

Engine Damage to a NASA DC-8-72 Airplane From a High-Altitude Encounter With a Diffuse Volcanic Ash Cloud

*Thomas J. Grindle
NASA Dryden Flight Research Center
Edwards, California*

*Frank W. Burcham, Jr.
Analytical Services and Materials, Inc.
Edwards, California*

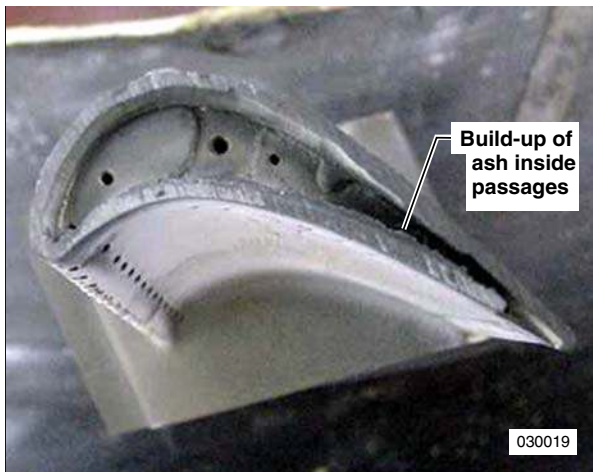

The NASA STI Program Office...in Profile

Since its founding, NASA has been dedicated to the advancement of aeronautics and space science. The NASA Scientific and Technical Information (STI) Program Office plays a key part in helping NASA maintain this important role.

The NASA STI Program Office is operated by Langley Research Center, the lead center for NASA's scientific and technical information. The NASA STI Program Office provides access to the NASA STI Database, the largest collection of aeronautical and space science STI in the world. The Program Office is also NASA's institutional mechanism for disseminating the results of its research and development activities. These results are published by NASA in the NASA STI Report Series, which includes the following report types:

- **TECHNICAL PUBLICATION.** Reports of completed research or a major significant phase of research that present the results of NASA programs and include extensive data or theoretical analysis. Includes compilations of significant scientific and technical data and information deemed to be of continuing reference value. NASA's counterpart of peer-reviewed formal professional papers but has less stringent limitations on manuscript length and extent of graphic presentations.
- **TECHNICAL MEMORANDUM.** Scientific and technical findings that are preliminary or of specialized interest, e.g., quick release reports, working papers, and bibliographies that contain minimal annotation. Does not contain extensive analysis.
- **CONTRACTOR REPORT.** Scientific and technical findings by NASA-sponsored contractors and grantees.
- **CONFERENCE PUBLICATION.** Collected papers from scientific and technical conferences, symposia, seminars, or other meetings sponsored or cosponsored by NASA.
- **SPECIAL PUBLICATION.** Scientific, technical, or historical information from NASA programs, projects, and mission, often concerned with subjects having substantial public interest.
- **TECHNICAL TRANSLATION.** English-language translations of foreign scientific and technical material pertinent to NASA's mission.

Specialized services that complement the STI Program Office's diverse offerings include creating custom thesauri, building customized databases, organizing and publishing research results...even providing videos.

For more information about the NASA STI Program Office, see the following:

- Access the NASA STI Program Home Page at <http://www.sti.nasa.gov>
- E-mail your question via the Internet to help@sti.nasa.gov
- Fax your question to the NASA Access Help Desk at (301) 621-0134
- Telephone the NASA Access Help Desk at (301) 621-0390
- Write to:
NASA Access Help Desk
NASA Center for AeroSpace Information
7121 Standard Drive
Hanover, MD 21076-1320

NASA/TM-2003-212030

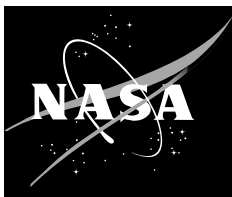

Engine Damage to a NASA DC-8-72 Airplane From a High-Altitude Encounter With a Diffuse Volcanic Ash Cloud

*Thomas J. Grindle
NASA Dryden Flight Research Center
Edwards, California*

*Frank W. Burcham, Jr.
Analytical Services and Materials, Inc.
Edwards, California*

National Aeronautics and
Space Administration

Dryden Flight Research Center
Edwards, California 93523-0273

August 2003

NOTICE

Use of trade names or names of manufacturers in this document does not constitute an official endorsement of such products or manufacturers, either expressed or implied, by the National Aeronautics and Space Administration.

Available from the following:

NASA Center for AeroSpace Information (CASI)
7121 Standard Drive
Hanover, MD 21076-1320
(301) 621-0390

National Technical Information Service (NTIS)
5285 Port Royal Road
Springfield, VA 22161-2171
(703) 487-4650

ABSTRACT

The National Aeronautics and Space Administration (NASA) DC-8 airborne sciences research airplane inadvertently flew through a diffuse volcanic ash cloud of the Mt. Hekla volcano in February 2000 during a flight from Edwards Air Force Base (Edwards, California) to Kiruna, Sweden. Although the ash plume was not visible to the flight crew, sensitive research experiments and instruments detected it. In-flight performance checks and postflight visual inspections revealed no damage to the airplane or engine first-stage fan blades; subsequent detailed examination of the engines revealed clogged turbine cooling air passages. The engines were removed and overhauled. This paper presents volcanic ash plume analysis, trajectory from satellites, analysis of ash particles collected in cabin air heat exchanger filters and removed from the engines, and data from onboard instruments and engine conditions.

NOMENCLATURE

AVHRR	Advanced Very High Resolution Radiometer
°C	degrees Celsius
EGT	exhaust gas temperature, °C
°F	degrees Fahrenheit
HPC	high pressure compressor
HPT	high pressure turbine
LPC	low pressure compressor
LPT	low pressure turbine
NASA	National Aeronautics and Space Administration
N1	engine fan rpm
N2	engine core rpm
SO ₂	sulfur dioxide
SOLVE	SAGE III Ozone Loss and Validation Experiment
VAAC	Volcanic Ash Advisory Center

INTRODUCTION

At any given time, there are numerous volcanoes erupting on earth. The problem of aircraft encounters with volcanic ash plumes is well-known and described in reference 1.

Several airplanes have nearly been lost, and many damaged. In most cases, the airplane entered an unseen ash cloud at night. Damage has included instances in which all engines flamed out and the airplane glided to lower altitudes before enough engines were restarted to effect a landing. Damage in excess of one quarter of a billion dollars has been directly linked to volcanic ash encounters.

As indicated by reference 2, there are techniques for detecting, tracking, and warning flight crews about the presence of, volcanic ash plumes. However, there are currently no onboard ash detectors, and predictive techniques are far from perfect. Reference 3 and Appendix A describe procedures for flight crews when they detect that they have entered an ash cloud, but these procedures are not well-known outside of the commercial aviation community.

The NASA DC-8 airplane, a highly instrumented research platform for conducting atmospheric science research, inadvertently flew through the fringe of the volcanic ash cloud produced by the Mt. Hekla volcano in Iceland. This encounter occurred in total darkness (no moon) in the early morning of February 28, 2000, during a ferry flight to Kiruna, Sweden.

Reference 4 gives an overview of the ash incident. This paper discusses details of the ash encounter, ash plume projections and actual locations, engine history and damage.

BACKGROUND

Volcanic eruptions can eject huge quantities of solid and gaseous material into the atmosphere. Large, solid material precipitates from the atmosphere near the volcano but small particles (< 15 microns) and gaseous material can be transported to high altitudes and distributed over large distances by atmospheric phenomena. Volcanic ash particles in the 1–10 micron size range can be found more than 1000 mi from a volcano. These ash particles typically have a melting point of approximately 1832 °F (1000 °C). Sulfur compounds and other aerosols can be found in ash clouds. At high altitudes, ice may form on ash particles, and electrostatic charges may also be present on ash particles.

More than 100 commercial aircraft have unexpectedly encountered volcanic ash in flight and at airports in the past 20 years. Eight of these encounters caused varying degrees of in-flight loss of jet engine power (ref. 1). In some cases this nearly resulted in the crash of the airplane. Reference 5 explains that a range of damage may occur to aircraft that fly through an eruption cloud depending on the concentration of volcanic ash and gas aerosols in the cloud, the length of time the aircraft actually spends in the cloud, and the actions taken by the pilots to exit the cloud.

Ash ingested by jet engines can lead to an immediate deterioration in engine performance and cause engine flameout. In the case of volcanic ash, the principal cause of engine flameout is the deposition of the ash in the hot sections of the engine. This buildup causes a very rapid increase in burner static pressure and in compressor discharge pressure, which at high altitude can lead to surge and flameout (ref. 3). Volcanic ash, when heated by the engine combustor section, becomes molten glass that can coat fuel nozzles, the combustor, and turbine. This reduces the efficiency of fuel mixing and restricts air from passing through the engine. This can ultimately cause loss of thrust, surging, and possible flameout. Ash can also seriously erode moving engine parts, including the compressor and turbine blades, reducing engine efficiency. Molten ash can solidify inside cooling passages, clogging the passages and reducing or eliminating cooling airflow, increasing blade and vane operating temperatures, and shortening engine life.

Volcanic ash is highly abrasive. It consists of hard, sharp rock fragments that easily scratch and erode plastic, glass, and metals. Any forward-facing surface of an aircraft is likely to be damaged, including the cockpit and windshields, landing light covers, leading edges of wings and tails, engine cowlings, and the

radar nose cone. Cockpit windshields can become so abraded and scratched that pilots can lose appreciable amounts of forward visibility (ref. 1).

Air that enters an airplane's pressurized interior usually must first pass through the engines. Therefore, some ash particles that are ingested through the engines use the airplane's ventilation ductwork to travel throughout the airplane. Ash can clog air filter systems and spread across the entire cabin, contaminating fixtures, carpeting, seat covers, and cushions. Ash can also damage the airplane's electronic system, including power generators and navigation instruments, and can set off the fire detection sensors in the cargo bay area (ref. 3).

Currently there are no available systems for airborne detection of volcanic ash, and aircraft weather radar cannot detect volcanic ash because the particle size is too small.

Ash plume penetration can be detected by an odor in the cabin air, by changes in engine readings, at night by the presence of St. Elmo's fire on forward-facing parts of the aircraft (particularly the engine cowls), or by the frosting of windows.

There are two satellite-based sensor systems which can detect volcanic clouds, but both are limited in real-time capability. The first, as discussed in reference 6, is the Total Ozone Mapping Spectrometer (TOMS). TOMS uses an ultraviolet spectrum system which detects sulfur dioxide (SO₂) gas and provides volcanic cloud position data globally about once per day during daylight hours only. The second, discussed in reference 7, uses infrared detectors aboard polar-orbiting weather satellite platforms. These are by far the most useful volcanic cloud detectors because they detect volcanic ash and because they give nearly global coverage very frequently (about every 15–60 min). As such, the weather satellites contain the only robust system that can be used to systematically track volcanic clouds. The Advanced Very High Resolution Radiometer (AVHRR) on these weather satellites provides infrared data at several wavelengths. The difference between bands four and five is used for the two-band thermal infrared algorithm described in reference 8, which covers volcanic cloud detection and has been applied to a number of different eruptions — demonstrating that it works well for a variety of different types of volcanic activity. The development of a retrieval method to obtain the mass of ash in a drifting volcanic cloud as well as its position has greatly expanded the utility of the two-band infrared method because it provides the ability to measure the mass of hazardous silicates as the clouds dissipate. However, with the diffuse and ice-coated ash that the DC-8 is suspected to have encountered, this information-gathering capability would have shown a cloud band that would have appeared to be standard atmospheric moisture, not volcanic ash.

DESCRIPTION OF AIRPLANE AND ENGINE

Description of Airplane

The NASA Airborne Laboratory DC-8 shown in figure 1 and described in reference 9 is a -72 configuration airliner specifically modified to serve as an airborne science platform airplane. It is 157 ft long, and has provisions for up to 17 experiment stations onboard. For the SAGE III Ozone Loss and Validation Experiment (SOLVE) missions the aircraft was configured for airborne chemistry research as described in reference 10. The DC-8 can fly in excess of 12 hr at altitudes up to 41,000 ft and Mach numbers up to 0.88. The airplane was re-engined with four CFM56-2 engines prior to delivery to NASA. The aircraft environmental system uses conditioned engine bleed air for aircraft pressurization and temperature control. Incoming outside air, which is filtered to remove particulate matter and moisture, is used to cool the bleed air as it passes through the aircraft heat exchangers.



Figure 1. NASA DC-8 airborne sciences platform aircraft on takeoff from Kiruna, Sweden.

Description of Engine

Figure 2 shows the CFM56-2 engine, which is a high bypass ratio, separate flow turbofan with a sea level static thrust rating of 22,000 lb, nominal bypass ratio of 6:1, an overall pressure ratio of 28:1, and a maximum exhaust gas temperature (EGT) of 1598 °F (870 °C). As shown in figure 2(a), the single-stage fan and three-stage booster compressor is driven by a four-stage low pressure turbine (LPT); only the first-stage LPT nozzle is cooled, using fifth-stage high pressure compressor (HPC) bleed air. A single-stage cooled high pressure turbine (HPT) drives the nine-stage high pressure compressor. The HPT blades and vanes feature air cooling through nose holes, gill holes, and trailing edge slots, using cooling air from the HPC discharge as shown in figure 2(b). The crew monitors the performance of the engine throughout each flight. At the start of cruise on each flight, performance data is manually recorded for engine trending.

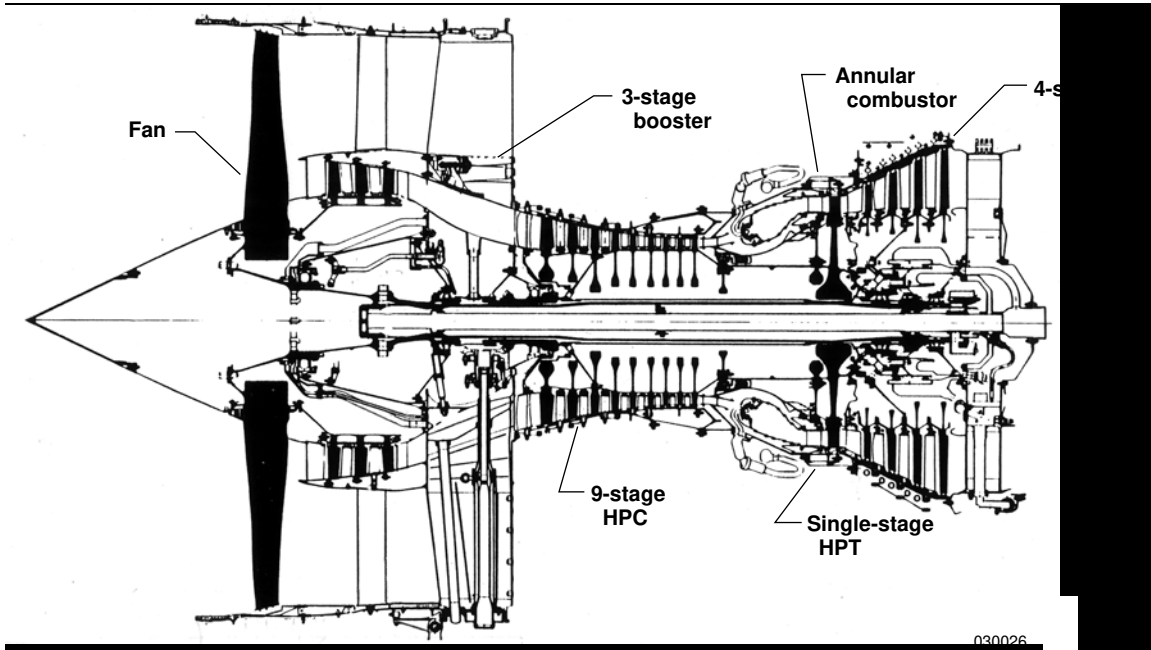

(a) Cutaway view.

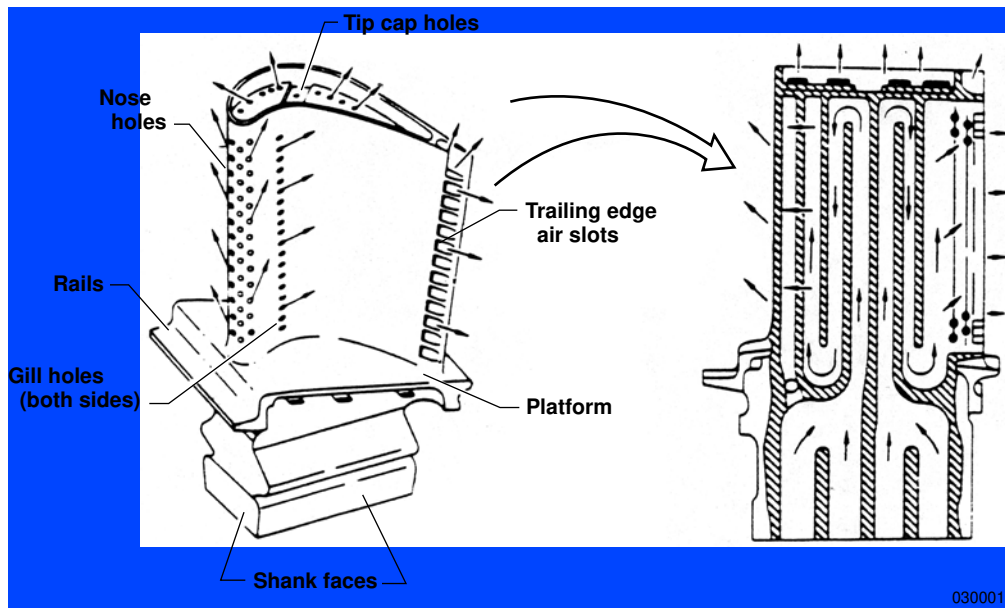

(b) High pressure turbine rotor blade cooling.

Figure 2. GE CFM56-2 high bypass turbofan engine.

Engine History

The CFM56-2 engine history is shown in figure 3. All engines had approximately 5000 total operating hours, but the hours since the last shop visit are the important figure, and are noted. Engine number four had not had some hardware upgrades that had been incorporated on the other three engines. In early December 1999, on a previous deployment to Kiruna, the airplane landed on a sanded runway and during thrust reversing, some sand was observed being ingested into the engines. After returning to Edwards, a borescope inspection was made and did not show any significant engine damage. A total of 47 more flight hours were accumulated prior to the volcanic ash encounter. After the oil change following the ash encounter, the engines accumulated 68 more hours prior to arriving back at Edwards. An oil sample was taken just after the volcanic ash encounter and was brought back to Edwards and analyzed. That initial analysis showed all tested values to be in the normal range. An additional analysis was performed that included an analysis of sulfur. Sulfur is not checked for at the Edwards lab because it is not listed as a normal wear element. Figure 4 shows 500 parts per million (ppm) of sulfur versus a normal value of less than 1 ppm. (The high phosphorus levels are normal and due to an additive.) The oil sample taken after returning to Edwards was normal. At the time the borescope inspections were completed, engine number four (serial number 692632) appeared to have sustained the most damage (and needed hardware upgrades in any case), so it was removed and sent to the engine manufacturer for teardown and refurbishment.

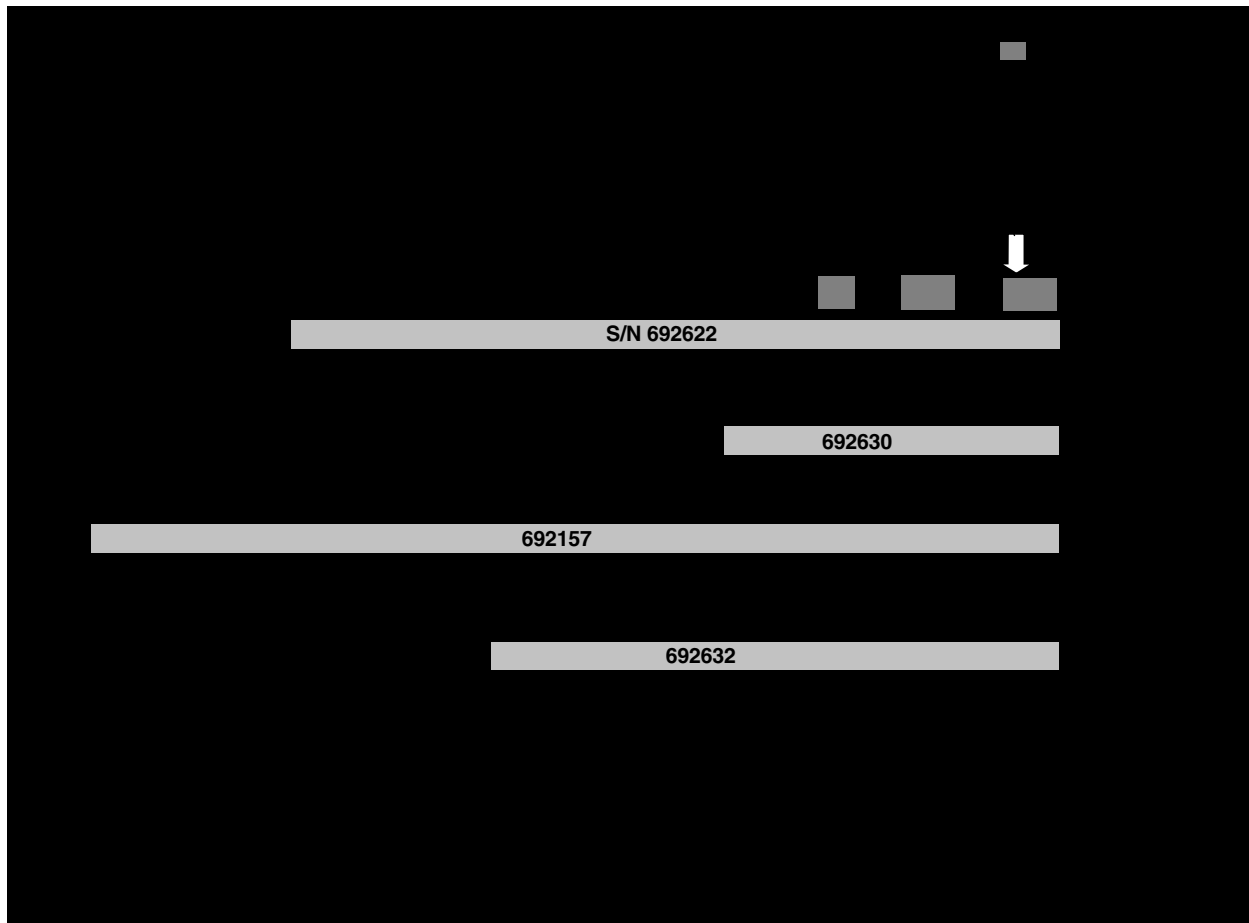
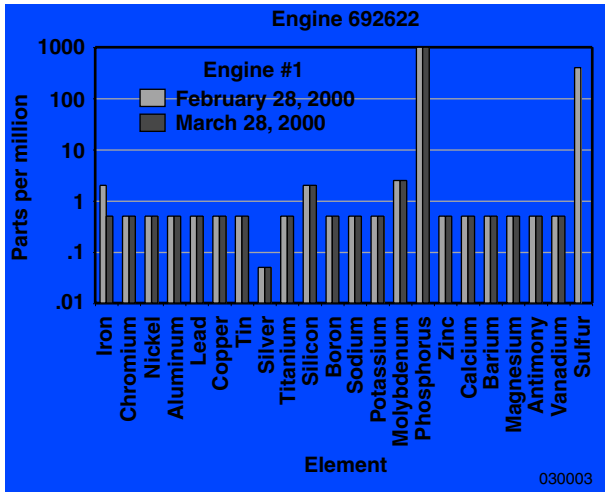
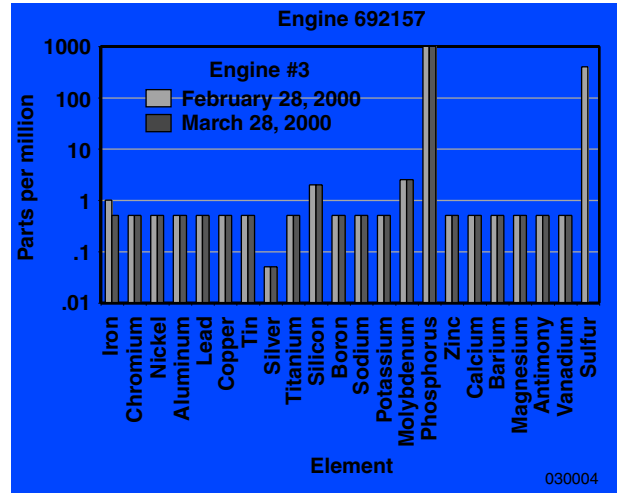

Figure 3. History of the DC-8 engines prior to and after the volcanic ash encounter.



(a) Engine 692622.



(b) Engine 692157.

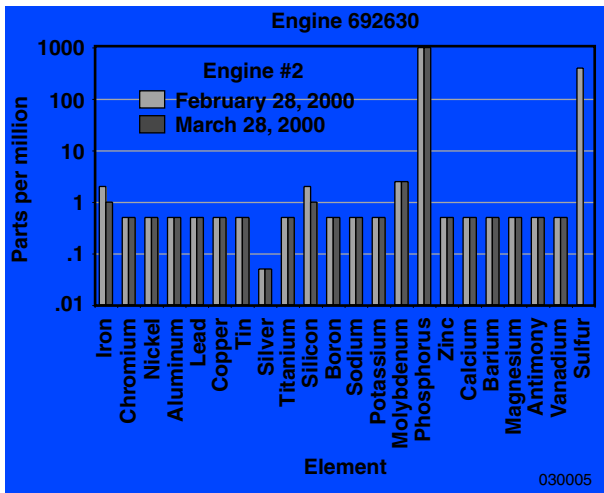

(c) Engine 692630.

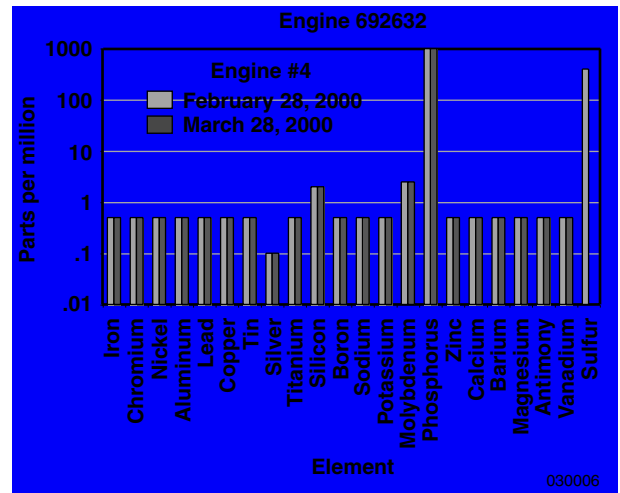

(d) Engine 692632.

Figure 4. Engine oil sample results before and after oil change at Kiruna, Sweden, showing high sulfur content from ash encounter.

THE VOLCANIC ASH ENCOUNTER FLIGHT

Figure 5 shows a time line of the events for the ash encounter. The DC-8 deployment flight began on February 27, 2000, from Edwards, California, to Kiruna, Sweden for a SOLVE study of the Arctic ozone. On February 26, 2000, at 1830 Greenwich mean time (GMT), the Mt. Hekla volcano in Iceland erupted, producing an ash and steam cloud to 45,000 ft and a lava flow. Plume projections (made using observatory inputs, satellite pictures, radar imagery and pilot reports) from the London Volcanic Ash Advisory Center (VAAC) and presented as appendix B showed a maximum northerly position above flight level 18,000 ft (FL180) to be 7300N 0005W, at February 27 0900 GMT, south of the proposed DC-8 flight track. Later plume predictions did not include any more northerly projections; however, to provide an additional margin of safety the DC-8 track was then adjusted 200 mi further north, to the ground track shown in figure 6. (Appendix B was previously available at <http://www.ssd.noaa.gov/VAAC/OTH/UK/MSG0572200.02.txt> and is currently being prepared by the National Geophysical Data Center for availability at <http://www.ngdc.noaa.gov/seg/hazard.>)

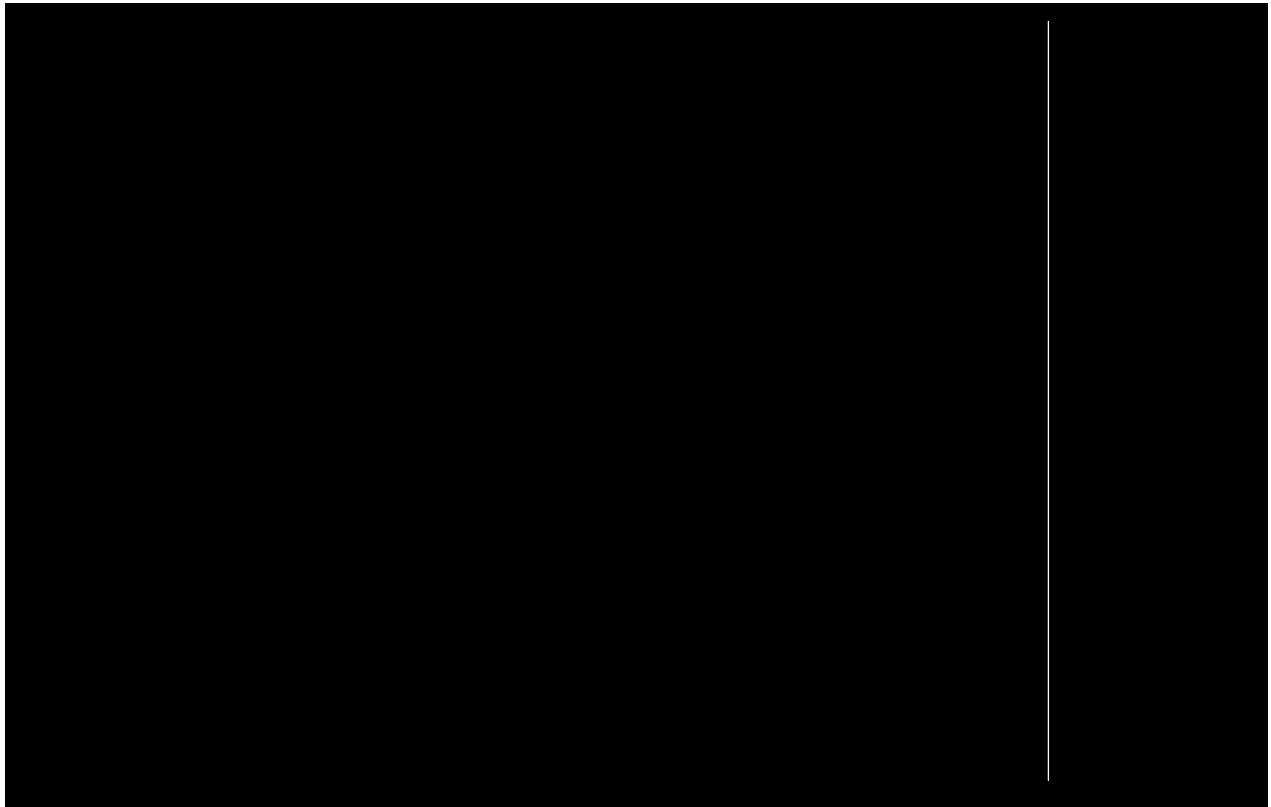

Figure 5. Timeline showing Mt. Hekla volcano eruption, ash advisories, NASA DC-8 flight, ash encounter, and AVHRR analysis.

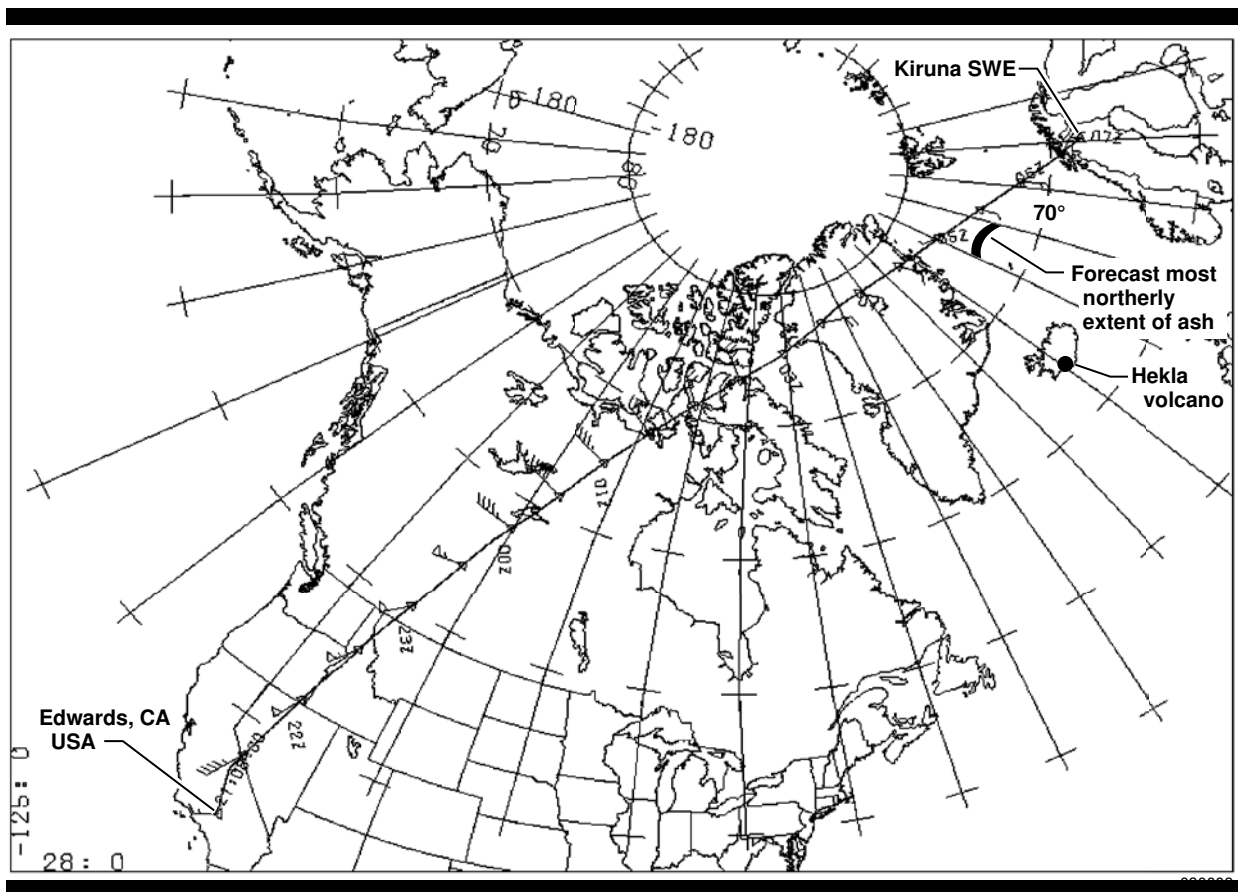
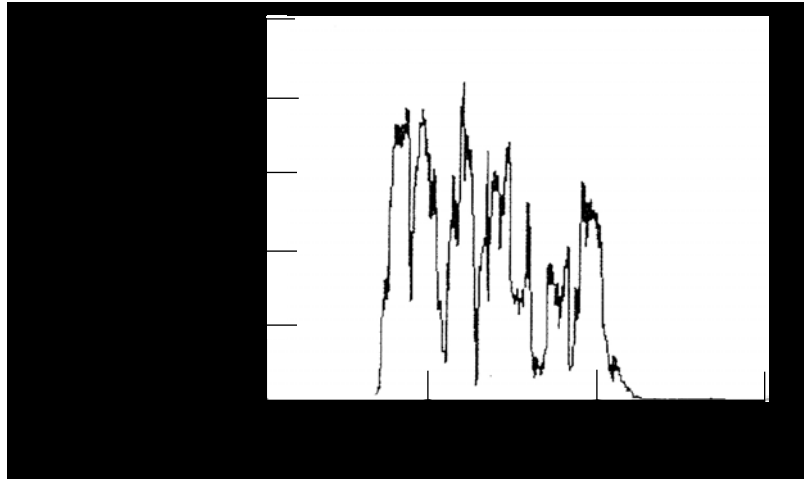
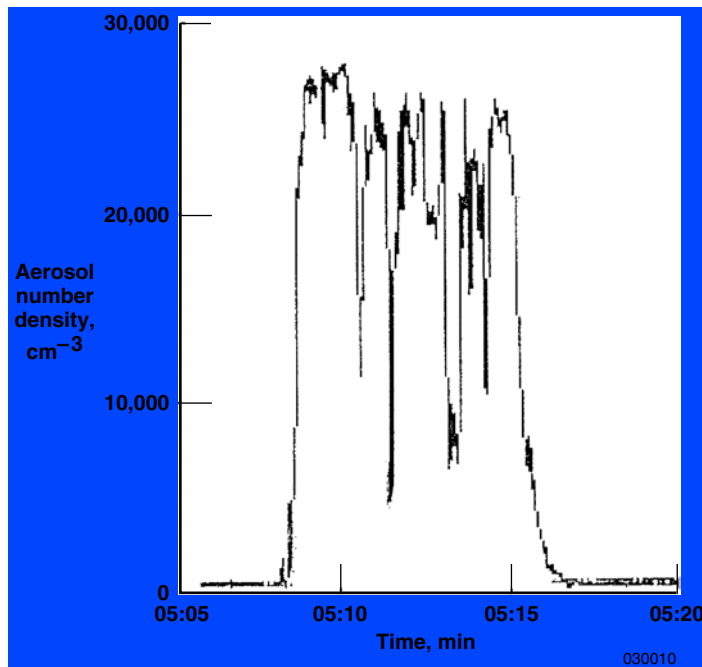

Figure 6. Ground track of NASA DC-8 volcanic ash encounter, flight 191, Feb. 27–28, 2000, Edwards, USA to Kiruna, Sweden.

On the flight to Sweden, in a moonless and cloudless sky at 0508 GMT on February 28, 2000, scientists onboard the DC-8 monitoring sensitive research instruments reported a sudden increase in measurements that indicated the presence of a volcanic ash cloud. The onboard sensor data is presented in figure 7, with figure 7(a) showing measurements of sulfur dioxide (SO_2) concentration in parts per trillion by volume (pptv), and figure 7(b) showing aerosol data for the seven-minute encounter. This encounter was more than 200 mi north of the predicted maximum northerly extent of the plume and approximately 800 nmi from the volcano (fig. 6). The volcanic plume was about 35 hr old at this time.



(a) SO₂ concentration, airborne Fourier transform infrared spectrometer.



(b) Aerosol data; airborne Langley condensation nuclei counter, 12 nm–1 micron.

Figure 7. Onboard sensor data for the DC-8 volcanic ash encounter.

The flight crew noted no change in cockpit readings, no St. Elmo's fire, no odor or smoke, and no change in engine instruments. They did notice that no stars were visible, but this is typical of flight through high cirrus clouds.

Conditions noted were:

Altitude	37,000 ft
Mach	0.792
Total temperature	-54 °F (-48 °C)
True airspeed	438 kn

And engine readings:

N1	88–88.5%
N2	90–91%
EGT	1165–1200 °F (630–649 °C)
Fuel flow	2950 lb/hr per engine

After seven minutes the crew noticed that the stars had reappeared, and at about this time the scientists reported that the research instrument readings had returned to normal. There was still no change in engine or airplane instrument readings. The DC-8 crew made an airborne encounter report to the appropriate oceanic control agency. This report is documented in VAAC #6 280751.

In this ash encounter, the crew verified that there was no change in engine instruments. As such, they did not reduce engine power nor attempt to exit the cloud. This was because of the complete lack of indication of a volcanic plume, other than the sensitive scientific instruments, and because the crew was not aware of the recommendation to reduce power to idle. In addition, over the polar ocean at night, using visual flight rules in a "Non-Radar Environment," it was probably not prudent to reduce power and descend even if the crew had been aware of the recommended procedure.

Data from the weather satellite AVHRR was analyzed after the encounter and is shown in figure 8 with the DC-8 flight track. The difference between bands four and five is plotted, with the lightest shade being the largest difference. The satellite scan, taken 30 min after the end of the encounter, shows a band across the DC-8 flight track. Considering the probable slow northerly drift of the ash cloud, this appears to coincide very well with the ash cloud encounter time and duration. Other AVHRR data was analyzed and shows the movement of the ash cloud. This data is presented in reference 11 but was not available to the VAAC forecasters.

After landing in Kiruna, the engine oil, oil filters, and heat exchanger filters were removed and saved for analysis. Visual inspection of the airplane and first-stage engine fan blades showed no apparent damage or erosion on any parts of the airplane, nor was any ash found in the engine cowlings or other normal access panels. Borescope inspection equipment was not available in Kiruna, and since there was no detected change in engine performance, the research flights continued.

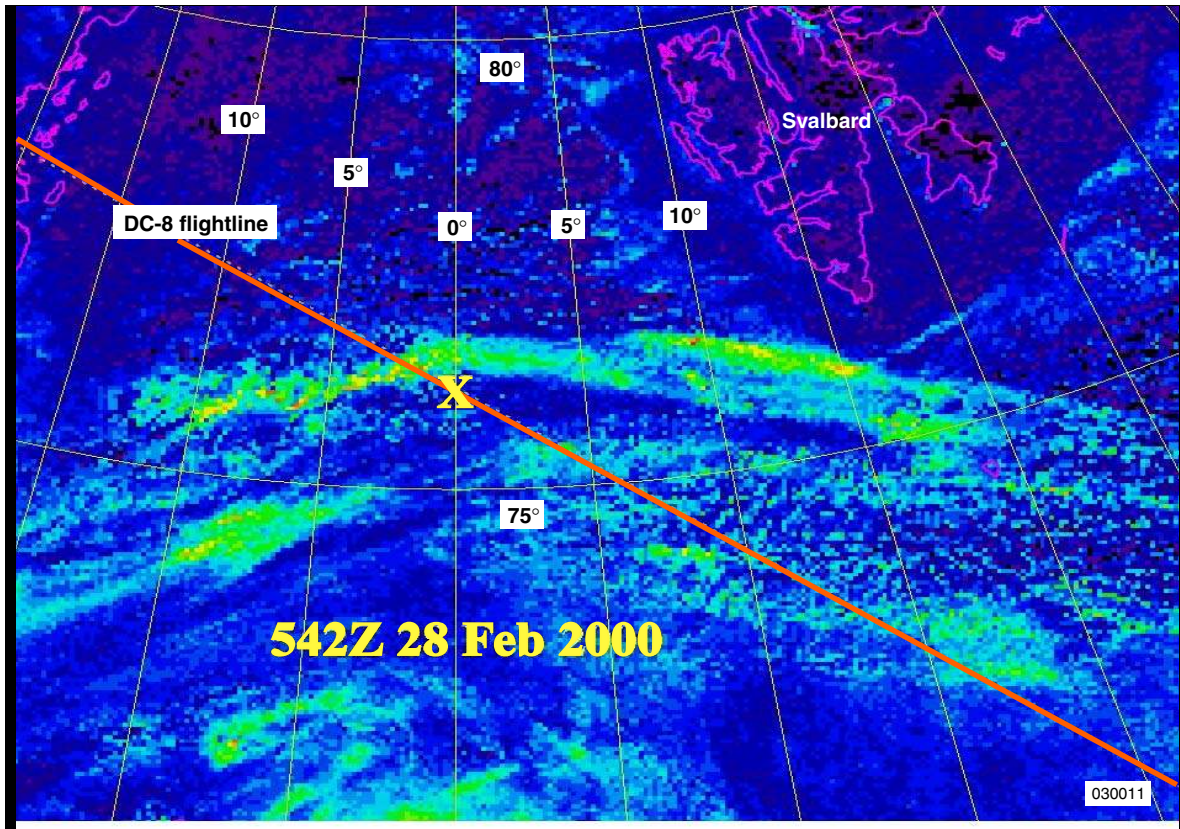

Figure 8. DC-8 flight track and ash cloud, inferred from satellite infrared radiometer data, 30 minutes after encounter.

During the seven SOLVE research flights in the same region of the Arctic, the sensitive research instruments again recorded traces of the volcanic ash cloud, but much more diffuse than in the first encounter.

When the SOLVE campaign was completed, the airplane was ferried back to Edwards. A total of 68 flight hours had accumulated since the ash encounter. At Edwards, engine borescope inspections revealed clogged cooling passages and some heat distress in the high temperature section of the engines. Engine number four appeared to be the most heavily damaged and was removed. Following the number four engine teardown and inspection, the other three remaining engines were also removed and disassembled for inspection.

Engine Trending Data

At the start of cruise flight on every mission, the flight crew of the DC-8 manually reads the following cockpit instrument data:

Total air temperature	Altitude
Mach number	Fan rpm
Core rpm	Oil pressure
Fuel flow	Exhaust gas temperature

These data points were sent to the engine manufacturer, who entered the data into a trending analysis that normalized the data for flight conditions and reported deviations from the nominal. The results of the engine trending analysis are shown in figure 9. There is no evidence of significant engine performance change following the ash encounter. In fact, there does appear to be a slight drop in cruise EGT. This is consistent with experience that says that a very mild ash encounter cleans and polishes the compressor blades, slightly increasing their efficiency. Blocked turbine cooling air passages and holes would be expected to reduce HPC bleed flow, which would also slightly improve performance. The increased blade and vane metal temperatures would degrade their service life, but not their performance. A blade with blocked cooling operates at a sufficiently higher temperature so that its service life may be as little as 100 hr as compared to a normal service life of thousands of hours.

Engine Conditions at Ash Encounter

The engines were being operated in the “long range cruise” mode at the time of the encounter. Figure 10 shows estimated temperatures through the engine. Thrust was about 4300 lb per engine, and HPC discharge air (used for HPT cooling) temperature was 779 °F (415 °C). The combustor exit and HPT inlet temperatures were estimated to be well above the 1832 °F (1000 °C) ash melting temperature (ref. 3). The ash would have been expected to melt and fuse to the HPT vanes and blades both outside and on the inner cooling passages. The second- and third-stage LPT temperatures were estimated to be below 900 °F (482 °C), and since those blades are uncooled, no damage would be expected.

ENGINE OVERHAUL RESULTS

All four engines were sent to the General Electric Strouther overhaul facility near Arkansas City, Kansas. Photographs were taken as the engines were disassembled. All engines exhibited a fine white powder coating throughout. There was leading edge erosion on HPT vanes and blades, blocked cooling air holes, blistered coatings, and a buildup of fine ash inside passages. Serial number 692632 (the number four engine on the DC-8) had the most severe damage; this may be partially due to the older hardware still resident in this engine. Figure 11 shows photos of the damaged HPT blades, with clogged cooling air holes, leading edge erosion, buildup of ash in passages, and blistered blade coatings clearly visible. Total cost of refurbishment (to standard flight condition) for all four engines was \$3.2 million.

Even though this was a diffuse ash cloud, the exposure was long enough and engine temperatures were high enough that engine hot section blades and vanes were coated and cooling air passages were partially or completely blocked. The uncooled blades still performed aerodynamically but necessitated expensive overhauls. The insidious nature of this encounter and the resulting damage was such that engine trending did not reveal a problem, yet hot section parts may have begun to fail (through blade erosion) if flown another 100 hr.

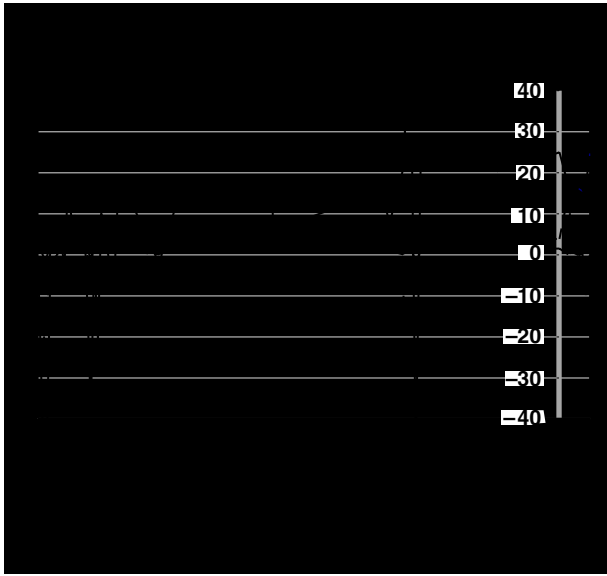

(a) Engine 692622.

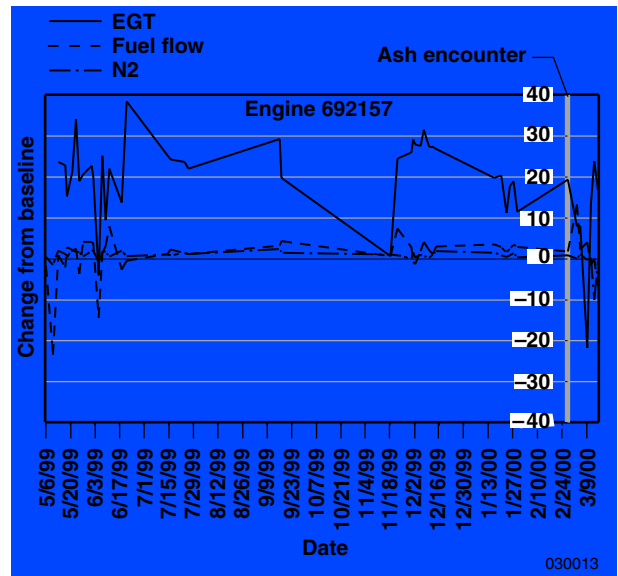

(b) Engine 692157.

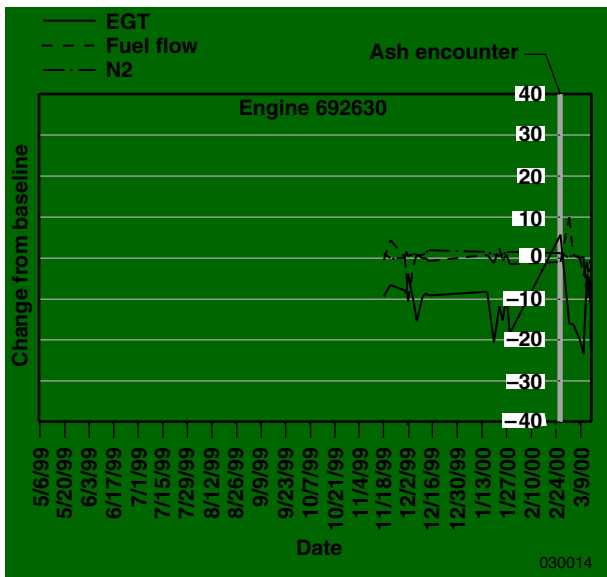

(c) Engine 692630.

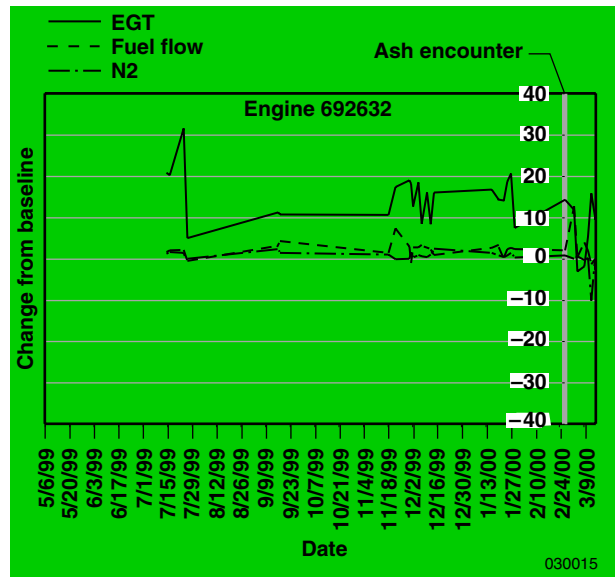

(d) Engine 692632.

Figure 9. Engine trend data for the CFM56-2 engines up to and following the volcanic ash encounter.

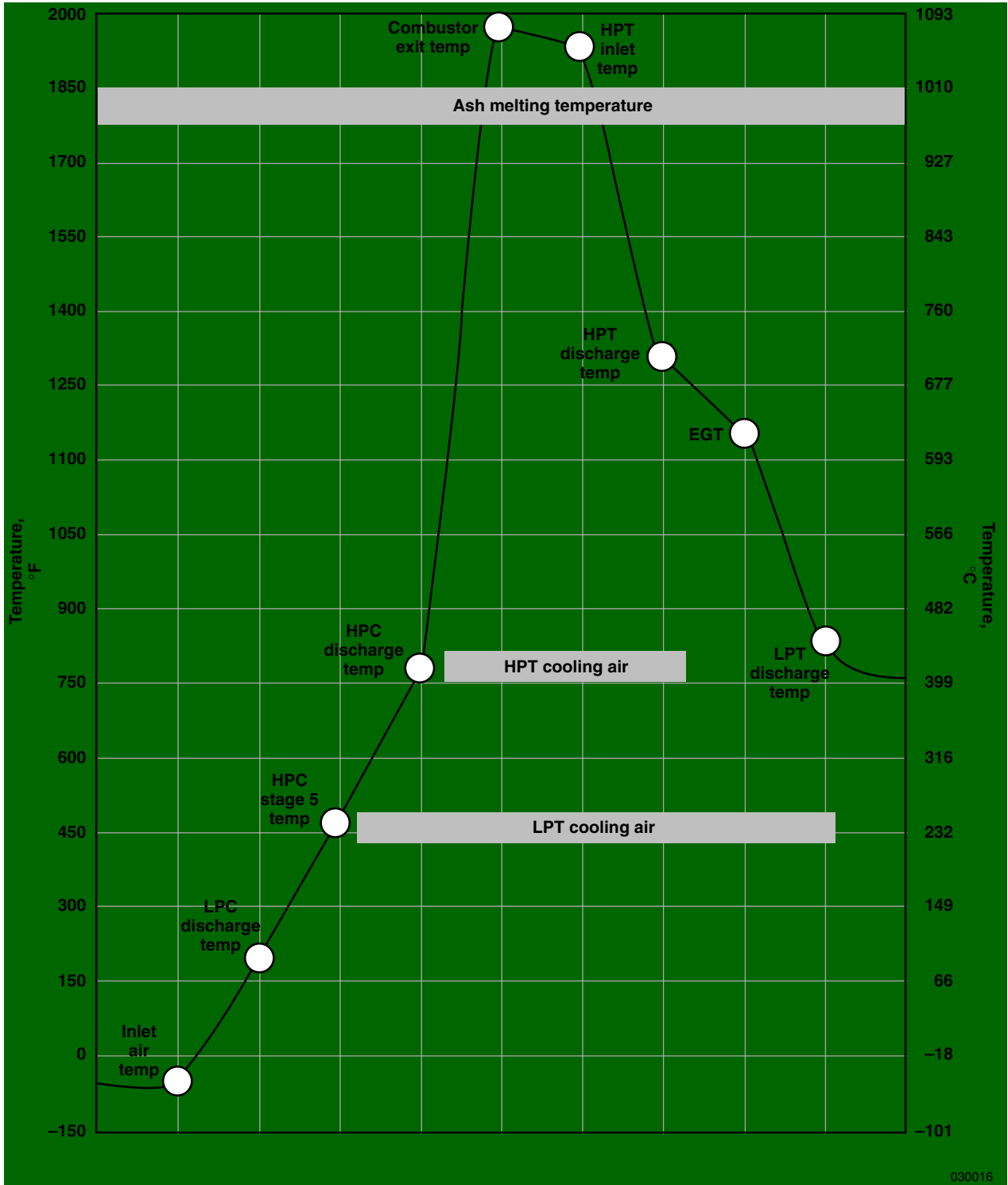
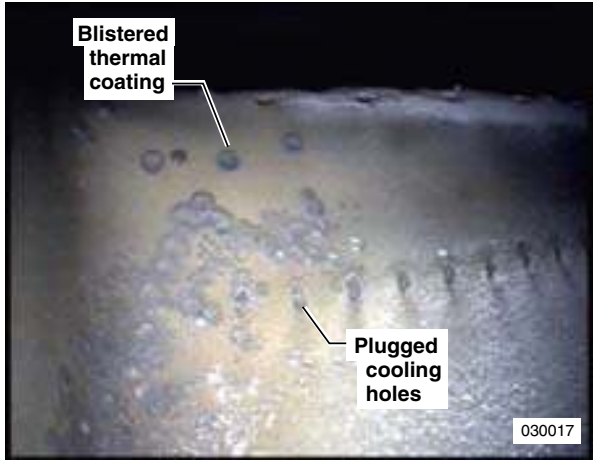

Figure 10. Estimated temperatures through the CFM56-2 at ash encounter conditions.



(a) Blistered thermal coating, and plugged cooling holes.



(b) Erosion of leading edge.



(c) Build-up of ash inside passage.

Figure 11. Photographs of damaged turbine blades from engine number 692632.

ANALYSIS OF VOLCANIC ASH SAMPLES AND ASH CLOUD

Samples of ash from the cabin air heat exchanger filters and the engine hot section were sent to two investigators experienced in analysis of volcanic plumes (refs. 11 and 12). Interpretations of findings differed. The heat exchanger filter, which was removed immediately after the encounter flight, showed clear evidence of basaltic volcanic ash particles between one and ten microns in diameter and clumped together in the fibers (ref. 12) (fig. 12). X-ray emission spectra from these samples were consistent with samples of the Mt. Hekla volcanic ash collected on the ground. The high sulfur content in the engine oil samples is also indicative of flight through the Mt. Hekla plume. Analysis of material removed from the engines was not so definitive, probably since 68 additional hours were accumulated before teardown.

AVHRR satellite data (ref. 11) showed that a cloud band was traversed by the DC-8 at the time of the encounter (fig. 8). One investigator (ref. 11), using the inferred temperature difference between band four and band five of the AVHRR, concluded that the cloud was composed mostly of ice crystals and little ash. Another investigator (ref. 12), surmised that ash particles were present and likely formed condensation nuclei for the abundant moisture in the volcanic ash plume; thus most of the ash particles were believed to be ice-coated. Ice-coated particles are much less destructive to airplane parts such as windscreens and leading edges (ref. 5), but would still be damaging to engines as the ice would melt in the compressor — possibly explaining engine damage unaccompanied by airplane damage.

Analysis of the volcanic ash plume trajectory from the AVHRR satellite data indicated the ash plume had been transported further north than expected by atmospheric effects. Part of the plume had been warped around a cyclonic system (ref. 11) and was moving slowly further north at the time of the encounter.

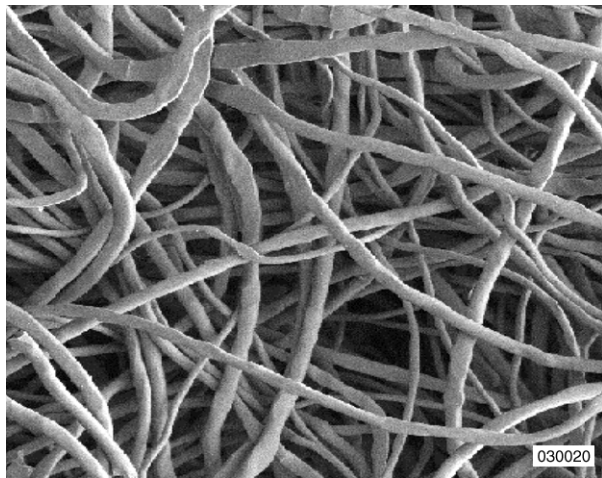

(a) New unused filter 100 μm 150X.

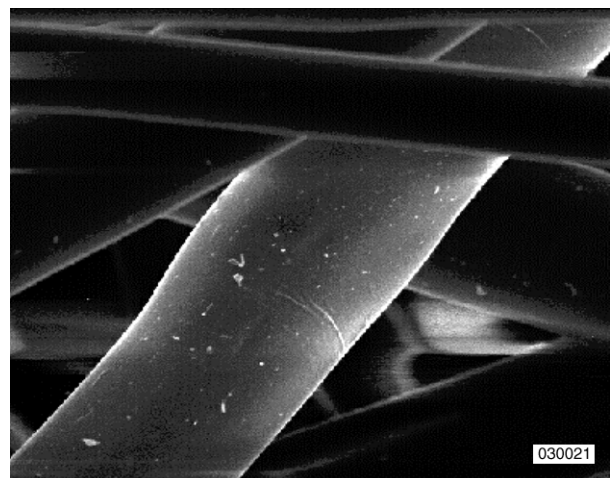

(b) New unused filter 100 μm 2000X.

Figure 12. Photomicrographs of DC-8 heat exchanger filters.

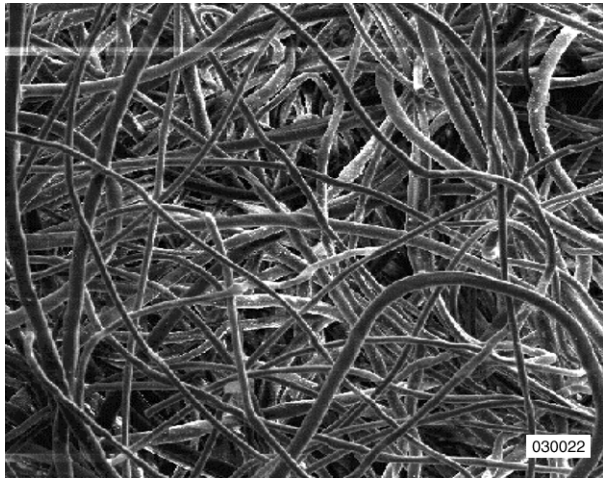

(c) Used filter—typical dirt, no ash 100 μm 150X.

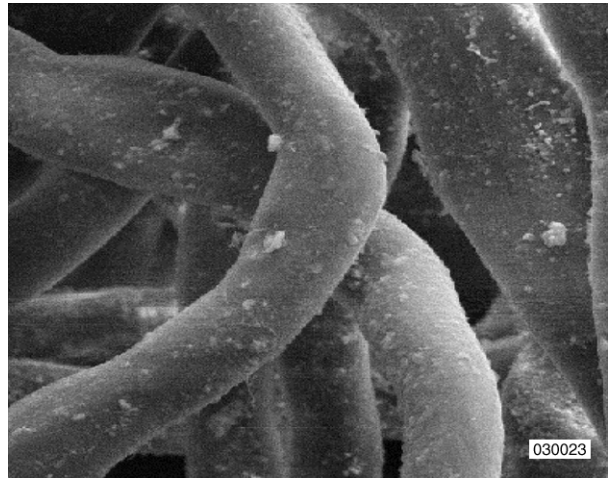

(d) Used filter—typical dirt, no ash 10 μm 1500X.

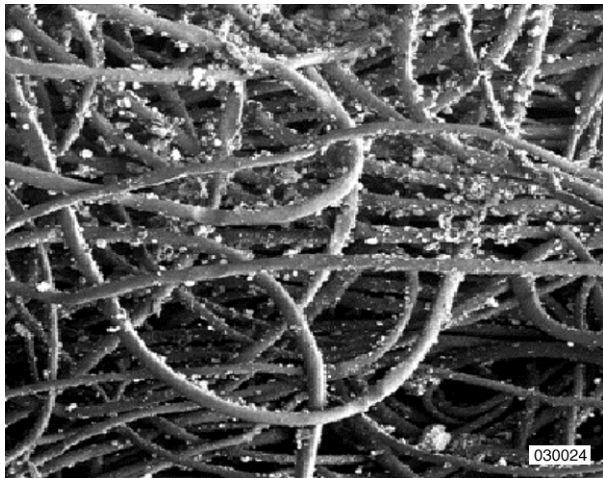

(e) Filter after Hekla ash encounter 100 μm 150X.

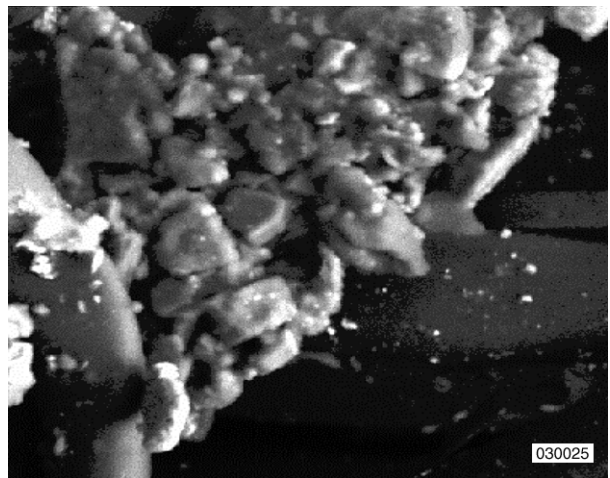

(f) Filter after Hekla ash encounter 10 μm 1500X.

Figure 12. Concluded.

SUMMARY

In the early morning hours of February 28, 2000, the National Aeronautics and Space Administration (NASA) DC-8 Airborne Sciences research airplane inadvertently flew through a diffuse plume of volcanic ash from the Mt. Hekla volcano. There were no indications to the flight crew, but sensitive onboard instruments detected the 35-hr-old ash plume. Upon landing there was no visible damage to the airplane or engine first-stage fan blades; later borescope inspection of the engines revealed clogged turbine cooling air passages. The engines were removed and overhauled at a cost of \$3.2 million. Satellite data analysis of the volcanic ash plume trajectory indicated the ash plume had been transported further north than predicted by atmospheric effects. Analysis of the ash particles collected in cabin air heat exchanger filters showed strong evidence of volcanic ash, most of which may have been ice-coated (and therefore less damaging to the airplane) at the time of the encounter. Engine operating temperatures at the time of the encounter were sufficiently high to cause melting and fusing of ash on and inside high-pressure turbine blade cooling passages. There was no evidence of engine damage in the engine trending results, but some of the turbine blades had been operating partially uncooled and may have had a remaining lifetime of as little as 100 hr. There are currently no fully reliable methods available to flight crews to detect the presence of a diffuse, yet potentially damaging volcanic ash cloud.

APPENDICES

APPENDIX A

RECOMMENDED PROCEDURE IF VOLCANIC ASH IS ENCOUNTERED

(A summary of procedures as presented in reference 3.)

What to do in an Emergency

Unfortunately, it is not always possible to avoid an ash cloud and if a plane does enter one there are very specific steps that the flight crew must take in order to increase the chance of making it out of the dangerous area safely, according to Campbell, 1994:

- **Immediately reduce thrust to idle.** This will lower EGT, which in turn will reduce buildup on the turbine blades and hot-section components. The volcanic dust can cause rapid erosion and damage to the internal components of the engines.
- **Autothrottles off** (if engaged). The autothrottles should be turned off to prevent the system from increasing thrust above idle. Due to the reduced surge margins, limit changes with slow and smooth thrust-lever movements.
- **Exit volcanic cloud as quickly as possible.** Volcanic ash may extend for several hundred miles. The shortest distance/time out of the dust may require an immediate, descending 180-degree turn. Setting climb thrust and attempting to climb above the volcanic cloud is not recommended due to accelerated engine damage/flameout at high thrust settings.
- **Engine and wing anti-ice on.** All air conditioning packs on.
- **Start the auxiliary power unit (APU), if available.** The APU can be used to power the electrical system in the event of a multiple-engine power loss.
- **Oxygen mask on and 100%, if required.**
- **Ignition on.** For systems with autostart, switch to “on” position.
- **Monitor EGT.** If necessary, shut down and then restart engines to keep from exceeding EGT limits.
- **Close the outflow valves.**
- **Do not pull the fire switch.**
- **Leave fuel boost pump switches “on” and open cross-feed valves.**
- **Do not use fuel heat.**
- **Engine restart.** If an engine fails to start, try again immediately. Successful engine restart may not be possible until airspeed and altitude are within the airstart envelope. After the engine starts, land at the nearest airport.

APPENDIX B

ASH ADVISORY

Subject: FVUK01 EGRR 262157

FVUK01 EGRR 262157
FF EGZZFVUK
262157 EGRRYMYX
FVUK01 EGRR 262157
VOLCANIC ASH ADVISORY
VAAC LONDON

NAME OF VOLCANO	HEKLA
REFERENCE NUMBER	1702-07
GEOGRAPHICAL AREA	ICELAND
LATITUDE AND LONGITUDE	64.00N 19.70W.

SOURCES OF INFORMATION ICELANDIC MET SERVICE

DETAILS OF ERUPTION ESTIMATED START AT 261830 GMT 26 FEBRUARY 2000

DETAILS OF ASH CLOUD: OBSERVATIONS INDICATE THE TOP OF THE ASH CLOUD TO HAVE REACHED FL450, APPROXIMATELY 200 KM TO NNE. DURING THE NEXT 4 HOURS THE CONCENTRATION OF VOLCANIC ASH IS EXPECTED TO LIE WITHIN THE AREA BOUNDED BY 6350N 020W, 6700N 020W, 7000N 010W, 6500N 015W, 6350N 018W AND 6350N 020W.

TRAJECTORY OF ASH CLOUD BELOW FL180 LIGHT NORTHWESTERLY WINDS ARE MOVING THE CLOUD SOUTHEAST, TURNING EAST FROM 6400N 010W THEN LATER TURNING NORTHEASTWARDS. ABOVE FL180 SOUTHWESTERLY WINDS ARE MOVING THE CLOUD NORTHEASTWARDS, REACHING 7100N 008W BY 270600 GMT

FORECAST MOVEMENT OF ASH CLOUD ABOVE FL180 CLOUD IS EXPECTED TO MOVE BETWEEN NORTH AND NORTHEASTERLY REACHING 7300N 0005W BY 270900 GMT. BELOW FL180 CLOUD IS EXPECTED TO MOVE SOUTHEASTERLY, THEN TURNING EASTERLY, REACHING 6300N 015W BY 270900 GMT

NEXT ADVISORY WILL BE ISSUED BEFORE 270600 GMT

REFERENCES

1. Miller, T.P., and T.J. Casadevall, "Volcanic Ash Hazards to Aviation," *Encyclopedia of Volcanoes*, page 915, 1999.
2. Schneider, David J., David J. Delene, William I. Rose, and Shiming Wen, "Remote Sensing of Volcanic Eruption Clouds Using AVHRR," <http://www.geo.mtu.edu/volcanoes/research/avhrr/>, July 2002.
3. Swanson, Samuel E., and James E. Beget, "Melting Properties of Volcanic Ash," *Volcanic Ash and Aviation Safety: Proceedings of the First International Symposium on Volcanic Ash and Aviation Safety*, U.S. Geological Survey Bulletin 2047, page 87, July 1991.
4. Grindle, Thomas J., and Frank W. Burcham, Jr., "Even Minor Volcanic Ash Encounters can Cause Major Damage to Aircraft," *ICAO Journal*, Volume 57, Number 2, page 12, March 2002.
5. Pieri, David C., and Robert Oeding, "Preliminary Analyses of Volcanic Ash on an Aircraft Windscreen: the December 15, 1989 Redoubt Encounter," *Airborne Hazards from Volcanic Ash Colloquium*, Seattle, Wash., Boeing Aircraft Company, July 7, 1991.
6. Krueger, A.J., L.S. Walter, P.K. Bhartia, C.C. Schnetzler, N.A. Krotkov, I. Sprod, and G.J.S. Bluth, "Volcanic Sulfur Dioxide Measurements from the Total Ozone Mapping Spectrometer Instruments," *Journal of Geophysical Research*, Volume 100, Number C7, July 1995.
7. Schneider, David J., William I. Rose, Larry R. Coke, and Gregg J.S. Bluth, "Early Evolution of a Stratospheric Volcanic Eruption Cloud as Observed with TOMS and AVHRR," *Journal of Geophysical Research*, Volume 104, Number E2, page 4037, February 1999.
8. Prata, A.J., "Observations of Volcanic Ash Clouds in the 10–12 μm Window Using AVHRR/2 Data," *International Journal of Remote Sensing*, Volume 10, Numbers 4 and 5, page 751, 1989.
9. Baer-Riedhart, Jenny, NASA DC-8 Airborne Laboratory, <http://www.dfrc.nasa.gov/PAO/PAIS/HTML/FS-050-DFRC.html>, April 2002.
10. SAGE III Ozone Loss and Validation Experiment, <http://cloud1.arc.nasa.gov/solve/index.html>, June 2001.
11. Rose, William I., Gregg Bluth, C.M. Riley, Matt Watson, Tianxu Yu, and Gerald G. Ernst, "Potential Mitigation of Volcanic Cloud Hazards Using Satellite Data — a Case Study of the February 2000 Hekla Event and an Unexpected NASA DC8 Encounter," American Geophysical Union, 2002 Fall Meeting, Eos Trans. AGU, 81 (48), Abst. V61B-09.
12. Pieri, D., C. Ma, J. Simpson, G. Hufford, T. Grindle, and C. Grove, "Analysis of In-Situ Airborne Volcanic Ash from the February 2000 Eruption of Hekla Volcano, Iceland," *Geophysical Research Letters*, Volume 29, Number 16, 10.1029/2001GL013688, 2002.

REPORT DOCUMENTATION PAGEForm Approved
OMB No. 0704-0188

Public reporting burden for this collection of information is estimated to average 1 hour per response, including the time for reviewing instructions, searching existing data sources, gathering and maintaining the data needed, and completing and reviewing the collection of information. Send comments regarding this burden estimate or any other aspect of this collection of information, including suggestions for reducing this burden, to Washington Headquarters Services, Directorate for Information Operations and Reports, 1215 Jefferson Davis Highway, Suite 1204, Arlington, VA 22202-4302, and to the Office of Management and Budget, Paperwork Reduction Project (0704-0188), Washington, DC 20503.

1. AGENCY USE ONLY (Leave blank)		2. REPORT DATE August 2003	3. REPORT TYPE AND DATES COVERED Technical Memorandum	
4. TITLE AND SUBTITLE Engine Damage to a NASA DC-8-72 Airplane From a High-Altitude Encounter With a Diffuse Volcanic Ash Cloud			5. FUNDING NUMBERS 436-14-01-E8-YY-00-DC8	
6. AUTHOR(S) Thomas J. Grindle and Frank W. Burcham, Jr.				
7. PERFORMING ORGANIZATION NAME(S) AND ADDRESS(ES) NASA Dryden Flight Research Center P.O. Box 273 Edwards, California 93523-0273			8. PERFORMING ORGANIZATION REPORT NUMBER H-2511	
9. SPONSORING/MONITORING AGENCY NAME(S) AND ADDRESS(ES) National Aeronautics and Space Administration Washington, DC 20546-0001			10. SPONSORING/MONITORING AGENCY REPORT NUMBER NASA/TM-2003-212030	
11. SUPPLEMENTARY NOTES				
12a. DISTRIBUTION/AVAILABILITY STATEMENT Unclassified—Unlimited Subject Category 03 This report is available at http://www.dfrc.nasa.gov/DTRS/			12b. DISTRIBUTION CODE	
13. ABSTRACT (Maximum 200 words) The National Aeronautics and Space Administration (NASA) DC-8 airborne sciences research airplane inadvertently flew through a diffuse volcanic ash cloud of the Mt. Hekla volcano in February 2000 during a flight from Edwards Air Force Base (Edwards, California) to Kiruna, Sweden. Although the ash plume was not visible to the flight crew, sensitive research experiments and instruments detected it. In-flight performance checks and postflight visual inspections revealed no damage to the airplane or engine first-stage fan blades; subsequent detailed examination of the engines revealed clogged turbine cooling air passages. The engines were removed and overhauled. This paper presents volcanic ash plume analysis, trajectory from satellites, analysis of ash particles collected in cabin air heat exchanger filters and removed from the engines, and data from onboard instruments and engine conditions.				
14. SUBJECT TERMS Aircraft, Ash, Safety, Turbine, Volcanic			15. NUMBER OF PAGES 28	
			16. PRICE CODE	
17. SECURITY CLASSIFICATION OF REPORT Unclassified	18. SECURITY CLASSIFICATION OF THIS PAGE Unclassified	19. SECURITY CLASSIFICATION OF ABSTRACT Unclassified	20. LIMITATION OF ABSTRACT Unlimited	