

Title	Environmental Concerns Are Driving The Development of The Welding Processes and Applications(Physics, Processes, Instruments & Measurements, INTERNATIONAL SYMPOSIUM OF JWRI 30TH ANNIVERSARY)
Author(s)	Pekkari, Bertil
Citation	Transactions of JWRI. 32(1) P.11-P.18
Issue Date	2003-07
Text Version	publisher
URL	http://hdl.handle.net/11094/6726
DOI	
rights	本文データはCiNiiから複製したものである
Note	

Osaka University Knowledge Archive : OUKA

<https://ir.library.osaka-u.ac.jp/>

Osaka University

Environmental Concerns Are Driving The Development of The Welding Processes and Applications[†]

Bertil PEKKARI*

Abstract

Higher productivity, high and consistent quality and improved working environment have been the main key drivers for continuous improvement of welding. Nowadays sustainability has become another important driver. The current environmental awareness in the welding industry is fairly low. The society is however much more concerned about environmental aspects. These drive for continuous development of the welding processes and applications. Some described applications from the shipyard, wind and nuclear power and automotive industries will illustrate the progresses.

KEY WORDS: (Sustainability), (Shipyard), (Laser), (Automotive), (Power Generation), (FSW), (Brazing)

1. Introduction

Sustainability is today an important factor in all our activities. Almost all initiated R&D programmes launched in European Union (EU) are covering objectives with environmental requirements. The objectives for the Aeronautics & Space programme totally on €1.075 million includes:

- Reduction of CO₂ by 50 % per passenger-km in the long term
- Reduction of NOX-gases by 20 % (80 %) in the short (long) term
- Reduction of external noise by 4-5 dB (10 dB) in the short (long) term

Similar objectives are presented for the shipyards projects:

- Lower weight 40 % by use of high strength steel (690 grade steel)
- Lower running cost 30 %
- Reduction of CO₂ emissions 15 %
- Lower manufacturing cost 20 %

The German government announced after an oil catastrophe near the Spanish coastline an eight-point programme to improve safety at sea, including the banning of single-hull tankers carrying heavy oil or other dangerous goods from its ports. The automotive industry is facing tough challenges e.g.

- Significantly improved fuel efficiency: 3,2 – 4,5 litre/100km
- Lower CO₂ emission: 86 – 108 g/km
- Low environmental impact - 80-85 % recyclable by 2006

We are also seeing a lot of environmental influenced projects in the energy sector.

Installation of wind power stations is rapidly growing 30-50 % per year. Safe storage of nuclear waste is another a major issue in many countries resulting in long-term R&D projects.

These environmental requirements are demanding development of the joining processes and applications, which will be illustrated in this paper.

2. Environmental Awareness in The Welding Industry

The environmental awareness varies very much between companies. The differences can be segregated as in Fig.1.

Functionality and service are the major concerns, when buying welding and cutting products. Welding is primarily considered a "health and safety" problem, which is noted in the allocation of responsibility for environmental matters. Appointed persons often cover beside the environmental programme also health and safety matters.

Welding is judged to have a small environmental aspect compared to other manufacturing processes. Even though we are fairly slow in implementing environmental programmes in the welding industries we have major challenges in developing the joining processes. The impact of the environmental requirements is manifold as shown in Fig.2. Much of the listed information in this figure must be considered when developing the joining processes and systems.

3. Joining The Automotive Industry

In this industry sector an intense development of joining processes is ongoing as a very large volume of

[†] Received on January 31, 2003

* ESAB AB, Box 8004, 402 77 Göteborg, Sweden
berti.pekkari@esab.se

Transactions of JWRI is published by Joining and Welding Research Institute of Osaka University, Ibaraki, Osaka 567-0047, Japan

Companies segregated according to their environmental awareness

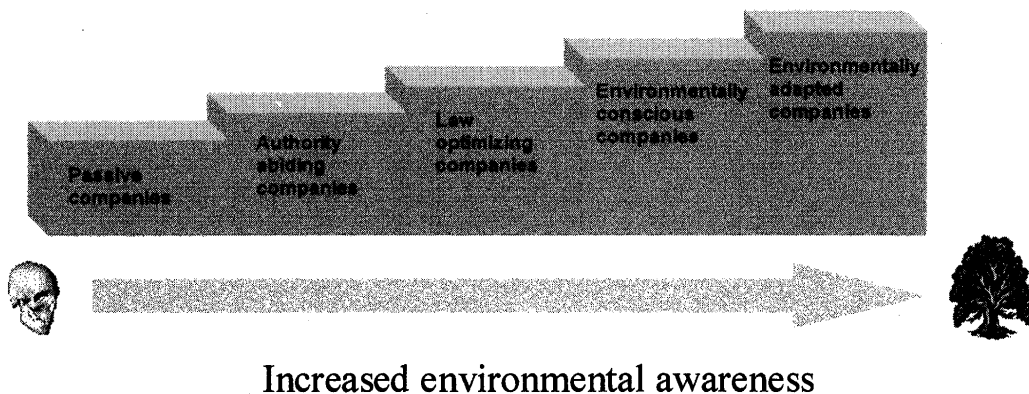

Fig.1 Environmental awareness.

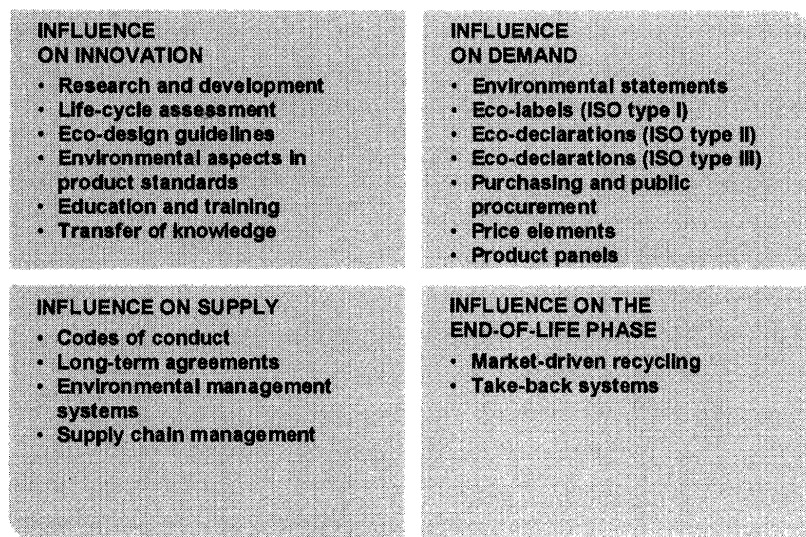

Fig.2 Impacts of an environmental programme.

cars are produced (Fig.3).

By studying the developments in this sector one can fairly well forecast what new joining processes we can expect to see applied in other sectors. The automotive industry is the most important driver of continuous improvement of and innovations in joining.

MIG-, laser- and arc-brazing are processes (1) attracting a lot of interest for welding of zinc-coated steel. The corrosion surface remains intact without any evaporation of the zinc next to the seam when brazing (Fig.4).

The brass solder over bridge gaps well as a consequence of the capillary action. The joint is produced without any spatter and porosity and the joint appearance is attractive.

We can expect more applications in other fields for MIG-brazing e.g. ventilation, household equipment, fire-resistant doors, roof and facade components in the

building industry etc.

The mechanical joining methods; clinching and self-piercing riveting; are increasingly used in this industry especially for Al-cars like Audi A2 (Fig.5). It contains

- YAG-laser welding 30 m with $P = 4 \text{ kW}$, $v = 5.5 \text{ m/min}$
- MIG-welding 20 m $v = 0.7 \text{ m/min}$
- Self-piercing rivets 1800 pieces

The line has 220 robots and the degree of mechanisation is 80 %.

The countermeasure against the higher use of Al by the steel industry is the introduction of Advanced High Strength Steels (AHSS), which is developed in project Ulsab financed by 33 steel companies. Porsche Engineering ending up with made the conceptual design

The car industry is welding much

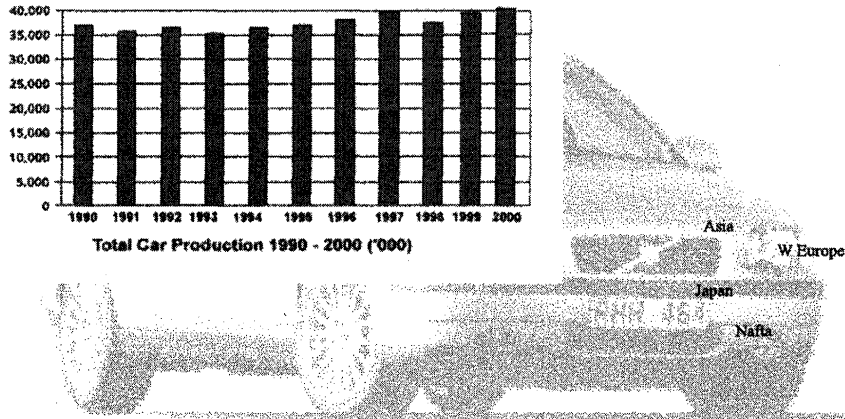

Annual growth 2,1 %

Fig.3 Global development of car manufacturing.

MIG brazing with different gaps Material thickness = 0,8 mm

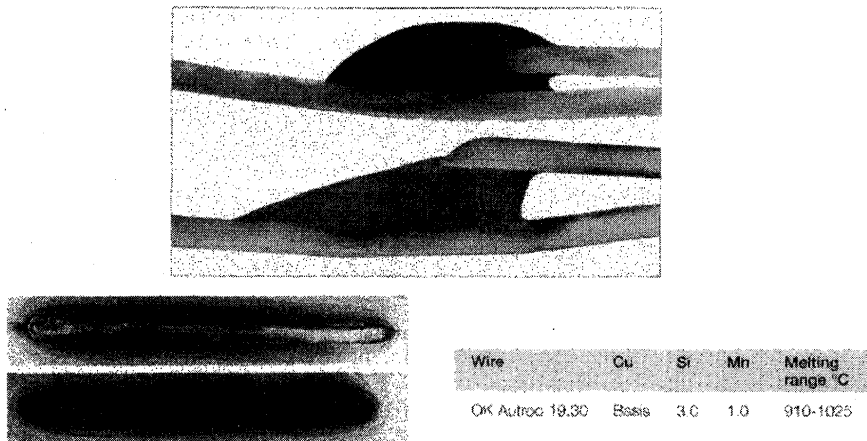

Fig.4 Samples of arc brazing.



Fig.5 Audi A2 completely in Al.

- Meeting anticipated crash safety requirements for 2004
- Significantly improved fuel efficiency: 3,2 – 4,5 litre/100 km
- Lower CO₂ emission: 86 – 108 g/km

- Low environmental impact – recyclable
- High volume manufacturability at affordable cost
- Demonstrating effective design concepts in AHSS: - 200 kg lighter

Tube structures and tailored blanks (40 % of structures) are used. 85 % of the body is made in AHSS. The traditional manufacturing processes can be applied

- Stamping
- Spot welding
- Laser welding
- Hydro forming

It will be interesting to follow how these new options into the automaker's arsenal will be applied to improve safety,

Environmental Concerns Driving Development of Welding Processes and Applications

performance of lower fuel consumption without hitting the car buyer in the pocketbook.

4. Welding in The Shipyard Industry

South Korea is by far the largest producer of ships (Fig.6).

The market has during the last 15 years annually grown on average with 4.6 %. PRC is expected to increase its market share while in Europe Poland and Croatia is doing the same.

Arc welding will remain to be the dominating joining process but with a higher degree of mechanisation to deposit the entire weld metal corresponding (2.2-2.3) % of the steel weight in the ship.

One side SAW is the dominating process for the butt

joints in the panel lines. Cored wires are often used and as well iron powder addition to increase the welding speed.

For welding the stiffeners we note more use of MIG/MAG welding robots (Fig.7), which is since years very common in the Japanese shipyards.

A similar set-up with a gantry and suspended robots is used for curved panel welding stations.

Tandem MAG-welding (2) is becoming a common process in shipyards and construction industry. There are already about 100 installations running in production mostly in Germany (Fig.8).

The Tandem solution has inherently greater freedom in varying the welding parameters like using different electrode diameters or mix with cored and solid wires

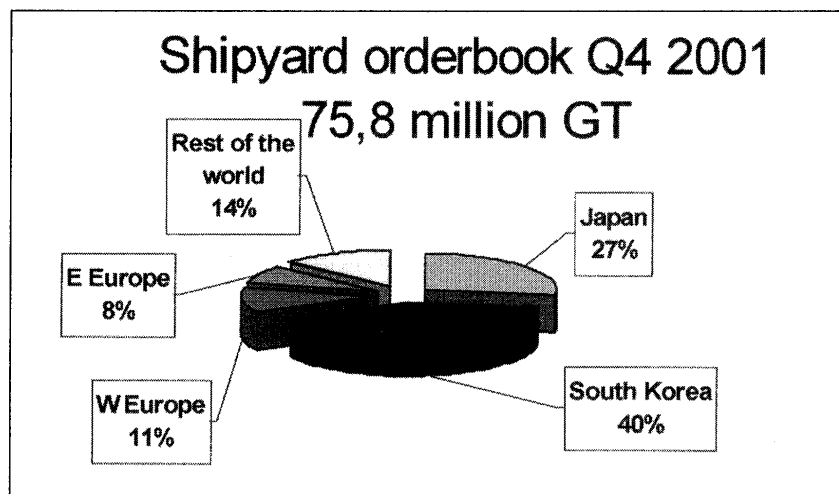

Annual output 28,7 million GT

Fig.6 Distribution of the shipyard order book.

Robot welding gantry

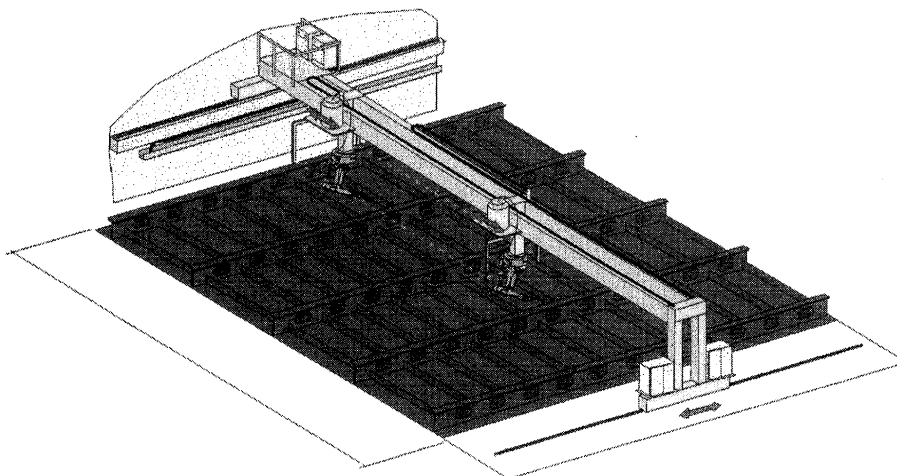

Fig.7 Robot gantry for welding of ship panels.

Tandem MAG welding of Panel Stiffeners



Welding data

Electrodes = 1.2 mm
Throat thickness = 4.5 mm
Stickout = 20 mm

Parameters	Electrode 1	Electrode 2
Welding voltage V	29.5	30.5
Welding current A	385	301
Wire feed speed m/min	18.2	13
Travel speed m/min	2.45	

Fig.8 Tandem MAG welding of stiffeners.

besides the ordinary parameters for voltage, currents and travel speed. In order to reduce the spatter and the interference between the arcs, pulsing with phase shifting is introduced.

There are additional efforts in Europe increasing the degree of mechanisation of welding. The EU-project DockWelder has the objective to demonstrate a flexible modular automation applied in welding ship sections in the dock (Fig.9). The project has the following participants

- Amrose Denmark
- APS Germany
- Cybenetix France
- Lindö Shipyard Denmark
- Ficantieri Shipyard Italy
- Inst. For Production Technology

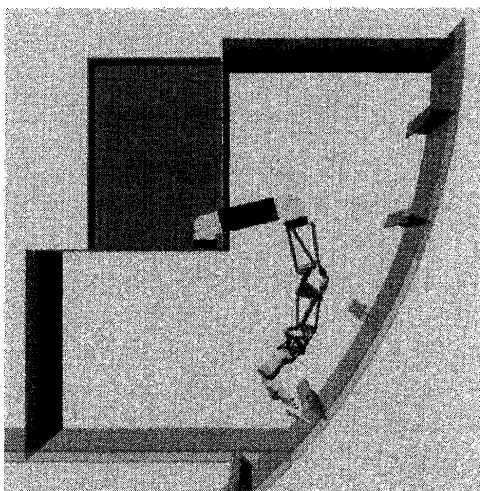

Fig.9 Artistic illustration of the DockWelder.

An optical sensor for joint tracking is used in this installation.

Many European shipyards have jointly investigated the feasibility introducing laser welding of ship panels and classification bodies have been involved for approvals of the welding procedures. Few installations with CO₂-lasers combined with cold wires were made some years ago. The accurate joint preparations with a gap < 0.5 mm required was a major obstacle. The level of impurities of sulphur and phosphor was another hindrance.

The latest process development with a combination of arc and laser welding; a hybrid process; is offering a more tolerant process with larger groove gap allowed 1.0 mm. The heat input is partly also reduced (10 %).

Besides a more tolerant hybrid process the travel speed can be drastically increased; up to 4 times for butt-welding of plate with $t = 5$ mm.

Such a hybrid set-up is in addition requiring a lower investment than a pure laser installation.

We are now seeing a technical breakthrough for the laser hybrid process at Meyer Shipyard in Germany. Figure 10 is an artistic sketch covering both butt-welding of the panels and fillet welding of stiffeners.

The panels are manufactured with closer tolerances and much less distortion.

There are other European shipyards also working with this process and close to invest in a laser panel line.

The next development phase has already started by developing a YAG-laser station for welding the webs and other structures on the ship (Fig.11 below). In this case a YAG-laser with the welding head mounted on an articulated robot is used thanks to the higher flexibility allowed by using an optical fibre delivering the light beam to the welding position. The wavelength is 1.06 μ m

Ship panels 20x16 m welded with the hybrid laser MIG process

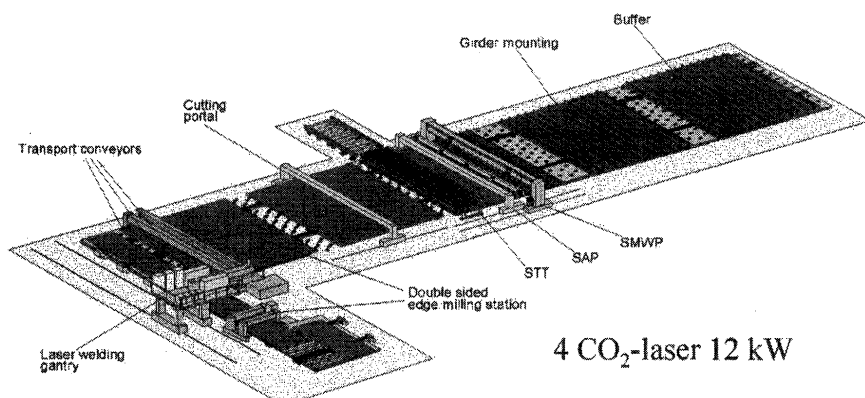

Fig.10 Laser hybrid MIG ship panel line.

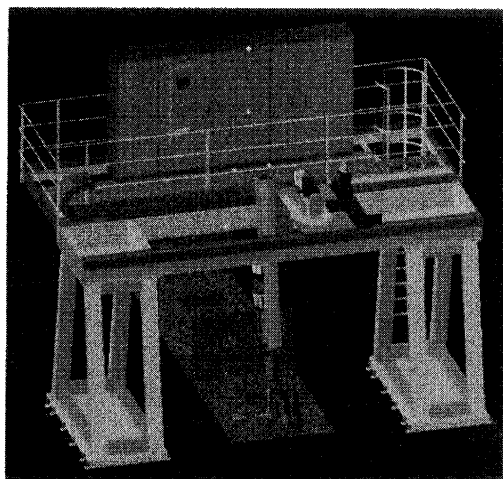

Fig.11 Concept on a YAG-laser installation.

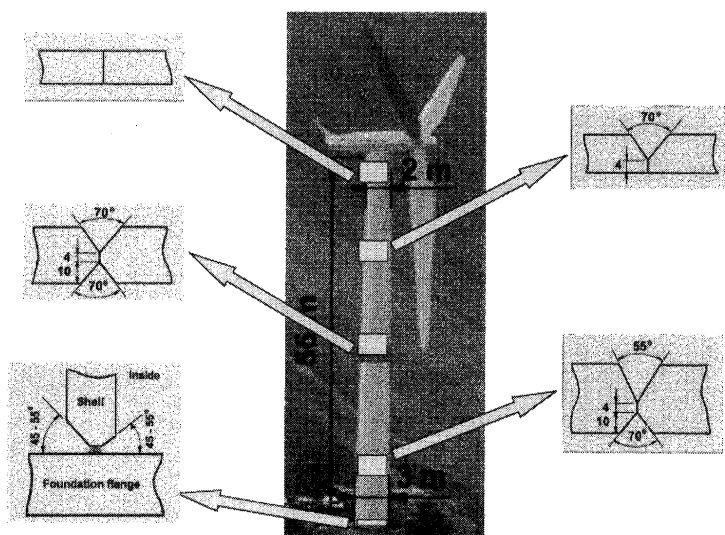

Fig.12 Typical joint preparations.

compared with the wavelength for CO₂ light beam 10.6 μm, for which an optical fibre cannot be used.

5. Welding in Power Generation Industry

The environmental sustainability objectives are among all resulting in an increased number of installed wind power stations, which contains currently a lot of weld metal on average 1500 kg. The SAW process is hence used when possible to get a high deposition rate. Then the welds must be made in down hand position with a root pass from inside and the capping passes from outside, for which two electrodes DC and AC are mostly used. Figure 12 shows typical joint preparations for the material thickness between 8-50mm.

Some welding data are listed in Table 1. Tapering between shells of different thickness is recommended in order to reduce the stress concentration at the weld joint.

Systems similar to the one shown in Fig.13 are often installed. As in other SAW applications metal-cored wires are introduced.

In contrast to the “clean” wind power the nuclear power produces dangerous waste, which must be safely disposed. In Sweden the Swedish Nuclear Power and Waste Management Company (SKB) is carefully evaluating the Electron Beam Welding and Friction Stir Welding processes for encapsulation of the waste in durable canisters in Cu. These will be stored in a deep repository in the Swedish bedrock. The Cu canister consists of a five centimetre thick Cu casing. Inside, there is a cast iron insert to provide mechanical strength. The canister (Fig.14) is close to five metres long and has a diameter of about one metre. A canister filled with spent fuel weighs about 27 tonnes.

A full-scale Electron Beam Welding tests have been

Table 1 Example on joint preparation and welding.

t=45 mm, X-joint

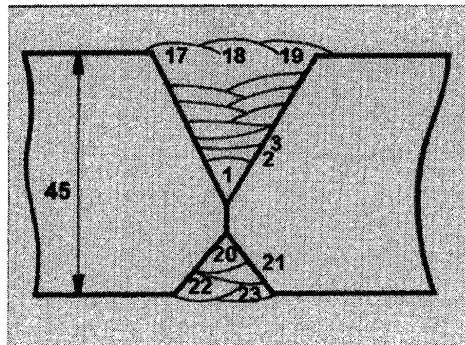

Run No.	Wire diam. mm	Weld current A	V	Speed cm / min
1	4	600	24	50
2	4	600	25	50
3	4	600	26	50
5-12	4	600	27	50
13-18	4	600	30	50
20	4	750	26	50
21-23	4	600	30	50

ESAB Production Line of positioners for wind towers

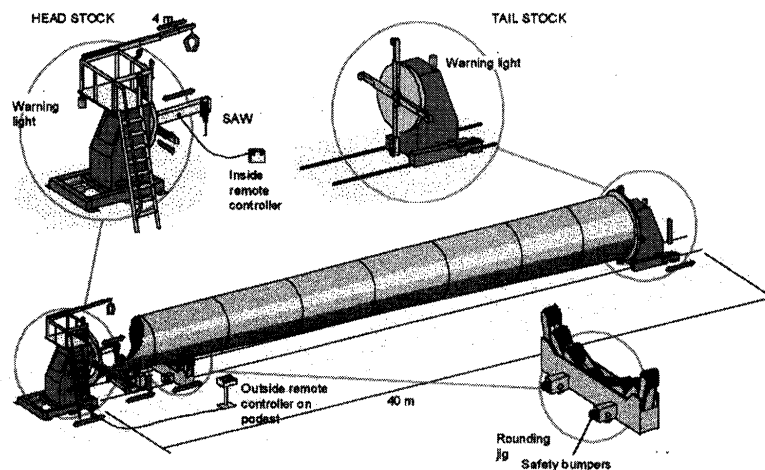

Fig.13 Setup for welding a tower.

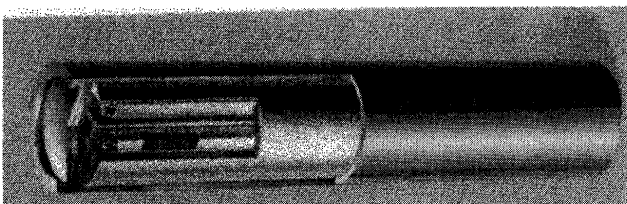

Fig.14 Cu-canister for nuclear waste.

performed. In 1998-1999, a test rig was built at TWI for the Friction Stir Welding of mock-up canisters. A fixture holds the canister and rotates it during welding. The lid is pressed down with four hydraulic cylinders. The welding speed reaches 150 mm per minute. The FSW process has functioned well and SKB has ordered an installation, which is sketched in Fig.15. Figure 16 shows the weld

result.

6. Conclusions

The described applications prove that sustainability is requiring development of the joining processes and applications. The driving forces behind these demands are among all

1. Productivity
2. Quality
3. Flexibility
4. Working environment
5. Sustainability
 - Reduction of energy consumption
 - Use of renewable energy sources
 - Safe disposal of waste
 - Safety

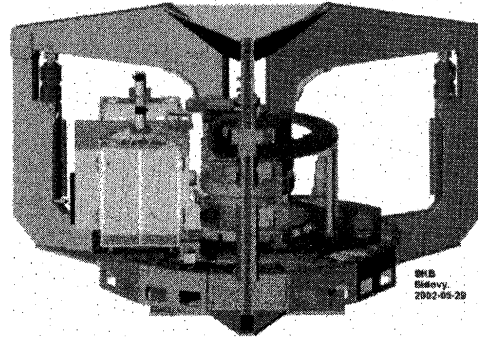
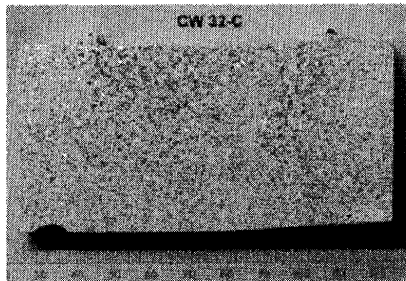
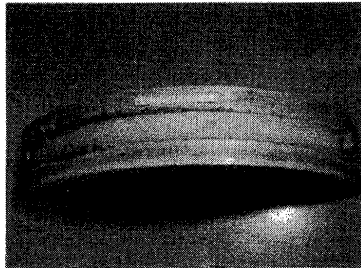

Fig.15 The welding heat rotates during the process around the fixed canister.

Welding of a lid to Cu-canister for nuclear waste with = 50mm in Sweden



A transverse metallurgical section through 50 mm thick Cu stir weld



A 120 degree weld segment

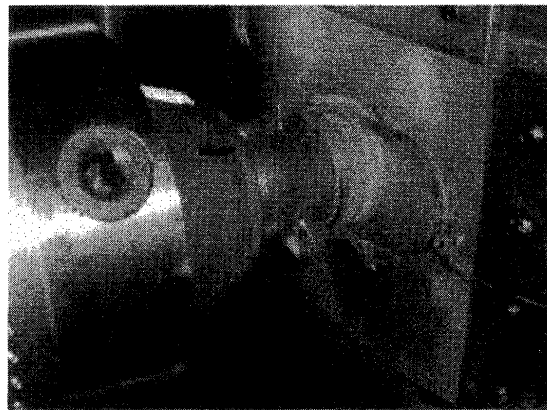

The early stages of a Cu canister weld. Note that the tool is operating at red heat

Fig.16 First FSW results.

References

- 1) H.Rohde, J.Katic, R.Paschold: *SVETSAREN No 3, (2000) page 24*
- 2) S.Goeke, J.Hedegård, M.Lundin, H.Kaufmann: *SVETSAREN No 2-3 (2001) page 14*
- 3) C-G.Andersson, R.E.Andrewa, B.G.I.Dance, M.J.Russel, E.J.Olden and R.M.Sanderson: *Proc.FSW International Symposium 2001 in Sweden*
- 4) L-G.Eriksson and R.Larsson: *SVETSAREN No 2 (2002) page 1*