

UC Berkeley

Dissertations

Title

Essays on Urban Transportation and Transportation Energy Policy

Permalink

<https://escholarship.org/uc/item/7sn272sc>

Author

Kim, Chun Kon

Publication Date

2008-12-01

University of California Transportation Center
UCTC Dissertation No. 162

Essays on Urban Transportation and Transportation Energy Policy

Chun Kon Kim
University of California, Irvine
2008

U C
 I ,

Essays on Urban Transportation and Transportation Energy Policy

D

submitted in partial satisfaction of the requirements
for the degree of

D P

in Economics

by

Chun Kon Kim

Dissertation Committee:
Professor Kenneth A. Small, Chair
Professor David Brownstone
Professor Kurt Van Dender

2008

The dissertation of Chun Kon Kim
is approved and is acceptable in quality and form for
publication on microfilm and in digital formats:

Committee Chair

University of California, Irvine
2008

T C

L	F							
L	T							
A								
C	V							
A	D							
1	I		1					
2	D	T	E	U	5			
	2.1	Introduction			5			
	2.2	Statistical Analysis			8			
		2.2.1	Data		8			
		2.2.2	Population and density data		9			
		2.2.3	Transportation and Energy Use Data		10			
	2.3	Density and Transportation Energy Consumption			12			
		2.3.1	Density Measures and Explanatory Variables		12			
		2.3.2	Model specification		14			
		2.3.3	Estimation Results		19			
	2.4	Conclusion			28			
3	T	I	T	E	C	S	F	30
	C	E						30
	3.1	Introduction						30
	3.2	Previous Studies						33
		3.2.1	Studies on Pricing Policies					33
		3.2.2	Studies on Regulation Policies					36
		3.2.3	Comparative Analysis of Policy Instruments					37
		3.2.4	Proposals of Policy Instruments					37
	3.3	Discussion of Policy Instruments						39
		3.3.1	Descriptive Impacts of a Policy Change					39
		3.3.2	Characteristics of Policy Instruments					42
	3.4	Analytical Model						44
		3.4.1	Vehicle miles, vehicle stock, and fuel efficiency					44
		3.4.2	VMT change:					48
		3.4.3	Fuel consumption					49
		3.4.4	Greenhouse Gas (GHG) Emissions					50
		3.4.5	Welfare Changes					51
	3.5	Data and Policy Simulations						53

	3.5.1	How to measure the impacts	53
	3.5.2	Simulation model structure	54
	3.5.3	Data and Parameter Values for simulation	55
	3.5.4	Assumptions on exogenous variables	55
	3.5.5	Policy Options and Scenarios	56
3.6		Impacts on Vehicle Stock and Vehicle Usage	57
	3.6.1	Per-mile Driving Cost	57
	3.6.2	Vehicle Usage and Vehicle Stock	58
	3.6.3	Fuel Consumption and tax revenue	58
	3.6.4	Greenhouse Gas Emissions and Tax Revenues	60
	3.6.5	Welfare Changes: Cost Savings	61
	3.6.6	Results Summary	62
4		T I T E P T S	63
	4.1	Introduction	63
	4.2	Light Duty Vehicles and Traffic Safety	64
	4.2.1	Trends in Light Duty Vehicle Transportation	64
	4.2.2	Trends in Traffic Crashes	66
	4.3	Literature on the Impact of Vehicle Attributes on Traffic Crashes	67
	4.3.1	Effects of Transportation Energy policy on Traffic Crashes	67
	4.3.2	Vehicle Size and Weight and Traffic Crashes	68
	4.3.3	CAFE and Traffic Safety	70
	4.4	Analytical Model for the Impacts of Policy Changes on Traffic Safety	71
	4.4.1	Traffic Crashes and Damage	72
	4.4.2	Accident Costs	78
	4.5	Decomposing Vehicle Miles and Vehicle Stock by Vehicle Type	78
	4.5.1	Decomposing Vehicle Stock into Cars and Light Trucks	79
	4.5.2	Decomposing Vehicle Miles by Vehicle Type	81
	4.6	Policy Simulations	82
	4.6.1	Policy Options and Scenarios	82
	4.6.2	Parameters and Data	82
	4.7	Impacts on Transportation Safety	83
	4.7.1	Share of Light Trucks	83
	4.7.2	Number of Vehicles Involved in Accidents	84
	4.7.3	Fatalities and Fatality Rates	85
	4.7.4	Accident Costs	88
	4.7.5	Results Summary	89
5		C	91
		A	95
	A	Estimation Results of System Equations	95
		B	97

L F

2.1	Vehicle Miles and Highway Fuel Consumption in the U.S.	11
2.2	Fuel Consumption and Population Density in the U.S.	13
3.1	Framework of the Study	41
3.2	Measuring Welfare Changes	51
3.3	Comparison of Per-mile Driving Cost	57
3.4	Comparison of Vehicle Miles and Vehicle Stock	59
3.5	Comparison of Fuel Intensity and Fuel Consumption	60
3.6	Comparison of Greenhouse Gas Emissions and Tax Revenues . . .	61
4.1	Light Trucks Index and The Share of Light Trucks	84
4.2	Index of Traffic Crashes by Vehicle Type (single crash + 2-veh. crashes)	85
4.3	Total Fatalities from accidents	87
4.4	Share of Fatalities in two vehicle crashes	87
4.5	Traffic Accident Costs	89

L T

2.1	Descriptive Statistics	17
2.2	Least Squares Regression Results	23
2.3	Fuel Consumption Equation Estimation Results	25
2.4	Road Supply Growth Equation Regression Results	27
2.5	Summary of Results	27
3.1	Expected Impacts of Policy Options	42
3.2	Summary of simulation results (Average over 2005-2030)	62
4.1	Vehicle Crash Involvement and Fatality Rate	83
4.2	Summary of simulation results (Average over 2005-2030)	90
A.1	Estimation Results of System Equations (3.1) Using 3SLS	96

ACKNOWLEDGMENTS

First of all, I would like to thank God for His making all this possible. Sometimes I felt that I might not be the right person to pursue Ph.D degree due to slow progress. But I believed that there would be my role to contribute with my knowledge and skills somewhere. God, I still pray for that and I believe YOU will make a way.

Though only my name appears on the cover of this dissertation, I would like to acknowledge many people for helping me during my graduate studies.

I would like to gratefully and sincerely thank my advisor, Prof. Kenneth Small, for his guidance, understanding, patience, and financial support. Throughout my doctoral work he encouraged me to develop independent thinking and research skills. He continually stimulated my analytical thinking and greatly assisted me with writing skills. I am extremely grateful to have such a wonderful advisor in my life.

I would also like to thank my committee members, Prof. Kurt Van Dender and Prof. David Brownstone for their precious time and guidance. Prof. Van Dender, who is now at the Joint Transport Research Centre of the OECD and the International Transport Forum in Paris, France, encouraged me to grow as an independent problem solver. Prof. Brownstone helped me understand econometric skills and interpret the results. I would like to express special thanks to the late Prof. Charles Lave, my former committee member, for his helpful comments and suggestions after the oral exam.

The period I spent at the UC Irvine was stressful sometimes but also enjoyable most of the time thanks to many good student colleagues at the Department of Economics and the Institute of Transportation Studies (ITS). I specially thank Chen Ng for her helpful comments and advice.

I acknowledge that this research was partially funded by the University of California Energy Institute, by the University of California Transportation Center, and also by the Newkirk Center for Science and Society. I am grateful for the administrative assistance I received from the staff of Graduate Studies Office at the School of Social Science and of the ITS.

Finally, and most importantly, I would like to thank my family (here in the U.S. and in Korea) for their quiet and strong support. Their prayer, their faith in me, and financial support were unforgettable. Especially, my wife, Young Chai's love, encouragement, quiet patience and trust for the past 10 years were undeniably the strongest support. I also thank my two kids, Jong Hyun (John) and Jueun (Nicole), for their kisses every day.

All errors in this dissertation belong solely to me.

CURRICULUM VITAE

Chun Kon Kim

E		
Doctor of Philosophy in Economics		2008
University of California, Irvine		<i>Irvine, California</i>
Master of Arts in Economics		2008
University of California, Irvine		<i>Irvine, California</i>
Master of Science in City Planning		1999
Seoul National University		<i>Seoul, KOREA</i>
Bachelor of Art in Agricultural Economics		1995
Seoul National University		<i>Seoul, KOREA</i>
R	W	E
Graduate Student Researcher		2003–2008
University of California, Irvine		<i>Irvine, California</i>
Teaching Assistant		2004–2006
University of California, Irvine		<i>Irvine, California</i>
Researcher		1999–2002
Korea Transport Institute (KOTI)		<i>Goyang, KOREA</i>
S	H	A
Graduate Student Fellowship		2007
Newkirk Center, UC Irvine		
Doctoral Dissertation Grant		2006
University of California Transportation Center (UCTC)		
Regents' Dissertation Fellowship		2006
University of California, Irvine		
California Energy Studies Grant (with Kenneth A. Small)		2005
University of California Energy Institute (UCEI)		

P	W	P	
The Impacts of Transportation Energy Policy on Fuel Consumption and Transportation Safety			2008
(presented at 14th UCTC student conference at UC Santa Barbara)			
Efficiency Costs of Constraints on the Use of Urban Transportation Tax Revenues			2006
(Department of Economics, UC Irvine)			
Density and Transportation Energy Consumption in the U.S., 1966-2001			2006
(poster presentation at 12th UCTC student conference at UC Berkeley)			
An Application of Two-part Tariff Pricing to Expressways: A Case of Korea (with Hun-Koo Ha)			2001
(presented at the 9th World Conference on Transport Research (WCTR) in Seoul)			
P		K	
An Analysis of Reasonability of Ear-marked Fuel-tax in Transportation Sector (with Hun-Koo Ha)			2002
Korea Transport Institute (KOTI)			
Problems and Improvements of Financing Transport Infrastructure Investment in Korea (with Hun-Koo Ha)			2000
Korea Transport Institute (KOTI)			
An Estimation of Reasonable Rates of Return on Private Sector Investment in Infrastructure (with Hun-Koo Ha)			1999
Korea Transport Institute (KOTI)			
A		A	
Student Member			2007 – present
Institute of Transportation Engineers (ITE)			
Student Member			2006 – 2007
Transportation Research Board (TRB)			
Lifetime Member			2001 – present
Korean Society of Transportation			

A

D

Essays on Urban Transportation and Transportation Energy Policy

By

Chun Kon Kim

Doctor of Philosophy in Economics

University of California, Irvine, 2008

Professor Kenneth A. Small, Chair

This dissertation outlines three topics on urban transportation energy, emphasizing the role of transportation energy policy, and aims to provide a single comprehensive framework to evaluate and compare different pricing and regulatory policy options for reducing transportation fuel consumption in the United States.

In the first chapter, I examine the effect of population density on motor fuel (i.e., highway gasoline) consumption, controlling for other variables such as gas price, income, vehicle stock and so on, using state level aggregate cross-sectional time series data from 1966 to 2004. By estimating the impact of density on fuel consumption, I improve the understanding of the conventional logic that there is a negative correlation between population density and transportation energy use due to reduced average travel distance and availability of alternative modes in denser area.

In the second part, I examine various transportation energy policy instruments such as a fuel tax, a mileage based VMT tax, Corporate Average Fuel Economy

(CAFE) standards, a Pay-at-the-pump (PATP), and a Pay-as-you-drive (PAYD) insurance premium to measure policy impacts through computerized policy simulations. By fully integrating three interrelated economic demand decisions - size of vehicle stock, use of the vehicle stock, and energy efficiency - it can predict short-run, long-run, and dynamic effects of a policy change. The impacts are measured in terms of vehicle miles traveled, fuel consumption, greenhouse gas emissions, and cost savings. I also examine the impact of transportation energy policies on traffic safety in terms of the number of traffic accidents, traffic fatalities, and total accident costs.

The outcome of this research provides a set of specific results comparing policy scenarios in a consistent manner. The results will provide guidance concerning whether the policy option would reduce energy dependency as well as undesirable side effects such as environmental problems and safety problems of motor-vehicle travel.

C 1

I

The United States is a heavily energy dependent country. It has about 5 percent of the world's population, but uses a much greater proportion of the world's energy resources. Transportation sector is responsible for a large portion of energy consumption in the U.S.¹ and motor vehicles contribute to air pollution and global warming, both of which are the subject of policy concern in the country. In addition, there is a desire to enhance energy security through various transportation energy conservation strategies. Therefore, a comprehensive analysis of policy options to conserve energy in transportation sector is useful.

Though many different types of energy are used in the transportation sector, we narrow our focus to highway use of gasoline by automobiles and light trucks, since gasoline use represents more than 60% of all transportation energy sources and highway gasoline use is more than 95% of gasoline consumption (U.S.DOE 2007).

Reducing transportation fuel consumption would not only enhance the country's energy dependency but also help to reduce greenhouse gas emissions, improve air quality, and reduce other driving-related external costs such as traffic accident costs. Therefore, a comprehensive review of transportation energy policy options to reduce transportation fuel consumption is necessary.

Conservation of transportation energy can be approached in two ways: one is through urban planning by changing urban spatial structure considering the

¹According to *Transportation Energy Data Book* by the U.S. Department of Energy (DOE), transportation share of U.S. total energy consumption in 2005 is 28.0% with 1.3% of average annual percentage change over the period 1973-2005. In terms of expenditure, households spend approximately 3.2% of annual income (before tax) on gasoline and motor oil, which is about 17% of all transportation expenditure in 2003.

relationship between land use and transportation; the other is through a more narrow transportation policy, which here is defined as a policy that causes changes in traveler's monetary costs.

This dissertation outlines three topics on urban transportation energy, emphasizing the role of transportation energy policy, and aims to provide a single comprehensive framework to evaluate and compare different pricing and regulatory policy options for reducing transportation fuel consumption in the United States.

First, I examine the effect of population density on motor fuel (i.e., highway gasoline) consumption, controlling for other variables such as gas price, income, vehicle stock and so on, using state level aggregate cross-sectional time series data from 1966 to 2004. By estimating the impact of density on fuel consumption, I improve the understanding of the conventional logic that there is a negative correlation between population density and transportation energy use due to reduced average travel distance and availability of alternative modes in denser area.

Second, I measure the impacts of transportation fuel conservation strategies through a policy simulation model. The impacts are measured in terms of vehicle miles, fuel consumption, greenhouse gas emissions, and cost savings with various changes in policy scenarios. Here we are primarily concerned with the following economic policy alternatives: (1) raising the existing fuel tax (*Fuel Tax*); (2) instituting a tax on vehicle miles traveled (*VMT Tax*); (3) converting insurance payments to per-gallon basis (pay-at-the-pump, or *PATP*); (4) converting insurance payments to a per-mile basis (pay-as-you-drive, or *PAYD*); (5) regulating stronger corporate average fuel economy (*CAFE*) standards.

Third, I also examine the impact of transportation energy policies on traffic safety. I focus on changes in VMT and in vehicle composition as a result of policy

changes and then examine the effect on traffic accidents of those changes in terms of the number of traffic accidents, traffic fatalities, and total accident costs considering externalities of traffic crashes.

The method for measuring policy impacts is based on an analytical framework by Small and Van Dender (2007), and identifies the ways that behavioral reactions modify policy outcomes. The model fully integrates three inter-related economic demand decisions: size of vehicle stock, use of the vehicle stock, and energy efficiency. I pay attention not only to direct impacts on travel demand (i.e., VMT and fuel consumption) but also to indirect (external) impacts on environment (e.g., greenhouse gas (GHG) emissions) and transportation safety, which are often not taken into account. Considering travelers' behavioral reactions through changes in other decision making factors clarifies how indirect impacts may modify policy outcomes.

The outcome of this research provides a set of specific results comparing policy scenarios in a consistent manner. The results will provide guidance concerning whether the policy option would reduce energy dependency as well as undesirable side effects such as environmental problems and safety problems of motor-vehicle travel.

This research contributes to literature in following ways. First, I develop a policy simulation model capable of assessing the impacts of policies by adding details to Small and Van Dender's (2007) econometric model, necessary to account for features of the policies being examined. For example, I extend their model to analyze the impact not only on travel miles but also fuel consumption, environmental emissions, and traffic fatalities. For doing this, I construct an analytical model of decomposing vehicle miles and vehicle stock, which allows to project the impact of policies by vehicle type. Second, I also develop a traffic accident model and compute the probabilities of accident and fatality risk of

different type of vehicles (i.e., cars and light trucks) and different type of accidents (i.e., single-vehicle crashes and two-vehicle crashes). The probabilities and fatality rates changing along with the share of light trucks and travel miles can be a development of assumed analysis of light truck shares in White (2004). Third, the simulation model can be used and adapted for the analysis of each state or of the entire United States by specifying the analysis region in the data set. Thus, it provides a tool for analyzing regional policies, or federal policies. Fourth, the data set from 1966 to 2004, which is cross-sectional time series data at the U.S. State level, is longer than other studies and it is constructed so that it is easy to use in simulations and to update in the future.

C 2

D T E
U

2.1 I

Land use pattern with given transportation infrastructure, which has different levels of residential or employment density, affect transportation energy consumption through effects on travel demand (i.e., Vehicle Miles Traveled or VMT), activity location, mode choice and traffic congestion. In other words, transportation energy consumption is not only a function of transportation patterns, but also a function of different density levels.

There have been some studies on the effects of land use patterns (or urban form) on vehicle usage, either at an aggregate or a disaggregate level. Steiner (1994) reviews theoretical and empirical literature on the interactions between high residential density, land use characteristics and transportation choices. He also introduces the discussion of high-density transit-oriented development which may reduce the usage of motor vehicles and shorten (average) travel distance. Levinson and Kumar (1997) evaluate the influence of residential density on commuting behavior (i.e., travel distance, speed, and travel time) across U.S. cities using individual travel behavior data from Nationwide Personal Transportation Survey (NPTS). They find density has negative effects on speed and travel distance but has ambiguous effect on travel time depending on density level. According to their results, travel time decreases at low density but increases above the threshold level (10,000 people per square mile). Regarding policy implications, they argue that density is a less important policy instrument than

the size of cities to influence individual's travel behavior.

Boarnet and Crane (2001) explore the relationship between urban form and travel behavior considering model specification and estimation issues. They also explore the implications of alternative behavioral assumptions regarding travel costs. When the land use variables are measured for postal codes, the effects of land use on the number of non-work trips are insignificant. If measured by the type of street network and by the distance from CBD, they are significant for some of the variables. They argue that the effect of land use characteristics on trip generation is complicated. Bento *et al.* (2003) separately measure the impacts of urban structure and those of public transit supply on the annual miles driven and commute mode choices. Using micro data from NPTS, they find that population centrality and jobs-housing balance have a significant impact on annual household vehicle miles traveled (VMT) while holding individual characteristics constant.

There are also several studies on the impact of urban density on transportation energy consumption. Newman and Kenworthy's (1989) study, which shows a strong (negative) correlation between urban density and energy consumption, is widely cited but also severely criticized.¹ Mogridge(1985) shows that the level of car ownership is the strongest determinant of energy consumption. Fujiwara *et al.* (2004) estimate transportation energy consumption by calculating link traffic volumes and average link speeds in Hiroshima metropolitan area in Japan. Their conclusion is that the more population is dispersed to the suburbs of a city, the more transportation energy is consumed. Golob and Brownstone (2005) explore the effect of residential density on vehicle usage using disaggregate data from National Household Transportation Survey (NHTS). They apply a simultaneous

¹Although they considered economic factors such as gasoline price, income, fuel efficiency, they were criticized for their methodology of not controlling those factors simultaneously and for emphasizing land use policy as a way to conserve transportation energy. See, for example, Gordon and Richardson (1989), Gómez-Ibánñez(1991).

equations model to explain the simultaneity of residential location choice on the effects of residential density on vehicle usage. Their result show substantial effects of residential density on energy consumption and are decomposed into the effect of VMT and the effect of fleet fuel economy.

Greene (1979) and Lin *et al.*(1985) study state level difference in gasoline demand using state level aggregate data over 1966-1975 and over 1966-1980 period respectively. They include population density variable as one of the explanatory variables to see state level differences and show negative impact of density on gasoline demand² controlling for gasoline price, income, licensed driver rates, household size etc.

The advantage of using state level data is that it eliminates most of the simultaneity problem observed by Golob and Brownstone (2005) that arises at micro level due to endogeneity of household location decision. This assumes people are unlikely to choose their state based on their preference regarding travel and fuel consumption. The purpose of this paper is to explore the relationship between regional population density³ and transportation energy consumption using state level aggregate data. We hypothesize that higher density reduces transportation energy consumption as we have seen in previous literature at city or metropolitan area level. We test this hypothesis with the conventional population density measured by the number of people per unit of land area. This study uses panel data across U.S. 50 states (plus District of Columbia) over 39 years while most studies analyze the topic using cross-sectional data for a single year.

²In Greene's study, two density variables, weighted average of urban and rural population densities and the percentage of population living in SMSA, are included while only the percentage of population in MSA is included in Lin *et al.*'s study (1985)

³The density measures in most studies are at a city or metropolitan area level and it is referred as "urban" density. Since this study measures densities at state level, which encompass both urban and rural areas, "regional" means a state level area.

2.2 S A

2.2.1 D

The analysis of this paper is based on aggregate panel data from 1966 to 2004 across 50 states plus District of Columbia in the United States. It may be more desirable if we can measure urban density and transportation energy use and compare the results for city or metropolitan area level. But some variables such as transportation energy use, and vehicle registration are difficult to collect in a consistent manner at city level. Most variables are measured separately for each state and price index variable is measured by national level only.

Most demographic data, such as total population by state and by age group, population ratio of metropolitan area population to total population, and land area⁴ are based on Census data directly from the U.S. Census Bureau or from the published *Statistical Abstract of the United States*. We also collect land use (land cover) data, especially farm land and rural land,⁵ to find an alternative measure or a proxy for density⁶ using the data from Natural Resources Conservation Service (NRCS) of U. S. department of agriculture, which provides agricultural census data every 5 years from 1982.

Transportation and its energy consumption data are provided mostly by Federal Highway Administration (FHWA). Regarding gasoline consumption data, we only consider highway use of gasoline by private and commercial and by

⁴Land area data are available only for the Census years with very slight changes (less than 1% of change in average). So it is assumed that there was no change in land area between the census years.

⁵Rural land area is the total of crop land, pasture land, range land, forest land, and other rural land. Detailed data are available from NRCS at http://www.nrcs.usda.gov/technical/land/cover_use.html

⁶The conventional population density may not be good enough to capture the impact of density on energy consumption at state level since huge amount of area which may not be used for residential purpose in some states. So we experimented with the number of people living in metropolitan area divided by a proxy of urban land area, which is calculated by subtracting farm and rural areas from state land area, but it turned out not to be a good proxy for density because of the area of neither urban nor rural areas.

public sector. The amount of gasoline used in highway accounts for about 80% of the total motor fuel consumption.

2.2.2 P

Conventionally density for a place such as city, county, or state is measured by the number of people per unit land area (mostly square mile or square kilometer). This population density is an often reported and commonly compared among cities or among countries around the world. Since traditional residential density just tells us how many people are living in a specific size of land it may not give information of "urban" density.

If we could collect the number of people living in metropolitan area divided by the metropolitan land area, it might work as a better density measure. But it is difficult to trace and to collect metropolitan land area at state level with its changing definitions of metropolitan statistical areas (MSAs) over the period and with some MSAs overlapping two or three states. Though it is not a density measure, the urbanization ratio, which relates to urban land use, is collected. The urbanization ratio is measured by the number of people living in metropolitan area⁷ divided by state total population.

We collect not only state total population and urbanization ratio but also the number of licensed drivers, and the age distribution of the population. Adult population is defined as the people of age 18 and above and it is assumed that the legal driving age is same for all states, which is 18.

⁷U.S. Census Bureau doesn't explicitly provide the data of the size of metropolitan areas. regarding urbanization ratio.

2.2.3 T

E U D

Vehicle miles traveled (VMT) is most widely used measure of vehicle usage and also a key variable to determine transportation fuel usage. Our data show that it has increased 3% per year on average since 1966 and the growth rate is higher than that of either population or Gross Domestic Product (GDP).

We are interested in the impact of regional density on transportation fuel consumption and the transportation fuel consumption data are available along with VMT. Highway motor fuel consumption data are reported from each state's motor-fuel tax agency. Gasoline takes up about 80% of total motor fuel use in transportation and about 98% of total gasoline consumption is for private, commercial and public use of highway. Therefore, we use the fuel consumption data, more precisely the amount of motor gasoline consumed per capita for highway use denoted as fuelcapita.

Other important transportation variables include price of gasoline as a proxy for operating cost of vehicle, personal income per capita, the number of automobiles and light trucks registered, and road mileage. With respect to the vehicle stock, it seems that the popularity of light trucks including mini-van, SUVs is growing in 1990s. Considering relatively low fuel economy of light trucks, the increase in the number of light trucks and their usage imply increase in transportation fuel consumption. According to the data by the U.S. Department of Energy (DOE), energy consumption by transportation sector accounts for about 23.7% and 26.8% in U.S. consumption of total energy for year 1966 and 2004 respectively, with 2.2 % of average annual increase over the period 1966-2004.⁸ In terms of expenditure, approximately 3.4% of average annual household expenditures is spent on motor gasoline and motor oil, which is about 17.4% of all

⁸U.S. Department of Energy (DOE), "Historical End-Use Consumption Data" available online at <http://www.eia.doe.gov/neic/historic/hconsumption.htm> (accessed on Aug. 10, 2005).

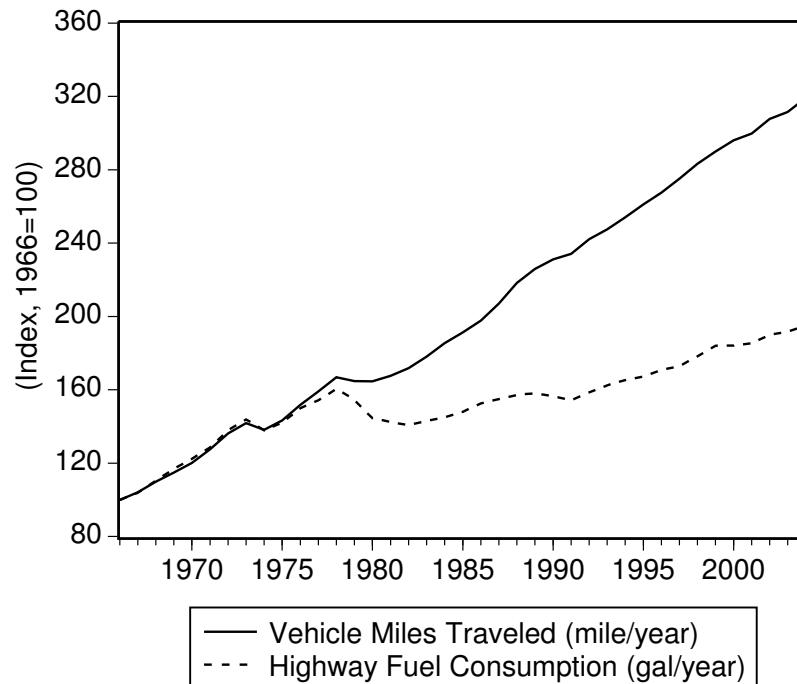

Figure 2.1: Vehicle Miles and Highway Fuel Consumption in the U.S.

transportation expenditure in 2000.⁹ Though there are many different types of energy used in transportation sector,¹⁰ we focus only on highway use of gasoline by automobiles and light trucks since highway gasoline use takes more than 95% of share in gasoline consumption and it is most closely related to the issue whether sprawl causes energy consumption.

Figure 2.1 shows the trends and the changes of the U.S. highway use of gasoline (HUG) and vehicle miles traveled (VMT) over the three decades. We can see a similar trend in 1970s between HUG and VMT. It shows a increasing trend in its consumption except the years following oil shock (1974, 1979) and the Gulf War (1991). VMT decreased in 1974 and 1979 but it kept increasing since 1980. The gap between VMT and HUG becomes larger since 1980. In 2000, VMT grows

⁹U.S. Bureau of Labor Statistics (BLS), “Consumer Expenditure in 2000” at <http://www.bls.gov/cex/csxann00.pdf> (accessed on Aug. 25, 2005)

¹⁰Other possible data sources for transportation are liquified petroleum gas (LPG), jet fuel, natural gas, and electricity.

more than twice while HUG increases about 50% from its 1970 value. Fuel efficiency, which has improved on average, explains the gap. The improved fuel efficiency may explain some part of the gap causing increase in VMT with relatively inexpensive operating cost per mile (i.e., price of gasoline per mile), which is known as "rebound effect" (See, e.g., Greening *et al.* 2000) assuming people use same amount of HUG. The increasing number of light trucks, which is not shown on the graph, may also be a reason for the gap between VMT and HUG since trucks have lower fuel efficiency than automobile.

2.3 D T E C

2.3.1 D M E V

1) P D F C

When we plot motor gasoline use per capita with the measure of population density over time, we can see the trends of the transportation energy use. Figure 2.2 shows scattered pattern of the relationship between transportation fuel use per person (*fuelcapita*) and density measures. It shows a negative relationship similar to the figure in Newman and Kenworthy (1989, Fig.1, p. 31), which compares 32 world cities in terms of annual gasoline use per capita and urban density.

In Figure 2.2, population density is used and District of Columbia is dropped out because it is considered as an outlier since it shows the far highest population density (10,447.7 (person / sq. mile)) among states (U.S. average : 363.5). The graph shows a negative correlation between the two variables (-0.509) and that states with low density such as Wyoming and Nevada use more transportation energy per capita than those states with high population density such as Rhode Island or New Jersey. When we trace the relations between the two variables over

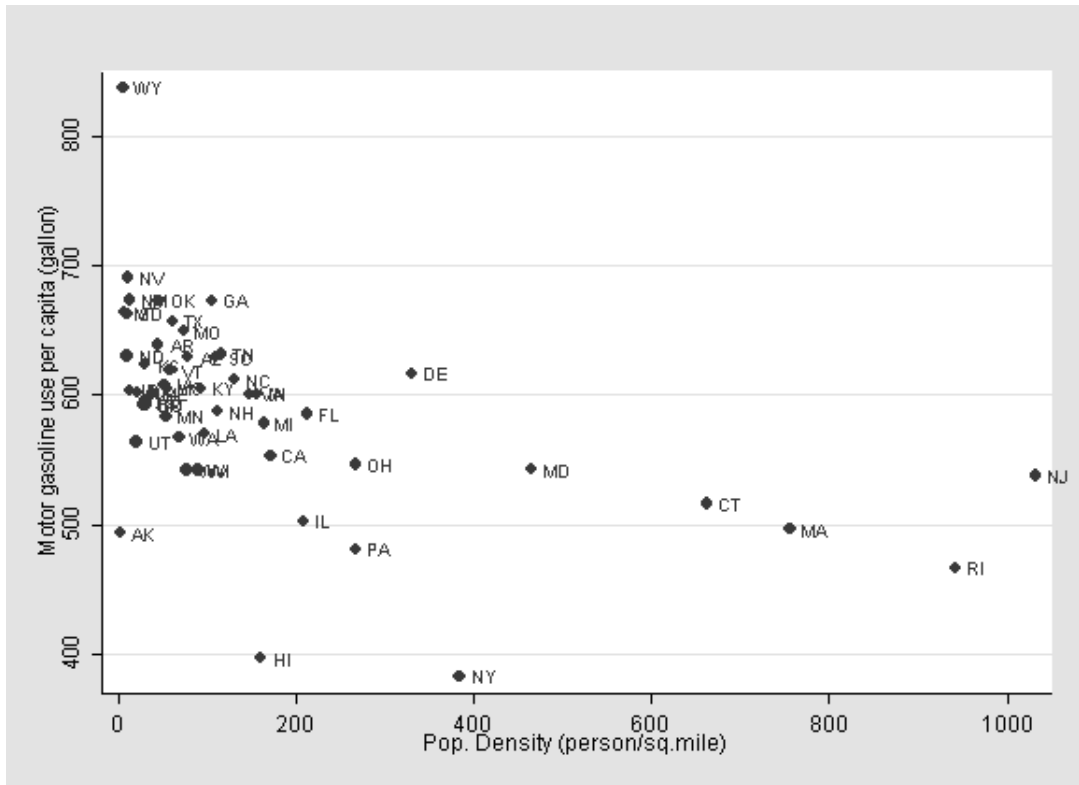

Figure 2.2: Fuel Consumption and Population Density in the U.S.

the period at each state level, most states show positive relations except D.C.¹¹

2) O

Transportation fuel consumption is a function of factors affecting travel demand (i.e., VMT) and fuel efficiency (i.e., MPG). The price of motor gasoline and the amount of personal income will be the primary factors to affect both travel demand and fuel efficiency. We also consider the number of licensed adult population, family size, and the number of vehicles as important factors to affect transportation energy use.

By controlling these factors along with density measure, we can estimate the impacts of population density on transportation energy consumption. We can

¹¹We experimented with alternative measure of density, metropolitan population divided by land area subtracting farm and rural area and it shows more negative correlation between fuel consumption and density than shown in Figure 2.2.

compare the results with the results obtained without controlling those variables, as in Newman and Kenworthy (1989).

2.3.2 M

1) L S M

Equation (2.1) is the basic model specification to estimate the effect of density measures on transportation energy use.

$$(fuelcapita)_{i,t} = \beta_f(fuelcapita)_{i,t-1} + \alpha_0 + \alpha_1(density)_{i,t} + \beta X_{i,t} + u_{i,t} \quad (2.1)$$

where, where, $u_t = \rho u_{t-1} + \epsilon_t$ and β is a vector of coefficients of the control variables in X and subscript i, t denotes state and year, respectively.

As dependent variable, motor gasoline use per capita (*fuelcapita*) measured as gallons of gasoline by state and year in natural logarithm is used. For independent variables, population density (*popden*) in logarithm is used as density variable. A non-linear density variable, *popden*², is allowed. Variables in X , other factors affecting transportation energy use, are used as control variables. It includes the following variables.¹²

- Price of gasoline (*pf*): It is measured by the price of gasoline per gallon in U.S. dollars and is used as a proxy for operating cost of a motor vehicle. It is expected to have a negative impact on energy consumption.
- Personal income per capita (*income*): It is measured as state total personal income (in USD) divided by state total population and normalized by subtracting the mean value in the sample. It is expected to have positive effect on fuel consumption.

¹²Variables starting with lower case are in logarithm and those with upper case are its level value.

- Urbanization ratio (*Urbanization*): It is measured by the ratio of people living in metropolitan area, which is defined by U.S. Census Bureau, to total state population. The more urbanized a state is the less fuel consumption is expected since average travel distance would be decreased as more people live in same size of metropolitan area.
- Road mileage (*roadden*): It is measured by public road mileage divided by the land area of a state. The more road mile is supplied It is likely to lead to an increase in fuel consumption if a state provides more and more road capacity since there will be an increase in travel demand induced by the road capacity expansion. It is rather stable, which varies slowly with population and fuel consumption, than road supply per capita, *roadcapita*, which changes immediately with the change in population by definition.
- Number of vehicles (*vehstock*): It is measured by the sum of private, commercial(including taxis) and publicly owned automobiles and light trucks and is expected to have positive impact on fuel consumption as the number of vehicles increases. We also assume there is no difference in fuel efficiency among vehicle type.¹³
- Share of light trucks (θ): It is measured by the ratio of light trucks, which include pickups, minivans, and SUVs, to the total vehicle stock of cars and light trucks. This variable would explain the impact of light trucks on fuel consumption. Given the difference in fuel economy (i.e., MPG) between cars and light trucks, a state with a higher share of light trucks would consume more fuel. It is available only at national level.
- Licensed adult population (*licadult*): It is measured as the number of licensed

¹³Fuel consumption has direct relationship with VMT but it is also affected by fuel efficiency (MPG). The total fuel consumption, assuming same amount of VMT, will be greater with higher portion of lower fuel efficiency vehicles than with higher portion of more fuel efficient vehicles.

drivers divided by the adult population of age 18 and above. It is expected to have positive impact on fuel consumption since when there are more people with driver's license since there is more possibility of driving more.

- Population ratio to adult population (*popadult*): It is measured by state total population divided by adult population and is used as a proxy of family size. If a family size is bigger, it may imply more vehicles owned by the family and more usage of them causing increases in gasoline consumption. But, in another sense, a large family size may imply less use of gasoline per capita (if the family has zero or one vehicle) since they have to share the vehicle while giving up some trips or using alternative modes. Therefore, the expected sign of the coefficient of *popadult* is not obvious.

Along with these variables, a year dummy variable to capture the effect of gasoline supply shock in 1974 and 1979 (*D7479*) and a time trend measured in years since 1966 (*Trend*=year-1966) are also included in X. We also include one-year lagged value of the dependent variable since including a lagged dependent variable effectively accommodates serial autocorrelation and captures inertial effects. Using the coefficient, β_f , which is the coefficient for the lagged dependent variable, we can also calculate the long-run effects of an independent variable.

Table 2.1 summarizes the descriptive statistics of the variables collected in terms of mean, standard deviation, minimum and maximum value in the samples.

In estimating the model, all income and price variables are deflated to year 2004 prices using national consumer price index. We assume that the error terms have first-degree serial correlation, AR(1). We also try to estimate the model by excluding the observations of D.C. for comparison purpose.

Since we are analyzing a cross-sectional time series data with 51 cross sections and 39 years of time series, we need panel data analytic model specified with either fixed effects or random effects. We consider fixed effects model assuming

Table 2.1: Descriptive Statistics

Variable ¹	unit	Mean ²	Std. Dev.	Minimum	Maximum
<i>FUELCAPITA</i>	gallon/person	460.73	73.40	234.48	822.27
<i>POPDEN</i>	person/sq.mile	364.81	1462.36	0.49	12,967.21
<i>URBANIZATION</i>	ratio	0.71	0.19	0.29	1.00
<i>ROADCAPITA</i>	road mile/person	2.09	2.70	0.01	25.02
<i>PF</i>	\$/gallon	1.79	0.38	1.00	3.24
<i>GASTAX</i>	cents/gallon	43.23	9.26	17.62	70.57
<i>INCOME</i>	\$(in 000)/person	24.834	5.834	10.732	51.155
<i>VEHSTOCK</i>	vehicle	1.00	0.19	0.45	1.73
<i>LICADULT</i>	licensed driver/adult population	0.91	0.08	0.63	1.15
<i>POPADULT</i>	total pop./adult pop.	1.41	0.09	1.23	1.73
<i>Theta</i>	Light trucks/vehicle stock	0.30	0.12	0.04	0.64
<i>TREND</i>	-	15.00	8.95	0.00	30.00

1. Prices, income, and taxes are converted to 2004 real prices.

2. Mean is based on total observations of 1938 (=51*38).

that there may be state-specific effects. A standard test of panel data analytic model specification is Hausman test by comparing the coefficients from both fixed effects and random effects model. The test rejects the random effects model in favor of the fixed effects model.¹⁴

2) S E M

If there is endogeneity problem in one or some of explanatory variables the estimates from basic model will be biased. Road supply variable, *roadden*,¹⁵ may be endogenous. An increase in travel demand may necessitate an expansion of road capacity and, in turn, an increase in road capacity will induce some additional travel demand that would not be added if new road construction or expansion didn't happen. Therefore, new roadway construction or expansion will result in increase in travel demand (i.e., VMT) and thus there may be an upward bias in the effect of *roadden* on fuel consumption. On the other hand, the

¹⁴The test statistic (chi-square value) for model with population density (*popden*) was 97.45 with degrees of freedom of 10.

¹⁵The effect of another possible road supply variable, road mileage per capita (*roadcapita*), can be calculated by the difference between the two coefficients of *roadden* and *popden* by definition. That is, $roadcapita = roadden - popden$, which are all in their logarithm.

investment decision on road capacity expansion or new road construction is determined to accommodate increasing travel demand.

Considering this endogenous relationship between travel demand and road supply, we specify a simultaneous equations model of travel demand and road supply. The equations need to be estimated using a technique to account for the endogeneity of *roadden*. A common such technique is instrumental variables (IV), which uses as instruments a set of variables that are expected to influence *roadden* but are assumed uncorrelated with the error term. Then we have two simultaneous equations, an equation for fuel consumption as a result of travel demand and one for road supply as following:

$$(fuelcapita)_{i,t} = \beta_f^D (fuelcapita)_{i,t-1} + \alpha_0 + \alpha_1 (density)_{i,t} + \alpha_2 (roadden)_{i,t} + \beta X_{i,t}^1 + u_{i,t} \quad (2.2)$$

$$(roadden)_{i,t} = \beta_f^S (fuelcapita)_{i,t-1} + \gamma_0 + \gamma_1 (density)_{i,t} + \gamma_2 (roadden)_{i,t-1} + \delta X_{i,t}^2 + v_{i,t} \quad (2.3)$$

where, δ is a vector of coefficients of the control variables in X^2 and subscript i, t denotes state and year, respectively. We assume that variables in X^2 are uncorrelated with the error $u_{i,t}$ in (2.2).

In specifying the road supply equation, we consider lagged structures as in Cervero and Hansen (2000) between road supply, *roadden*, and travel demand, *fuelcapita*. We experimented lags of up to three years since road supply decision is reflected from the previous years' travel demand. X^1 contains the same variables specified in LS model LS5 as X . For X^2 , following variables are used:

- Population change (*popchg*): it is measured as the percent change in population from a a year before in logarithm ($\log(pop_t/pop_{t-1})$).
- Federal and State gasoline tax rate (*taxrate*): Most interstate and state highways are funded by Highway Trust Fund (HTF), most of which revenues are from either federal or state gasoline tax. The log of sum of federal and state gasoline tax rate in 2004 price are used to see the effect of

highway funding on road supply.

- Fuel consumption in previous year ($fuelcapita_{t-1}$): fuel consumption data with lag of 1 year were used.

Along with these data, *Trend*, and one-year lagged value of the dependent variable (*roadden*) are considered to explain the inertia of road supply.

In estimating the model, two methods are used: two-stage least squares (2SLS) and three-stage least squares (3SLS). Both models can be used to estimate each equation with endogenous variables while the former assumes no correlation between the error terms in two equations and the latter assume correlation between the error terms. Exogenous variables appeared in both equations are used as instruments.

We estimate the simultaneous equation model with four different specifications according to estimation methods (2SLS vs. 3SLS) and how many lags we use for the dependent variable of fuel consumption variable (1 lag vs. 3 lags). Therefore, we have 4 different combinations of model specifications such as 2SLS estimation model with 1-year lagged dependent variable and 3SLS with 3-year lagged dependent variable. In addition to that, we also estimate the model by excluding the observations of D.C. area.

2.3.3 E R

The estimation results by Least Squares methods are presented in Table 2.2.¹⁶

First, as in many other studies, the results show that transportation fuel consumption decreases as the density of a state increases. But we can see that the impact of density on transportation fuel consumption is overestimated when we

¹⁶The result using alternative measure of population density, metropolitan population density defined in section 2.2.1 (footnote 6), is not shown but it shows mostly same sign with *popden* with a bit larger magnitude.

don't control other factors affecting fuel consumption (Model LS1) just as the critics of Newman and Kenworthy (1989) argued. Concerning the coefficient of ρ , which presents the serial correlation at first-degree, AR(1), since LS1 presents very high coefficient values near to 1 for ρ we may say that the model specification is not adequate because this indicates that too many important explanatory factors remain in the error term. Therefore, we interpret the other results in more detail.

In Model LS1, we estimate the impact of population density while controlling only for fuel price (*pf*), personal income (*income*) and vehicle stock (*vehstock*). It is to serve as a benchmark and to compare with Newman and Kenworthy (1989). We introduce more controlling variables such as *licadult*, *popadult*, *Trend* and dummy variable for 1974 and 1979 (*D7479*) in Model LS2 to Model LS5. We add the variable of urbanization ratio (*Urbanization*) in Model LS4 and Model LS5. We exclude *vehstock* in Model LS4 since it may vary endogenously with fuel consumption. We introduce the share of light trucks in total vehicle stock, θ , in Model LS3 along with *vehstock* and in Model LS5 excluding *vehstock*.

The result of Model LS1 may work as a starting point to analyze the impact of density on fuel consumption. Comparing LS1 with the other models, we see that the impacts are measured much higher if we do not include possible control variables.

Looking at the coefficients of density measure, which is our main interest, we can see that it decreases when we control the other factors but remains statistically significant at 5% level. The model LS4 excluding *vehstock* presents not much different impact of density on fuel consumption than models including the variable (Model LS3 and LS5). It may be because the impact of *vehstock* also reflects the impact of *popadult*. We can see that the coefficients of *popadult* in Model LS2 and LS4 decrease in their magnitude and they are statistically significant at 5% level. It can be interpreted that 10% increase in population

density will cause about 2.0% (Model LS2 and LS4) and 1.7% (Model LS3 and LS5) increase in fuel consumption.

Coefficients of Urbanization in Model LS4 and LS5 are statistically insignificant though they show (expected) negative signs. It can be interpreted that the demand for fuel consumption decreases as more and more people live in urban (metropolitan) area. It may be because the population density variable captures the aspect of less demand for fuel consumption by large number of people in more concentrated metropolitan areas.

The results also present the impacts of other control variables such as fuel price and personal income. The short-run price elasticity of gasoline consumption is estimated as about 0.074 with all the control variables (Model LS5). The short-run elasticity of gasoline use with respect to income is presented as 0.054. In the long run, the price elasticity changes to -0.738 and the income elasticity to 0.536.¹⁷ We can see the impact of income on gasoline use in model LS1 decreases greatly as we control more explanatory variables in models LS2–LS5. It also shows that the number of vehicles has positive and significant impact on gasoline consumption as expected (Model LS3 and LS5). We can also see that fuel consumption increases statistically significantly in model LS2 and LS4 as the number of licensed drivers. As we introduce *vehstock*, the coefficient of vehicle stock becomes insignificant though it presents expected positive sign. The coefficient of the proxy for family size, *popadult*, shows positive impact on fuel consumption at 5% significance level in all model specifications. It means that fuel consumption increase as *popadult*, which is a proxy to a family size, becomes larger, since additional family member in a family may require additional travel to the family.

For a robustness check of the result, we estimated the models by omitting the

¹⁷From equation (1), we can calculate the long-run price elasticity and income elasticity as $\beta_{pf}/(1 - \beta_{fuelcapita,t-1})$ and $\beta_{income}/(1 - \beta_{fuelcapita,t-1})$ respectively, where β_{pf} , β_{income} , and $\beta_{fuelcapita,t-1}$ (assuming $0 < \beta_{fuelcapita,t-1} < 1$) are the coefficient of gasoline price, income, and lagged dependent variable respectively.

observations for D.C. suspecting those observations being outliers in terms of population density as we discussed in Section 2.3.1. The regression results (not shown in the tables) show that the estimated coefficients for population density increase a little in all specifications. For example, it increases to -0.023 (0.0066) in model LS5 with standard error in parenthesis.

We also specify the models LS1 through LS5 by including *popden* squared. Basically *popden*² variable doesn't explain much of the impact of density on fuel consumption. It showed (statistically insignificant and) unstable results in the specification of including D.C. data. It showed expected sign and statistical significance in the specification of excluding D.C. data while the coefficients of *popden* decrease by almost half from the coefficients of the specification with *popden* only. The results of both specifications including or excluding D.C. observations are not much different from each other in terms of magnitude of coefficients and their statistical significance.

These results are consistent with other studies in terms of sign and magnitude. Many studies show that population density has 0.03–0.15 of elasticities and estimate price elasticity around 0.05–0.34 in the short run and 0.23–0.46 in the long run (See Table 2.5). Income elasticity is measured 0.095–0.415 in the short run and 0.44–0.47 in the long run. The results in our model lie in between these range.

Results in Table 2.3 from simultaneous equations model show that the impact of density change is only slightly larger than the estimates in models using Least Squares. The inclusion of the variable, *Urbanization*, does not affect the impact of other variables throughout the simultaneous systems equation model. There is almost no difference in the coefficients of *popden* from either 2SLS or 3SLS. The effect of population density increases but only a little, when we estimate the model with three lags of fuel consumption variable. We can see there is little difference between the results from 2SLS and 3SLS estimation. We can also see

Table 2.2: Least Squares Regression Results

Model Variable	LS1 Coefficient	LS2 Coefficient	LS3 Coefficient	LS4 Coefficient	LS5 Coefficient
Dependent Variable: <i>fuelcapita</i> = log(Motor Fuel Consumption per Capita)					
<i>fuelcapita</i> (-1)	-	0.8990	0.8958	0.9034	0.9001
	-	(0.0121)	(0.0122)	(0.0114)	(0.0116)
<i>popden</i>	-0.4415	-0.0154	-0.0176	-0.0167	-0.0187
	(0.0424)	(0.0065)	(0.0066)	(0.0063)	(0.0064)
Urbanization	-	-	-	-0.0638	-0.0523
	-	-	-	(0.0449)	(0.0453)
<i>pf</i>	-0.0923	-0.0745	-0.0730	-0.0753	-0.0738
	(0.0080)	(0.0045)	(0.0046)	(0.0045)	(0.0046)
income	0.3319	0.0520	0.0544	0.0514	0.0536
	(0.0274)	(0.0135)	(0.0135)	(0.0134)	(0.0134)
vehstock	<i>0.0354</i>	0.0107	0.0097	-	-
	(0.0194)	(0.0103)	(0.0104)	-	-
θ	-	-	<i>0.0536</i>	-	<i>0.0502</i>
	-	-	(0.0274)	-	(0.0276)
licadult	-	0.0346	0.0345	0.0349	0.0350
	-	(0.0131)	(0.0131)	(0.0129)	(0.0129)
popadult	-	0.2038	0.1726	0.1936	0.1651
	-	(0.0355)	(0.0389)	(0.0340)	(0.0374)
Trend	-	-0.0014	-0.0019	-0.0013	-0.0018
	-	(0.0003)	(0.0004)	(0.0003)	(0.0004)
D7479	-	-0.0516	-0.0515	-0.0519	-0.0518
	-	(0.0037)	(0.0037)	(0.0037)	(0.0037)
constant	8.0698	0.6567	0.6898	0.6821	0.7070
	(0.1866)	(0.0814)	(0.0834)	(0.0855)	(0.0867)
ρ	0.8626	-0.1621	-0.1619	-0.1668	-0.1661
	(0.0104)	(0.0255)	(0.0255)	(0.0253)	(0.0253)
No. observations	1938	1887	1887	1887	1887
Adjusted R-squared	0.9573	0.9611	0.9611	0.9611	0.9611
S.E. of regression	0.0341	0.0320	0.0320	0.0320	0.0320
Sum squared resid	2.1894	1.8713	1.8674	1.8703	1.8669
Durbin-Watson stat	1.9948	2.0100	2.0127	2.0113	2.0137

Notes:

1. Bold or italic type indicates the statistical significance at the 5% or 10% level, respectively.
2. Standard errors are shown in parentheses.
3. Estimates of fixed effects coefficients (one for each state except Wyoming) are not shown.
4. Variables starting with lower case are in logarithm and those with upper case are its level value.

that the results of systems of equation are not much different from those results estimated by LS method, which means the simultaneity in the model is not that strong.¹⁸ So we consider the results from the 3SLS estimation with one lag of fuel consumption data as our best estimates. According to the results, a 10% increase in popden will reduce fuel consumption by 0.19% in the short run, which is consistent with other studies.

Table 2.3 also shows that the short-run elasticity of fuel consumption with respect to fuel price is measured as - 0.074 and the elasticity of fuel consumption with respect to income is about 0.054 in 3SLS of Model SEM1lag. In the long run, the price elasticity is -0.716, which is higher than the results from other studies, and income elasticity is 0.52, which lies in similar values of other studies.

The coefficients for *roadcapita* turn out to be insignificant meaning no effect on fuel consumption. Coefficients for Urbanization have been decreased compared to Table 2.3 and become insignificant. *Popadult* has almost the same impact as in Least Squares estimates in model LS5. The dummy variable for year 1974 and 1979 shows a lower usage of gasoline of about 5% in those years, other things being equal. We also see strong inertia in fuel consumption indicated by the coefficient of *fuelcapita_{t-1}*. It tells us how much the short run effect will be magnified. An increase in income, for example, would cause more than 8 times, by a factor of $1/(1-0.88)= 8.3$, of short run effect in the long run.

Table 2.4 reports the other equation in the simultaneous equation model. It tells us the factors affecting road supply in terms of public road mileage in an area. As expected, previous year's road supply produces an the inertial effect on current road mileage. It also shows that an increase in transportation demand (i.e., fuel consumption) in past years would cause increase in road supply. A 10% increase

¹⁸If there exists simultaneity, the first stage residuals should be significantly different from zero. The result of Hausman test, which is the most common test for simultaneity, shows that the t-statistic on the residual's coefficient is 1.0402 and thus there exists simultaneity.

Table 2.3: Fuel Consumption Equation Estimation Results

Model	SEM1lag		SEM3lags	
	2SLS	3SLS	2SLS	3SLS
Variable	Coefficient	Coefficient	Coefficient	Coefficient
Dependent Variable: <i>fuelcapita</i> =log(Motor Fuel Consumption per Capita)				
<i>fuelcapita</i> (-1)	0.8976 (0.0119)	0.8974 (0.0117)	0.8814 (0.0138)	0.8811 (0.0135)
Roadcapita	0.0087 (0.0100)	0.0089 (0.0098)	0.0063 (0.0106)	0.0065 (0.0105)
<i>popden</i>	-0.0189 (0.0064)	-0.0190 (0.0063)	-0.0205 (0.0072)	-0.0206 (0.0071)
Urbanpop	-0.0446 (0.0464)	-0.0407 (0.0457)	-0.0524 (0.0510)	-0.0496 (0.0501)
pf	-0.0736 (0.0046)	-0.0735 (0.0045)	-0.0732 (0.0047)	-0.0731 (0.0046)
income	0.0540 (0.0134)	0.0536 (0.0132)	0.0584 (0.0140)	0.0580 (0.0137)
vehstock	- -	- -	- -	- -
θ	0.0526 (0.0278)	0.0543 (0.0273)	0.0553 (0.0296)	0.0574 (0.0291)
licadult	0.0330 (0.0131)	0.0327 (0.0129)	0.0355 (0.0141)	0.0350 (0.0139)
popadult	0.1622 (0.0376)	0.1596 (0.0369)	0.1818 (0.0397)	0.1789 (0.0390)
D7479	-0.0516 (0.0037)	-0.0515 (0.0037)	-0.0506 (0.0038)	-0.0506 (0.0037)
Trend	-0.0019 (0.0004)	-0.0019 (0.0004)	-0.0019 (0.0004)	-0.0019 (0.0004)
constant	0.6668 (0.0847)	0.6681 (0.0833)	0.7653 (0.0954)	0.7673 (0.0938)
ρ	-0.1647 (0.0255)	-0.1638 (0.0250)	-0.1629 (0.0266)	-0.1616 (0.0261)
No. observations	1887	1887	1887	1887
Adjusted R-squared	0.9611	0.9611	0.9588	0.9588
S.E. of regression	0.0320	0.0320	0.0324	0.0324
Sum squared resid	1.8655	1.8655	1.8054	1.8054
Durbin-Watson stat	2.0129	2.0145	2.0071	2.0093

Notes:

1. Bold or italic type indicates the statistical significance at the 5% or 10% level, respectively.
2. Standard errors are shown in parentheses.
3. Estimates of fixed effects coefficients (one for each state except Wyoming) are not shown.
4. Variables in lower case are in logarithm and those with upper case are its level value.

in fuel consumption in a year ago would lead to about 0.3% increase in road supply. It also shows that population density has negative impact on road supply. It means the more people are concentrated in an area the less road supply is needed since average travel distance would decrease and people may use alternative transportation mode (e.g., public transit or walk). It turns out that the impact of federal and state gasoline tax rate on road supply is insignificant with unexpected sign.

We can decompose the effect of population density on fuel consumption into direct effect and indirect effect. Direct effect is estimated in Table 2.3 (-0.019) and indirect effect can be calculated by multiplying the effect of road supply on gasoline consumption (.0089) and that of population density on road supply (-.0013), which is about 0.0001. Combining the direct and the indirect effect, we get -0.0191, which still shows consistency with other studies. Essentially, only the direct effect matters.

Table 2.5 compares the estimated elasticities of fuel consumption with respect to density, price of gasoline, and income from previous studies. The elasticity of gasoline consumption with respect to population density, *popden*, from the study is -0.019, which is smaller than other studies (many of other studies use VMT as their dependent variable). The elasticity with respect to gasoline price is -0.074 in the short-run and also lies between -0.052 and -0.179, the values from previous studies. In the long run, the price elasticity increases to -0.716 and is much larger than the results of Haughton and Sarka (1996) and Small and Van Dender (2007). Regarding income elasticity, it is estimated as 0.054 in the short-run, which is lower than those from other studies. The long-run income elasticity is measured as 0.523 and is quite consistent with the results of other studies. Overall, the elasticities in the short run in this study are smaller than other studies, and somewhat larger in the long run.

Table 2.4: Road Supply Growth Equation Regression Results

Model	SEM1lag		SEM3lags	
	2SLS	3SLS	2SLS	3SLS
Variable	Coefficient	Coefficient	Coefficient	Coefficient
Dependent Variable: <i>roadcapita</i> = log(Road Mileage per Capita)				
<i>roadcapita</i> (-1)	0.8656 (0.0117)	0.8654 (0.0115)	0.9034 (0.0120)	0.9033 (0.0118)
<i>fuelcapita</i> (-1)	<i>0.0317</i> (0.0104)	<i>0.0317</i> (0.0102)	<i>0.0235</i> (0.0181)	<i>0.0226</i> (0.0178)
<i>fuelcapita</i> (-2)	-	-	<i>-0.0395</i> (0.0227)	<i>-0.0370</i> (0.0223)
<i>fuelcapita</i> (-3)	-	-	0.0418 (0.0186)	0.0404 (0.0182)
<i>popchg</i>	0.1254 (0.1014)	0.1231 (0.0999)	0.1363 (0.0991)	0.1318 (0.0975)
<i>popden</i>	-0.0130 (0.0074)	-0.0130 (0.0073)	-0.0130 (0.0078)	-0.0130 (0.0077)
Trend	0.0004 (0.0001)	0.0004 (0.0001)	0.0003 (0.0001)	0.0003 (0.0001)
constant	-0.3450 (0.0728)	-0.3454 (0.0718)	-0.2651 (0.1030)	-0.2677 (0.1013)
ρ	0.0792 (0.0265)	0.0800 (0.0261)	0.1106 (0.0274)	0.1116 (0.0269)
No. observations	1887	1887	1887	1887
Adjusted R-squared	0.9990	0.9990	0.9991	0.9991
S.E. of regression	0.0301	0.0301	0.0275	0.0275
Sum squared resid	1.6612	1.6612	1.3085	1.3085
Durbin-Watson stat	1.7806	1.7820	2.0581	2.0601

Notes:

1. Bold or italic type indicates the statistical significance at the 5% or 10% level, respectively.
2. Standard errors are shown in parentheses.
3. Estimates of fixed effects coefficients (one for each state except Wyoming) are not shown.
4. Variables in lower case are in logarithm and those with upper case are its level value.

Table 2.5: Summary of Results

Source	Dependent Variable	Period	Estimated Elasticity with respect to:		
			<i>density</i>	<i>gas. price</i>	<i>income</i>
Greene (1979)	Gas. consumption per HH	1966-1975	-0.031 ^{SR}	-0.34 ^{SR}	0.357 ^{SR}
Lin et al.(1985)	Gas. consumption per HH	1966-1980	-0.152 ^{SR}	-0.149 ^{SR}	0.415 ^{SR}
Gately (1990)	U.S. annual VMT	1966-1988	-	-0.09 ^{SR}	0.52 ^{SR} a
Haughton & Sarkar (1996)	VMT per driver	1970-1991	-0.063 ^{SR} b	-0.156 ^{SR}	0.306 ^{SR}
			-0.091 ^{LR}	-0.226 ^{LR}	0.442 ^{LR}
Cervero & Hansen (2002)	Countywide annual VMT	1976-1997	-0.079 ^{SR}	-0.179 ^{SR}	0.294 ^{SR}
Small & Van Dender (2004)	VMT per adult population	1966-2001	-	-0.104 ^{SR}	0.095 ^{SR}
			-	-0.46 ^{LR}	0.477 ^{LR}
<i>This study (Model SEM1lag: 3SLS)</i>	Gas. use per capita	1966-2001	-0.017 ^{SR}	-0.102 ^{SR}	0.051 ^{SR}
			-0.142 ^{LR}	-0.873 ^{LR}	0.440 ^{LR}

Note: HH (Household); SR (Short-run); LR (Long-run).

a. Elasticity with respect to GNP

b. It was reported as -0.642 in the report but it seems to be mistakenly changed with the coefficient of the variable, "drivers as proportion of adult population," of which coefficient is reported as -0.063 (Table 1, p. 115)

2.4 C

This study explored the relationship between state level density and motor gasoline consumption using panel data over the period of 1966-2001. The estimation of the impact of population density on transportation fuel consumption was done using LS estimation and using simultaneous equations methods considering the endogeneity of travel demand and road supply. The estimated results confirm that the higher the density becomes the less fuel is consumed, which is consistent with theory and previous studies.

The elasticity of fuel consumption with respect to population density measure, *popden*, is estimated as -0.019 at 5% statistical significance level with controlling other many factors such as fuel price, income, urbanization etc., which might affect fuel consumption. The elasticities of fuel consumption with respect to gasoline price and income variable are -0.074 and 0.054 respectively in the short run. The price elasticity is in the range of the results from other studies while income elasticity turns out to be a little lower than the results in previous studies.

The results of this study can be explained further using more detailed data on travel behavior of people such as modal share, travel time and speed. With those data it may be able to compare the impact of density on fuel consumption at city level or at state level. Since population density measure at state level may not capture the aspect of suburbanization, a model with the density variable which incorporates suburbanization aspect might work to explain the current urban form of coexisting concentration of people into urban areas and dispersion of activities within urban areas as mentioned in Anderson *et al.* (1996). Regarding policy suggestions for conservation of transportation energy, it may be approached in two ways: one is the effects of spatial structure change and the other is the effects of changes in economic factors. In terms of spatial structure, it is being discussed that sustainable spatial structural development to reduce

energy dependency considering the relationship between land use and transportation. Since population (employment) distribution and city size are strongly correlated with transportation energy consumption or travel pattern, it would be good to discuss the impact of decentralized population (employment) distribution on travel demand and fuel consumption at metropolitan city level.

We know that economic factors such as price and income have much greater impact on fuel consumption than density impact shown in this study and other previous studies. It may explain the reason that economic policy options are preferred to land use policy options to tackle energy conservation issue. A suggestion from this study is to examine the impacts of economic policy options such as change in gas price. In examining the impact of economic factors one should also consider the relationship between density and congestion since concentration of population and function around major urban areas is now one of the main reasons for increasing traffic congestion and thus fuel consumption of the country.

C 3

T I T
E C S
F C E

3.1 I

One of the most distinct trends in the U.S. transportation sector for the past three decades is the shift in vehicle stock composition toward light trucks. Light trucks, which include pickups, vans, and sport utility vehicles (SUVs), increased their share of the new light duty vehicle (LDV) market from 20.9% in 1975 to 54.7% in 2005 (Ward's Communications, 2006). The growth in the share of light trucks is partly a result of lower fuel prices and higher income levels. The continuing increases in demand for and use of light trucks, which have lower fuel economy than cars in average, have offset the improvements in fuel economy due to enhanced motor vehicle engine technology and have resulted in the higher rate of increase in petroleum consumption in the transportation sector than any other sector.

The transportation sector is responsible for a large portion of energy consumption in the U.S. and the highway sector is the largest part of transportation fuel consumption. According to the U.S. Department of Energy (DOE), the transportation sector's share of U.S. total energy consumption in 2005 was 28.0%, with an average annual percentage growth rate of 1.3% over the period 1973-2005 (U.S. DOE 2006). Light truck energy use has increased at an annual average rate of 4.9% over the period 1970-2005, while overall highway

transportation energy use has increased by 1.8% (U.S. DOE (2006), Table 2.7). The actual corporate average fuel economy (CAFE) of light trucks was 22.0 miles per gallon (MPG) in 2005, with 20.9% up from 18.2 (MPG) in 1979 (average annual growth rate: 3.4%). Over the same period, corporate average fuel economy of cars increased by 4.1% annually on average (U.S. DOE (2006), Table 4.17 and 4.18).

We narrow our focus regarding transportation energy on highway use of gasoline by light duty vehicles (i.e, cars and light trucks) since gasoline use explains more than 60% of all transportation energy sources and highway gasoline makes up more than 95% of total gasoline consumption in the U.S. Motor vehicles contribute to air pollution and global warming, both of which are subject to extensive policy concern in the country. Thus, reducing transportation fuel consumption would not only enhance the country's energy dependency but also help to reduce greenhouse gas emissions, improve air quality, and reduce other driving-related external costs. Therefore, a comprehensive review of transportation energy policy options to reduce transportation fuel consumption is needed.

Regarding policy suggestions for conservation of transportation energy, it may be approached in two ways: one is through urban planning by changing urban spatial structure considering the relationship between land use and transportation; the other is through economic policy. Economic policy can be defined as a policy which cause changes in traveler's monetary costs through changes in price. Many policy options can be considered including a gasoline tax policy and corporate average fuel economy (CAFE) regulation, and those policies would lead to reduction in VMT and to changes in vehicle stock composition through changes in consumers' preference of vehicle choice.

This chapter examines the effects of different economic policy instruments to conserve transportation energy taking into account both direct and indirect effects

through policy simulation model. The impacts will be measured in terms of vehicle miles, fuel consumption, greenhouse gas emissions, and cost savings with various changes in policy scenarios. Here we are primarily concerned with the following economic policy alternatives: (1) raising the existing fuel tax (*Fuel Tax*); (2) instituting a tax on vehicle miles traveled (*VMT Tax*); (3) converting insurance payments to per-gallon basis (pay-at-the-pump, or *PATP*); (4) converting insurance payments to a per-mile basis (pay-as-you-drive, or *PAYD*); (5) regulating stronger corporate average fuel economy (*CAFE*) standards.

In measuring policy impacts, this research is based on an analysis framework by Small and Van Dender (2007) to identify the ways that behavioral reactions modify policy outcomes. The model fully integrates three inter-related economic demand decisions: size of vehicle stock, use of the vehicle stock, and energy efficiency. Therefore, we pay attention not only to direct impacts on travel demand (i.e., VMT and fuel consumption) but also to indirect (external) impacts on environment (e.g., greenhouse gas emissions), which are often not taken into account and may modify policy outcomes by travelers' behavioral reactions through the changes in other decision making factors.

This research contributes to literature in following ways. First, I develop a policy simulation model capable of assessing the impacts of policies by adding details necessary to account for features of the policies being examined to the econometric model in Small and Van Dender (2007). Second, the simulation model can be used and adapted for the analysis of each state level or of the entire United States level. Thus, it would provide a tool for potential use in analyzing regional policies, or federal policies. Third, the data set from 1966 to 2004, which is cross-sectional time series data at the U.S. State level, is longer than other studies and it is constructed in such ways of being easy to use in simulation, and also to update in the future.

3.2 P S

There are many studies about the impacts of various policy options on fuel consumption, VMT, and greenhouse gas (GHG) emissions. In this section, I review the literature on the policy strategies to conserve transportation energy and refine the description of them.

3.2.1 S P P

Regarding pricing policies, many studies mostly focus on the impact of fuel tax increase on travel demand and fuel consumption. The U.S. Environmental Protection Agency (1998) explores how to quantify the impacts of “market-based” pricing measures, for example, fuel taxes, VMT fees, and emission fees on VMT, trips, and transportation emissions. Their travel demand analysis is basically based on the general “four step process” simulations considering land use/activity allocations and vehicle ownership and emissions are calculated as an end product of the process. But the study lacks an analysis of the effect of fuel economy change. According to the study, though the study does not advocate any specific policy, an increase in gasoline tax by \$.50 per gallon (42% increase from the base case price) reduces VMT up to 2.8% and CO₂ up to 7.4% while a VMT fee of \$.02 per mile reduces VMT up to 5.6% and CO₂ up to 5.7% from the base case.

Parry and Small (2005) analyze the second-best optimal gasoline tax level in the US and in the UK taking into account the externalities of air pollution, congestion, and traffic accident using household utility function. They find that optimal gasoline tax (\$1.01/gal for US and \$1.34/gal for UK) is higher than current tax level in the US while it is lower than the current level in the UK. They also find that changing per-gallon fuel tax scheme to per-mile VMT tax, which is \$.0225/mile for equal tax revenue as fuel tax and is \$.14/mile for optimized VMT

tax, would increase welfare gain with a greater impact on reducing externalities than the fuel tax.

Parry (2006) compares the costs and benefits of four policies to reduce greenhouse gas emissions by 10%: emissions taxes, emission permits, fuel economy standards, and mileage taxes. He estimates marginal and total cost for reducing vehicle emissions and measures the (marginal) welfare costs of each policy considering interactions with labor tax distortions. He shows that a tax-based approach (i.e. gas tax policy) to reduce emissions produce large net benefits than fuel economy regulation when considering the externalities.

Austin and Dinan (2005) estimate annual cost of reducing gasoline consumption over 14 years considering vehicle replacements through simulation model. They find that gasoline tax would produce greater cost savings by encouraging people to drive less and to choose more fuel efficient vehicles. According to their study, by increasing CAFE standards for both car and light truck by 3.8 mpg, the government would achieve 10% reduction in fuel consumption. The same amount of fuel consumption reduction would be achieved by increasing 30 cents per gallon of fuel tax with less welfare costs.

A policy change may have different impacts on people with different income. Fullerton and West (2003, ch.7) and Bento *et al.* (2005) explore the distributional impact of gasoline tax changes. Fullerton and West study incentive programs such as permits, taxes, or subsidies to achieve air quality standards. They compare the simulation results from various gasoline tax options and also analyze the distributional impacts of those taxes in California. They find that a single rate of tax on emissions is most efficient and that a tax on gasoline is not regressive across the lowest incomes but is regressive from middle to high incomes. Bento *et al.* (2005) study the impacts of the gasoline tax on fuel consumption considering households' vehicle choice. They also examine the distributional impact of

gasoline tax considering tax revenue-recycling. They find that gasoline tax increase induces a reduction in fleet size, a decline in new car demand, and a relative increase in demand for more fuel-efficient cars. Regarding distributional impact, they find that income-based recycling is relatively beneficial to households.

There are several studies examining per-gallon (i.e., *PATP*) or per-mile insurance premium (i.e., *PAYD*) policy. Khazzoom (1998) discusses *PATP* proposal to replace the current insurance system of lump sum payments for automobile insurance. He argues *PATP*, by converting the insurance premium from a fixed to a variable cost through price signal, improves economic efficiency and decreases insurance costs because of the reduction in VMT. But the study does not provide any numerical results of policy impacts.

Regarding *PAYD* policy instrument, Parry (2005) shows that *PAYD* reduces mileage-related externalities more than fuel taxes for a given reduction in fuel demand. Social welfare gains of fully implemented *PAYD* is \$19.3 billion while fuel tax increase would gain \$6.2 for a given reduction of fuel demand of 11.4 billion gallons. He also shows that *PAYD* is slightly more efficient than VMT tax policy for a given fuel reduction. He estimates 9.1 % reductions in gasoline demand and higher welfare gains than fuel taxes (\$8.12 billion vs. \$3.5 billion).

Edlin (2003) also analyzes the impact of per-mile premium for auto insurance by an analytical model of accidents costs and congestion using state level data. Based on his simulation model, he finds different per-mile premium from state to state: for example, \$.018/mile for Wyoming and \$.079 for Hawaii, which leads to an average of 10% reduction in total vehicle mileage and to \$18.2 billion of total U.S. benefits (\$12.7 billion (in 1995 dollars) of net accident savings and \$5.5 billion of reduced delay costs).

3.2.2 S R P

CAFE standard and its impacts on travel demand and fuel consumption have been an interest in many studies. National Research Council (NRC, 2002) assess the impact of the CAFE system on reductions in fuel consumption, on emissions of greenhouse gases, on safety and on impacts on the automotive industry. By changing CAFE standards 15%, 25%, 35%, and 45% considering different vehicle sizes, they find CAFE standards need to be increased by 12 percent for small cars and by up to 42 percent for light trucks for the policy to be cost-efficient.

Parry *et al.* (2004) examine the implications of changes in the US nationwide corporate average fuel economy (CAFE) regulations. They find that welfare gains from CAFE standards change on new vehicles depends on how consumers value fuel economy technologies and their opportunity costs.

The National Commission on Energy Policy (NECP, 2004) examine a revenue-neutral package of measures designed to ensure affordable and reliable supplies of energy and recommends several policy options including fuel efficiency standards and incentives for developing energy technology at national level and for all energy sources. The results, based on National Energy Modeling System (NEMS) analysis, show that improving fleet-wide passenger vehicle (i.e., car and light truck) fuel-economy standards by 10, 15, and 20 mpg by 2015 would reduce fuel consumption 10 to 15 percent by 2025. Regarding CAFE standards, the commission suggests an increase in CAFE standards for new cars and light trucks.

Small and Van Dender (2007) measure the rebound effect of fuel economy standards and evaluate their effects on VMT taking into account changes in vehicle stock and fuel efficiency. The rebound effect from their estimation for the U.S. as a whole, over the period 1966-2001, is 5.3% for the short run and 26% for the long run. They also find that the rebound effect reduces as income increases. They use aggregate cross sectional time series data to estimation for the US as a

whole, but they also provide an example simulation specifically for California.

3.2.3 C A P I

Austin and Dinan (2005)¹ consider fuel economy standards, fuel tax, and direct limits on greenhouse gas emissions, taking the rebound effect into account in a relatively simple way. They also examine the external effects on safety, congestion, though it does not include any feedback of these effects on VMT. Fuel tax increases are one of the most efficient and effective ways to encourage energy conservation. They compare the costs of different policy options and estimates \$3.0 ~ 3.6 billion of welfare costs, slightly higher than the cost of increasing fuel tax.

To narrow the geographical scope, the California Energy Commission and California Air Resources Board (CEC & CARB, 2002) consider how to reduce the state's petroleum dependency. Policy options in their study are categorized as fuel efficiency, alternative fuel substitution, pricing, and others. Their simulations are mostly based on the CALCARS model, a microsimulation model relying on household surveys originally carried out in the early 1990s.

3.2.4 P P I

Mileage Based Tax. Oregon State is testing a new system, "Road User Fee", that could replace the gas tax (Whitty *et al.*, 2006). The main purpose of the new system is to develop a revenue collection design that ensures a flow of revenue sufficient to Oregon's state, county and city highway and road system. A secondary purpose of the study is to evaluate a congestion pricing system in which motorists are charged extra for traveling during peak traffic hours.

A mileage fee is set per mile driven within the state. Fees are collected at the service station, where transmitting devices wirelessly retrieve data from the

¹The results of the Congressional Budget Office (CBO, 2002) are based on their study.

on-board counting devices. Drivers are not charged a mileage fee for travel outside the state.

Insurance Premium based on vehicle usage. Generally, either *PATP* or *PAYD* insurance premium, pay for only the liability component among the three kinds of insurance: liability, collision, and comprehensive. Under current insurance program, the amount of liability premium is mostly determined by factors such as driver's age, gender and driving record, how many miles the car is driven.

Under *PATP* auto insurance charge, a driver, who pays the same premium (\$1,250) and drives same mileage (12,500 miles) with fuel economy of 25 MPG, purchase the fuel by adding \$2.50 per gallon to the cost of gasoline. Under *PAYD* insurance charge, for example, a driver, who would pay a \$1,250 annual premium for liability, pays 10 cents per mile assuming 12,500 annual vehicle miles.

New Fuel Economy Standards. Recently, NHTSA proposed a reform of the structure of CAFE standards for light trucks of model year 2008-2011 (NHTSA, 2006). Under the Reformed CAFE system, each light truck manufacturer's required level of CAFE is based on target levels set according to vehicle size, which is determined by vehicle's "footprint".² In Model Year (MY) 2011, all manufacturers will be required to comply with a Reformed CAFE standard. The agency also assesses 10.7 billions of gallons of fuel savings from the new fuel economy standards for light trucks.³

²"footprint" is defined as the product of the average track width (the distance between the centerline of the tires) times the wheelbase (the distance between the centers of the axles)

³NHTSA (2006), Final Regulatory Impact Analysis, available at <http://www.nhtsa.dot.gov/>.

3.3 D P I

3.3.1 D I P C

The primary goal of the policies considered here is to reduce transportation energy consumption and the policy instruments will decrease the fuel consumption by way of travelers' behavioral changes. When a policy is newly implemented, they may reduce unnecessary trips and thus decrease vehicle use and travel distance. They may even change mode to a less expensive ones or to a more fuel efficient mode. These behavioral changes would affect not only fuel consumption but also other transportation externalities such as greenhouse gas emissions, traffic safety, and congestion.

Changes in travel demand in terms of VMT will directly reduce the amount of fuel consumption and it, in turn, may cause a proportional reduction in greenhouse gas emissions since most emissions decline in proportional to mileage and fuel consumption. If the decrease in travel demand happens in short distance trips, by way of mode change to walk or non-motorized vehicles, the decrease in vehicle miles may reduce pollution emissions relatively large.

Each policy will result in some savings from reduction in fuel consumption but implementing a new policy may also require some additional costs. Therefore, for an energy conservation strategy to be meaningful to society, the benefits from the policy should outweigh the expected costs of implementation.

Let's take an example of increasing fuel tax, which increases the fuel price as a result. Increasing fuel price has two effects on consumer's travel decision. It will not only modestly decrease in vehicle mileage directly but also will also cause consumers to choose more fuel-efficient vehicles. As discussed in many studies, improved fuel efficiency would reduce per mile cost of driving and thus would increase VMT. Considering the proportionality between VMT and fuel

consumption for fixed fuel efficiency, the final changes in fuel consumption would be the sum of the direct decrease in fuel consumption from mileage decrease due to price increase and the indirect VMT increases caused by the rebound effect.

Increasing fuel price also has an impact on transportation emissions of CO₂, which is mostly proportional to the amount of fuel consumed or to vehicle miles. The impact of fuel price change on emissions would be less than expectation considering the indirect effect of increased vehicle mileage and fuel consumption due to fuel efficiency change.

A policy change would also have an impact on traffic safety. The safety issue comes from the change in vehicle fleet composition caused by consumer's preference change in favor of fuel efficient vehicles, which tend to be lighter in weight and smaller in size, after the policy implementation. The changed vehicle fleet mix would affect traffic fatalities or injuries since passengers in heavier and larger vehicle are known to be safer than those in lighter and smaller vehicles when the two-vehicles are in crashes against each other. (See, for example, Brozović and Ando, 2005.) The impact of a policy change on safety impact will be discussed more in detail in Chapter 4.

Unlike fuel tax, VMT tax based on the mileage driven may directly change the per-mile driving costs and it affects all travelers regardless of the fuel economy of their vehicles. It may work as an incentive to reduce travel miles and thus would decrease fuel consumption. Taking account of vehicle price assuming that fuel efficient vehicles are generally more expensive than less fuel efficient vehicles of same size, VMT taxes would cause higher increase in costs of vehicle purchase and driving for the users of fuel efficient vehicles than relatively inefficient vehicle users.

Figure 3.1 shows the relationship among results from a change in policy instrument.

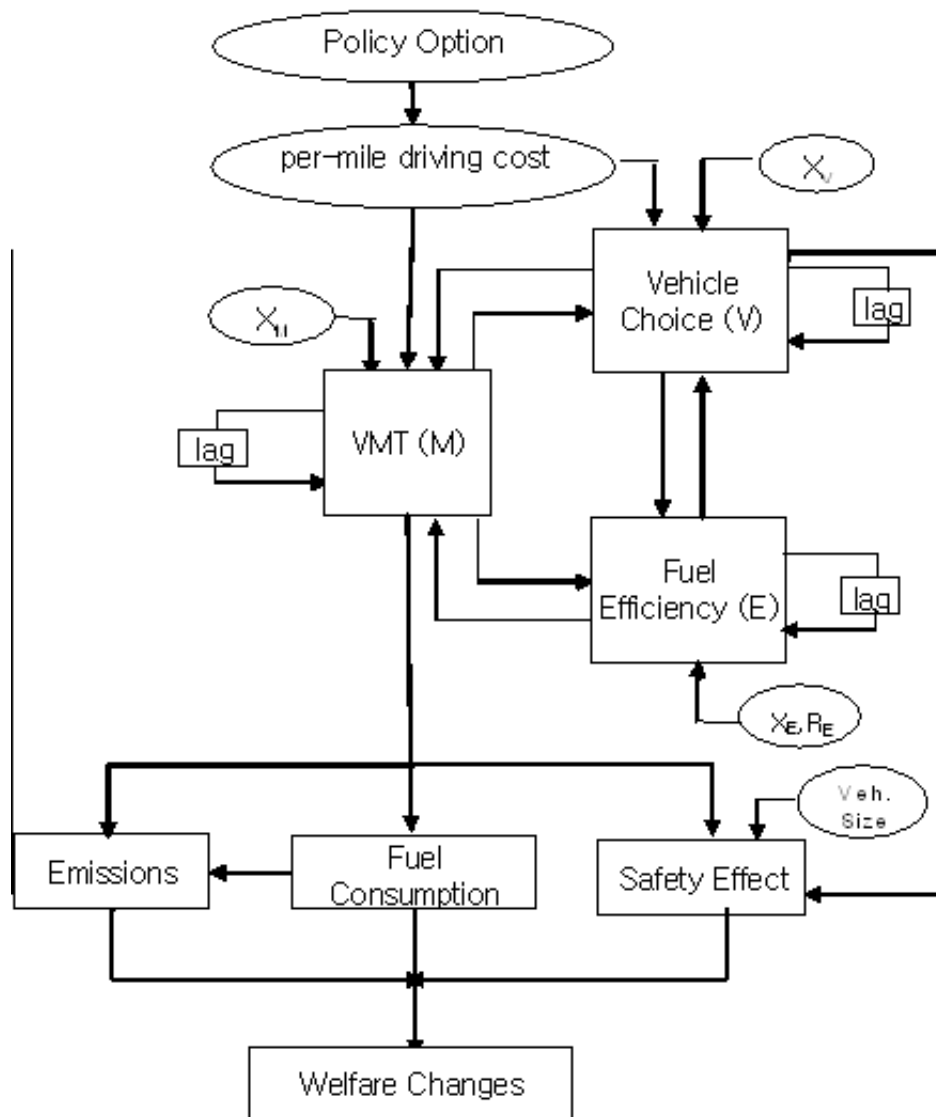

Figure 3.1: Framework of the Study

Table 3.1 summarizes the impacts of policy instruments on per-mile vehicle driving cost, VMT, vehicle choice, fuel consumption etc.

Table 3.1: Expected Impacts of Policy Options

Policy Option	Per-mile Vehicle Cost	Fuel Efficient Vehicle Choice	VMT	Fuel Consumption	Greenhouse Gas Emissions
Fuel Tax	+	+	-	-	-
VMT Tax	+	?	-	-	-
PAYD Insurance	+	?	-	-	-
PATP Insurance	+	+	-	-	-
CAFE Standards	-	+	+	-	-

3.3.2 C P I

The proposed policy options, except CAFE standard regulation, may reduce VMT (and fuel consumption) due to an increase of per mile cost of driving. While most policy strategies mainly aim to reduce total vehicle mileage and thus to reduce fuel consumption, those strategies also have other indirect impacts on congestion, safety, vehicle choice, vehicle emissions etc. and some indirect effects are difficult to quantify.

We assume that all the policy instruments are technically feasible and ready to be implemented.

1) F

It raises cost of per-mile vehicle travel and affects vehicle usage and VMT. This policy is technologically easy to implement and the administrative costs are likely to be less than the costs for administering and implementing other policies.

2) VMT

This policy does not directly affect fuel efficiency; therefore travel and fuel change approximately in the same proportions as the tax rate is varied. Oregon state is

considering to convert fuel tax policy from gas tax per gallon to mileage tax to secure fund for road investment. But the owners of hybrid vehicles, which are more fuel efficient than other cars, would hurt by the policy.

3) P -A -T -P (PATP) I L P C

PATP policy adds insurance surcharge per gallon of gasoline. The surcharge may be calculated to be equal to the current average cost of insurance. This policy may raise the per gallon cost of gasoline and, therefore, would encourage less use of vehicle. Assuming the probability of crash is proportionate to VMT for an individual, this policy would also decrease crash rate (i.e. number of crashes divided by total VMT). This policy would also contribute to eliminating uninsured motorist problem.

Decreased travel demand from the strategies, especially PAYD or PATP strategies, may also have impact on safety and reduce social external costs by way of reducing uninsured motorists and reducing traffic crash risk.

4) P -A -Y -D (PAYD) I L P C

It is a simple and effective way to make distance-based vehicle insurance. The premium rates are calculated to proportional to mileage, incorporating all existing rating factors. It may provide more accurate insurance pricing, increased insurance affordability, and reductions in traffic congestion, road and parking facility costs and pollution.

5) C A F E (CAFE) S R

Corporate Average Fuel Efficiency (CAFE) standards require auto makers to produce vehicles which meet the fuel economy standard set by the government. It

directly affects the costs of vehicle makers and thus auto companies are against this policy.

3.4 A M

3.4.1 V , ,

The proposed policy options, except CAFE standard regulation, may reduce VMT (and fuel consumption) due to an increase of per mile cost of driving. While most policy strategies mainly aim to reduce total vehicle mileage and thus to reduce fuel consumption, those strategies also have other indirect impacts on congestion, safety, vehicle choice, vehicle emissions etc. and some indirect effects are difficult to quantify.

We define VMT as a function of the per-mile cost of driving, vehicle ownership, and other exogenous characteristics. Likewise, consumers choose how many vehicles to own based on vehicle purchase and operating price, how much they intend to drive, and other characteristics. The fuel efficiency choice is determined jointly by consumers and manufacturers taking into account the price of fuel, how much they intend to drive, the regulatory environment, and other characteristics. So we consider simultaneity in vehicle usage (i.e. vehicle miles, M) and vehicle stock (V) and fuel intensity (E) as specified in Small and Van Dender (2007). Total fuel consumption, F , (in gallons per year) is defined by the identity $F = M/E$.

These definitions can be shown as following equations:

$$\begin{aligned}
 M &= M(P_m, V, X_M), \\
 V &= V(P_v, M, P_m, X_V), \\
 E &= E(P_f, M, R_E, X_E).
 \end{aligned}
 \tag{3.1}$$

where M is aggregate VMT; V is the size of the vehicle stock; P_v is a price index for the ownership cost of new vehicles; X_M , X_V and X_E are exogenous variables affecting M , V and E , respectively; and R_E represents one or more regulatory variables.

In estimating the system (3.1) econometrically, we include a one-year lagged value of dependent variable of each equation and we also include some variables in X_M that are interactions of per-mile cost of driving, P_m , with income, urbanization, and P_m itself. We normalize the interaction variables by subtracting their mean value over the sample period (1966–2004). We assume that the error terms in the equations show first-degree serial correlation.

We estimate the system equations by three-stage least squares (3SLS) as explained in Small and Van Dender (2007). In the first stage, we estimate an ordinary least squares (OLS) regression of each variable in the model on the set of instruments. In the second stage, we estimate the original equation while replacing the endogenous variables on its right-hand side by their predicted values from the first stage. In the third stage, we estimate correlations in the error terms in the two equations. The entire system is re-estimated taking these correlations into account. The estimates of this procedure will be used as parameter values in policy simulation model.⁴

We assume there is no maintenance cost and the total cost of driving is the sum of fuel cost and lump-sum auto insurance cost (I). We define fuel price per gallon (P_f) as the producer price (P_0) plus state and federal fuel taxes (t_f). If we define i_f as per-gallon auto insurance premium, which can be calculated by dividing the lump-sum insurance premium by total fuel consumption ($i_f = I/F$), the total per-gallon driving cost (P_g) is the sum of per-gallon fuel cost (P_f) and per-gallon auto insurance premium (i_f).

⁴See Appendix for the independent variables in the equations and the estimation results.

$$P_g = P_0 + t_f + i_f \quad (3.2)$$

$$= P_f + i_f. \quad (3.3)$$

We can convert this per-gallon driving cost to per-mile driving cost (P_m), defined as the total cost of driving divided by VMT. Total fuel cost is the fuel price per gallon (P_f) multiplied by the amount of fuel consumed (F). Therefore, per-mile driving cost is defined as the sum of total fuel cost and insurance cost divided by VMT and it can be broken down into the per-mile fuel price, per-mile fuel tax (t_m), and per-mile insurance premium (i_m) as following:

$$P_m = P_f \cdot \frac{F}{M} + \frac{I}{M} \quad (3.4)$$

$$= P_0 \cdot \frac{F}{M} + t_f \cdot \frac{F}{M} + \frac{I}{M} \quad (3.5)$$

$$= \underbrace{\frac{P_0}{E} + t_m}_{\text{per-mile fuel cost}} + \underbrace{i_m}_{\text{per-mile insurance cost}}. \quad (3.6)$$

Therefore, P_m is affected by any changes in policy instruments: fuel price per gallon; fuel tax either per gallon or per-mile; insurance premium (either per gallon or per mile); and fuel efficiency. Increasing gas tax, for example, would affect fuel price per gallon (P_f) directly and the change in P_f will be reflected in P_m . Any policy change would impact many interrelated factors either directly or indirectly and may cause changes in consumer's behavior. That is, a policy change may simultaneously change two or even all endogenous variables in the system of equations (3.1).

The three equations in (3.1) can be solved for M , V , and E . We can use system (3.1) and the definition of P_m to find the changes in all three endogenous variables (V , M , and E) by applying chain rule differentiation.

Any policy change would impact many interrelated factors either directly or indirectly and may cause changes in consumer's behavior. That is, a policy change may simultaneously change two or even all endogenous variables in the system of equations (3.1).

A policy causing a change in pricing or regulatory parameter would affect per-mile driving cost, P_m , and it would, in turn, directly affect vehicle miles, M , and fuel consumption, F . An increase in P_m then would affect consumers' choice of vehicles (i.e. number of vehicles and vehicle type) in favor of fuel efficient vehicles.⁵ A change in fuel efficiency (E) now has two effects. One is the direct effect on fuel consumption which reduces fuel consumption assuming no change in VMT and the other is the indirect effect (or "rebound effect") on fuel consumption which increases VMT since improved fuel efficiency would cause a reduction in per-mile driving costs, P_m .

Since fuel consumption F and travel miles M are related through the identity $F = M/E$ and M depends on the per-mile driving cost P_m , the demand for fuel with respect to a policy change will be determined by the magnitude of the elasticity of fuel demand with respect to fuel efficiency, ε_{FE} . The elasticity is computed from the identity of $F = \frac{M(P_m)}{E}$, which can be decomposed into the direct effect of the efficiency change on fuel consumption and the indirect effect (i.e. rebound effect) on fuel consumption from increased VMT. The rebound effect depends on the elasticity of vehicle miles M with respect to the per-mile driving cost (ε_{M,P_m}). Recalling that fuel efficiency E is a function of fuel price as in the third equation of Eq.(3.1), we can derive the connection between ε_{M,P_m} and ε_{E,P_f} ⁶ and we

⁵Since we assume no vehicle maintenance cost consumers consider vehicle purchase price (P_v) and per-mile driving cost (P_m) when they make decisions on new vehicle purchase.

⁶See Small and Van Dender (2005, pp.2-5) for detailed derivation.

can get the proportional rebound effect as:

$$\varepsilon_{M,P_m} = \frac{\varepsilon_{F,P_f} + \varepsilon_{E,P_f}}{1 - \varepsilon_{E,P_f}} \quad (3.7)$$

3.4.2 VMT :

A policy change (e.g., gas tax increase) would decrease VMT (ΔM_0) directly because of the increased fuel price through the first of equations (3.1). But there are also indirect change in VMT through the impact of gas price on fuel efficiency (ΔM_E) and vehicle stock (ΔM_V) in the other two equations. Consumers are in favor of fuel efficient vehicles and thus fuel efficiency technology would affect vehicle price. Vehicle prices (and other vehicle characteristics) would affect vehicle ownership cost and high ownership cost would cause decrease in vehicle stock (probably with some changes in vehicle composition) and in vehicle miles (M). Total change in M including indirect effect from a change in vehicle stock and in fuel efficiency can be determined by solving the system equations (3.1) with respect to the change of a policy variable change.

The three equations in (3.1) can be solved for M , V , and E . We can use system (3.1) and the definition of P_m to find the changes in all three endogenous variables (V , M , and E) by applying chain rule differentiation.

The change in fuel efficiency E can take place through different policy instruments: a change in fuel price per gallon, a change in vehicle prices, and a change in the regulatory parameter. Because these three exogenous variables all have different impacts on E via the other equations, the effects of these on other variables like VMT will not be the same. The total change in vehicle miles ΔM

from a change in fuel price (P_f), for example, would be:

$$\begin{aligned}
\Delta M &= \Delta M_0 + \Delta M_V + \Delta M_E \\
&= M \cdot \beta_{M,pm} \frac{\Delta P_f}{P_f} + M \cdot \beta_{M,V} \beta_{V,pm} \frac{\Delta P_f}{P_f} + \varepsilon_{M,pm} (1 - \beta_{E,pf}) \frac{\Delta P_f}{P_f} \\
&= M \cdot \varepsilon_{M,pm} (1 - \beta_{E,pf}) \frac{\Delta P_f}{P_f}.
\end{aligned} \tag{3.8}$$

where, $\varepsilon_{M,pm} = \beta_{M,pm} + \beta_{M,V} \cdot \beta_{V,pm}$ is the elasticity of vehicle miles with respect to the change in per-mile vehicle driving cost and β 's represent the elasticities of the three structural equations. For example, $\beta_{E,pf} \equiv (\partial E / \partial P_f) \cdot (P_f / E)$ represent the elasticity of fuel efficiency with respect to fuel price change in the third of equations (3.1).

3.4.3 F

Basically, the total amount of fuel consumption is calculated by the identity, $F = M/E$. Therefore, either change of vehicle miles (by way of the change in P_m) or fuel efficiency would affect the amount of fuel consumption. Likewise, the total change in fuel consumption can be decomposed into direct impact from a change in fuel efficiency due to a policy change and indirect impact of vehicle composition change in favor of fuel efficient vehicles and of VMT change due to improved fuel efficiency which leads to lower vehicle operating costs.

$$\Delta F = \Delta \left(\frac{M}{E} \right) = \underbrace{-\frac{M}{E^2} \cdot \Delta E}_{\Delta F_0} + \frac{\Delta M}{E}. \tag{3.9}$$

The first term in the equation, ΔF_0 , is direct impact from a change in fuel efficiency due to policy change and the second term is the change from increased vehicle miles.

3.4.4 G (GHG) E

According to U.S. EPA (2006), the transportation sector accounted for about 27 percent of total U.S. GHG emissions in 2004.⁷ CO₂ is the predominant GHG emitted from vehicles. In addition to carbon dioxide, automobiles produce methane (CH₄) and nitrous oxide (N₂O) from the tailpipe, as well as HFC emissions from leaking air conditioners.

Calculating GHG emissions from “Light-duty” vehicles (i.e., passenger cars and light-duty trucks), including other GHGs converted into CO₂ equivalent, follows the method of U.S. EPA (2005). A gallon of gasoline is to produce some pounds of CO₂.⁸ It is also assumed that CH₄, N₂O, and HFCs account for a portion of emissions, and the CO₂ estimate was adjusted by this factor to incorporate the contribution of the other greenhouse gases.⁹ We denote G_f as an emission factor per gallon of fuel use and G_α (in percent) as the portion of other GHGs among total emissions. Then, total GHG emission, G , becomes a function of fuel economy and VMT (M):

$$G = G(E, M) = G_f \cdot \frac{M}{E} \times \frac{100}{1 - G_\alpha}. \quad (3.10)$$

By defining c_G as an external cost of gas emissions per unit of CO₂ equivalent, we can monetize environmental costs of greenhouse emissions, C_G , as:

$$C_G = c_G \cdot G. \quad (3.11)$$

⁷EPA, US Emissions Inventory 2006

⁸According to U.S. EPA, it is assumed as 19.4 pounds (or 8.8 kilograms) per gallon.

⁹The emissions of CH₄ and N₂O are related to vehicle miles traveled rather than fuel consumption. On average, CH₄, N₂O, and HFC emissions represent roughly 5 – 6 percent of the GHG emissions from passenger vehicles. So we assume other GHGs account for 5 percent of emissions and the CO₂ estimate was multiplied by 100/95. (For more detail, see U.S. EPA, 2005.)

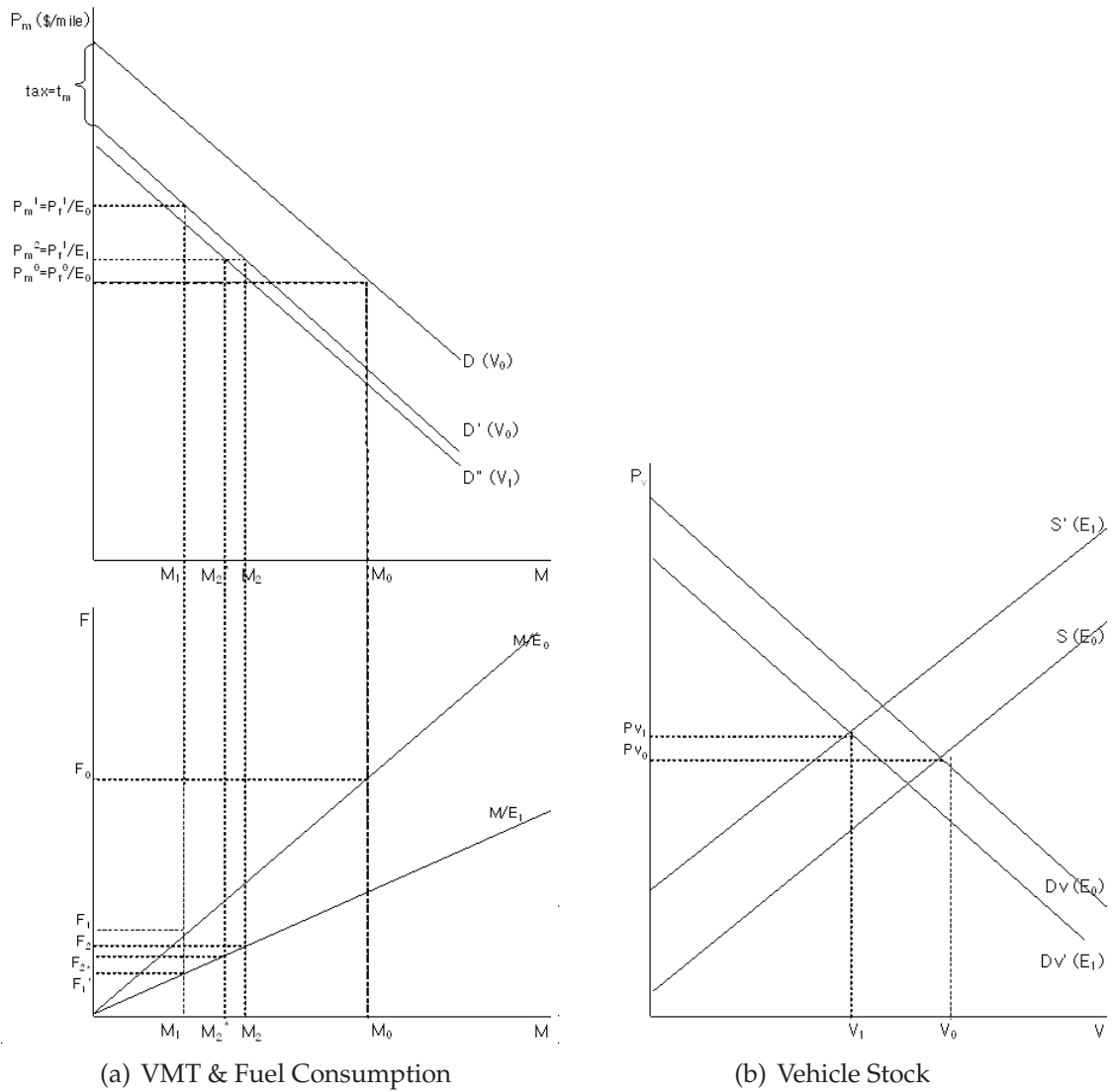

Figure 3.2: Measuring Welfare Changes

3.4.5 W C

Measuring welfare changes considering indirect effects of rebound effect can be explained graphically. In Figure 3.2, curve D and D' represent the demand for VMT as a function of per-mile fuel cost (P_m) before and after a policy implementation (e.g. fuel tax increase) respectively. The graph in the bottom of panel (a) shows fuel consumption as a function of VMT at two different values for fuel efficiency: E_0 and E_1 ($E_1 > E_0$). The initial equilibrium before a new policy implementation is determined at $P_m^0 = P_f^0/E_0$ and M_0 , which determines the fuel

consumption at F_0 . An increase in tax per gallon of fuel consumption (t_f) will shift the demand curve to the left by a distance of $t_m = t_f/E_0$; when other things remain equal, this will increase the consumers' per-mile fuel price to $P_m^1 = P_f^1/E_0$. The difference between the price consumers pay (P_m^1) and the price producers receive (P_m^0) is the same as t_m . Then the increase in consumer's price will move the quantity of vehicle miles to M_1 along the shifted demand curve D' . The tax policy also affects consumers' and manufacturers' choice of fuel efficiency. Consumers are in favor of fuel efficient vehicles and manufacturers invest in new technologies to improve fuel efficiency. The joint decision of consumers and manufacturers would increase fuel efficiency to E_1 . Then, the change in fuel efficiency further decreases fuel consumption to F_1' if VMT remained constant at M_1 . But in fact VMT increases from M_1 to M_2 ("rebound effect") due to decrease in per-mile driving cost from P_m^1 to P_m^2 raising fuel consumption by amount $(F_2 - F_1')$.

Meanwhile, the new choice of fuel efficiency by consumers and manufacturers would lead to a new equilibrium in vehicle market. The new technologies to raise fuel efficiency are likely to increase the cost of manufacturing vehicles causing the supply curve in vehicle market, $S(E_0)$, to $S'(E_1)$. The new equilibrium in vehicle market would be the point with reduced vehicle stock but with increased price of new vehicles. These changes in vehicle demand and supply are shown in panel (b). The reduction in vehicle stock, in turn, would reduce the amount of driving to M_{2*} as in panel (a).

Therefore, the effect of fuel tax on vehicle miles is reduction in travel demand by $(M_0 - M_{2*})$ and then the reduction in fuel consumption is $(F_0 - F_{2*})$.

The welfare can be measured approximately by the sum of consumer surplus. In general, consumer surplus is measured as the area surrounded by the price level and the demand curve. Since we are considering two different markets (i.e., vehicles miles and vehicle stock in terms of output), the welfare is the sum of

consumer surplus in these two markets. In the absence of fuel tax the consumer surplus is the sum of the area of a triangle surrounded by the price P_m^0 and the demand curve $D(V_0)$ along with the vertical axis in vehicle miles market and the area of a triangle under the demand $D_v(E_0)$ and above the price P_v^0 along with the vertical axis in vehicle stock market. With the implementation of fuel tax policy, for example, the consumer surplus reduces to the sum of the area of the price P_m^2 and the shifted demand curve $D''(V_1)$ in panel (a) and the area of the increased price P_{v1} and the shifted demand curve $D'_v(E_1)$ in panel (b).

A policy change also has an effect of cost savings from reduction in fuel consumption and in GHGs emissions. Note that other cost charges (e.g., PATP premium) are transfers of costs and they are not considered as part of welfare. The monetary cost savings from fuel consumption and GHG gas emissions can be computed by multiplying the reductions in fuel consumption ($F_0 - F_{2*}$) and in GHG emissions ($G_0 - G_{2*}$) by the unit cost of fuel P_f and of CO₂ emissions.

$$\begin{aligned}\Delta W &= \Delta C_F + \Delta C_G \\ &= P_f \cdot \Delta F + c_G \cdot \Delta G,\end{aligned}\tag{3.12}$$

where c_G is the unit cost per ton of GHG emissions (e.g., CO₂).

3.5 D P S

3.5.1 H

Several studies have attempted to compare and rank energy conservation and emission reduction strategies in terms of cost effectiveness. Their conclusions vary due to varying assumptions. To fully explain the impacts of policy options, we need to consider a variety of impacts besides energy conservation and

emission reductions, including impacts on consumer costs and transportation choice, congestion, traffic safety. Policy strategies that increase per-mile vehicle operating costs tend to reduce total vehicle travel, and so can provide benefits such as reduced congestion, traffic crashes while strategies aiming to reduce per-mile vehicle operating costs tend to induce additional vehicle travel, and so tend to increase traffic congestion, crash risk.

3.5.2 S

Three interrelated economic demand decisions (size of vehicle stock, use of the vehicle stock in terms of VMT or fuel consumption, and energy efficiency) are integrated into systems of equations to predict policy impacts as in Small and Van Dender (2007). Since the details of each policy strategies will influence consumers with different income levels, vehicle preferences, driving patterns etc., the analysis framework identifies the ways that behavioral reactions modify policy outcomes. Along with these system equations (3.1), some necessary equations are constructed to describe the relationships among variables that represent these factors. For example, equations to decompose the estimated vehicle miles and vehicle stock by vehicle type are constructed, which will be explained later in more detail. This work includes adding some characteristics to the econometric model to describe features of the policies under consideration, and probably reestimating the model with these additional characteristics so that they can be accounted for consistently in simulation. Then we can project the impact on fuel consumption and greenhouse gas emissions, for example, from the added equations of (3.9) and (3.10).

3.5.3 D P V

State level aggregate cross-sectional times series data set over the period from 1966 to 2004 are used in the simulation. Data set for this study provides a description of each state's fuel price, VMT, highway gasoline consumption and other factors such as income per capita, vehicle stock and its composition. State level aggregate data of transportation, economics and demographics, which were used in Small and Van Dender (2007), are used in the simulation with expansion to 2004. Some of the required parameters are taken from existing literature, while others are estimated by extending and re-estimating the econometric model from the system of equations (3.1) using the expanded data set.

Regarding data sources, transportation data such as vehicle miles traveled (VMT), vehicle stock, highway use of gasoline, state and federal gasoline taxes, number of drivers and public road mileage are from *Highway Statistics* by U.S. FHWA. Demographic data such as population and urbanization are from U.S. Census Bureau. Other economic data such as consumer price index (CPI), new car price index, personal income, interest rate, and price of gasoline are from Bureau of Labor Statistics or Bureau of Economic Analysis.

In the system equations (3.1), M and V are divided by adult population, by state and year in log form. Income and price data, stated in 2004 prices, are also in log form and normalized by subtracting the sample mean over 1966 to 2004.

3.5.4 A

To examine simulation results using the model under different scenarios, we need to decide on values for the exogenous variables during the forecast period. Future exogenous variables are determined outside the model and some of the required parameters are taken from existing literature.

As a baseline scenario for the annual growth rate for future years of exogenous variables such as population, income, price indexes, we assume that the exogenous variables increase at the previous 10 years' (1995-2004) average growth rate in 2005 and then keep the same increase rate after 2006. Regarding interest rate, we assume that it is fixed at 2004 rate considering cyclical fluctuations.¹⁰ Regarding gasoline price, we apply high price case from *Annual Energy Outlook 2007* by the U.S. Energy Information Administration (EIA).¹¹

3.5.5 P O S

After setting up an baseline scenario, we need to specify each policy option with various scenarios such as different combinations of parameter values to achieve the targeted policy goal. We are considering five different policy options and each policy option may have different scenarios for exogenous variables. For example, future income may increase with fixed rate of increase annually or it may change differently every year.

Regarding policy scenarios, we may have different ways of approaching to policy goal and of defining future values of exogenous variables. We consider one-time permanent change in pricing policy variables such as fuel tax or mileage tax in a specific year (2008 in our model) and a gradual change in fuel economy standards over some period of time (2008–2012 in our model).

¹⁰The 10 previous years' average shows that future interest rate would decrease by 3.88%.

¹¹U.S. EIA, "Annual Energy Outlook 2007 with Projections to 2030," available online at <http://www.eia.doe.gov/oiaf/archive/aeo07/index.html> (accessed on Dec. 15, 2007).

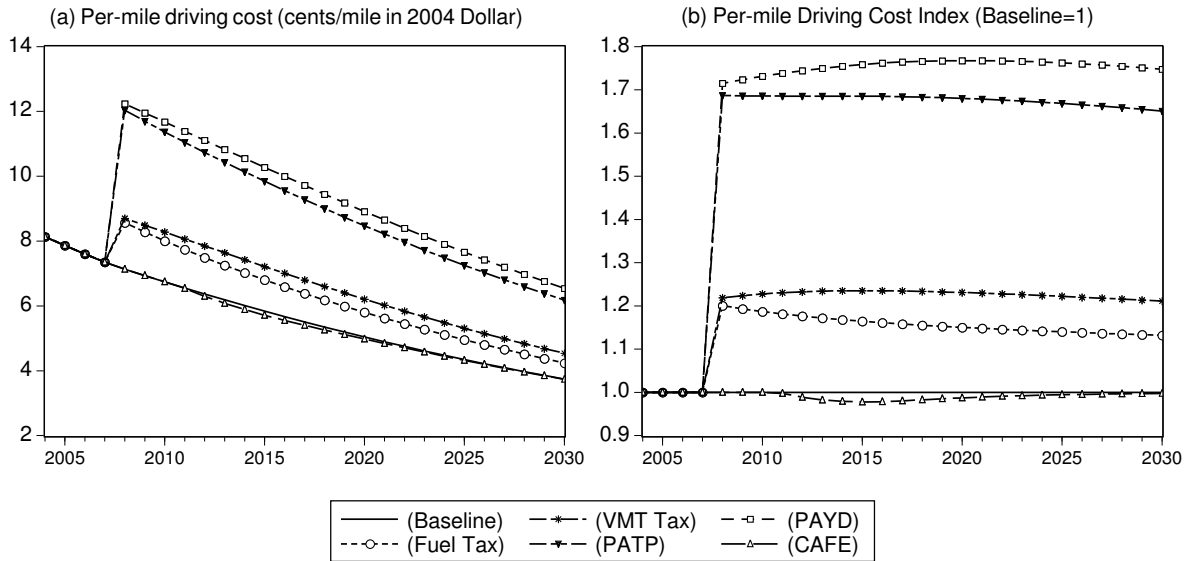

Figure 3.3: Comparison of Per-mile Driving Cost

3.6 I V S V U

3.6.1 P - D C

The simulation results in Figure 3.3 show that the per-mile cost of driving increases in all scenarios except *CAFE* scenario as we expected. *PAYD* scenario has the highest per-mile driving cost, with 83.6% increase in average from the baseline scenario over the period of 2008-2030, followed by *PATP* scenario, 71.9%, *VMT Tax* scenario, 24.8%, and *Fuel tax* scenario, 15.2%. The reason of high per-mile cost in *PAYD* or *PATP* scenario is because the insurance costs which were regarded as fixed costs are now variable costs along with fuel prices. The per-mile cost of *CAFE* standards regulation is slightly lower, with 7.6% decrease in average over the same period, than the baseline scenario. The results also show a decreasing trend of per-mile driving cost after an increase in 2008.

3.6.2 V U V S

Figure 3.4 presents the results on vehicle miles and vehicle stock. Predicted vehicle miles from simulations in panel (a) keep increasing in the future in all policy scenarios but the differences from the baseline scenario results are less than 1%. Due to the changes in per-mile cost, *PATP* and *PAYD* policy scenario show larger decrease in vehicle miles (per adult) from the baseline scenario. The gaps between an alternative policy and the baseline are also decreasing in later years and it seems to be from increasing income. On the contrary, *CAFE* policy scenario results in slight increase in vehicle miles because of the relatively cheaper per-mile cost.

Simulation results show increasing total number of cars and light trucks in all scenarios. When we look at the results in index term as in panel (b), we can see decreases in light duty vehicle stock index compared to the baseline scenario. The increase in per-mile driving cost might affect people to choose more fuel efficient (and possibly more expensive) vehicles in policies of *Fuel Tax*, *PATP*, and *PAYD*. We also see more light duty vehicle stock in *VMT Tax* and *CAFE* policy compared to the baseline. *VMT Tax* policy does not have any incentive to purchase fuel efficient vehicles so it increases the overall light duty vehicle stock index compared to the baseline scenario. *CAFE* policy also slightly increases the total light duty vehicle stock index compared to the baseline scenario thanks to the lower per-mile driving cost.

3.6.3 F C

Panel (a) in Figure 3.5 presents the decreasing fuel intensity (gallon per mile) in all scenarios which means increasing fuel economy (mile per gallon). It tells *PATP* achieves the highest fuel economy of the fleet while *VMT Tax* shows less fuel

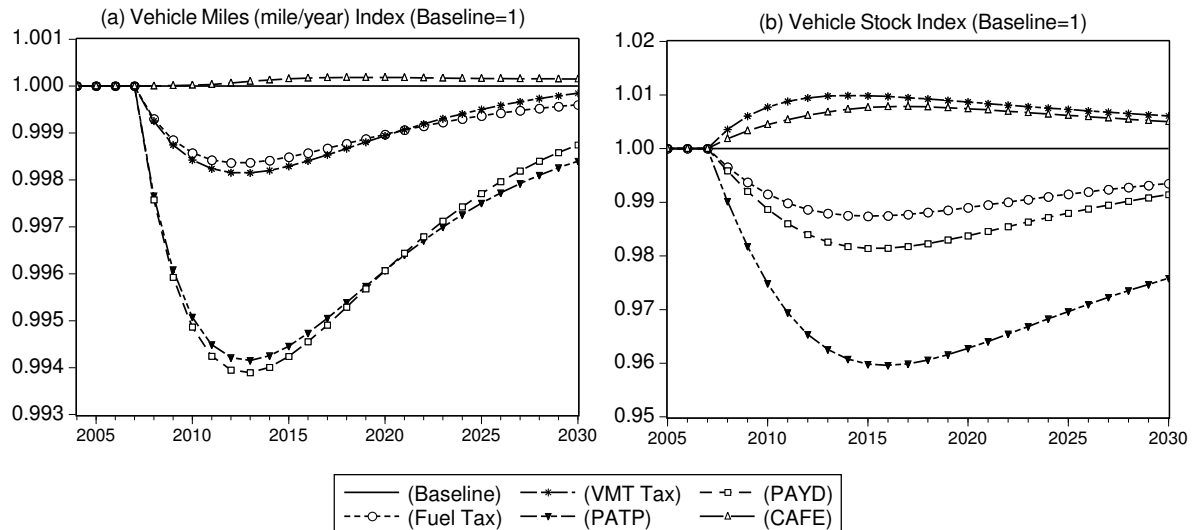

Figure 3.4: Comparison of Vehicle Miles and Vehicle Stock

economy compared to the baseline scenario.

Total fuel consumption shows increasing trend as vehicle miles do. The increase in the share of light trucks and the lower fuel economy of light trucks than cars would contribute to the increase in fuel consumption. All policy scenarios except *VMT Tax* scenario show less fuel consumption than the baseline scenario. The largest decrease in fuel consumption is achieved by *PATP* policy scenario, about 12.8% decrease in average from the baseline scenario result, followed by *CAFE* (7.2%), *PAYD* (5.6%), and *Fuel Tax* (4.6%) while *VMT Tax* shows increase in 3.5% in average over 2008-2030. The decrease in overall fuel consumption in spite of the increased vehicle miles was possible by the higher decrease in fuel intensity which allows less fuel use per mile of travel.

VMT Tax policy shows more fuel consumption than the baseline scenario even with the decrease in vehicle miles. It is because there is no incentive to use fuel efficient vehicle in *VMT Tax* scenario and there is overall increase in vehicle stock as we see in Figure 3.4 (b). Less fuel efficiency and more vehicle stock lead to a more fuel consumption. Therefore, *VMT Tax* policy does not achieve the assumed

policy goal of reducing fuel consumption.

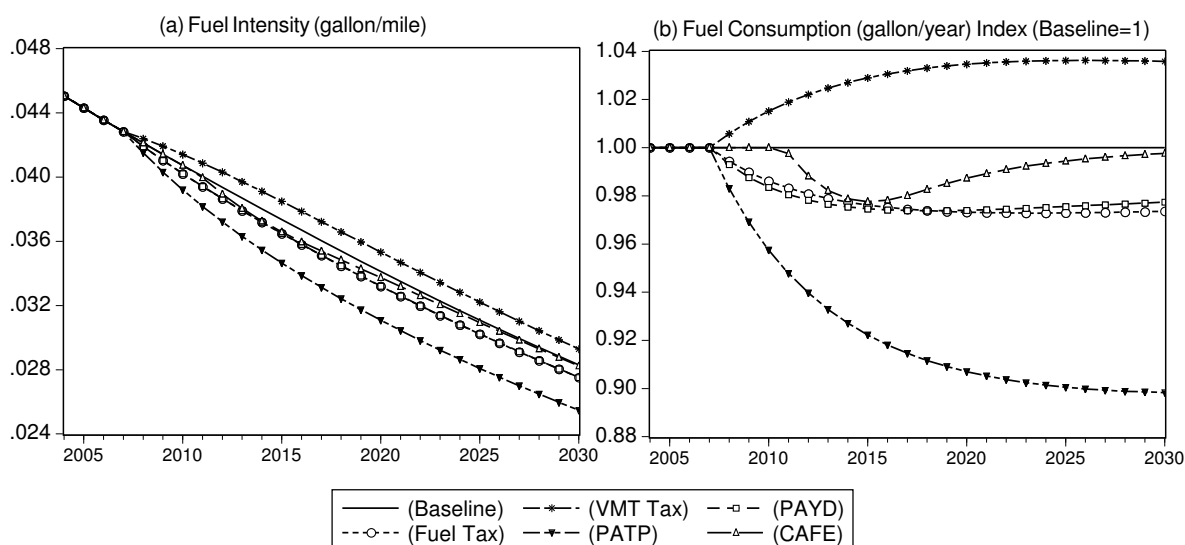

Figure 3.5: Comparison of Fuel Intensity and Fuel Consumption

3.6.4 G G E T R

Panel (a) in Figure 3.6 shows the environmental impact of transportation energy policy in terms of greenhouse gas (GHG) emissions. Total GHG emissions are sum of the amount of CO_2 , which is proportionate to fuel consumption and CH_4 and N_2O which are proportionate to vehicle miles and converted to CO_2 equivalent amount. Basically, GHG emissions figure in index term is almost the same as fuel consumption figure as in Figure 3.5 (b). The more fuel consumption leads to the more GHG emissions.

Regarding tax revenues, it seems there are high increase in tax revenues over time but the truth is that most policy options show decreasing tax revenues compared to the baseline scenario taking into account the tax level increase.¹²

Therefore, only *VMT Tax* scenario results in higher tax revenues due to less fuel

¹²We assumed 100% increase in tax level (cents/gallon) in all policies except *CAFE* policy. In *VMT Tax* policy the increased tax level per gallon is converted to per mile tax.

efficiency. We might say that *VMT Tax* policy can be a way to secure tax revenues to fund road construction and management.

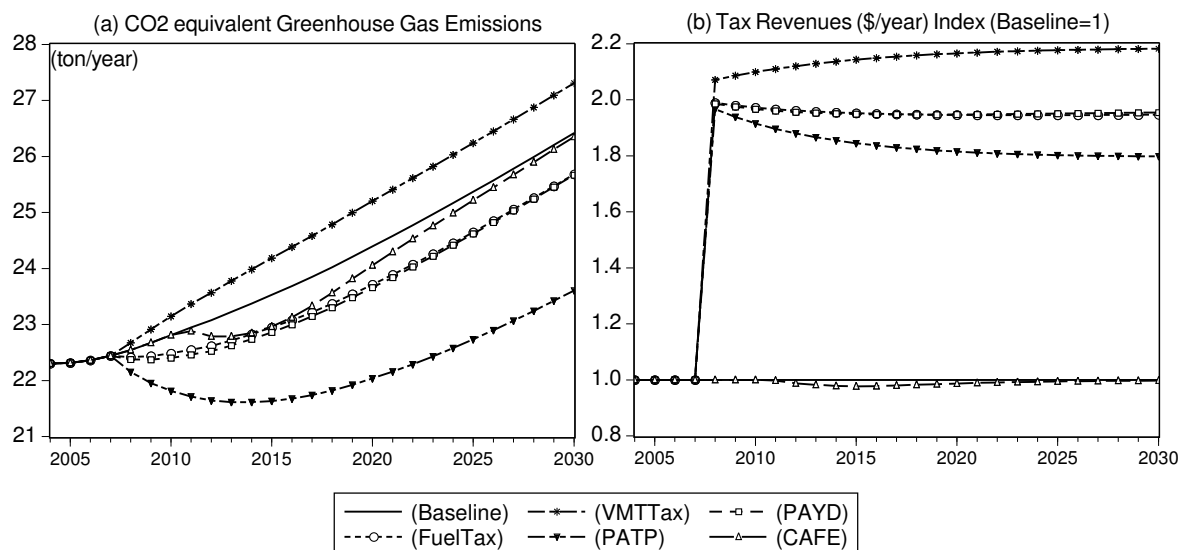

Figure 3.6: Comparison of Greenhouse Gas Emissions and Tax Revenues

3.6.5 W C : C S

Measuring welfare changes in numerical terms requires the slopes of demand functions of vehicle miles and vehicle stock as well as the elasticities of demand with respect to changes in price (See section 3.4.5). In addition, we also need information on the changes in supply side in vehicle stock market, which is beyond the scope of this research.

Instead, we present the numerical cost savings from the reductions in fuel consumption and GHG emissions. Fuel consumption and environmental cost savings depend on the unit costs and the amount of savings in fuel consumption. Unit costs of GHG emissions are affected by the deaths and illnesses caused by exposure to that pollutant. The State of Minnesota has evaluated the environmental cost of carbon dioxide emissions in the range of \$0.37–\$3.82 per

ton of CO₂.¹³ We arbitrarily apply \$3.00 per ton of CO₂ equivalent.¹⁴

The results on average over 2005–2030 show that there is cost reductions by 0.11% (CAFE) – 1.31% (PATP) from the baseline scenario mainly due to reductions in fuel consumption even though there are not much changes in vehicle miles. But VMT tax policy increases the costs by 0.28% due to increases in fuel consumption.

3.6.6 R S

Table 3.2 summarizes the impacts of transportation energy policy changes on travel demand and on environment over the time period of 2005–2030. Based on the results shown, *PATP* seems to be the best option to reduce travel demand and fuel consumption and thus GHG emissions.

Table 3.2: Summary of simulation results (Average over 2005-2030)

Policy	per-mile cost (cent/mile)	Veh. miles (bill. miles)	Fuel cons. (bill. gall.)	CO ₂ (kg/year)	N ₂ O (kg/year)	CH ₄ (kg/year)
Baseline	5.55	3,743.28	129.186	1,136.8	151.1	127.8
Fuel Tax	6.30	3,739.96	126.494	1,113.1	150.9	127.7
VMT Tax	6.61	3,739.98	132.611	1,166.9	150.9	127.7
PATP	8.72	3,730.94	119.802	1,054.2	150.6	127.4
PAYD	9.06	3,731.05	126.551	1,113.6	150.6	127.4
CAFE	5.51	3,743.76	128.096	1,127.2	151.1	127.8

¹³The unit costs are inflated to 2004 price from the original 1993 price (\$0.28–\$2.92) using CPI index.

U.S. EPA, “High Stakes Valuation in Action in Minnesota,” (Newsletter Volume: IV # 8 August, 1997) available online at <http://yosemite.epa.gov/ee/epalib/nwlet.nsf/Subject> (accessed on March 20, 2008).

¹⁴For other values of unit air pollution costs, visit Victoria Transport Policy Institute’s website at <http://www.vtpi.org/tca/tca0510.pdf> (accessed on March 20, 2008).

C 4 T I T E P T S

4.1 I

Motor vehicle traffic crashes are reported as one of the leading causes of death (out of 68 causes) in the U.S. based on 2002 data though total traffic fatalities and the fatality rates for vehicle occupants per 100 million vehicle miles are decreasing. Considering the current trends of increasing stock of light trucks (i.e., minivans, pickup trucks, or sport utility vehicles(SUVs)), which are reportedly safer than smaller cars when involved in traffic crashes, there are concerns about the risk of fatalities in smaller cars involved in traffic crashes, especially in two-vehicle crashes of cars and light trucks.

There are, of course, many factors from engineering factor to human factor which may affect traffic safety. The dominant category for high crash risk is driver's behavior. If drivers are cautious and abide by the traffic rules crash rate will be lower than that of reckless drivers' group.¹ Another important factor is engineering factor, which is related with the technology for safer vehicle and road conditions. In this chapter, we assume that vehicle miles and vehicle size, among many other factors, are important factors of the risk of traffic crashes.

Transportation energy policies considered in Chapter 3 would lead to reduction in VMT and to changes in vehicle fleet composition through changes in consumers' preference of lighter vehicle over heavy vehicles. Those changes in

¹This is one of reasons that the term "accident" is considered an inappropriate word by some people. But we use the terms 'accident' and 'crash' interchangeably.

vehicle fleet composition and the size of vehicles, in turn, may cause changes in the risk of traffic crashes and would have different impact on fatality and injury depending on whether the accident is a one-vehicle crash or two-vehicle crash. Considering the current trend of increasing stock of light trucks, which are reportedly safer than smaller cars when involved in traffic crashes, there are concerns about the risk of fatalities in smaller cars involved in traffic crashes, especially in two-vehicle crashes of cars against light trucks.

The purpose of this chapter is to explore the impacts of the transportation energy policies on traffic fatalities. It focuses on changes in VMT and in vehicle composition as a result of policy changes and then examines the effect on traffic accidents from those changes in terms of the number of traffic accidents, traffic fatalities, and total accident costs considering externalities of traffic crashes.

The measurement of the impacts of a policy change on traffic safety will be done through an analytical traffic accident model reflecting possible changes in the probabilities of accident of different types of vehicles (i.e., cars and light trucks) and crash type (i.e., single-vehicle crashes and two-vehicle crashes) after implementation of a new policy. In measuring policy impacts on vehicle miles and vehicle stock, this research is based on an analytical framework to identify the ways that behavioral reactions modify policy outcomes by Small and Van Dender (2007). We can use the simulation tool for the analysis of each state level or of the entire United States level like we do with the simulation model in Chapter 3.

4.2 L D V T S

4.2.1 T L D V T

Cars still dominate the share of light duty vehicle (LDV) stock at 57% in 2005, but not to the same extent as in 1970, when their share was about 83%. In contrast,

there was remarkable growth in the share of light trucks thanks to the increasing trends of light truck share in new LDV sales, which is even larger share (54.7%) than the share of new car sales in 2005. The number of registered cars and light trucks in U.S. rose from 108 million in 1970 to 240 million in 2005, an increase of 132 million vehicles according to U.S. Federal Highway Administration (FHWA) with an average annual increase rate of 5.0% over the same period while that of passenger cars is only 1.2%. The market share of light trucks sales is increasing rapidly with 5.4% of average annual increase rate from 1970 to 2005 while new car sales decreases with -0.3% in average for the same period (U.S. DOE 2007, Table 4.5 and 4.6). The increasing trends of light truck sales result in a change in overall vehicle composition and accounts for about 50 percent of the U.S. light-duty vehicle market since 2002. In terms of the share of vehicle miles traveled (VMT) of light duty vehicles, vehicle miles by cars account for about 61% of the total VMT in 2005, which was decreased by 27% from the share in 1970, while the share of light trucks' VMT increases to 39% from 12% in 1970. Average vehicle miles per vehicle for light truck has increased 31% from 1970 to 2002 while that of automobile has increased 18.8% (FHWA, 2004). The slower rate of increase in VMT share of light trucks may be due to the lower fuel economy (mile per gallon; MPG) in average compared to average car's fuel economy. According to FHWA's *Highway Statistics*, a car can drive up to 22.9 miles consuming one gallon of gasoline while a light truck can drive 16.2 miles in 2005.

The shares of highway transportation energy (i.e., motor fuel gasoline) by cars and by light trucks are about 41.5% and 36.8% respectively in 2005. The share of light trucks rose from 13.1% in 1970 with annual average increase rate of 0.6% while the share of cars decreased from 72.4%.

4.2.2 T T C

Crash rate can be defined as the crash frequency divided by some measure of exposure, such as the traffic volume, time, or distance. It is usually measured in crashes per million vehicle miles. Annual crash risk can be considered the product of two factors: per-mile crash risk times annual mileage. Therefore, traffic crash risk seems to increase with respect to an increase in vehicle miles.

Motor vehicle traffic crashes as one of the leading causes of death in the U.S. More than 6.1 million police-reported motor vehicle crashes occurred in the United States in 2005. Almost one-third of these crashes resulted in an injury, with less than 1 percent of total crashes (39,189) resulting in a death. Fifty-eight percent of fatal crashes involved only one vehicle Collision with another motor vehicle in transport was the most common first harmful event for fatal, injury, and property-damage-only crashes (NHTSA 2006).²

In 2005, the fatality rate per 100 million vehicle miles of travel was 1.47. In 2005, 31,415 occupants of light duty vehicles (LDV) were killed in traffic crashes (cars 18,440; light trucks 12,975) and an additional 2,446,000 were injured, accounting for 84 percent of all occupant fatalities (cars 49%, light trucks 35%) and 95 percent of all occupants injured (passenger cars 61%, light trucks 34%). Occupant fatalities in single-vehicle crashes accounted for 43 percent of all motor vehicle fatalities in 2005. Occupant fatalities in multiple-vehicle crashes accounted for 43 percent of all fatalities, and the remaining 14 percent were non-occupant fatalities such as pedestrians, bicyclists, etc.

²For purposes of compiling DOT safety statistics, fatality is defined as any injury that results in death within 30 days of a transportation crash, accident, or incident.

4.3 L I V A T C

4.3.1 E T E T C

As discussed in Chapter 3, a new policy change would result in a change of per-mile driving cost and the cost change would cause changes in vehicle miles, vehicle stock and its composition by way of travelers' behavioral changes. The cost change would also lead to changes in vehicle weight and sizes to improve fuel economy. The changes in vehicle miles and vehicle fleet composition along with the changes in vehicle weight and size, in turn, would have different impact on traffic safety by traffic crash type.

But the analysis of the safety effects considering the changes in vehicle weights and sizes together is very complex since there are many different specifications of cars and light trucks available in terms of weight and size. Some large 4-door cars are heavier than compact pickup trucks or small 4-door SUVs (NHTSA 2003, Table 3). With advanced technology it would be also possible to make a vehicle lighter without reducing the size of the vehicle (Ross and Wenzel 2001, p.33). So we assume, for simplicity, a light truck is heavier and larger than a car in general and a policy change would cause consumers to shift from light trucks toward cars or vice versa. CAFE standards regulation, for example, would tend to reduce vehicle weights to meet the standards with less changes in other vehicle characteristics (e.g., horsepower).

In general, the probability of a driver or passenger, either in a car or a light truck, being killed in a two-vehicle crash is higher if the other vehicle is a light truck than if it is a car. Increased VMT would by itself have a negative impact on

safety. But the safety implications of CAFE standards have been controversial and seem to be a mixture of two effects of increased safety in light truck occupants and increased fatality risk in cars involved in car-truck crash.

Little research has been done on the safety implications of other policy options, e.g., higher gasoline tax, per-mile insurance premium change, than CAFE standard changes. It is expected that a policy increasing fuel tax (and thus gas price) would tend to lower the number of accidents since it would reduce vehicle miles traveled. But it would also affect drivers to choose fuel efficient vehicles, which tend to be less in weight and smaller in size as a result of improved fuel efficiency, in the long run. The increase in fuel efficient smaller and lighter vehicles may have negative impact on injuries, especially when the vehicle is involved in a two-vehicle crash with a light truck. Therefore, the true effect of gasoline tax on crashes can be examined by comparing these effects together.

Mileage based VMT tax and insurance (liability) premium may only affect vehicle miles since drivers have no incentive to choose fuel efficient vehicles. Therefore, it would have positive impact on traffic safety with reduced number of crashes.

4.3.2 V S W T C

Regarding vehicle weight, the average weight of a new car and of a new light truck, which were both just over 4,000 lbs, began to decline in the late 1970's and early 1980's. It may be because of the CAFE standard regulation which was enacted in 1978 and increased at a slow rate extending into the late 1980s. Both cars and light trucks show decreases in their weight till 1987 and then, the weight for both vehicle types has been generally increasing maybe because of the relatively constant level of CAFE standards. The weight gap between cars and light trucks becomes larger and, in 2005, light trucks averaged 1,200 lbs. heavier

than cars in average (U.S. EPA, 2006).

Several studies examine the relationship between vehicle weight (or mass)³ and fatality rate. Here we focus on the effect of vehicle weight and size from two-vehicle crashes since the findings from two-vehicle crashes may give a better understanding of general effects of vehicle crashes.

When two vehicles with different weight crash, it seems likely that the lighter vehicle would have more damage than the heavier one taking into account basic physical principles of vehicle mass and speed. Ross and Wenzel (2001) show that occupants of the lighter car are at greater risk in almost all two vehicle crashes and thus reducing the weight (mass) of light trucks would result in a decrease in car fatalities and in overall fatalities. Evans (2004) also shows that the driver in the light car is 9 times as likely to die as the light truck driver when light cars and light truck (van) crash into each other. NHTSA (2003) analyze the crash data in 1995–2000 and estimate the average increase rate in the fatality rates of (W-100) pounds vehicles compared W pounds weighing vehicles for the same period model year (1991–1999) controlling for the age and gender of drivers, the types of roads they travel, and other factors. 100 pounds weight reduction in light trucks result in a modest net benefit by reducing the risk to the occupants of the other vehicles even though the fatality risk of the occupants in light trucks from rollover or fixed object crash increased. The weight reduction in cars increase the fatality risk to car occupants due to largest fatality increase in collisions with light truck vehicles. The conclusion of the research is that the association between vehicle weight and fatality risk in heavier light trucks was weak and insignificant while it was strong in the lighter cars implying increase in fatality risk from overall weight reduction.

Vehicle size, specifically crush space, does provide safety in case of crashes. In

³We assume that mass and weight are interchangeable though, conceptually, the two terms are distinct.

some studies, vehicle weight and size have not been distinguished and the benefits of size have been confused with the benefits of vehicle weight.

Evans (1984) examines police reported crashes with different age group and finds that accident involvement rates are lower for small cars than they are for larger cars driven by drivers of similar age. Regarding two vehicle crashes, many studies show that the damage is more critical to the occupants in a car than to the occupants in a light truck (See, e.g, White, 2004; Brozović and Ando, 2005). White (2004) measures both the internal effect of large vehicles on their own occupants' safety and their external effect on others and finds that the larger vehicle drivers and passengers are safer in a given two-car crash. She estimates the probabilities of fatalities and serious injuries by vehicle crash type and finds that that the probability of a car driver being killed in a two-vehicle crash is 61 percent higher if the other vehicle is a light truck than if it is another car. She also calculates the impact on the fatalities of replacing 1 million light trucks by cars caused by a policy change and finds the policy change would reduce the number of fatal crashes involving cars, pedestrians, bicyclists, and motorcyclists.

4.3.3 CAFE T S

Many studies have examined the relationship between vehicle safety and fuel economy. Some studies examine the effect of CAFE assuming that CAFE regulations led to reductions in vehicle weight since fuel is used primarily to overcome inertia and, other factors being equal, making a vehicle lighter reduces its fuel use. Crandall and Graham (1989) investigate the effect of CAFE on vehicle weight and on vehicle safety in terms of traffic fatalities using time series data. They find that decreases in vehicle weight caused by CAFE regulations increase traffic fatalities holding such variables as income, speed, age of drivers, alcohol consumption, gas price constant, concluding that CAFE, which caused decreases

in vehicle weight, was associated with an increase in crash fatalities in new cars. But Noland (2004) and Ahmad and Greene (2005) find no supportive evidence of Crandall and Graham's early finding through a statistical analysis of the correlation between fuel economy and traffic fatalities covering the period from 1966 to 2002 using state level data and national level data respectively.

These mixed results may be because there are two different effects from CAFE standard changes (Godek, 1997). One is the impact on vehicle stock composition. CAFE standards tend to reduce the weight of vehicles as substitute of high fuel efficiency and it seems to have negative impact on safety when a crash occurs. The other is that the increase in light trucks may reduce the fatalities risk of the passengers in light trucks but increase it for passenger of cars. Gordon *et al.* (2006) argue that modern vehicle manufacturing technology can strategically reduce car weight while improving vehicle structure, using advanced materials and designs, and thus can simultaneously increase fuel economy and safety.

4.4 A M I P C T S

A policy change would also cause changes in VMT and in vehicle stock and its composition through the system equations model in Small and Van Dender (2007) as discussed in previous section. Changes in vehicle fleet composition, in turn, would affect the severities (i.e., fatalities or injuries) of an accident differently by vehicle type and by crash type, especially in a two-vehicle crash, because of the differences in weight and size of the vehicle. Therefore it is important to analyze how the changes in vehicle fleet mix and in vehicle miles would impact the severity of two-vehicle crash.

In our analysis, we assume that two types of vehicle, cars (C) and light trucks

(LT), are available to consumers. We modeled the total passenger vehicle stock ($V \equiv V_C + V_{LT}$) as a function of vehicle purchase price, per-mile driving cost, and vehicle miles in the system of equations (3.1). Here we first analyze the changes in vehicle fleet composition as a result of a policy change. Consumers would also take into account the expected personal safety of occupants of each vehicle type, and their heterogeneous preferences for each vehicle type as specified in Brozović and Ando (2005).

4.4.1 T C D

An accident may result in damage risk such as fatality, injury to the occupant(s) of the vehicle differently by vehicle type and by crash type. Especially when a vehicle is involved in a two-vehicle crash the damage differs according to the size of vehicle. In our analysis, we assume that light trucks are larger and heavier than cars on average. Therefore car passengers involved in a two vehicle crash against a light truck would have more damage than light truck passengers involved.

1) N V I T C

A traffic crash can be categorized into either single-vehicle crash or multi-vehicle crash. We only consider single vehicle or two-vehicle crashes. That is, there are five types of crashes: single car (A_C), single light truck (A_{LT}), car-car ($A_{C,C}$), car-truck ($A_{C,LT}$), truck-truck ($A_{LT,LT}$).⁴ We assume the probabilities of a driver of each vehicle type getting involved in an accident, either one-vehicle accident or two-vehicle accident, may be different.

Here we define the accident involvement rates of a vehicle (a_{ij}) as the number

⁴According to the data of NHTSA (2005), the proportion of fatal single car and single light truck crash is about 84.3% of all fatal single vehicle crashes (Table 27). The proportion of fatal two-vehicle crashes of cars and light trucks is about 62.9% (Table 33) and the proportion of fatalities from two-vehicle of cars and trucks are about 64.1% of all two-vehicle crash fatalities (Table 73).

of vehicles of vehicle type i ($i= C, LT$) involved in crash type j ($j=1, 2$: 1= single vehicle crash, 2=two-vehicle crash), V_{ij} , divided by the total vehicle miles of vehicles of type i , M_i ⁵:

$$a_{ij} = \frac{V_{ij}}{VMT_i}. \quad (4.1)$$

By further defining a_{ij}^κ as the accident involvement rate by crash severity ($\kappa = F$ (fatality), H (injury), P (property damage only)) we can also compute the number of vehicles involved by crash severity, so that $a_{ij}(=\sum_\kappa a_{ij}^\kappa)$ and $V_{ij}(=\sum_\kappa V_{ij}^\kappa)$ are the sum of all severity types. Therefore a_{C1} , for example, is the rate of a car to be involved in a single car accident and a_{C2} is the rate of a car to be involved in a two-vehicle crash. Likewise, the accident involvement rates for a light truck are denoted as a_{LT1} and a_{LT2} for single truck crash and for two-vehicle crash respectively. These involvement rates can be obtained by averaging over the period of available historical data and, regarding future accident involvement rates, we assume these rates remain the same after a policy change. By applying the accident involvement rate, a_{ij} , to the changed vehicle miles by vehicle type, we can compute the number of vehicles by vehicle type and by accident type.

Vehicle miles by vehicle type can be obtained by decomposing the total vehicle miles (VMT) into:

$$\begin{aligned} M &= M_C + M_{LT} \\ &= m_C V_C + m_{LT} V_{LT} \\ &= m_C(1 - \theta)V + m_{LT}\theta V \\ &= m \cdot V \end{aligned} \quad (4.2)$$

⁵The probability of crashes can also be defined as the number of crashes per year by vehicle type divided by the total stock of vehicles of that type (See, e.g., White (2004), Table 4). Taking into account of the relations between the number of crashes and the number of vehicles involved in crashes and between the vehicle stock and the vehicle miles ($M_i = V_i \cdot m_i$), the one concept of probability of crashes can be converted into the other.

where, m_C and m_{LT} are average annual mileage of cars and trucks respectively, V_C and V_{LT} denote the number of cars and light trucks respectively, θ is the proportion of light trucks in the vehicle fleet, and m is the average annual mileage of all passenger vehicles.

2) P T -V C

Changes in vehicle fleet mix would result in different probabilities of accident by vehicle type, especially the probabilities of two-vehicle crashes by vehicle type, and thus the number of vehicle crashes. The vehicle type with higher share of total vehicle stock would have higher probabilities of getting involved in an accident, and any given vehicle has a higher probability of crashes into this type of vehicle.

Let's define V_2 as the number of vehicles involved in two-vehicle crashes, which is the sum of cars (V_{C2}) and light trucks (V_{LT2}) involved in two-vehicle crashes ($V_2 = V_{C2} + V_{LT2}$).⁶ Then we can compute the share of two-vehicle crashes by each crash type: car-car crash $p(C, C)$, car-truck crash $p(C, LT)$, and truck-truck crash $p(LT, LT)$, from following equations:

$$\begin{aligned} p(C, C) &= \binom{V_{C2}}{2} / \binom{V_2}{2} \approx \frac{V_{C2}^2}{V_2^2}, \\ p(C, LT) &= \binom{V_{C2}}{1} \binom{V_{LT2}}{1} / \binom{V_2}{2} \approx \frac{2 \cdot V_{C2} \cdot V_{LT2}}{V_2^2}, \\ p(LT, LT) &= \binom{V_{LT2}}{2} / \binom{V_2}{2} \approx \frac{V_{LT2}^2}{V_2^2}, \end{aligned} \quad (4.3)$$

where $\binom{V_{i2}}{2}$ denotes the combination function of choosing two vehicles out of the

⁶Note that the number of vehicles involved in two-vehicle crashes is twice as many as the number of two-vehicle crashes. Therefore caution should be taken when calculating the number of vehicles involved in two-vehicle crashes by vehicle type. The relationship between the number of vehicles involved in two-vehicle crashes and the number of accidents can be analyzed as: $V_2 = V_{C2} + V_{LT2} = [V_{C,C} + V_{C,LT}] + [V_{LT,C} + V_{LT,LT}] = V_{C,C} + 2V_{C,LT} + V_{LT,LT} = 2(A_{C,C} + A_{C,LT} + A_{LT,LT}) = 2A_2$, where A is the number of crashes.

number of V_{i2} and, by definition, $\binom{V_{C2}}{1} = V_{C2}$.⁷ The sum of $p(C, C)$, $p(C, LT)$, and $p(LT, LT)$ equals to one.

V_{C2} , V_{LT2} and thus V_2 can be shown as function of accident rate per vehicle mile traveled (a_{ij}), the share of light trucks (θ), average vehicle miles per vehicle (m_i), and total vehicle stock (V) as:

$$\begin{aligned} V_{C2} &= a_{C2}m_C(1 - \theta)V, \\ V_{LT2} &= a_{LT2}m_{LT}\theta V. \end{aligned} \tag{4.4}$$

We assume constant a_{ij} then the number of vehicles involved in two-vehicle crashes depend on the changes in average vehicle miles (m_i), the share of light trucks (θ), and the total vehicle stock (V). We further assume constant type-specific average vehicle miles (m_i) and total vehicle stock (V). Then V_{C2} is decreasing as θ is increasing while V_{LT2} is increasing with respect to an increase in θ . It implies that the share of two-car crash $p(C, C)$ decreases as θ increases while the share of two-light truck crash $p(LT, LT)$ increases. But we cannot tell whether the share of car-light truck crash $p(C, LT)$ and the number of vehicles involved in car-light truck crash would decrease or increase since it depends on the magnitude of changes in $p(C, C)$ and $p(LT, LT)$.

With the assumptions above, we see how the equation that the total number of vehicles involved in two-vehicle crashes, V_2 , may increase or decrease with θ depending on the relative magnitudes of $a_{C2}m_C$ and $a_{LT2}m_{LT}$. If $a_{C2}m_C > a_{LT2}m_{LT}$, the decrease in V_{C2} is larger than the increase in V_{LT2} , so V_2 decreases with θ . The opposite is true if $a_{C2}m_C < a_{LT2}m_{LT}$.

Once we can compute the number of vehicle of two-vehicle crashes (V_2), we can compute the number of vehicles involved in two-vehicle crashes by each

⁷Note that, for large V_2 , $\binom{V_2}{2} = \frac{V_2(V_2-1)}{2} \approx \frac{V_2^2}{2}$.

crash type from following equations:

$$V_{C,C} = p(C, C)V_2, \quad (4.5)$$

$$V_{C,LT} = p(C, LT)V_2, \quad (4.6)$$

$$V_{LT,LT} = p(LT, LT)V_2, \quad (4.7)$$

where $V_{l,m}$ ($l, m = C$ or LT) is the number of vehicles involved in two-vehicle crashes between vehicle type l and m .

F I R

We can compute the number of people involved in traffic accidents by multiplying the number of vehicles of type i involved in accidents of crash type j by the average occupancy rate of that vehicle type:

$$O_{ij} = V_{ij} \cdot o_i, \quad (4.8)$$

where O_{ij} is the number of people of vehicle type i being involved in traffic accidents of type j and o_i is the average occupancy rate of vehicle type i .

Now we define $f_{l,m}$ ($l, m = C$ (Car), LT (light truck)) as the fatality risk of occupants in a two-vehicle crash of type l vehicle against type m vehicle and we compute $f_{l,m}$ from historical fatality data:

$$f_{l,m} = \frac{F_{l,m}^0}{O_{l,m}^0}, \quad (4.9)$$

where $F_{l,m}^0$ and $O_{l,m}^0$ are the number of fatalities and people involved in two vehicle crash between l and m respectively from historical data and we also assume that this fatality risk $f_{l,m}$ is fixed at the 5 previous years' average value.⁸ We assume a

⁸The fatality risk of occupants differs by impact type (i.e., front-front, front-side, or front-rear

vehicle involved in a specific type of crash has the same risk of crash severity under all policy scenarios.⁹

Then the number of fatalities after policy implementation would be affected by the change in vehicles (and thus occupants) involved in crashes due to changes in vehicle fleet composition and vehicle miles and can be computed as:

$$F_{l,m} = f_{l,m} \cdot (V_l \cdot o_l + V_m \cdot o_m), \quad (4.10)$$

where V_l and V_m are the number of type l and type m vehicles in two-vehicle crashes, o_l and o_m are the average occupancy rate of each corresponding vehicle type.

We can similarly apply the same procedure to compute the number of people injured and the injury rate by replacing the fatality risks with the injury risk $h_{l,m} (\equiv \frac{H_{l,m}}{O_{ij}})$, where $H_{l,m}$ is the injured people from two vehicle crashes between type l and m vehicle. In summary, we may project the number of vehicles involved in traffic crashes by crash type from the projected vehicles miles from the model. Then we can compute the probabilities of two-vehicle crashes by crash type and we can decompose the number of vehicles involved two-vehicle crashes by vehicle type. Next, we can compute the number of people involved and the fatalities in traffic crashes by crash type and by vehicle type using the assumed average occupancy rate and relative fatality risk of striking and struck vehicle. Finally, we can compute the changes in fatality rate (or injury rate) using the simulated fatalities and injuries.

crash) and by whether the vehicle is a striking vehicle or a struck one. In general, occupants in struck vehicle has higher fatality risk. According to Fatality Analysis Reporting System (FARS) data, for example, the fatality ratio of striking car to struck light truck in front-side crash is 1:1.07, while the ratio of striking light truck to struck car in same type of crash (front-side) is 1:29.5 (NHTSA 2005).

But if we assume that this crashworthiness of a vehicle remains unchanged, the fatalities of striking or struck vehicle occupants are proportionate to those parameters.

⁹Regulations by the authorities and consumers' safety concern would make vehicle manufacturers keep improving vehicle safety features and the crashworthiness would be improved eventually.

4.4.2 A C

Conditional on an accident occurring, the costs of fatalities and injuries from two-vehicle crashes of vehicle l against m in a year can be defined as:

$$C(A)_{l,m} = F_{l,m} \cdot VSL + H_{l,m} \cdot WTP, \quad (4.11)$$

where VSL is value of statistical life and WTP is willingness to pay to avoid the accident. Then the total accident costs in a society are just sum of $C(A)_{ij}$ over vehicle type i and crash type j :

$$C(A) = \sum_i \sum_j C(A)_{ij}. \quad (4.12)$$

A policy change would impact VMT, the vehicle stock, and the fleet mix and these changes would affect the number of accidents (A_{ij}), the probabilities of two-vehicle crashes, and the number of fatalities (F_{ij}) or injuries (H_{ij}) and thereby the fatality (injury) rate. The changes in accident costs should be obtained by reflecting all these changes.

4.5 D V M V S V T

As explained earlier, each policy option would cause changes in vehicle preference and vehicle use and therefore it would be better if we could decompose the vehicle miles and vehicle stock into different vehicle types (i.e., cars and light trucks) to measure the safety effects from different policy scenarios. But we are not be able to decompose the projected vehicle miles and vehicle stock by vehicle type exactly due to data limitation. We will have combined light duty

vehicle stock (V) and total vehicle miles (M), which is the sum of all vehicle types including heavy trucks and buses. We don't have information on average vehicle miles by different vehicle type and we are more interested in the effect on light duty vehicles (LDV). Using the available data and some plausible assumptions, we can approximate projected vehicle miles by vehicle type.¹⁰

4.5.1 D V S C L T

1) N N L D V

Total vehicle stock of a current year is the sum of one previous year's vehicle stock minus scrapped vehicles plus newly purchased (and registered) vehicles in that current year. Vehicles are scrapped due to physical wear and tear of aging vehicles or as a result of severe crashes. The owner of a scrapped vehicle would then make an economic decision whether to purchase a new (or used) vehicle or to switch to an alternative means of transportation such as public transportation. Once he decided to buy a new vehicle then he determines which type of vehicle to buy. Therefore, newly purchased vehicles of a current year, cars and light trucks altogether, are:

$$V_t^{New} = (V_t - V_{t-1}) + V_t^{Scrp} \quad (4.13)$$

where V_t^{Scrp} is the number of vehicles scrapped (i.e., not used and not registered) vehicles in a state in year t .

We use national level scrappage rates by cars (σ_C) and by light trucks (σ_{LT}) projected using previous 5 years' average.¹¹ Overall scrappage rate of light duty

¹⁰There may be many other possible methods of decomposition with different assumptions on the unavailable (historical) data. The method described here is based on the assumption that the residents in a state may have different travel behavior from the residents in another state due to different light duty vehicle stock composition.

¹¹Historical scrappage rates at national level (2000–2004) were obtained from R.L. Polk & Co., "Reports U.S. Motor Vehicle Longevity Increases in 2006," http://usa.polk.com/news/latestnews/2007_0215_veh_longevity.htm (accessed on May 20, 2007).

vehicles (σ) is weighted average of σ_C and σ_{LT} considering the share of light trucks ($\sigma = (1 - \theta)\sigma_C + \theta\sigma_{LT}$).

2)S L T (θ)

Recalling the equation (4.2), we need the information on the share of light trucks (θ) to decompose vehicle miles and vehicle stock by cars and by light trucks. To compute θ , we need to know the market share of light trucks among newly purchased vehicle stock. There are many studies on vehicle type choice to analyze the factors to affect consumer's vehicle type choice. Many studies concentrate on vehicle attributes, household and drive characteristics, and brand loyalty and some studies focus on travel attitude, lifestyle factors. Discrete choice models (multinomial logit and nested logit) are generally used in those studies and most common explanatory variables are vehicle purchase price, operating cost, and income. (For more detailed review of vehicle type choice literature, see, e.g., Choo and Mokhtarian 2002.)

Unlike disaggregate discrete choice model, we simply define θ_{new} as the market share of light trucks among newly purchased vehicle stock and specify as a function of independent variables such as personal income (inc), consumer price index (CPI) for new vehicle (p_{newcar}), per-mile driving cost (p_m), fuel efficiency ($fint$), and others. But the experimental estimation of θ_{new} using historical national level data produce statistically insignificant coefficients of the variables, maybe due to not enough observations.¹²

In our analytical model, the only change among policy options happens in fuel price. All other variables but per mile driving costs are the same among policy options we consider and therefore the changes in θ_{new} would be mainly affected by the difference of new vehicle price compared to the baseline scenario (in case of

¹²Historical θ_{new} and the independent variables are available at national level only for 1970 to 2004.

CAFE policy) and by the difference of per mile driving costs. Therefore, figuring out θ_{new} can be done using the elasticity of the demand for light trucks with respect to fuel price (P_f) change.

Busse *et al.* (2008) investigate the effect of fuel prices on car prices and market shares. They estimate the effect of fuel prices on new light duty vehicle shares with more segments of LDV types (i.e., Compact, Midsize, Luxury, Sports, SUV, Pickup, and MiniVan) using a linear probability model. We apply their estimated elasticity (-0.045) of the demand for light trucks with respect to fuel price change from the baseline ($\Delta\theta_{new} = -0.045 \cdot \Delta pm$).

Then, the number of cars and light trucks becomes:

$$\begin{aligned} V_{C,t} &= V_{C,t-1} - \sigma_{C,t} \times V_{C,t} + (1 - \theta_{new,t})V_t^{New} \\ V_{LT,t} &= V_{LT,t-1} - \sigma_{LT,t} \times V_{LT,t} + \theta_{new,t}V_t^{New}, \end{aligned} \quad (4.14)$$

where σ_C and σ_{LT} are scrappage rate for cars and light trucks respectively, and $\theta_{new,t}$ is the market share of light trucks in new car sales in year t .

Therefore, the share of light trucks in year t , which is defined as $\theta = \frac{V_{LT,t}}{V_{C,t} + V_{LT,t}}$, now reflects the market share of light trucks in new vehicle sales.

4.5.2 D V M V T

1)S L A V M

We define $\omega (= M_{LDV}^N / M^N)$ as the portion of vehicle miles of light duty vehicles and compute ω from national level historical data. We assume this ω will be the same among states and compute state level vehicle miles of light duty vehicles

($M_{LDV} = \omega M$) and average vehicle miles ($m^S = M_{LDV} / V$).¹³

¹³Recall that M from (3.1) are the sum of vehicle miles of all types of vehicles including buses and heavy trucks.

2)S L T V M

We further define $\omega_C (= M_C/M_{LDV})$ and $\omega_{LT} (= M_{LT}/M_{LDV})$ as the share of vehicle miles of cars and light trucks respectively in total vehicle miles of light duty vehicles. By definition, ω_C and ω_{LT} become a function of the share of light trucks (θ) and average per vehicle miles m , m_C or m_{LT} :

$$\begin{aligned}\omega_C &= \frac{M_C}{M_{LDV}} = (1 - \theta) \frac{m_C}{m}, \\ \omega_{LT} &= \frac{M_{LT}}{M_{LDV}} = \theta \frac{m_{LT}}{m}.\end{aligned}\tag{4.15}$$

We assume future ratios of $\frac{m_C}{m}$ and $\frac{m_{LT}}{m}$ using previous 5-year average annual change rate. Then we can compute m_C and m_{LT} once we get the information on θ .

4.6 P S

4.6.1 P O S

We consider the same policy options and scenarios in Chapter 3 and focus on the effect of the policy change on traffic safety using the parameters from historical data or from other study results. We focus on the impact of policy options on traffic safety in terms of the number of traffic accidents, traffic fatalities, and total accident costs considering externalities of traffic crashes.

4.6.2 P D

The variables used in the simulation model and the sources of data are explained in Chapter 3. We measure the impacts of a policy change on traffic safety by estimating the changes in the number of accidents by vehicle type, by crash type, and by crash severity and the simulations are based on the (fixed) factors such as

Table 4.1: Vehicle Crash Involvement and Fatality Rate

	Accident Involvement Rate (Accident Veh.'s/VMT (in mil.))		Fatality Rate (Fatalities/Occupants)		
	Single Crash	2-veh. Crash	Single Crash	2-veh. Crash	
Car	0.6687	2.8243	0.00441	(C-C)	0.00068
				(C-LT)	0.00168
LT	0.6707	2.6853	0.00418	(LT-C)	0.00040
				(LT-LT)	0.00100

crash involvement rate, fatality and injury rate. These rates can be obtained from historical data or from other study results (e.g., White (2004)). Table 4.1 shows the accident involvement rate (a_{ij}) and fatality rate (f_{ij}) from actual historical data.

Traffic accident costs can be estimated by reflecting the changes in VMT and the changes in vehicle fleet composition with incorporating the changes of fatalities or injuries. To estimate the accident costs per crash or the total social costs of accident, we need the values of WTP and VSL . We apply average social cost per injury type as in Parry (2004) and, for fatalities, we apply the Value of Statistical Life (VSL) of \$5.5 million in Small and Verhoef (2007).

4.7 I T S

4.7.1 S L T

Simulation results of vehicle stock present decreasing light duty vehicle stock index compared to the baseline scenario as we see in Chapter 3 (Figure 3.4). Taking a closer look in terms of the number of light trucks, all scenarios except *CAFE* policy show decreasing number of light trucks compared to the baseline scenario (Figure 4.1 (a)). Improved fuel efficiency in *CAFE* policy reduces the per-mile driving cost and lower operation costs may enable consumers to purchase more light trucks.

The share of light trucks (θ) is expected to keep increasing in all scenarios with

the highest increase at *CAFE* policy and the lowest increase at *PAYD* policy in Figure 4.1 (b). The share of light trucks becomes larger than that of cars starting 2018 in Baseline and *CAFE* policy and in all scenarios in 2024.

The increase in per-mile driving cost might cause people to choose more fuel efficient vehicles in policies of *Fuel Tax* and *PATP*. Meanwhile, *VMT Tax* policy does not have any incentive to purchase fuel efficient vehicles so it increases the overall light duty vehicle stock index compared to the baseline scenario. *CAFE policy* also slightly increases the share of light trucks than the baseline scenario thanks to the lower per-mile driving cost.

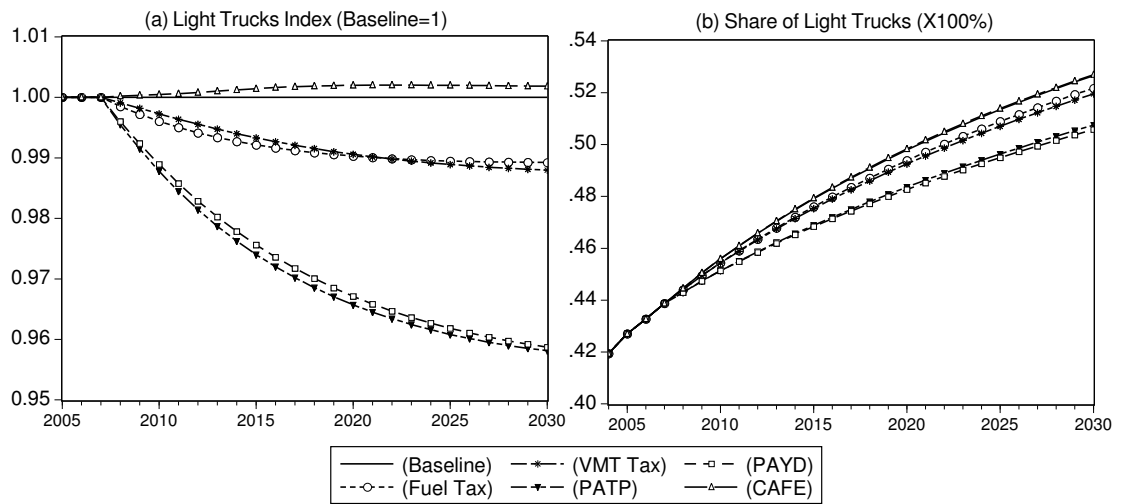

Figure 4.1: Light Trucks Index and The Share of Light Trucks

4.7.2 N V I A

We can easily expect that the number of vehicles involved accidents would increase as vehicle miles increase since we assume constant accident involvement rates proportionate to vehicle miles from the equation (4.1). We can also expect that the number of cars involved in accidents would keep decreasing along with the reduced share of cars in light duty vehicle stock and less vehicle miles of cars

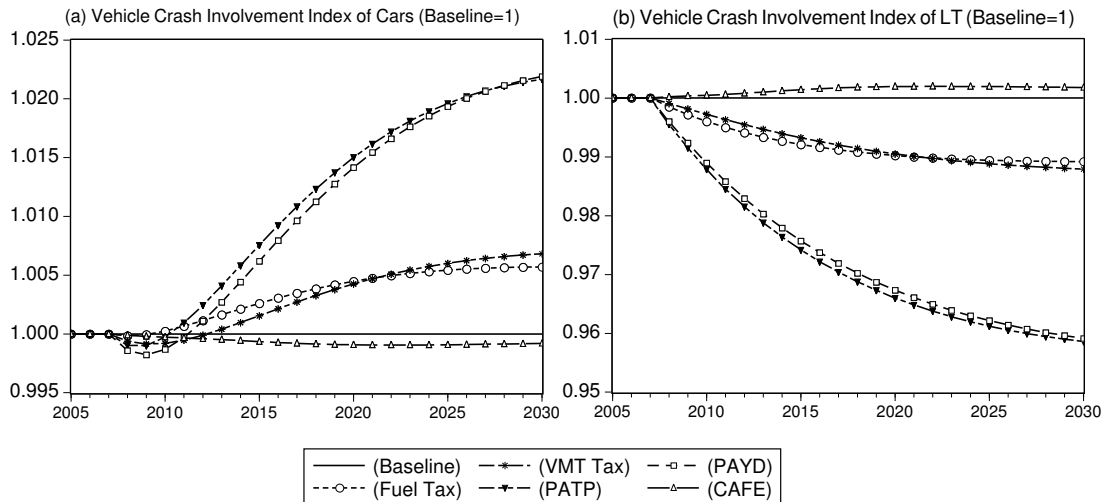

Figure 4.2: Index of Traffic Crashes by Vehicle Type (single crash + 2-veh. crashes)

than the baseline scenario. The number of light trucks involved in accidents would increase as the share of light trucks increase. *VMT Tax* policy would result in the highest decrease in the number of cars involved in both single and two-vehicle crashes due to biggest decrease in vehicle miles by cars. The number of light trucks involved in any type of crashes decrease the most in *PATP* policy compared to the baseline scenario. It is mainly due to the decrease in vehicle miles since the number of crashes is proportional to vehicle miles.

Figure 4.2 shows the comparison of vehicles involved in accidents by policy scenarios and by vehicle type in index term. We can see that trends of increasing light truck crashes and, as in the results of car crashes, *VMT Tax* policy has the smaller vehicles involved in accident than the baseline scenario but much smaller than the decrease in car crashes.

4.7.3 F F R

Figure 4.3 presents the total fatalities in index terms and we can see that all policy options except *CAFE* policy slightly decrease the number of people killed from

traffic accidents than the baseline scenario by less than 1%. It shows the similar trend as the vehicle miles difference since the accident involvement rates and the fatality risks are assumed constant and therefore the fatalities are proportionate to vehicle miles.

Panel (b) in Figure 4.3 also shows that fatality rates, which are defined as the fatalities divided by vehicle miles, are decreased by most policies, implying that a policy goal of reducing traffic fatalities may also be achieved from transportation energy policy changes. *PATP* and *PAYD* policy result in the largest decrease in fatalities.

Inverted U-shaped curves of these fatality rates can be explained from the changes in θ and vehicle miles by vehicle type. As θ increases the fatalities from single car crash and two-car crashes would decrease while there would be increase in fatalities from single light truck crashes and two light truck crashes. Considering fatality risk parameters in Table 4.1, the sum of these changes would have little difference from the baseline. Therefore the difference of the fatality rates come from the changes in fatalities from Car-LT crashes. Simulation results show that both vehicle miles by cars (M_C) and by light trucks (M_{LT}) increase while the share of M_{LT} shows decreasing trend with slight increases in the first 5 years. Therefore, there will be decreases in in fatalities from Car-LT crashes taking into account the trends of vehicle miles by vehicle type along with the increase in θ and higher fatality risk of car passengers.

Focusing on the fatalities from two-vehicle crashes, fatalities from car-car crash are higher than baseline scenarios in *PATP* and *Fuel Tax* policy and lower in *VMT Tax*, *CAFE* scenario. The share of fatalities of car occupants in two vehicle crashes keep decreasing while the share of fatalities of light truck occupants keep increasing mainly due to the increase in the share of light trucks (θ) in all scenarios. The fatality share of car occupants decreases down to about 70.3% in

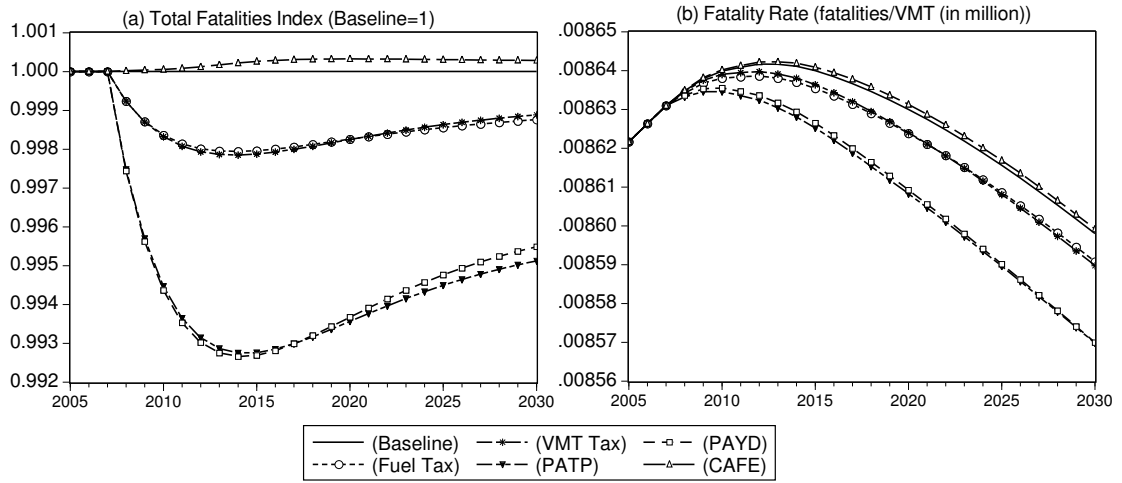

Figure 4.3: Total Fatalities from accidents

2030 from 73.6% in 2005 while the share of light truck occupants increase to about 29.7% over the same period.

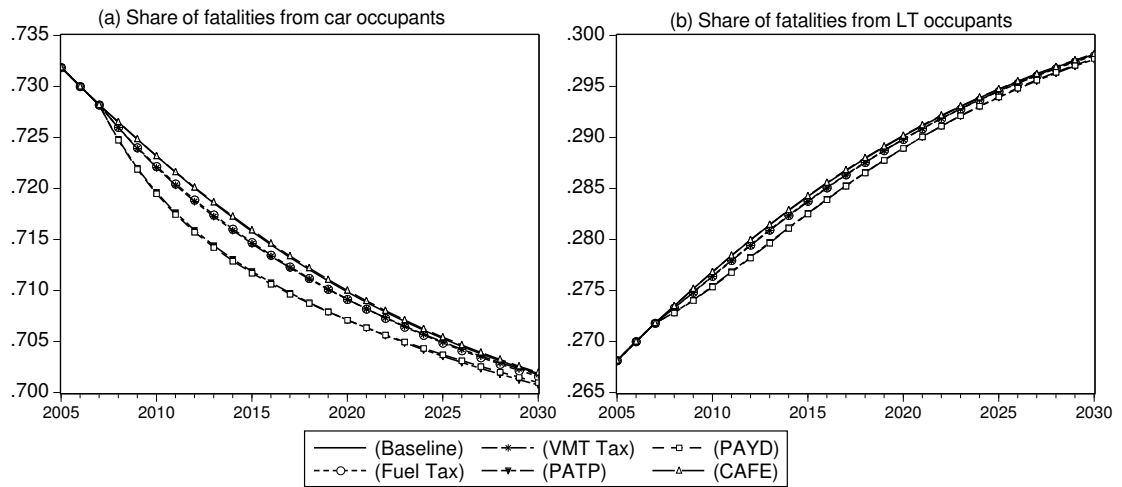

Figure 4.4: Share of Fatalities in two vehicle crashes

In addition, the share of fatalities in car-car crash decreases while the share in LT-LT crash increases due to the increasing share of light trucks. The increase rate of fatalities in LT-LT crash is more than double of the increase rate of fatalities in Car-Car crash in most scenarios. *PATP* policy results in highest increase in the

fatalities in LT-LT crash (annual average of 3.64%) while *PAYD* leads to lowest rate of increase (1.96%).

Due to increasing share of light trucks and thereby increasing fatalities from LT-LT crashes, the share of fatalities in car-car crashes keeps decreasing while that of LT-LT keeps increasing. Fatalities from Car-LT crash take up about 54% of the total fatalities from all types of two-vehicle crashes with about 4 times larger fatalities of occupants in cars than of occupants in light trucks. *PATP* policy shows lowest fatalities in car-LT crashes compared to baseline scenario while *CAFE* policy shows increase in fatalities in car-LT crashes showing the smallest effect on reducing fatalities.

There seems to be small difference between the share of the actual (or historical) and the mathematically computed two-vehicle crash by crash type. The increase in crashes between same vehicle type (i.e., car-car and truck-truck) are also due to the difference of the conditional probabilities of two-vehicle crash by crash type. The actual share from observed data is lower than the computed ones in car-car and truck-truck crashes while the actual probability of car-truck crash is higher by about 0.045 than the computed probability causing decreased the number of vehicles (and occupants) being involved in car-truck (or truck-car) crashes.

4.7.4 A C

Assuming VSL or Value of Statistical Life as \$5.5 million and WTP or Willingness To Pay as \$29,792, we compute about \$208 billion of accident costs from fatalities and injuries in 2008 in baseline scenario. The costs increases up to \$363.1 billion in case of *CAFE* policy scenario in 2030, which is almost the same costs as the baseline scenario. When we look at the cost changes in index term it looks similar to the changes of fatalities since VSL and WTP are assumed fixed. The total accident costs are smaller than the baseline scenario in all scenarios except *CAFE*

policy scenario (Figure 4.5 (a)).

The costs of the lives lost from traffic crashes increase from 66.1% up to 66.5% of total accident costs (Figure 4.5 (b)), showing the same pattern as fatality rates in Figure 4.3.

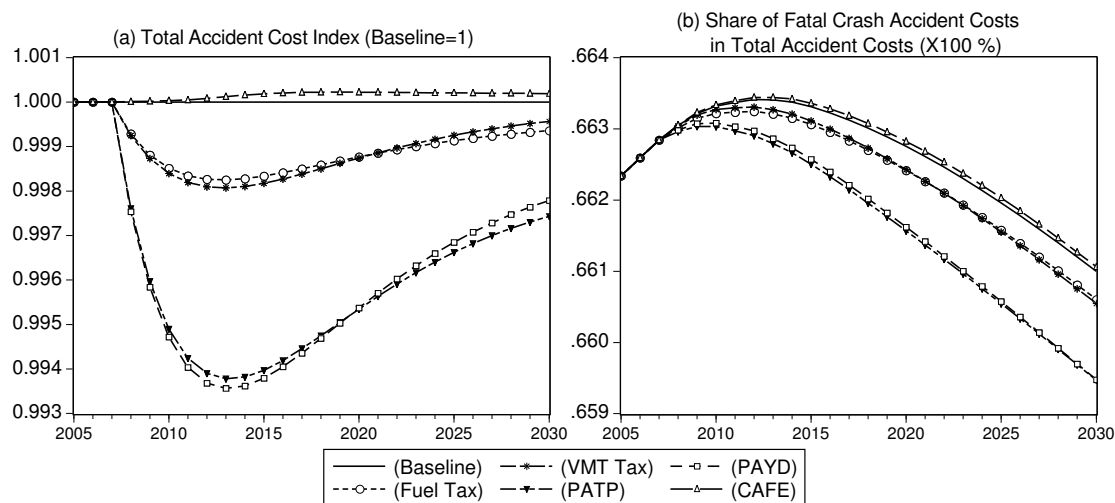

Figure 4.5: Traffic Accident Costs

4.7.5 R S

Table 4.2 compares the simulation results in average over 2005-2030. *CAFE* scenario shows almost the same in the share of light trucks and in the number of total fatalities. The problem of *CAFE* scenario is that the improved fuel efficiency in light trucks leads to an increase in the share of light trucks and it may cause an increase in fatalities of two-vehicle crashes. *PATP* and *PAYD* policy decrease the share of light trucks and total number of fatalities and thus decrease in accident costs as well. Fuel Tax and VMT Tax policy shows almost no difference in impacts on traffic safety.

Table 4.2: Summary of simulation results (Average over 2005-2030)

Policy	Veh. miles (A) (billion miles)	Share of LT (%)	Fatalities (B) (person)	Total Accident costs (\$ in billion)
Baseline	3,743.28	49.68	32,286	268.038
Fuel Tax	3,739.96	49.37	32,238	267.756
VMT Tax	3,739.98	49.27	32,239	267.758
PATP	3,730.94	48.65	32,112	266.992
PAYD	3,731.05	48.58	32,116	267.006
CAFE	3,743.76	49.71	32,293	268.080

The trend of increasing demand for light trucks has resulted in the higher rate of increase in motor fuel consumption by offsetting the fuel economy improvements in motor vehicle engine technology. The higher demand and consumption of motor fuel raised a concern regarding energy security along with the unstable international oil prices. Thus many policy options are being considered to reduce transportation fuel consumption not only to enhance the country's energy dependency but also to help to reduce greenhouse gas emissions, to improve air quality, and to reduce other driving-related external costs.

Another concern raised from the shift toward light trucks is safety issue because of higher fatality risk of occupants in smaller and lighter cars compared to the risk of larger and heavier light truck occupants. Many policy options considered here would cause changes in per-mile vehicle costs of driving and the cost changes, in turn, would affect vehicle usage and vehicle stock (and its composition) through changes in consumers' preference of vehicle choice. This research examined the impacts of transportation energy policies on traffic safety through an analytical traffic accident model reflecting possible changes in the probabilities of accident of different type of vehicles (i.e., cars and light trucks) and different crash type (i.e., single-vehicle crashes and two-vehicle crashes). The simulations of policy options are done through a model which fully integrates three inter-related economic demand decisions: size of vehicle stock, use of the vehicle stock, and energy efficiency. The changes in vehicle miles and vehicle stock from each policy scenario are decomposed by vehicle type along with the changes regarding traffic safety.

The results show ongoing trend of increase in the light truck share of new vehicle sales in all scenarios. Higher per-mile driving costs from *Fuel Tax*, *PATP*, and *PAYD* policies would cause people to choose more fuel efficient vehicles (i.e., cars) and thus those policy options would lead to slow growth rate of the share of light trucks. Meanwhile, *VMT Tax* policy does not have any incentive to purchase fuel efficient vehicles so the policy would cause an increase in the share of light trucks. *CAFE* regulation policy also slightly increases the share of light trucks compared to the baseline scenario due to the lower per-mile driving cost.

Fuel consumption will decrease compared to the baseline scenario in all scenarios except *VMT Tax* policy. The higher share of light trucks and relatively lower fuel economy of light trucks would result in more fuel consumption in *VMT Tax* policy even though the policy contributes to reductions in vehicle miles. The highest decrease in fuel consumption is achieved by *PATP* policy scenario, about 7.2% decrease in average from the baseline scenario result, followed by *PAYD* (2.1%), *Fuel Tax* (2.1%), and *CAFE* (0.9%), while *VMT Tax* shows increase in 2.6% in average over 2008-2030.

Regarding traffic accident fatalities, the results show that total average fatalities of each policy option will decrease from the baseline scenario except *CAFE* policy. In *CAFE* policy scenario, the lower per-mile driving cost would increase vehicle usage, which means more exposure of drivers (and occupants) to traffic crash risk and would cause more fatalities. In terms of total fatality rates per vehicle miles traveled, *CAFE* policy shows almost the same fatality rate as the baseline scenario. *PATP* and *PAYD* policy result in the lowest fatality rate compared to the baseline scenario. But the change in accident costs is very small, which is less than 1% from the baseline scenario, since the total fatalities change very little as we see in Figure 4.3 (a). Also the gap between a new policy option and the baseline scenario decreases leading to just 0.4% decrease in total accident costs over 2005–2030 in

case of *PATP* policy.

The share of fatalities of car occupants, either in single crashes or in two vehicle crashes involving at least a car, will keep decreasing while the share of fatalities of light truck occupants will keep increasing. Fatalities from car-car crash are higher than baseline scenarios in *PATP* and Fuel Tax policy and lower in *VMT Tax*, *CAFE* scenario. *PAYD* policy has lower fatalities than the baseline scenario over the simulation period. On the contrary, *VMT Tax* and *CAFE* policy result in higher fatalities in LT-LT crashes while other policies have lower fatalities than the baseline scenario. Fatalities from Car-LT crash take up about 54% of the total fatalities from all types of two-vehicle crashes with about 4 times larger fatalities of occupants in cars than of occupants in light trucks.

The results may provide guidance as to which would improve energy dependency while reducing undesirable side effects related to traffic safety since the results of this study may contain an element to predict aggregate vehicle stock and how that in turn affects vehicle use. It may be used and adapted for other uses in analyzing regional policies, such as the greenhouse-gas regulations in a state or federal policies.

Since the simulations are based on the projections of exogenous variables to future years, the results may be inherently uncertain. In addition, the simulation model does not incorporate the congestion factor. The projected increase in vehicle miles may lead to increase in congestion and this would raise the travel time. As a future extension of this study, it needs to consider new per-mile costs of driving including time costs.

For the simulation model in this research can be used and adapted for the analysis of each state level policy impacts by vehicle type, it is crucial to collect the decomposed vehicle miles and vehicle stock by vehicle type. Along with the data by vehicle type it would provide a tool for potential use in analyzing regional

policies. It also can be extended by empirically estimating the social welfare impacts from policy changes.

A

A E R S E

We estimate the full structural model based on system (3.1) and Table A.1 shows the estimation results. Formally, then, the system is the following:

$$\begin{aligned}(vma)_t &= \alpha^m(vma)_{t-1} + \alpha^{mv}(vehstock)_t + \beta_1^m(pm)_t + \beta_3^m X_t^m + u_t^m, \\(vehstock)_t &= \alpha^v(vehstock)_{t-1} + \alpha^{vm}(vma)_t + \beta_1^v(pv)_t + \beta_2^v(pm)_t + \beta_3^v X_t^v + u_t^v, \\(fint)_t &= \alpha^f(fint)_{t-1} + \alpha^{fm}(vma)_t + \beta_1^f(pf)_t + \beta_2^f(cafe)_t + \beta_3^f X_t^f + u_t^f,\end{aligned}\quad (\text{A.1})$$

with error terms following the rule

$$u_t^k = \rho_t^k u_{t-1}^k + \epsilon_t^k, \quad k=m, v, f. \quad (\text{A.2})$$

See Small and Van Dender (2007) for data sources and detailed description of how the variables were generated and estimated.

Table A.1: Estimation Results of System Equations (3.1) Using 3SLS

Vehicle Usage Equation			Vehicle Stock Equation			Fuel Intensity Equation		
Variable	Coefficient	Std. Error	Variable	Coefficient	Std. Error	Variable	Coefficient	Std. Error
vma(t-1)	0.7971	0.0119	vehstock(t-1)	0.8623	0.0148	fint(t-1)	0.8517	0.0127
vehstock	0.0254	0.0093	vma	0.0332	0.0169	vma+pf	-0.0170	0.0055
pm	-0.0378	0.0037	pv	0.0306	0.0343	cafe	-0.0898	0.0123
pm*pm	-0.0223	0.0063	pm	0.0007	0.0062	inc	-0.0017	0.0161
pm*inc	0.0782	0.0120	inc	0.0146	0.0167	pop/adult	-0.0263	0.0667
pm*Urban	0.0243	0.0101	adults/road-mile	-0.0273	0.0070	Urban	<i>-0.1094</i>	0.0581
inc	0.1037	0.0134	Trend	0.0007	0.0007	D7479	-0.0107	0.0047
adults/road-mile	-0.0218	0.0044	interest	0.0072	0.0047	Trend66-73	-0.0007	0.0011
pop/adult	0.1854	0.0369	licenses/adult	0.0411	0.0166	Trend74-79	-0.0040	0.0012
Urban	-0.1073	0.0498				Trend80+	-0.0022	0.0004
Railpop	-0.0039	0.0061						
D7479	-0.0436	0.0035	constant	-0.2500	0.1709	constant	-0.2663	0.0726
Trend	0.0008	0.0003	rho	-0.1136	0.0263	rho	-0.1490	0.0221
constant	1.9046	0.1172						
rho	-0.0866	0.0219						
No. obs.	1,887		No. obs.	1,887		No. obs.	1,887	
Adj. R-squared	0.9821		Adj. R-squared	0.9572		Adj. R-squared	0.9599	
S.E. of regression	0.9814		S.E. of regression	0.0401		S.E. of regression	0.0415	
D-W stat.	1.9687		D-W stat.	2.0204		D-W stat.	2.0037	

Notes:

1. Bold or italic type indicates the statistical significance at the 5% or 10% level, respectively.
2. Estimates of fixed effects coefficients (one for each state except Wyoming) are not shown.
3. Variables starting with lower case are in logarithm and those with upper case are its level value.

B

- Ahmad, S., & Greene, D. L. (2005). Effect of fuel economy on automobile safety: A reexamination. *Transportation Research Record, 1941*(1), 1–7.
- Anderson, P. S. K., William P., & Miller, E. J. (2003). Urban form, energy and the environment: A review of issues, evidence and policy. *Urban Studies, 31*(10), 961–976.
- Austin, D., & Dinan, T. (2005). Clearing the air: The costs and consequences of higher cafe standards and increased gasoline taxes. *Journal of Environmental Economics and Management, 50*(3), 562–582.
- Bento, A. M., & Goulder, L. H. (2003). An equilibrium model for analyzing automobile fuel-use and pollution policies. Working Paper, University of California, Santa Barbara.
- Bento, A. M., Goulder, L. H., Cropper, M., Moborak, M., & Vinha, K. (2005a). The impact of urban spatial structure on travel demand in the united states. *Review of Economics and Statistics, 87*(3), 466–478.
- Bento, A. M., Goulder, L. H., Henry, E., Jacobsen, M. R., & von Haefen, R. H. (2005b). Distributional and efficiency impacts of gasoline taxes: An econometrically based multi-market study. *American Economic Review: Papers and Proceedings, 95*(2), 282–287.
- Bezdek, R. H., & Wendling, R. M. (2005). Potential long-term impacts of changes in us vehicle fuel efficiency standards. *Energy Policy, 33*(3), 407–419.
- Blincoe, L. J., & (NHTSA), U. S. N. H. T. S. A. (2002). The economic impact of motor vehicle crashes, 2000. NHTSA technical report.
- Bode, S. (2006). Long-term greenhouse gas emission reductions—what’s possible, what’s necessary? *Energy Policy, 34*(9), 971–974.
- Bose, R. K., & Srinivasachary, V. (1997). Policies to reduce energy use and environmental emissions in the transport sector : A case of delhi city. *Energy Policy, 25*(14-15), 1137–1150.
- Boyd, J. H., & Mellman, R. E. (1980). The effect of fuel economy standards on the u.s. automotive market: An hedonic demand analysis. *Transportation Research Part A: General, 14*(5-6), 367–378.
- Brozović, N., & Ando, A. W. (2005). Defensive purchasing, the safety (dis)advantage of light trucks, and motor-vehicle policy effectiveness. Working Paper, University of Illinois at Urbana-Champaign.

- Choo, S., & Mokhtarian, P. (2004). What type of vehicle do people drive? the role of attitude and lifestyle in influencing vehicle type choice. *Transportation Research Part A: Policy and Practice*, 38(3), 201–222.
- Communications, W. (2006). *Ward's Motor Vehicle Facts and Figures*. Ward's Communications.
- Congressional Budget Office (CBO) (2002). Reducing gasoline consumption: Three policy options. Tech. rep., Congressional Budget Office.
- Congressional Budget Office (CBO) (2003). The economic costs of fuel economy standards versus a gasoline tax. Tech. rep., Congressional Budget Office.
- Dargay, J., & Gately, D. (1997). Vehicle ownership to 2015: Implications for energy use and emissions. *Energy Policy*, 25(14-15), 1121–1127.
- DeCicco, J. M. (1995). Projected fuel savings and emissions reductions from light-vehicle fuel economy standards. *Transportation Research Part A: Policy and Practice*, 29(3), 205–228.
- Edlin, A. S. (2003). *Per-mile premiums for auto insurance*, (pp. 53–82). Economics for an Imperfect World: Essays In Honor of Joseph Stiglitz. MIT Press.
- Elvik, R. (2000). How much do road accidents cost the national economy? *Accident Analysis & Prevention*, 32(6), 849–851.
- Evans, L. (1984). Accident involvement rate and car size. *Accident Analysis & Prevention*, 16(5-6), 387–405.
- Evans, L. (1994). Driver injury and fatality risk in two-car crashes versus mass ratio inferred using newtonian mechanics. *Accident Analysis & Prevention*, 26(5), 609–616.
- Evans, L. (2004). *Traffic safety*. Bloomfield, Mich.: Science Serving Society.
- Evans, L., & Frick, M. C. (1993). Mass ratio and relative driver fatality risk in two-vehicle crashes. *Accident Analysis & Prevention*, 25(2), 213–224.
- Evans, L., & Wasielewski, P. (1983). Risky driving related to driver and vehicle characteristics. *Accident Analysis & Prevention*, 15(2), 121–136.
- Fels, M. F. (1982). Transportation energy policy in the 1980's. *Energy Conversion and Management*, 22(4), 317–328.
- Fullerton, D., & West, S. (2006). *Public Finance Solutions to Vehicle Emissions Problems in California*. The Berkeley Electronic Press. Available at <http://www.bepress.com/fullertonwest>.
- Gayer, T. (2004). The fatality risks of sport-utility vehicles, vans, and pickups relative to cars. *Journal of Risk and Uncertainty*, 28(2), 103–133.

- Geller, H., Harrington, P., Rosenfeld, A. H., Tanishima, S., & Unander, F. (2006). Polices for increasing energy efficiency: Thirty years of experience in oecd countries. *Energy Policy*, 34(5), 556–573.
- Geltner, D. (1985). Transport and energy in developing countries. *Energy Policy*, 13(4), 340–344.
- Godek, P. E. (1997). The regulation of fuel economy and the demand for "light trucks". *The Journal of Law and Economics*, 40(2), 495–510.
- Golob, T. F., & Brownstone, D. (2005). The impact of residential density on vehicle usage and energy consumption. Tech. rep., University of California Energy Institute. University of California Energy Institute. Policy & Economics. Paper EPE-011. Available at <http://repositories.cdlib.org/ucei/policy/EPE-011>.
- Gómez-Ibánñez, J. A. (1991). A global view of automobile dependence – cities and automobile dependence: An international sourcebook by peter w. g. newman and jeffrey r. kenworthy. *Journal of the American Planning Association*, 57(3), 376–379.
- Gordon, H. R., Peter, & Wong, H. (1986). The distribution of population and employment in a polycentric city: the case of los angeles. *Environment and Planning A*, 18(2), 161–173.
- Greene, D. L. (1979). State differences in the demand for gasoline: An econometric analysis. *Energy Systems ad Policy*, 3(2), 191–212.
- Greene, D. L., Meddeb, N., & Liu, J.-T. (1986). Vehicle stock modelling of highway energy use : Tunisian and us applications. *Energy Policy*, 14(5), 437–446.
- Greening, L. A., Greene, D. L., & Difiglio, C. (2000). Energy efficiency and consumption – the rebound effect – a survey. *Energy Policy*, 28(6-7), 389–401.
- Greenspan, A., & Cohen, D. (1999). Motor vehicle stocks, scrappage, and sales. *Review of Economics and Statistics*, 81(3), 369–383.
- Harrington, W. (1997). Fuel economy and motor vehicle emissions. *Journal of Environmental Economics and Management*, 33(3), 240–252.
- Kavalec, C., & Woods, J. (1999). Toward marginal cost pricing of accident risk: the energy, travel, and welfare impacts of pay-at-the-pump auto insurance. *Energy Policy*, 27(6), 331–342.
- Kenworthy, F., Jeff Laube (1999). A global review of energy use in urban transport systems and its implications for urban transport and land-use policy.
- Kirby, E. G. (1995). An evaluation of the effectiveness of us cafe policy. *Energy Policy*, 23(2), 107–109.

- Kleit, A. N. (1990). The effect of annual changes in automobile fuel economy standards. *Journal of Regulatory Economics*, 2(2), 151–172.
- Lave, C. (1998). 25 years of u.s. energy policy: successes, failures, and some general lessons for public policy.
- Levinson, D. M., & Kumar, A. (1997). Density and the journey to work. *Growth and Change*, 28(2), 147–172.
- Litman, T. (2005). Efficient vehicles versus efficient transportation. comparing transportation energy conservation strategies. *Transport Policy*, 12(2), 121–129.
- loh Lin, A., Botsas, E. N., & Monroe, S. A. (1985). State gasoline consumption in the usa : An econometric analysis. *Energy Economics*, 7(1), 29–36.
- Mogridge, M. J. H. (1985). Transport, land use and energy interaction. *Urban Studies*, 22(6), 481–492.
- National Research Council (NRC) (2002). *Effectiveness and impact of corporate average fuel economy (CAFE) standards*. Washington, D.C.: National Academy Press.
- Nivola, P. S., & Crandall, R. W. (1995). *The extra mile : rethinking energy policy for automotive transportation*. Washington, D.C.; New York: The Brookings Institution; The Twentieth Century Fund Inc.
- Noland, R. B. (2005). Fuel economy and traffic fatalities: multivariate analysis of international data. *Energy Policy*, 33(17), 2183–2190.
- Office, U. N. E. P. I. . E. (1995). *Energy savings in the transport sector*, vol. 25. Paris, France: United Nations environment Programme, Industry and Environment.
- Parry, I., & Small, K. A. (2005). Does britain or the united states have the right gasoline tax? *American Economic Review*, 95, 1276–1289.
- Parry, I. W. H. (2004). Comparing alternative policies to reduce traffic accidents. *Journal of Urban Economics*, 56(2), 346–368.
- Parry, I. W. H. (2005). Is pay-as-you-drive insurance a better way to reduce gasoline than gasoline taxes? *American Economic Review*, 95(2), 288–293.
- Parry, I. W. H. (2007). Are the costs of reducing greenhouse gases from passenger vehicles negative? *Journal of Urban Economics*, 62(2), 273–293.
- Parry, I. W. H., Fischer, C., & Harrington, W. (2004). Should corporate average fuel economy (cafe) standards be tightened? Tech. rep., Resources for the Future. Discussion Paper 04-53.
- Patterson, M. G. (1996). What is energy efficiency? : Concepts, indicators and methodological issues. *Energy Policy*, 24(5), 377–390.

- Plotkin, S. E., & Greene, D. (1997). Prospects for improving the fuel economy of light-duty vehicles. *Energy Policy*, 25(14-15), 1179–1188.
- Plourde, C., & Bardis, V. (1999). Fuel economy standards in a model of automobile quality. *Energy Economics*, 21(4), 309–319.
- Portney, P. R., Parry, I. W. H., Gruenspecht, H. K., & Harrington, W. (2003). Policy watch: The economics of fuel economy standards. *The Journal of Economic Perspectives*, 17(4), 203–217.
- Quinet, E. (2004). A meta-analysis of western european external costs estimates. *Transportation Research Part D: Transport and Environment*, 9(6), 465–476.
- Roson, R., & Small, K. A. (1998). *Environment and transport in economic modelling*, vol. ECGY 10. Dordrecht ; Boston: Kluwer Academic Publishers.
- Ross, M., & Wenzel, T. (2001). Losing weight to save lives: A review of the role of automobile weight and size in traffic fatalities. Tech. Rep. LBNL–48009, American Council for an Energy-Efficient Economy (ACEEE).
- Small, K., & Verhoef, E. T. (2007). *The Economics of Urban Transportation*. Routledge.
- Small, K. A., & Van Dender, K. (2005). A study to evaluate the effect of reduced greenhouse gas emissions on vehicle miles traveled. Tech. rep., California Air Resources Board. Final report prepared for California Air Resources Board, Research Division and California Energy Commission.
- Small, K. A., & Van Dender, K. (2007). Fuel efficiency and motor vehicle travel: The declining rebound effect. *The Energy Journal*, 28(1), 25–51.
- Thorpe, S. G. (1997). Fuel economy standards, new vehicle sales, and average fuel efficiency. *Journal of Regulatory Economics*, 11(3), 311–326.
- Toy, E. L., & Hammitt, J. K. (2003). Safety impacts of suvs, vans, and pickup trucks in two-vehicle crashes. *Risk Analysis*, 23(4), 641–650.
- U.S. Department of Energy (DOE) (2007). *Transportation Energy Data Book: Edition 26*. Oak Ridge National Laboratory.
- U.S. EPA (1998). Technical methods for analyzing pricing measures to reduce transportation emissions. Tech. rep., U.S. Environmental Protection Agency. USEPA Report #231-R-98-006.
- Verhoef, E. (1994). External effects and social costs of road transport. *Transportation Research Part A: Policy and Practice*, 28(4), 273–287.
- Viscusi, W. K., & Aldy, J. E. (2003). The value of a statistical life: A critical review of market estimates throughout the world. *Journal of Risk and Uncertainty*, 27(1), 5–76.

- White, M. J. (2004). The "arms race" on american roads: The effect of sport utility vehicles and pickup trucks on traffic safety. *The Journal of Law and Economics*, 47, 333–355.
- Whitty, J., Svadlenak, J., & Capps, D. (2006). Public involvement and road user charge development: Oregon's experience. Tech. rep., Oregon Department of Transportation.
- Wood, D. P. (1997). Safety and the car size effect: A fundamental explanation. *Accident Analysis & Prevention*, 29(2), 139–151.
- Yun, J. M. (2002). Offsetting behavior effects of the corporate average fuel economy standards. *Economic Inquiry*, 40(2), 260–270.