

---

## Ethosomes: A Novel Vesicular Carrier for Enhanced Transdermal Delivery of an AntiHIV Agent

---

S. JAIN, R. B. UMAMAHESHWARI, D. BHADRA AND N. K. JAIN\*  
Pharmaceutics Research Laboratory, Department of Pharmaceutical Sciences  
Dr. Hari Singh Gour University, Sagar-470003.

Zidovudine is a potent antiviral agent acting on acquired immunodeficiency virus. Orally administered zidovudine, however has strong side effects. Therefore an adequate zero order delivery of zidovudine is desired to maintain expected anti-AIDS effect. In the present study we encapsulated the zidovudine, in recently developed novel vesicular carrier ethosomes, for its enhanced transdermal delivery and results were compared with liposomes. Ethosomes of zidovudine were prepared and characterized *in vitro* and *in vivo*. The effect of different formulation variables on skin permeation of zidovudine was studied using locally fabricated Keshry-Chien type of diffusion cell. To understand the mechanism of better skin permeation of ethosomes, vesicle skin interaction study was carried out. To confirm the better skin permeability of ethosomes, fluorescence microscopy using rhodamine 123 as fluorescence probe was performed. Results were compared with those obtained after administration of liposomes and hydroethanolic and ethanolic solution of drug. The optimized ethosomal formulation showed transdermal flux  $78.5 \pm 2.5 \mu\text{g}/\text{cm}^2/\text{h}$  across the rat skin as compared to  $5.2 \pm 0.5 \mu\text{g}/\text{cm}^2/\text{h}$  for control hydroethanolic solution of drug, and  $7.2 \pm 0.6 \mu\text{g}/\text{cm}^2/\text{h}$  for ethanolic drug solution. Vesicle skin interaction study showed that ethosomes affected the ultrastructure of the *stratum corneum*, distinct regions with lamellar stacks derived from the vesicle were observed in intercellular spaces of the stratum corneum. These lamellar stacks disrupted the organization of the skin bilayers leading to increased skin permeability. This was further confirmed by fluorescence microscopy. Finally, it can be concluded from the study that complex lipid molecule, ethosomes can increase the transdermal flux, prolong the release and present an attractive route for the sustained delivery of zidovudine. Our results indicate that the ethosomal system may be a promising candidate for transdermal delivery of number of problematic drug molecules.

Zidovudine (azidothymidine), the first antiHIV compound approved for clinical use, is still widely used for treatment of AIDS and AIDS-related complex, either alone or in combination with other antiviral agents. However, the main limitation to therapeutic effectiveness of zidovudine is its dose dependent hematological toxicity and very short biological half-life, high first pass metabolism and poor bioavailability<sup>1</sup>. After oral administration, it is rapidly

absorbed from the gastrointestinal tract with a peak plasma concentration of  $1.2 \mu\text{g}/\text{ml}$  at  $0.8 \text{ h}^2$ . It is also rapidly metabolized to the inactive glucuronide with a mean elimination half-life ( $t_{1/2}$ ) of 1 h thus necessitating frequent administration of large doses (200 mg/every 4 h) to maintain therapeutic drug levels. Since zidovudine acts as a metabolic antagonist of thymidine, the antiviral effect of zidovudine can be time dependent. Therefore, an adequate zero order delivery of zidovudine is desired to maintain expected antiAIDS effect and to avoid the strong side affect, which may be attributed to an exceeded plasma level of zidovudine

---

\*For correspondence

E-mail: jnarendr@yahoo.co.in

immediately after intravenous or oral administration. Therefore, to maintain effective plasma concentration and to avoid sub-therapeutic and toxic concentrations, a continuous delivery of zidovudine is required. Because of the high first pass metabolism, oral sustained delivery may not be a good option. Transdermal route is, therefore, a better alternative, to achieve constant plasma levels, which additionally warrants less frequent dosing regimen.

In spite of several advantages offered by transdermal route, only a few drug molecules are administered transdermally because of the formidable barrier nature of Stratum corneum (SC). Since, zidovudine is relatively polar molecule with a log P 0.09<sup>3</sup>, its transdermal permeability is poor and below the level necessary to achieve a therapeutic effect. In past several approaches were used to increase the transdermal permeability of zidovudine e.g. Kim and Chien<sup>4</sup> studied the effect of vehicle on transdermal permeability of zidovudine, Oh *et al.*<sup>5</sup> reported the enhanced transdermal delivery of zidovudine by iontophoresis, Seki *et al.*<sup>6</sup> studied the effect of different penetration enhancers on transdermal delivery of zidovudine. But all the above mentioned approaches are not able to increase the skin permeation of zidovudine to the desired extent.

To overcome the difficulties of poor skin permeability, recently two vesicular carrier systems transfersomes<sup>7</sup> and ethosomes<sup>8</sup> have been reported for effective transdermal delivery of drugs. A new type of drug carrier, ethosomes, can circumvent this problem by providing non-invasive delivery of the pharmaceuticals across the skin. Ethosomal system is a vesicular system composed mainly of phospholipids, [phosphatidylcholine (PC), phosphatidylserine (PE), phosphatidic acid, phosphatidylethanolamine (PE)], alcohol (ethanol or isopropyl alcohol) in relatively high concentration, sometimes glycols (polyols) and water. Unlike classic liposomes, that are known mainly to deliver drugs to outer layers of skin, ethosomes were shown to enhance permeation through the stratum corneum barrier. The basic difference between the liposomes and ethosomes is their composition. Ethosomes contain relatively high concentration of ethanol that is responsible for their better skin permeation ability. An important characteristic of ethosomes is enhanced skin permeability for various compounds. Ethosomal system is vesicular in nature, depending on the ratio of components and the chemical structure of the phospholipids can be comprised of very small entities (nm). This drug carrier is already reported for the effective transdermal delivery of acyclovir<sup>9</sup>, trihexyphenidyl, minoxidil and testosterone<sup>10</sup>.

In our previous study we reported the transfersomes as a carrier for transdermal delivery of drugs<sup>11-13</sup>. Thus in the present study the vesicular approach has been extended to the ethosomes, which are reported to have superior skin penetration ability as compared with liposomes and niosomes. In the present study we encapsulated the zidovudine into novel vesicular carrier ethosomes and the main aim of this study was to optimize the ethosomal formulation with respect to sustained transdermal delivery of zidovudine and study the possible mechanism of better skin permeation of ethosomes.

## MATERIALS AND METHODS

Zidovudine was received as a gift sample from M/s Cipla Ltd., Mumbai, Soyaphosphatidyl choline (PC), sephadex-G-50, Triton-X 100, phosphotungstic acid, rhodamine 123 (1,2-dihexadecyl -rac -glycerol 3, phosphoethanolamine-N-rhodamine) were purchased from Sigma Chemicals, St. Louis, MO USA., Ethanol, propylene glycol, butanol, xylene, acetonitrile, methanol and chloroform were procured from E. Merck, Mumbai. Inert cellulose membrane MWCO of 12000-14000 was purchased from Himedia, Ltd., Mumbai. Eosin and Hematoxylin were purchased from Loba Chemie, Mumbai. All other reagents used in the study were of analytical grade.

### Method of preparation:

The ethosomal formulation was prepared according to the method reported by the Touitou *et al.*<sup>8</sup>. The ethosomal system prepared here were comprised of 0.5-4% phospholipids, 10-50% ethanol, drug, 10% propylene glycol and water to 100% w/w. Phospholipid and drug or fluorescence probe (rhodamine 123), were dissolved in ethanol-propylene glycol mixture. The mixture was heated to 30° in a water bath. The double distilled water heated to 30° was added slowly in a fine stream with constant mixing (Mechanical stirrer, Remi Equipment, Mumbai) at 700 rpm in a closed vessel. Mixing was continued for an additional 5 min. The system was kept at 30° throughout the preparation. The preparation was sonicated at 4° using probe sonicator (at 40 W, Imeco, Ultrasonics, Mumbai) in 3 cycles of 5 min with 5 min rest between the cycle. The final lipid and drug concentration in all ethosomal formulations were 0.5-4% w/w and 0.4 % w/w, respectively.

Liposomal formulation that was used as a control in the present study was prepared by the Cast film method<sup>14</sup>. Soya PC and cholesterol were dissolved in minimum quantity of chloroform: methanol mixture (3:1 v/v) in a round bottom

flask. The organic solvent was removed in a rotary evaporator (Yorco, New Delhi) under reduced pressure to form a thin film on the wall of the flask. Final traces of solvent were removed under vacuum, overnight (Vacuum oven, Jyoti Scientific Ltd., Gwalior). The deposited lipid films were hydrated with PBS solution of drug at 60 rev/min for 1 h at room temperature. The resulting vesicle suspension was sonicated at 4° using probe sonicator (at 40 W, Imeco, Ultrasonics, Mumbai) in 3 cycles of 5 min with 5 min rest between the cycle. The final lipid and drug concentration in liposomal formulation were 2% w/w and 0.4 % w/w, respectively.

#### **Vesicular characterization:**

Ethosome vesicles were visualized using a Transmission Electron Microscope, with an accelerating voltage of 100 kv. A drop of the sample was placed on to a carbon coated copper grid to leave a thin film. Before the film dried on the grid, it was negatively stained with 1% phosphotungstic acid (PTA). A drop of the staining solution was added on to the film and the excess of the solution was drained off with a filter paper. The grid was allowed to air dry thoroughly and samples were viewed in a transmission electron microscope. The vesicles size and size distribution were determined by Dynamic Light Scattering method (DLS), using a computerized inspection system (Malvern Zetamaster, ZEM 5002, Malvern, UK) and Turbidity of different ethosomal formulations was determined by using the Nephelometer (Superfit, Ambala), taking PBS (pH 6.5) as blank.

#### **Entrapment efficiency:**

The entrapment efficiency was determined after separation of the untrapped drug by the minicolumn centrifugation method<sup>15</sup>. Sephadex G-50 was swollen in distilled water at room temperature, with occasional shaking, for at least 5 h after which the gel was formed and stored at 4°. To prepare the minicolumn, Whatman paper pads were placed at the bottom of the barrels of 1 µl syringe, which were filled with the gel. Excess water was removed by centrifugation at 3000 rev min<sup>-1</sup> for 3 min and 200 µl ethosomes suspension was applied drop wise to the center of the column. Followed by centrifugation as before and collection of vesicles, distilled water was added to the minicolumn and centrifugation was repeated. Ethosomes (depending on their type and size) can be recovered from the first or the second stage of centrifugation. Here two stages were necessary to recover the vesicles. No free drug remained (tested by its absence in the centrifugate after

application of saturated drug solution instead of the vesicles), when a saturated drug solution was used instead of the ethosomes suspensions, the entire drug remained bound to the gel. This confirmed that there would be no free drug present after recovering the vesicles. The amount of drug entrapped in the vesicles was then determined by disrupting the vesicles using 0.1% Triton X- 100, filtered it and drug amount determined spectrophotometrically.

#### ***In vitro* drug release (skin permeation study):**

The *in vitro* skin permeation of zidovudine from ethosomal formulation was studied using locally fabricated diffusion cell. The effective permeation area of the diffusion cell and receptor cell volume was 1 cm<sup>2</sup> and 10 ml, respectively. The temperature was maintained at 37±1°. The receptor compartment contained 10 ml PBS (pH 6.5) and was constantly stirred by magnetic stirrer (Expo India Ltd., Mumbai, India) at 100 rpm. Sprague Dawley rat skin (4 to 5 w old) was mounted between the donor and the receptor compartments. The ethosomal formulation (1 ml) was applied to the epidermal surface of the rat skin. Samples were withdrawn through the sampling port of the diffusion cell at predetermined time intervals over 24 h and analyzed by HPLC assay. The receptor phase was immediately replenished with equal volume of fresh diffusion buffer. Sink conditions was maintained throughout the experiment. After 24 h the skin was cleaned on both sides and the drug accumulated in the skin was extracted with ethanol and drug concentration was determined by HPLC assay. Triplicate experiments were conducted for each study. *In vitro* skin permeation studies were conducted for different formulations and effect of variation in composition on permeation rate was also studied. *In vitro* drug release study from ethosomal formulation was repeated with cellulose membrane using the same method as described above. Permission of the Institutional Animal Ethical Committee was obtained for all animal experimentation as per the approved protocol.

#### **Vesicle skin interaction study:**

Male Sprague Dawley rats weighing (80-100 g) were divided into three groups of three each. First group served as control, received the topical application of aqueous drug solution; second and third groups received the optimized ethosomes and liposomes formulation, respectively. Ethosomes and liposomal formulation were applied topically to rats. After 6 h of application the rats were sacrificed, skin was removed, cut into small pieces and fixed into the fixative solution (3:1, absolute alcohol: chloroform) for 3 h, the skin pieces were then transferred to absolute alcohol for half an

hour and then in absolute alcohol and xylene for 1 h. The wax scrapings were added in this solution till saturation and were kept for 24 h. After 24 h, the paraffin blocks were made by embedding the tissue in hard paraffin, matured at 62°. The sections were cut using microtome (Erma optical works, Japan) at 5 µm, stained with eosin and hematoxyline and histological changes in stratum corneum and epidermis were examined under optical microscope (Leica, DMLB, Heerbrugg, Switzerland)<sup>16</sup>.

#### Fluorescence microscopy:

Fluorescence microscopy was performed to confirm the penetration ability of ethosomes in comparison to liposomes. The fluorescence labeling was carried out by preparing the ethosomal formulation according to the method described earlier in the presence of fluorescence marker Rhodamine-123. Fluorescence marker loaded formulation was applied topically to rats. After 3 h of application the rats were sacrificed, skin was removed, cut into small pieces, fixed by the conventional procedure as described earlier in the vesicle skin interaction study section and examined under a fluorescence microscope (Leica, DMRBE, Heerbrugg, Switzerland).

#### HPLC Assay:

The quantitative determination of zidovudine was performed by HPLC using acetonitrile in 0.1% acetic acid (25/75 v/v) as mobile phase delivered at 1.0 ml/min by LC 10-AT vp pump (Shimadzu, Japan). Twenty five microlitres of injection volume was eluted in LUNA 54, C18, 4.6 C 150 mm, column (Phenomex, USA) at room temperature. The column eluant was monitored at 265 nm using SPD-M10A vp diode array UV detector (Shimadzu, Japan)<sup>17</sup>.

#### Statistical analysis:

Data are expressed as the mean±standard deviation (SD) of the mean and statistical analysis was carried out employing the student's t test using the software PRISM (Graphpad). A value of P<0.005 was considered statistically significant.

#### RESULTS AND DISCUSSION

Ethosomal carrier is a system containing soft vesicles and are composed mainly of phospholipids (phosphatidylcholine PC), ethanol in relatively high concentration and water. The composition of different ethosomal formulations was shown in Table 1. It has been commonly believed that high concentrations of ethanol are detrimental to liposomal formulations. Therefore, when liposomes are prepared from ethanolic solution of phospholipids, much care is taken to remove the remaining traces of alcohol, if at all alcohol is usually found in final liposomal compositions. Data presented here indicate that phospholipids, ethanol at relatively high concentration and water form vesicular systems with enhanced skin permeation properties. Visualization by transmission electron microscopy showed that ethosomes have a lamellar vesicular structure and this confirms the existence of vesicular structure at higher concentration of ethanol (fig. 1). The effect of phospholipids and ethanol concentration on the size distribution of ethosomes vesicles was investigated using Dynamic Light Scattering (DLS) method. The ethosomal formulation prepared with 30% ethanol and 2% phospholipids showed an average vesicle size 161±6.0 nm with a very low polydispersity index (0.03). In the ethanol concentration range of 10-50%, the size of the vesicles decreased with increasing ethanol concentration, with the

TABLE 1: COMPOSITION OF DIFFERENT ETHOSOMAL FORMULATIONS

Formulation Code	Phospholipid (% w/w)	Ethanol (% w/w)	Propylene glycol (% w/w)	Cholesterol (% w/w)	Drug (% w/w)
ETE <sup>a</sup> <sub>1</sub>	2.0	10	10	-	0.4
ETE <sub>2</sub>	2.0	20	10	-	0.4
ETE <sub>3</sub>	2.0	30	10	-	0.4
ETE <sub>4</sub>	2.0	40	10	-	0.4
ETE <sub>5</sub>	2.0	50	10	-	0.4
LP <sup>b</sup>	2.0	-	-	0.15	0.4

a=Ethosomal formulation containing ethanol; b=Liposomal formulation.

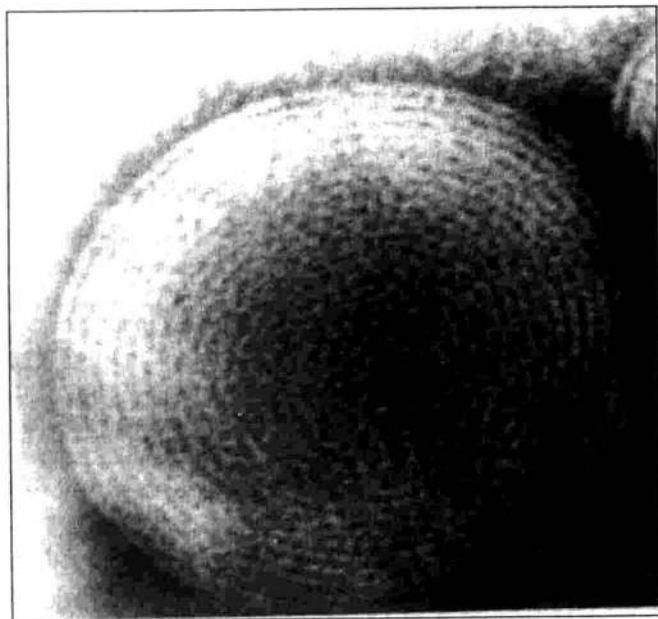

**Fig. 1: Transmission electron microscope photomicrograph of ethosomal formulation (x 180, 000) (Formulation code ETE<sub>3</sub>).**

largest particles in preparation containing 10% ethanol (235±8.0 nm) and the smallest in preparation containing 50% ethanol (91±1.5 nm) (Table 2). By comparison, conventional liposomes, made from the same phospholipids by the film forming method and containing no ethanol, had an average size of (388±14 nm). The dependence of vesicle size on phospholipids content was determined for ethosomes formulation containing 30% ethanol and phospholipids concentration range from 0.5-4.0%. It can be seen in fig. 2 that ethosomes size exhibits a limited dependence on phospholipids concentration. An eight fold increase in phospholipids concentration from 0.5 to 4% resulted in

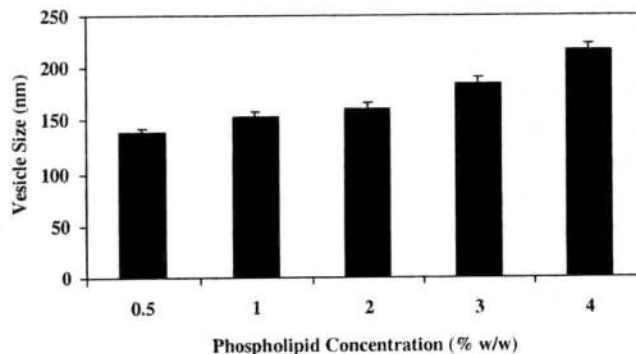

**Fig. 2: Effect of phospholipids concentration on the size of ethosomal vesicles as determined by DLS method (Formulation code ETE<sub>3</sub>). Values represented as mean±SD (n=3).**

insignificant increase in ethosomes size (from 128±2.5 to 216±3.1 nm).

The entrapment efficiency of zidovudine in ethosomes and in traditional liposomes were calculated as percent total drug entrapped using the minicolumn centrifugation method. This method gives the quantity of drug, in three different regions of the vesicular system; the quantity adsorbed onto the vesicle membrane, the quantity incorporated into the membrane bilayer, and the quantity incorporated in the internal core phase. The entrapment efficiency of zidovudine in ethosomes and liposomes was found to be 62.3±2.1 and 41.4±1.7%, respectively (Table 2). The relative high entrapment of zidovudine can be explained by the high lamellarity throughout the vesicles to the core and by the presence of ethanol. The data indicated that the entrapment efficiency depends on the ethanol concentration. Increasing the ethanol to 30% w/w, increased in the entrapment efficiency and with further increased in the ethanol

**TABLE 2: CHARACTERIZATION OF DIFFERENT ETHOSOMAL FORMULATIONS**

Formulation Code	Vesicle Size (nm)	PI <sup>a</sup>	Entrapment efficiency	Turbidity (N.T.U.)
ETE <sub>1</sub>	235±8.0	0.034	55.6±1.7	288±5.0
ETE <sub>2</sub>	182±6.5	0.035	58.1±1.8	315±4.5
ETE <sub>3</sub>	161±6.0	0.037	62.3±2.1	342±7.0
ETE <sub>4</sub>	103± 2.5	0.024	27.3±0.9	115±3.5
ETE <sub>5</sub>	91±1.5	0.016	23.2±0.8	102±3.0
LP	388±14	0.036	41.4±1.7	341±9.0

Values represented as mean ± SD (n=3). a=polydispersity index=Standard Deviation/Vesicle Size.

TABLE 3: SKIN PERMEATION PROFILE OF DIFFERENT FORMULATIONS OF ZIDOVUDINE CALCULATED FROM IN VITRO DRUG RELEASE STUDY THROUGH A RAT SKIN (AFTER 24 H)

Formulation Code	Transdermal flux ( $\mu\text{g}/\text{cm}^2/\text{h}$ )	$Q^a$ ( $\mu\text{g}$ )	$P^b$ ( $\text{cm h}^{-1}$ )	$Re^c$	$R^d$	$ER^e$
ETE <sub>1</sub>	23.2±0.9	37.12±1.5	1.43·10 <sup>-3</sup>	699.3	0.9450	7.2
ETE <sub>2</sub>	49.8±1.6	79.68±3.1	3.08·10 <sup>-3</sup>	324.6	0.9523	15.4
ETE <sub>3</sub>	78.5±2.5	125.6±5.2	4.86·10 <sup>-3</sup>	205.7	0.9464	24.3
ETE <sub>4</sub>	18.6±0.8	29.76±1.1	1.15·10 <sup>-3</sup>	869.5	0.9454	5.7
ETE <sub>5</sub>	18.2±0.7	29.12±1.0	1.12·10 <sup>-3</sup>	892.8	0.9132	5.6
LP	6.1±0.7	9.90±0.6	9.90·10 <sup>-4</sup>	1010	0.9551	1.9
2 % PC in Etha.	10.2±0.8	16.32±0.8	0.63·10 <sup>-3</sup>	1587	0.8123	3.1
Ethanolic sol.	7.2±0.6	11.52±0.9	0.27·10 <sup>-3</sup>	3703	0.7235	2.2
30 % Ethanol in water	5.2±0.5	8.32±0.5	0.20·10 <sup>-3</sup>	5000	0.8213	1.6
Plain drug sol.	3.2±0.2	5.15±0.5	0.12·10 <sup>-3</sup>	8333		

Values represented as mean±SD (n=3).  $Q^a$ =Amount of drug deposited into the skin;  $P^b$ =Permeability coefficient;  $Re^c$ =Resistance=1/Permeability coefficient;  $R^d$ =Regression coefficient;  $ER^e$ =Enhancement ratio (ratio of transdermal flux from ethosomal formulation to plain drug solution).

concentration (>30% w/w) the vesicle membrane become more permeable that leads to decrease in the entrapment efficiency of ethosomal formulation (Table 2). The results of the turbidity measurement study also support this hypothesis as turbidity increased with increasing the ethanol concentration because at low (30 %) levels of ethanol it increase the fluidity of lipid bilayers resulting in increased turbidity of vesicle dispersion (Table 2). At higher ethanol concentration rapid decrease in the turbidity of vesicle dispersion occurred because after sublytic concentration of ethanol (optimum concentration) further increase in the ethanol concentration it solubilize the lipid bilayers that leads to decrease in the turbidity of vesicle dispersion.

The cumulative amount of drug permeated per unit area was plotted as a function of time and steady-state transdermal flux were calculated from the slope of the linear portion. The values of steady state transdermal flux for different ethosomal formulations were observed between 23.2±0.9  $\mu\text{g}$  to 78.5±2.5  $\mu\text{g}$  of drug/h/cm<sup>2</sup> area across the rat skin (Table 3). This value is substantially eight times, higher than that of the 2% phospholipids solution in ethanol (10.2±0.8  $\mu\text{g}/\text{h}/\text{cm}^2$ ), twelve times higher than that of the ethanolic solution of drug (7.2±0.6  $\mu\text{g}/\text{h}/\text{cm}^2$ ), fifteen times higher than that of the 30 % hydroalcoholic solution of drug (5.2±0.5  $\mu\text{g}/\text{h}/\text{cm}^2$ ), and nearly three times higher than the

previously reported value for the transdermal delivery of zidovudine by Oh *et al*<sup>6</sup>. The data suggests that the value of transdermal flux depends on the ethanol concentration. As the concentration of ethanol increased, transdermal flux of zidovudine increased up to 30% v/v (23.2±0.9  $\mu\text{g}/\text{h}/\text{cm}^2$  to 78.5±2.5  $\mu\text{g}/\text{h}/\text{cm}^2$ ) and further increase in the ethanol concentration significantly decreased the transdermal flux. The reason for this is the deteriorating effect of ethanol on the lipid bilayers at higher concentration of ethanol. The statistical significant difference in the transdermal flux value between ethosomal formulation and ethanolic solution of drug clearly indicated that the ethosomal system is much more effective permeation enhancer than ethanol alone (7.2±0.6  $\mu\text{g}/\text{h}/\text{cm}^2$ ), aqueous ethanolic solution (5.2±0.5  $\mu\text{g}/\text{h}/\text{cm}^2$ ) or an alternate phospholipids solution (10.2±0.8  $\mu\text{g}/\text{h}/\text{cm}^2$ ) and liposomes (6.1±0.7  $\mu\text{g}/\text{h}/\text{cm}^2$ ).

Overall, the data clearly indicates that the ethosomal system is effective at delivering the drug molecule deeply into and through the skin, when tested, ethosomal preparations were much more effective permeation enhancer than ethanol, 30% hydroalcoholic solution or an ethanolic phospholipids solution (fig. 3). The enhancement properties of the ethosomal carrier were also reported previously for minoxidil, progesterone<sup>8</sup> and trihexyphenidyl<sup>10</sup>.



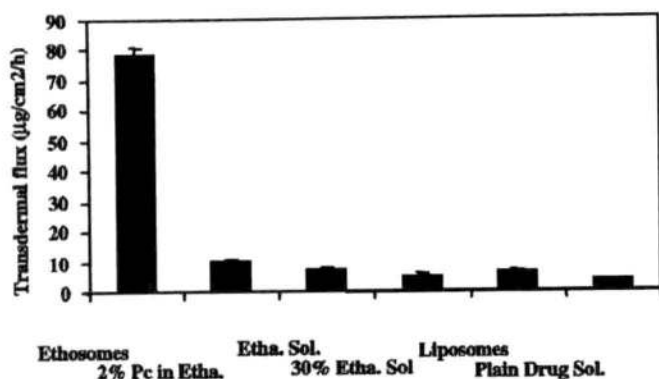

Fig. 3: Transdermal flux of zidovudine through the rat skin from ethosomal formulation (ETE<sub>3</sub>) and control system. Value represent as mean±SD (n=3).

Ethanol has long been known to have permeation enhancement properties. However, the permeation enhancement from ethosomes observed in this work is much greater than would be expected from ethanol alone (Table 3), suggesting some kind of synergistic mechanism between ethanol, vesicles and skin lipids. Thus, the effects of ethanol, which were considered harmful to classic liposomal formulations, may provide the vesicles with soft flexible characteristic, which allow them to more easily penetrate into deeper layers of the skin.

Another contribution to the high skin permeation from the ethosomal system could be made by the interaction of ethanol and of phospholipids vesicles with the stratum corneum. Such types of interaction was also proposed by Kirjavainen *et al.*<sup>19</sup>. It has also been suggested that mixing of phospholipids with the SC lipids of the intracellular layers enhances the permeability of the skin<sup>20</sup>.

When ethosomal carriers, which contain ethanol, and soft small vesicles are applied to the skin a number of concomitant processes may take place, involving the stratum corneum and pilosebaceous pathway. Evidence of existence of the follicular transport pathway taken by lipid vesicles was reported<sup>9,21</sup>. Fig. 4 illustrates a hypothetical model of how ethosomes may enhance penetration of drugs through the stratum corneum lipids. First, ethanol disturbs the organization of the stratum corneum lipid bilayer and enhances its lipid fluidity. The flexible ethosomes vesicles can then penetrate the disturbed SC bilayers and even forge a pathway through the skin by virtue of their particulate nature. The release of drug in the deep layers of the skin and its transdermal absorption could then be the result of fusion of ethosomes with skin lipids and drug release at

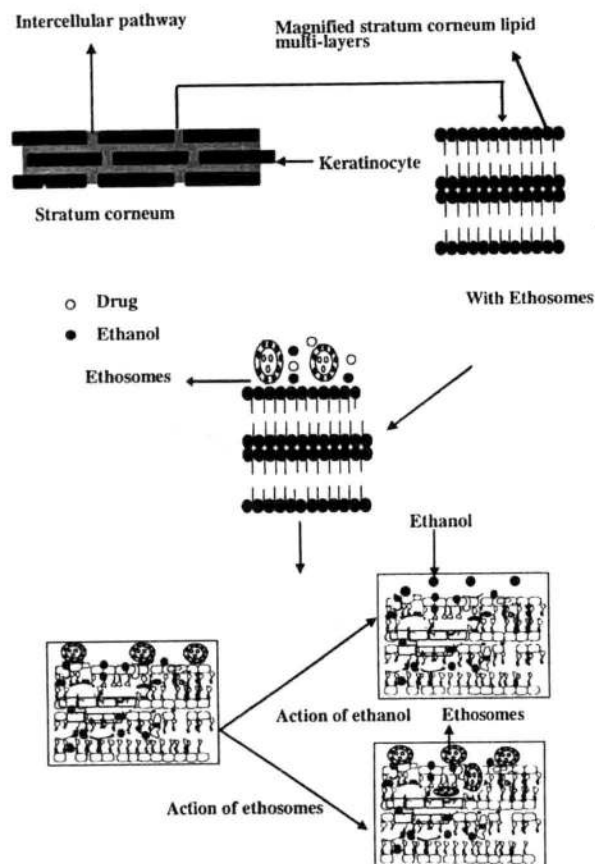

Fig. 4: Proposed mechanism for penetration of molecule from ethosomal system across the lipid domain of stratum corneum.

various points along the penetration pathway.

To support the above hypothesis histological studies were conducted in order to visualize the changes in the ultrastructure of the stratum corneum. When comparing the interaction of the ethosomes and liposomes with rat skin, *in vivo*, only the ethosomes affected the ultrastructure of the stratum corneum. No change in the ultrastructure of the viable tissue (epidermis or dermis) could be observed after treatment with any of the vesicle formulation. Treating the rat skin with the elastic vesicle (ethosomes) after 6 h, resulted in appearance of round and oval lamellar stacks in the intracellular spaces between the lipid bilayers (fig. 5b). The bilayers of these stacks are either oriented perpendicular to the intracellular bilayers of the skin when they are located in between the skin bilayers or oriented randomly when accumulated in the intracellular spaces. Their appearance is different from intact unilamellar vesicles, which are characterized by a spherical bilayer. The presence of

lamellar stacks in the intracellular regions within the stratum corneum after treatment with ethosomes showed its skin permeation ability because the stratum corneum is the main resistance barrier for skin permeation of molecule. Treatment with liposomal formulation did not induce the formation of lamellar stacks (fig. 5a), which illustrates the importance of the presence of ethanol in the ethosomal formulation in the formation of these phase separated lamellar domains and this confirm the better skin permeation ability of ethosomes in comparison of liposomes<sup>22</sup>.

Significant prolongation of zidovudine release across the artificial membrane was achieved with the ethosomal formulation in comparison with the plain drug solution (fig. 6). The cumulative amount of zidovudine released in 24 h from the ethosomal formulation was  $38.4 \pm 1.2\%$  compared

with  $92.5 \pm 2.1\%$  from the control drug solution. Zidovudine release from the ethosomal formulation was steady and slow and decreased as a function of time<sup>23</sup>.

The ability of ethosomes to deliver drug molecule to the deeper layers of the skin was investigated by using a lipophilic fluorescence probe rhodamine 123 using fluorescence microscopy study. Using the fluorescence probe rhodamine 123 we are able to visualize the penetration of a lipophilic molecule into the skin from various carriers. Fluorescence photomicrograph of the skin after an 6 h application of rhodamine 123 loaded liposomal and ethosomal formulation are shown in fig. 7a and fig 7b, respectively. Penetration from classic liposomes was only to upper layer of skin (stratum corneum). Deep penetration from alcohol free liposomes was almost negligible (fig. 7a).

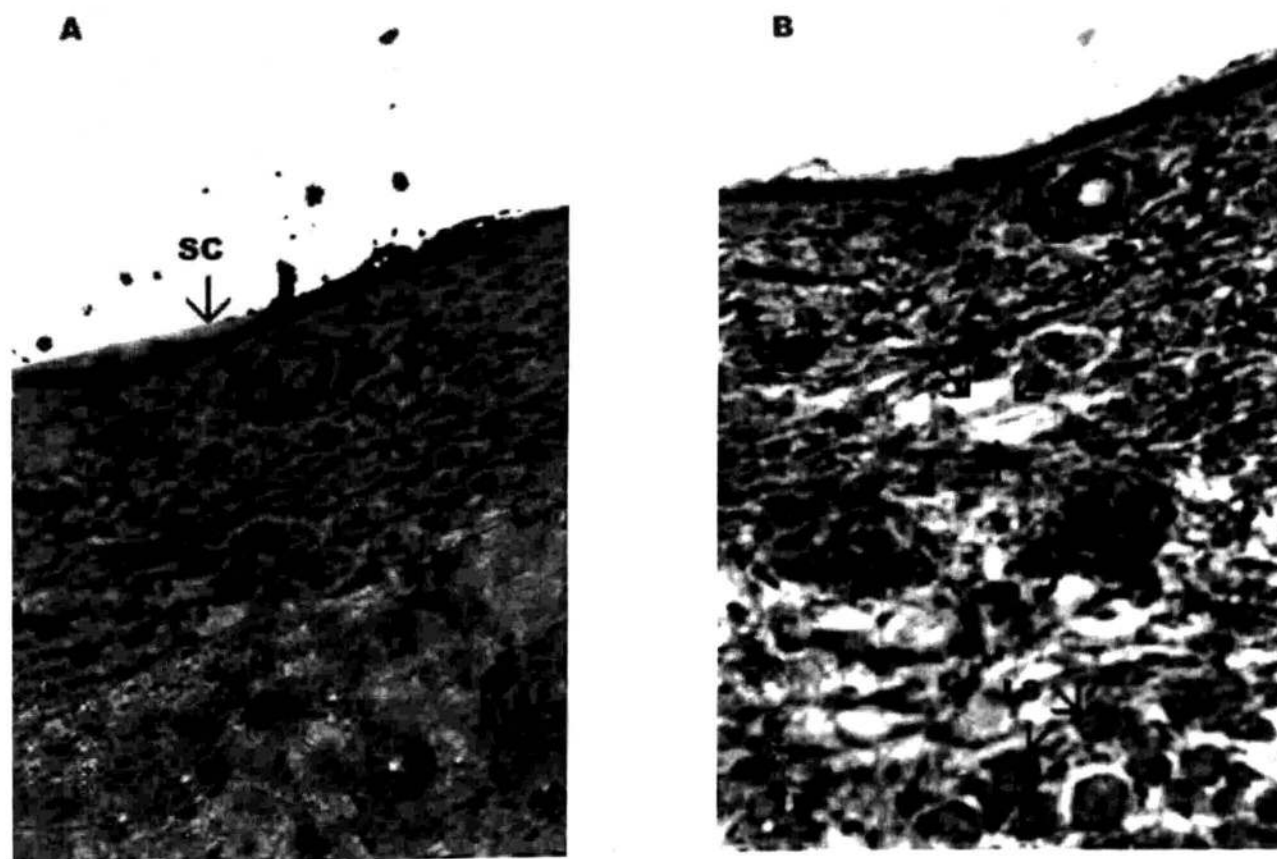

**Fig. 5: Effect of type of vesicle on the histology of the rat skin.**

**5a.** Microphotograph (x 450) of skin treated with the liposomal formulation for 6 h and shows the no changes in the normal histology of skin. SC=Stratum corneum. **5b.** Photomicrograph (x 450) of skin treated with the optimized ethosomal formulation for 6 h showing the presence of lamellar stacks (LS) of bilayers in intracellular space. Treatment with ethosomal formulation also caused the widening of intracellular space between lipid bilayers (arrowheads).



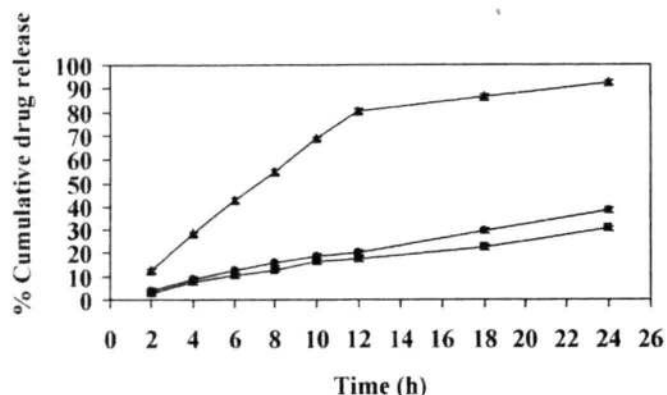

**Fig. 6: Comparative cumulative drug release of zidovudine.**

Cumulative drug release of zidovudine after 24 hr from ethosomal formulation (-●-), liposomal formulation (-■-) and plain drug solution (-▲-). Value represent as mean  $\pm$  SD (n =3).

In contrast enhanced delivery of rhodamine 123 in terms of depth and quantity (dermis layer) was observed using the ethosomal carrier (fig. 7b). Ethosomes were able to enhance penetration of relatively large quantities of probe deeply into the skin. These qualitative results were supported by the skin permeation studies of zidovudine.

Transdermal flux of zidovudine is increased nearly 15 times by encapsulation into ethosomes as compared to hydroalcoholic and ethanolic solutions of the drug. The effect of ethanol on stratum corneum lipids and on vesicle fluidity as well as a dynamic interaction between ethosomes and the stratum corneum all may contribute to the superior skin penetration ability of ethosomes. The results of the skin vesicle interaction study showed the importance of presence of ethanol in vesicle membrane in establishing disorganization of the skin lipid bilayers and subsequent increase in skin permeability. So finally it can be concluded from the result of present study that soft vesicle ethosomes improves the transdermal flux, prolongs the release and represent as an attractive carrier for sustained transdermal delivery of zidovudine. The ethosomal system was shown here to be a highly efficient carrier for enhanced zidovudine delivery through skin. The efficient skin permeation ability together with the sustained release characteristic make this system a promising candidate for transdermal delivery of number of problematic drug molecules.

#### ACKNOWLEDGEMENTS

Authors are grateful to M/s Cipla Ltd., India for providing Zidovudine as gift sample, AIIMS New Delhi, India for

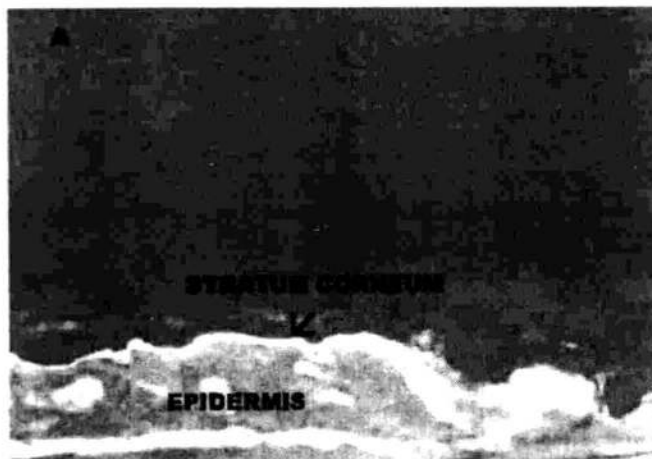

(a)

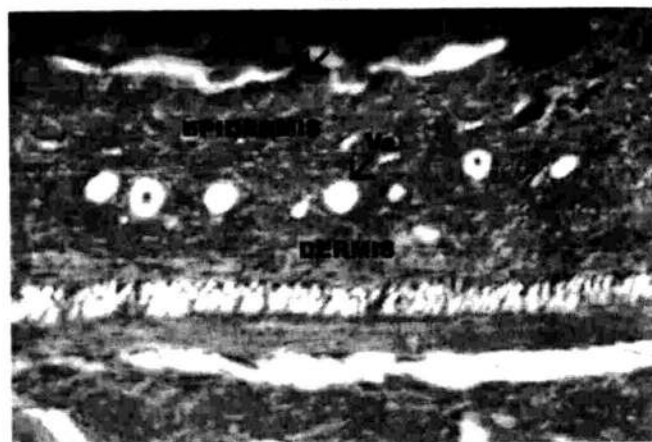

(b)

**Fig. 7: Fluorescence photomicrograph of rat skin after application of fluorescence probe Rhodamine 123.**

7a. Shows the deposition of fluorescence probe into top most layer of skin (stratum corneum), when applied in the form of liposomal formulation(x 100). 7b. Shows the deposition of fluorescence probe into the deeper layer of skin (dermis tissue) when applied in the form of ethosomal formulation (ETE). Ve stands for Vesicle.

Transmission Electron and Fluorescence Microscopy and Council for Scientific and Industrial Research (CSIR), New Delhi, India for providing financial support as Senior Research Fellowship to Subheet Jain.

#### REFERENCES

1. Kleburtz, K.D., Seidlin, M., Laobert, J.S., Dollis, R., Reicheras, R. and Valentine, T., *J. Acquir. Immuno. Defic. Syndrom.*, 1992, 5, 60.
2. Klecker, Jt. R.W., Collitus, J.M. and Myers, C.E., *Clin. Pharmacol.*, 1987, 41, 407.

3. Kumar, P.K., Sweet, D.E. and Lafoa, S., **Antimicrob. Agent. Chemother.**, 1999, 43, 603.
4. Kim, D.D. and Chien, Y.W., **J. Pharm. Sci.**, 1996, 85, 214.
5. Oh, S.Y., Joong, S.Y., Park, T.G. and Lee, J.H., **J. Control. Release**, 1998, 51, 161.
6. Seki, T., Kawaguachi, K., Juni, K. and Morimoto, Y., **J. Control. Release**, 1991, 17, 41.
7. Cevc, G., Schatzlein, A. and Blume, G., **J. Control. Release**, 1995, 36, 3-16.
8. Touitou, E., Dayan, N., Bergelson, L., Godin, B. and Eliaze, M., **J. Control. Release**, 2000, 65, 403.
9. Horwitz, E., Pisanty, S., Czerninski, R., Helser, M., Eliav, E. and Touitou, E., **Oral Surg. Oral Med. Oral Pathol. Oral radiol. Endod.**, 1999, 87, 700.
10. Touitou, E., Godin, B. and Weiss, C., **Drug Dev. Res.**, 2000, 50, 406.
11. Jain, S., Jain, P. and Jain, N.K., **Drug Dev. Ind. Pharm. (In press)**.
12. Jain, S., Jain, S. and Jain, N.K., **Drug Delivery Tech.**, 2002, 2, 70.
13. Jain, S., Sapre, R., Umamaheswari, R.B. and Jain, N.K., **Indian J. Pharm. Sci.**, 2003, 65, 652-661.
14. Bangham, A.D., Standish, M.M. and Workins, J.C., **J. Mol. Bio.**, 1965, 13, 138.
15. Fry, D.W., White, J.C. and Goldman, I.D., **J. Anal. Biochem.**, 1978, 90, 809.
16. Berge vanden, B.A.I., Wertz, P.W., Junginger, H.E. and Bouwstra, J.A., **Int. J. Pharm.**, 2001, 217, 13.
17. Seki, T., Kawaguchi, T., Sugibayashi, K., Juni, K. and Morimoto, Y., **Int. J. Pharm.**, 1989, 57, 73.
18. Dayan, N. and Touitou, E.M., **Biomaterials**, 2000, 21, 1879.
19. Kirjavainen, M., Urtti, A., Valjakka-Koskela, R., Kiesvaara, J. and Monkkonen, J., **Eur. J. Pharm. Sci.**, 1999, 7, 279.
20. Blume, A., Jansen, M., Gihyczy, M. and Garels, J., **Int. J. Pharm.**, 1993, 99, 219.
21. Touitou, E., Dayan, N., Bergelson, L., Levi-Schaffer, F. and Pilponsky, A., **Lipid Res.**, 1998, 8, 113.
22. Touitou, E., Alkabes, M., Dayan, N., **Pharm. Res.**, 1997, S14, 305.
23. Touitou, E., **US Patent No.**, 5540,934, 1996.