

2010-01-01

Experimental Demonstration of a Simple Displacement Sensor Based on a Bent Singlemode-Multimode-Singlemode (SMS) Fiber Structure

Qiang Wu

Technological University Dublin, qiang.wu@tudublin.ie

Yuliya Semenova

Technological University Dublin, yuliya.semenova@tudublin.ie

Pengfei Wang

Technological University Dublin, pengfei.wang@tudublin.ie

See next page for additional authors

Follow this and additional works at: <https://arrow.tudublin.ie/engscheceart>



Part of the [Electrical and Computer Engineering Commons](#)

Recommended Citation

Wu, Q. et al. (2010) Experimental Demonstration of a Simple Displacement Sensor Based on a Bent Singlemode-Multimode-Singlemode (SMS) Fiber Structure, *Measurement Science and Technology*, Vol. 22, no 2. doi:10.1088/0957-0233/22/2/025203

This Article is brought to you for free and open access by the School of Electrical and Electronic Engineering at ARROW@TU Dublin. It has been accepted for inclusion in Articles by an authorized administrator of ARROW@TU Dublin. For more information, please contact arrow.admin@tudublin.ie, aisling.coyne@tudublin.ie.



This work is licensed under a [Creative Commons Attribution-NonCommercial-Share Alike 4.0 License](#)
Funder: Science Foundation Ireland under grant no. 07/SK/I1200.

Authors

Qiang Wu, Yuliya Semenova, Pengfei Wang, Agus Hatta, and Gerald Farrell

Experimental demonstration of a simple displacement sensor based on a bent *singlemode-multimode-singlemode* (SMS) fiber structure

Qiang Wu, Yuliya Semenova, Pengfei Wang, Agus Muhamad Hatta, Gerald Farrell

Photonics Research Center, School of Electronic and Communications Engineering, Dublin Institute of Technology, Kevin Street, Dublin 8, Ireland (e-mail: qiang.wu@dit.ie).

Abstract: A simple displacement sensor based on a bent singlemode-multimode-singlemode (SMS) fiber structure is proposed and experimentally investigated. The sensor offers a wider displacement range, not limited by the risk of fiber breakage, as well as a three-fold increase in displacement sensitivity by comparison with a straight SMS structure sensor. This sensor can be interrogated by either an optical spectral analyzer (OSA) or a ratiometric interrogation system: (1) if interrogated by an OSA assuming a resolution of 1 pm, it has a sensitivity of 28.2 nm for a displacement measurement range from 0 to 280 μm ; (2) if interrogated by a ratiometric interrogation system, it has worst and best case resolutions of 556 and 38 nm respectively, for a displacement measurement range from 0 to 520 μm .

Index Terms—singlemode-multimode-singlemode fiber, optical sensing

I. Introduction

Optical fiber sensors have many advantages such as immunity to electromagnetic interference, the possibility of remote operation and ease of fabrication. Recently, displacement sensing has been proposed for applications in growth areas such as estimation of metal surface roughness [1], vibration tests [2], determination of thickness of a transparent plate [3], buildings structural monitoring [4] etc. A fiber Bragg grating (FBG) based optical sensor [5-10] is the most common type of fiber sensor which has many advantages but suffers from a narrow measurement range for displacement, resulting in the need for a mechanical arrangement to improve the measurement range and a complex interrogation system to achieve high wavelength

measurement resolution. SMS fiber structures have also been proposed as strain sensors. A SMS fiber structure has a bandpass spectral response for a given wavelength range [11-13] and can be used as either a stand alone sensor or as an edge filter to interrogate an optical sensor such as a FBG sensor. Since a SMS fiber structure is much easier to fabricate than a FBG, a sensor based on a SMS fiber structure will be more economic than the one based on a FBG. A straight SMS fiber structure can be used as a displacement sensor, but in common with a FBG sensor, a straight SMS structure suffers from a narrow displacement range, due to the limited strain that can be applied to the fiber to avoid the risk of fiber breakage.

In this paper, we propose to use a bent SMS fiber structure to measure displacement. This technique offers the advantages of a much simpler configuration and ease of fabrication for the actual sensor with a wide measurement range and high resolution.

II. THEORETICAL ANALYSIS

A schematic diagram of a straight SMS fiber structure is shown in Fig. 1.

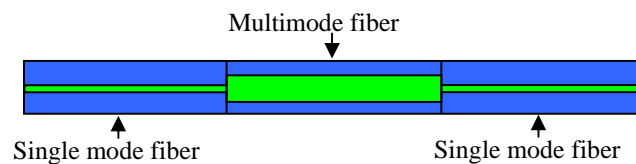

Fig. 1 Schematic diagram of a straight SMS fiber structure

The multimode fiber (MMF) in Fig. 1 has a step-index profile. The light injected into the MMF from a single mode fiber (SMF) will excite multiple modes propagating in the MMF. For a straight fiber, the refractive index along the propagation direction is symmetrically distributed. Using a 3D beam propagation method (BPM) with a semi-vectorial variation at a free space wavelength of 1550 nm, the calculated light propagation in the straight MMF section is shown in Fig. 2(a). In this simulation the MMF has a core diameter of 105 μm and a step index profile with refractive indices for the core and cladding of 1.4446 and 1.4271 respectively.

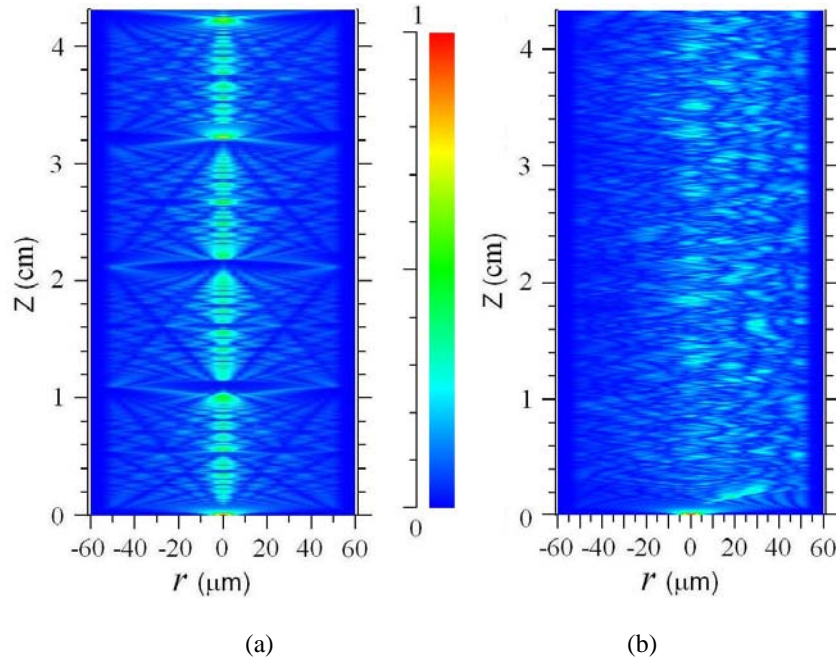

Fig. 2 Simulated light propagation within the MMF for (a) straight and (b) bent SMS fiber structure

Fig. 2(a) shows that as the propagation distance changes, the field profile also changes accordingly but remains symmetrically distributed along the propagation direction. Self-imaging takes place periodically at points along the propagation direction. When the length of the MMF section is made equal to a self-imaging distance the coupling efficiency of the SMS fiber structure is maximised and the SMS structure has a bandpass spectral response. In the example above the MMF length is circa 42 mm, equal to the self-imaging distance along the MMF fiber section length.

For a bent MMF, the refractive index distribution is no longer symmetric and must be defined by an equivalent refractive index distribution as follows [14]:

$$n = n_0 \left(1 + \frac{x}{R_{eff}} \right) \quad (1)$$

where $n_0(x,y)$ is the refractive index of the straight fiber and R_{eff} is the equivalent bend radius which can be expressed as follows [11]:

$$R_{eff} = \frac{R}{1 - \frac{n_0^2}{2} [P_{12} - \nu(P_{11} + P_{12})]} \quad (2)$$

where R is the bent radius of the fiber, ν is the Poisson ratio and P_{11} and P_{12} are components of the photoelastic tensor.

A simulation based on a 3D beam propagation method (BPM) for a bent SMS structure was also carried out at wavelength of 1550 nm. The propagation in the bent MMF is shown in Fig. 2(b). In this simulation, the bent diameter of the MMF portion is 54.8 mm. The length of the MMF section which undergoes a bend is estimated from the experimental setup to be 43 mm.

The simulated result in Fig. 2(b) provides a visual confirmation that a bend in a SMS fiber structure physically influences transmission within the MMF section. Fig. 2(b) shows that the field distribution in the bent fiber portion is asymmetric since the bent fiber has effectively an asymmetric refractive index distribution as illustrated in Eq. (1). The bend in the MMF section has a significant influence on the mode distribution in the SMS fiber structure, which in turn will have a profound effect on the overall transmission characteristics of the SMS structure.

III. A BENT SMS FIBER STRUCTURE INTERROGATED BY AN OSA

For a straight SMS structure, at the self-imaging position along the MMF there is a maximum output and the SMS fiber structure has a bandpass spectral response for a given wavelength range. The bandpass response is a result of multimode interference and recoupling within a SMS fiber structure. When axial strain is applied to a straight SMS fiber structure, the MMF length changes, the phase differences between these multiple modes change, and hence the spectral response of the SMS fiber structure changes. The measured spectral response of a SMS fiber structure (MMF length 42.1 mm) is shown in Fig. 3 for two values of axial strain.

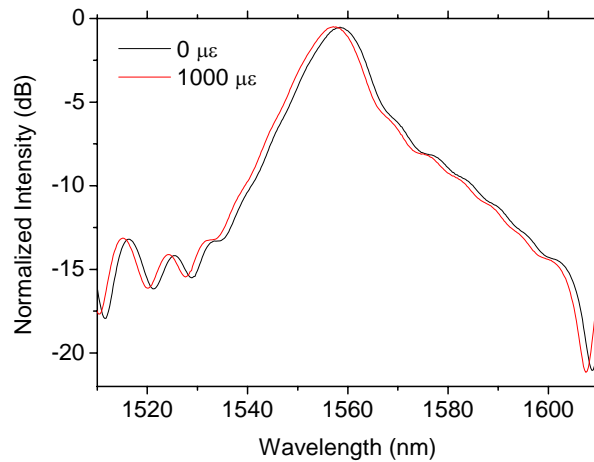

Fig. 3 Measured spectral response of SMS fiber structure

Fig. 3 shows that the straight SMS fiber structure has a bandpass spectral response and its central wavelength is sensitive to strain with a coefficient of $-1.28 \text{ pm}/\mu\epsilon$. In this experiment the total length of fiber subjected to strain was 100 mm, consisting of the MMF section with equal lengths of SMF fiber on each side. For a SMS fiber structure, the maximum allowed applied strain is normally less than $2000 \mu\epsilon$, to avoid risk of fiber breakage. Since the length of the fiber structure under strain is 100 mm, the estimated displacement range for this sensor will be $0 - 200 \mu\text{m}$ and the sensitivity will be $12.8 \text{ pm}/\mu\text{m}$. In order to

improve the sensitivity, a shorter length of fiber under strain could be used, such as 50 mm, but while the sensitivity will increase to 25.6 pm/ μm , the estimated measurement range will be decreased to 0 – 100 μm .

A bent SMS fiber structure in principle should allow for displacement measurement without the limitation imposed on the displacement range by the risk of excessive strain that occurs for a straight SMS structure. The key question however is whether the spectral response of the bent SMS structure is suitable for displacement sensing and can offer a competitive sensitivity. Preliminary results showed that the transmission response of the bent SMS fiber structure is very sensitive to bend diameter. To investigate this, an experimental setup using a bent SMS fiber structure for displacement sensing, where displacement changes the bend diameter, was used as shown in Fig. 4.

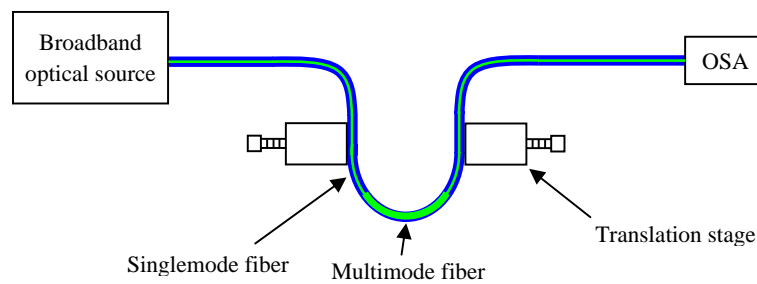

Fig. 4 Schematic of the experimental setup

A broadband optical source signal is used as an input to a bent SMS fiber structure, with the output measured by an OSA. The MMF portion of the SMS fiber structure is bent and the bent radius can be changed by using the translation stage. In our experiments, the single- and multimode fibers were SMF28 and AFS105/125Y respectively. The MMF section has a length of 42.1 mm. The initial bent diameter is 54.8 mm and the displacement was applied in 10 μm increments in a manner that decreases the bend diameter. The fiber is fixed by epoxy to the stages to reduce mechanically induced error, caused by unintentional movement of the fiber between the faces of the translation stages. The experimental results are shown in Fig. 5.

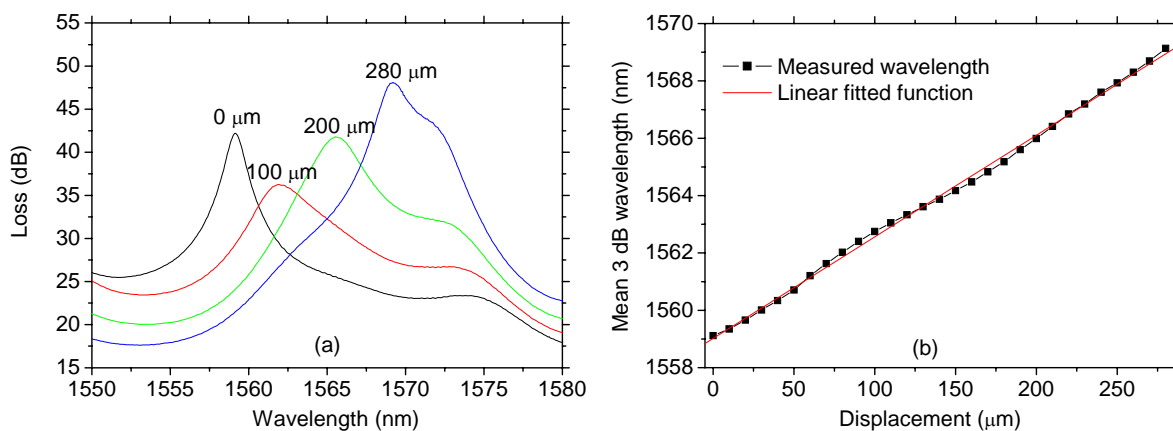

Fig. 5 Measured (a) spectral response at different displacements and (b) mean 3 dB wavelength response vs. displacement

Fig. 5(a) shows for four sample values of displacement that as displacement increases, the centre wavelength shifts to a longer wavelength. Fig. 5(b) shows the relationship between the mean 3 dB wavelength shifts and displacement. It is noted that since the spectral response for the SMS structure has a relatively broad peak, mean 3 dB wavelength is chosen instead of peak wavelength for measurement as it is known to be a more reliable OSA measurement parameter. A linear fit is applied to the measured curve in Fig. 5(b). The fitted function is $y = 0.0355x + 1559.017$, which displays a good linearity demonstrated by a linear regression value $R^2 = 0.998$. From Fig. 5(b) and the fitted function, it is easy to see that in the displacement measurement range from 0 to 280 μm , the sensitivity is 35.5 $\text{pm}/\mu\text{m}$, which is much higher than that of the straight SMS fiber structure, while still achieving a wider displacement range. Assuming the resolution of an OSA is 1 pm, the resolution of the displacement sensor will be 28.2 nm.

IV. A BENT SMS FIBER STRUCTURE IN A RATIOMETRIC INTERROGATION SYSTEM

The investigation above shows that a displacement sensor based on a bent SMS fiber and employing an OSA for interrogation can achieve very high resolution in a relatively large measurement range from 0 to 280 μm . Since an OSA is very expensive, an alternative approach is to use a cost effective ratiometric interrogation system to measure displacement [15]. A schematic diagram of a bent SMS fiber structure in a ratiometric interrogation system is shown in Fig. 6.

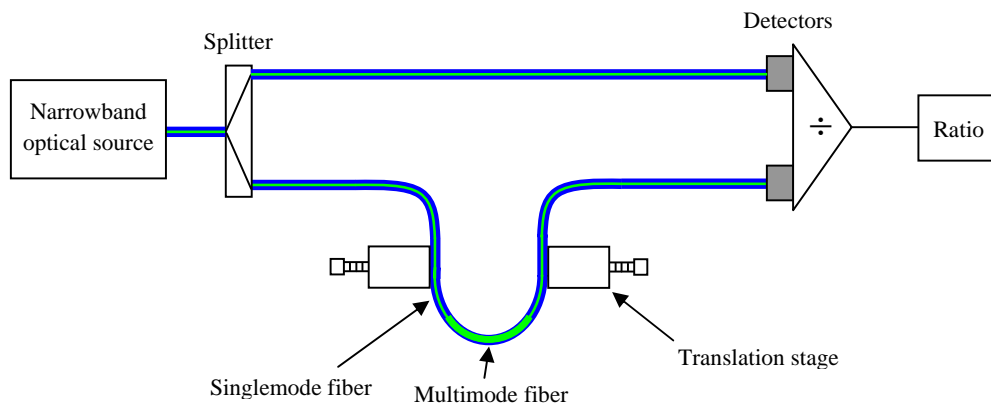

Fig. 6 Schematic diagram for a bent SMS fiber structure based displacement sensor in a ratiometric system

Fig. 6 shows a narrowband optical signal split into two parts: one arm goes directly to a photo detector as a reference signal to compensate for power variations in the optical source and another goes through a bent SMS fiber structure subjected to displacement and is detected by the second photo detector. Experimental investigations were carried out based on the above system. The initial bent diameter was selected as 55.60 mm. A signal reflected from a FBG with a central wavelength of 1529.85 nm and 3 dB bandwidth of 0.44 nm illuminated by a broadband optical source was used as the input narrowband

optical signal. Experimental investigations based on a ratiometric interrogation system were carried out by measuring the ratio response at 10 μm displacement intervals for the bent diameter range from 55.60 mm to 55.08 mm. Fig. 7 shows the experimental results for the measured ratio vs. displacement.

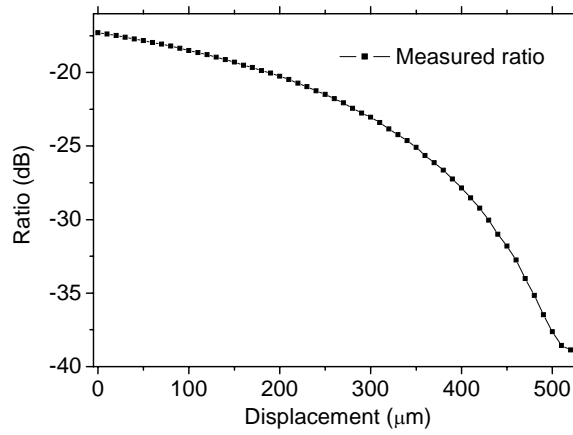

Fig. 7 Measured ratio vs. displacement

Fig. 7 shows that an increase in the displacement from 0 to 520 μm causes a monotonic decrease in the measured ratio. The slope of the measured ratio changes from its minimum value in the displacement range from 0 to 10 μm to its maximum in the range from 480 to 490 μm respectively.

To demonstrate the resolution of this system, incremental displacement step changes of 10 μm were applied to the bent SMS fiber structure over a time period of 1060 seconds. The corresponding measured ratio variation vs. time is shown in Fig. 8.

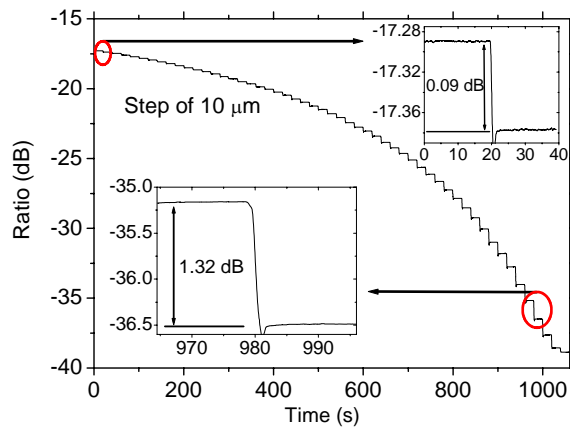

Fig. 8 Measured ratio variation vs. time with step change of 10 μm

Fig. 8 shows that the slope of the measured ratio ranges from 0.009 $\text{dB}/\mu\text{m}$ for low displacement values to 0.132 $\text{dB}/\mu\text{m}$ for larger displacements. For a ratiometric interrogation system, we can assume the minimum reliable detectable ratio variation is

equal to the peak-to-peak ratio fluctuation ΔR_{p-p} . If the slope of the ratio response of a system is S , then the system resolution will be equal to $\Delta R_{p-p} / S$. In our experiments the peak-to-peak ratio fluctuation was 0.005 dB, and the minimum and maximum slopes of the ratio response of the system were 0.009 and 0.132 dB/ μm respectively and hence the worst and best case resolutions are 556 and 38 nm respectively.

V. Conclusions

We have reported a simple displacement sensor based on a bent SMS fiber structure, which overcomes the limitations on displacement range imposed by using a straight SMS structure, while offering a three-fold increase in displacement sensitivity. We demonstrated that this sensor can be interrogated by an OSA with a sensitivity of 28.2 nm (assuming the OSA has resolution of 1 pm) in the displacement range from 0 to 280 μm . We also demonstrated that alternatively the sensor can be used in a ratiometric interrogation system with the worst and best case resolutions of 556 and 38 nm respectively, for a displacement range from 0 to 520 μm .

VI. Acknowledgements

The authors acknowledge the support of Science Foundation Ireland under grant no. 07/SK/I1200.

REFERENCES

- [1]. S. W. Harun, M. Yasin, H. Z. Yang, Kusminarto, Karyono, H. Ahmad, "Estimation of metal surface roughness using fiber optic displacement sensor", *Laser Physics*, vol. 20, no. 4, pp. 904-909, Apr. 2010
- [2]. A. Vallan, M. L. Casalicchio, G. Perrone, "Displacement and Acceleration Measurements in Vibration Tests Using a Fiber Optic Sensor", *IEEE Transactions on Instrumentation and Measurement*, vol. 59, no 5, Special Issue, pp. 1389-1396, May 2010
- [3]. D. Sastikumar, G. Gobi, B. Renganathan, "Determination of the thickness of a transparent plate using a reflective fiber optic displacement sensor", *Optics and Laser Technology*, vol. 42, no. 6, pp. 911-917, Sep. 2010
- [4]. N. Metje, D. N. Chapman, C. D. F. Rogers, P. Henderson, M. Beth, "An optical fiber sensor system for remote displacement monitoring of structures – Prototype tests in the laboratory", *Structural Health Monitoring – An International Journal*, vol. 7, no. 1, pp. 51-63, Mar. 2008
- [5]. K. C. Chuang, C. C. Ma, "Pointwise fiber Bragg grating displacement sensor system for dynamic measurements", *Applied Optics*, vol. 47, no. 20, pp. 3561-3567, July 2008
- [6]. J. H. Ng, X. Q. Zhou, X. F. Yang, J. Z. Hao, "A simple temperature-insensitive fiber Bragg grating displacement sensor", *Optics Communications*, vol. 273, no. 2, pp. 398-401, May 2007
- [7]. Q. Wu, Y. Semenova, A. Sun, P. Wang and G. Farrell, "High resolution temperature insensitive interrogation technique for FBG sensors", *Optics and Laser Technology*, vol. 42, no. 4, pp. 653-656, June 2010
- [8]. S. O. Silva, D. F. C. Peixoto, O. Frazão, P. M. G. P. Moreira, J. L. Santos and P. M. S. T. de Castro, "Fibre Bragg grating sensors for monitoring the metal inert gas and friction stir welding processes", *2010 Meas. Sci. Technol.* 21 085105
- [9]. S. O. Park, B. W. Jang, Y. G. Lee, C. G. Kim and C. Y. Park, "Simultaneous measurement of strain and temperature using a reverse index fiber Bragg

grating sensor”, 2010 Meas. Sci. Technol. 21 035703

- [10]. J. R. Lee , C. Y. Yun and D. J. Yoon, “A structural corrosion-monitoring sensor based on a pair of prestrained fiber Bragg gratings ”, 2010 Meas. Sci. Technol. 21 017002
- [11]. L. B. Soldano and E. C. M. Pennings, “Optical multi-mode interference devices based on self-imaging: Principles and applications,” J. Lightwave Technol., vol. 13, pp. 615–627, 1995.
- [12]. D. P. Zhou, L. Wei, W. K. Liu and J. W. Y. Lit, “Simultaneous strain and temperature measurement with fiber Bragg grating and multimode fibers using an intensity-based interrogation method”, IEEE Photonics Technology Letters, vol. 21, no. 7, pp. 468-470, Apr. 2008.
- [13]. Q. Wu, A. M. Hatta, Y. Semenova and G. Farrell, “Use of a SMS fiber filter for interrogating FBG strain sensors with dynamic temperature compensation”, Applied Optics, vol. 48, pp. 5451-5458, 2009
- [14]. R. T. Schermer, J. H. Cole, “Improved bend loss formula verified for optical fiber by simulation and experiment”, J. Quantum Electronics, vol. 43, no. 10, pp. 899-909, 2007
- [15]. Q. Wu, P. Wang, Y. Semenova, G. Farrell, “Influence of system configuration on a ratiometric wavelength measurement system”, Special Issue in Measurement Science and Technology, vol. 21, no. 9, 21 094013, 2010