

Experimental demonstration of wakefield effects in a THz planar diamond accelerating structure

Sergey Antipov

Euclid Techlabs

[ATF Program Advisory Committee and
the ATF Users' Meetings, April 26 - 27, 2012](#)

Wakefield Mapping

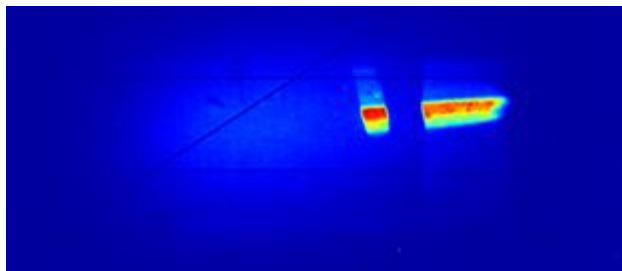
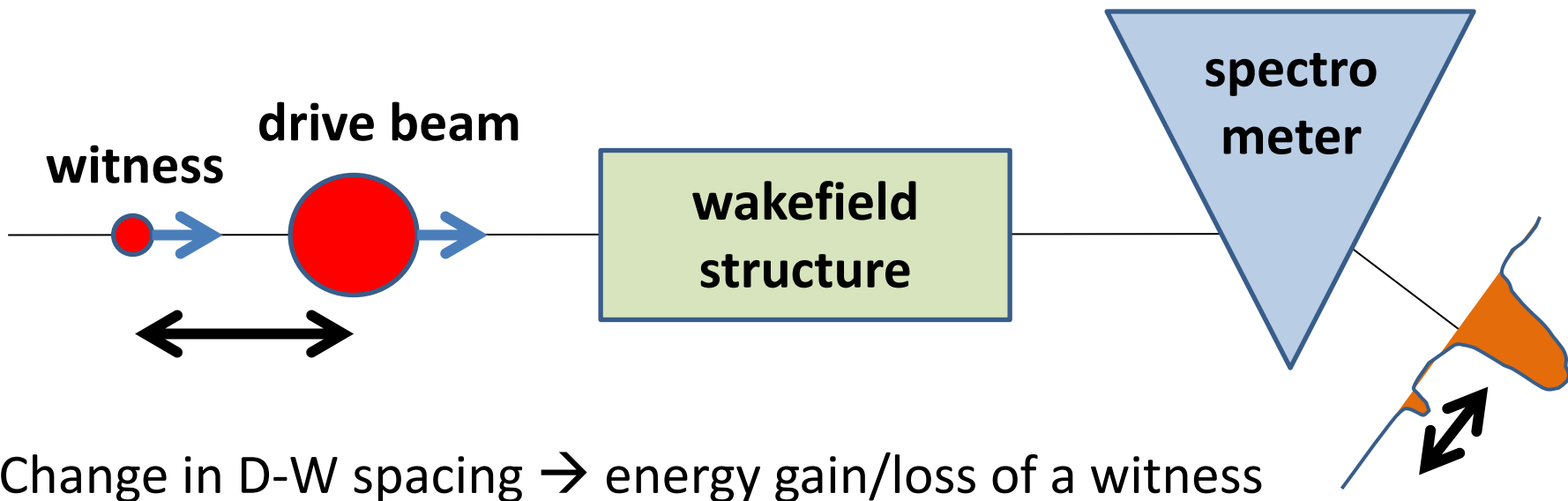

Experimental drive + witness visualization

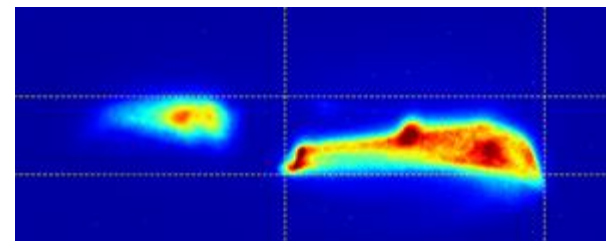

Spectrometer measurement

Wakefield structure

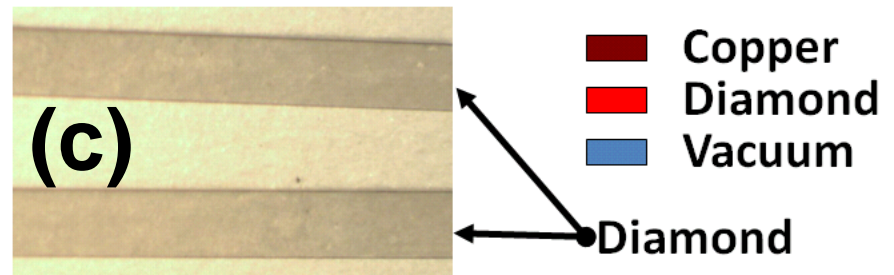
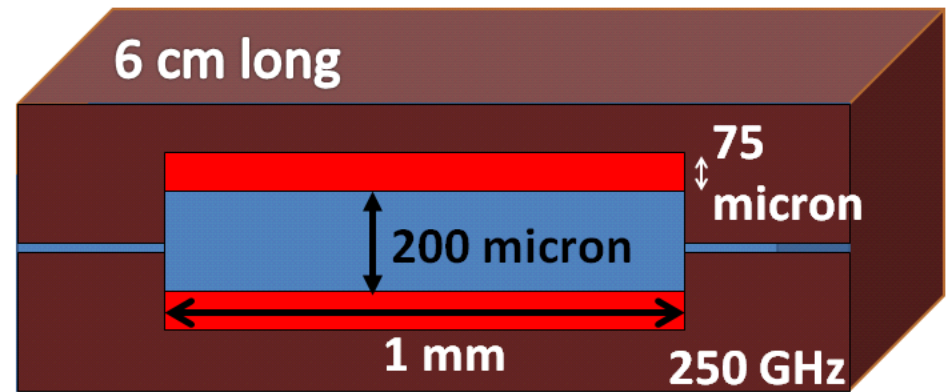
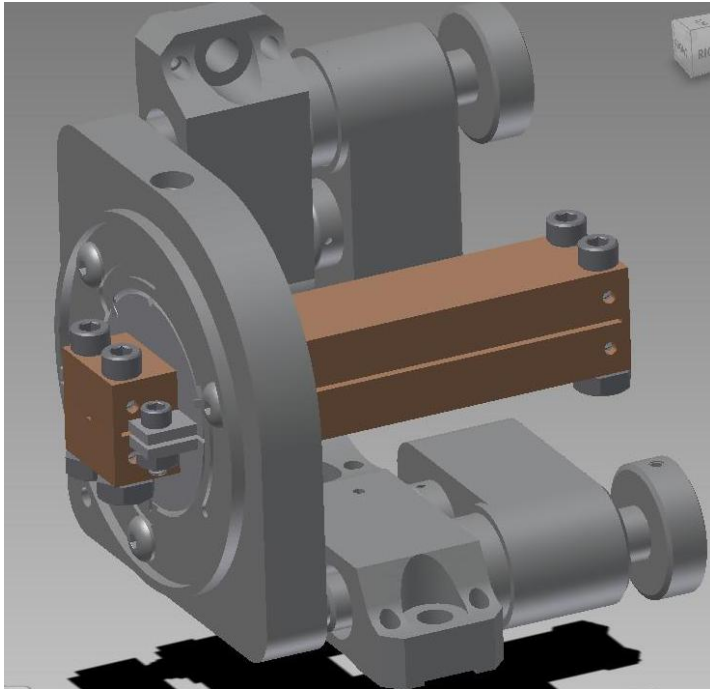

- Polycrystalline diamond, 75um thick
- 250 GHz slab-symmetrical structure

Why Diamond

Breakdown test at the AWA: 72nC goes through a standing wave diamond based structure (~ 70 MV/m, 35ns long) + scratch on a diamond \rightarrow field enhancement $\sim \epsilon$ times (300 MV/m field in the scratch)

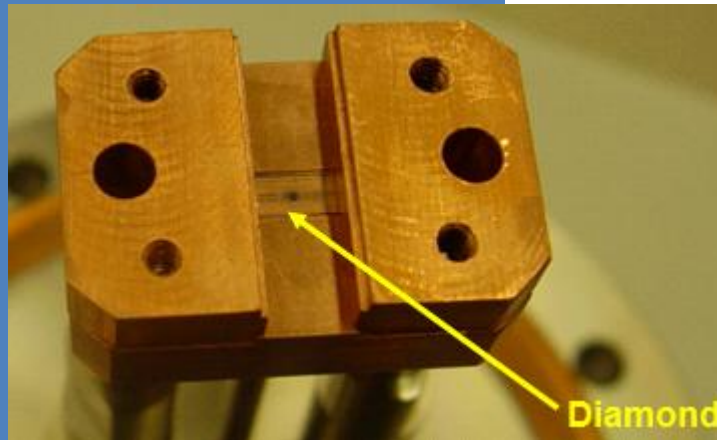
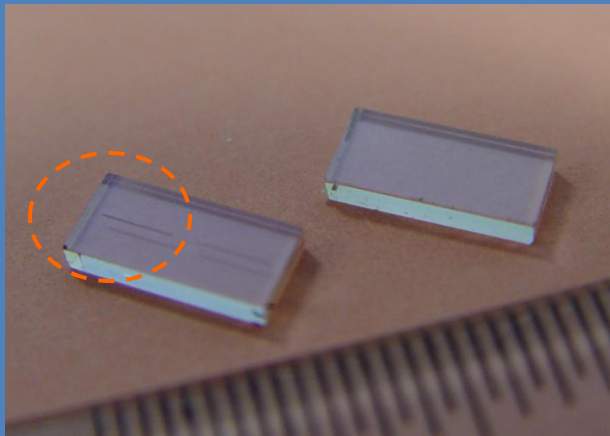

E / E_{acc} Field is ~ 5 times higher

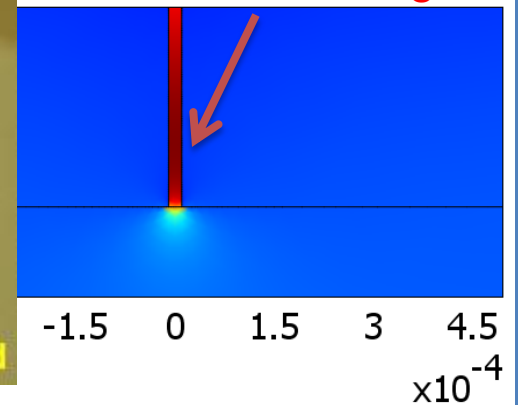

Preliminary examination shows no evidence of breakdowns. Additional test will be carried out. We are currently working on CVD diamond technology for THz DLA applications: $\sim 200\mu\text{m}$ aperture, 1-2 inches long high quality diamond

Why Diamond

Breakdown test at the AWA: 72nC goes through a standing wave diamond based structure (~ 70 MV/m, 35ns long) + scratch on a diamond \rightarrow field enhancement $\sim \epsilon$ times (300 MV/m field in the scratch)

“BEFORE”

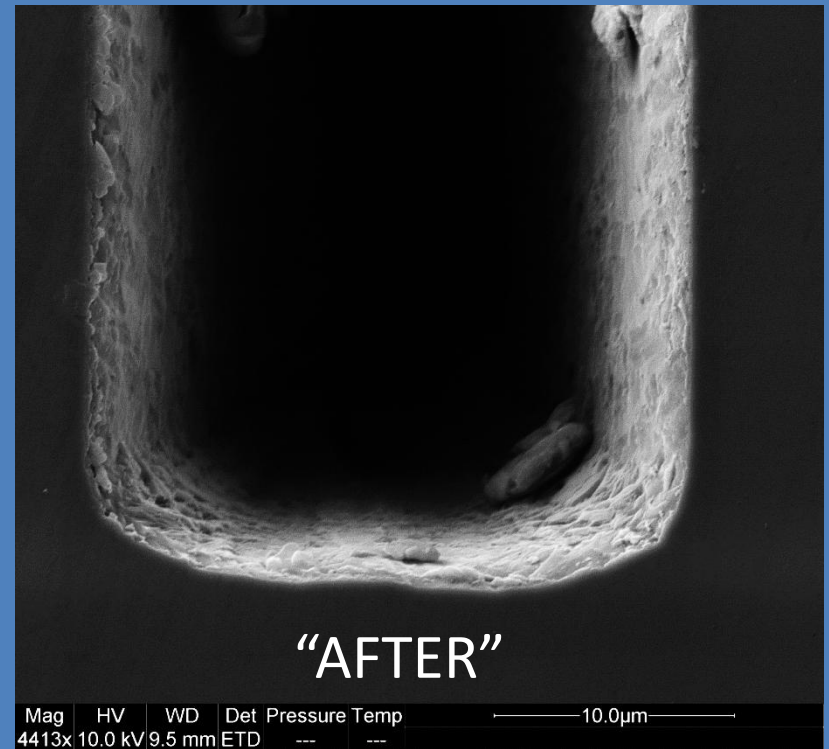
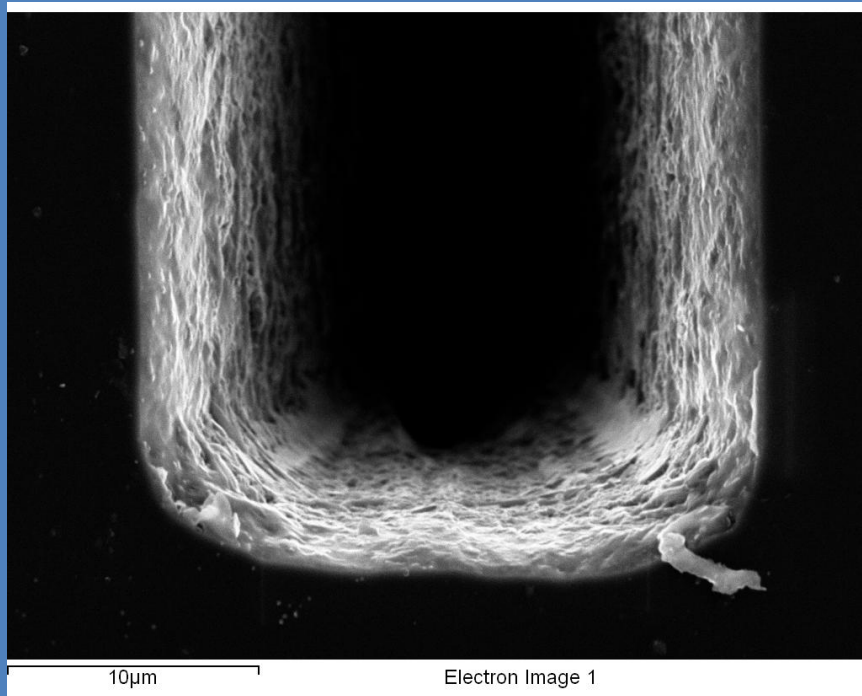

Preliminary examination shows no evidence of breakdowns. Additional test will be carried out. We are currently working on CVD diamond technology for THz DLA applications: $\sim 200\mu$ m aperture, 1-2 inches long high quality diamond

ATF beam masking

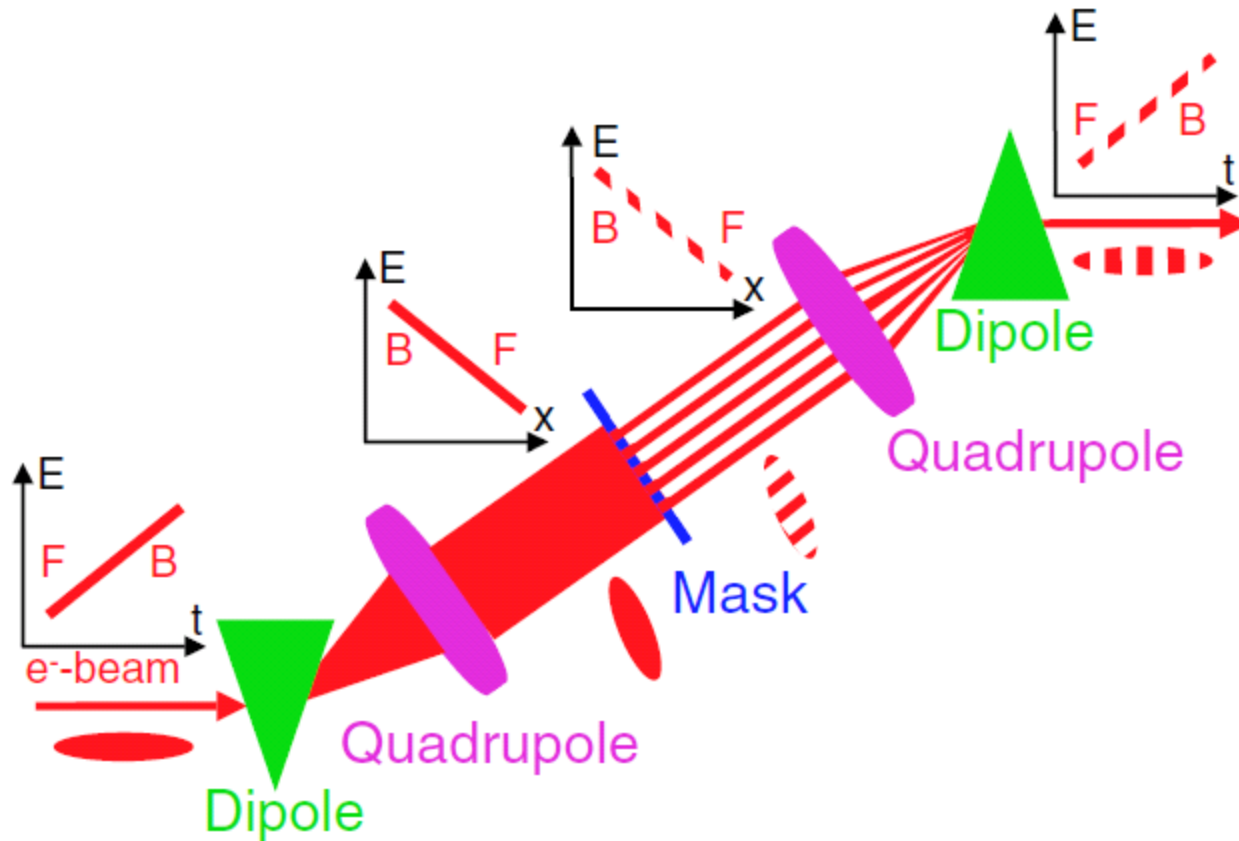

ATF beam masking

Transversely, flat beam is preferred, with max possible charge:

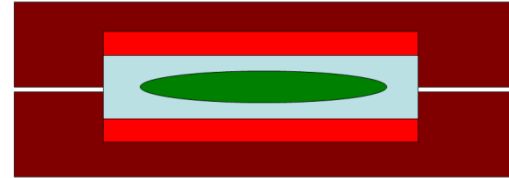

Longitudinally: 800 pC in 2.4 mm length [100 A]

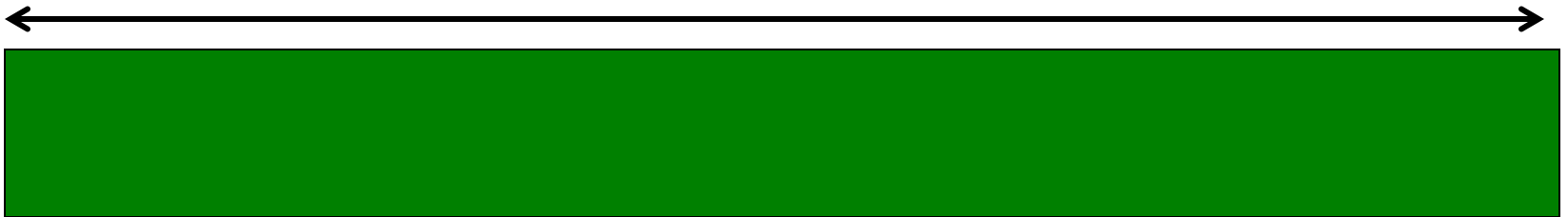

Longitudinal \rightarrow Transverse with **Energy spread**

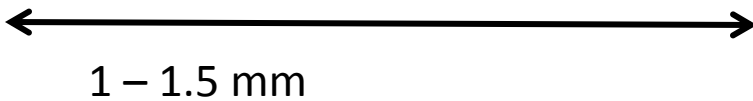
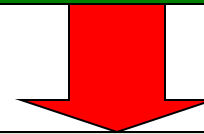

Possibility of movable mask to sweep the position of the witness beam?

Triangle drive bunch (max charge \sim 200pC) and small witness bunch (min possible)

Drive and Witness

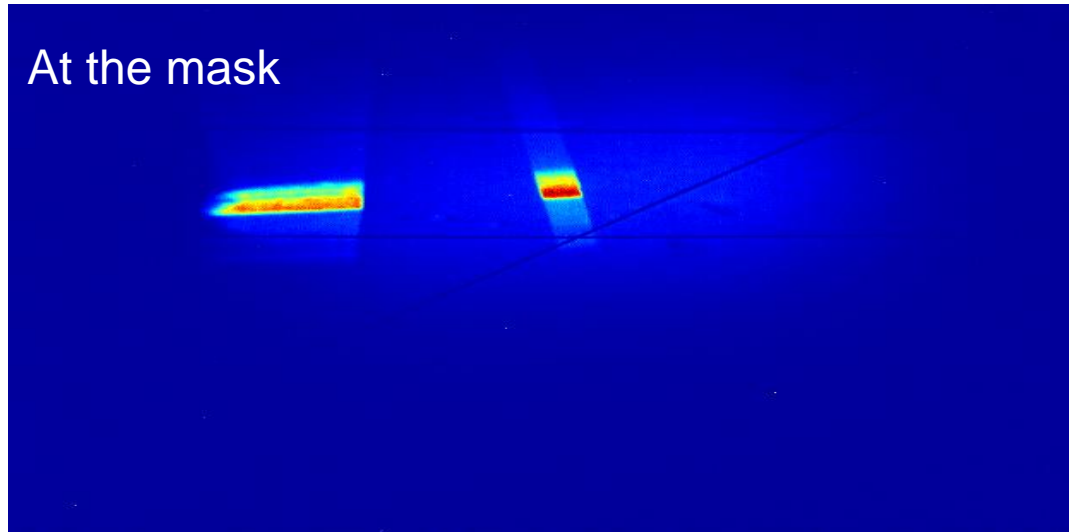

IPOP3 image
(right after the mask)
CTR interferometry is used
to calibrate the IPOP3
image to the longitudinal
current distribution

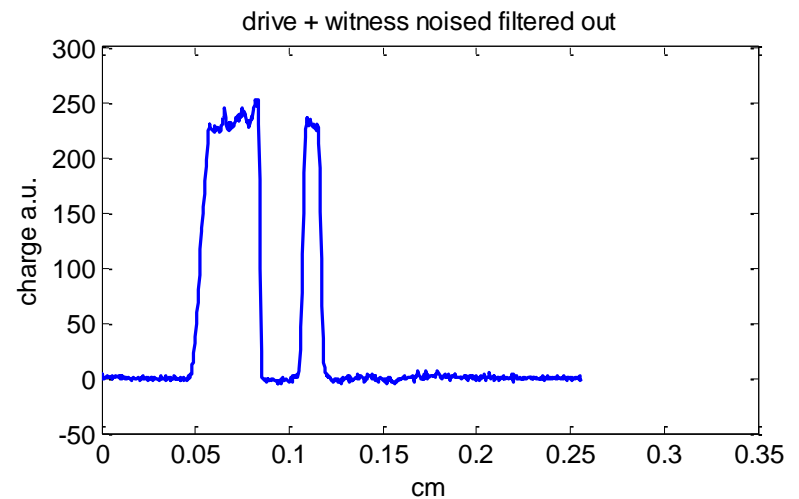
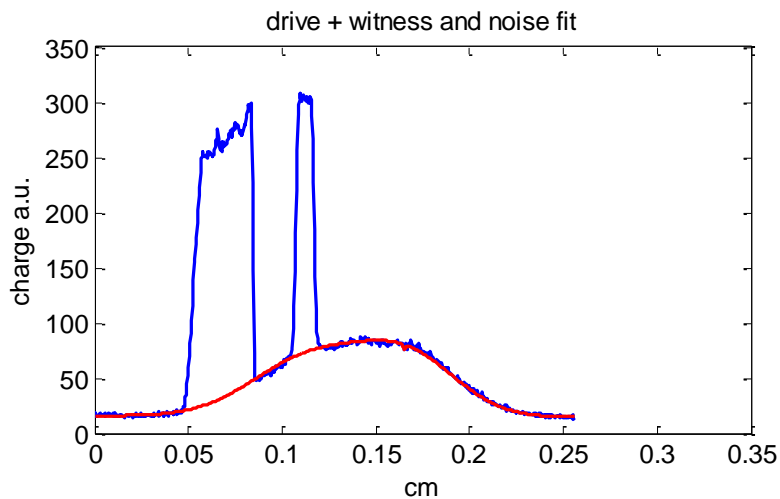

witness beam size effect

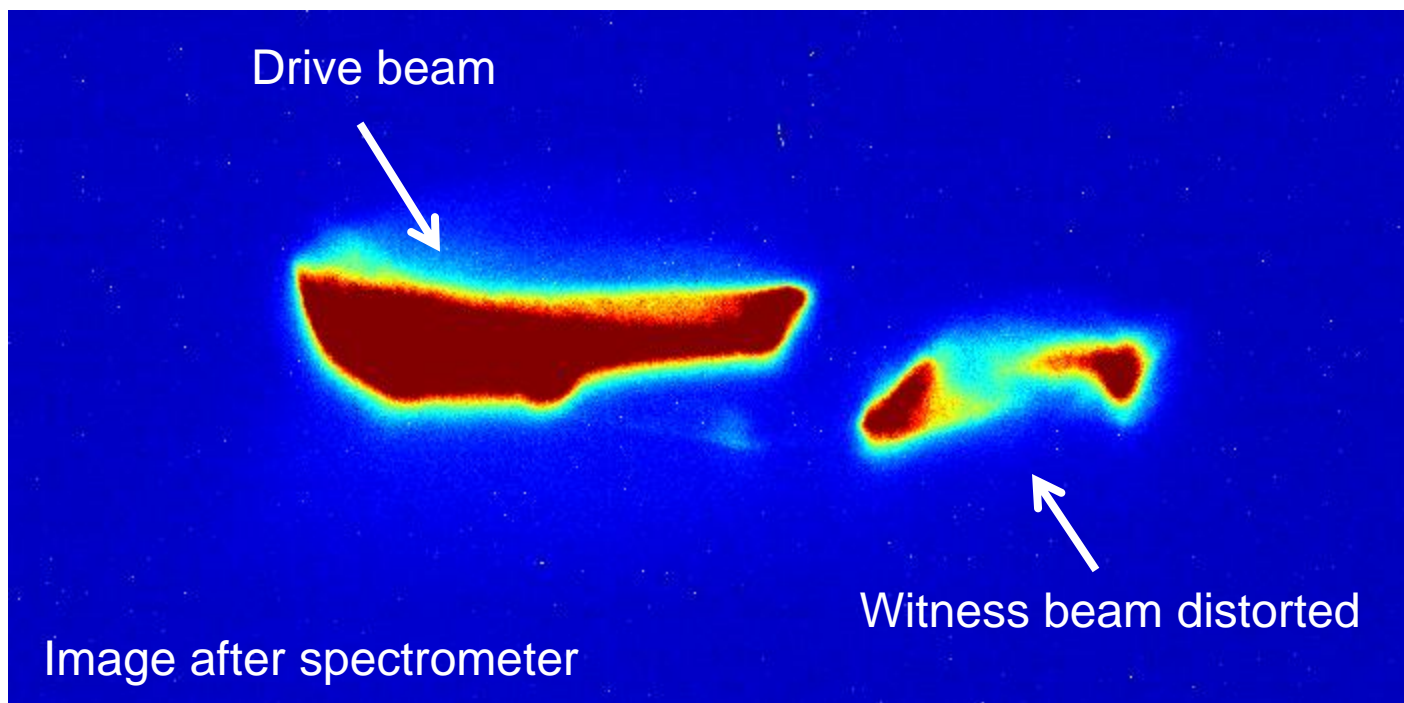
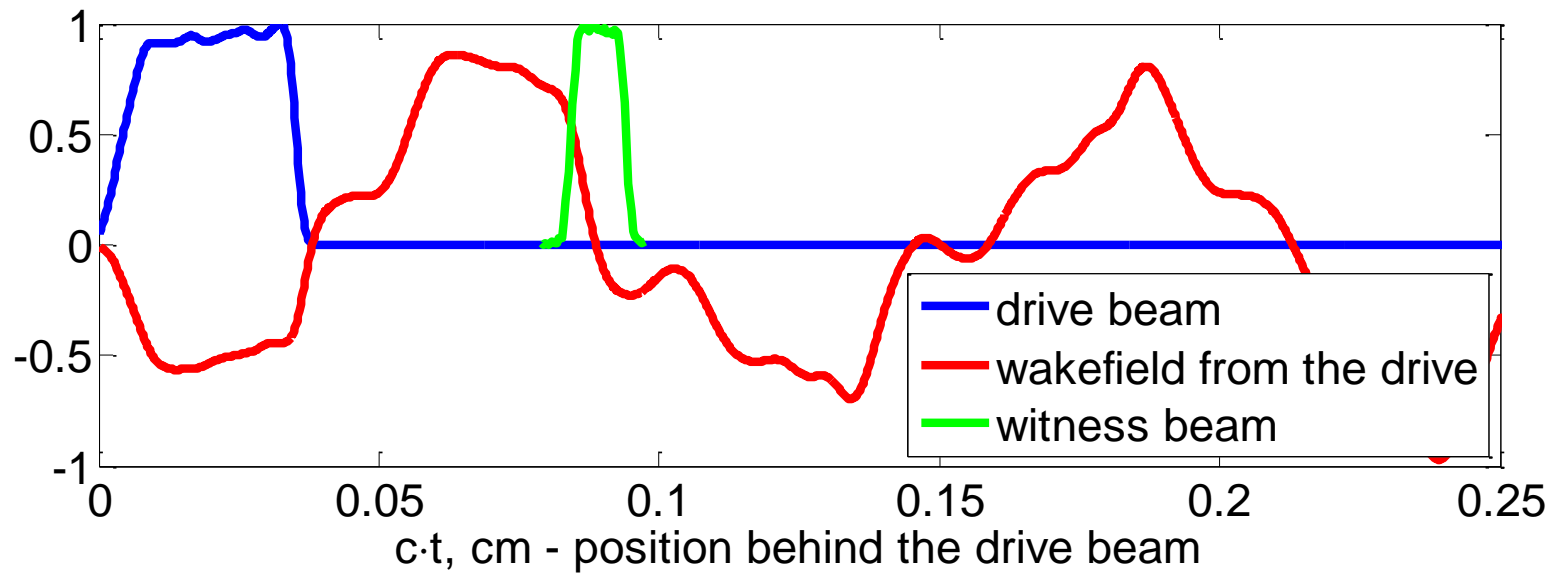

Result: wakefield mapping

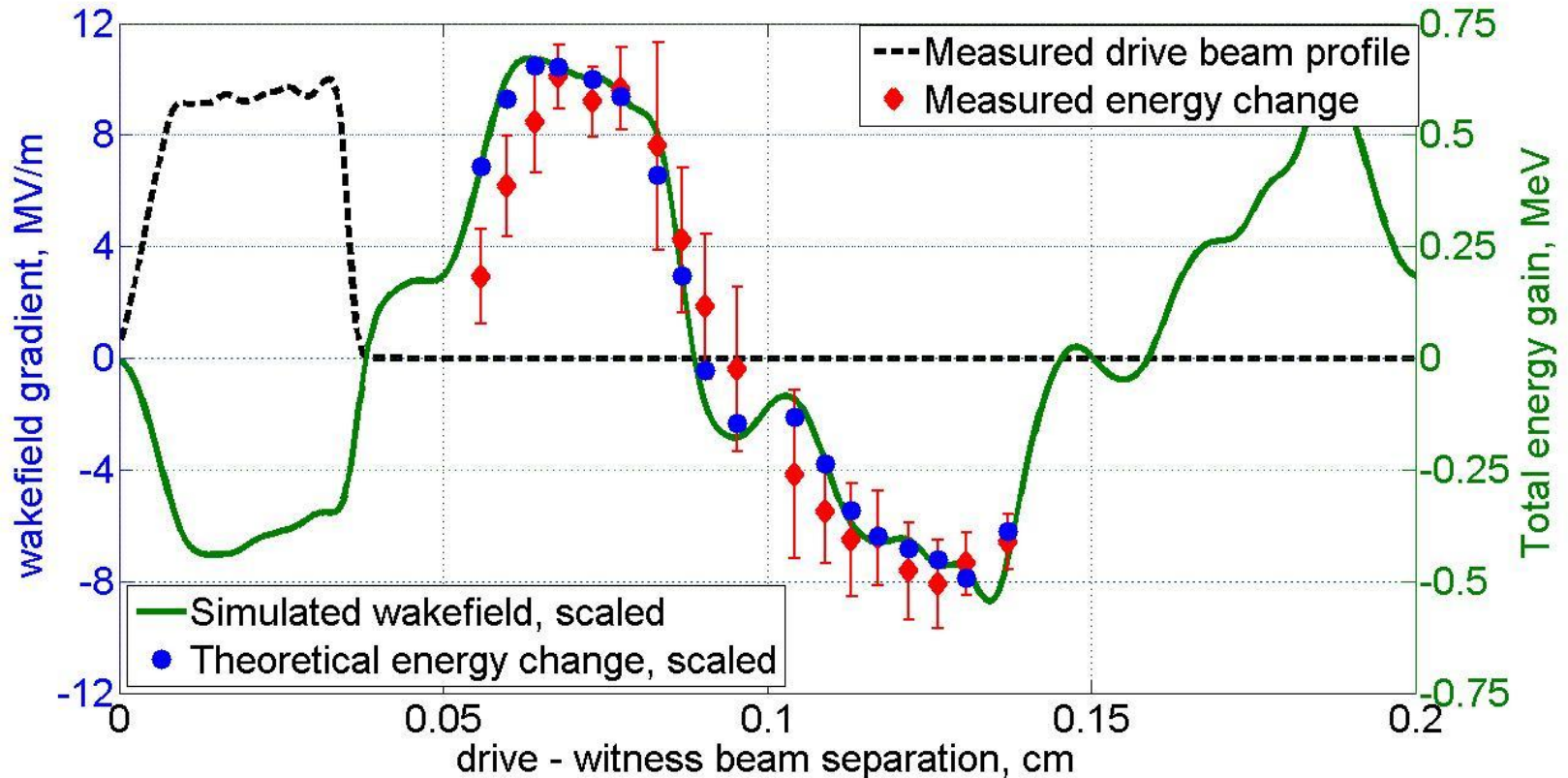

- Successful wakefield measurement at 0.25 THz
- Extremely valuable experience

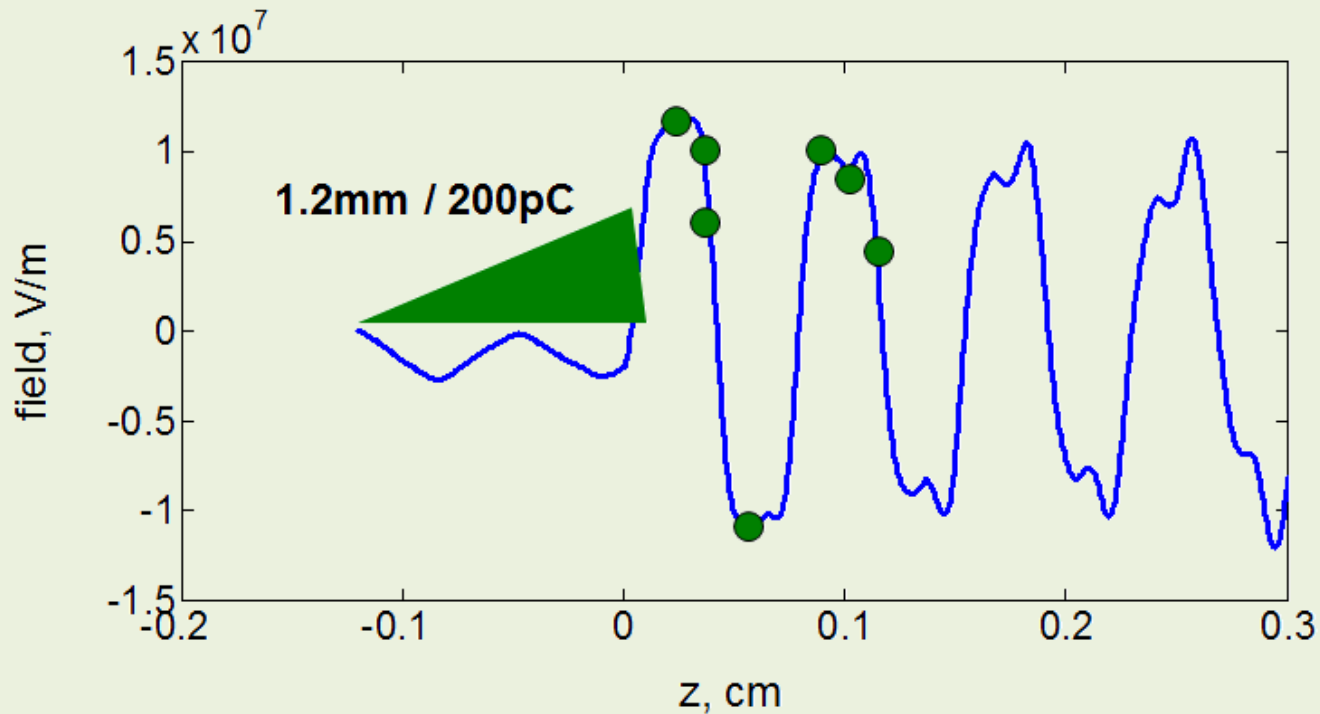

PROPOSED EXPERIMENT: HIGH TRANSFORMER RATIO