

Experimental Implementation of Smart Glove Incorporating Piezoelectric Actuator for Hand Tremor Control

S. KAZI, A. AS'ARRY, M. Z. MD. ZAIN, M. MAILAH, M. HUSSEIN

Department of Applied Mechanics
Faculty of Mechanical Engineering
Universiti Teknologi Malaysia (UTM)
81310, Skudai, Johor
MALAYSIA

skazi75@gmail.com, zarhamdy@fkm.utm.my

Abstract: - This paper examines the effectiveness of a glove specifically designed to compensate human hand tremor by incorporating a type of piezoelectric actuator. In this paper, the experimental results are divided into two parts involving actual human hand tremor and model hand-arm tremor. Both experiments were done using same measurement equipments, experimental setup and programming to evaluate the effectiveness of the glove in reducing the hand tremor. The initial experiment was done by measuring human hand tremor to determine the coherence frequency while other was performed on a hand-arm model with artificial vibration exciter to validate the response of the actual hand tremor. A number of selected sample frequencies were chosen for the experiment. Next, a piezoelectric actuator was employed as the main active element for the compensation of the tremors in both systems. The results presented both in time and frequency domains show that most tremors are readily suppressed to demonstrate the effectiveness of the proposed systems. They are considered as useful data that can be used for further investigation into the technique of effective human hand tremor suppression, particularly applicable to patients suffering from uncontrollable shaking or trembling such as in Parkinson's disease, white hand syndrome, etc. Subsequently, the output of this investigation can be also used to assist in developing advanced control strategies that involve the generation of controlled signals as the input for the piezoelectric actuator or other similar device to suppress the hand tremor. The presented system is notable for simplicity and low cost.

Key-words: - Human hand tremor, Smart glove, Piezoelectric Actuator.

1 Introduction

Typically, human hand motion can be broadly divided into two categories as either voluntary or involuntary. The former is intentional, such as throwing a baseball or changing the TV channel using a remote control while the latter is unintentional movement. An example of involuntary hand motion is the small vibration in a person's hand when trying to keep his/her hand still, due to small imperfections in the human body's biomechanical feedback mechanisms. Thus, an important part of this mechanism is the loss of the neurotransmitter dopamine in a group of brain structures that control the movements. Its major manifestations are variable but can include hand tremor, slowness of movements, limb stiffness, and difficulties with gait and balance [1]. In healthy people this involuntary hand motion is small but those who are suffering from neurological disorder, such as Parkinson's disease, there is a significant hand tremor movement which makes it difficult for

the tremor patient to perform desired tasks especially for holding and writing.

Neurological disorders are associated with the diminishing of finger sensitivity. The first symptom is a tingling in the fingers and is more noticeable straight after exposure to vibration, numbness of the fingers may accompany the tingling [2].

Muscle weakness, particularly in the middle finger and diminishing of grip strength is also associated with long-term exposure to vibration [3]. Directly exposed hands muscles are more likely to be weakened by prolonged vibration exposure than the muscles in the forearm, leading to the lowering of both grip and punch strength of the hands.

Engineering principles are applied to the biomechanical system to better understand the dynamics of the human hand. Moreover, a robust and stable performance of a hand is essential as it deals with the capability of the hand to compensate for the disturbance effects, uncertainties, parametric and non-parametric changes, which are prevalent in

the system particularly when the hand is executing tasks involving the interaction with the environment. Thus, the application of rehabilitation has become a matter of great concern.

There are substantial experimental research works conducted on human hand tremor [4-8]. Most of them used the medical treatment (drug), deep brain stimulus (DBS), a thalamic stimulator or other methods to reduce the tremble at the hand. Tremors are caused by problems with the nerves supplying certain commands to muscles. From the literature review, it is mentioned that two muscles (thenar and first dorsal interosseous) cause the source of tremor from the brain to the hand [9, 10]. To reduce that tremor, the actuator should be placed on the muscles to counter act the vibration.

Tremor is an unintentional, approximately rhythmic, involuntary, and roughly sinusoidal movement observed at relative fixed frequency and amplitude [11-14]. The tremor is primarily a single frequency phenomenon. It was found that the tremor frequency ranges between 4 – 12 Hz and can affect various parts of the body [11, 14]. Most commonly tremors occur at the hand. It occurs for everyone [13] but each person has different involuntary movement. Since wrist tremor and finger tremor possess different resonant frequencies, i.e., 8-12 Hz and 17-30 Hz, respectively [15-17] that do not include the 4-5 Hz frequency, the high power percentage seen in some patients within the 4-7 Hz must then be the result of an abnormal central oscillator, namely Parkinson's disease (PD) tremor.

Two types of tremors are usually observed in Parkinson's (PD) patients; that are resting tremor and postural tremor. Resting tremor occurs when muscles stay in relaxed and limbs are supporting fully to gravity, such as when the hands stay on the lap. Postural tremor appears when a part of the body is maintained in a fixed position and may also persist during movement [18]. Resting tremor occurs within the frequency range 3-7 Hz, occurs in up to 75% of individuals with PD [19]. Postural tremor is typically observed between 5 and 12 Hz and is symptomatic in around 60% of PD patients [19]. This implies that hand tremor for PD person is significant movement when the person at rest condition due to the negative correlation between amplitude and frequency signal.

Previous research has found that the acceleration amplitude for postural tremor is at the range ± 10 m/s² [19, 20] and displacement amplitude range ± 5 mm [13, 20-24].

In tremor investigation, the tremor measurement is often processed as random time series and

spectral [12, 14, 19, 20, 24-26]. By measuring involuntary movement, loading the hand will increase the amplitude of tremor while decreasing the frequency. The acceleration of limb tremor movement is often measured with an accelerometer and acts as a transducer to convert mechanical movement or vibration to an electrical output, which can then be filtered and analyzed using available computer software. According to some researchers tremor is directly related to acceleration.

Piezoelectric bimorph actuators, consisting of two oppositely poled piezoelectric plates that are bonded together with a bonding agent, were developed by utilizing the transverse piezoelectric coefficient for high-displacement and low-force applications [27]. The displacement amplification mechanism in such type of actuators are based on extension and contraction of piezoelectric plates, the lateral extension of one plate and the contraction of the other yield a bending displacement.

The use of gloves may be an economical and effective way of reducing the level of vibration that affects the hand and arm. Current legislation determines that personal protection, such as anti-vibration gloves, may only be used as a last resort to protect humans from health hazards.

Prolonged exposure to vibration affects the human body in many different ways [28]. Problems related to hand and arm areas due to exposure to vibration are fast becoming a serious concern. Different measures have been implemented to eradicate vibration-induced diseases but with very marginal success.

The use of anti-vibration gloves is one possible solution to lower the vibration levels that are transmitted to the hand and arm area of humans. These gloves provide anti-vibration material in the finger and palm areas to absorb the vibration energy from the source in order to lower the level of vibration reaching the patient's hand. The effective use of the gloves should be evaluated as an economical means of reducing vibration, as a form of personal prevention.

In this paper, the postural type of tremor is selected to be studied because the frequency range of postural tremor is greater than the resting tremor. We attempt to solve the vibration control problem of the human hand with tremor using smart glove. The current study was motivated by the wish to develop a better understanding of potential mechanisms of the effects of deep brain stimulation on parkinsonian tremor by studying the tremor dynamics that occur during the onset and offset of high frequency deep brain stimulation in subjects to parkinsonian tremor.

2 Design Consideration

The experimental rig is designed for the purpose of tremor data collection and measurement from hand-arm model and a close-up view of that rig with smart glove incorporated piezoelectric actuator is shown in Figures 1 and 2 respectively. The test rig is designed to hold the hand-arm model (Intra Vernacular Training Arm or IVTA) firmly in horizontal axis so as to emulate the postural tremor condition. The PD patients' postural type of tremor was selected rather than resting tremor, because the frequency range of postural tremor is greater compared to the resting tremor [19, 29]. By engaging unbalanced rotating mass actuated by the DC motor, vibration can be induced onto the hand-arm model, emulating the postural tremor behavior. The tremor measurement is taken at the specific point where the amplitude of tremor is high. The piezoelectric actuator should be placed on the palm of the patients hand to reduce the tremor. The test rig will be useful for further research especially in demonstrating the suppression of the postural tremor through the use of more advanced control technique such as active feedback control system with suitable instrumentations including the use of anti-vibration gloves to compensate the tremor [22, 30].

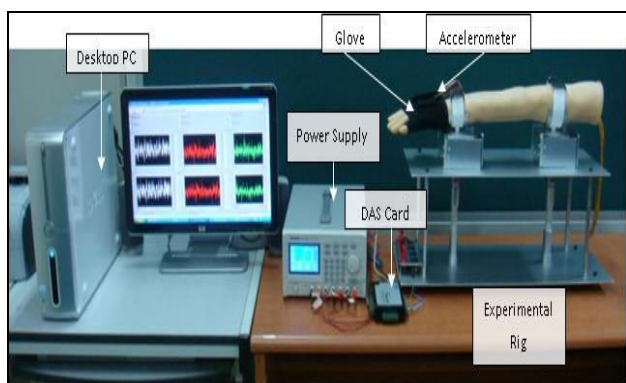

Fig.1 The experimental setup



Fig.2 The smart glove

3 Biodynamic Model of the Human Hand

Many researchers have attempted to study the biodynamic response (BR) of the hand and arm in terms of its vibration transmissibility for the purpose of quantifying the nature of vibration transmitted to the different segments of the hand and arm [31]. However, this study only focuses the biodynamic model at the palm of the human hand. The purpose is to investigate the BR distributed at the palm in the vertical plane (z-axis) in terms of acceleration, displacement and frequency behavior. Theoretically, human hand tremor occurs on its own without any external force that acts on the hand. However, to simplify the biodynamic model, external force is used to induce the vibration.

4 Dynamic Modelling of Piezoelectric Actuator

Piezoelectric actuators are becoming increasingly important in today's positioning technology and there has been a great deal of interest in getting better performance out of this technology, which in other terms means getting increased actuator deflection out of smaller devices with lower input power [32]. In the recent years, piezoelectric materials under computer control were made to act as actuators and sensors. The word "Piezo" is derived from the Greek word for pressure. Piezoelectric actuators convert electrical energy into mechanical energy or vice versa. In other words piezoelectric actuators convert voltage and charge into force and motion. Piezoelectric materials are constructed of special type of dielectric material in which it is typical that an extremely applied force induces an electrical charge, hence producing the piezoelectric effect. Conversely, an applied electrical charge induces a force to produce the inverse piezoelectric effect. There are many applications and fields where piezoelectric actuators have been widely used, such as ultra-precise positioning, active vibration control, ultrasonic welding and machining, common rail diesel injection systems, and in the generation and handling of high forces or pressures in static and dynamic situations [33].

Among the different actuator technologies, piezoelectric actuator devices offer a number of benefits for application in active control systems. Their high stiffness results in isotropic high actuator performance. The actuators are easily controlled, provide fast response, can have small dimension and weight, and can be simply driven by voltage.

The model shown in Fig. 3 has been derived from the linear, coupled, electromechanical, constitutive equations (represented in Eqs. (1) and (2)) between stress, strain, electric field and displacement.

$$D_3 = \epsilon_{33}E_3 + d_{33}T_3 \tag{1}$$

$$S_3 = d_{33}E_3 + \frac{1}{Y_{33}}T_3 \tag{2}$$

Where:

- D_3 Electric displacement or polarization in actuator
- S_3 Mechanical strain in actuator
- D_{33} Piezoelectric charge coefficient of actuator
- E_3 Electric field in actuator
- Y_{33} Elastic modulus of actuator
- T_3 Mechanical stress in actuator
- v_a Instantaneous voltage across actuator
- ϵ_{33} Dielectric permittivity of piezoelectric actuator material
- N Number of layers
- L Length of actuator
- w Width of actuator
- D Thickness of a one layer of actuator
- Q Total charge in actuator
- K^2 Electromechanical coupling coefficient

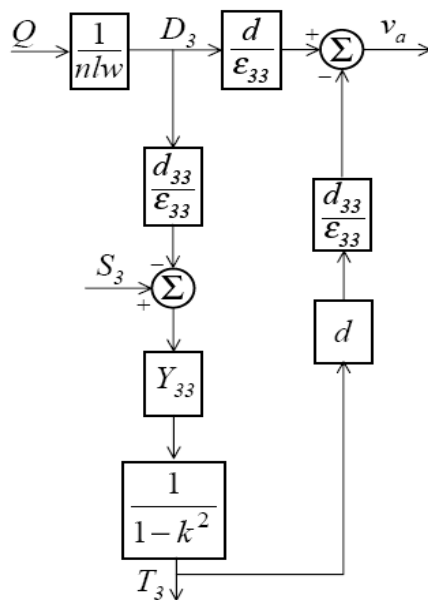

Fig.3 Electromechanical model of piezoelectric actuator [34]

The bimorph type piezoelectric actuator with amplifier is used in this experimental study as shown in Fig. 4.



Fig.4 Bimorph piezoelectric actuator with amplifier

5 Experimental Results and Discussions

In this section, the experimental results are divided into two parts (a) actual human hand tremor (b) model hand-arm tremor. The oscillation readings of both the human hand tremor and IVTA are taken at the left hand only by quantifying in the vertical axis as the plane of interest. The objective of the study is to determine the amplitude of vibration in terms of acceleration and displacement in time and frequency domain. The results can be used for further investigation of developing the anti-vibration glove to suppress or reduce tremor.

For every graph shown, there were two signal conditions which are “with piezoelectric actuator effect” (red line color) and “without piezoelectric effect” (black line color). Figure 5 shows the acceleration response for actual human hand tremor behavior when wearing the glove in time and frequency domain. In order to get the pure human hand tremor oscillation, the hand is measured without the effect of piezoelectric actuator, and it fluctuates between -3 m/s^2 to 2.85 m/s^2 . It is also found that the coherence frequency occurred at 9Hz with magnitude of $0.623 \text{ (m/s}^2\text{)}^2\text{/Hz}$. Then, by applying piezoelectric actuator with the frequency at 7Hz, it is found that the acceleration signal changes and fluctuates between -3.85 m/s^2 and 3.85 m/s^2 as shown in Figure 5(a). The tremor frequency observed at 9Hz with the magnitude decreased to $0.4081 \text{ (m/s}^2\text{)}^2\text{/Hz}$. Figure 5(b) illustrated the effect of piezoelectric actuator when applying the frequency at 8Hz. From the time domain figure, the acceleration signal vibrates within the range of -1.35 m/s^2 to 1.35 m/s^2 . Meanwhile in the frequency domain, it is observed that the frequency occurred at 6Hz with magnitude of $0.1969 \text{ (m/s}^2\text{)}^2\text{/Hz}$. In Figure 5(c), the acceleration signal oscillates between -1.28 m/s^2 to 1.25 m/s^2 when the human hand tremor is exposed to the piezoelectric actuator that vibrates at the frequency of 9Hz. In the frequency domain, the tremor frequency observed at 9 Hz with the magnitude decreased to $0.1485 \text{ (m/s}^2\text{)}^2\text{/Hz}$.

Generally, when applying the glove at human hand tremor, the acceleration signal with the effect of piezoelectric (at 7Hz to 9Hz) reduced the human hand tremor oscillation. In frequency domain results, the magnitude peak was decreased a little bit from the actual human hand tremor, when the piezoelectric actuator was applied.

Meanwhile, Figure 6 represents the displacement results for actual human hand tremor wearing the glove with/without the actuation of piezoelectric actuator in time and frequency domain. Without effect of piezoelectric actuator, human hand tremor displaced between -1.2 mm to 1.3 mm. It is also found that the coherence frequency occurred at 6Hz with magnitude of $0.07097 \text{ mm}^2/\text{Hz}$. Figure 6(a) shows the effect of piezoelectric actuator, when vibrating at 7Hz. In the time domain, human hand tremor amplitude is not in uniform distribution and ranges between -7.24 mm to 7.25 mm. In spectral measurement, the tremor was observed at 6Hz with magnitude of 0.08676. Figure 6(b) depicts the amplitude of human hand tremor when applying piezoelectric actuator at 8Hz oscillates between -1.3 mm and 1.2 mm. Meanwhile in frequency domain, the hand tremor was observed at 6Hz with magnitude of $0.04445 \text{ mm}^2/\text{Hz}$ and decreases displacement magnitude peak from the human hand tremor. Lastly, Figure 6(c) illustrates the effect of piezoelectric actuator when it vibrates by applying frequency of 9Hz. From the time domain figure, the amplitude of displacement signal has the peak within -0.82mm to 0.82 mm. Meanwhile in the frequency domain, it is observed that the frequency occurred at 6 Hz with magnitude reduced to $0.02533 \text{ mm}^2/\text{Hz}$. Based on the displacement results, human hand tremor oscillates at the frequency of 6Hz. The glove applied with piezoelectric is able to reduce human hand tremor frequency magnitude at 8Hz and 9Hz. During a 30 second time interval, it indicates that the displacement signal is not in the uniform distribution form as the displacement result correlates with the ability of patient to maintain straight hand-arm (90 degrees from straight body) under the tremor circumstance. This may give some effect to the accuracy of displacement hand tremor since the measurement was using the non contact and precise device. However, the result between the effects of piezoelectric on human hand can be easily evaluated by referring to the frequency peak in the frequency domain graphs.

From the acceleration signal results, the glove proves to be excellent in reducing human hand tremor at all selected piezoelectric vibration frequencies (7 Hz, 8 Hz and 9 Hz). When applying the piezoelectric with the glove, for vibration at 7

Hz, it reduces the human hand tremor magnitude by 34.50%, for vibration at 8 Hz, it is 63.39% and for vibration at 9 Hz, it is 76.16%.

From displacement signal results, the glove proves to be excellent in reduction human hand tremor magnitude peak to 37.37% and 64.31%, when the piezoelectric vibrates at 8 Hz and 9 Hz, respectively. The findings clearly show that the glove is better in reducing human hand tremor behavior.

Results with the glove for tremor data collection and experimental setup can be seen in Figures 7 and 8. Figure 7 shows three selected natural frequencies of DC motor analysis for acceleration behavior in time and frequency domains. For every graph shown, there were two signal conditions which are "piezoelectric actuator on" (red line) and "piezoelectric actuator off" (black line). The acceleration amplitude exhibited in Figure 7(a) with the DC motor frequency of 67.91 Hz induces vibration within the range of -6.5 m/s^2 to 6.5 m/s^2 for the duration of 30 seconds excitation without the effect of piezoelectric actuator. The acceleration signal vibrates within the range of -7 m/s^2 to 7.25 m/s^2 , when piezoelectric actuator was applied. On the other hand, the frequency coherence for both signal occurred at 7 Hz with a little bit difference in the peak magnitude. Without piezoelectric actuator, the magnitude is $0.852 \text{ (m/s}^2)^2/\text{Hz}$, while with piezoelectric actuator, the magnitude is reduced to $0.7156 \text{ (m/s}^2)^2/\text{Hz}$. Figure 7(b) presents the vibration when the DC motor frequency was 70.68 Hz. In time domain, without the effect of piezoelectric actuator, the acceleration signal oscillates between -11 m/s^2 and 10.5 m/s^2 . Then, with piezoelectric actuator, the acceleration signal was found to increase in the range -11.3 m/s^2 and 11.2 m/s^2 . Meanwhile, the coherence frequency domain also occurred at 8 Hz with the peak magnitude of $2.863 \text{ (m/s}^2)^2/\text{Hz}$ (piezoelectric off) and with piezoelectric effect at $2.92 \text{ (m/s}^2)^2/\text{Hz}$, respectively. Lastly, Figure 7(c) shows the vibration of IVTA at DC motors frequency of 77.80 Hz with dynamic range between -12.14 m/s^2 to 12 m/s^2 without the effect of piezoelectric actuator. The dynamic range of acceleration was fluctuated between -11.5 m/s^2 to 12 m/s^2 , when the piezoelectric effect was presence.

The frequency of vibration occurred at 8 Hz with a magnitude of $3.22 \text{ (m/s}^2)^2/\text{Hz}$ (off piezo) and $3.041 \text{ (m/s}^2)^2/\text{Hz}$ (on piezo). From the time domain graph, it can be seen that significant dominance for both signals is not shown since they fluctuate approximately at the same amplitude level. However, in frequency domain, the magnitude is seen to be slightly greater without piezo than with

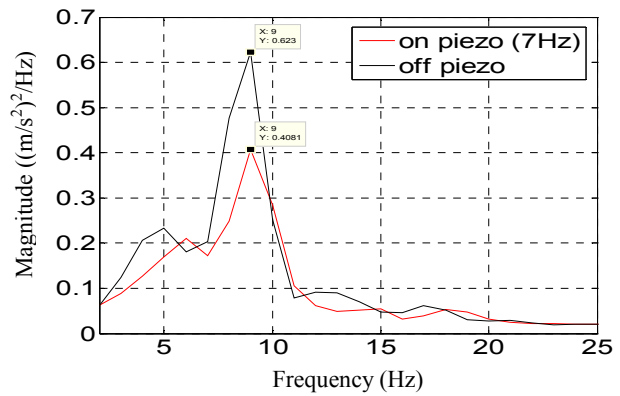
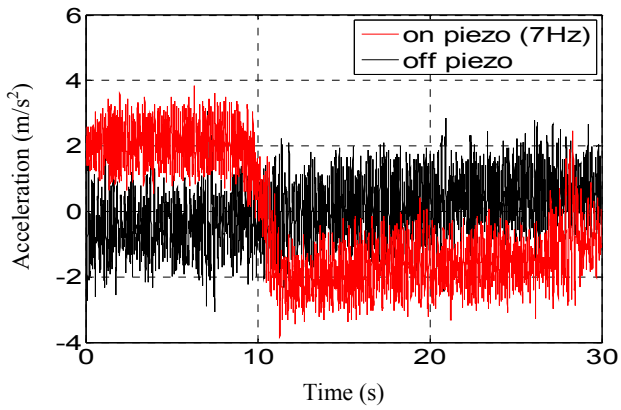

(a) Acceleration response when piezoelectric actuator vibrates at 7Hz

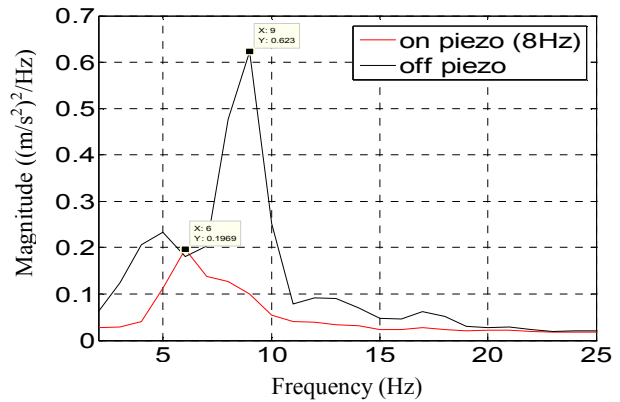
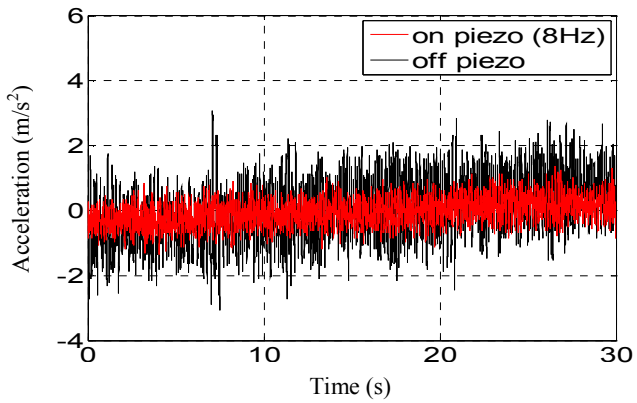

(b) Acceleration response when piezoelectric actuator vibrates at 8 Hz

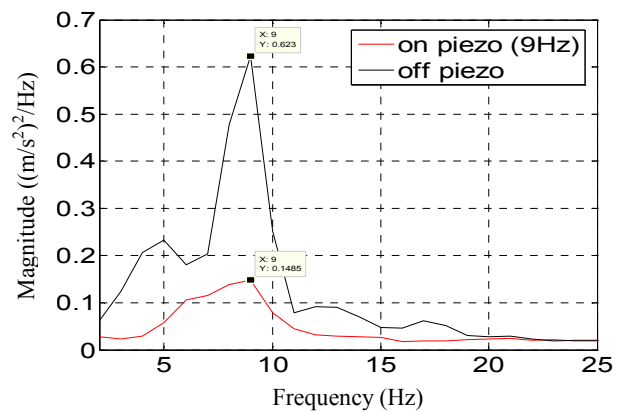
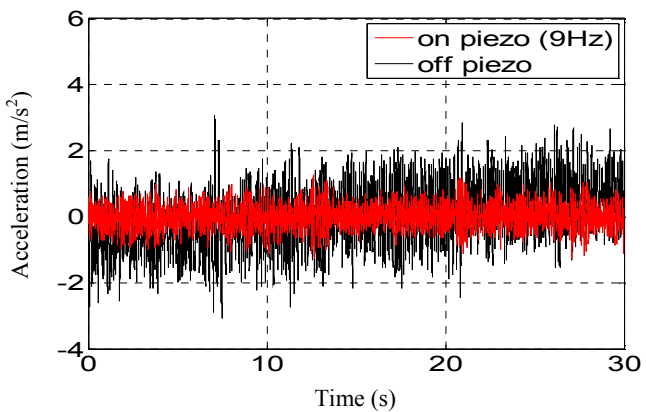

(c) Acceleration response when piezoelectric actuator vibrates at 9 Hz

Fig.5 Acceleration responses for the human hand tremor with glove

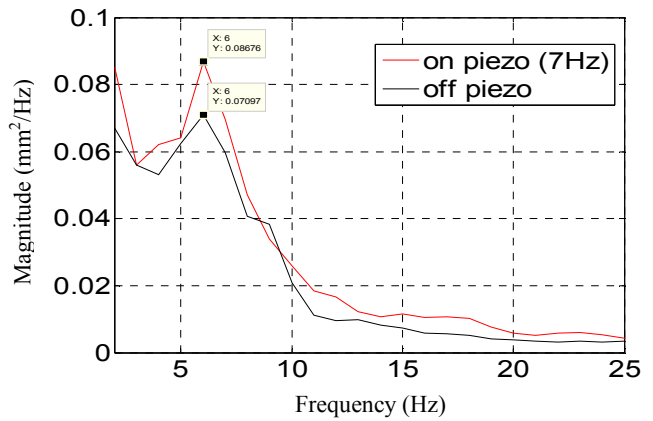
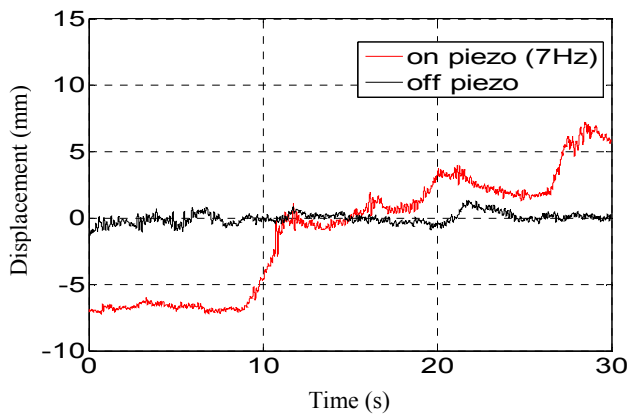

(a) Displacement response when piezoelectric actuator vibrates at 7Hz

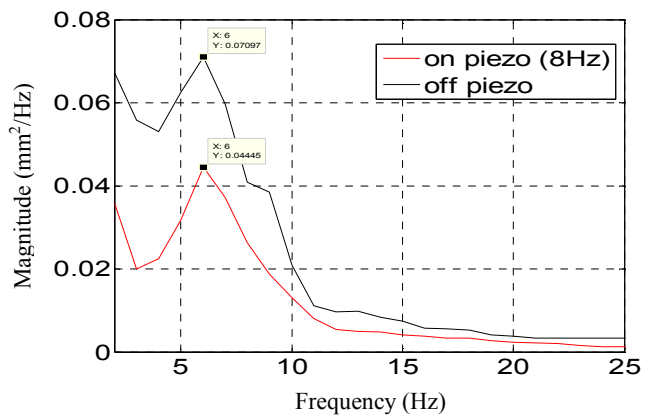
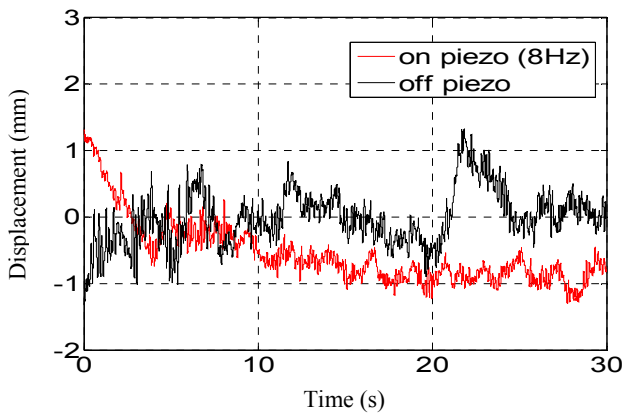

(b) Displacement response when piezoelectric actuator vibrates at 8 Hz

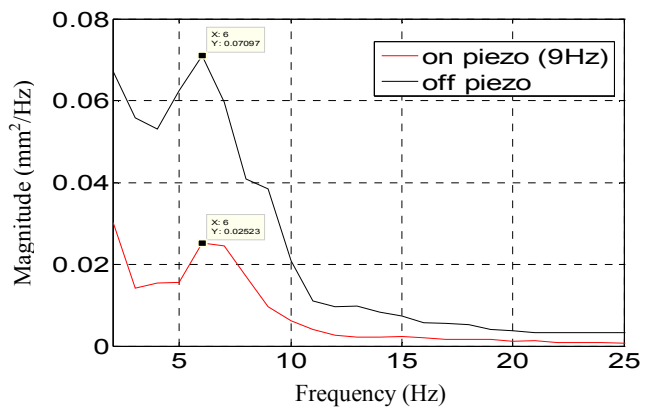
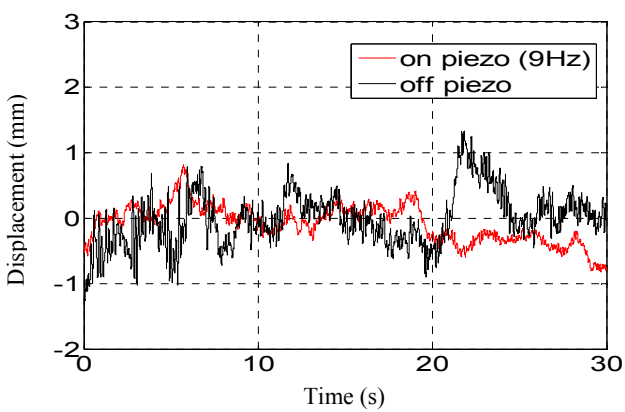

(c) Displacement response when piezoelectric actuator vibrates at 9 Hz

Fig.6 Displacement responses for the human hand tremor with glove

the piezo condition.

Figure 8 shows the precise vibration displacement signals of IVTA, after wearing the second glove. As shown in Figure 8(a), the amplitude is within the range of -0.65 mm to 0.75 mm (off piezo) and -0.85 mm to 0.85 mm (on piezo). Meanwhile in the frequency domain, it is observed at 7 Hz with the magnitude peak at 0.1525mm²/Hz (off piezo) and 0.1745 mm²/Hz (on piezo).

In Figure 8(b), the IV Training Arm oscillated between -1.1 mm and 1.1 mm without piezoelectric effect. With the piezoelectric actuator, the acceleration signal is not in uniform distribution as the amplitude is within the range of -1.2 mm and 1.2 mm. This is due to the noise of the displacement signal while taking the measurement. Nevertheless, the frequency domain revealed the actual vibration reading at 8Hz and without the effect of piezoelectric, the magnitude is 0.3168 mm²/Hz but with the piezoelectric, the magnitude is reduce a

it reduces a little bit to 0.3162 mm²/Hz. Lastly, Figure 8(c) shows the high displacement range between -1.15 mm and 1.2 mm when disable piezoelectric effect while with piezoelectric it is between -1.3 mm and 1.35 mm respectively. In frequency domain, without piezoelectric actuator effect, the frequency was observed at 9 Hz with magnitude peak at 0.3903 mm²/Hz. By applying piezoelectric actuator, the frequency occurred at 8 Hz with magnitude at 0.3219 mm²/Hz. From the glove results, by referring to the time and frequency domains, it shows that the acceleration of the IVTA is reduced when the DC motor rotates the unbalanced mass at 77.80 Hz with 5.59% reduction. Meanwhile for the displacement signal, the glove is able to reduce tremor when the natural frequency of the DC motor is also at 70.68 Hz with 0.19% and at 77.80 Hz with 17.52%. Thus, it clearly shows more effectiveness of the glove in reducing IVTA tremor when the natural frequency of DC motor is at 77.80 Hz.

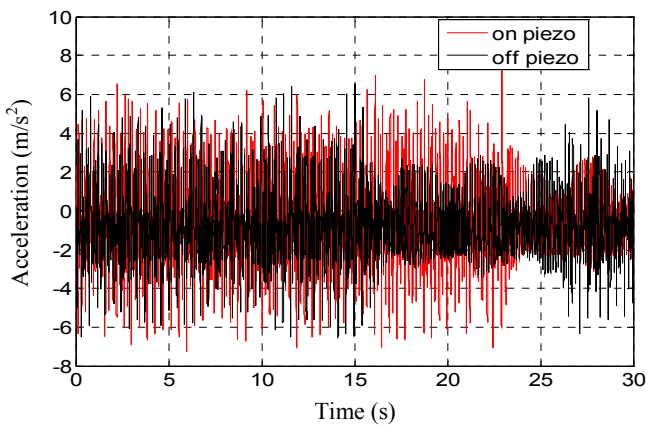

(a) Vibration induced by the DC Motor at 67.91 Hz

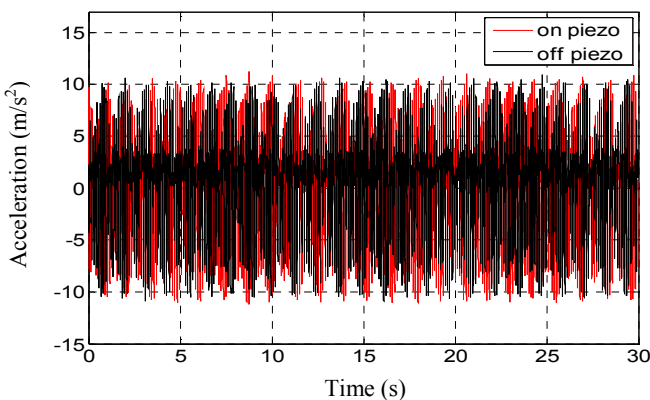
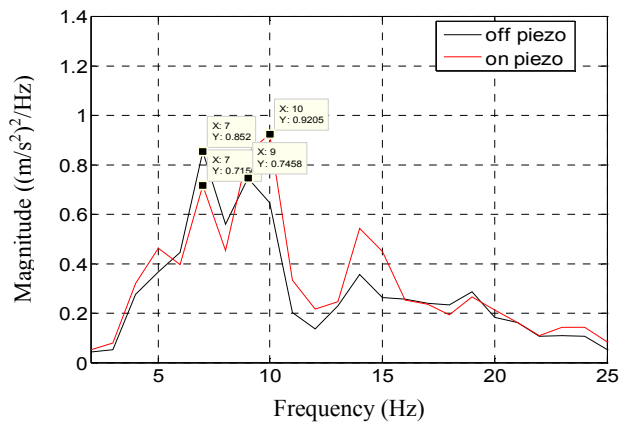

(b) Vibration induced by the DC Motor at 70.68 Hz

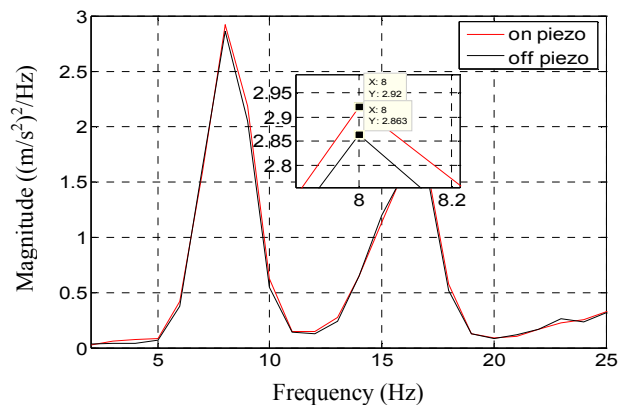

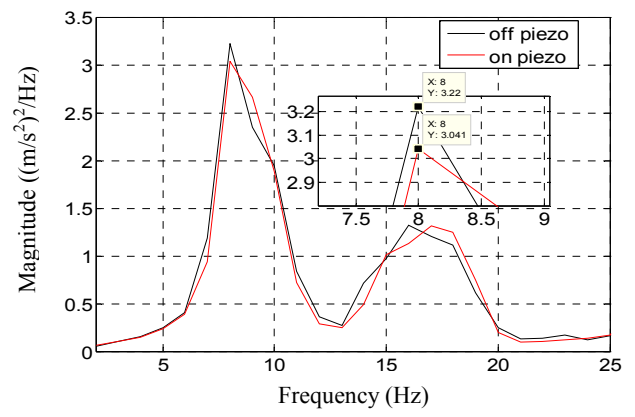
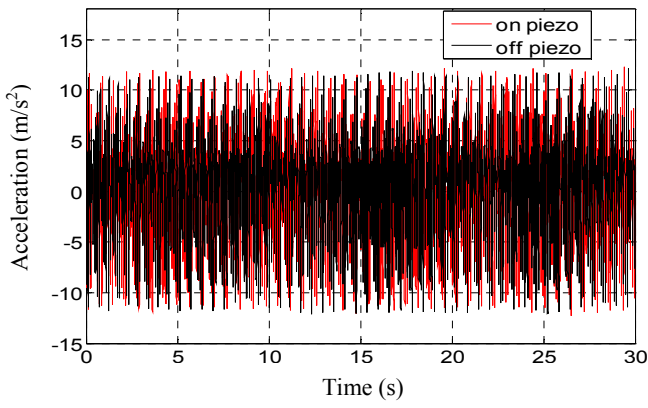

(c) Vibration induced by the DC Motor at 77.80 Hz

Fig.7 Acceleration responses of IVTA with glove

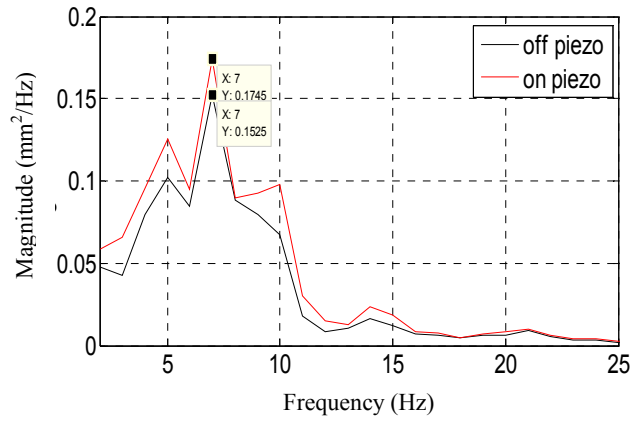
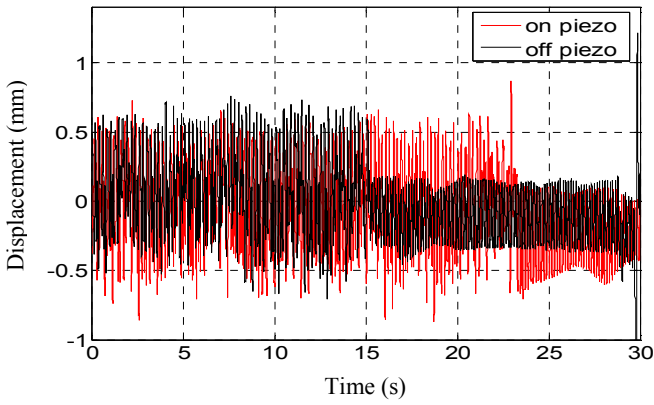

(a) Vibration induced by the DC Motor at 67.91 Hz

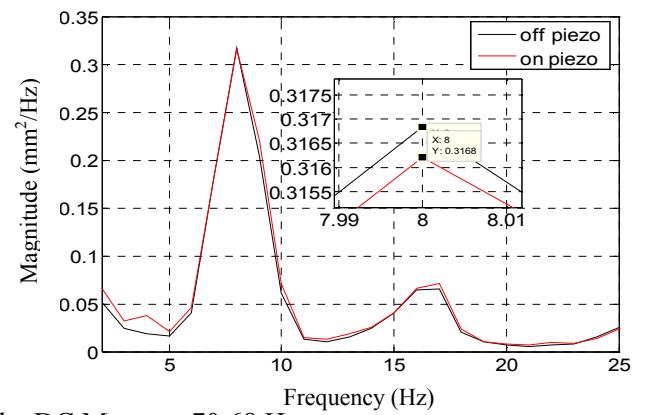
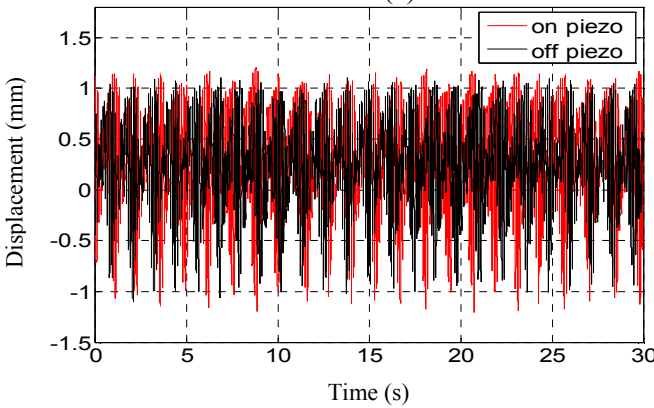

(b) Vibration induced by the DC Motor at 70.68 Hz

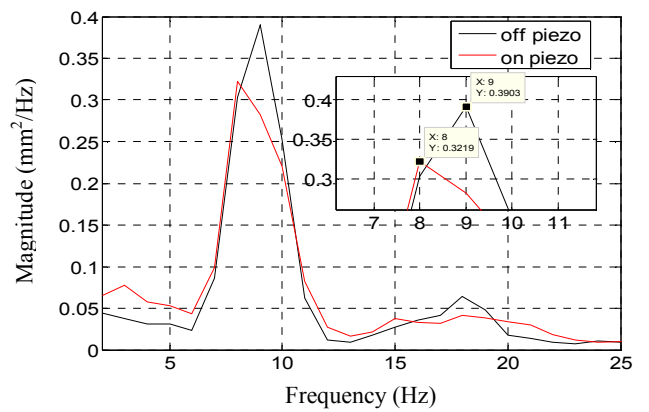
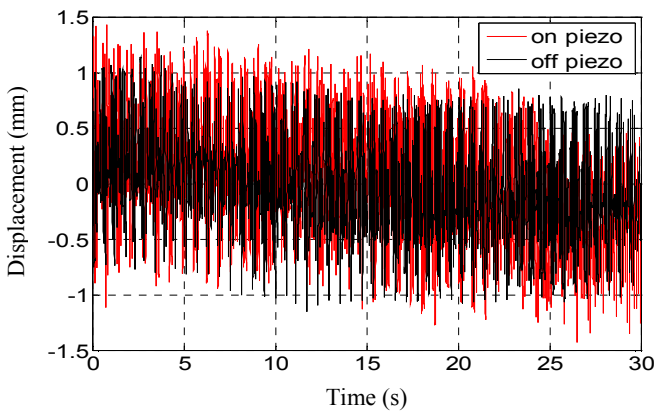

(c) Vibration I induced by the DC Motor at 77.80 Hz

Fig.8 Displacement responses of IVTA with glove

6 Conclusion

The tremor suppression is made possible through the use of glove with piezoelectric actuator embedded. It is clear that the actuator acts as a tremor resist element by providing the pre-emptive force to the hand and/or IVTA model. For human hand tremor, the glove is much better in reducing the tremor because it is able to give high percentage of magnitude reduction for both acceleration and displacement signals. For the IVTA tremor, the glove shows good responses, when the natural frequencies of the artificial exciter through the DC motor were operated at 67.91 Hz and 77.80 Hz. It was also found that three selected frequencies of the artificial exciter can provide vibration almost similar to the human hand tremor at 67.91 Hz, 70.68 Hz and 77.80 Hz, thereby implying that the model can be acceptably used for emulating the actual hand tremor.

7 Acknowledgment

The authors would like to thank the Malaysian Ministry of Science, Technology and Innovation (MOSTI) and Universiti Teknologi Malaysia (UTM) for their continuous support in the research work. Financial support through the Escience Fund grant (Vote No.:79246) is gratefully acknowledged.

References:

- [1] Z. Szabo, B. Storkova, J. Hozman and V. Zanchi, Objective assessment of Patients with Parkinson's Disease, 3rd WSEAS International conference on Remote Sensing, 2007, pp. 39-42.
- [2] R.M. Franz, J.L. Phillips, A handbook of Occupational Health Practices in the South African Mining Industry, Published by The Safety in Mines Research Advisory Committee (SIMRAC). Johannesburg. 2001, pp. 193-232
- [3] L.E. Neckling, G. Lundborg, J. Friden, Hand muscle weakness in long-term vibration exposure, *Journal of the British Society for surgery of the hand*. Vol.26, No.6, 2002, pp. 520-525.
- [4] M. Haeri, Y. Sarbaz, S. Gharibzadeh, Modeling the Parkinson's tremor and its treatment, *Journal of Theoretical Biology*, 236, 2005, pp. 311-322.
- [5] F. Klostermann, J. Vesper, G. Curio, Identification of target areas for deep brain stimulation in human basal ganglia substructures based on median nerve sensory evoked potential criteria, *J. Neurol.* *Neurosurg. Psychiat*, 74(8), 2003, pp. 1031-1035
- [6] A. Beuter, M.S. Titcombe, Modulation of tremor amplitude during deep brain stimulation at different frequencies. *Brain Cogniton* 53(2), 2003, pp. 190-192.
- [7] P. Limousin, P. Krack, P. Pollak, A. Benazouz, C. Ardouin, D. Haffmann, A.L. Benabid, Electrical stimulation of the subthalamic nucleus in advanced Parkinson's disease. *N. Engl. J. Med.*, 339(16), 1998, 1105.
- [8] E.B. Montgomery, K.B. Baker, Mechanism of deep brain stimulation and future technical developments. *Neurol. Res.* 22(3), pp. 259-266.
- [9] S. J. Fellows., J. Noth and M. Schwarz, Precision grip and Parkinson's Disease, Brain, Oxford University Press, 1998, 121, pp. 1771-1784.
- [10] Markus kofler, Influence of transcutaneous electrical nerve stimulation cutaneous silent periods in humans, *Neuroscience letters*, 2004, 360, pp. 69-72.
- [11] W.T. Ang, C.N. Riviera and P.K. Khosla, Design and Implementation of the Active Error Cancelling in Hand-held Microsurgical Instrument. In Proceedings of the 2001 International Conference on Intelligent Robots and Systems., Carnegie Mellon University, Maui, Hawaii, USA., Oct. 29 - Nov. 03, pp. 1106-1111.
- [12] M. Engin, A recording and analysis system for human tremor. *Measurement.*, 40(3), 2007, pp. 288-293.
- [13] B. Pellegrini, L. Faes, G. Nollo and F. Schena, Quantifying the Contribution of Arm Postural Tremor to the outcome of goal-directed pointing task by displacement measures. *Journal of Neuroscience Methods*, 139(2), 2004, pp. 185-193.
- [14] J. Zhang, F. Chu and M. Nizamuddin, DSP Controller Based Signal Processing of Physiological Hand Tremor. American Control Conference; Portland, OR, USA, June 8-10, 2005, pp. 1569-1574.
- [15] R.J. Elble and J.E. Randall, Mechanistic components of normal hand tremor. *Electroencephalogr. J Clin Neurophysiol.*, 44, 1978, pp. 72-82.
- [16] I. Andrzej, M. Marcin, T. Ryszard, R. Monika, B. Jaroslaw and W. Ireneusz, Acquisition and Interpretation of Upper Limbs tremor signal in Parkinsonian Disease, 4th WSEAS International Conference on

- Electronic, Signal processing and control, Brazil, 21, 2005.
- [17] R.N. Stiles and J.E. Randall, Mechanical factors in human tremor frequency; *J Appl Physiol.*, 1967, 23(3), pp. 324-330.
- [18] R. Barker, Tremor. ACNR-Advances in Clinical Neuroscience & Rehabilitation., 4, 2004, pp. 13-14. <http://www.ancr.co.uk/pdfs/volume4issues1/management.pdf> [Accessed April, 2007].
- [19] S. Morrison, G. Kerr and P. Silburn, Bilateral tremor relations in Parkinson's disease: Effects of mechanical coupling and medication. *Parkinsonism and Related Disorders.* 14 (2008), 2007, pp. 298–308.
- [20] K.E. Norman, R. Edwards and A. Beuter, The Measurement of Tremor using a Velocity Transducer: Comparison to Simultaneous Recordings using Transducers of Displacement, Acceleration and Muscle Activity. *Journal of Neuroscience Methods*, 92, 1999, pp. 41-54.
- [21] S. Calzetti, M. Baratti, M. Gresty, and L. Findley, Frequency/Amplitude Characteristics of Postural Tremor of the Hands in a Population of Patients with Bilateral Essential Tremor: Implications for the Classification and Mechanism of Essential Tremor, *J Neurol Neurosur.* Ps, 50, 1987, pp. 561-567.
- [22] R.G. Dong, T.W. McDowell, D.E. Welcome, W.P. Smutz, A.W. Schopper, C. Warren, J. Z. Wu and S. Rakheja, On-the-hand measurement methods for assessing effectiveness of anti-vibration gloves. *Inter J Ind Ergonom.*, 32, 2003, pp. 283-298.
- [23] C. Duval, Rest and Postural Tremors in Patients with Parkinson's disease. USA. *J. Brain Res Bull.*, 70, 2006, pp. 44-48; PMID: 16750481.
- [24] R. Edwards, A. Beuter and L. Glass, Parkinsonian Tremor and Simplification in Network Dynamics. <http://www.idealibrary.com>, 51, 1999, pp. 157-177 (Accessed April, 2007).
- [25] B.B. Graham, Using an Accelerometer Sensor to Measure Human Hand Motion. Master Thesis, Massachusetts Institute of Technology, 2000.
- [26] D.O. Ibanez, F.P. Baquerin, D.Y. Choi and C.N. Riviere, Performance Envelope and Physical Tremor in Microsurgery, 2006, pp. 121-122.
- [27] S. Hayashi, A. Ando, T. Kittaka, and Y. Sakabe, Displacement Characteristics of Series-Type Bimorph actuator Under High Applied Voltage. *Japanese Journal of Applied Physics*, Vol.30, 1991, pp. 2285-2288.
- [28] Simon Lache, Upon Parametric sensitivity Used in Damping Active control for Human body Protection against Vibrations, 2006, pp. 168-173.
- [29] S. Smaga, M.D, Tremor. *American Family Physician*, 68(8), 2003, pp. 1545-1552.
- [30] R.G. Dong, S. Rakheja, T.W. McDowell, D.E. Welcome, J.Z. Wu, C. Warren, J. Barkley, B. Washington, and A.W. Schopper, A Method for Assessing the Effectiveness of Anti-vibration Gloves using Biodynamic Responses of the Hand-Arm System. *J. Sound Vib.*, 2004, pp. 1101-1118.
- [31] S. Kazi., A. As'arry., M. Z. Md. Zain., M. Mailah and M. Hussein., Biodynamic Response of the Human Hand-Arm Models under Vibration, 10th WSEAS International Conference on Automatic Control, Modelling and Simulation, Istanbul, Turkey, 2008, pp. 237-242.
- [32] I. Masaaki, K. Takeshi, W. Zhan-Jie, Hidemasaichikawa and M. Ryutaro, Micro Fabrication Technology of Ferroelectric Film and its Application to MEMS, 5th WSEAS Int. Conf. On Microelectronics, Nanoelectronics, Optoelectronics, 2006, pp. 147-150.
- [33] GlobalSpec Product Alert Piezoelectric Actuators. <http://www.globalspec.com/piezoelectric-actuator.html>, 1999 (Accessed on April 2007).
- [34] C. Sriram, D.K. Linder and Ralph C. Smith, Optimizing Design of Switching Amplifiers for Piezoelectric Actuators. *J Intel Mat Syst. Str.*, 11, 2000, pp. 887-901.