

Experimental Investigation of In-wheel Switched Reluctance Motor Driving System for Future Electric Vehicles

Jiongkang LIN¹ K.W. Eric CHENG¹ Zhu ZHANG¹ Xiangdang XUE¹

¹Department of Electrical Engineering, The Hong Kong Polytechnic University, Hung Hom, Kowloon
Email: eericky@polyu.edu.hk

Abstract – This paper presents an experimental direct driving system with in-wheel switched reluctance motor (SRM) for electrical vehicle (EV). The integrated EV direct driving system includes three main parts: the SRM model, driving circuit and control unit. The proposed 8/6 SRM is a novel motor with high performance; the specified external rotor type fits the requirement of in-wheel EV for saving space. The driving module consists of four independent drivers, is controlled by the micro-controller, DSP. The detailed hardware installment is presented to realize the EV direct driving system, with the block diagram to show the design of the driving system. Control flow of the specified system is introduced to describe the control procedure; various control methods are proposed and studied to verify the performance of SRM and the driving system. Speed control and constant torque/constant power control are implemented with PI control and hysteresis loop control, to test the speed response and reliability of the direct driving system. An experimental direct driving system is developed; the experimental results are obtained to verify the performances of the EV driving system.

Keywords – Electrical vehicle, direct driving, switched reluctance motor, speed control, constant torque/constant power control

I. INTRODUCTION

Electrical vehicle (EV), comparing to the traditional vehicle which is driven by internal combustion engine(ICE), applies an electrical machines as its prime mover and has many advantages: zero-emissions, high efficiency, independence from fossil fuel, and quiet and smooth operation[1][2]. Hence, electrical machines, along with the power electronics technologies, play an important role in the development of EV and provide a propulsion system with high performance and flexibility, especially for direct driving systems without gearbox.

The switched reluctance motor (SRM) is a novel electrical machine with high torque at low speed, making it a good candidate for direct driving purpose. Its torque is produced by the tendency of its moveable part to move to a position where the inductance of the excited winding is maximized [3]. Besides, the SRM has a simple and firm construction with no windings and permanent magnets in the stators and rotors. Since the geometrical simplicity of SRM, it has a lower cost of manufacturing and maintenance than other types of electrical machine, while the reliability and robustness appear to be improved. Furthermore, the driving power converter of SRM has an independent circuit for each phase, which provides the great advantages of inherent fault tolerance and the potential of high reliability.

Figure 1 shows the simple construct of in-wheel switched reluctance motor in this application. From the below figure,

the developed 8/6 SRM has an exterior rotor type to meet the requirement of in-wheel. The electrical machine is installed inside the tire of the electrical vehicle, to realize the direct driving purpose. The SRM has excellent torque-speed characteristics with high torque density [4-10]; also, the transmission efficiency is high, provides a highly reliable and simple drive system.

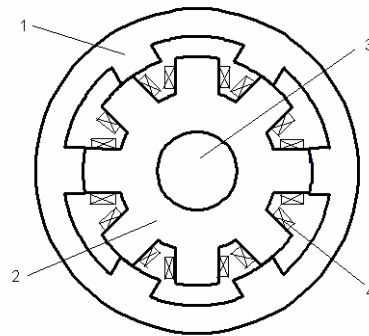


Fig. 1: Construct of in-wheel SRM (1-rotor; 2-stator; 3-shaft; 4-winding)

Based on the switched reluctance motor, an experimental direct driving system for electrical vehicle is introduced in this paper. A SRM with exterior rotor is applied for the assembly of in-wheel design, which saves space and provides great flexibility in motion control. The whole block diagram is presents first to show the design of the integrated direct driving system; the specified 8/6 SRM with external rotors is developed [4] to meets the requirement of in-wheel EV for saving space. The topology of driving module consisted of four independent drivers is presented with half bridge structure; a high performance micro-controller, DSP, is used to control the whole driving system with the accessorized position sensor and current sensor. Various control methods are proposed and studied to verify the performance of SRM, including starting and motoring, speed control based on PI controller. Also, constant torque/constant power curve is obtained through lots of experimental results.

In this paper, the design of the direct driving system for EV is presented in section II, section III discusses the various control methods for the driving system, section IV shows the experimental results to verify the dynamic performance of the direct driving EV system.

II. DESIGN OF THE DIRECT DRIVING SYSTEM

1. Block diagram of the direct driving system

The direct driving system of EV mainly consists of three parts: the electrical machine, an 8/6 type SRM; power converter with four independent inverters; and the DSP controller. The block diagram is shown in figure 2.

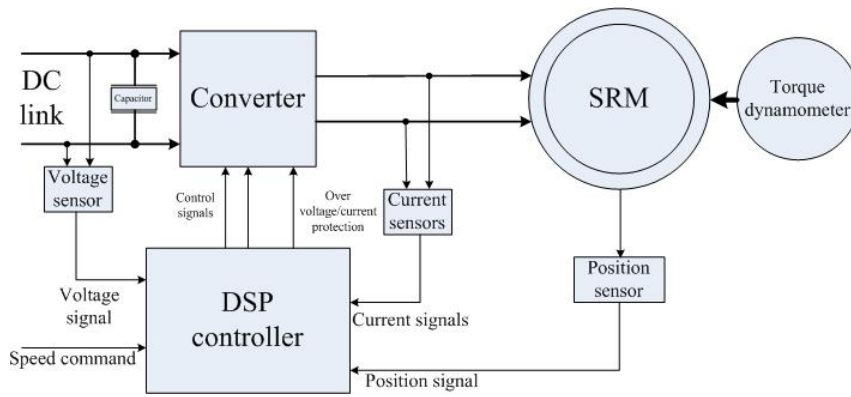


Fig. 2: Block diagram of the direct driving system

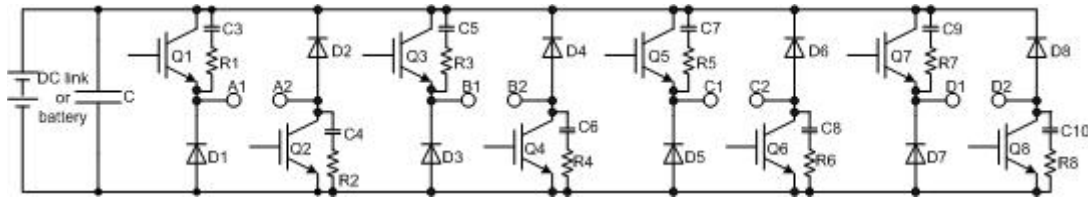


Fig. 3: Four-phase power converter

As shown in the above figure, a DC source, which is DC supply or batteries, is connected to the power converter. A torque dynamometer is connected to the rotor shaft of the SRM, to provide various torque loads and simulate different operating conditions. A block of sensors, including position sensor, voltage sensor and current sensors, are added to communicate with the DSP controller, and to protect the system from over-current and over-voltage.

2. Power converter

As shown in figure 3, there are four independent inverters in the power converter module, to drive four phases of the specified 8/6 SRM, respectively. Here, the winding of phase A is connected with two terminals, A1, A2, and so on. Eight IGBTs are used as the switches; the related RC snubber circuit is added to improve the performance of the inverter with decreasing di/dt .

During the conducting period of phase A, Q1 and Q2 are switched on, the current flows from Q1 to Q2 through the winding of phase A; when a chopping is needed to decrease the phase current, Q1 is turned off while Q2 keeps on, the current flows through Q2 and D1. Q1 and Q2 are both switched off when phase A is turned off, the current flows through D1 and D2 and decreases to zero.

3. DSP controller

In this application, a high performance DSP of TI is selected to implement the controller board. TMS320F2808 is a 32-bit digital signal processor with high-performance static CMOS technology. It is very powerful and flexible for motion control. The driving system can operate in a high switching frequency with its maximum operation frequency of 100 MHz.

Several modules of the DSP are used in this application: the referenced speed and feedback electrical signals are detected by ADC module; position signal is calculated by the capture module. Besides, 3 I/O pins are used to receive

the input commands, such as forward/backward, start/stop, motoring/braking; other I/O pins are used to output the drive signals to the converters, also the protection signals.

4. SRM module

The proposed electrical machine is an 8/6 SRM with the rating power of 5 kW. As we know, the inductance of the machine varies with the position of the rotor, as shown in figure 4. Actually, the phase inductance value is also affected by the phase current. The phase inductance has its minimum value at the fully unaligned position. Accompanied the movement of rotor, the phase inductance increases and reaches its maximum value at the fully aligned position. This is the period of motoring. In contrast, the rotor moves from fully aligned position to fully unaligned position in generating period.

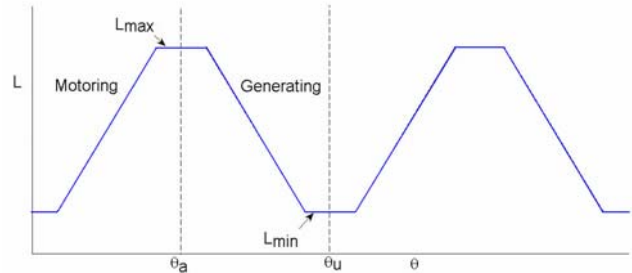


Fig. 4: Ideal inductance profile of the SRM

The variations of flux and torque of the SRM, depend not only on the current value, but also on the rotor position. The following equations show the relationships of flux λ and torque T with position θ and current i .

$$\lambda(i, \theta) = L(i, \theta)i \tag{1}$$

$$T(i, \theta) = \frac{1}{2}i^T \frac{dL}{d\theta}i \tag{2}$$

Since inductance L is a nonlinear function of θ for its saturation at fully aligned position, the flux λ and torque T are each a nonlinear function of θ and i . In fact, they are severely nonlinear so that it's hard to derive the analytical expressions of flux and torque. Because equations (1) and

(2) are hardly obtained, FEA method is an alternative for the motion control of the SRM.

The SRM characteristics of flux and torque are shown as above, obtained by FEA method. From figure 5, the flux is increasing from fully unaligned position (0°) to fully aligned position (30°); the level of saturation increases when the rotor is closer to the fully aligned position. In figure 6, the torque value depends on the derivation of inductance, indicating that the torque control is needed to be optimal for effective control.

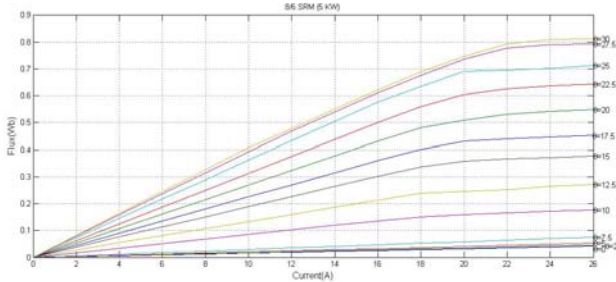


Fig. 5: Flux characteristics

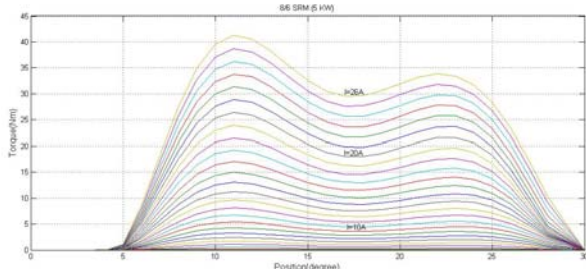


Fig. 6: Torque characteristics

III. CONTROL METHODS

1. Control flow

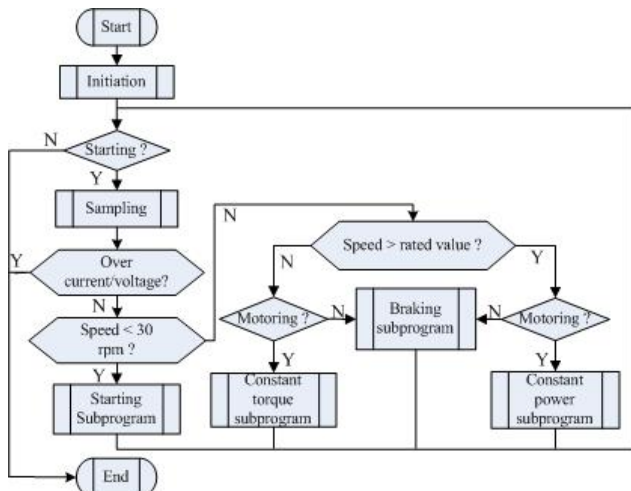


Fig. 7: Main flow chart of direct driving system

Figure 7 shows the main flow chart of the direct driving system. There are three signals to control the system: starting signal indicates the system to start or stop, motoring signal indicates the running status of the system, with motoring or braking; forward/backward signal determines the running direction of the driving system.

After sampling, the position signal, electrical signals and command signal are acquired by the DSP. The over current/voltage protection module is checked first by comparing the phase current and bus voltage with the preset maximum values, to guarantee the driving system is operating in a safe condition. The feedback position signal is used to calculate the rotor speed of the SRM. Two-phases starting method is adopted to improve the starting torque. When the starting speed exceeds 30rpm, the SRM switches to the motoring condition. In this application, the rated speed of SRM is 1000rpm. Constant torque control is applied when the speed is below the based speed; otherwise the SRM runs at constant power control; a PI control is adopted in the control system, to improve the robust of the driving system. Commutation of phase current will be occurred in the period of decreasing of the inductance, where a braking is needed.

2. Speed control

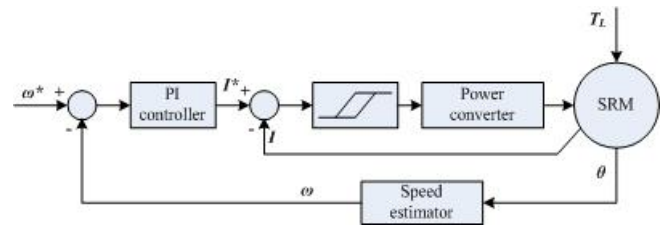


Fig. 8: Block diagram of speed control

Speed control is proposed to study the speed response of the EV. As shown in figure 8, ω and ω^* are the speed of the SRM and the referenced speed, respectively; θ is the position of the SRM; T_L is the mechanical torque load; I is the phases currents, I^* is the required currents generated by PI controller.

In this application, the position signal θ is derived by the position sensor, and is used to calculate the shaft speed ω . The speed error is used as the input of the PI controller, and the output is the referenced value of four-phase currents. The parameters of the PI controller are stimulated first by the simulation software and then modified by the experimental test. Hysteresis current control is employed here to switch the power converter. When the phase current is greater than the output current of PI controller, the DSP controller switches off the specified phase converter; and the phase converter is switched on while the phase current is lower than the output current generated by the PI controller. The load torque is generated by the torque dynamometer, to test the driving system's response in different load condition.

3. Constant torque/power control

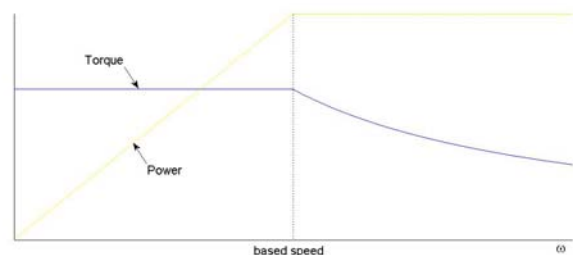


Fig. 9: Constant torque/constant power curve

Constant torque/constant power curve is the basic characteristic of electrical machines, as shown in figure 9. Similar to the synchronous speed for the synchronous machines, base speed is employed for the switched reluctance motor, which is the maximum speed while the rated torque is kept. Constant torque control is achieved below the base speed while the power increases linearly; the maximum power is acquired when the speed reached the base speed; then the torque starts to decrease to keep the power at its maximum value.

Constant torque/constant power curve is an indication of the performance of the SRM. Based on this curve, torque control and power control can be achieved. For the proposed SRM in the direct driving system, constant torque/constant power curve is tested by a series of experiments, to verify the performance of the SRM. Based on the speed control, a PI controller is applied in torque control to generate the required torque based on the error of speed. Torque distribution function is employed here to produce the required torque for each phase, then the phase current will be achieved by lookup the table described by figure 6. The block diagram of constant torque control is shown as below, similar with the constant power control.

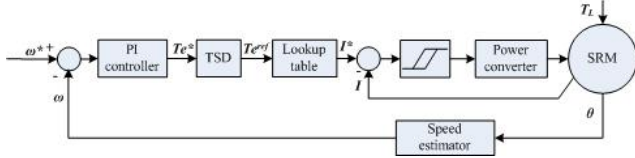


Fig. 10: Torque control of the direct driving system

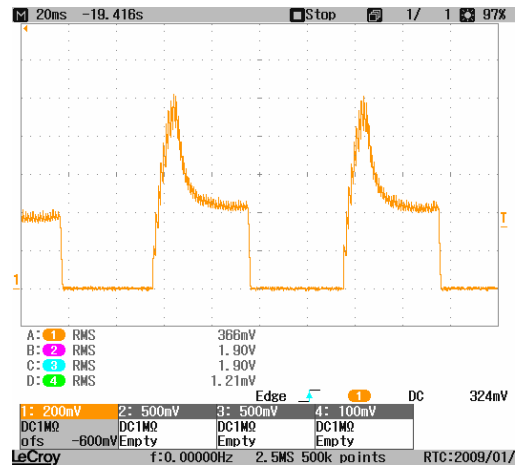
IV. EXPERIMENTAL RESULTS

The experimental direct driving system has been built at the lab. There are four modules in the EV experimental system: the SRM module, power converter module, DSP controller module and torque dynamometer. Figure 11 shows the hardware installment of the experimental system at the lab. In this application, the rating voltage is designed to 240V powered from a DC power supply or a battery source.

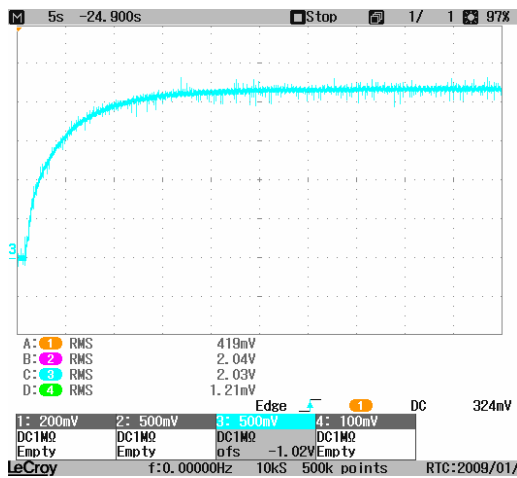


Fig. 11: Experimental direct driving system for EV

Figure 12 shows the two phases starting procedure with phase current and speed response. The load torque of the starting test is 2Nm, nearly no load starting. From 12.a), the phase winding is conducted at the fully unaligned position, and turned off at the fully aligned position. Current flows the winding at motoring period and generates positive torque, making the SRM starts more reliable. From 12.b), the speed increases smoothly and the SRM runs in a stable condition.



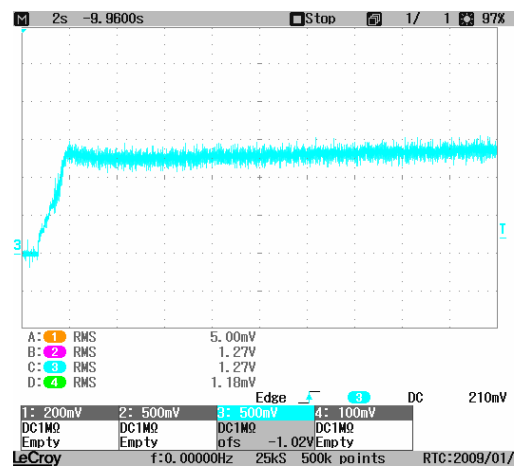
a) Phase current (unit: 2A/div)



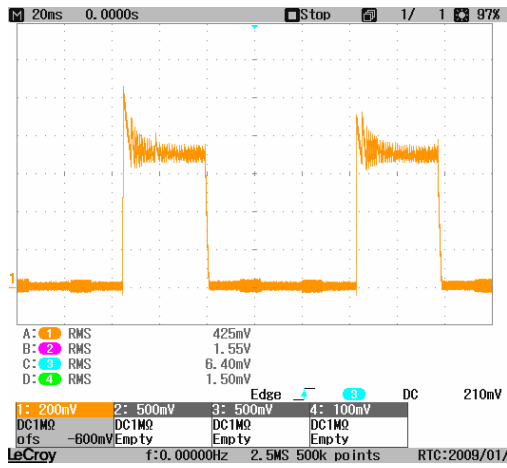
b) Speed response (unit: 20rpm/div)

Fig. 12: Two phase starting period

Figure 13 shows the speed control of the driving system. From 13.a), after successful starting, the speed of rotor increases rapidly to the required speed of 100 rpm while the load torque is kept at 2 Nm. PI controller is employed here to keep the speed to stay at 100 rpm; the parameters are well tuned with fast response and small overshoot. The phase current is restricted by hysteresis loop control as shown in 13.b).



a) Speed response (unit: 40 rpm/div)



b) Phase current (unit: 2A/div)

Fig. 13: Speed control of the direct driving system

Constant torque/constant power test is done to verify the performance of the SRM. For the test, 500 rpm is set to be the base speed. From 100 rpm to 800 rpm, totally 8 speed points are tested to obtain the constant torque/constant power curve under the load torque of 10 Nm, as shown in figure 14. Figure 15 shows the phase current of torque control, which at the speeds of 200 rpm, 500rpm and 800rpm, respectively. The RMS values of the phase currents are almost equal for the specified torque test, which is referred to equation (2).

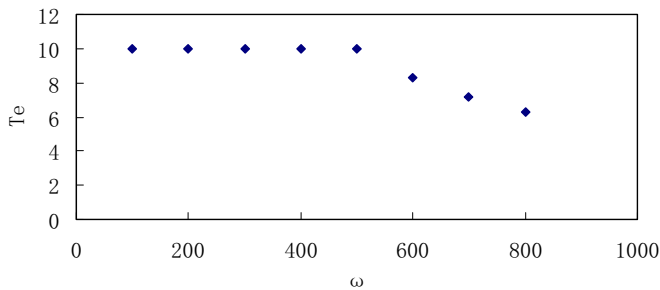
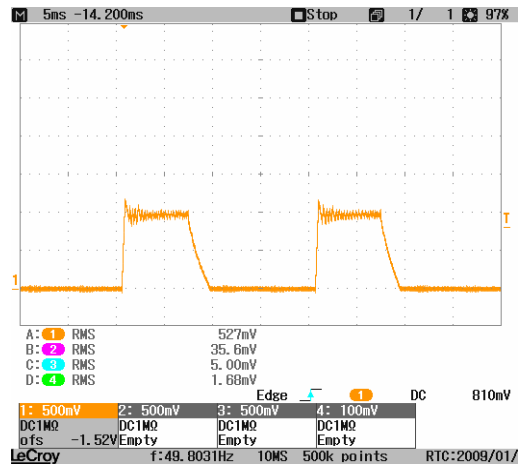


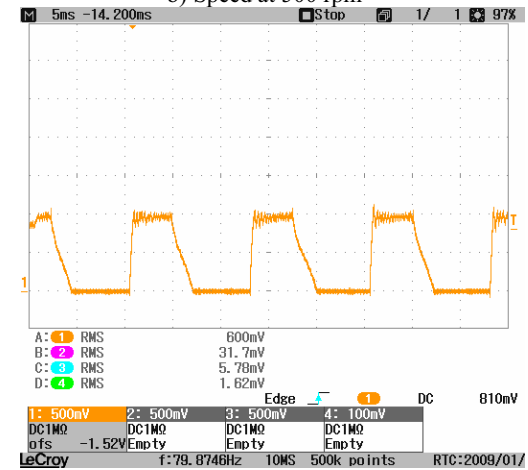
Fig. 14: Constant torque/constant power curve with 10 Nm



a) Speed at 200 rpm



b) Speed at 500 rpm



c) Speed at 800 rpm

Fig. 15: Phase current with load of 10 Nm (unit: 5A/div)

V. CONCLUSION

This paper presents a direct driving system of EV with the switched reluctance motor. The developed SRM with exterior rotor is applied to save space and provide high reliability and flexibility in motion control. DSP is used to obtain a reliable and high performance motion control with high switching frequency of converters. An experimental system is installed to verify the performance of the direct driving EV system. Speed control and constant torque/constant power control are done to illustrate the performance of the developed SRM and the speed response of the driving system. From the experimental results, the driving system can track the referenced speed rapidly and has a small overshoot. Besides, the torque/power characteristics of the driving system meet the requirement of the design, proving that the developed direct driving EV system is reliable for the industry application. Furthermore, torque ripple minimization will be studied to improve the performance of instantaneous torque of the SRM, hence to improve the speed response and loading effect to EV.

ACKNOWLEDGMENT

The authors gratefully acknowledge the financial support of Innovation and Technology Fund under the project reference ITP/013/07AP.

REFERENCES

- [1] Mehrdad Ehsani, *et al.*: 'Modern Electric, Hybrid Electric, and Fuel Cell Vehicles Fundamentals, Theory, and Design' (CRC Press, 2005)
- [2] C.C.Chan and K.T.chau, 'Modern Electric Vehicle Technology'(Oxford University Press, 2001)
- [3] T.J.E. Miller: 'Switched reluctance motors and their control' (Oxford University Press, 1993)
- [4] X.D. Xue, K. W. E. Cheng, et al.: 'Evaluation of Torque Sharing Functions for Torque Ripple Minimization in Switched Reluctance Motor Drives', IEEE IECON 2008.
- [5] X. D. Xue, K. W. E. Cheng, S. L. Ho, and K. F. Kwok, "Trigonometry-Based Numerical Method to Compute Nonlinear Magnetic Characteristics in Switched Reluctance Motors", IEEE Trans Magnetics, 2007, Volume 43, No. 4, April 2007, pp. 1845 – 1848.
- [6] X.D.Xue, K.W.E.Cheng, S.L.Ho, "A Position Stepping Method for Predicting Performances of Switched Reluctance Motor Drives", IEEE Trans. Energy Conversion, vol. 22, no. 4, Dec 2007, pp. 839-847.
- [7] X.D. Xue, K.W.E. Cheng and S.L. Ho, "Improvement of power factor in switched reluctance motor drives through optimizing in switching angles", Electric Power Components and Systems., Dec 2004, Vol. 32, No. 12, pp. 1225-1238.
- [8] X. D. Xue, K. W. E. Cheng and S. L. Ho, "A Self-Training Numerical Method to Calculate the Magnetic Characteristics for Switched Reluctance Motor Drives", IEEE Trans on Magnetics, Volume: 40 , Issue: 2 , March 2004, Pp734 – 737.
- [9] X.D. Xue , K.W.E. Cheng and S.L. Ho, "Simulation of Switched Reluctance Motor Drives Using Two-dimensional Bicubic Spline", IEEE Tran. Ene Con. Dec 2002, Vol. 17, Issue 4, pp. 471-477.
- [10] X.D.Xue, K.W.E.Cheng, S.L.Ho, "Online and Offline Rotary Regressive Analysis of Torque Estimator for SRM Drives", IEEE Trans Energy conversion, vol. 22, no. 4, Dec 2007, pp. 810-818.