

Experimental validation of a coexistence model of IEEE 802.15.4 and IEEE 802.11b/g networks

Citation for published version (APA):

Yuan, W., Wang, X., Linnartz, J. P. M. G., & Niemegeers, I. G. M. M. (2010). Experimental validation of a coexistence model of IEEE 802.15.4 and IEEE 802.11b/g networks. *International Journal of Communication Networks and Distributed Systems*, 2010, [581081]. <https://doi.org/10.1155/2010/581081>

DOI:

[10.1155/2010/581081](https://doi.org/10.1155/2010/581081)

Document status and date:

Published: 01/01/2010

Document Version:

Publisher's PDF, also known as Version of Record (includes final page, issue and volume numbers)

Please check the document version of this publication:

- A submitted manuscript is the version of the article upon submission and before peer-review. There can be important differences between the submitted version and the official published version of record. People interested in the research are advised to contact the author for the final version of the publication, or visit the DOI to the publisher's website.
- The final author version and the galley proof are versions of the publication after peer review.
- The final published version features the final layout of the paper including the volume, issue and page numbers.

[Link to publication](#)

General rights

Copyright and moral rights for the publications made accessible in the public portal are retained by the authors and/or other copyright owners and it is a condition of accessing publications that users recognise and abide by the legal requirements associated with these rights.

- Users may download and print one copy of any publication from the public portal for the purpose of private study or research.
- You may not further distribute the material or use it for any profit-making activity or commercial gain
- You may freely distribute the URL identifying the publication in the public portal.

If the publication is distributed under the terms of Article 25fa of the Dutch Copyright Act, indicated by the "Taverne" license above, please follow below link for the End User Agreement:

www.tue.nl/taverne

Take down policy

If you believe that this document breaches copyright please contact us at:

openaccess@tue.nl

providing details and we will investigate your claim.

Research Article

Experimental Validation of a Coexistence Model of IEEE 802.15.4 and IEEE 802.11b/g Networks

Wei Yuan,¹ Xiangyu Wang,¹ Jean-Paul M. G. Linnartz,² and Ignas G. M. M. Niemegeers³

¹Department of Distributed Sensor Systems (DSS), Philips Research Nat.Lab., HTC 34, WB1, 5656 AE Eindhoven, The Netherlands

²Department of Electronic Systems and Silicon Integration (ESSI), Philips Research Nat.Lab., HTC 37, 5.005, 5656 AE Eindhoven, The Netherlands

³Wireless and Mobile Communication Group, Faculty of Electrical Engineering, Mathematics, and Computer Science (EEMCS), Delft University of Technology, P.O. Box 5031, 2600 GA Delft, The Netherlands

Correspondence should be addressed to Xiangyu Wang, xiangyu.wang@philips.com

Received 15 January 2009; Revised 1 April 2009; Accepted 15 May 2009

Copyright © 2010 Wei Yuan et al. This is an open access article distributed under the Creative Commons Attribution License, which permits unrestricted use, distribution, and reproduction in any medium, provided the original work is properly cited.

As IEEE 802.15.4 Wireless Sensor Networks (WSNs) and IEEE 802.11b/g Wireless Local Area Networks (WLANs) are often collocated, coexistence issues arise as these networks share the same 2.4 GHz Industrial, Scientific, and Medical (ISM) band. Consequently, their performance may degrade. We have proposed a coexistence model of IEEE 802.15.4 and IEEE 802.11b/g networks, which addresses their coexistence behavior and explains their coexistence performance. As an extension of the previous work, a compact testbed was developed and experiments on the coexistence issues between these networks were conducted. The experiments not only validated the theoretical model but also provided more information and insights about the coexistence issues in the real-life environment.

1. Introduction

IEEE 802.15.4 Wireless Sensor Networks (WSNs) are becoming increasingly popular. Because of their applications, for example, in hospitals and home [1], WSNs are often collocated with IEEE 802.11b/g Wireless Local Area Networks (WLANs), which gives rise to coexistence issues as they both operate in the license-free 2.4 GHz Industrial, Scientific, and Medical (ISM) band.

There have been some studies about the coexistence issues between the IEEE 802.11b/g WLANs and IEEE 802.15.4 WSNs [2–5]. Particularly in [5], we presented a coexistence model of IEEE 802.15.4 WSNs and IEEE 802.11b/g WLANs. In two aspects, namely, power and timing, the model addresses the interaction between these two types of wireless networks and explains their coexistence performance. These two aspects jointly impose specific impacts on the performance of IEEE 802.15.4 WSNs and IEEE 802.11b/g WLANs, depending on the coexistence situations. In order to validate the model and get a better understanding of the coexistence issues in real-life situations, we conducted a number of experiments, which will be presented in detail in this paper. The remainder of the

paper is organized as follows. Section 2 gives an overview of the IEEE 802.11b/g standard, IEEE 802.15.4 standard, and the coexistence model. Section 3 describes our testbed. The experimental results are presented in Section 4. The conclusion is drawn in Section 5.

2. Overview of IEEE 802.11b/g, IEEE 802.15.4, and a Coexistence Model

2.1. IEEE 802.11b/g. The IEEE 802.11b and IEEE 802.11g standards define the Medium Access Control (MAC) sub-layer and the Physical (PHY) layer for WLANs. Both standards operate at 13 overlapping channels in the 2.4 GHz ISM band and the bandwidth of each channel is 22 MHz. The IEEE 802.11b/g MAC employs the Carrier Sense Multiple Access with Collision Avoidance (CSMA/CA) mechanism. Clear Channel Assessment (CCA) is used in the physical layer to determine the channel occupancy [6]. CCA performs Energy Detection (ED), or Carrier Sense (CS), or a combination of two, that is, CCA shall report a busy channel upon detection of any energy above the ED threshold, or a signal with the known features, for example, the modulation

and spreading characteristics, or a known signal with energy above the ED threshold. Owing to involving only integrating the square of the received signal or signal envelop over a CCA duration, ED is a universal mechanism that can be deployed in all systems without requiring any knowledge of the type of underlying modulation scheme employed at the physical layer [7]. Therefore, in the heterogenous network environment, only ED can, though unreliably [7], sense the channel occupancy of other types of networks.

Before initiating a transmission, an IEEE 802.11b/g node senses the channel using either ED or CS (or both) to check whether it is busy because of the transmissions by other nodes. If the channel is sensed idle for a Distributed coordination function InterFrame Space (DIFS) time interval the node will transmit a packet. Otherwise, the node defers its transmission. As the channel becomes idle for a DIFS interval, the node will generate a random backoff delay uniformly chosen in a Contention Window (CW), that is, $[0, W]$, where W is the size of the CW. The backoff timer decreases by one as long as the channel is sensed idle for a backoff time slot. The backoff counter will be frozen when a transmission is detected on the channel, and resumed when the channel is sensed idle again for a DIFS interval. When the backoff timer counts down to zero, the node transmits a packet. Immediately after receiving a packet correctly, the destination node waits for a Short InterFrame Spacing (SIFS) interval and then sends an ACK back to the source node. If the source node receives the ACK, the size of CW remains the same value; otherwise, it doubles.

2.2. IEEE 802.15.4. The IEEE 802.15.4 standard defines the MAC sublayer and the PHY layer. Its operational frequency bands include the 2.4 GHz ISM band. The IEEE 802.15.4 WSNs also employ CSMA/CA for the medium access control. There are two versions of IEEE 802.15.4 CSMA/CA: slotted and unslotted. In this paper, we discuss only the popular unslotted one. In IEEE 802.15.4 WSNs, the channel is sensed only during a CCA period rather than during both a CCA and a backoff period like in IEEE 802.11b/g WLANs. Moreover, if the channel is sensed busy during the CCA period, the size of CW in IEEE 802.15.4 WSNs doubles, and when the number of the channel access attempts exceeds $macMaxCSMABackoffs$, the maximum number of backoffs the CSMA-CA algorithm will attempt before declaring a channel access failure [8], the pending packet is discarded. We call this kind of packet loss as *inhibition loss*.

2.3. A Coexistence Model of IEEE 802.11b/g and IEEE 802.15.4 Networks. The coexistence model of IEEE 802.11b/g and IEEE 802.15.4 networks in [5] includes two aspects, namely power and timing, which are described as follows.

2.3.1. Power Aspect. The transmit powers of IEEE 802.11b/g nodes and IEEE 802.15.4 nodes are typically 100 mW [6] and 1 mW [8], respectively. In case of comparable CCA thresholds, the significant difference in the transmit power can result in three distinct regions as illustrated in Figure 1:

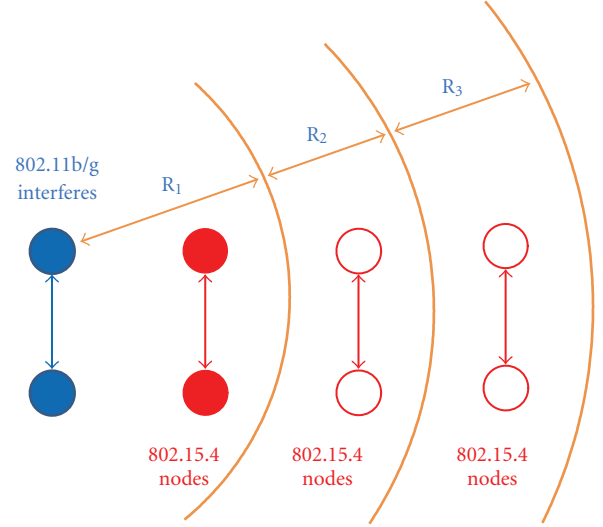

FIGURE 1: Coexistence regions of IEEE 802.15.4 and IEEE 802.11b/g.

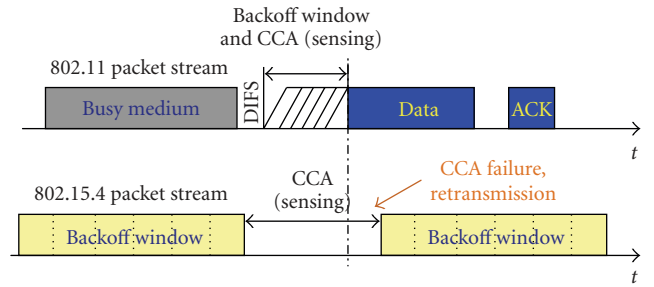

FIGURE 2: In R1, the shorter timing gives IEEE 802.11b/g nodes priority over IEEE 802.15.4 nodes to access the channel and therefore causes unfairness to the IEEE 802.15.4 nodes.

- R1: a region in which IEEE 802.15.4 nodes and IEEE 802.11b/g nodes can sense each other,
- R2: a region in which IEEE 802.15.4 nodes can sense IEEE 802.11b/g nodes, but not *vice versa*,
- R3: a region in which neither can sense the other, but IEEE 802.15.4 nodes could still suffer IEEE 802.11b/g interference.

2.3.2. Timing Aspect. In R1, an IEEE 802.11b/g node and an IEEE 802.15.4 node can sense each other via ED and therefore both of their CSMA/CA mechanisms work, that is, as one is transmitting, the other has to be waiting. IEEE 802.15.4 nodes, however, typically have a 10–30 times longer timing than IEEE 802.11b/g nodes, for example, the backoff slot unit is $320 \mu\text{s}$, $20 \mu\text{s}$ and $9 \mu\text{s}$ for IEEE 802.15.4, IEEE 802.11b and IEEE 802.11g, respectively, shown in Table 1. The shorter timing gives IEEE 802.11b/g nodes priority over IEEE 802.15.4 nodes to access the channel and therefore causes unfairness to the IEEE 802.15.4 nodes in R1. This is illustrated in Figure 2.

TABLE 1: IEEE 802.15.4 and IEEE 802.11b/g system parameters and additional parameters used in experiments.

	IEEE 802.15.4	IEEE 802.11b	IEEE 802.11g
Transmit power	0 dBm	17 dBm	17 dBm
Receiver sensitivity	-85 dBm	-76 dBm	-82 dBm
Bandwidth	2 MHz	22 MHz	22 MHz
Data rate	250 kbps	11 Mbps	54 Mbps
Backoff unit T_{bs}	320 μ s	20 μ s	9 μ s
SIFS	192 μ s	10 μ s	10 μ s
DIFS	N/A	50 μ s	28 μ s
CCA duration	128 μ s	$\leq 15 \mu$ s	$\leq 4 \mu$ s
CCA threshold	-85 dBm	-84 dBm	-84 dBm
CW_{min}	7	31	15
Center frequency	2410 MHz	2412 MHz	2412 MHz
Payload size	30 bytes	1500 bytes	1500 bytes
ACK	No	Yes	Yes
Transmit intensity	Every 20 ms	Saturated	Saturated

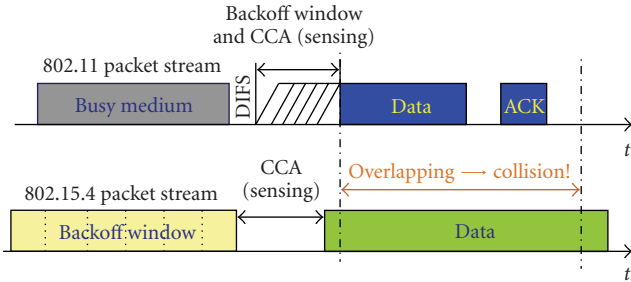

FIGURE 3: In R2, IEEE 802.11b/g nodes fails to sense IEEE 802.15.4 nodes.

In R2, IEEE 802.15.4 nodes can sense IEEE 802.11b/g nodes but not *vice versa* given the comparable CCA thresholds, because the transmit power of IEEE 802.11b/g nodes is much higher than that of IEEE 802.15.4 nodes. As a consequence, when IEEE 802.11b/g nodes are transmitting, IEEE 802.15.4 nodes have to be waiting, whereas when IEEE 802.15.4 nodes are transmitting, IEEE 802.11b/g nodes are not aware and thus simply proceed to transmit, probably causing an overlapping in packet transmissions. This is shown in Figure 3.

In R3, neither IEEE 802.15.4 nodes nor IEEE 802.11b/g nodes can sense the other. However, IEEE 802.15.4 nodes may still suffer from the IEEE 802.11b/g interference in case of weak IEEE 802.15.4 links, as we will show in Section 4.

3. Testbed

We set up a compact testbed to check whether the three regions described in Section 2.3 exist in practice and to get a better understanding about the coexistence issue. Note that we use only the IEEE 802.11b mode in the test, but the result is also applicable to the IEEE 802.11g case. As shown in Figure 4, the testbed consists of the following items:

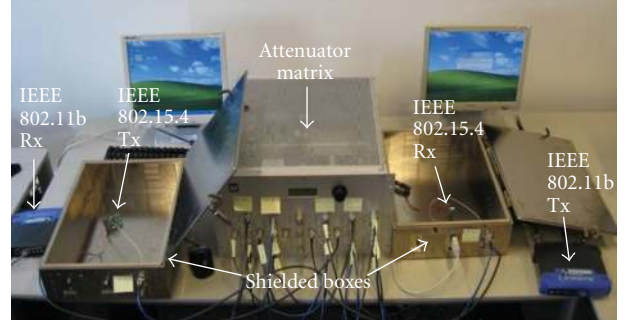

FIGURE 4: Testbed of the coexistence model of IEEE 802.11b and IEEE 802.15.4 networks.

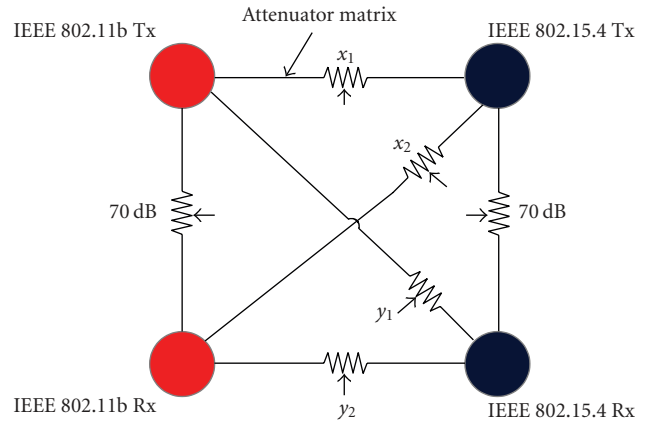

FIGURE 5: Functional diagram of the coexistence testbed.

- (i) two IEEE 802.11b nodes (Linksys WRT54G): a Tx and an Rx,
- (ii) two IEEE 802.15.4 nodes (AquisGrain [9]): a Tx and an Rx,
- (iii) two RF-shielded isolation boxes,
- (iv) one attenuator matrix box,
- (v) two PCs with testing software.

The antennas of IEEE 802.11b nodes and IEEE 802.15.4 nodes are connected by cables via the attenuator matrix, the attenuation values of which can be adjusted to emulate the physical distance in a wireless environment. To isolate from other RF interference, IEEE 802.15.4 nodes were put into the RF-shielded isolation boxes such that we got a controlled RF environment, allowing the measurements repeatable.

A functional diagram of the testbed is depicted in Figure 5. The attenuation losses among those nodes are as follows,

- (i) x_1 : between IEEE 802.11b Tx and IEEE 802.15.4 Tx,
- (ii) x_2 : between IEEE 802.11b Rx and IEEE 802.15.4 Tx,
- (iii) y_1 : between IEEE 802.11b Tx and IEEE 802.15.4 Rx,
- (iv) y_2 : between IEEE 802.11b Rx and IEEE 802.15.4 Rx.

x_1 , x_2 , y_1 , and y_2 are adjustable, from 32 dB to 212 dB. Moreover, we set both the attenuation losses between IEEE

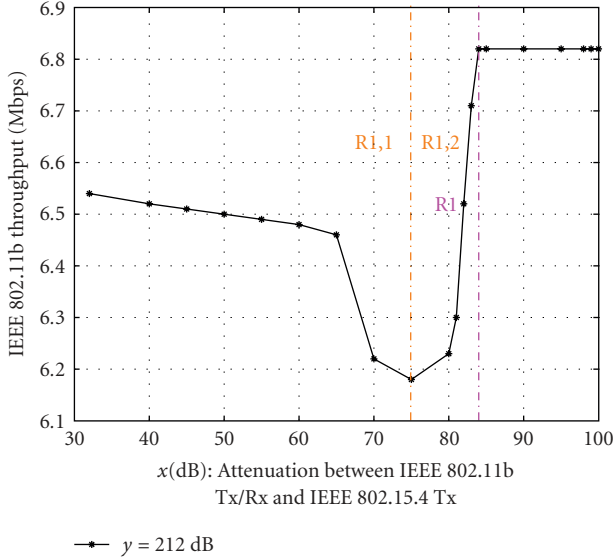

FIGURE 6: In R1: IEEE 802.11b/g nodes can also sense IEEE 802.15.4 traffic.

802.11b Tx and Rx and between IEEE 802.15.4 Tx and Rx as 70 dB, so that the two links have a very good quality, that is, the packet loss ratio of the IEEE 802.15.4 link is close to zero and the throughput of the IEEE 802.11b link is 6.82 Mbps, the maximum value achievable in our case given the parameter values in Table 1.

4. Experiments

In our experiments, the IEEE 802.15.4 Tx constantly sends only broadcast packets and the IEEE 802.15.4 Rx does not send any packets including ACKs. The IEEE 802.11b Tx generates a saturated packet stream and the IEEE 802.11b Rx sends ACKs only. Moreover, we made the IEEE 802.11b Tx and the Rx have the same impact to the IEEE 802.15.4 Tx and to the IEEE 802.15.4 Rx, respectively. We therefore always set the same values for x_1 and x_2 , and y_1 and y_2 , respectively. For brevity sake, we let $x = x_1 = x_2$ and $y = y_1 = y_2$.

Before carrying out the experiments, let us calculate R1, R2 and R3, given the parameter values in Table 1.

R1: Given the IEEE 802.15.4 transmit power of 0 dBm and the IEEE 802.11b CCA threshold of -84 dBm, when $x \geq 84$ dB, the IEEE 802.11b nodes will not be able to sense the IEEE 802.15.4 nodes, that is, R1 is the region where $x < 84$ dB.

R3: Although the IEEE 802.11b transmit power is 17 dBm, only 16.9% falls into the 2 MHz band of IEEE 802.15.4 [10], that is, 9.3 dBm. Given the CCA threshold of -85 dBm, the IEEE 802.15.4 nodes will not be able to sense the IEEE 802.11b nodes when $x \geq 94.3$ dB, that is, R3 is the region where $x \geq 94.3$ dB.

R2: By definition, R2 is in between R1 and R3, that is, R2 is the region where $84 \text{ dB} \leq x < 94.3 \text{ dB}$.

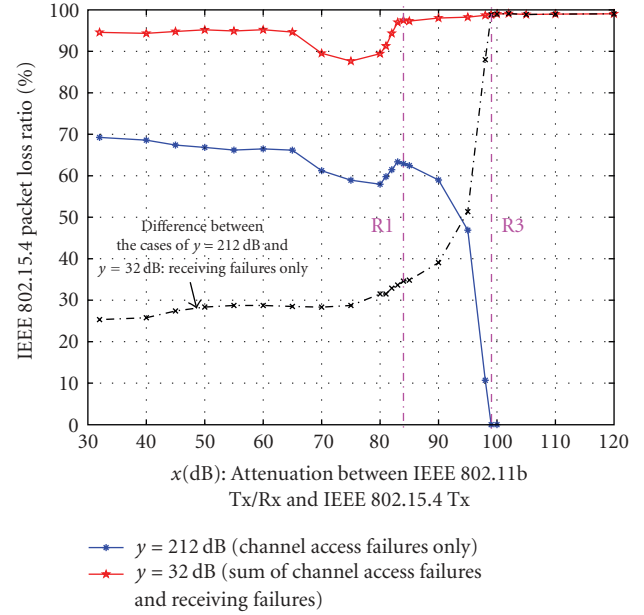

FIGURE 7: IEEE 802.15.4 Tx CCA Failure Rate.

Now let us carry out the experiments to identify these regions. For convenience, we start with identifying R1, followed by R3 and R2.

4.1. *R1 Identification.* To identify R1 and to investigate details of the coexistence behavior of IEEE 802.11b and IEEE 802.15.4 networks, we measure the IEEE 802.11b throughput and the IEEE 802.15.4 packet loss ratio in the following two cases.

4.1.1. *y = 212 dB (Inhibition Loss Only).* Given such a high attenuation loss, the IEEE 802.11b Tx and Rx have actually no any impact on the IEEE 802.15.4 Rx but only on the Tx. Therefore, in this case, the IEEE 802.15.4 packet loss is not due to collision but only inhibition. As the IEEE 802.15.4 Rx does not send any packets including ACKs in our experiments, only the IEEE 802.15.4 Tx could affect the throughput of the IEEE 802.11b network. Thus, we can adjust only x to observe the impact of the IEEE 802.15.4 Tx on the IEEE 802.11b Tx and Rx.

As an example, in Figure 6, we can see that as $x = 32$ dB, the IEEE 802.11b throughput is approximately 6.54 Mbps, less than its maximum, that is, 6.82 Mbps, which suggests that the IEEE 802.11b network is suffering, though not very seriously, from the IEEE 802.15.4 traffic.

As x increases, we expected the IEEE 802.11b throughput to increase as well because of the weakening IEEE 802.15.4 Tx impact. However, we surprisingly found in Figure 6 that as x increases until about 75 dB, the IEEE 802.11b throughput actually decreases, which suggests that the impact of the IEEE 802.15.4 Tx on the IEEE 802.11b network increases rather than decreases. This is confirmed by Figure 7, in which we can see that for $32 \text{ dB} < x < 80 \text{ dB}$, as x increases, the IEEE 802.15.4 CCA failure rate decreases, which suggests that more IEEE 802.15.4 packets were sent out indeed and

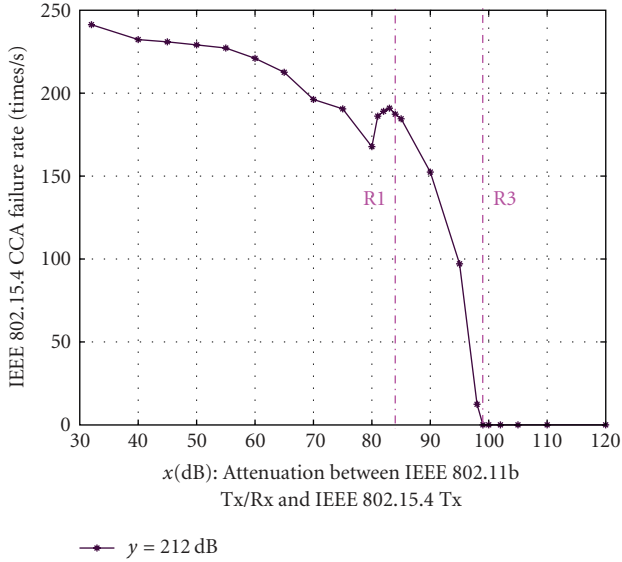

FIGURE 8: In R3: neither can sense the other, but IEEE 802.15.4 nodes could still suffer IEEE 802.11b/g interference.

the impact of the IEEE 802.15.4 Tx on the IEEE 802.11b network therefore increases. We think it is because that as x increases, the missed probability of the IEEE 802.15.4 ED increases and consequently, more often the IEEE 802.15.4 Tx senses the channel idle and then sends out more packets than it should, which lowers the channel occupancy of the IEEE 802.11b traffic and thus the throughput of the IEEE 802.11b network. As addressed in [7], with a high missed probability, ED is not a reliable CCA method. Especially, as the detected signal weakens, the missed probability of ED goes even higher.

In Figure 6, for $75 \text{ dB} < x < 84 \text{ dB}$, as x increases, the IEEE 802.11b throughput increases, which suggests the influence from the IEEE 802.15.4 Tx is getting less. This is because the IEEE 802.11b Tx/Rx are leaving the region where they are able to sense the IEEE 802.15.4 Tx.

For $x \geq 84 \text{ dB}$, as x increases, the IEEE 802.11b throughput keeps constant at its maximum, that is, 6.82 Mbps, suggesting that the IEEE 802.11b Tx/Rx are not able to sense the IEEE 802.15.4 Tx and therefore not affected by the IEEE 802.15.4 Tx anymore. On the other hand, from the Figure 8 we see that in the region of $x < 84 \text{ dB}$, the IEEE 802.15.4 Tx has a high packet loss ratio, which suggests it can sense IEEE 802.11b traffic there. We therefore conclude the region where $x < 84 \text{ dB}$ is R1. We may further divide R1 into two subregions as R1,1 ($x < 75 \text{ dB}$) and R1,2 ($75 \text{ dB} < x < 84 \text{ dB}$), illustrated in Figure 6. R1,2 is a transition region, where the IEEE 802.11b Tx is leaving the region in which it is able to sense the IEEE 802.15.4 nodes.

Note that the curve of “inhibition loss only ($y = 212 \text{ dB}$)” case in Figure 8 is not monotonic. We see that when $x \geq 80 \text{ dB}$, there is a “hump”, that is, the IEEE 802.15.4 packet loss ratio goes up first until $x = 83 \text{ dB}$ and then goes down

again till to zero at $x = 98 \text{ dB}$. The “hump” is because the IEEE 802.11b Tx and Rx are leaving R1, as shown in Figure 6, and therefore getting less influence from the IEEE 802.15.4 traffic, which results in more IEEE 802.11b packets sent out and therefore more IEEE 802.15.4 inhibition loss. For $x \geq 83 \text{ dB}$, as x increases, although more IEEE 802.11b packets are sent out, these packets cause only decreasing IEEE 802.15.4 inhibition loss because of their weakening power. For $x \geq 98 \text{ dB}$, the IEEE 802.15.4 packet loss ratio equals zero, which means that IEEE 802.15.4 Tx cannot sense IEEE 802.11b traffic anymore and therefore does not suffer from the inhibition loss. This is confirmed in Figure 7, where we can see that the IEEE 802.15.4 CCA failure stays zero for $x \geq 98 \text{ dB}$.

It is worthy of noting that according to [2–4], IEEE 802.15.4 WSNs has little impact on the IEEE 802.11 WLANs performance. This conclusion is true in general, but may not hold in some cases. For example, in Figure 6, we see that for $70 \text{ dB} < x < 80 \text{ dB}$, the IEEE 802.11b throughput is about 6.2 Mbps, approximately 10% less than its maximum, that is, 6.82 Mbps. In case of weaker IEEE 802.11b links and a heavier IEEE 802.15.4 traffic, the IEEE 802.11b throughput will get even lower.

Although R1 has been identified, to reveal more details of the coexistence behavior of IEEE 802.11b and IEEE 802.15.4 networks, with an emphasis on the impact from the IEEE 802.11b traffic on the IEEE 802.15.4 network, we further measured the IEEE 802.15.4 packet loss ratio in the following case.

4.1.2. $y = 32 \text{ dB}$ (Inhibition Loss + Collision Loss). In this case, the IEEE 802.11b Tx and Rx influence not only the IEEE 802.15.4 Tx but also the IEEE 802.15.4 Rx. As a consequence, the IEEE 802.15.4 packet loss is not only due to the inhibition loss but also to the collision loss. As described in Section 4.1.1, as x increases, the CCA performance decreases, resulting a decrease in the inhibition loss (the only exception happens for $80 \text{ dB} < x < 84 \text{ dB}$, which will be discussed later.) and an increase in the collision loss. More specifically, as x increases, more often the IEEE 802.15.4 Tx senses the channel idle and therefore transmits more packets than it should. The inhibition loss thus decreases. However, on the other hand, most of these packets will be collided by IEEE 802.11b packets and the collision loss therefore increases. Whether the overall IEEE 802.15.4 packet loss ratio increases or decreases, depends on which is dominant, the decrease in the inhibition loss or the increase in the collision loss.

From the curve of “inhibition loss + collision loss ($y = 32 \text{ dB}$)” in Figure 8, we can see that for $32 \text{ dB} < x < 65 \text{ dB}$, as x increases, the IEEE 802.15.4 packet loss ratio keeps approximately constant, which suggests that the decrease in the inhibition loss at the IEEE 802.15.4 Tx and the increase in the collision loss at the IEEE 802.15.4 Rx are comparable, shown as the curve of “inhibition loss only ($y = 212 \text{ dB}$)” case and the curve of the difference between the cases of $y = 212 \text{ dB}$ and $y = 32 \text{ dB}$.

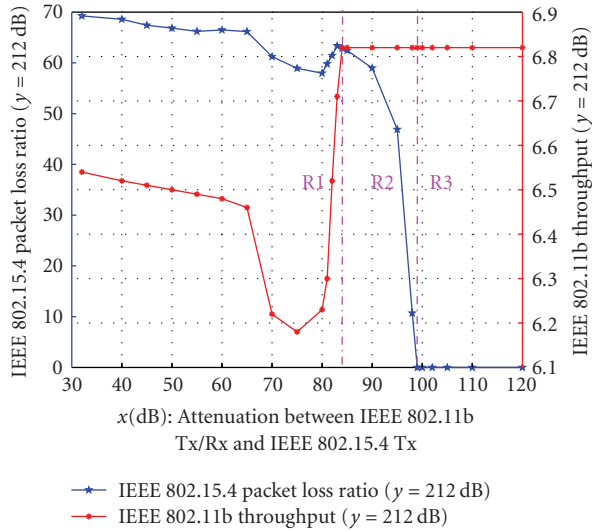

FIGURE 9: In R2: IEEE 802.15.4 nodes can sense IEEE 802.11b/g nodes, but not *vice versa*.

- (i) For $65 \text{ dB} < x < 75 \text{ dB}$, the IEEE 802.15.4 packet loss ratio decreases since the inhibition loss decreases sharply, while the collision loss keep almost constant.
- (ii) For $75 \text{ dB} < x < 80 \text{ dB}$, the dominant collision loss increases accounts for the increase in the IEEE 802.15.4 packet loss ratio.
- (iii) For $80 \text{ dB} < x < 84 \text{ dB}$, the inhibition loss increases rather than decreases as usual. This is because the IEEE 802.11b Tx and Rx are leaving R1, shown in Figure 6, and getting less influence from the IEEE 802.15.4 traffic, much more IEEE 802.11b packets are therefore sent out, causing a sharp increase in the inhibition loss at the IEEE 802.15.4 Tx. Moreover, the collision loss also increase. Therefore, the IEEE 802.15.4 packet loss ratio increases.
- (iv) For $84 \text{ dB} < x < 98 \text{ dB}$, the collision loss is slightly dominant, which accounts for the slightly increased IEEE 802.15.4 packet loss ratio.
- (v) For $x \geq 98 \text{ dB}$, the IEEE 802.15.4 packet loss ratio keeps a high value close to 100%. In this case, only the collision loss exists as there is no inhibition loss anymore.

Given the detailed discussion about the coexistence behavior of IEEE 802.11b and IEEE 802.15.4 networks above in R1, the identification of R3 and R2 is straightforward as follows.

4.2. R3 Identification. From the curve of “inhibition loss only ($y = 212 \text{ dB}$)” in Figure 8, we see that as $x \geq 98 \text{ dB}$, the IEEE 802.15.4 packet loss ratio owing to the inhibition loss goes down till to zero, which means that IEEE 802.15.4 Tx cannot sense IEEE 802.11b traffic and therefore does not suffer from the inhibition loss anymore. This is confirmed in Figure 7, where we can see that the IEEE 802.15.4 CCA

failure rate goes down till zero as $x \geq 98 \text{ dB}$. We therefore conclude that in the region where $x \geq 98 \text{ dB}$, neither IEEE 802.15.4 nodes nor IEEE 802.11b nodes can sense the other, but IEEE 802.15.4 nodes may still suffer from the IEEE 802.11b interference, which is exactly what R3 defines. Note that $R3 \geq 98 \text{ dB}$ here is 3.7 dB more than that we have calculated, that is, 94.3 dB and this difference may be attributed to the errors in the measurement and/or the hardware implementation.

4.3. R2 Identification. For convenience, Figure 6 is superimposed on Figure 8, resulting in Figure 9. We can see that in the region between R1 and R3, that is, $84 \text{ dB} < x < 98 \text{ dB}$, there are still some IEEE 802.15.4 packets loss owing to the inhibition loss, which suggests in that region, IEEE 802.15.4 Tx can still sense the IEEE 802.11b Tx/Rx, while not *vice versa*. This is exactly the region which R2 defines.

Upon till now, all R1, R2 and R3 are clearly identified and the coexistence model in [5] is validated by the experiments.

5. Conclusion

As an extension of the previous work, experiments on the coexistence issues between an IEEE 802.11b WLAN and an IEEE 802.15.4 WSN were conducted. The experiments clearly validated the coexistence model we had proposed and therefore confirmed its usefulness in the explanation and prediction of the coexistence behavior of IEEE 802.11b/g and IEEE 802.15.4 networks. Furthermore, we gained more insights on the coexistence issue from the experiments, for example, the imperfect CCA performance, that is, CCA could miss the detection of the ongoing packet transmission in the channel, which may therefore result in the transmission collision. For another example, the experiments showed that in some cases, IEEE 802.15.4 WSNs may have a nonnegligible impact on the performance of IEEE 802.11b/g WLANs. We believe that based on such a thoroughly understanding about the coexistence issue, our coexistence model is helpful for researchers to resolve the coexistence issues between IEEE 802.11b/g WLANs and IEEE 802.15.4 WSNs.

Acknowledgment

This work was partially supported by the Dutch Freeband PNP 2008 project.

References

- [1] A. Soomro and D. Cavalcanti, “Opportunities and challenges in using WPAN and WLAN technologies in medical environments,” *IEEE Communications Magazine*, vol. 45, no. 2, pp. 114–122, 2007.
- [2] M. Petrova, J. Riihijärvi, P. Mähönen, and S. Laella, “Performance study of IEEE 802.15.4 using measurements and simulations,” in *Proceedings of the IEEE Wireless Communications and Networking Conference (WCNC '06)*, pp. 487–492, Las Vegas, Nev, USA, April 2006.

- [3] I. Howitt and J. A. Gutierrez, "IEEE 802.15.4 low-rate wireless personal area network coexistence issues," in *Proceedings of the IEEE Wireless Communications and Networking (WCNC '03)*, vol. 3, pp. 1481–1486, New Orleans, La, USA, March 2003.
- [4] A. Sikora, "Compatibility of IEEE 802.15.4 (ZigBee) with IEEE 802.11 (WLAN), Bluetooth, and Microwave Ovens in 2.4 GHz ISM-Band," Test Report. Steinbeis-Transfer Center, University of Cooperative Education, Lörrach. September 2004.
- [5] W. Yuan, X. Wang, and J.-P. M. G. Linnartz, "A coexistence model of IEEE 802.15.4 and IEEE 802.11b/g," in *Proceedings of the 14th IEEE Symposium on Communications and Vehicular Technology in the Benelux (SCVT '07)*, Delft, The Netherlands, November 2007.
- [6] *IEEE Std. 802.11 Wireless MAC and PHY Layer Spec.*, 1999.
- [7] I. Ramachandran and S. Roy, "Clear channel assessment in energy-constrained wideband wireless networks," *IEEE Wireless Communications*, vol. 14, no. 3, pp. 70–78, 2007.
- [8] IEEE Std. 802.15.4-2006, "IEEE Standard for Information Technology Part 15.4: Wireless Medium Access Control and Physical Layer Specifications for Low-Rate Wireless Personal Area Networks".
- [9] J. Espina, T. Falck, and O. Mühlens, "Network topologies, communication protocols, and standards," in *Body Sensor Networks*, G. Z. Yang, Ed., pp. 145–182, Springer, New York, NY, USA, 2006.
- [10] S. Y. Shin, S. Choi, H. S. Park, and W. H. Kwon, "Packet error rate analysis of IEEE 802.15.4 under IEEE 802.11b interference," in *Proceedings of the 3rd International Conference on Wired/Wireless Internet Communications (WWIC '05)*, vol. 3510 of *Lecture Notes in Computer Science*, pp. 279–288, Xanthi, Greece, May 2005.