



Queensland University of Technology
Brisbane Australia

This may be the author's version of a work that was submitted/accepted for publication in the following source:

Figl, Kathrin & [Recker, Jan](#)
(2016)

Exploring cognitive style and task-specific preferences for process representations.

Requirements Engineering, 21(1), pp. 63-85.

This file was downloaded from: <https://eprints.qut.edu.au/78877/>

© Consult author(s) regarding copyright matters

This work is covered by copyright. Unless the document is being made available under a Creative Commons Licence, you must assume that re-use is limited to personal use and that permission from the copyright owner must be obtained for all other uses. If the document is available under a Creative Commons License (or other specified license) then refer to the Licence for details of permitted re-use. It is a condition of access that users recognise and abide by the legal requirements associated with these rights. If you believe that this work infringes copyright please provide details by email to qut.copyright@qut.edu.au

Notice: *Please note that this document may not be the Version of Record (i.e. published version) of the work. Author manuscript versions (as Submitted for peer review or as Accepted for publication after peer review) can be identified by an absence of publisher branding and/or typeset appearance. If there is any doubt, please refer to the published source.*

<https://doi.org/10.1007/s00766-014-0210-2>

Exploring Cognitive Style and Task-specific Preferences for Process Representations

Abstract:

Process models describe someone's understanding of processes. Processes can be described using unstructured, semi-formal or diagrammatic representation forms. These representations are used in a variety of task settings, ranging from understanding processes to executing or improving processes, with the implicit assumption that the chosen representation form will be appropriate for all task settings. We explore the validity of this assumption by examining empirically the preference for different process representation forms depending on the task setting and cognitive style of the user. Based on data collected from 120 business school students, we show that preferences for process representation formats vary dependent on application purpose and cognitive styles of the participants. However, users consistently prefer diagrams over other representation formats. Our research informs a broader research agenda on task-specific applications of process modeling. We offer several recommendations for further research in this area.

Keywords:

Conceptual modeling; process modeling, business process; representation forms; model evaluation; user preferences; cognitive style

1 Introduction

When seeking to (re-) design business processes, organizations often use externalized documentations of their business processes – so called process models [1, p. 201]. These models capture, in some graphical and/or textual notation, the tasks, events, states, business rules and possibly other information that are relevant to a business process [2]. Process models are frequently used as a key tool in organizational analysis and re-design initiatives [3]. Studies have shown that process models indeed make a solid contribution in this area [4] and that various benefits are associated with process modeling [5].

In creating process models, analysts can choose a variety of graphical and textual formats to represent business processes [6]. Process representation forms used in process modeling range from pure free-form textual descriptions in natural language [7] to semi-structured textual representations such as structured English [8] to fully graphical, diagrammatic representations using dedicated symbols such as rectangles, circles and other shapes [9]. And indeed, research has showed that, when given a choice, students of process modeling employ different representation formats – textual, structured, and/or graphical – for process modeling [10]. Yet, whether or not individuals always prefer one type of process representations (say, diagrammatic process models) or whether this preference is based on individual or context factors, has not been examined to date. Studying preference is relevant, because it influences users “willingness to use and follow instructions” [11, p. 240], even if preference for a representation format might not always correspond to performance in using it [12].

In this paper, we address two research questions about user preference for process representation formats:

First, because individuals differ in preference and mode for information processing, the representation format chosen to describe a process may exhibit a better or worse match to the cognitive style of an individual [13]. Since a good cognitive match is associated with better comprehension and learning performance in general [14], it is of interest to ascertain whether general cognitive preferences for visual or verbal information processing models apply in a similar way to preferences for process representations. Therefore, we investigate how *individual cognitive styles* relate to preferences for process representations.

Second, recognizing the existence of different ways of documenting a business process, the question emerges whether there is also a more preferable representation format based on *different application tasks* of process modeling. Prior research on visualizations in analysis and programming has demonstrated that representations are “not superior in an absolute sense; rather they are good in relation to specific tasks” [15], which suggests that the task setting in which process modeling is employed may have an influence on the best or most preferred process representation format to be used.

This is important because that process models are in fact in use for a wide variety of purposes, such as organizational redesign, ERP implementation, software development, knowledge management or IT education, to name just a few. These application areas are disjoint and pose different requirements to the way processes are represented [16]. Still, most of the research on process modeling [e.g., 17, 18] has focused on narrow task settings and not on comparing differences in the application settings in which process modeling is conducted. Therefore, we investigate how *different application tasks* relate to preferences for process representations.

In addressing these two research questions, we will discuss relevant research on process modeling, task settings and cognitive styles, and then report on the collection and analysis of empirical data collected from 120 individuals about their preference of different process representation formats in different task settings.

Our primary objective is to provide an empirical contribution: We report on an exploratory study, which is the first to systematically gather and analyze empirical knowledge about whether behavioral decisions (the formation of preferences) in process modeling are dependent on the application task and the cognitive style of the user. On the basis of the findings, we contribute to a deepened, empirical and contextualized body of knowledge around process modeling behaviors. In turn, our findings can guide the development of novel substantive theory that explains task-specific usage of process models.

2 Background

2.1 Process modeling and its applications

The common aim of process models as representations of a process domain is to facilitate a shared understanding and to increase knowledge about a business process [17]. This represented process knowledge is meant to support problem solving in the form of process analysis and (re-) design decisions. Process modeling is therefore a cognitive design activity [19], in which users use process models as a *problem representation* (e.g., to improve ways of working) with the aim to make potential problem solutions (e.g., alternative to-be processes) apparent. Examining prevalent applications of process modeling, several empirical studies of process modeling in practice [e.g., 15, 3] report on wide variety in the application areas in which process models are used, ranging from knowledge management [20] to simulation [21] or software development [22], amongst others. The global Delphi study by Indulska et al. [5] identified four main process model application tasks, which we summarize in conjunction with their main objectives in Table 1.

Table 1 Common Application Areas for Process Modeling

Task	Objective
Understanding	To be able to reach a <i>faithful</i> and <i>consistent</i> understanding of business processes.
Communication	To be able to communicate the work flow of a business process <i>clearly</i> and <i>accurately</i> to a number of stakeholders with a vested interest in the business process.
Execution	To be able to <i>derive system requirements</i> that allow for a process-aware information system to be designed under the control of which the business process can be enacted.
Improvement	To be able to identify <i>weaknesses</i> in the current execution of a business process and to develop <i>opportunities</i> where and how the business process can be changed to improve its performance.

These model application tasks pose different requirements to the way processes are represented in a process model: For instance, workflow engineering-related modeling purposes (*execution* in Table 1) typically have the requirements of sound, machine-readable models with a very low level of detail without ambiguity, whereas business requirements documentation purposes typically require a model to be intuitive and understandable and often on a higher level of abstraction [16].

Process model application tasks also differ in other aspects. For instance, Dumas et al. [23] describe different reasons for process modeling as follows: “The first one is simply to understand the process and to share our understanding of the process [...] a thorough understanding is the prerequisite to conduct process analysis, redesign or execution.” This quote indicates that *understanding* typically is considered the basis and prerequisite

for any subsequent model application tasks [24, 25]. Task complexity is likely to increase for the other tasks. For instance, *communication* includes at least one other person in addition to one self. Similarly, process *execution* as well as *improvement* exhibit characteristics typical for complex problem-solving tasks such as multiple alternatives, path-goal connections and constraints that need to be satisfied [26]. Process execution imposes fixed constraints about the representation of a process in a formally correct way in order to make the model machine-readable – which typically violates human readability concerns [16]. By contrast, process improvement describes a creative problem-solving task [27] in which the analysts are required to develop original and appropriate solutions for a novel organizational reality in the form of a “to-be” process model [28]. Creative problem-solving tasks are highly dependent on the type and format of information provided to the problem-solvers [29], which suggests that process improvement tasks are also dependent on a suitable process representation format.

In conclusion, we expect that the task requirements, stemming from the specific application area for which process representations are sought, will have an influence on which representation format (e.g., textual, structured text or diagrammatic) will be preferred by the individual engaged in the task. In examining which representation formats are in use for process modeling, the literature shows differences between at least four key information representation formats in use [e.g., 30, 10]:

1. *Text representations*: Textual documents describing business processes can be policies, reports, forms, manuals, content of knowledge management systems, and e-mail messages [31]. Content management professionals estimated that 85% of the process information in companies is stored in such unstructured format [32]. Recker et al. [10] showed that this format is one of several preferred formats for process design by students.
2. *Structured text representations*: Some users prefer textual descriptions that contain some sort of pre-defined structure, such as pseudo-algorithmic formats [10] or structured use case scripts [33]. Structured text can be seen as the middle between natural language and pseudo code, which would also include elements such as variable declarations [34]. It denotes a constrained language subset for describing the logic of a process but, as a subtype of natural language it remains a familiar medium for non-technical oriented stakeholders. In structured text the amount of information represented is condensed, and structure (indentation) and layout (text blocks) are introduced to visualize concepts which are typical and repeatedly relevant (especially control structures such as repetition or decisions) in process descriptions.
3. *Diagram representations*: In comparison to the uni-dimensional linear sequence of activities in a structured text representation, most process modeling grammars available today peruse a diagrammatic representation form that includes 1D, 2D or even 3D graphic elements such as lines, shapes and other spatial relationships [35] to express relevant process information and conditions. Curtis et. al. [36] showed that diagrammatic flowchart representations were equally effective for most programming related tasks as constrained, structured text, while text was less efficient. Prior research in general has suggested that these visual cues can aid cognitive processing better than textual representations [37], as long as the graphical representation in itself is not too complex to comprehend [38]. The grammars most frequently in use [3] mostly fall into this category.
4. *Iconic representations*: Some studies have shown that the use of additional or complementary graphical icons can assist users in processing representational information [39]. Mendling et al. [40], for instance, argued that a suitable strategy for making process models more understandable is to develop iconic representations for the different activities in the process. And indeed, research in information processing has

shown that additional iconic representations can assist users in the perceptual processing of information that precedes cognitive reasoning [9]. Similarly, pictorial stimuli have been shown to increase task performance in creative-problem solving exercises [41]. Iconic representations have in common that a graphical symbolic vocabulary is added to the existing representations (both text and diagrams) to add visual cues about the semantic meaning of the representation elements.

Fig. 1 illustrates the differences between text, structured text and diagram process representations (with snippets of the study materials). It also shows how, in iconic variants of these representations, appropriate symbolic icons are usually added to elements in these representations.

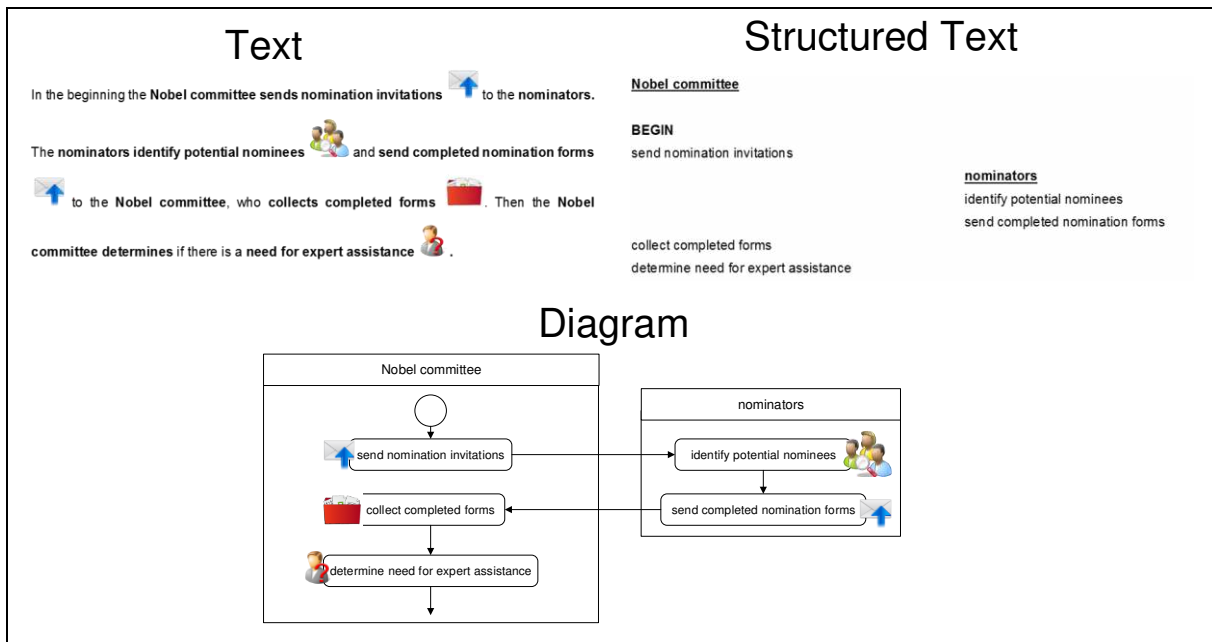

On the basis of these arguments we thus contend that different representation formats may be preferred by users in different task settings. Still, such preference judgments are also based on individual affective and cognitive factors [42]. In the following, we therefore explore why users might prefer different formats, by examining the concept of cognitive styles.

2.2 Cognitive Styles

With process modeling being a cognitive design activity, the use of process representations is dependent on the way individuals think, perceive and remember information when engaging in a task. These individual preferences for information processing are encapsulated as the cognitive style of a person [13, 43]. This is important because depending on the user's cognitive information-processing style, the external representation (the process model) may be different to the internal representation (the internal mental model) developed by the viewer, in turn more or less aligning with the preferred mode for information processing, resulting in cognitive fit or a lack thereof [44]. Vessey [45, p. 220] defines the notion of cognitive fit as "when the problem-solving aids [...] support the task strategies [...] required to perform that task". Cognitive fit leads to effective problem-solving performance because a match in representation to task leads to the formulation of a consistent mental representation, without a need to transform or align the mental representation to that of the problem [45]. Thus,

different cognitive styles are conducive to understanding why users may prefer one process representation format over another, because they determine preferred task strategies and problem-solving processes.

Blazhenkova and Kozhevnikov [43] proposed a three-dimensional model that differentiates two visual styles (an *object* and *spatial* style) and a *verbal* style, based on the neuropsychological existence of distinct subsystems that encode and process information in different ways:

1. an object imagery system that processes the visual appearance of objects and scenes in terms of their shape, color information and texture;
2. a spatial imagery system that processes object location, movement, spatial relationships and transformations and other spatial attributes; and
3. a verbal system that processes information in words or verbal associations.

The distinction of verbal from two different visual styles is conducive to examining preferences for different process representation formats because (a) the formats used in practice vary between textual to diagrammatic, and with or without and pictorial representations; and (b) research on individual differences in imagery shows that object visualizers “use imagery to construct vivid high-resolution images of individual objects”, while spatial visualizers “use imagery to represent and transform spatial relations” [46, p. 641]. There is thus some evidence to suggest that individuals, depending on their cognitive style, would prefer different types of process representation formats based on its inclusion of verbal or object information representations and/or the inclusion of object imagery. The assertion that we wish to examine, therefore, is whether process representation format preference may also be influenced by the cognitive style of the user seeking to work with a process representation.

3 Research Framework

The available literature on cognitive styles or process modelling application purposes as discussed above is too general [43] or not sufficiently operationalized to allow for precise empirical discrimination [5]. To aid the contribution of knowledge, therefore, exploratory research [47] appears most suitable in order to gain experience that will be helpful in formulating hypotheses for more definite subsequent investigation.

Therefore, in such an exploratory study setting with an absence of strong a priori theory, the development of propositions or hypotheses is not necessarily appropriate or indeed helpful [48]. However, to provide structure to our exploratory research, we developed a research framework that would help us to remain cognizant of extant literature and existing empirical results and to draw attention to relevant elements of a research design that are likely of relevance when studying process representation preferences in our empirical examination.

Hence, the conceptual framing of a research framework serves three key purposes in the ensuing exploratory study. First, it helps us to ensure that we remain theoretically aware during our collection and analysis of empirical data. Second, it provides a reference to evaluate the alignment between theoretical factors of interest as identified from prior research and the operationalization of measurements in the research design of our empirical study. Third, it assists the development of novel substantive theory by sensitizing us to the range of potential factors and discriminating, based on the empirical results, between important and unimportant determinants, which will aid subsequent theory development that can evolve the conceptual framework.

Our view of that framework is shown in Fig. 2, in which we highlight theoretical factors of relevance to our study and also provide information about their operationalization in the empirical study that follows.

Recall, the assertion we wish to examine is whether preferences for a particular process representation format will be dependent on the *application task* setting and further be influenced by the *cognitive style* of the individual user. The framework in Fig. 2 consequently views the formation of a process representation preference as a function of the cognitive style (preference for spatial, verbal or object information representation [43]) and the task setting (understanding, communicating, executing or improving a business process [5]) for which the process model is being used. Based on the review of the extant literature, we also recognize that there may be an influence (such as moderation or masking effects) through previous expertise and experience [49, 25], that is, by increased familiarity with graphical models of an individual (in terms of the amount of process models read or created and knowledge of conceptual modeling approaches).

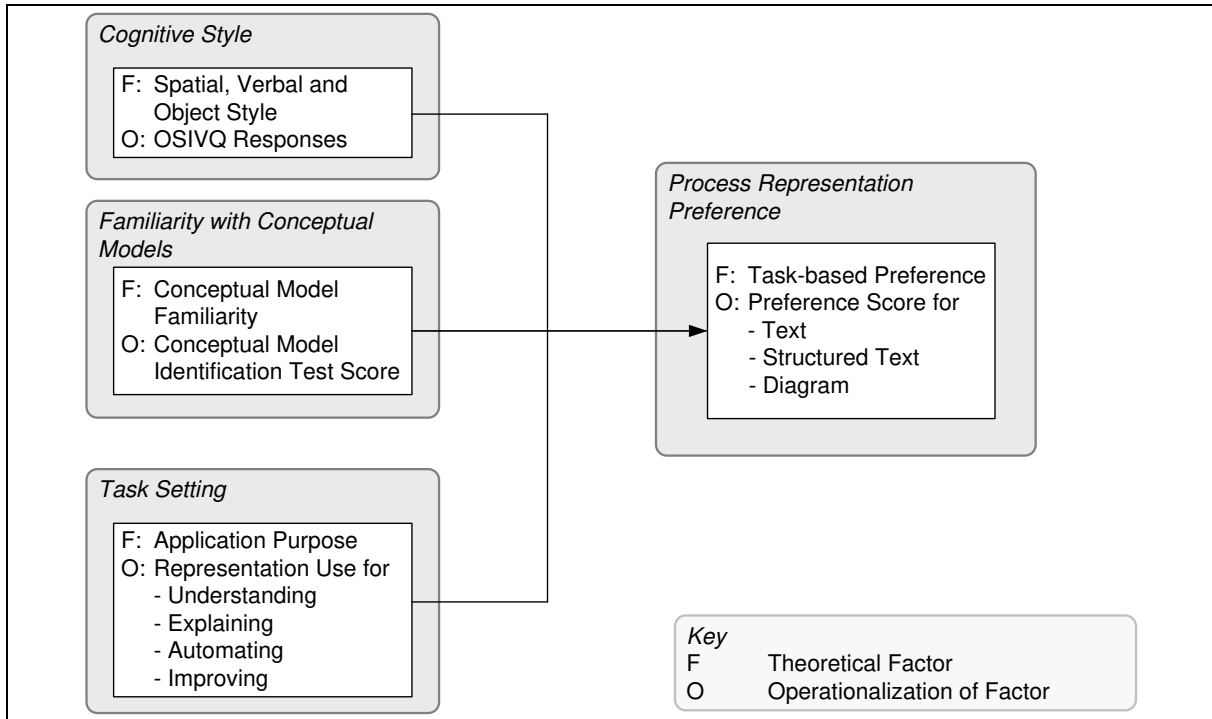

Fig. 2 Research Framework

4 Research Method

4.1 Design

To empirically explore the factors described in our research framework whilst maintaining control over potentially confounding external factors, we selected a within-subjects-only exploratory lab study design. In this type of design, variables of interest are captured in a controlled setting but no experimental treatment is provided like in a factorial experiment. Subjects are placed in a controlled environment where they are free to behave (within the required boundaries of the study, e.g., the prescribed tasks) and are asked to make decisions and choices as they see fit, thus allowing values of the independent variables to range over the natural range of the subjects' experiences [50]. These designs are relatively common in process modeling studies [e.g., 49, 51].

Our lab study design featured three within-subject factors (task, cognitive style, modeling familiarity), and one dependent variable (representation preference), as depicted in Fig. 2.

The factor *task* had four levels, based on the top four application areas of process modeling [5], viz., choosing a process representation to

1. *understand* the process without being familiar with it,
2. *communicate* the process to someone unfamiliar with the procedures,
3. support developers of an IT-based system to *execute* the process, and
4. identify opportunities to *improve* the way the process is being executed.

We note here that the task settings are mutually dependent. Notably, in the application tasks communicating, executing and improving it is subsumed that actors have already gained a basic understanding of the process before using the process representation for the specific task.

The second factor, *cognitive style*, had three levels, viz., spatial, object and verbal, following the object-spatial-verbal cognitive style model by Blazhenkova and Kozhevnikov [43], which we measured using their validated instrument.

The third factor, *modeling familiarity*, was evaluated by presenting six different types of conceptual models to the participants and asking them to identify the correct type of diagram. Through this test, we were able to establish a proxy for levels of familiarity with various forms of conceptual modeling across a broad range of information representation formats used in the different models.

The dependent measure was *preference for a representation format*. Preferences describe an individual's attitude towards an object, typically based on an explicit decision-making process about expected consequences from using that object [52]. In analogy to modeling grammar usefulness scales [53], our preference scale therefore captures expected performance beliefs (for instance, whether or not using a particular representation format will assist the decision-making or problem-solving or overall successful completion of the task), and reflects expected effectiveness and efficiency gains that would manifest from the use of a representation form. Because preferences are essentially choice decisions [54], we measured the relative judgment of preference for a representation format in comparison to each other (e.g., text over diagram) for each of the four task settings considered.

Before executing the study, seven researchers with knowledge of the study pilot-tested the online survey system, which led to minor modifications to the design.

4.2 Procedures

The survey contained six different sections. First, the system showed an information cover sheet with consent form and directions, and then proceeded to a section about demographics, a section about experience with conceptual modeling, a section measuring cognitive style, a section presenting the different process representation forms, and finally the questions for the task-specific preference ratings. The system automatically proceeded after participants completed a section and/or after a certain time period elapsed (e.g., 50 seconds to view each process representation format).

4.3 Materials

Appendix A includes the study materials. We briefly describe important material elements in the following.

1. Demographics

In the first section of the lab study, a survey asked demographic question such as age, gender and level of education to be able to describe our sample frame..

2. Modeling Familiarity Measurements

In this section we first asked how many process models participants had read or created previously to generate a measure for *process modeling experience*. Additionally, this section subjected the participants to a test of their knowledge of six different types of conceptual modeling representation forms to generate a measure for *conceptual modeling familiarity*. In this test, participants were shown a number of different conceptual models and were for each model asked to identify the type of model from a list of six choices (5 alternative types of models plus “I don’t know”). We chose this test to be able to ascertain whether participants, in principle, had some level of experience with different types and formats of conceptual modeling grammars, because essential to our research was the study of different representation formats. This study focus prevented us from using traditional experience measures such as self-rated comparisons to expert users [24] or multiple-choice questions about the grammatical logic of any given model [25].

In selecting types of conceptual models to use in the familiarity test, we examined experience reports of modelling in practice that list frequently used techniques [3, p. 573]. We selected a sample of techniques that covers different modelling paradigms (e.g., state-based, process-oriented, data-oriented, object-oriented), also making sure that we selected notations typically covered in business and IT courses such as ERM, UML, BPMN and ORM. The rationale was to allow for the possibility that some students may have experience in all model types, some may have none, but most would have varying levels of experience, which indeed was the case. We then devised multiple choice tests in which a diagram was shown to the participants alongside with multiple answers (possible notations) out of which only one was correct.

To develop a score for conceptual modeling familiarity, we used the “number correct” method to score answers in in the multiple choice test [55]. This is the most commonly used scoring method and each correct response earns a point. Studies have shown that this scoring method performs well from a psychometric perspective [55]. Thus, for our purposes we found this to be an appropriate measure for the underlying familiarity of participants.

3. Cognitive Style Measurement

We administered the self-report Object-Spatial Imagery and Verbal Questionnaire (OSIVQ) designed and validated by Blazhenkova and Kozhevnikov [43]. It contains 45 5-point Likert scale items anchored between “totally disagree” and “totally agree” with the mid-point “neutral”. An example item for the spatial cognitive style scale was “I prefer schematic diagrams and sketches when reading a textbook instead of colorful and pictorial illustrations” [46, p. 645]. “Putting together furniture kits (e.g. a TV stand or a chair) is much easier for me when I have detailed verbal instructions than when I only have a diagram or picture” is an example for the verbal style scale, and “My images are very vivid and photographic” is an example for the object style scale [46, p. 645]. We chose the OSIVQ because it had undergone several tests of internal reliability as well as construct, criterion and ecological validity [56, 46], and had been successfully applied in many different studies [57, 58, 59, 60, 61, 62]. Details about the measurement instrument can be obtained from MM Virtual Design.

4. Process Representations

In this section, each participant was shown six representations of one process, namely, the process of selecting a Nobel Prize winner. The process was based on the Nobel Prize process scenario published in the context of the BPMN standard [63]. We selected this process because it is both from a domain that most people would have heard of (the Nobel Prize) but also describe a procedure largely unknown to the wider public, in turn reducing potential bias stemming from existing domain knowledge or process familiarity [64]. The process contains 16 activities executed by four actors and includes control flow divergences such as an exclusive split. It can be regarded as a realistic example of a “normal” process, as process models in practice reportedly contain about 19 tasks on average [65].

Each participant was shown six representations of this process, viz., text, structured text and diagram, each in a version with and without icons. We used a mechanism that allowed viewing the different process representation forms for 50 seconds each. The timing was decided based on (a) experiences from the pretest in which participants found this time limit sufficient to read and look through all representation format, and (b) pragmatic reasons to ensure the survey could be progressed and completed with the time limit available.

A prior study [11] demonstrated that short interaction time with a representation format could influence users’ preference in a positive way. Therefore, we used six different scramblings of the order of the process representations, which were randomly assigned to participants to avoid order effects. We examined the correlations of the scrambling to all other variables (see Table 3 below), which were all insignificant, suggesting that presentation schedule did not affect results.

In the construction of the visual materials, we tried to control for model representation factors that were not part of our research model to avoid deterring effects. For instance, we used an up-down modeling direction for the process model, which is common in practice. The main rationale behind this decision was to keep layout differences between the textual versions and the diagrams as low as possible, as prior research has shown an effect of layout on the understandability of a model [66]. Furthermore, the diagrams were developed on basis of the BPMN standard grammar [63], perusing the set of constructs frequently used in practice [67].

In selecting icons for the iconic representations, our aim was to select intuitive icons that represent the activity as well as the business object. We refrained from using icons to represent actors. We followed prior work on the development of icons for process modeling activity categories [40]. We finalized selection of icons based on a pre-test with 10 BPM researchers that ranked the six best icon options according to their fit for representing the indicated activities in a “vivid, colorful and pictorial way”. For the final selection we used the icons with the highest Borda-count [68], which gives each item option a number of points corresponding to its ranking position.

4. Representation Preference Measurement

Finally, participants were asked to judge their preference for using representation formats through pair-wise comparisons, for each of the four task settings described. The rating system was implemented using a slider that measured preference for one representation format over another on an unnumbered graphical scale from representation format A to representation format B (200 pixel width). The slider captured respondents on a scale from 0 to 100 where 0 indicates full preference for option (A) and 100 indicates full preferences for option (b), with 50 indicating no preference for either. Such graphical rating scales offer reliable scores and the “psychometric advantage of communicating to respondents that they are responding on an interval continuum” [69, p. 705]. Specifically, for each task setting, participants were asked to rate

- Preference for structured text (B) over text (A),

- Preference for diagram (B) over structured text (A),
- Preference for diagram (B) over text (A), and
- Preference for representation form with icons (B) over representation without icons (A).

4.4 Participants

Our interest was to identify preferences for the use of representation formats for business processes across a number of task settings. The population of interest to our study thus consists of business users of process representation formats (i.e., process model readers) that are involved in tasks such as explaining a process, executing a process, or seeking improvements to a process. This business cohort is thus wider than BPM practitioners alone (i.e., designers of process models) whose tasks typically consist mainly of describing or formalizing a process in a particular representation format (i.e., process model creators). Thus, in our study we are interested in model interpretation rather than model creation tasks [70]. More so, high levels of knowledge, experience of formal training in model design practices typically found with experienced process modelers would induce a significant bias in the preference for a particular representation format. Following recommendations for sample selection [71], we therefore decided to recruit university students from a business school as study subjects because we deemed them a realistic proxy of future end-users of process models. Two studies support this justification. The study in [72] reported that student-practitioner differences were not due to occupation but rather attributed to experience differences, if any. Similar, a study on process model comprehension showed that practical experience in model use or type of university education were not significantly correlated with model comprehension [18].

To estimate a required sample size, we conducted a power analysis using the G*Power 3 software [73] using the parameters of the lab study design (see Section 4.1) and the nature of the variables measured (see Section 4.3). To approximate the sample size requirements for the multiple regression analysis with four predictors (3 cognitive styles plus the familiarity measure as described in Section 5.1 below) and expecting medium effect sizes of $f(U) > 0.25$ with type-1 error probability of $\alpha < 0.05$, a sample size of $N = 80$ is required to reach sufficient statistical power > 0.95 . To approximate the sample size requirements for the reported multivariate analysis of variance with four measurements (pair wise preferences) across four groups (application tasks, see Section 5.2) and again expecting medium effect sizes of $f(U) > 0.25$ with type-1 error probability of $\alpha < 0.05$, a sample size of $N = 76$ is required to reach sufficient statistical power > 0.95 . To be safe, we thus set out to recruit approximately 100 participants for our study.

In our study, overall 120 individuals participated. Subjects were business students from a European university. Participants were recruited through email via a university mailing list. To assure sufficient motivation during the study, participants were offered 15 Euro as an incentive. 418 students registered for participation two days after the invitation was sent out. Of these, we selected 120 students based on specific selection criteria (preference of students of a business-related study to guarantee homogeneity of sample, German was mother tongue and English was fluent, preference of students who had participated in modeling courses to assure variance in prior experience with modeling, availability for a time slot, and maintaining gender distribution of approximately 50%). The study took place in a computer laboratory and two test instructors supervised participants. Subjects were allowed to spend as much or as little time as desired, on average they took about 25 min to complete the study.

We performed an outlier detection analysis for the familiarity with process models. Based on the variable amount of models read or created (varying from 0 to 51 models), we identified 5 participants as outliers [74], reducing the sample size to 115. The remaining students had created or read between 0 to 19 process models. The population of our study, therefore, is largely similar to those of other studies in this domain [75, 76, 77].

5 Results

The online system automatically coded all responses received. All responses were complete and valid. The results were examined in three steps. First, we examined descriptive statistics to assert whether the data collected contained sufficient variance for examination. Table 2 summarizes relevant descriptive statistics about the sample population in our study and Table 3 gives correlations. We note that mean scores in the familiarity with conceptual modeling test were low; participants on average answered only 1.15 out of 6 items correctly. In a next step we examined reliability for this measure (Cronbach's alpha = 0.51) and decided to exclude the most difficult item on BPMN, which had lowered reliability Cronbach's alpha = 0.44 with all six items). From Table 3 we can see that process modeling experience (the number of models created or read) and the control variable scrambling show no correlations with any of the dependent measures, thus, we decided to drop these variables in the statistical tests.

Table 2 Descriptive Statistics

Construct	Variable	Distribution	Mean	SD
<i>Demographics</i>	Gender	50 male (44%) 65 female (56%)	-	-
	Age	[from 19 to 34]	24.25	3.29
	Number of models created	-	2.34	3.59
	Number of models read	-	1.77	2.05
	Number of models created or read	-	4.11	4.52
<i>Modeling Familiarity</i>	ERD	61 correct (53%) 54 incorrect (47%)	1.15	1.13
	ORD	21 correct (18%) 94 incorrect (82%)		
	BPMN	4 correct (3%) 111 incorrect (97%)		
	Sequence diagram	18 correct (16%) 97 incorrect (84%)		
	Petri net	6 correct (5%) 109 incorrect (95%)		
	Class diagram	22 correct (19%) 93 incorrect (81%)		
Cognitive Style	Spatial orientation	-	2.95	0.61
	Verbal orientation	-	3.26	0.52
	Object orientation	-	3.46	0.64

Table 3 Correlations

	Process modeling experience	Familiarity with conceptual modeling	Spatial orientation	Verbal orientation	Object orientation	Preference for Structured Text over Text	Preference for Diagram over Structured Text	Preference for Diagram over Text	Preference for Icons	Scrambling
Process modeling experience	1.00									
Familiarity with conceptual modeling	0.42**	1.00								
Spatial orientation	0.24**	0.24**	1.00							
Verbal orientation	-0.08	-0.05	-0.22*	1.00						
Object orientation	-0.21*	0.03	-0.31**	0.08	1.00					
Preference for Structured Text over Text	0.09	0.14	0.11	0.14	0.07	1.00				
Preference for Diagram over Structured Text	0.08	0.22*	0.06	-0.22*	0.00	-0.04	1.00			
Preference for Diagram over Text	0.03	0.11	0.16	-0.13	0.18	0.53**	0.42**	1.00		
Preference for Icons	-0.18	-0.07	-0.11	-0.01	0.04	0.13	0.05	0.20*	1.00	
Scrambling	-0.13	-0.02	0.03	-0.03	0.02	-0.07	0.02	-0.02	0.06	1.00

** p <0.01, * p <0.05

Next, we examined the assertions in our research model in two steps which we discuss in turn. First we report results concerning cognitive style, then results on application task.

5.1 Examining Preferences based on Cognitive Style

In our initial analysis, we examined how the cognitive styles influence preference for a process representation format across the four considered task settings. Data analysis was completed using standard multiple regression (enter method) SPSS Version 19.0 [78]. We used four independent variables. First, the respondents' three mean scale values of the Object-Spatial Imagery and Verbal Questionnaire [43] (object orientation, spatial orientation, verbal orientation). Second, we used the conceptual modeling familiarity score as an additional independent variable because of its noted correlations (see Table 3). As dependent measures, we used the mean of the preference slide scores (which were measured four times for the task applications understanding, communicating, executing and improving) one for each of the comparisons:

- text versus structured text,
- text versus diagram,
- structured text versus diagram, and
- icons versus no icons.

We screened the data for its conformance with the assumptions of regression analysis based on the procedures proposed in [79]. Analyses of standard residuals were carried out on the data to identify any outliers, which indicated that one participant record needed to be removed in the regression analysis for preference for diagram over text, else there were no outliers. Tests to see if the data met the assumption of collinearity indicated that multicollinearity was not a concern (Tolerance > 0.80, VIF < 1.24). The data also met the assumption of independent errors (Durbin-Watson values between 1.60 and 2.15), with the exception of preference for diagram over text, which yielded a positive autocorrelation (Durbin-Watson = 0.01), which might result in inflation of the Type-1 error rate. The scatterplots of standardized residuals showed that the data met the assumption of linearity; they also showed slight deviations from homoscedasticity and normality, due to the fact that preference scores were negatively skewed. Heteroscedasticity might weaken, but not invalidate the analysis [79, p. 85] .

Table 4 reports the four statistical tests (one per preference comparison) and displays the unstandardized regression coefficients (B), the standardized regression coefficients (β), the intercept, R^2 and R. All results with $p < .10$ are highlighted gray. Appendix B summarizes descriptive statistics about reported participants' preferences across the four tasks. Participants were grouped into high and low levels of object, spatial and verbal orientation based on median splits to aid interpretation of results.

Table 4 Multiple Regression Analysis with Results

	Variables	B	β
<i>Preference for Structured Text over Text</i> $R^2=0.07$ $R=0.25$ <i>Intercept =16.50</i>	Object Orientation	3.87	0.10
	Spatial Orientation	6.13	0.15
	Verbal Orientation	8.30 ⁺	0.17 ⁺
	Familiarity with Conceptual Modeling	2.46	0.11
<i>Preference for Diagram over Structured Text</i> $R^2=0.09$	Object Orientation	0.05	0.00
	Spatial Orientation	-1.44	-0.03
	Verbal Orientation	-10.64*	-0.22*

$R=0.30$ $Intercept = 110.54$	Familiarity with Conceptual Modeling	4.86*	0.21*
$R^2=0.08$ $R=0.29$ $Intercept = 61.84$	Object Orientation	3.57	0.13
	Spatial Orientation	7.35	0.27*
	Verbal Orientation	-2.60	-0.08
$R^2=0.02$ $R=0.13$ $Intercept = 80.94$	Familiarity with Conceptual Modeling	0.08	0.01
	Object Orientation	0.51	0.01
	Spatial Orientation	-5.59	-0.11
	Verbal Orientation	-2.03	-0.03
	Familiarity with Conceptual Modeling	-1.31	-0.05

* $p \leq 0.05$, + $p \leq 0.10$

Our analysis allows us to make several interpretations.

First, we note how different cognitive styles and are significant predictors to the preference of different process representation formats in two out of four combinations (diagram vs. text, diagram vs. structured text).

Concerning the preference for structured text over text, the four predictor model was able to account for 7% of the variance, $F(4, 114) = 1.90$, $p = 0.12$, $R^2 = 0.07$, thus, the overall regression model was not significant. However, we found the predictor verbal orientation tended to influence the preference for structured text over text, albeit not significantly so ($p = 0.07$). As can be seen from Fig. 3, participants with lower verbal style seem to prefer structured text over text.

Next, we turn to the preference for diagram over structured text. R^2 was significantly greater than zero, $F(4, 114) = 2.78$, $p = 0.03$, $R^2 = 0.09$. Verbal orientation and familiarity with conceptual modeling were found to be significant predictors. Users with lower verbal orientation and higher familiarity with conceptual modeling have a stronger preference for diagrams over structured text.

The analysis shows that cognitive styles and familiarity with conceptual modeling did significantly predict the preference for diagrams over text, $F(4, 113) = 2.48$, $p = 0.05$, $R^2 = 0.08$. Higher spatial orientation was found to be a significant predictor for the preference for diagrams over text.

No effects of cognitive style and familiarity with conceptual modeling on the preference for icons were found.

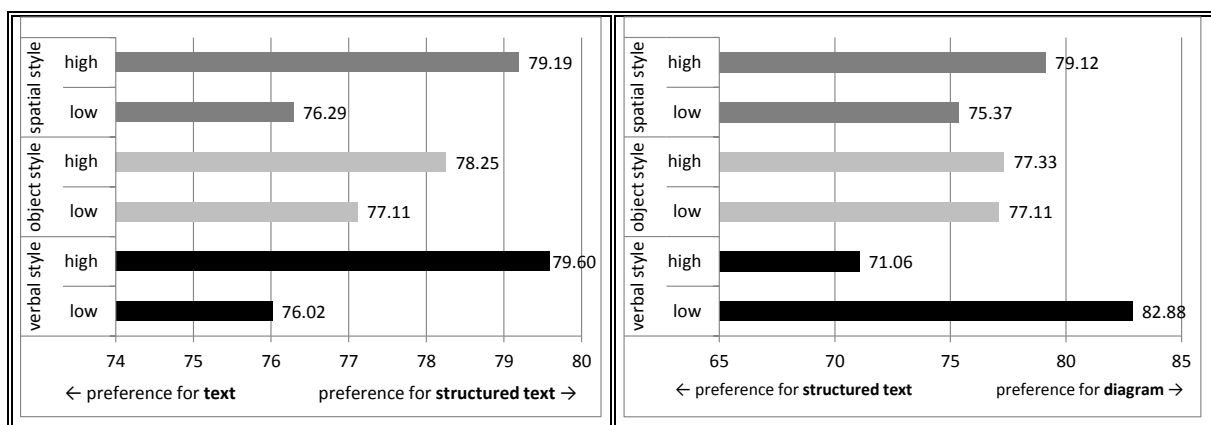

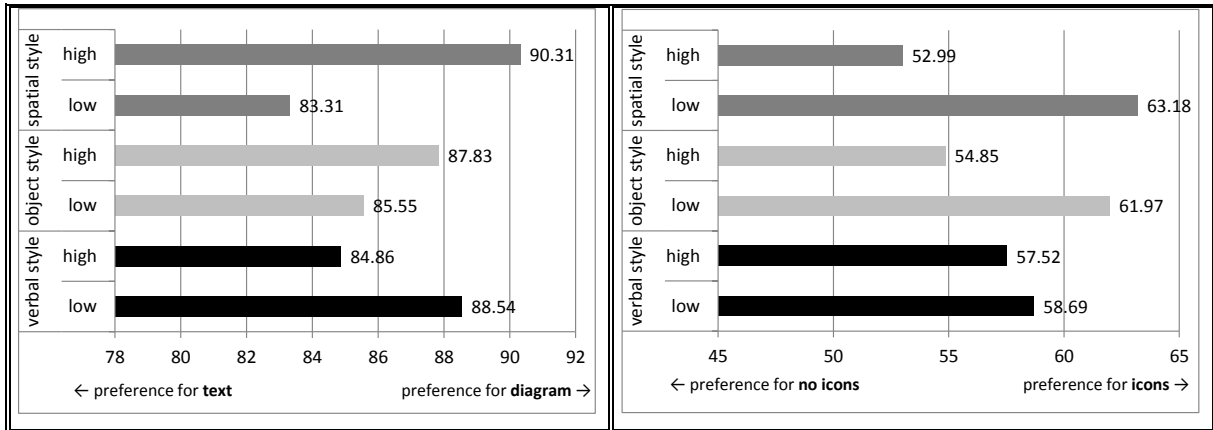

Fig. 3. Cognitive Styles and Preference for a Process Representation

5.2 Examining Preferences based on Application Task

In our second analysis, we then examined whether preferences for a process representation format change on basis of the different task settings considered. To that end, we performed MANCOVAs using the GLM procedure in SPSS, with the independent within-subject-factor task (with four levels: understanding, communicating, executing and improving). As dependent measures, we used the preference slide scores. We performed four separate analyses, one for each of the distinctions

- text versus structured text,
- text versus diagram,
- structured text versus diagram, and
- icons versus no icons.

Each of these dependent variables was measured four times for the four tasks, thus constituting four dependent measures in each of the analyses. We used one covariate - familiarity with conceptual modeling.

Prior to the analysis, we screened the data for its conformance with the assumptions of MANCOVA [79]. Specifically, Shapiro-Wilk tests of the dependent variables indicated that the assumption of multivariate normality of dependent variables had been violated. We still decided to interpret the results, because the MANCOVA procedure is usually robust against violations of normality [79, p. 251] – especially when for degrees of freedom for error are largely than over 100 as was the case in our study in our case – and provides the advantage to analyze all relevant influence factors in one analysis, thereby reducing risk of inflating type-1 error due to multiple hypothesis testing. However, MANCOVA tests are sensitive to multivariate outliers. Therefore, we calculated Mahalanobis distance for each set of dependent variables to detect multivariate outliers. For the four analyses, there were no multivariate outliers identified ($p > 0.001$).

Table 5 reports the results of the statistical test and Table 6 gives estimated marginal means and the standard errors. Recall that scores in Table 6 larger than 50 indicate a preference for option (B) while scores smaller than 50 indicate a preference for option (A).

Table 5 Multivariate Test for Task Effect

Dependent Measure	F	df (Hypothesis; Error)	p	Eta-Square
<i>Preference for Structured Text over Text</i>	3.54	3; 111	0.02	0.09
<i>Preference for Diagram over Structured Text</i>	0.71	3; 111	0.55	0.02
<i>Preference for Diagram over Text</i>	5.30	3; 111	0.002	0.13

<i>Preference for Icons</i>	2.99	3; 111	0.03	0.08
-----------------------------	------	--------	------	------

Table 6 Descriptive Results for Task Effect

Task	Structured Text (B) over Text (A)		Diagram (B) over Structured Text (A)		Diagram (B) over Text (A)		Icons (B) over No Icons (A)	
	estimated marginal means	standard error	estimated marginal means	standard error	estimated marginal means	standard error	estimated marginal means	standard error
Task 1: Understanding	70.24	3.42	74.42	3.07	80.05	2.71	62.99	3.50
Task 2: Communicating	75.58	2.97	75.23	2.97	86.49	2.25	65.18	3.42
Task 3: Executing	82.96	2.70	79.86	2.93	90.40	1.91	53.54	3.79
Task 4: Improving	82.14	2.77	79.41	2.96	90.18	1.92	50.80	3.71

The results from this analysis again lead to interesting findings. From Table 6 we can infer general preferences for representation formats based on the averages across all task settings. Users, overall, tend to prefer diagrammatic representations (over text, means > 80.05, and structured text, means > 74.42), and structured text over free-form text (means > 70.24).

Still, the data in Table 5 suggests that representation form preferences, at least in parts, indeed vary dependent on the type of tasks.

Preferential judgment scores for the different representation formats changed significantly for three out of four multivariate comparisons, with only the comparison of diagram versus structured text being insignificant.

First, we turn to the preference for structured text over text. In general, the task setting is a significant influence factor for this preference. While there is no significant difference for execution vs. improving tasks, which both show the highest preference for structured text over text, this preference is less strong for understanding ($p = 0.000$) and communicating tasks ($p \leq 0.04$).

Concerning the preference for diagrams over structured text, the data shows that there is no overall influence of the task setting on the relative preference. Instead, the data shows that familiarity with conceptual modeling does positively influence the preference for diagrams, $F(1,113) = 5.54$, $p = 0.02$.

The preference for diagrams over text changes significantly depending on task setting. For understanding process diagrams are less preferred over text than for all three other task settings ($p \leq 0.01$).

The preference for iconic representations differs significantly among task settings. Preferences for executing and improving tasks are similar to each other, yet different to understanding and communicating tasks ($p \leq 0.01$), in which preference for icons is stronger.

6 Discussion

6.1 Summary of Findings

We set out to systematically collect and analyze empirical data in relation to two exploratory research questions concerning the preference for process representation formats by different types of users and across different task settings. Our study provides empirical results on the influence of task settings and cognitive style on the

preference for process representation formats. Our results suggests that while overall a tendency exists that users prefer diagrammatic representation forms, our tests showed that preferences do significantly vary in dependence on cognitive styles on the one hand, and task settings on the other.

First, we want to discuss the relation between cognitive styles and preferences for process representations.

Higher verbal orientation is related to the preference for structured text over text lowers the preference for diagrams over text. A possible explanation is that structured text makes the relevant part of the text more pronounced and suits verbalizers that “prefer to process information by verbal-logical means” [80, p. 47], which, in turn, also coined the rephrasing of the verbal style as “verbal-analytical”.

Spatial visual cognitive style seemed to be positively related to the preference for diagrams over text, while verbal style is negatively related. These findings suggest that diagrams provide externalized representations that can be effective for those whose cognitive styles do not align with highly verbalized representations but instead for those users that prefer the visual existence of structural elements (e.g., via shapes and lines). It would appear that the syntactic and semantic information about the process contained in the spatial relations between elements in a process model conforms to a spatial information processing style which is related to preferring schematic, abstract representations.

Previous research has indicated that process diagrams in general can assist in the building of mental models better than text, because the visual structure of their elements is similar to the internal structure of a mental model of procedures [81]. Our research further develops this argument by showing that the representation form preferences are at least partially dependent on the cognitive processing style of individuals. Diagrammatic representations apparently provide a superior fit for individuals who have a preference for internal imagery of mental models.

It is somewhat surprising that no significant relations between the preference for icons and cognitive styles could be found. One would have expected that iconic representations would fit to the preferences for pictorial, concrete representations of object visualizers who “engage the visual-pictorial imagery system in solving problems” [80, p. 69]. However, this result may be explained by the fact that icons also have the potential to distract users with a high object style, because they might overload their visual working memory capacity. One likely root cause for this distraction could that such individuals are “unable to suppress pictorial details irrelevant to solving the problem” [80, p. 70]. Thus, users with high object orientation might also feel that distraction and therefore neither prefer no dismiss the use of icons.

Second, we discuss the influence of task settings on process representation preferences. Our results show that for all tasks, diagrams were rated most preferred, and structured text was consistently preferred over text. These results are in line with related studies [10, 11, 38] and may reflect a general level of awareness of advantages of these representations in terms of elimination of irrelevant information and reduction of cognitive effort [37, 82, 83], in particular when designing instructions [11] – such as instructions for carrying out work tasks in a process. In comparison to purely textual formats, these representations include both visual and verbal cues, which in turn can be processed by two different cognitive information processing channels as stipulated by multimedia learning theory [84].

Third, our study provides some evidence that icons can be preferable additions in some but not all model-based tasks; to be precise, for understanding and communicating. This finding clarifies the argument that iconic representations are indeed helpful for improving an understanding of processes [40]. Our study also qualifies this

contention by showing that icons can also denote an unnecessary overhead when applying process models for process execution or improvement.

In sum, our results assist the development of a more systematic view of the relevance of cognitive styles and model application purposes to the formation of a preference for process representation format. To develop a cohesive view on the noted effects, we sought to characterize the uncovered influence of cognitive style and task setting on preferences in form of a pictorial representation (Fig. 4) that highlights the basic preferences and how they are strengthened or lowered ensuing from our exploratory analysis. Fig. 4 shows our view of that model and which influence factors strengthen or weaken the general preferences (diagrams over text and structured text, structured text over text and icons over no icons). We note that this model, in alignment with our results, should rather be seen as emergent and tentative than conclusive and validated in nature. Still, we believe that the formulation of such a model (a) suggests likely outcomes of choices made in practice, (b) draws attention to a limited set of factors with explored probabilities of interactions and effects and thus aids theory development through abduction, i.e., it allows the generation of concepts and propositions on basis of the empirically grounded understanding of the problem (task-based preferences of process representations by users).

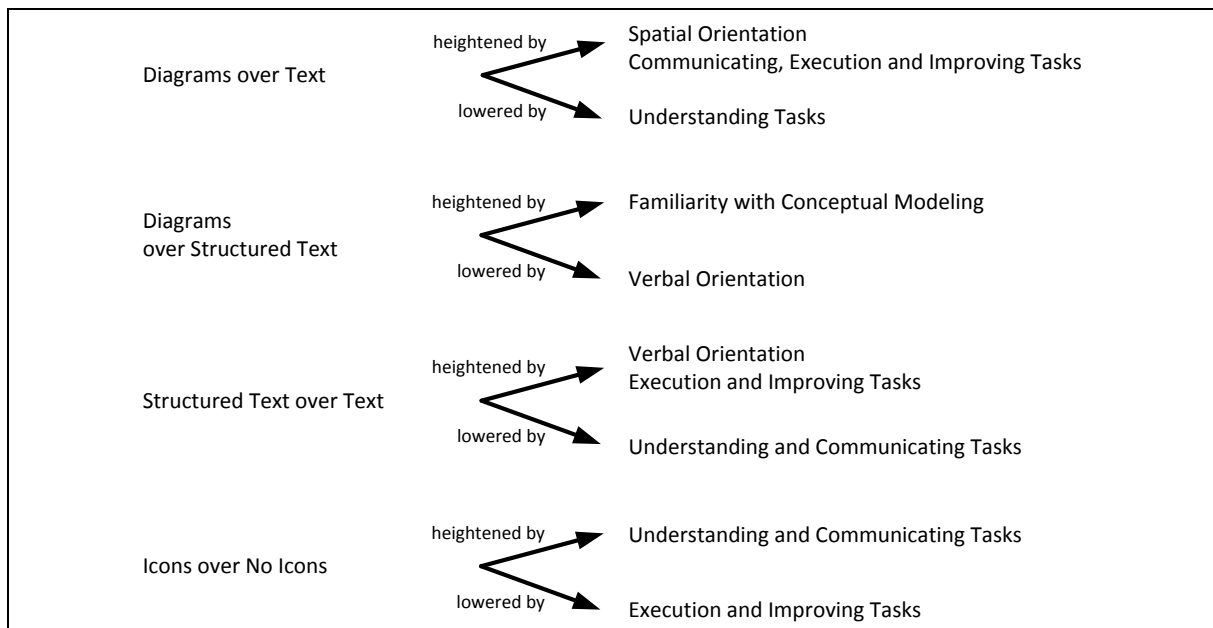

Fig. 4. Tentative Model of the Influence of Cognitive Style and Task Setting on Process Representation Preference

6.2 Threats to Validity

A number of limitations that pertain to our study need to be acknowledged as, equivalent to any other research, our results are bounded by threats to validity [85].

First, our sample was drawn from business school students, in turn limiting the *external validity* of the findings. Our sample was chosen to be approximately representative of novice business end users of process descriptions (such as models or texts). In turn and in particular, we can only offer speculations about how novice or senior process analysts or similar BPM practitioners with expert process modeling knowledge may behave, who are

likely to have higher knowledge and familiarity of certain representation formats (e.g., typical flowchart process models). However, as we explained above, we were interested specifically in the preferences of business users (model readers rather than creators) for which our sample was appropriate. We note that results may be different for business users with higher experience levels in either the domain of the process or any of the chosen task settings. However, we deliberately chose a process domain outside of any particular business sector or industry to avoid such working knowledge bias. Also, recruiting users with high levels of experience in some of the selected task settings (e.g., improvement) may have led to a measurement of “reflected” preference based on experience rather than on an “intuitive” preference based on the task at hand. In addition, despite potential lack of experience, our results show student participants were able to differentiate between task settings and their judgements of suitability of representations varied substantially. Still, response reliability may be reduced by lack of varied or high experience in the different task settings. Finally, we note that our sample is similar to that of most of other studies in process model use [e.g., 86, 18, 87], in turn allowing for comparison and cross-examination of results.

Concerning *construct validity*, we like to discuss social desirability bias. We recognize that students’ answers could reflect a social desirability bias rather than actual preference as educational institutions might have advocated the use of visualizations like diagrams. Indirect questioning or test designs (e.g. providing subjects with different models and then asking, for example, to explain the process to another subject, and then see which model the subject uses) than the direct questions we used might have reduced such a bias [88]. However, other studies which have investigated students’ preferences of different representations formats [11], have not demonstrated clear preferences for diagrammatic representations over structured or textual representations, thus, there is no evidence that such a social desirability for diagram preference exists at all.

From a statistical point of view, we note that there are limits to the *conclusion validity*. In particular, because of the nature of the data collected, we conducted and reported the tests for cognitive style influence and application task influence independently. We reported the results from these analyses without Bonferroni alpha level adjustments. In addition, preferences scores were negatively skewed, which may indicate some levels of heteroscedasticity. This might weaken, but not invalidate the analysis [79, p. 85] but should nevertheless be taken into consideration when interpreting the results. In conclusion, we do advise the reader to bear in mind that we report preliminary, not necessarily statistically conclusive findings.

7 Implications

Three broad implications arise for process modeling research. First, we believe we gathered sufficient evidence that future research on user perceptions of, and attitudes towards, process modeling should take differences in task settings more explicitly into account. Second, we showed how preference of visual process models varies across task settings. Regarding research addressing cognitive styles in the context of (process) modeling, future research might be advised to distinguish between two different visual styles (object and spatial), instead of focusing on the bipolar visual versus verbal dimension only, which has a long tradition in examining different representation types for learning or reasoning activities [e.g., 89]. From a more general perspective, our article encourages the further exploration of cognitive science findings in (process) modeling research, as this may provide valuable insights in how to best exploit (process) modeling as a cognitive tool for different users and different uses.

Third, our study is the first to attempt to examine one important but neglected element of process modeling practice – that of the application task. We chose to examine four categories of tasks based on their relative importance as ranked by experts [5]. We did not explicitly consider tasks beyond those four, e.g., compliance management, knowledge management or simulation. Future research can now study the reported effects alongside four avenues:

- a) Research should examine in more detail the relevant attributes of different task settings to develop an understanding of the effects that we observed beyond the business process modeling field, for a variety of tasks in which visual models in general are used. For instance, research in the organizational behavior [26] and information processing literature [90] have provided differentiated models of tasks and their constituent characteristics, for instance, to differentiate problem-solving tasks further in terms of variety, interdependence and difficulty or problem representation. Such models can be useful in further developing our findings and generating novel substantive theory about model application tasks.
- b) Future research could extend this work by examining the application of further existing process representation formats, such as storyboard or canvas designs [10] or videos.
- c) As one reviewer rightfully pointed out, other opportunities for future research include the replication of the study in various forms. For instance, a lab study task could be added in which participants are asked to use different representation formats to carry out requested tasks before assessing preferences, which would yield insight on preference changes through application experience and might also reveal how preferences and performance are connected.
- d) Research should also examine different dependent variables related to process model use in accordance to different task settings. For example, typical phenomena of interest include comprehension of process models [18], problem-solving with models [86], or usefulness and intention to use [1]. Of course, one may also envisage and study other behaviors or practices that warrant attention, such as satisfaction or collaboration.

Regarding implications for process modeling practice, we believe our findings inform two neglected aspects – the dependence of the preference for visual process models on the task setting, and on individual difference factors of possible users. Our findings can inform ongoing revisions of process modeling tools to promote the support of different representations and views on a business process for different tasks. Modeling tools could enable users to flexibly switch features as icons on/off, auto-generate other representation formats (e.g., structured text from a process model or the other way), (semi-) automatically suggest appropriate representation formats and provide the combined view on various representation formats at the same time. Additionally, the finding that icons are more relevant to tasks that involve an understanding of a process than for executing and improving tasks can directly be transferred to practice. The effort of finding appropriate icons has to be questioned if understanding of an unfamiliar process is not the foremost goal as for other tasks their use is not necessarily an improvement.

Given that cognitive styles assessed even influence professional and educational choices of individuals [43] and in our study were shown to be relevant for whether individuals prefer to work with a particular process model, practitioners should be aware that there is not the “one fits all” representation in process-related projects. While it will not be feasible, for instance, to measure cognitive styles of participants of a process redesign workshop to choose the optimal representation type, still, awareness of different preferences and possibly offering textual as well as diagrammatic content appears beneficial. Instructions on understanding process models might be adapted to fit individuals’ styles, users with high spatial style could for instance be warned that spatial information, e.g.,

the length of a connection between activities has no semantic meaning, while differences in symbols carry important meaning. Users with high object style might benefit from concrete, interactive simulations of a process execution and users with high verbal style might profit from additional textual descriptions and explanations of the process.

Finally, our study in general yielded an overall preference for diagrammatic over textual representations and thus further encourages the current use, and ongoing development, of process model grammars such as BPMN for process management practice.

8 Conclusions

In this study, we contribute to process modeling research by providing an empirical analysis of user preferences for different process representation formats. Our findings suggest that cognitive style and task setting are relevant predictors for user preferences of textual versus diagrammatic representations as well as the use of additional icons. This study is one of the first to consider the task context and cognitive styles for process modeling usage beliefs and therefore denotes an important extension to the literature and provides a basis for development of novel substantive theory.

9 References

1. Davies I, Green P, Rosemann M, Indulska M, Gallo S (2006) How do Practitioners Use Conceptual Modeling in Practice? *Data & Knowledge Engineering* 58 (3):358-380.
2. Recker J, Rosemann M, Indulska M, Green P (2009) Business Process Modeling: A Comparative Analysis. *Journal of the Association for Information Systems* 10 (4):333-363.
3. Fettke P (2009) How Conceptual Modeling Is Used. *Communications of the Association for Information Systems* 25 (43):571-592.
4. Kock N, Verville J, Danesh-Pajou A, DeLuca D (2009) Communication Flow Orientation in Business Process Modeling and Its Effect on Redesign Success: Results from a Field Study. *Decision Support Systems* 46 (2):562-575.
5. Indulska M, Green P, Recker J, Rosemann M (2009) Business Process Modeling: Perceived Benefits. In: Castano S, Dayal U, Laender AHF (eds) *Conceptual Modeling - ER 2009*. Lecture Notes in Computer Science. Springer, Gramado, Brazil, pp 458-471.
6. Wolter C, Meinel C (2010) An approach to capture authorisation requirements in business processes. *Requirements Engineering* 15 (4):359-373.
7. Phalp KT, Vincent J, Cox K (2007) Improving the Quality of Use Case Descriptions: Empirical Assessment of Writing Guidelines. *Software Quality Journal* 15 (4):383-399.
8. Lee J, Wyner GM, Pentland BT (2008) Process Grammar as a Tool for Business Process Design. *MIS Quarterly* 32 (4):757-778.
9. Moody DL (2009) The “Physics” of Notations: Toward a Scientific Basis for Constructing Visual Notations in Software Engineering. *IEEE Transactions on Software Engineering* 35 (6):756-779.
10. Recker J, Safrudin N, Rosemann M (2012) How Novices Design Business Processes. *Information Systems* 37 (6):557-573.

11. Boekelder A, Steehouder M (1998) Selecting and switching: Some advantages of diagrams over tables and lists for presenting instructions. *IEEE Transactions on Professional Communication* 41 (4):229-241.
12. Coll RA, Coll JH, Thakur G (1994) Graphs and tables: a four-factor experiment. *Communications of the ACM* 37 (4):76-86.
13. Riding R, Cheema I (1991) Cognitive Styles—an overview and integration. *Educational Psychology: An International Journal of Experimental Educational Psychology* 11 (3):193 - 215.
14. Thomas PR, McKay JB (2010) Cognitive styles and instructional design in university learning. *Learning and Individual Differences* 20 (3):197-202.
15. Recker J (2010) Opportunities and Constraints: The Current Struggle with BPMN. *Business Process Management Journal* 16 (1):181-201.
16. Dehnert J, van der Aalst WMP (2004) Bridging The Gap Between Business Models And Workflow Specifications. *International Journal of Cooperative Information Systems* 13 (3):289-332.
17. Bandara W, Gable GG, Rosemann M (2005) Factors and Measures of Business Process Modelling: Model Building Through a Multiple Case Study. *European Journal of Information Systems* 14 (4):347-360.
18. Reijers HA, Mendling J (2011) A Study into the Factors that Influence the Understandability of Business Process Models. *IEEE Transactions on Systems Man & Cybernetics, Part A* 41 (3):449-462.
19. Simon HA (1996) *The Sciences of the Artificial*. 3rd edn. MIT Press, Cambridge, Massachusetts.
20. Kalpic B, Bernus P (2006) Business Process Modeling Through the Knowledge Management Perspective. *Journal of Knowledge Management* 10 (3):40-56.
21. Kim H-W, Kim Y-G (1997) Dynamic Process Modeling for BPR: A Computerized Simulation Approach. *Information & Management* 32 (1):1-13.
22. Ouyang C, van der Aalst WMP, Dumas M, ter Hofstede AHM, Mendling J (2009) From Business Process Models to Process-Oriented Software Systems. *ACM Transactions on Software Engineering Methodology* 19 (1):2-37.
23. Dumas M, La Rosa M, Mendling J, Reijers HA (2013) *Fundamentals of Business Process Management*. Springer, Berlin, Germany.
24. Burton-Jones A, Meso P (2008) The Effects of Decomposition Quality and Multiple Forms of Information on Novices' Understanding of a Domain from a Conceptual Model. *Journal of the Association for Information Systems* 9 (12):784-802.
25. Mendling J, Strembeck M, Recker J (2012) Factors of Process Model Comprehension — Findings from a Series of Experiments. *Decision Support Systems* 53 (1):195-206.
26. Campbell DJ (1988) Task Complexity: A Review and Analysis. *Academy of Management Review* 13 (1):40-52.
27. Akin Ö, Akin C (1998) On the process of creativity in puzzles, inventions, and designs. *Automation in Construction* 7 (2-3):123-138.
28. Kettinger WJ, Teng JTC, Guha S (1997) Business Process Change: A Study of Methodologies, Techniques, and Tools. *MIS Quarterly* 21 (1):55-80.
29. Sarkar P, Chakrabarti A (2008) The effect of representation of triggers on design outcomes. *Artif Intell Eng Des Anal Manuf* 22 (2):101-116.
30. Gorla N, Pu H-C, Rom WO (1995) Evaluation of process tools in systems analysis. *Information and Software Technology* 37 (2):119-126.

31. Friedrich F, Mendling J, Puhlmann F (2011) Process Model Generation from Natural Language Text. In: Mouratidis H, Rolland C (eds) *Advanced Information Systems Engineering - CAiSe 2011*, vol 6741. *Lecture Notes in Computer Science*. Springer, London, England, pp 482-496.
32. Blumberg R, Atre S (2003) The Problem with Unstructured Data. *DM Review* 13:42-49.
33. Cockburn A (2000) *Writing Effective Use Cases*. Addison-Wesley Longman Publishing Co., Inc.
34. Vessey I, Weber R (1986) Structured Tools and Conditional Logic: An Empirical Investigation. *Communications of the ACM* 29 (1):48-57.
35. Moody DL (2009) The “Physics” of Notations: Towards a Scientific Basis for Constructing Visual Notations in Software Engineering. *IEEE Transactions on Software Engineering* 35 (5):756-779.
36. Curtis B, Sheppard SB, Kruesi-Bailey E, Bailey J, Boehm-Davis DA (1989) Experimental evaluation of software documentation formats. *Journal of Systems and Software* 9 (2):167-207.
37. Larkin JH, Simon HA (1987) Why a Diagram is (Sometimes) Worth Ten Thousand Words. *Cognitive Science* 11 (1):65-100.
38. Ottensooser A, Fekete A, Reijers HA, Mendling J, Menictas C (2012) Making Sense of Business Process Descriptions: An Experimental Comparison of Graphical and Textual Notations. *Journal of Systems and Software* 85 (3):596-606.
39. Masri K, Parker DC, Gemino A (2008) Using Iconic Graphics in Entity-Relationship Diagrams: The Impact on Understanding. *Journal of Database Management* 19 (3):22-41.
40. Mendling J, Recker J, Reijers HA (2010) On the Usage of Labels and Icons in Business Process Modeling. *International Journal of Information System Modeling and Design* 1 (2):40-58.
41. Malaga RA (2000) The effect of stimulus modes and associative distance in individual creativity support systems. *Decision Support Systems* 29 (2):125-141.
42. Zajonc RB, Hazel M (1982) Affective and Cognitive Factors in Preferences. *Journal of Consumer Research* 9 (2):123-131.
43. Blazhenkova O, Kozhevnikov M (2009) The New Object-Spatial-Verbal Cognitive Style Model: Theory and Measurement. *Applied Cognitive Psychology* 23 (5):638-663.
44. Vessey I, Galletta DF (1991) Cognitive Fit: An Empirical Study of Information Acquisition. *Information Systems Research* 2 (1):63-84.
45. Vessey I (1991) Cognitive Fit: A Theory-Based Analysis of the Graphs Versus Tables Literature. *Decision Sciences* 22 (2):219-240.
46. Blazhenkova O, Kozhevnikov M (2008) The new object-spatial-verbal cognitive style model: Theory and measurement. *Applied Cognitive Psychology* 23 (5):638-663.
47. Stebbins RA (2001) *Exploratory Research in the Social Sciences*, vol 48. *Qualitative Research Methods*. Sage, Thousand Oaks, California.
48. Kumar S, Karoli V (2011) *Handbook Of Business Research Methods*. Thakur Publishers.
49. Recker J, Reijers HA, van de Wouw SG (2014) Process Model Comprehension: The Effects of Cognitive Abilities, Learning Style and Strategy. *Communications of the Association for Information Systems* 34 (9):199-222.
50. Fromkin HL, Streufert S (1976) *Laboratory Experimentation*. Rand McNally College Publishing Company, Chicago, Illinois.

51. Recker J, Mendling J, Hahn C (2013) How Collaborative Technology Supports Cognitive Processes in Collaborative Process Modeling: A Capabilities-Gains-Outcome Model. *Information Systems* 38 (8):1031-1045.
52. Lichtenstein S, Slovic P (eds) (2006) *The Construction of Preference*. Cambridge University Press, New York.
53. Recker J (2010) Continued Use of Process Modeling Grammars: The Impact of Individual Difference Factors. *European Journal of Information Systems* 19 (1):76-92.
54. Brehm JW (1956) Post-decision Changes in the Desirability of Alternatives. *The Journal of Abnormal and Social Psychology* 52 (3):384-389.
55. Ben-Simon A, Budescu DV, Nevo B (1997) A Comparative Study of Measures of Partial Knowledge in Multiple-Choice Tests. *Applied Psychological Measurement* 21 (1):65-88.
56. Blajenkova O, Kozhevnikov M, Motes MA (2006) Object-spatial imagery: a new self-report imagery questionnaire. *Applied Cognitive Psychology* 20 (2):239-263.
57. Kozhevnikov M, Blazhenkova O, Becker M (2010) Trade-off in object versus spatial visualization abilities: Restriction in the development of visual-processing resources. *Psychonomic Bulletin & Review* 17 (1):29-35.
58. Kozhevnikov M, Kozhevnikov M, Yu CJ, Blazhenkova O (2013) Creativity, visualization abilities, and visual cognitive style. *British Journal of Educational Psychology* 83 (2):196-209.
59. Campos A (2014) Gender differences in imagery. *Personality and Individual Differences* 59:107-111.
60. Ocelli V, Lin JB, Lacey S, Sathian K (2014) Loss of form vision impairs spatial imagery. *Frontiers in human neuroscience* 8.
61. Kraemer DJ, Hamilton RH, Messing SB, DeSantis JH, Thompson-Schill SL (2014) Cognitive style, cortical stimulation, and the conversion hypothesis. *Frontiers in human neuroscience* 8.
62. Aggarwal I, Woolley AW (2013) Do you see what I see? The effect of members' cognitive styles on team processes and errors in task execution. *Organizational Behavior and Human Decision Processes* 122 (1):92-99.
63. OMG (2011) *Business Process Model and Notation (BPMN) - Version 2.0*. Object Management Group. <http://www.omg.org/spec/BPMN/2.0>. Accessed March 17 2011
64. Khatri V, Vessey I, Ramesh V, Clay P, Sung-Jin P (2006) Understanding Conceptual Schemas: Exploring the Role of Application and IS Domain Knowledge. *Information Systems Research* 17 (1):81-99.
65. Patig S, Casanova-Brito V, Vögeli B (2010) IT Requirements of Business Process Management in Practice – An Empirical Study. In: Hull R, Mendling J, Tai S (eds) *Business Process Management - BPM 2010*, vol 6336. *Lecture Notes in Computer Science*. Springer, Hoboken, New Jersey, pp 13-28.
66. Reijers HA, Freytag T, Mendling J, Eckleder A (2011) Syntax Highlighting in Business Process Models. *Decision Support Systems* 51 (3):339-349.
67. zur Muehlen M, Recker J (2008) How Much Language is Enough? Theoretical and Practical Use of the Business Process Modeling Notation. In: Léonard M, Bellahsène Z (eds) *Advanced Information Systems Engineering - CAiSE 2008*. *Lecture Notes in Computer Science*. Springer, Montpellier, France, pp 465-479.
68. Saari DG (2000) Mathematical Structure of Voting Paradoxes: II. Positional Voting. *Economic Theory* 15 (1):55-102.
69. Cook C, Heath F, Thompson RL, Thompson B (2001) Score Reliability in Webor Internet-Based Surveys: Unnumbered Graphic Rating Scales versus Likert-Type Scales. *Educational and Psychological Measurement* 61 (4):697-706.

70. Gemino A, Wand Y (2004) A Framework for Empirical Evaluation of Conceptual Modeling Techniques. *Requirements Engineering* 9 (4):248-260.
71. Compeau DR, Marcolin BL, Kelley H, Higgins CA (2012) Generalizability of Information Systems Research Using Student Subjects — A Reflection on Our Practices and Recommendations for Future Research. *Information Systems Research* 23 (4):1093-1109.
72. Runeson P Using Students as Experiment Subjects – An Analysis on Graduate and Freshmen Student Data. In: Linkman S (ed) 7th International Conference on Empirical Assessment & Evaluation in Software Engineering, Staffordshire, England, 2003. Keele University, pp 95-102.
73. Faul F, Erdfelder E, Lang A-G, Axel B (2007) G*Power 3: A Flexible Statistical Power Analysis for the Social, Behavioral, and Biomedical Sciences. *Behavior Research Methods* 39 (2):175-191.
74. Leys C, Ley C, Klein O, Bernard P, Licata L (2013) Detecting outliers: Do not use standard deviation around the mean, use absolute deviation around the median. *Journal of Experimental Social Psychology* 49 (4):764-766.
75. Recker J (2013) Empirical Investigation of the Usefulness of Gateway Constructs in Process Models. *European Journal of Information Systems* 22 (6):673-689.
76. Figl K, Mendling J, Strembeck M (2013) The Influence of Notational Deficiencies on Process Model Comprehension. *Journal of the Association for Information Systems* 14 (6):312-338.
77. Reijers HA, Mendling J (2011) A Study into the Factors that Influence the Understandability of Business Process Models. *IEEE Transactions on Systems, Man, and Cybernetics - Part A* 41:449-462.
78. Stevens JP (2001) *Applied Multivariate Statistics for the Social Sciences*. Applied Multivariate STATS, 4th edn. Lawrence Erlbaum Associates, Hillsdale, New Jersey.
79. Tabachnick BG, Fidell LS (2007) *Using Multivariate Statistics*. Pearson Education, Inc., Boston.
80. Kozhevnikov M, Hegarty M, Mayer RE (2002) Revising the Visualizer-Verbalizer Dimension: Evidence for Two Types of Visualizers. *Cognition and Instruction* 20 (1):47-77.
81. Glenberg AM, Langston WE (1992) Comprehension of illustrated text: Pictures help to build mental models. *Journal of Memory and Language* 31 (2):129-151.
82. Cheng PC (2004) Why diagrams are (sometimes) six times easier than words: benefits beyond locational indexing. In: *Diagrammatic Representation and Inference*. Springer, pp 242-254.
83. Scaife M, Rogers Y (1996) External cognition: how do graphical representations work? *Int J Hum-Comput Stud* 45 (2):185-213.
84. Mayer RE (2009) *Multimedia Learning*. 2nd edn. Cambridge University Press, Cambridge, Massachusetts.
85. Shadish WR, Cook TD, Campbell DT (2002) *Experimental and quasi-experimental designs for generalized causal inference*. Houghton Mifflin Company, Boston, New York.
86. Recker J, Dreiling A (2011) The Effects of Content Presentation Format and User Characteristics on Novice Developers' Understanding of Process Models. *Communications of the Association for Information Systems* 28 (6):65-84.
87. Reijers HA, Mendling J, Dijkman RM (2011) Human and Automatic Modularizations of Process Models to Enhance their Comprehension. *Information Systems* 36 (5):881-897.
88. Fisher RJ (1993) Social desirability bias and the validity of indirect questioning. *Journal of Consumer Research* 20 (2):303-315.
89. Paivio A, Harshmann R (1983) Factor Analysis of a Questionnaire on Imagery and Verbal Habits and Skills. *Canadian Journal of Psychology* 37 (4):461-483.

90. Byström K, Järvelin K (1995) Task Complexity Affects Information Seeking and Use. *Information Processing & Management* 31 (2):191-213.

10 Appendix A

10.1 Demographic Questions

1. *Age*: What is your age? ____ years
2. *Gender*: What is your gender? [male/female]
3. *Education*: What is the highest degree or level of school you have completed?
 - No schooling completed
 - High school graduate
 - 1 or more years of college/university, major subject: _____
 - Bachelor's degree, major subject: _____
 - Master's degree, major subject: _____
 - Doctorate degree, major subject: _____
4. *Process modeling experience*: Roughly, how many process models have you...
 - ...created to date? ____ ○ None
 - ...read to date? ____ ○ None

10.2 Conceptual Modeling Familiarity Test [correct answer highlighted bold]

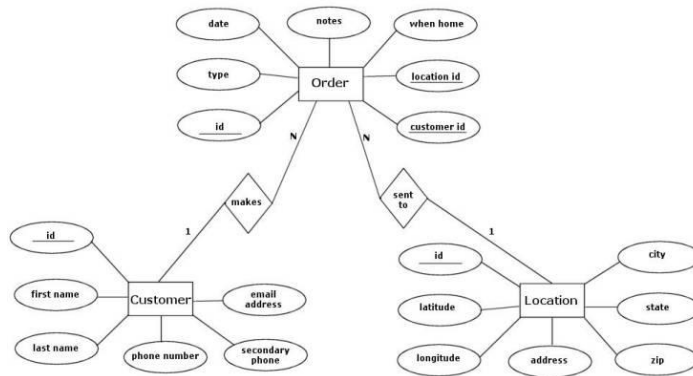

What type of model is this?

- Entity Relationship Diagram**
- Data Flow Diagram
- Object Role Diagram
- UML Class Diagram
- IDEF1X Entity Level Diagram
- I don't know.

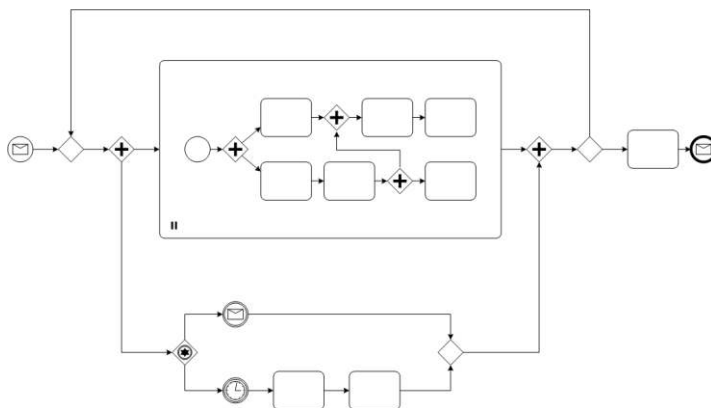

What type of model is this?

- UML Activity Diagram
- Event-Driven Process Chain Diagram
- Business Process Modeling Notation Diagram**
- UML Interaction Diagram
- YAWL Diagram
- I don't know.

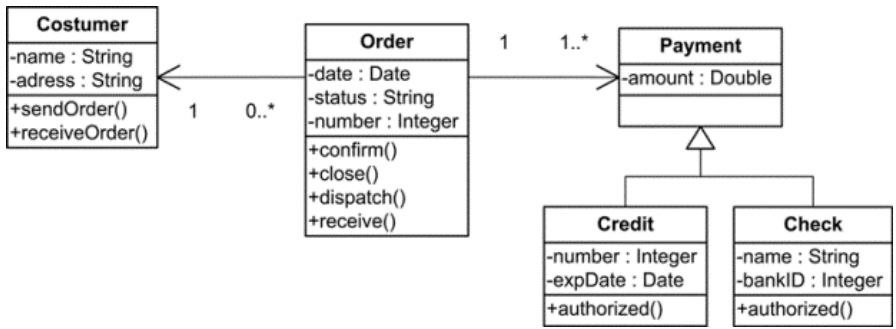

What type of model is this?

- UML Communication Diagram
- UML Class Diagram**
- UML Deployment Diagram
- UML Composite Structure Diagram
- UML Package Diagram
- I don't know.

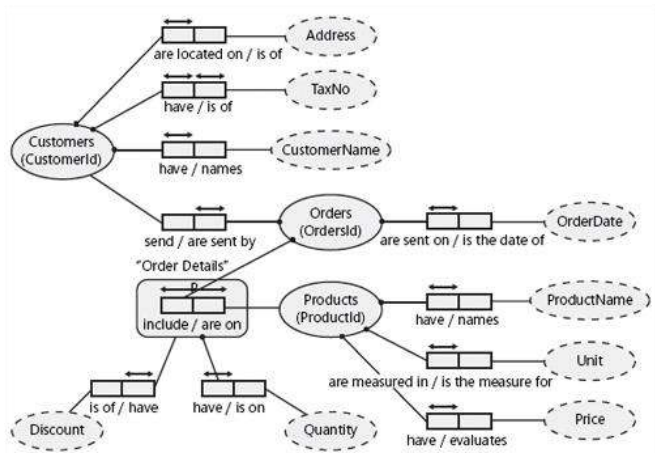

What type of model is this?

- Entity Relationship Diagram
- Bachman Diagram
- Object Relationship Diagram**
- UML Object Diagram
- EXPRESS-G Data Diagram
- I don't know.

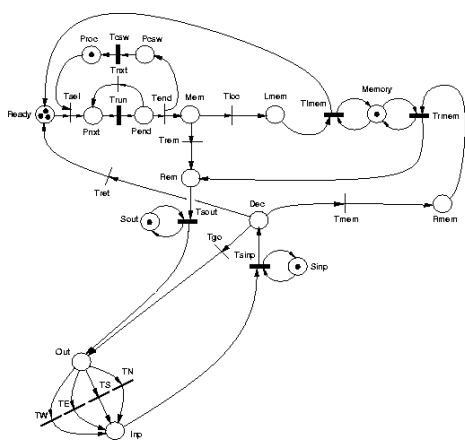

What type of model is this?

- Causal Loop Diagram
- WorkFlow Net Diagram
- **Petri-Net Diagram**
- Spider Diagram
- Binary Decision Diagram
- I don't know.

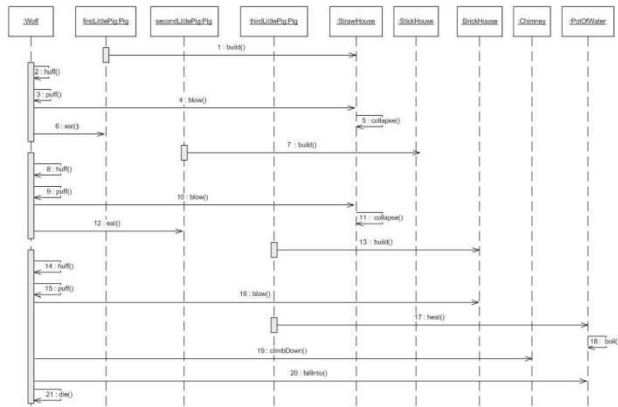

What type of model is this?

- IDEF3 Diagram
- UML Use Case Diagram
- Harel State Chart Diagram
- Kripke Diagram
- **UML Sequence Diagram**
- I don't know.

10.3 Cognitive Styles Test

The questions were taken from [43] and provided using a 5-item Likert scale anchored between “totally disagree” and “totally agree” with the mid-point “neutral”.

Process Representation Forms

We will now show you six different visual representations for the Nobel Prize process. Each representation will be displayed for 50 seconds. Please study each representation carefully. After all representations have been shown, the survey will proceed automatically.

Text without icons

In the beginning the Nobel committee sends nomination invitations to the nominators.

The nominators identify potential nominees and send completed nomination forms to

the Nobel committee, who collects completed forms. Then the Nobel committee

determines if there is a need for expert assistance. If expert assistance is required,

they send a list of selected preliminary candidates to experts. The experts assess the

candidates work and send the candidates assessment reports to the Nobel committee,

who collects candidates work assessment reports. Then the Nobel committee selects

final candidates and their works. If no expert assistance is required, the Nobel

committee immediately selects final candidates and their works. Then the Nobel

committee writes a recommendations report and submits the recommendations report

to the Nobel assembly. The Nobel assembly discusses nominations and selects

laureates. Then the Nobel assembly announces Nobel prize laureates. In the end the

Nobel committee holds the Nobel prize award ceremony.

Text with icons



In the beginning the Nobel committee sends nomination invitations  to the nominators.

The nominators identify potential nominees  and send completed nomination forms

 to the Nobel committee, who collects completed forms . Then the Nobel

committee determines if there is a need for expert assistance . If expert assistance is

required, they send a list of selected preliminary candidates  to experts. The experts

assess the candidates work  and send the candidates assessment reports  to the

Nobel committee, who collects candidates work assessment reports . Then the Nobel

committee selects final candidates and their works . If no expert assistance is

required, the Nobel committee immediately selects final candidates and their works .

Then the Nobel committee writes a recommendations report  and submits the

recommendations report to the Nobel assembly . The Nobel assembly discusses

nominations  and selects laureates . Then the Nobel assembly announces

Nobel prize laureates . In the end the Nobel committee holds the Nobel prize award

ceremony 

Structured text without icons

Nobel committee

BEGIN

send nomination invitations

collect completed forms

determine need for expert assistance

IF expert assistance is required

THEN

send list of selected preliminary candidates

collect candidates work assessment reports

END IF

select final candidates and their works

write recommendations report

submit recommendations report

hold Nobel prize award ceremony

END

nominators

identify potential nominees

send completed nomination forms

experts

assess candidates work

send candidates assessment report

Nobel assembly

discuss nominations

select laureates

announce Nobel prize laureates

Structured text with icons

Nobel committee

BEGIN

send nomination invitations 

collect completed forms 

determine need for expert assistance 

IF expert assistance is required

THEN

send list of selected preliminary candidates 

collect candidates work assessment reports 

END IF

select final candidates and their works 

write recommendations report 

submit recommendations report 

hold Nobel prize award ceremony 

END

nominators

identify potential nominees 

send completed nomination forms 

experts

assess candidates work 

send candidates assessment report 

Nobel assembly

discuss nominations 

select laureates 

announce Nobel prize laureates 

Diagram without icons

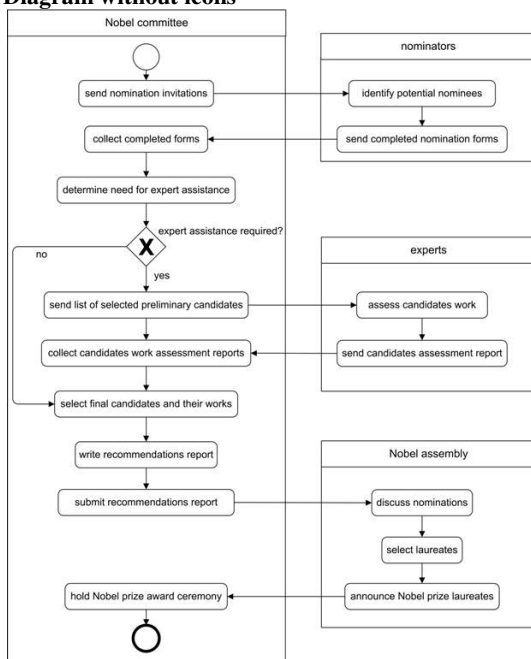
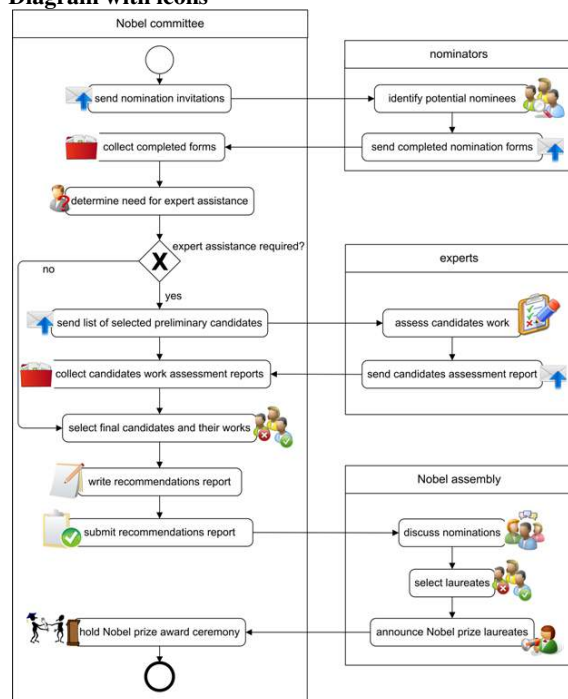

Diagram with icons













10.4 Task Preference Ratings

Now that you have seen all representations, we will ask you to answer some questions.

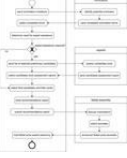
1. Image your task is to **understand** the Nobel Prize process without being familiar with it and you can choose one representation of the process to assist you in this task.
2. Image your task is to **communicate** the Nobel Prize process to someone unfamiliar with the Nobel Prize procedures and you can choose one representation of the process to assist you in this task.
3. Image your task is to develop an IT-based system to **execute** the Nobel Prize process and you can choose one representation of the process to assist you in this task.
4. Image your task is to identify opportunities to **improve** the way the Nobel Prize process is being executed and you can choose one representation of the process to assist you in this task.

10.5 Preference Ratings

Please indicate your preference of using different representation formats by moving the slide control.

	no preference	
<p>text</p> 		<p>structured text</p> 
<p>structured text</p> 		<p>diagram</p> 
<p>text</p> 		<p>diagram</p> 
<p>without icons</p> 		<p>with icons</p> 

11 Appendix B

Dependent Variable	Group		Task 1: Understanding	Task 2: Explaining	Task 3: Automating	Task 4: Improving	All Tasks	
<i>Preference for Structured Text over Text</i>	Low object orientation (n = 53)	Mean	73.66	75.26	83.24	80.85	78.25	
		SD	33.17	29.63	27.55	31.17	23.16	
	High object orientation (n = 62)	Mean	66.23	75.96	82.62	83.64	77.11	
		SD	40.85	34.27	31.07	28.15	26.53	
	Low spatial orientation (n = 58)	Mean	69.64	76.21	80.98	78.33	76.29	
		SD	35.28	28.61	28.81	30.45	24.13	
	High spatial orientation (n = 57)	Mean	70.84	74.95	84.96	86.02	79.19	
		SD	38.83	34.83	29.49	28.71	25.34	
	Low verbal orientation (n = 60)	Mean	68.05	72.77	81.42	81.83	76.02	
		SD	38.33	35.94	32.59	30.67	26.14	
	High verbal orientation (n = 55)	Mean	72.62	78.65	84.64	82.47	79.60	
		SD	35.53	26.33	24.91	28.93	23.05	
	<i>Preference for Diagram over Structured Text</i>	Low object orientation (n = 53)	Mean	74.74	72.34	79.05	83.18	77.33
			SD	32.81	34.25	32.35	28.45	23.48
High object orientation (n = 62)		Mean	74.04	78.60	80.81	75.00	77.11	
		SD	33.54	30.04	31.15	35.76	27.79	
Low spatial orientation (n = 58)		Mean	70.78	72.88	78.59	79.22	75.37	
		SD	35.69	33.54	31.60	31.34	24.92	
High spatial orientation (n = 57)		Mean	78.12	77.61	81.16	79.60	79.12	
		SD	29.88	31.30	31.98	33.22	26.04	
Low verbal orientation (n = 60)		Mean	83.02	81.20	85.82	81.50	82.88	
		SD	24.07	27.34	26.81	30.96	20.76	
High verbal orientation (n = 55)		Mean	65.04	68.71	73.36	77.13	71.06	
		SD	38.66	36.26	35.36	33.53	28.66	
<i>Preference for Diagram over Text</i>		Low object orientation (n = 53)	Mean	82.69	86.19	91.23	91.21	87.83
			SD	28.41	24.58	19.31	20.42	15.80
	High object orientation (n = 62)	Mean	76.96	86.83	89.43	88.98	85.55	
		SD	32.10	24.06	23.03	21.04	20.96	
	Low spatial orientation (n = 58)	Mean	74.24	83.74	86.02	89.24	83.31	
		SD	35.70	27.84	25.12	19.79	19.36	
	High spatial orientation (n = 57)	Mean	85.96	89.28	94.86	91.14	90.31	
		SD	22.02	19.78	14.76	21.61	16.60	
	Low verbal orientation (n = 60)	Mean	83.72	87.75	91.27	91.43	88.54	
		SD	26.41	22.15	20.36	17.88	14.84	
	High verbal orientation (n = 55)	Mean	76.05	85.11	89.45	88.82	84.86	
		SD	33.58	26.47	21.89	23.38	21.44	
	<i>Preference for Icons</i>	Low object orientation (n = 53)	Mean	60.32	65.35	48.73	44.98	54.85
			SD	39.11	37.02	41.28	40.95	33.56
High object orientation (n = 62)		Mean	66.11	64.98	59.17	57.60	61.97	
		SD	35.62	36.17	39.16	37.57	29.49	
Low spatial orientation (n = 58)		Mean	67.09	73.43	57.07	55.12	63.18	
		SD	36.51	31.74	39.41	39.04	30.13	
High spatial orientation (n = 57)		Mean	58.82	56.79	49.95	46.40	52.99	
		SD	38.34	39.24	41.58	40.35	32.92	
Low verbal orientation (n = 60)		Mean	63.27	65.03	51.97	54.48	58.69	
		SD	34.76	33.28	39.68	37.74	29.83	
High verbal orientation (n = 55)		Mean	62.69	65.35	55.25	46.78	57.52	
		SD	40.59	39.97	41.63	41.84	34.12	