

Face Recognition Using Neural Network: A Review

Manisha M. Kasar¹, Debnath Bhattacharyya¹ and Tai-hoon Kim^{2,*}

¹*Department of Information Technology,
Bharati Vidyapeeth University College of Engineering,
Pune-411043, India*

²*Department of Convergence Security,
Sungshin Women's University,
Dongseon-dong 3-ga, Seoul, Korea
{kasarmanisha,debnathb}@gmail.com, taihoonn@daum.net*

Abstract

Face recognition from the real data, capture images, sensor images and database images is challenging problem due to the wide variation of face appearances, illumination effect and the complexity of the image background. Face recognition is one of the most effective and relevant applications of image processing and biometric systems. In this paper we are discussing the face recognition methods, algorithms proposed by many researchers using artificial neural networks (ANN) which have been used in the field of image processing and pattern recognition. How ANN will used for the face recognition system and how it is effective than another methods will also discuss in this paper. There are many ANN proposed methods which give overview face recognition using ANN. Therefore, this research includes a general review of face detection studies and systems which based on different ANN approaches and algorithms. The strengths and limitations of these literature studies and systems were included, and also the performance analysis of different ANN approach and algorithm is analysing in this research study.

Keywords: *Face Recognition, Biometric, Image Processing, Pattern Recognition, Artificial Neural Network*

1. Introduction

Face recognition is a very challenging research area in computer vision and pattern recognition due to variations in facial expressions, poses and illumination. Several emerging applications, from law enforcement to commercial tasks, demand the industry to develop efficient and automated face recognition systems. Although, many researchers have worked on the problem of face recognition for many years still several challenges need to be solved. Difference in illumination of the scene, changes in pose, orientation and expression are examples of some of the issues to be dealt carefully. Also when size of face database increases the recognition time becomes a big constraint. Face recognition is one of the biometric methods that to have the merits of both high accuracy and low intrusiveness. It has the accuracy of a physiological approach without being intrusive. For this reason, the face recognition has drawn the attention of researchers in fields from security, Psychology, and image processing, to computer vision. Many algorithms have been proposed for face recognition, Face recognition has also proven useful in other multimedia information processing areas. Facial recognition analyzes the characteristics of a person's face images input through a digital video camera or online face capturing. Now days we need to maintain global security Information, in every organization or individual wants to improve their existing security system. Most of the people need better security system which gives complete security solution. From time to time we hear about

* Corresponding Author

the crimes of credit card fraud, computer break-in by hackers, or security breaches in company, in shops, in government buildings. In most of these crimes the criminals were taking advantage of that hacking the information from commercial or academic access control system. The systems do not grant access by who we are, but by what we have, such as ID cards, keys, passwords, PIN numbers. These means they are really defining us or they just want to authenticate us. It goes without Permission of owner's, duplicates, or acquires these identity means, he or she will be able to access our data or our personal property any time they want. Recently, technology became available to allow verification of true individual identity. This technology is based in a field called "biometrics". Biometrics is a technique for identifying people by using a unique physiological characteristic, such as a fingerprint, eye, face, *etc.* or behavioural characteristics, *e.g.*, voice and signature *etc.* Biometrics is the use of computers to recognize people, considering all of the across-individual similarities and within-individual variations. Among the various biometric ID methods, physiological methods such as fingerprint, face, DNA are more stable than methods in behavioural category like keystroke, voice print *etc.*

In this survey paper we are discussing the different neural network techniques which is has been proposed by many researcher in face recognition system .In this field many researcher has done research on different types of face recognition using ANN algorithms and approaches. The last few decades have observed that artificial neural networks (ANNs) has used in various fields including pattern recognition, image processing, fault diagnosis *etc.* The study of neural networks has gained as research interests from the early1980s. ANNs, as both predictors of dynamic non-linear models and pattern classifiers for evaluation, have been suggested as a possible technique for the face direction recognition. For this instead of requiring an accurate mathematical model of the process, these approaches only require representative training data.

In this paper, the section II gives Structure of Face Recognition System, section III gives Introduction to Neural Network Section IV gives the Literature Survey of Face Recognition Techniques Using ANN Algorithms and section V gives the conclusion and future scope for the paper.

2. Structure of Face Recognition System

Every Biometric system has four main features which are shown in Figure. 1: face Detection, preprocessing, Feature Extraction, and Face Recognition.

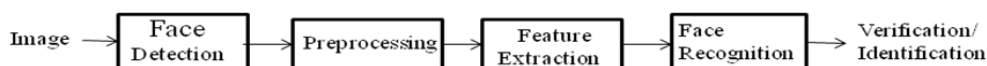

Figure 1. Architecture of Face Recognition System

As Figure 1 shows the first task of the face recognition system is capturing image by video, camera or from the database and this image is given to the further step of face recognition system that is discuss in this section:

2.1. Face Detection

The main function of this step is to detect the face from capture image or the selected image from the database. This face detection process actually verifies that weather the given image has face image or not, after detecting the face this output will be further given to the pre-processing step.

2.2. Pre-processing

This step is working as the pre-processing for face recognition, In this step the unwanted noise, blur, varying lightening condition, shadowing effects can be remove using pre-processing techniques .once we have fine smooth face image then it will be used for the feature extraction process.

2.3. Feature Extraction

In this step features of face can be extracted using feature extraction algorithm. Extractions are performed to do information packing, dimension reduction, salience extraction, and noise cleaning. After this step, a face patch is usually transformed into a vector with fixed dimension or a set of fiducial points and their corresponding locations.

2.4. Face Recognition

Once feature extraction is done step analyzes the representation of each face; this last step is used to recognize the identities of the faces for achieving the automatic face recognition, for the recognition a face database is required to build. For each person, several images are taken and their features are extracted and stored in the database. Then when an input face image comes for recognition, then it first performs face detection, pre-processing and feature extraction, after that it compare its feature to each face class which stored in the database. There are two general applications of face recognition, one is called identification and another one is called verification. Face identification means given a face image, can be used to determine a person's identity even without his knowledge. While in face verification, given a face image and a guess of the identification, the system must to tell about the true or false about the guess.

Face recognition can be largely classified into two different classes of approaches, the local feature-based method and the global feature-based method. The Human faces can be characterized both on the basis of local as well as of global features global features are easier to capture they are generally less discriminative than localized features local features on the face can be highly discriminative, but may suffer for local changes in the facial appearance or partial face occlusion. Now a day's face recognition system is recognize the face using multiple-views of faces, these Multi-view face recognition techniques has proposed by some authors for detecting each view of face such as left, right, front, top, and bottom *etc.*

In this paper we are going to discuss the various methods of Neural Network used in multi-view face recognition system, many researchers has used neural network in face recognition system using different approaches. First, we will discuss the concept of neural network and hot it will be used in face recognition system.

3. Neural Network

Neural network is a very powerful and robust classification technique which can be used for predicting not only for the known data, but also for the unknown data. It works well for both linear and non linear separable dataset. NN has been used in many areas such as interpreting visual scenes, speech recognition, face recognition, finger print recognition, iris recognition *etc.* An ANN is composed of a network of artificial neurons also known as "nodes". These nodes are connected to each other, and the strength of their connections to one another is assigned a value based on their strength: inhibition (maximum being -1.0) or excitation (maximum being +1.0). If the value of the connection is high, then it indicates that there is a strong connection. Within each node's design, a transfer function is built in. There are three types of neutrons in an ANN, input nodes, hidden nodes, and output nodes.

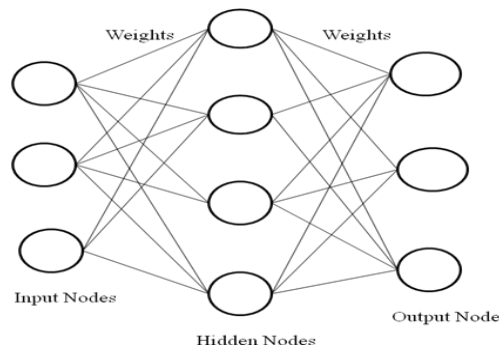

Figure 2. Artificial Neural Network

The input nodes take information, in the form of numeric expression. The information is presented as activation values, where each node has given a number, if the higher the number greater the activation. This information is then passed throughout the network. Based on the connection strengths which are weights, inhibition or excitation, and transfer functions, the activation value is passed from node to node. Each of the nodes sums the activation values it receives; it then modifies the value based on its transfer function. The activation flows through the network, through hidden layers, until it reaches the output nodes. The output nodes then reflect the meaningful.

3.1. Topologies of Neural Network

3.1.1. A Feed-Forward Network: A feed-forward network is a non-recurrent network which contains inputs, outputs, and hidden layers; the signals can only travel in one direction. Input data is passed onto a layer of processing elements where it performs calculations. Each processing element makes its computation based upon a weighted sum of its inputs. The new calculated values then become the new input values that feed the next layer. This process continues until it has gone through all the layers and determines the output. A threshold transfer function is sometimes used to quantify the output of a neuron in the output layer. Feed-forward networks include linear and non-linear and Radial Basis Function networks [1].

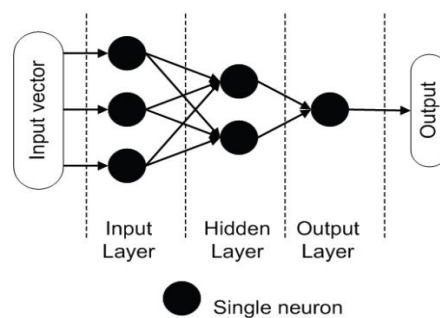

Figure 3. Feed-forward (FNN)

The Figure 3 represents simple feed forward topology also known as acyclic graph where the information is flows from inputs to outputs in only one direction while in Figure. 4. We need to mention that for easier understanding and mathematical description of an artificial neural network. We form group of individual neurons in layers. In Figure. 4. We can see input, hidden and output layer. When we choose and build topology of our artificial neural network we only finished half of the task before we can use this artificial

neural network for solving given problem. The next step is used to learn the proper response of an artificial neural network and this can be achieved through supervised, unsupervised or reinforcement learning. The task of learning is to set the values of weight and biases on basis of learning data to minimize the chosen cost function [1].

3.2.2. Recurrent (RNN) Neural Network:

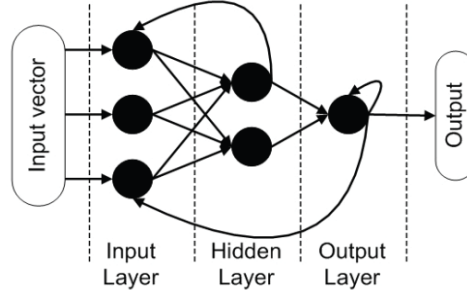

Figure 4. Recurrent (RNN) Topology of an Artificial Neural Network

In Figure 4. Represents simple recurrent topology also known as semi cyclic graph, where some of the information flows not only in one direction from input to output but also in opposite direction. Artificial neural network with the recurrent topology is called recurrent artificial neural network. It is similar to feed forward neural network with no limitations regarding back loops. In these cases information is no longer transmitted only in one direction but it is also transmitted backwards. This creates an internal state of the network which allows it to exhibit dynamic temporal behaviour. Recurrent artificial neural networks can use their internal memory to process any sequence of inputs. The most basic topology of recurrent artificial neural network is fully recurrent artificial network where every basic building block is directly connected to every other basic building block in all direction [1].

3.1 Types of Artificial Neural Networks

3.2.1. Single Layer Feed Forward Network: A neural network in which the input layer of source nodes is connected to an output layer of neurons but not vice-versa is known as single feed-forward or acyclic network. In single layer network, 'single layer' refers to the output layer of computation nodes as shown in Figure. 5 [2].

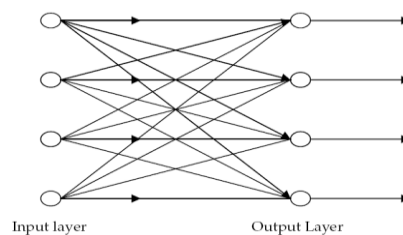

Figure 5. A Single Layer Feed Forward Network

3.2.2. Multilayer Feed Forward Network: This type of network consists of one or more hidden layers, whose computation nodes are called hidden neurons or hidden units. The function of hidden neurons is to interact between the external input and network. The source nodes in input layer of network supply the input signal to neurons in the second layer of 1st hidden layer. The output signals of 2nd layer are used as inputs to the third layer and so on. The set of output signals of the neurons in the output layer of network constitutes the overall response of network to the activation pattern supplied by source nodes in the input first layer [2].

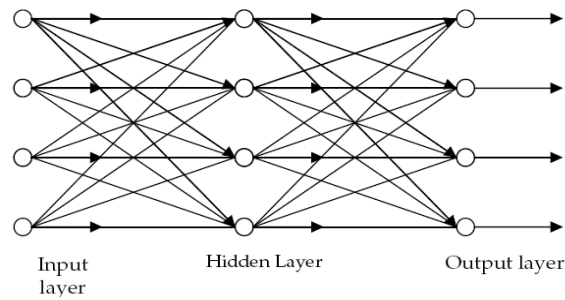

Figure 6. A Multilayer Feed Forward Network

3.2.3. Recurrent Network: A feed forward neural network having one or more hidden layers with at least one feedback loop is known as recurrent network as shown in Figure. 7. The feedback may be a self feedback, *i.e.*, where output of neuron is given back to its own input. Sometimes, feedback loops involve the use of unit delay elements, which results in nonlinear dynamic behaviour, assuming that neural network contains non linear units. There are various other types of networks like; delta-bar-delta, Hopfield, vector quantization, counter propagation, probabilistic, Hamming, Boltzman, bidirectional\ associative memory, spacio-temporal pattern, adaptive resonance, self organizing map, recirculation *etc* [2].

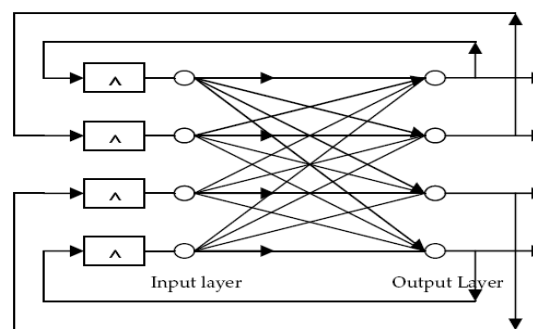

Figure 7. Recurrent Connected Network

ANN has been classified in different types like single layer feed forward Neural Network, Multilayer Feed Forward Neural Network, and Recurrent Network which is discuss here. The many researchers have used these types of ANN for Face recognition and Different they had proposed different algorithms for face recognition. In this paper we are discussing the methods on ANN which has been proposed by many researchers for face recognition such as, PCA with Artificial Neural Networks [3], Deep Convolution Neural Networks [4], Radial basis function neural networks [10], Convolutional Neural Network Cascade [11], Bilinear CNNs [12], Back Propagation Network (BPN) and Radial Basis Function Network (RBF) [13], Retinal Connected Neural Network (RCNN) [14], Rotation Invariant Neural Network (RINN) [15], Fast Neural Network [16], Evolutionary Optimization of Neural Networks [17], Multilayer Perceptron (MLP) [18], Gabor Wavelet Faces with ANN [19], Hybrid Wavelet Neural Network and Switching Particle Swarm Optimization algorithm [20] *etc*.

The method proposed by Navneet Jindal, Vikas Kumar [3], is PCA with ANN method. PCA is dimensionality reduction method and retain the majority of the variations present in the data set. The purposed face recognition system works with high accuracy and provides better success rates even for noisy face images, but the local features extraction methods is not work well using this proposed method. This issue is solved by Back Propagation Network (BPN) and Radial Basis Function Network (RBF) method which is proposed by M.Nandini, P.Bhargavi, G.Raja Sekhar [13], after studying this method we

analyse that, recognition accuracy achieved by this method is very high. This method can be suitably extended for moving images and the images with varying background. The scope of this work will be continue by using Evolutionary Optimization of Neural Networks method which is proposed by Stefan Wiegand, Christian Igel, Uwe Handmann [17] , This approach has recognized face from video streams which speed up the accuracy. Here they describe the optimization of such a network by a hybrid algorithm combining evolutionary computation and gradient-based learning. The problem of improving the generalization by cross-validation of both, learning and evolution, is an improvement over other methods and the problem of evolving good generalizing neural networks needs further investigation. This problem of generalization by cross validation is solved by Multilayer Perceptron (MLP) method which is proposed by Nidal f. Shilbayeh and gaith a. Al-qudah [18]. The proposed approach significantly improves the efficiency and the accuracy of detection in comparison with the traditional neural-network techniques. In order to reduce the total computation cost, we organize the neural network in a pre-stage that is able to reject a majority of non-face patterns in the image backgrounds, thereby significantly improving the overall detection efficiency while maintaining the detection accuracy. The scope for the system is to detect upright frontal faces in colour images with simple or complex background. This problem is not yet solve by researcher, Sachin Sudhakar Farfade, Mohammad Saberian, Li-Jia Li [4] has proposed deep convolution neural network method by studying this approach we analyzed performance of proposed face detector and found that there seems to be a correlation between distribution of positive examples in the training set and scores of the proposed detector. The scope of this approach is to use better sampling strategies and more sophisticated data augmentation techniques to further improve performance of the proposed method for detecting occluded and rotated faces. Some of the problems of this approach can be resolve by using rotational invariant neural Network method for face recognition system which is proposed by Henry A. Rowley, Shumeet Baluja, Takeo Kanade [15] which is used to recognise the unlike similar systems which are limited to detecting upright, frontal faces, this system detects faces at any degree of rotation in the image plane. The scope of this approach is to build a single router which recognizes all views of the face, and to speed up the system. This problem is not yet solve by researcher. Haoxiang Liy, Zhe Linz, Xiaohui Shenz, Jonathan Brandtz, Gang Hua [11] has proposed Convolutional Neural Network Cascade for Face Detection this method has build with very powerful discriminative capability, while maintaining high performance. The proposed CNN cascade operates at multiple resolutions, quickly rejects the background regions in the fast low resolution stages, and carefully evaluates a small number of challenging candidates in the last high resolution stage. The accuracy of face recognition is poor as compare to other methods. Aruni RoyChowdhury Tsung-Yu Lin Subhranshu Maji Erik Learned-Miller [12] has proposed Bilinear CNN method for face identification which has shown dramatic performance gains on certain fine-grained recognition problems it bridges the gap between the texture models and part-based CNN models. Sung-Hoon Yooa, Sung-Kwun Oha, Witold Pedrycz[10] has proposed a hybrid method of face recognition which uses radial basis function neural network method for face recognition. The proposed P-RBF NNs (Polynomial based RBF NNs) are applied to facial recognition and its performance is quantified from the viewpoint of the output performance and recognition rate. The scope for this approach can be attributed that the unnecessary parts of the image have been removed with the use of the ASM (Active Shape Model). This problem is solved by CNN method and the further improvement for this method is solve by Retinal Connected Neural Network (RCNN) method which is proposed by Henry A. Rowley, Student Member [14], this system is only detects upright faces looking at the camera. Separate versions of the system could be trained for each head orientation; Preliminary work in this area indicates that detecting profile views of faces is more difficult than detecting frontal views; the scope of this system is to improve

performance of system using more positive examples for training or applying more sophisticated image pre-processing and normalization techniques. Hazem M. El-Bakry has proposed fast Neural Network method for face detection [16]. A faster neural network approach has been introduced to identify frontal views of human faces. This approach reduces the computation time taken by fast neural nets for the searching process is presented. The proposed approach may be applied to detect the presence/absence of any other object in an image. Hossein Sahoozadeh, Davood Sarikhanimoghadam, and Hamid Dehghani [19] have proposed a new hybrid approaches using Gabor wavelet face using ANN for face recognition. Proposed Gabor wavelet faces combined with extended neural net feature space classifier shows very good performance. There are a number of directions for future work. The main limitation of the current system is that it only detects upright faces looking at the camera. Separate versions of the system could be trained for each head orientation, and the results could be combined using arbitration methods similar to those presented here but the limitation is that it detects only the limited views of the face image. This problem is solved by the Hybrid Wavelet Neural Network and Switching Particle Swarm Optimization algorithm which is proposed by YangLu, NianyinZeng , YurongLiu , NanZhang [20], a novel hybrid approach called Switching Particle Swarm Optimization Wavelet Neural Network(PSO-WNN) is presented. The application to the face direction recognition shows that the proposed WNN model can correctly and effectively recognize the face direction. Compared with other WNN models, the proposed method has a better performance, faster convergence rate, as well as better recognition ability than other WNN models. The scope of this approach is to investigate the issue of the face direction recognition where the more existing head pose image database and real-time acquisition of head pose images will be tested in order to verify the effectiveness of the proposed PSO-WNN model. Furthermore, the multi objective PSO algorithm combined with WNN will be investigated for multi objective parameter optimization problems. All this methods are discussed in literature survey section.

4. Artificial Neural Networks Approaches for Face Detection

In the recent years, different architectures and models of ANN were used for face detection and recognition. ANN can be used in face detection and recognition because these models can simulate the way neurons work in the human brain. This is the main reason for its role in face recognition. This research includes summery review of the researches related to face detection based on ANN.

4.1. PCA with Artificial Neural Networks

Navneet Jindal, Vikas Kumar [3] has proposed PCA with ANN method which recognizes features of the face images are extracted using PCA in this purposed methodology. PCA is dimensionality reduction method and retain the majority of the variations present in the data set. It capture the variations the dataset and use this information to encode the face images. It computes the feature vectors for different face points and forms a column matrix of these vectors. After calculating the feature vector it calculate the mean of the face then it will normalize the each input face image by subtracting from the mean face then computing the covariance matrix for it, and calculate the eigenvalues of the covariance matrix and keep only the largest eigenvalues, then computing the eigenvector for covariance matrix using that matrix eigenface are computed contacting highest information of the face image according to that it will compute the projected image. PCA method computes the maximum variations in data with converting it from high dimensional image space to low dimensional image space. These extracted projections of face images are further processed to Artificial Neural Networks for training and testing purposes. The features of the face images are extracted using PCA which extracts the variations in the features of face images which contains the

highest information with decomposed dimensions. Extracted features compute the eigenfaces which are taken as input to the Artificial Neural Networks to train the neural networks. For testing purpose, the eigenface of the tested image is provided as input to the trained neural networks and it finds the best match considering the threshold value for rejecting the non-human and unknown face images. Back Propagation feed forward Artificial Neural Network (ANN) is used for training the input face images. The computed eigenfaces of the input face images are fed to the neural networks. The number of neural networks taken based on the number of different input face images. As we analyze that author has taken the 9 networks for nine different face images. After setting the parameters neural networks are trained with eigenfaces of the input images via input layer, hidden layer and output layer. Each eigenface image distance is compared with each other. The eigenfaces images of same person have the zero distance between them and output is taken as 1 otherwise output taken as 0. The mathematical function values for each eigenface image are used to compare the eigenface images. In this work, the mathematical function Log-sigmoid is used for the eigenfaces of same person, the specific neural network provides the output as 1 and for the eigenfaces of other person it provides the output as 0. Now, only the known faces are recognized as output 1. Hence, Neural Network forms an Identity matrix for different face images using the outputs 1's and 0's. The errors in the output layer are sent back to the previous layers and update the weights of these layers which minimize the error. The momentum and learning rate parameters counts the updates from previous iterations and recalculates the new updated output. For face recognition, the eigenfaces images of the test face image is calculated by feature extraction based on PCA. This eigenface image is compare to the each trained neural network. The tested eigenface is compared with the eigenfaces of the trained neural network for best match using the Log-sigmoid function values. As the threshold value is set which is the best distance. If the minimum distance between the tested eigenface image and the trained input eigenface image is less than the threshold value, then the output of specific network is 1 and the trained eigenface image is selected from the Identity matrix as an output image and further recognized as a resulted face image otherwise the test face image is rejected as non-human or unknown face image. The purposed face recognition system works with high accuracy and provides better success rates even for noisy face images [3]. In future, we will apply the local features extraction methods with Artificial Neural Networks for further improvements in the research of Face Recognition System.

4.2. Deep Convolution Neural Networks

Sachin Sudhakar Farfade, Mohammad Saberian, Li-Jia Li [4] has proposed deep convolution neural network method for that they provide details of the algorithm and training process of their proposed face detector, called Deep Dense Face Detector (DDFD). The key ideas are average the high capacity of deep convolutional networks for classification and feature extraction to learn a single classifier for detecting faces from multiple views and minimize the computational complexity by simplifying the architecture of the detector. Author has started by fine-tuning AlexNet [5] for face detection. For this he has extracted training examples from the AFLW dataset [6]. To increase the number of positive examples, he randomly sampled sub-windows of the images and used them as positive examples if they had more than a 50% IOU (intersection over union) with the ground truth. These examples were then resized to 227×227 and used to fine-tune a pre-trained AlexNet model [5]. For fine-tuning, They used 50K iterations and batch size of 128 images, where each batch contained 32 positive and 96 negative examples. Using this fine-tuned deep network, it is possible to take either region-based or sliding window approaches to obtain the frontal face detector. In this work author has selected a sliding window approach because it has less complexity and is in-dependent of extra modules such as selective search [4]. This proposed method

(DDFD) is very simple; DDFD can achieve state-of-the-art performance for face detection. Detector analysis analyzes the scores of the DDFD detector and observes that there seems to be a correlation between those scores and the distribution of positive examples in the training set. It detects the all test face images from the database using DDFD detector on a variety of faces with different in-plane and out-of-plane rotations, occlusions and lighting conditions. First, in all cases his detector is able to detect the faces except for the two highly occluded ones, second for almost all of the detected faces; the detector's confidence score is slightly high, close to 1. In the heat-map, the scores are close to zero for all other regions. This shows that DDFD has very strong discriminative power, and its output can be used directly without any post-processing steps. Third, when author compare the detector scores for faces, it is clear that the up-right frontal face in the bottom has a very high score while faces with more in plane rotation have fewer score. And thus small changes in them reacts much larger changes in the output of the previous layer. It is interesting to see that the scores decrease as the in-plane rotation increases. Then the proposed face detector based on deep CNN is able to detect faces from different angles and handle occlusion to some extent. The network is more confident about up-right faces and better results can be achieved by using better sampling strategies and more sophisticated data augmentation techniques. After converting fully-connected layers to convolutional layers, it is possible to get the network response for the whole input image in one call to Caffe code. The heat-map shows the scores of the CNN for every 227×227 window with a stride of 32 pixels in the original image. He directly used this response for classifying a window as face or background. To detect faces of smaller or larger than 227×227 , for fine tuning, we scaled the image up or down respectively. Author tested his face detection approach on PASCAL Face [9], AFW [7] and FDDB [8] datasets. For selecting and tuning parameters of the proposed face detector we used the PASCAL Face dataset. Author started by finding the optimal number of scales for the proposed detector using PASCAL dataset. He upscale images by factor of 5 to detect faces as small, then down scaled the image with by a factor, f_s , and repeated the process until the minimum image dimension is less than 227 pixels. Decreasing f_s allows the detector to scan the image finer and increases the computational time and f_s have little impact on the performance of the detector. Smaller seem to have slightly better performance with a set of faces with different out-of-plane rotations and occlusions [4]. The proposed method does not require pose/landmark and notation and is able to detect faces in a wide range of orientations using a single model. In addition, DDFD is independent of common modules in recent deep learning object detection methods such as bounding-box regression, SVM, or image segmentation. He compared the proposed method with R-CNN and other face detection methods that are developed specifically for multi-view face detection. He analyze that his detector is able to achieve similar or better results even without using pose annotation or information about facial landmarks. Finally, author has analyzed performance of our proposed face detector on a variety of face images and found that there seems to be a correlation between distribution of positive examples in the training set and scores of the proposed detector. In future author are planning to use better sampling strategies and more sophisticated data augmentation techniques to further improve performance of the proposed method for detecting occluded and rotated faces.

4.3. Radial Basis Function Neural Networks

Sung-Hoon Yooa, Sung-Kwun Oha, Witold Pedrycz[7] has proposed a hybrid method of face recognition by using face region information extracted from the detected face region. In the preprocessing part, he has develop a hybrid approach based on the Active Shape Model (ASM) and the Principal Component Analysis (PCA) algorithm. At this step, author use a CCD (Charge Coupled Device) camera to acquire a facial image by using AdaBoost and then Histogram Equalization (HE) is employed to improve the quality of the image. ASM extracts the face contour and image shape to produce a

personal profile. Then he uses a PCA method to reduce dimensionality of face images. In the recognition part, he has considered the improved Radial Basis Function Neural Networks (RBF NNs) to identify a unique pattern associated with each person. The proposed RBF NN architecture consists of three functional modules realizing the condition phase, the conclusion phase, and the inference phase completed with the help of fuzzy rules coming in the standard 'if-then' format. In the formation of the condition part of the fuzzy rules, the input space is partitioned with the use of Fuzzy C-Means (FCM) clustering. In the conclusion part of the fuzzy rules, the connections (weights) of the RBF NNs are represented by four kinds of polynomials such as constant, linear, quadratic, and reduced quadratic. The values of the coefficients are determined by running a gradient descent method. The output of the RBF NNs model is obtained by running a fuzzy inference method. The essential design parameters of the network (including learning rate, momentum coefficient and fuzzification coefficient used by the FCM) are optimized by means of Differential Evolution (DE). The proposed P-RBF NNs (Polynomial based RBF NNs) are applied to facial recognition and its performance is quantified from the viewpoint of the output performance and recognition rate. This improvement can be attributed to the fact that the unnecessary parts of the image have been removed with the use of the ASM [7].

4.4. Convolutional Neural Network Cascade

Haoxiang Liy, Zhe Linz, Xiaohui Shenz, Jonathan Brandtz, Gang Hua [8] has proposed Convolutional Neural Network Cascade for Face Detection this method has build with very powerful discriminative capability, while maintaining high performance. The proposed CNN cascade operates at multiple resolutions, quickly rejects the background regions in the fast low resolution stages, and carefully evaluates a small number of challenging candidates in the last high resolution stage. To improve localization effectiveness, and reduce the number of candidates at later stages, author has introduced a CNN-based calibration stage after each of the detection stages in the cascade. The motivation of applying the calibration is the most confident detection window may not be well aligned to the face. As the result has generated, without the calibration step, the next CNN in the cascade will have to evaluate more regions to maintain a good result. The overall detection has to increases the result at run time. This problem generally exists in object detection. He has analysed this problem with CNNs in this work. Instead of training a CNN for bounding boxes regression as in R-CNN, he trained a multi-class classification CNN for calibration. He observed that a multi-class calibration CNN can be easily trained from limited amount of training data while a regression CNN for calibration requires more training data. He observed that the discretization decreases the difficulty of the calibration problem so that he can achieve good calibration accuracy with simpler CNN structures, after calibration the detection bounding box is better aligned to the real face centre. As the result has generated, the calibration nets enable more accurate face localization using coarser scanning windows across fewer scales. The output of each calibration stage is used to adjust the detection window position for input to the subsequent stage. The proposed method runs at 14 FPS on a single CPU core for VGA-resolution images and 100 FPS using a GPU, and achieves state-of-the-art detection performance on two public face detection benchmarks [8].

4.5. Bilinear CNNs

Aruni RoyChowdhury Tsung-Yu Lin Subhranshu Maji Erik Learned-Miller [9] has proposed Bilinear CNN method for face identification which has shown dramatic performance gains on certain fine-grained recognition problems it bridges the gap between the texture models and part-based CNN models. It consists of two CNNs whose convolutional-layer outputs are multiplied using outer product at each location of the

image. The resulting bilinear feature is placed across the image resulting in an order less descriptor for the entire image. This vector can be normalized to provide additional invariance. If one of the feature extractors was a part detector and the other computed local features, the resulting bilinear vector can model the representations of a part-based model. On the other hand, the bilinear vector also resembles the computations of a Fisher vector, where the local features are combined with the soft membership to a set of cluster centres using an outer product. The resulting architecture is a directed acyclic graph (DAG), both the networks can be trained simultaneously by back-propagating the gradients of a task-specific loss function. This allows us to initialize generic networks on Image Net and then fine-tune them on face images. Instead of having to train a CNN for face recognition from scratch, which would require both a search for an optimal architecture and a massive annotated database, he can use pre-trained networks and adapt them to the task of face recognition. When using the symmetric B-CNN both the networks is identical, he has to think that bilinear layer being similar to the quadratic polynomial kernel often used with Support Vector Machines (SVMs). However, unlike a polynomial-kernel SVM, this bilinear feature is placed over all locations in the image. He has applied this new CNN to the challenging new face recognition benchmark. He has demonstrated the performance of the B-CNN model beginning from an AlexNet-style network pre-trained on ImageNet, FaceScrub. He also present results with additional fine-tuning on the limited training data provided by the protocol. In each case, the fine-tuned bilinear model shows substantial improvements over the standard CNN [9].

4.6. Back Propagation Network (BPN) and Radial Basis Function Network (RBF)

M.Nandini, P.Bhargavi, G.Raja Sekhar [10] has proposed back propagation and radial Basis Function network for face recognition. This method proposes a novel approach for recognizing the human faces. The recognition is done by comparing the characteristics of the new face to that of known faces. It has Face localization part, where mouth end point and eyeballs will be obtained. In feature Extraction, Distance between eyeballs and mouth end point will be calculated. The recognition is performed by Neural Network (NN) using Back Propagation Networks (BPN) and Radial Basis Function (RBF) networks. Back propagation can train multilayer feed-forward networks with differentiable transfer functions to perform function approximation, pattern association, and pattern classification. The BPN is designed with one input layer, one hidden layer and one output layer. The input layer consists of six neurons the inputs to this network are feature vectors derived from the feature extraction method in the previous section. The network is trained using the right mouth end point samples. The Back propagation training takes place in three stages: Feed forward of input training pattern, back propagation of the associated error and Weight adjustment. During feed forward, each input neuron receives an input value and broadcasts it to each hidden neuron, which in turn computes the activation and passes it on to each output unit, which again computes the activation to obtain the net output. During training, the net output is compared with the target value and the appropriate error is calculated. From this, the error factor has been calculated which is used to distribute the error back to the hidden layer. The weights are updated accordingly. In a similar manner, the error factor is calculated for a single unit. After the error factors are obtained, the weights are updated simultaneously. The output layer contains one neuron. The result obtained from the output layer is given as the input to the RBF. RBF uses the gaussian function for approximation. For approximating the output of BPN, it is connected with RBF. The Radial Basis Function neural network is found to be very attractive for the engineering problems. They have a very compact topology, universal approximations; their learning speed is very fast because of their locally tuned neurons. The RBF neural network has a feed forward architecture with an input layer, a hidden layer and an output layer. A RBF neural network is used as recognizer in face recognition system and the inputs to this network are the results obtained from the BPN. This neural

network model combined with BPN and RBF networks is developed and the network is trained and tested. From these results, it can be concluded that, recognition accuracy achieved by this method is very high. This method can be suitably extended for moving images and the images with varying background [10].

4.7. Retinal Connected Neural Network (RCNN)

Henry A. Rowley, Student Member [11] has proposed, a retinally connected neural network examines small windows of an image and decides whether each window contains a face. The first component of our system is a filter that receives as input a 20×20 pixel region of the image and generates an output ranging from 1 to -1, signifying the presence or absence of a face, respectively. To detect faces anywhere in the input, the filter is applied at every location in the image. To detect faces larger than the window size, the input image is repeatedly reduced in size by using sub sampling, and the filter is applied at each size. This filter must have some invariance to position and scale. The amount of invariance determines the number of scales and positions at which it must be applied. For the work presented here, he has applied the filter at every pixel position in the image and scale the image down by a factor of 1.2 for each step in the pyramid. The system arbitrates between many networks to improve performance over one network. They used a bootstrap algorithm as training progresses for training networks to add false detections into the training set. This eliminates the difficult task of manually selecting non-face training examples, which must be chosen to span the entire space of non-face images. First, a pre-processing step, adapted from [28], is applied to a window of the image. The window is then passed through a neural network, which decides whether the window contains a face. They used three training sets of images. Test SetA collected at CMU: consists of 42 scanned photographs, newspaper pictures, images collected from WWW, and TV pictures. Test SetB consists of 23 images containing 155 faces. Test SetC is similar to Test SetA, but contains images with more complex backgrounds and without any faces to measure the false detection rate: contains 65 images, 183 faces, and 51,368,003 windows. The detection ratio of this approach equal of faces over two large test sets and small number of false positives. The system arbitrates between multiple networks to improve performance over a single network. He presented a straightforward procedure for aligning positive face examples for training. To collect negative examples, he uses a bootstrap algorithm, which adds false detections into the training set as training progresses. This eliminates the difficult task of manually selecting nonface training examples, which must be chosen to span the entire space of nonface images. Simple heuristics, such as using the fact that faces rarely overlap in images, can further improve the accuracy. Comparisons with several other state-of-the-art face detection systems are presented, showing that proposed system has comparable performance in terms of detection and false-positive rates. The main limitation of the current system is that it only detects upright faces looking at the camera. Separate versions of the system could be trained for each head orientation, and the results could be combined using arbitration methods similar to those presented here. Preliminary work in this area indicates that detecting profile views of faces is more difficult than detecting frontal views, because they have fewer stable features and because the input window will contain more background pixels. He has also applied the same algorithm for the detection of car tires and human eyes also needed more work for the face detection. Even within the domain of detecting frontal views of faces, also remains more work. When an image sequence is available, temporal coherence can focus attention on particular portions of the images. As a face moves about, its location in one frame is a strong predictor of its location in the next frame. Standard tracking methods, as well as expectation- based methods [2], can be applied to focus the detector's attention. Other methods of improving system performance include obtaining more positive examples for training or applying more sophisticated image pre-processing and normalization techniques [11].

4.8 Rotation Invariant Neural Network (RINN)

Henry A. Rowley, Shumeet Baluja, Takeo Kanade [12] has proposed rotational invariant neural Network method for face recognition system which is used to recognise the unlike similar systems which are limited to detecting upright, frontal faces, this system detects faces at any degree of rotation in the image plane. The system employs multiple networks; a “router” network first processes each input window to determine its orientation and then uses this information to prepare the window for one or more “detector” networks. He presents the training methods for both types of networks. Proposed system directly analyses image intensities using neural networks, whose parameters are learned automatically from training examples. There are many ways to use neural networks for rotated-face detection. The simplest would be to employ one of the existing frontal, upright, face detection systems. Systems such as [12] use a neural network based filter that receives as input a small window of the image, and generates an output signifying the presence or absence of a face. To detect faces anywhere in the image, the filter is applied at every location in the image. To detect faces larger than the window size, the input image is repeatedly subsample to reduce its size, and the filter is applied at each scale. To extend this framework to capture rotated faces, the entire image can be repeatedly rotated by small increments and the detector can be applied to each rotated image. However, this would be an extremely computationally expensive procedure. Therefore, the entire detection procedure would need to be applied at least 18 times to each image, with the image rotated in increments of 20° . He also performed sensitivity analysis on the networks, and present empirical results on a large test set. The system described above to be accurate, the router and detector must perform robustly and compatibly. Because the output of the router network is used to derogate the input for the detector, the angular accuracy of the router must be compatible with the angular invariance of the detector. To measure the accuracy of the router, he has generated test example images based on the training images, with angles between -30° and 30° at 1° increments. These images were given to the router. He has investigating the use of the above scheme to handle out-of-plane rotations. There are two ways in which this could be approached. The first is directly analogous to handling in-plane rotations: using knowledge of the shape and symmetry of the face, it may be possible to convert a profile or semi-profile view of a face to a frontal view. A second approach, and the one he has explored, is to partition the views of the face, and to train separate detector networks for each view. He has chosen five views: left profile, left semi-profile, frontal, right semi profile, and right profile. The router is responsible for directing the input window to one of these view detectors. As can be seen, there are still a significant number of false detections and missed faces. He suspects that one reason for this is that our training data is not representative of the variations present in real images. Most of our profile training images are taken from the FERET database, which has very uniform lighting conditions. Finally, He has come up with preliminary results for detecting faces rotated out of the image plane, such as profiles and semi-profiles. There are two possible improvements for future work. First, it would be interesting to merge the systems for in plane and out-of-plane rotations. One approach is to build a single router which recognizes all views of the face, then rotates the image in-plane to a canonical orientation, and presents the image to the appropriate view detector network. The second area for future work is improvement to the speed of the system. Based on the work of presented a quick algorithm based on the use of a fast but somewhat inaccurate candidate detector network, whose results could then be checked by the detector networks. A similar technique may be applicable to the present work [12].

4.9 Fast Neural Network

Hazem M. El-Bakry has proposed fast Neural Network method for face detection [13]. A faster neural network approach has been introduced to identify frontal views of human faces. Such approach has decomposed the image under test into many small in size sub-images. This approach reduces the computation time taken by fast neural nets for the searching process is presented. The principle of divide and conquer strategy is applied through image decomposition. Each image is divided into small in size sub-images and then each one is tested separately using a fast neural network. Compared to conventional and fast neural networks, experimental results show that a speed up ratio is achieved when applying this technique to locate human faces in automatically in cluttered scenes. A simple algorithm for fast face detection based on cross correlations in frequency domain between the sub-images and the weights of the neural net is presented in order to speed up the execution time. Moreover, simulation results have shown that, using a parallel processing technique, each sub-image is tested using a fast neural network simulated on a single processor or a separated node in a clustered system. Large values of speed up ratio may be achieved. Furthermore, the problem of sub-image centering and normalization in the Fourier space has been solved. The proposed approach may be applied to detect the presence/absence of any other object in an image [13].

4.10 Evolutionary Optimization of Neural Networks

Stefan Wiegand, Christian Igel, Uwe Handmann [14] has proposed evolutionary optimization of Neural Network approach for detecting face. This approach has recognized face from video streams which speed up the accuracy. Here they describe the optimization of such a network by a hybrid algorithm combining evolutionary computation and gradient-based learning. In the efficient and hardware-friendly implementation of the face detection neural network within Viisage-FaceFINDER the speed of the classification scales approximately linearly with the number of hidden neurons and not with the number of connections. With every hidden neuron that is saved detection costs are reduced by approximately one percentage point. Hence, the goal of the optimization is to reduce the number of hidden nodes of the detection network under the constraint that the classification error does not increase. He has decided to increase the number of connections as long the number of neurons decreases. Author has initialized his optimization algorithm and compares our results with the expert designed architecture of the reference topology. This network has been implemented to the face detection task and has become a standard reference for neural network based face detection. Evolutionary algorithms are an established method for the optimization of the topology of neural networks. Its basic concept might be used as a canonical evolutionary network optimization method using direct encoding, nested learning, and Lamarckian inheritance. However, there are some special features described in the following. He has initialized the parent population with 25 individuals that all represent the reference topology. The number of input corresponds to the pixel of the image pattern which is right and left. No hidden neuron is fully connected to the input but to certain receptive fields then the total number of connections portioned into 4 sets train, Val, test, and extern, each parent creates one child per generation by reproduction. The off springs are changed by elemental variation operators. These are chosen randomly for each offspring from a set of operators and are applied sequentially. The process of choosing and applying an operator is repeated n times where n are an individual realization of a Poisson distributed random number with mean 1. A key concept in evolutionary computation is strategy adaptation, *i.e.*, the automatic adjustment of the search strategy during the optimization process. Not all operators might be necessary at all stages of evolution and questions such as when fine-tuning becomes more important than operating on receptive fields. Hence, the application probabilities of the 8 variation operators are adapted using the method

described in, which is based on the heuristic that recent beneficial modifications are likely to be also beneficial in the following generations. The proposed hybrid evolutionary algorithm successfully tackles the problem of reducing the number of hidden neurons of the face detection network without loss of detection accuracy. The speed of classification whether an image region corresponds to a face or not could be improved by approximately. By speeding up classification, the rate of complete scans of video-stream images can be increased leading to a more accurate recognition and tracking of persons. Note that almost all of the networks in right have more weights than the initial one, but fewer hidden nodes. Such solutions cannot be found by a pure pruning algorithm. The suggested algorithm can be adapted to the automatic construction of neural networks for any classification task. Even if the classification error on a fixed additional data set that is not considered for adapting the weights neither for training nor for early stopping is additionally or solely used in the strong calculation, the evolved networks would tend to over fit to the data that are responsible for their selection. Therefore he has introduced additional data sets to reliably measure generalization performance. His way of improving the generalization by cross-validation of both, learning and evolution, is an improvement over other methods. Nighter the problem of evolving good generalizing neural networks needs further investigation. Although the results are satisfying, one can think of further enhancements of the described algorithm. It took some time to find a suitable balance in between the competing objectives of reducing the number of hidden neurons and reducing the classification error [14].

4.11 Multilayer Perceptron (MLP)

Boughrara, H., Chtourou, M., Amar [15], has propose a face detector using an efficient architecture based on a Multi-Layer Perceptron (MLP) neural network and Maximal Rejection Classifier (MRC). The proposed approach significantly improves the efficiency and the accuracy of detection in comparison with the traditional neural-network techniques. In order to reduce the total computation cost, we organize the neural network in a pre-stage that is able to reject a majority of non-face patterns in the image backgrounds, thereby significantly improving the overall detection efficiency while maintaining the detection accuracy. An important advantage of the new architecture is that it has a homogeneous structure so that it is suitable for very efficient implementation using programmable devices. Comparisons with other state-of-the-art face detection systems are presented. A new classifier for face detection based on MRC and MLP. The proposed approach significantly improves the detection rate in comparison with the standard MLP neural network systems. Our Algorithm can detect between 79% and 92% of faces from images of varying size, background and quality with an acceptable number of false detections. A threshold of between 0.5-0.6 gives the best range of results out of the threshold set tested. The new system was designed to detect upright frontal faces in colour images with simple or complex background. There is no required a priori knowledge of the number of faces or the size of the faces to be able to detect the faces in a given image. The system has acceptable results regarding the detection rate, false positives and average time needed to detect a face. Our proposed approach achieves one of the best detection accuracies with significantly reduced training and detection cost [15].

4.12 Gabor Wavelet Faces with ANN

Hossein Sahoolzadeh, Davood Sarikhanimoghadam, and Hamid Dehghani [16] have proposed a new hybrid approaches for face recognition. Gabor wavelets representation of face images is an effective approach for both facial action recognition and face identification. Perform dimensionality reduction and linear discriminate analysis on the down sampled. Gabor wavelet faces can increase the discriminate ability. Nearest feature space is extended to various similarity measures. In this experiment, proposed Gabor

wavelet faces combined with extended neural net feature space classifier shows very good performance. Gabor wavelets are widely used in image analysis and computer vision. The Gabor wavelets transform provides an effective way to analyze images and has been elaborated as a frame for understanding the orientation and spatial frequency selective properties of simple cortical neurons. They seem to be a good approximation to the sensitivity profiles of neurons found in visual cortex of higher vertebrates. The important advantages are infinite smoothness and exponential decay in frequency. In comparison with other methods, all Gabor wavelet faces based method is better than the base-line method. Down sampled Gabor wavelets transform of face images as features for face recognition in subspace approach is superior to pixel value. In this experiment, proposed Gabor wavelet faces combined with extended neural net feature space classifier shows very good performance. There are a number of directions for future work. The main limitation of the current system is that it only detects upright faces looking at the camera. Separate versions of the system could be trained for each head orientation, and the results could be combined using arbitration methods similar to those presented here. Preliminary work in this area indicates that detecting profiles views of faces is more difficult than detecting frontal views, because they have fewer stable features and because the input window will contain more background pixels. He has applied the same algorithm for the detection of car tires and human eyes, although more work is needed. Even within the domain of detecting frontal views of faces, there are more work remains. When an image sequence is available, temporal coherence can focus attention on particular portions of the images. As a face moves about, its location in one frame is a strong predictor of its location in next frame. Other methods of improving system performance include obtaining more positive examples for training, or applying more sophisticated image preprocessing and normalization techniques. One application of this work is in the area of media technology. Improved technology provides cheaper and more efficient ways of storing and retrieving visual information. However, automatic high-level classification of the information content is very limited; this is a bottleneck that prevents media technology from reaching its full potential [16].

4.13 Hybrid Wavelet Neural Network and Switching Particle Swarm Optimization Algorithm

YangLu , NianyinZeng , YurongLiu , NanZhang[17], has proposed a novel hybrid approach called Switching Particle Swarm Optimization Wavelet Neural Network (SPSO–WNN) is presented. In this model, he employs the recently proposed Switching Particle Swarm Optimization (SPSO) algorithm to optimize the parameters of weights, scale factors, translation factors and threshold in Wavelet Neural Network (WNN). The proposed SPSO–WNN method has fast convergences peed and higher learning ability than conventional WNNs. Especially, a mode dependent velocity updating equation with Markovian switching parameters is introduced in SPSO to overcome the contradiction between the local search and the global search, which makes it easy to jump the local minimum. The experiment result shows the recognition for face directions how the feasibility and effectiveness of the proposed method. Compared with Particle Swarm Optimization Wavelet Neural Network (PSO–WNN), Genetic Algorithm Wavelet Neural Network (GA–WNN) and WNN, the proposed method has much better performance over them. The advantages of the WNN model are that all parameters are optimized by the SPSO algorithm. The application to the face direction recognition shows that the proposed WNN model can correctly and effectively recognize the face direction. Compared with other WNN models, the proposed method has a better raining performance, faster convergence rate, as well as better recognition ability than other WNN models. In near future, we will try to investigate the issue of the face direction recognition where the more existing head pose image database and real-time acquisition of head pose images will be tested in order to verify the effectiveness of the proposed SPSO–WNN model.

Furthermore, the multi objective SPSO algorithm combined with WNN will be investigated for multi objective parameter optimization problems [17].

The literature studies discussed have its own advantages and limitations which have solved by many researchers, but there are still some other issues in face recognition like computational time and efficiency of recognizing the faces from large databases. Also, to overcome the problem of uncontrolled environmental problem, face direction recognition where the more existing head pose image database and real-time acquisition of head pose images will be tested in order to verify the effectiveness of the face recognition, multi objective parameter optimization problems, and face recognition with real time data with better accuracy.

Table 1. Comparison of Neural Network Methods

Sr. No.	Methodology	Recognition Rate
1	PCA with ANN Face recognition system	95.45%
2	DDFD	91.79%
3	RBNNs	97.56%
4	CNN	85.1%
5	B-CNN	95.3%
6	BPN+RBF	98.88%
7	RCNN	90.3%
8	RINN	90.6%
9	MRC & MLP Neural Network	91.6%
10	Gabor Wavelet Faces with ANN	93%
11	WNN	89.22%

The table1. Describes the comparative study of different ANN methods accuracy with the help of different databases, here we analyze that the some methods are achieves better recognition accuracy but the still there is some limitation of face recognition.

5. Conclusion

This paper includes a summary review of literature studies related to face recognition systems based on ANNs. In this paper we are discussed different architecture, approach, algorithms, methods, database for training or testing images and performance measure of face recognition system were used in each study. Every researcher has their own approach for recognizing face from database or from video many researches has try to solve the problems associated with earlier proposed method but still there are some advantages and limitations in these discussed methods.

6. Future Work

In future work, a face recognition system will be based on the real data with hybrid Wavelet and ANN approach with many hidden layers. Different network architectures and parameters' values of BPNN will be used to determine the result in best performance values of face detection system and, we will try to use genetic algorithm (GA) as an optimization algorithm to obtain the best values of ANN algorithm parameters that result to optimal results or we will try to solve the same problem using Neuro fuzzy system, Neuro-fuzzy system incorporates the human-like reasoning style of fuzzy systems through the use of fuzzy sets and a linguistic model consisting of a set of IF-THEN fuzzy rules. The strength of Neuro-fuzzy systems involves two contradictory requirements in fuzzy modeling: interpretability versus accuracy.

References

- [1] A Krenker, J Bešter and A Kos, "Introduction to the Artificial Neural Networks", Edited Kenji Suzuki, Published by InTech, Janeza Trdine, Croatia, (2011), pp 3-18.
- [2] Er. P Kumar, Er.P Sharma, "ARTIFICIAL NEURAL NETWORKS- A Study", International Journal of Emerging Engineering Research and Technology, vol. 2, no. 2, (2014), pp. 143-148.
- [3] N Jindal, V Kumar, "Enhanced Face Recognition Algorithm using PCA with Artificial Neural Networks", International Journal of Advanced Research in Computer Science and Software Engineering, vol 3, no. 6, (2013), pp. 864-872.
- [4] S Sudhakar Farfade, M Saberian, L-J Li, "Multi-view Face Detection Using Deep Convolutional Neural Networks", International Conference on Multimedia Retrieval, Shanghai, China, (2015).
- [5] A. Krizhevsky, I. Sutskever, and G. E. Hinton, "Image net classification with deep convolutional neural networks", Edited F. Pereira and C.J.C. Burges and L. Bottou and K.Q. Weinberger, publish by Curran Associates, Inc. , (2012), pp. 1097-1105.
- [6] P. M. R. Martin Koestinger, P Wohlhart and H. Bischof, "Annotated facial landmarks in the wild: A large-scale, real-world database for facial landmark localization", IEEE International Workshop on Computer vision workshops, Barcelona, (2011), pp. 2144 – 2151.
- [7] S-H Yooa, S-K Oha, Witold Pedrycz, "Optimized face recognition algorithm using radial basis function neural networks and its practical applications", International journal on Neural Networks, volume 69, (2015), pp. 111-125.
- [8] H Liy, Z Linz, X Shenz, J Brandtz, GHua, "A Convolutional Neural Network Cascade for Face Detection", IEEE Conference on Computer Vision and Pattern Recognition, Boston, MA, (2015), pp. 5325 – 5334.
- [9] A Roy Chowdhury Tsung-Yu Lin Subhranshu Maji Erik Learned-Miller, "Face Identification with Bilinear CNNs", Computer vision and pattern recognition, (2015).
- [10] M.Nandini, P.Bhargavi, G.Raja Sekhar, "Face Recognition Using Neural Network", International Journal of Scientific and Research Publications, vol. 3, no. 3, (2013), pp. 1-5.
- [11] H A. Rowley, Student Member, "Neural Network-Based Face Detection", IEEE Computer Society Conference on Computer Vision and Pattern Recognition, San Francisco, CA , (1996), pp. 203 – 208.
- [12] H A. Rowley, S Baluja, T Kanade, "Rotation Invariant Neural Network-Based Face Detection", IEEE Computer Society Conference on Computer Vision and Pattern Recognition, Santa Barbara, CA, (1998), pp. 38 – 44.
- [13] H M. El-Bakry, "Fast Face Detection Using Neural Networks and Image Decomposition", International Computer Science Conference, Hong Kong, China, (2001), pp. 205-215
- [14] S Wiegand, C Igel, U Handmann, "Evolutionary Optimization of Neural Networks for Face Detection", European Symposium on Artificial Neural Networks Bruges, (2004), pp. 139-144.
- [15] H., Boughrara, M Chtourou,., C.B., Amar, "MLP neural network based face recognition system using constructive training algorithm" International conference on Multimedia computing and system, Tangier, (2012), pp. 233 – 238.
- [16] H Sahoozadeh, D Sarikhanimoghadam, and HDehghani, "Face recognition system using neural network with Gabor and discrete wavelet transform parameterization", International Conference of Soft Computing and Pattern Recognition, Tunis, (2014), pp. 17 – 24.
- [17] Y Lu , N Zeng , Y Liu , NZhang, "A hybrid Wavelet Neural Network and Switching Particle Swarm Optimization algorithm for face direction recognition", International Journal on Neurocomputing, Volume 155, (2015), pp. 219–224.

Authors



Manisha M. Kasar, She received the M.Tech degree in Computer Engineering from MPSTME, NMIMS Shirpur Campus, District, Dhule in 2014. Now perusing Ph.D degree in Information Technology in Bharti Vidyapeeth University, Pune, Her research interests are image processing, neural network, pattern recognition and Biometrics.



Debnath Bhattacharyya, He received the Ph.D. (Tech.) in Computer Science and Engineering from University of Calcutta. Currently, associated as Professor, Information Technology Department, Bharti Vidyapeeth University College of Engineering, Pune, India. His research interests include image processing, pattern

recognition, and data hiding. He published 170 Research papers in International Journals and Conferences and published 6 text books for Computer Science and Engineering.



Tai-hoon Kim, He received the B.E., and M.E., degrees from Sungkyunkwan University in Korea and and Ph.D. degrees from University of Bristol in UK and University of Tasmania in Australia. Now he is working for Department of Convergence Security, Sungshin W. University, Korea. His main research areas are security engineering for IT products, IT systems, development processes, and operational environments. He published 300 Research papers in International Journals and Conferences and published more than 10 text books for Computer Science and Engineering.