

Fault and Event Tree Analyses for Process Systems Risk Analysis: Uncertainty Handling Formulations

Refaul Ferdous,¹ Faisal Khan,^{1,*} Rehan Sadiq,² Paul Amyotte,³ and Brian Veitch¹

Quantitative risk analysis (QRA) is a systematic approach for evaluating *likelihood*, consequences, and risk of adverse events. QRA based on event (ETA) and fault tree analyses (FTA) employs two basic assumptions. The first assumption is related to *likelihood* values of input events, and the second assumption is regarding interdependence among the events (for ETA) or basic events (for FTA). Traditionally, FTA and ETA both use crisp probabilities; however, to deal with uncertainties, the probability distributions of input event *likelihoods* are assumed. These probability distributions are often hard to come by and even if available, they are subject to incompleteness (partial ignorance) and imprecision. Furthermore, both FTA and ETA assume that events (or basic events) are independent. In practice, these two assumptions are often unrealistic. This article focuses on handling uncertainty in a QRA framework of a process system. Fuzzy set theory and evidence theory are used to describe the uncertainties in the input event *likelihoods*. A method based on a dependency coefficient is used to express interdependencies of events (or basic events) in ETA and FTA. To demonstrate the approach, two case studies are discussed.

KEY WORDS: Event tree analysis (ETA); fault tree analysis (FTA); interdependence; *likelihoods*; quantitative risk analysis (QRA); uncertainty

SYMBOLS

$m(p_i)/m(c_i)$ Belief mass
 m_{1-n} 1 to n numbers of experts' knowledge
 n Number of events/basic events
 Subscript (L) Minimum (left) value of a TFN
 Subscript (m) Most likely value of a TFN
 Subscript (U) Maximum (right) value of a TFN

C_d Dependency coefficient
 N Number of samples
 P_i Probability of events ($i = 1, 2, \dots, n$)
 \tilde{P}_i Fuzzy probability
 λ_i Frequency
 \tilde{P}_α TFN with a α -cut
 P_{OR} "OR" gate operation
 P_{AND} "AND" gate operation
 μ Membership function
 α Membership function at a specific level
 Ω Frame of discernment (FOD)
 Φ Null set
 \cap Symbol for intersection
 \subseteq Symbol for subsets
 Bel, Pl Belief, plausibility
 bpa Basic probability assignment

¹Faculty of Engineering and Applied Science, Memorial University, St. John's, NL, Canada.

²Okanagan School of Engineering, University of British Columbia, Kelowna, BC, Canada.

³Department of Process Engineering and Applied Science, Dalhousie University, Halifax, NS, Canada.

*Address correspondence to Faisal Khan, Faculty of Engineering & Applied Science, Memorial University, St. John's, NL, Canada A1B 3X5; tel: 709 737 8939; fax: 709 737 4042; fikhan@mun.ca.

ABBREVIATIONS

E	Events
H	High
I	Independent
P	Perfectly dependent
L	Low
BE	Basic events
MH	Moderately high
ML	Moderately low
RH	Rather high
S	Strong
VH	Very high
VL	Very low
VS	Very strong
VW	Very weak
DS	Dempster & Shafer
W	Weak
T, F	True/false probability
ETA	Event tree analysis
FTA	Fault tree analysis
PDF	Probability density function
MCS	Monte Carlo simulation
TFN	Triangular fuzzy number

1. INTRODUCTION

Process systems in chemical engineering are infamous for fugitive emissions, toxic releases, fire and explosions, and operation disruptions. These incidents have considerable potential to cause an accident and incur environmental and property damage, economic loss, sickness, injury, or death of workers in the vicinity. Quantitative risk analysis (QRA) is a systematic approach that integrates quantitative information about an incident and provides detailed analysis that helps to minimize the *likelihood* of occurrence and reduces its adverse consequences. QRA for process systems is a difficult task as the failures of components and the consequences of an incident are randomly varied from process to process. Furthermore, for a process system comprising thousands of components and steps, it is difficult to acquire the quantitative information for all components.⁽¹⁾ Finally, the interdependencies of various components are not known and are generally assumed to be independent for the purpose of simplicity.

Event tree analysis (ETA) and fault tree analysis (FTA) are two distinct methods for QRA that develop a logical relationship among the events leading to an accident and estimate the risk associated with the accident. The term “event” is frequently used in

place of the term “accident” in the analyses of fault trees and event trees for QRA.⁽²⁾ ETA is a technique used to describe the consequences of an event (initiating event) and estimate the likelihoods (frequency) of possible outcomes of the event. FTA represents basic causes of occurrence of an unwanted event and estimates the likelihood (probability) as well as the contribution of different causes leading to the unwanted event. In FTA, the basic causes are termed basic events, and the unwanted event is called the top event.^(3–6) Kumamoto and Henley⁽⁷⁾ provide a detailed description of fault tree development and analysis for a process system.

In the event tree, the unwanted event is named as an initiating event, and the follow-up consequences are termed as events or safety barriers.⁽⁸⁾ The ETA represents the dichotomous conditions (e.g., success/failure, true/false, or yes/no) of the initiating event until the subsequent events lead to the final outcome events.^(8–10) AIChE⁽⁸⁾ and Lees⁽¹¹⁾ provide a detailed procedure for constructing and analyzing the ETA for a process system.

Event and fault trees help to conduct the QRA for process systems based on two major assumptions.⁽²⁾ First, the *likelihood* of events or basic events is assumed to be exact and precisely known, which is not very often true due to inherent uncertainties in data collection and defining the relationships of events or basic events.^(10,12) Moreover, because of variant failure modes, design faults, and poor understanding of failure mechanisms, as well as the vagueness of system phenomena, it is often difficult to predict the acquired probability of basic events/events precisely.⁽¹³⁾ Second, the interdependencies of events or basic events in an event tree or fault tree are assumed to be independent, which is often an inaccurate assumption.⁽¹⁴⁾ These two assumptions indeed misrepresent the actual process system behaviors and impart two different types of the uncertainty, namely, *data uncertainty* and *dependency uncertainty*, while performing the QRA using FTA and ETA. In an attempt to circumvent the *data uncertainty* in risk analysis, a number of research works^(1,10,13,15–23) have been developed to facilitate the accommodation of expert judgment/knowledge in quantification of the *likelihood* of the basic events/events for QRA. Sadiq *et al.*,⁽¹²⁾ Ferson *et al.*,⁽¹⁴⁾ and Li⁽²⁴⁾ proposed methods to describe the *dependency uncertainty* among the basic events/events.

Fuzzy-based and evidence-theory-based formulations have been proposed and developed to address data and dependency uncertainties in FTA and

ETA. The interdependencies among the events (or basic events) are described by incorporating a dependency coefficient into the fuzzy- and evidence-theory-based formulations for FTA/ETA. Expert judgment/knowledge can be used to quantify the unknown or partially known likelihood and dependency coefficient of the events (or basic events).

2. FTA AND ETA IN PROCESS SYSTEMS

The traditional fault and event trees can be analyzed either deterministically or probabilistically. The deterministic approach uses the crisp probability of events (or basic events) and determines the probability of the top event and the frequency of outcome events in the fault and event trees, respectively. The probabilistic approach treats the crisp probability as a random variable and describes uncertainty using probability density functions (PDF).^(10,20,23) Traditionally, the probabilistic approach uses Monte Carlo simulation (MCS) to address the random uncertainty in the inputs (i.e., probability of basic events or events) and propagate the uncertainty for the outputs.⁽²⁵⁾ The PDFs for the inputs can be derived from historical information, but are often rare, especially when the process system comprises thousands of components.⁽¹⁸⁾

With an assumption that the events (or basic events) are independent, deterministic and probabilistic approaches use the equations in Table I to analyze the fault and event trees. P_i denotes the probability of i th ($i = 1, 2, 3, \dots, n$) events (or basic events), P_{OR} and P_{AND} , respectively, denote the “OR” and “AND” gate operations, and λ_i denotes the frequency for the initiating event and the outcome events.

Two examples—an event tree for “LPG release” (Fig. 1) and a fault tree for “runaway reaction” (Fig. 2)—are considered to illustrate the use of deter-

ministic and probabilistic approaches in QRA for the process system. The event and fault trees for these two examples were earlier studied, respectively, in Lees⁽¹¹⁾ and Skelton.⁽²⁶⁾ The deterministic approach provides a quick analysis if the probabilities are known accurately.⁽¹⁰⁾ Based on assigned probabilities (Fig. 1 and Table II), the frequency of outcome events for “liquefied petroleum gas (LPG) release event tree” and the probability of top event for “runaway reaction fault tree” are calculated as crisp values (Table III). In the probabilistic approach, triangular PDFs are assumed to perform MCS ($N = 5,000$ iterations) and the PDFs for the outcome events’ frequency and the top event probability are determined based on this assumption. The 90% confidence intervals for the outcome events of the “LPG event tree” and top event of “runaway reaction fault tree” are summarized in Table IV and Fig. 3, respectively.

3. UNCERTAINTY IN FTA AND ETA

FTA and ETA require probability data of events (or basic events) as inputs to conduct a comprehensive QRA for a process system. Since most of the time the crisp data as well as PDFs are rarely available for all events and basic events, experts’ judgment/knowledge are often employed as an alternative to the objective data.⁽¹³⁾ Two types of uncertainties, namely, *aleatory and epistemic uncertainties*, are usually addressed while using the expert’s knowledge in QRA.^(10,27,28) *Aleatory uncertainty* is a natural variation, randomness, or heterogeneity of a physical system. It can be well described using probabilistic methods if enough experimental data are available to support the analysis.⁽²⁹⁾ *Epistemic uncertainty* means ambiguity and vagueness, ignorance, knowledge deficiency, or imprecision in system behaviors.

In QRA, it is important to characterize, represent, and propagate the uncertainty accurately in order to get a reliable analysis. However, when the input PDFs are “reasonably known,” MCS can be used to estimate and propagate the uncertainties, especially two dimensional MCS, which can effectively deal with both *aleatory and epistemic uncertainties* (not discussed here).⁽³⁰⁾ If knowledge is limited for definition of the PDFs, probabilistic approaches might not be the best choice to handle the uncertainty in QRA.⁽³¹⁾ In addition, the independence assumption of events (or basic events) might be convenient to simplify the FTA or ETA; however, it is not always true for all cases.⁽¹⁴⁾ This assumption in fact is

Table I. Equations Used in Traditional Fault Tree Analyses and Event Tree Analyses

QRA Method	Equation
ETA	$\lambda_i = \lambda \times \prod_{i=1}^n P_i$
FTA	$P_{OR} = 1 - \prod_{i=1}^n (1 - P_i)$
	$P_{AND} = \prod_{i=1}^n P_i$

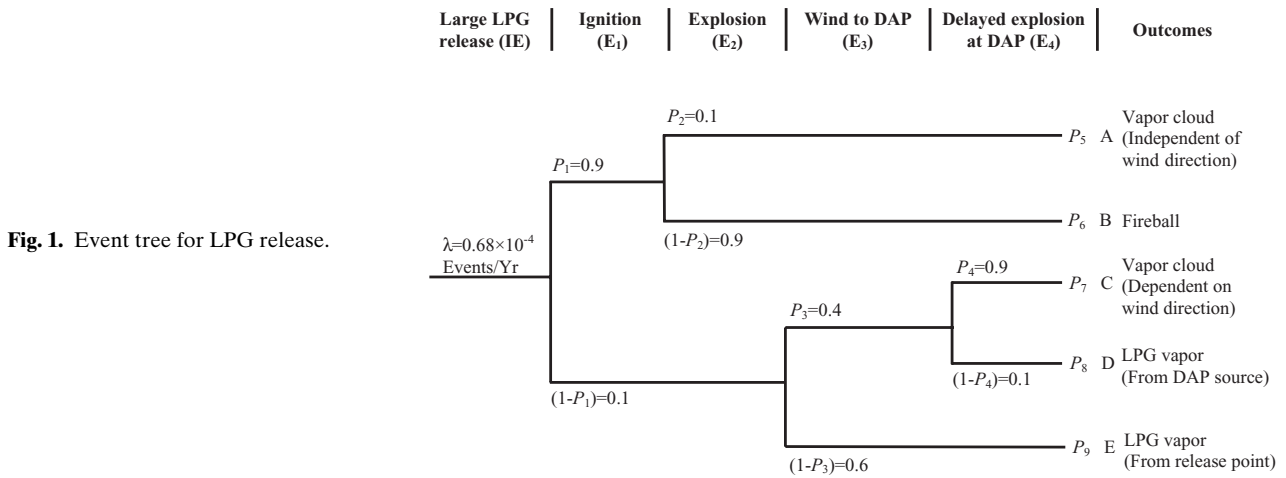

Fig. 1. Event tree for LPG release.

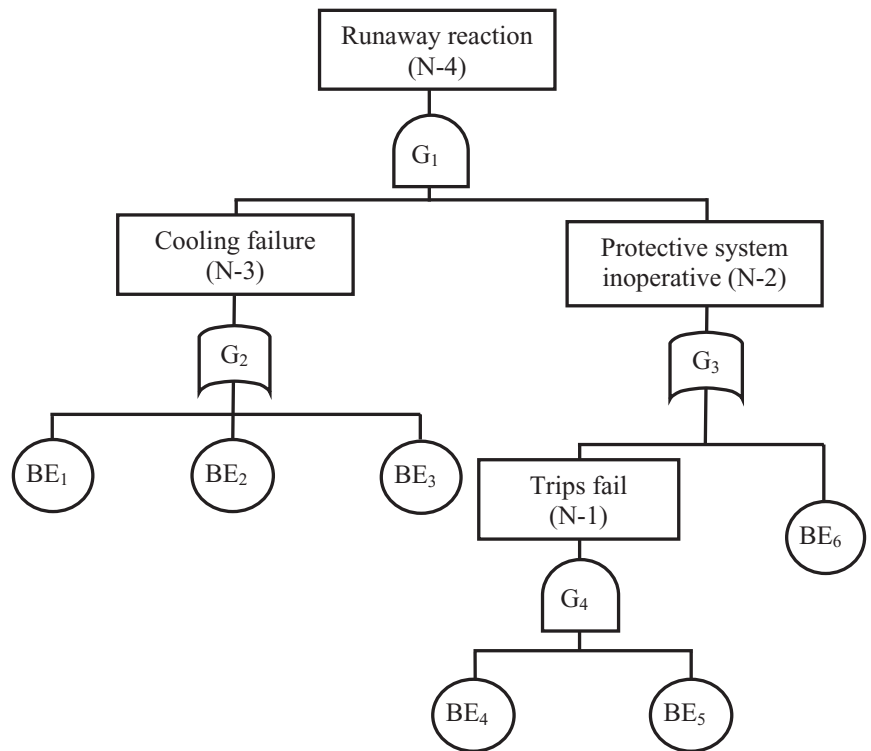

Fig. 2. Fault tree for runaway reaction in a reactor.

Table II. Basic Events Causing the Runaway Reaction

Symbol	Basic-Event	Probability of Basic Event
BE ₁	Pump fails	0.2
BE ₂	Line block	0.01
BE ₃	No cooling water	0.1
BE ₄	Low coolant flow	0.01
BE ₅	High temp	0.01
BE ₆	Dump valve fails	0.001

adding other kind of uncertainty, that is, the *dependency uncertainty*, during the analyses. Vesely *et al.*⁽³⁾ show several cases of FTA where the independent assumptions of basic events are not valid.

Fuzzy set and evidence theories have recently been used in many engineering applications where expert knowledge is employed as an alternative to crisp data or PDFs.^(12,23,28,29,32) Fuzzy set theory is used to address the subjectivity in expert judgment, whereas the evidence theory is more promptly

Table III. Deterministic Results for Fault Tree Analyses and Event Tree Analyses

LPG release event tree	Frequency of outcome events (Events/Yr)	A	B	C	D	E
		6.1E-06	5.5E-05	2.4E-06	2.7E-07	4.1E-06
Runaway reaction fault tree	Probability of top event	$P_{Top} = 3.16E-04$				

Table IV. Frequency Determination of Outcome Events Using Monte Carlo Simulation

Outcome Events	90% Confidence Interval		Median (50th Percentile)
	Lower Bound (5th Percentile)	Upper Bound (95th Percentile)	
A	1.958E-06	1.024E-05	6.100E-06
B	4.935E-05	6.090E-05	5.512E-05
C	7.353E-07	4.151E-06	2.443E-06
D	3.057E-10	5.467E-07	2.736E-07
E	1.300E-06	6.850E-06	4.080E-06

employed in handling the uncertainty that arises due to ignorance, conflict, and incomplete information. In addition, to describe the *dependency uncertainty* among the basic events in FTA, Ferson *et al.*⁽¹⁴⁾ described the Frank copula and Frechet’s limit. For known dependency, the Pearson correlation in the Frank copula describes the full range of dependencies; that is, from perfect dependence to opposite dependence.⁽¹²⁾ Li⁽²⁴⁾ proposed a dependency factor-based fuzzy approach to address the dependencies in performing risk analysis. Li⁽²⁴⁾ uses fuzzy numbers to define the dependency factor among basic events.

In this article, the probabilities of events (or basic events) and their dependency coefficients are treated as fuzzy numbers or basic probability assignments (*bpas*), which are derived through expert knowledge. Fuzzy set and evidence theories along with dependency coefficients, are used to explore the *data* and *dependency uncertainty* in ETA/FTA. The fuzzy numbers in fuzzy set theory describe linguistic and subjective uncertainty while *bpas* in evidence theory are used to handle ignorance, incompleteness, and inconsistency in expert knowledge. A generic framework is shown in Fig. 4 illustrating the use of fuzzy set theory and evidence theory to handle two different kinds of *uncertainties* in FTA and ETA. The following sections describe the fuzzy set theory and the evidence theory with respect to handling uncertainties.

4. FUZZY SET THEORY

Zadeh⁽³³⁾ introduced fuzzy sets, which have recently been applied where probability theory alone was found insufficient to represent all types of uncertainties. Fuzzy set theory is flexible in describing linguistic terms as fuzzy sets, hedges, predicates, and quantifiers.⁽³⁴⁾ Fuzzy set theory is an extension of

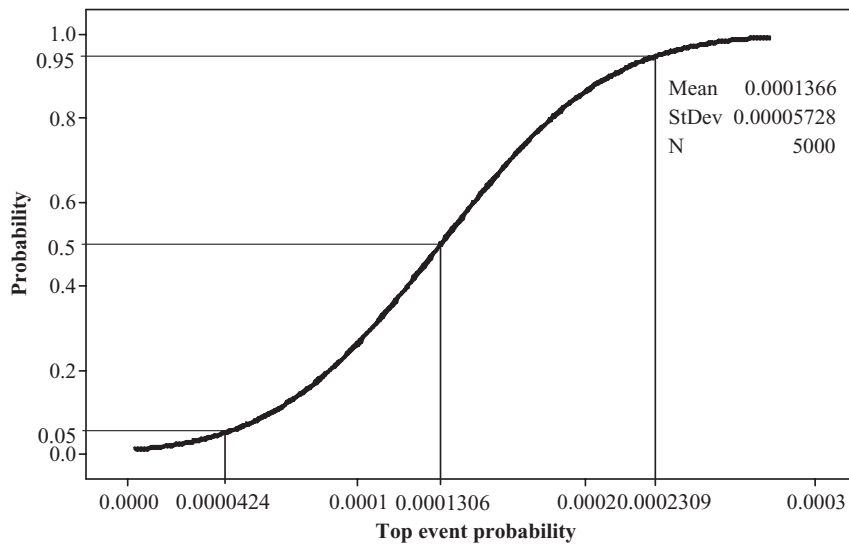

Fig. 3. 90% confidence interval for top event probability.

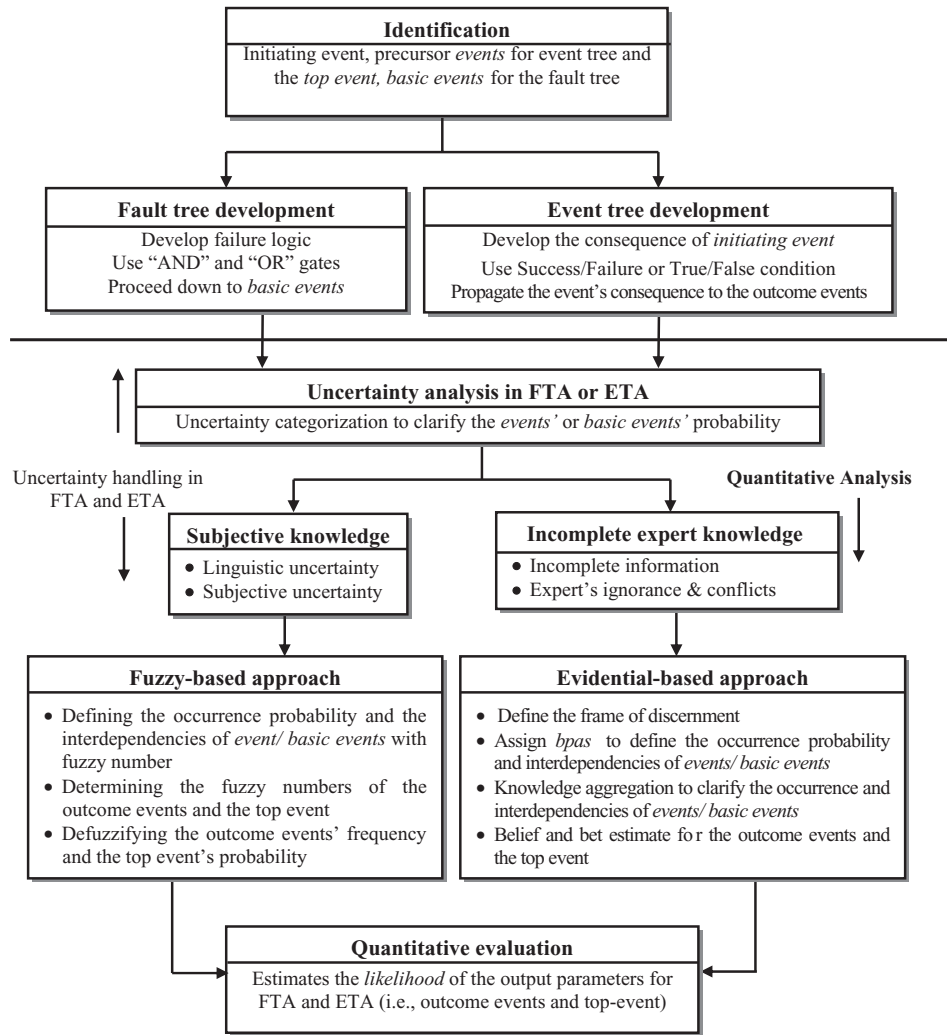

Fig. 4. Framework for fault tree analyses and event tree analyses under uncertainty.

traditional set theory, which represents imprecise values as fuzzy numbers and characterizes the uncertainty using a continuous membership function (μ).

4.1. Fundamentals

Fuzzy numbers are used to describe the vagueness and subjectivity in expert judgment through a relationship between the uncertain quantity p (e.g., event or basic event probability) and a membership function μ that may range between 0 and 1. Any shape of a fuzzy number is possible, but the selected shape should be justified by available information (but it should be normal, bounded, and

convex). Generally, triangular or trapezoidal fuzzy numbers (TFN or ZFN) are used for representing linguistic variables.^(18,21,35,36) In this study, we used triangular fuzzy numbers (TFN) in which the fuzzy intervals are derived using α -cuts. Fig. 5 shows a TFN in which fuzzy intervals are estimated using Equation (1). The values p_L , p_m , and p_R below represent the minimum, most likely, and maximum values, respectively, in an interval \tilde{P}_α :

$$\tilde{P}_\alpha = [p_L + \alpha(p_m - p_L), p_R - \alpha(p_R - p_m)]. \quad (1)$$

Fuzzy set theory uses the fuzzy arithmetic operations based on α -cut formulation to manipulate fuzzy numbers.^(24,37,38) Traditional fuzzy arithmetic operations assume that the events (or basic events) are

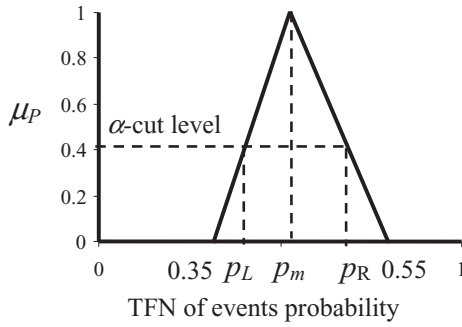

Fig. 5. Triangular fuzzy number to represent the probability of events (or basic events).

independent and use equations in Table V for FTA and ETA.^(15–21,23,37)

4.2. Fuzzy-Based Approach for FTA/ETA

In the proposed fuzzy-based approach, the probability of events (or basic events) can be defined linguistically and described using TFN. The interdependence of events (or basic events) is defined linearly using a dependency coefficient (C_d) that can also be described using a TFN. Fuzzy probability and dependency coefficients are used to determine the probability of top event and the frequency of outcome events in fuzzy terms. The fuzzy-based approach comprises the following three steps:

- (1) Definition of input probability and dependency coefficient using TFN.
- (2) Determination of *likelihood* of outcome events (ETA) and top event (FTA) as a TFN.
- (3) Defuzzification.

4.2.1. Definition of Input Probability and Dependency Coefficient Using TFN

Experts are more comfortable using linguistic expression rather than numerical judgment when they are asked to define an uncertain quantity like the probability of occurrence of events (or basic events) and dependency coefficients.⁽²⁸⁾ In order to capture these linguistic expressions, eight linguistic grades are defined in the proposed approach (Fig. 6). They include: *Very Highly* (VH), *Very Low* (VL), *Moderately High* (MH), *Moderately Low* (ML), *Low* (L), *Moderate* (M), *High* (H), and *Rather High* (RH). These grades can be used to assign the probability of events (or basic events) for ETA (or FTA).

As mentioned earlier, the traditional methods of FTA and ETA assume that the events in an event tree and the basic events in a fault tree are independent. However, in practice, the interdependencies among the events (or basic events) could be ranged from *perfectly dependent* to *oppositely dependent*. A scalar quantity $\in [+1, -1]$ may describe the dependency between two events, where the scalar quantity $+1$ refers to *perfect dependence* and -1 refers to *opposite dependence*.⁽¹⁴⁾ More specifically, the positive dependence belongs to an interval $[0, +1]$, whereas the negative dependence belongs to an interval $[-1, 0]$. However, various levels of dependency are possible in between the events (or basic events). This work explores only the positive dependence of events (or basic events) at each node in FTA (or ETA). Six linguistic grades are used in this study to describe the different levels of interdependencies among the events and basic events, which include: *Perfectly Dependent* (P), *Very Strong* (VS), *Strong* (S), *Weak* (W), *Very Weak* (VW), and *Independent* (I). The left bound (C_{dL}) and the right bound (C_{dR}) in Table VI

Method	Operation	α -Cut Formulation
ETA	Frequency estimation	$\lambda_i = \lambda \times \prod_{i=1}^n (p_{iL}^\alpha, p_{iR}^\alpha)$
	$\tilde{P}_1 \times \tilde{P}_2$	$p_L^\alpha = \prod_{i=1}^n p_{iL}^\alpha; p_R^\alpha = \prod_{i=1}^n p_{iR}^\alpha$
	$\tilde{P}_1 + \tilde{P}_2$	$p_L^\alpha = \sum_{i=1}^n p_{iL}^\alpha; p_R^\alpha = \sum_{i=1}^n p_{iR}^\alpha$
FTA	“OR” gate	$p_L^\alpha = 1 - \prod_{i=1}^n (1 - p_{iL}^\alpha); p_R^\alpha = 1 - \prod_{i=1}^n (1 - p_{iR}^\alpha)$
	“AND” gate	$p_L^\alpha = \prod_{i=1}^n p_{iL}^\alpha; p_R^\alpha = \prod_{i=1}^n p_{iR}^\alpha$

Table V. Traditional α -Cut-Based Fuzzy Arithmetic Operations

Fig. 6. Mapping linguistic grades for fault tree analyses and event tree analyses.

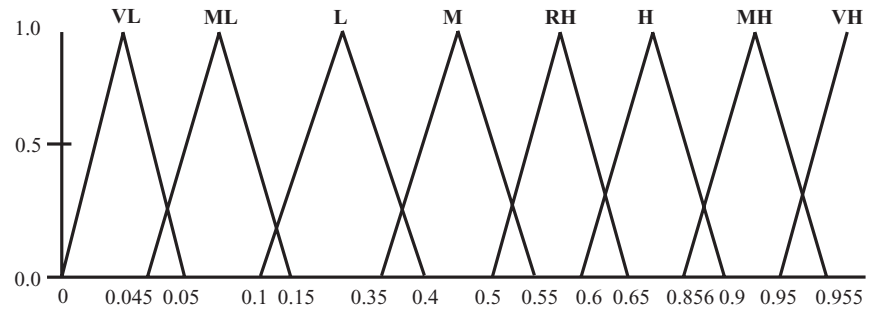

Table VI. Scale to Categorize the Interdependence Among the Basic Events/Events

Linguistic Grade	Description	Minimum (C_{dL})	Maximum Bound (C_{dU})
P	Perfect dependence between the events	1.000	1.000
VS	Very strong dependence, but not fully dependent	0.800	0.995
S	Strong dependence, but not too strong	0.450	0.850
W	Weak dependence, but not too weak	0.150	0.500
VW	Very weak dependence, but not fully independent	0.005	0.200
I	Perfect independence between the events	0.000	0.000

are representing the TFNs boundary for the dependency coefficients.

4.2.2. Determination of Likelihood of Outcome Event and Top Event as a TFN

The dependency coefficient C_d defines the dependence of the events (or basic events) at each node of a fault and event tree (Table VI). The modified fuzzy arithmetic with the empirical relation for FTA and ETA are described in Table VII, where $C_d \approx 1$ refers to perfect dependence and $C_d \approx 0$ refers to complete independence among the event (or basic events).

4.2.3. Defuzzification

Defuzzification transforms the fuzzy number into a crisp value.⁽³⁹⁾ The crisp value is useful in evaluating the rank of outcome events' frequency for ETA and calculating the contribution of basic events leading to the top event FTA. A number of defuzzification methods, including max membership principle, centroid method, weighted average method, mean max membership, center of sums, center of largest area, and first (or last) of maxima, are available in the literature.⁽³⁹⁻⁴¹⁾ The weighted average method is comparatively easy and computationally efficient to implement.^(34,41) The following equation for the weighted average method is used to defuzzify

the obtained fuzzy numbers for the event tree and fault tree outputs:⁽⁴¹⁾

$$P_{out} = \frac{\sum \mu_P(\tilde{P}) \cdot \tilde{P}}{\sum \mu_P(\tilde{P})} \tag{2}$$

5. EVIDENCE THEORY (EVIDENTIAL REASONING)

Multisource knowledge can provide more reliable information about the probability of events (or basic events) than a single source. Knowledge can never be absolute as it is socially constructed and negotiated and often suffers incompleteness and conflict.⁽⁴²⁾ Evidence theory has alternatively been used in many applications, especially when the uncertainty is due to ignorance and incomplete knowledge.^(43,44) The main advantages of evidence theory are:

- (1) Individual belief, including complete ignorance, can be assigned.
- (2) An interval probability can be obtained for each uncertain parameter.
- (3) Multisource information can be combined that helps to avoid bias due to some specific source.⁽⁴⁵⁾

5.1. Fundamentals

Evidence theory was first proposed by Dempster and later extended by Shafer. This theory is

Method	Operation	α -Cut Formulation
ETA	Frequency estimation	$\lambda_i = \lambda \times \prod_{i=1}^n (p_{iL}^\alpha, p_{iR}^\alpha)$
	$\tilde{P}_1 \times \tilde{P}_2$	$p_L^\alpha = [1 - (1 - C_{dL}^\alpha)(1 - p_{1L}^\alpha)] \times p_{2L}^\alpha$ $p_R^\alpha = [1 - (1 - C_{dR}^\alpha)(1 - p_{1R}^\alpha)] \times p_{2R}^\alpha$
FTA	\tilde{P}_1 "OR" \tilde{P}_2	$p_L^\alpha = \{1 - (1 - p_{1L}^\alpha) \times [1 - (1 - C_{dL}^\alpha) \times p_{2L}^\alpha]\}$ $p_R^\alpha = \{1 - (1 - p_{1R}^\alpha) \times [1 - (1 - C_{dR}^\alpha) \times p_{2R}^\alpha]\}$
	\tilde{P}_1 "AND" \tilde{P}_2	$p_L^\alpha = \{[1 - (1 - C_{dL}^\alpha) \times p_{1L}^\alpha] \times p_{2L}^\alpha\}$ $p_R^\alpha = \{[1 - (1 - C_{dR}^\alpha) \times p_{1R}^\alpha] \times p_{2R}^\alpha\}$

Table VII. Modified α -Cut-Based Fuzzy Arithmetic Operations

also known as Dempster-Shafer Theory (DST).^(24,45) DST uses three basic parameters, that is, *basic probability assignment (bpa)*, *belief measure (Bel)*, and *plausibility measure (Pl)* to characterize the uncertainty in a belief structure.^(32,36,46) The belief structure represents a continuous interval [*belief, plausibility*] for the uncertain quantities in which the true probability may lie. Narrow belief structures are representative of more precise probabilities. The main contribution of DST is a scheme for the aggregation of multisource knowledge based on individual degrees of belief.

5.1.1. Frame of Discernment (FOD)

FOD Ω is defined as a set of mutually exclusive elements that allows having a total of $2^{|\Omega|}$ subsets in a power set (P), where $|\Omega|$ is the *cardinality* of an FOD. For example, if $\Omega = \{T, F\}$, then the power set (P) includes four subsets, that is, $\{\Phi$ (a null set), $\{T\}$, $\{F\}$, and $\{T, F\}$, as the cardinality is two.

5.1.2. Basic Probability Assignment

The *bpa*, also known as belief mass, is denoted by $m(p_i)$. The *bpa* represents the portion of total knowledge assigned to the proposition of the power set (P) such that the sum of the proposition is 1. The focal elements, that is, $p_i \subseteq P$ with $m(p_i) > 0$, collectively represent the evidence. The *bpa* can be characterized by the following equation:

$$m(p_i) \rightarrow [0, 1]; \quad m(\Phi) \rightarrow 0; \quad \sum_{p_i \subseteq P} m(p_i) = 1. \quad (3)$$

For example, suppose an expert reports that the occurrence probability of an event in ETA is 80% true and 10% false. For this example, the *baps* of every subset of $m(p_i)$ can be written as $m(T) = 0.8$, and $m(F) = 0.1$. The unassigned *bpa* is referred to

the set $m(\Omega) = m(T, F) = 0.1$. This is because, the unassigned *bpa* is taken as ignorance, which is usually represented by the subset $m\{\Omega\}$.⁽⁴³⁾

5.1.3. Belief Measure

The *belief (Bel) measure*, sometimes termed as the lower bound for a set p_i , is defined as the sum of all the *bpas* of the proper subsets p_k of the set of interest p_i , that is, $p_k \subseteq p_i$. The relationship between *bpa* and *belief measure* is written as:

$$Bel(p_i) = \sum_{p_k \subseteq p_i} m(p_k). \quad (4)$$

The *belief measures* in the above example are given by:

$$Bel(T) = m(T) = 0.8; \quad Bel(F) = m(F) = 0.1$$

and

$$Bel(T, F) = m(T) + m(F) + m(T, F) = 1.0.$$

5.1.4. Plausibility Measure

The upper bound, that is, the *plausibility (Pl) measure*, for a set p_i is the summation of *bpas* of the sets p_k that intersect with the set of interest p_i , that is, $p_k \cap p_i \neq \Phi$. Therefore, the relationship can be written as:

$$Pl(p_i) = \sum_{p_k \cap p_i \neq \Phi} m(p_k). \quad (5)$$

The *plausibility measures* for the above example are given by:

$$Pl(T) = m(T) + m(T, F) = 0.8 + 0.01 = 0.9;$$

$$Pl(F) = m(F) + m(T, F) = 0.1 + 0.1 = 0.2; \quad \text{and}$$

$$Pl(T, F) = 1.0.$$

5.1.5. Rule of Combination for Inference

The combination rules allow aggregating the individual beliefs of experts and provide a combined belief structure. The Dempster & Shafer (DS) combination rule is the fundamental for all combination rules. Many modifications of the DS rule of combination have been reported. The most common modifications include those by Yager, Smets, Inagaki, Dubois and Prade, Zhang, Murphy, and more recently by Dezert and Smarandache.⁽⁴³⁾ Detailed discussions on these rules can be found in Dezert and Smarandache.⁽⁴⁷⁾ In this study, DS and Yager combination rules are discussed in detail and used in developing the evidence-theory-based approach for FTA and ETA. *DS combination rule:* The DS combination rule uses a normalizing factor $(1-k)$ to develop an agreement among the acquired knowledge from multiple sources, and ignores all conflicting evidence through *normalization*. Assuming that the knowledge sources are independent, this combination rule uses the AND-type operator (product) for aggregation.⁽⁴³⁾ For example, if the $m_1(p_a)$ and $m_2(p_b)$ are two sets of evidence for the same event collected from two different experts, the DS combination rule uses the following relation to combine the evidence:

$$m_{1-2}(p_i) = \begin{cases} 0 & \text{for } p_i = \Phi \\ \frac{\sum_{p_a \cap p_b = p_i} m_1(p_a) \times m_2(p_b)}{1 - k} & \text{for } p_i \neq \Phi \end{cases} \quad (6)$$

In the above equation, $m_{1-2}(p_i)$ denotes the combined knowledge of two experts for the event, and k measures the *degree of conflict* between the two experts, which is determined by the factor k :

$$k = \sum_{p_a \cap p_b = \Phi} m_1(p_a) \times m_2(p_b). \quad (7)$$

Yager combination rule: Zadeh in 1984⁽⁴⁸⁾ pointed out that the DS combination rule yields counterintuitive results and exhibits numerical instability if conflict is large among the sources.⁽⁴⁵⁾ To resolve this issue, Yager in 1987⁽⁴⁹⁾ proposed an extension, which is similar to the DS combination rule except that it does not allow normalization of joint evidence with the normalizing factor $(1-k)$. The total degree of conflict (k) is assigned to be part of ignorance Ω .⁽⁴³⁾ However, in a non- (or less) conflicting case, the Yager combination rule exhibits similar results as the DS combination rule. For high conflict

Table VIII. Determination of Belief Structure of an Event Using Different Combination Rules

m_1	m_2	{T}	{F}	{T, F}
		0.60	0.30	0.10
{T}	0.80	{T} = 0.48	{Φ} = 0.24	{T} = 0.08
{F}	0.10	{Φ} = 0.06	{F} = 0.03	{F} = 0.01
{T, F}	0.10	{T} = 0.06	{F} = 0.03	{T, F} = 0.01
k			0.30	
$\sum_{p_a \cap p_b = p_i} m_1(p_a)m_2(p_b)$	0.62		0.07	0.01
m_{1-2} (DS)		0.89	0.1	0.014
m_{1-2} (Yager)		0.62	0.07	0.31
Rules of Combination	Belief Structure			
	<i>Bel</i> (T)	<i>Pl</i> (T)	<i>Bel</i> (F)	<i>Pl</i> (F)
DS rule	0.89	0.90	0.10	0.11
Yager rule	0.62	0.93	0.07	0.38

cases (i.e., higher k value), it provides more stable and robust results than the DS combination rule:⁽¹⁰⁾

$$m_{1-2}(p_i) = \begin{cases} 0 & \text{for } p_i = \Phi \\ \sum_{p_a \cap p_b = p_i} m_1(p_a) \times m_2(p_b) & \text{for } p_i \neq \Omega \\ \sum_{p_a \cap p_b = p_i} m_1(p_a) \times m_2(p_b) + k & \text{for } p_i = \Omega \end{cases} \quad (8)$$

In the above example, if we assume another expert reports new evidence for the same event: $m(\{T\}) = 0.6$, $m(\{F\}) = 0.3$ and $m(\{T, F\}) = 0.1$. Both bodies of evidence are combined using DS and Yager combination rules. The aggregation of the knowledge is performed using Equations (6) and (8). Equations (3) and (4) are used to obtain the combined belief structure of the event (Table VIII).

5.2. Evidence Theory-Based Approach for FTA/ETA

Expert knowledge is used to define the probability of occurrence and dependency coefficient of events (or basic events). Each expert may have their own belief or knowledge that may be incomplete and that may be in conflict with the others. In an evidential reasoning framework, the ignorance in an evidence is assigned to a subset $m(\Omega)$. The conflict among the sources is dealt with using combination rules as discussed above. The following sections

describe the steps of the evidence-theory-based approach to analyze the event tree/fault tree under uncertainties.

5.2.1. Definition of FODs

Three different FODs for three uncertain quantities in FTA and ETA, including the probability of events, the probability of basic events, and the dependency coefficient (C_d), are used to acquire the belief masses from different experts. The subsets for the FODs are generated based on the cardinality of each FOD (Ω).

Traditionally, the consequences of events in ETA are dichotomous, that is, $\{T\}$ and $\{F\}$. Therefore, the FOD for ETA is defined as $\Omega \{T, F\}$, which leads to four subsets in a power set (P) that includes $\{\Phi, \{T\}, \{F\}, \{T, F\}\}$.

The operational state of a system is usually defined on the basis of evaluating the success (S) or failure (F) state of basic components.^(3,5,6) Hence, the occurrence probability of a basic event in FTA can be described using the FOD $\Omega = \{S, F\}$. As the cardinality is two for the FOD, the power set (P) of each event comprises four subsets, which includes $\{\Phi, \{S\}, \{F\}, \{S, F\}\}$.

Six qualitative grades of dependency are categorized in this study to describe interdependences through dependency coefficients for FTA or ETA. The notations of these grades are: Independent (I); Very Weak (M); Weak (W); Strong (S); Very Strong (VS); and Perfect dependence (P). The FOD for this case consists of six cardinal elements, which is represented by $\Omega = \{P, VS, S, W, M, I\}$.

5.2.2. Assignment of $bpas$ to Basic Events/Events

The $bpas$ or belief masses for the events (or basic events) and the dependency coefficients (C_d) are elicited using the experts' knowledge. Assuming that the knowledge sources are independent, the $bpas$ are

assigned to particular subsets of each FOD. However, for the dependency coefficient, experts' knowledge is collected only for the subsets $\{P\}$, $\{VS\}$, $\{S\}$, $\{W\}$, $\{VW\}$, $\{I\}$, and $\{\Omega\}$. The $bpas$ for each subset individually represent the degree of belief of each expert, and implicitly, it represents the total evidences that support the probability of occurrence of an event (or a basic event) and a dependency coefficient (C_d).

5.2.3. Belief Structure and Bet Estimation

The combination rules allow merging the knowledge from different sources as coherent evidence. These rules help to account for ignorance in knowledge and resolve conflicts among the sources. The DS (Equation (6)) or Yager (Equation (8)) combination rules are used in this study to aggregate collected knowledge from different sources. Equations (4) and (5) are then used to derive the *belief* and *plausibility* measure for the probability and dependency coefficients of events (or basic events). The *belief* and *plausibility* measure for six kinds of dependencies (in each node of FTA or ETA) are normalized to attain a generalized belief structure. Information in Table VI, which represents the *belief* and *plausibility* for each kind of dependency, is used for normalizing the belief structure of dependency coefficient for each node. Subsequently, equations shown in Table IX are used to estimate the *likelihoods* of outcome events and top event for the ETA and FTA, respectively.

“*Bet*” provides a point estimate in belief structure (similar to defuzzification), which is often used to represent the crisp value of the final events. It is estimated based on the following equation:

$$Bet(P) = \sum_{p_i \subseteq P} \frac{m(p_i)}{|p_i|}, \quad (9)$$

where $|p_i|$ is the *cardinality* in the set p_i . For example, the “*Bet*” estimate for the belief structure obtained

Method	Operation	Formulation
ETA	Frequency estimation	$\lambda_i = \lambda \times \prod_{i=1}^n [Bel(P_i), Pl(P_i)]$
	$P_1 \times P_2$	$Bel(P_{out}) = [1 - \{(1 - Bel(C_d)) \times \{(1 - Bel(P_1))\}\}] \times Bel(P_2)$ $Pl(P_{out}) = [1 - \{(1 - Pl(C_d)) \times \{(1 - Pl(P_1))\}\}] \times Pl(P_2)$
FTA	P_1 “OR” P_2	$Bel(P_{out}) = 1 - \{(1 - Bel(P_1))\} \times [1 - \{(1 - Bel(C_d)) \times Bel(P_2)\}]$ $Pl(P_{out}) = 1 - \{(1 - Pl(P_1))\} \times [1 - \{(1 - Pl(C_d)) \times Pl(P_2)\}]$
	P_1 “AND” P_2	$Bel(P_{out}) = [1 - \{(1 - Bel(C_d)) \times \{(1 - Bel(P_1))\}\}] \times Bel(P_2)$ $Pl(P_{out}) = [1 - \{(1 - Pl(C_d)) \times \{(1 - Pl(P_1))\}\}] \times Pl(P_2)$

Table IX. Equations to Analyze the Event and Fault Trees

using the DS combination rule is calculated as:

$$Bet(P_T) = \frac{m(T)}{1} + \frac{m(T, F)}{2} = \frac{0.89}{1} + \frac{0.01}{2} = 0.895.$$

The denominators “1” and “2” represent the cardinality in the respective subsets.

6. APPLICATION OF DEVELOPED APPROACHES

The same examples (“LPG release event tree” and “runaway reaction fault tree”) discussed earlier in Section 2 are studied in detail here using both fuzzy-based and evidence theory-based approaches.

6.1. LPG Release—Event Tree Analysis

6.1.1. Fuzzy-Based Approach

The revised event tree with fuzzy probabilities is illustrated in Fig. 7. In the fuzzy-based approach, the

probability of events (or basic events) and their dependency coefficients (C_d) are defined using TFNs. The frequency for the outcome events are then estimated using the α -cut-based fuzzy formulations developed in Table VII. For example, the path leading to the outcome event “A” is followed by the two events. The probability and the coefficient of dependency (C_d) of these two events are linguistically expressed, which are, respectively, assumed to be “Moderately Low (ML),” “Moderately High (MH),” and “Strong (S).” The assigned linguistic expressions for these two events are converted into TFNs (based on Fig. 6 and Table VI). The TFN for the outcome event “A” (shown in Fig. 8) is derived using the empirical equations described in Table VII. Using numerous trials for event dependency at each node of the LPG event tree, the uncertainty ranges (i.e., fuzzy interval) for the outcome event “A” are estimated (shown in Fig. 9). It can be observed that the uncertainty ranges are varied according to the change of event dependency at each node of the event tree.

Fig. 7. Event tree with fuzzy linguistic grades.

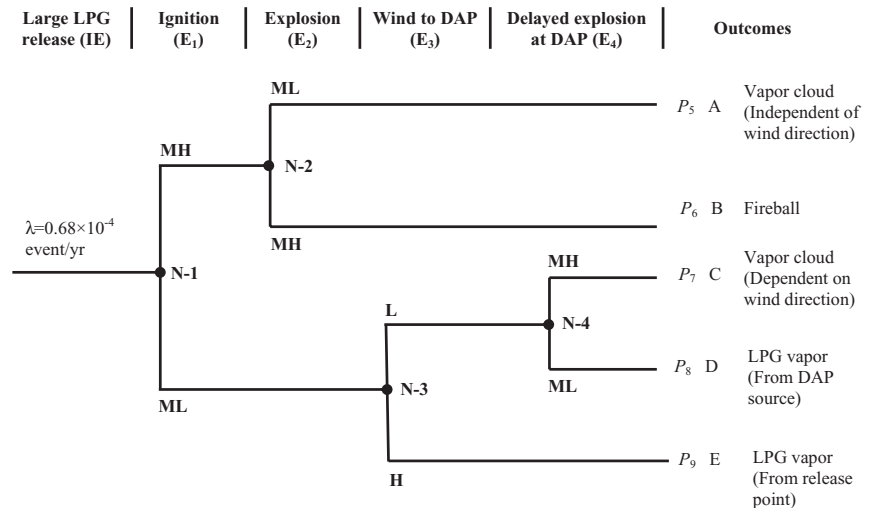
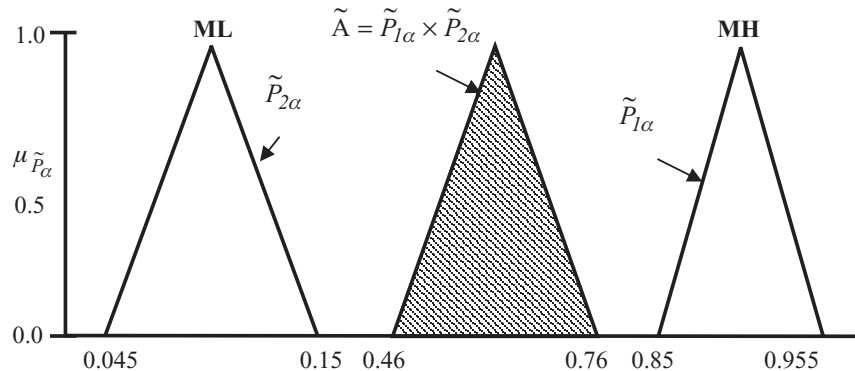

Fig. 8. Triangular fuzzy numbers of outcome event “A” with “strong” dependency.



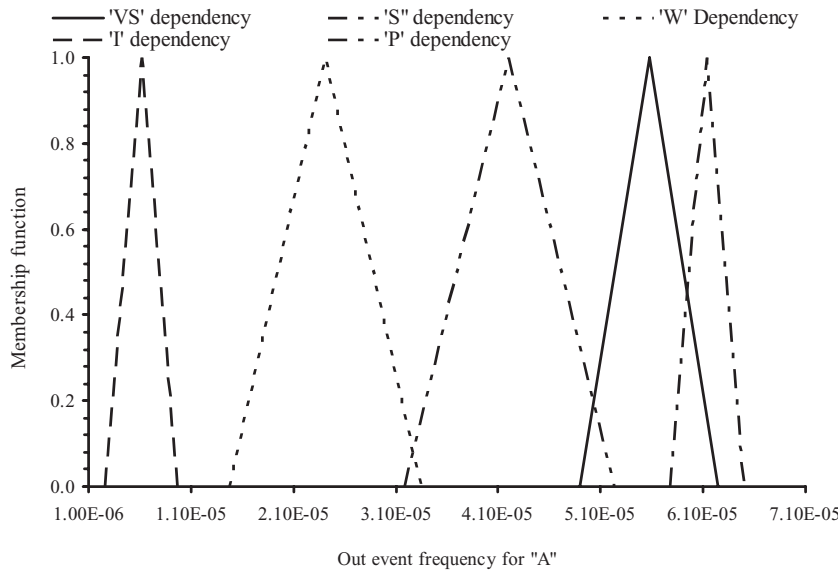

Fig. 9. Uncertainty in outcome event's frequency "A."

6.1.2. Evidence-Theory-Based Approach

To demonstrate the evidence-theory-based approach, experts' knowledge from two unbiased and independent sources is considered for determining the probability as well as the dependency coefficients of events for ETA. The elicited knowledge from the sources is shown in Tables X(a) and X(b).

DS and Yager combination rules are used to aggregate and determine the belief structures of proba-

bility and dependency coefficients of events for the ETA. Table XI lists the belief structures of events and dependency coefficients for the LPG release event tree (Fig. 1). These belief structures and the equations in Table IX are used to derive the belief structures for the outcome events of LPG release. Two different kinds of dependence, that is, independent and dependent, are considered while estimating the belief structures for the outcome events. The

Table X. Experts' Knowledge on (a) the Probability of Events

Symbol	Events' Name	Expert 1 (m_1)			Expert 2 (m_2)		
		{T}	{F}	{T, F}	{T}	{F}	{T, F}
E ₁	Ignition	0.80	0.10	0.10	0.60	0.30	0.10
E ₂	Explosion	0.10	0.80	0.10	0.05	0.80	0.15
E ₃	Wind to DAP	0.60	0.20	0.20	0.50	0.40	0.10
E ₄	Ignition Explosion at DAP	0.85	0.10	0.05	0.80	0.10	0.10

(b) Interdependence of Events at Different Nodes

Number of Experts	Node (N)	{*P}	{VS}	{S}	{W}	{VW}	{I}	{Ω}
Expert 1 (m_1)	N-1	0.15	0.00	0.30	0.10	0.00	0.00	0.45
	N-2	0.00	0.30	0.20	0.00	0.10	0.00	0.40
	N-3	0.40	0.00	0.20	0.00	0.00	0.20	0.20
	N-4	0.50	0.20	0.00	0.00	0.00	0.20	0.10
Expert 2 (m_2)	N-1	0.30	0.00	0.20	0.15	0.00	0.00	0.35
	N-2	0.20	0.30	0.00	0.00	0.00	0.15	0.35
	N-3	0.00	0.20	0.40	0.00	0.20	0.00	0.20
	N-4	0.00	0.30	0.40	0.00	0.20	0.00	0.10
	N-1	0.30	0.00	0.20	0.15	0.00	0.00	0.35

Table XI. Belief Structures for the Probability and Interdependence of Events

Reference in the Event Tree		DS Rule of Combination		Yager Rule of Combination			
		<i>Bel</i>	<i>Pl</i>	<i>Bel</i>	<i>Pl</i>		
E ₁	T	0.8857	0.9000	0.6200	0.9300		
	F	0.1000	0.1143	0.0700	0.3800		
E ₂	T	0.0284	0.0455	0.0250	0.1600		
	F	0.9545	0.9716	0.8400	0.9750		
E ₃	T	0.6970	0.7273	0.4600	0.8200		
	F	0.2727	0.3030	0.1800	0.5400		
E ₄	T	0.9641	0.9701	0.8050	0.9750		
	F	0.0299	0.0359	0.0250	0.1950		
*N-1		0.2549	0.7450	0.1605	0.8395		
N-2		0.2755	0.7245	0.1526	0.8474		
N-3		0.3150	0.6849	0.0769	0.9230		
N-4		0.4013	0.5987	0.0512	0.9488		
		P	VS	S	W	VW	I
N-1	<i>Bel</i>	0.305	0.000	0.334	0.154	0.000	0.000
	<i>Pl</i>	0.511	0.207	0.541	0.361	0.207	0.207
<i>Bel</i> (C _d)	$\frac{(0.305 \times 1 + 0 \times 0.80 + 0.334 \times 0.45 + 0.154 \times 0.15 + 0 \times 0.005 + 0 \times 0)}{(0.305 + 0 \times 0.80 + 0.334 \times 0.45 + 0.154 \times 0.15 + 0 \times 0.005) + (0.551 + 0.207 \times 0.995 + 0.541 \times 0.85 + 0.361 \times 0.5 + 0.207 \times 0.2)} = 0.255$						
<i>Pl</i> (C _d)	$\frac{(0.511 \times 1 + 0.207 \times 0.995 + 0.541 \times 0.85 + 0.361 \times 0.5 + 0.207 \times 0.2 + 0 \times 0.207)}{(0.305 + 0 \times 0.80 + 0.334 \times 0.45 + 0.154 \times 0.15 + 0 \times 0.005) + (0.551 + 0.207 \times 0.995 + 0.541 \times 0.85 + 0.361 \times 0.5 + 0.207 \times 0.2)} = 0.745$						

*Normalization of belief structure at N-1 for DS rule of combination.
T = true; F = false.

Table XII. Outcome Events Frequency for Two Kinds of Interdependence of Events

Outcome Events	Interdependence of Events					
	Independent			Dependent		
	Belief Structures (DS Rule of Combination)		<i>Bet</i>	Belief Structures (Yager Rule of Combination)		<i>Bet</i>
	<i>Bel</i>	<i>Pl</i>		<i>Bel</i>	<i>Pl</i>	
A	1.054E-06	1.012E-05	*5.586E-06	1.153E-06	1.076E-05	5.958E-06
B	3.541E-05	6.166E-05	4.854E-05	3.873E-05	6.559E-05	5.216E-05
C	1.763E-06	2.066E-05	1.121E-05	6.186E-06	6.556E-05	3.587E-05
D	5.474E-08	4.132E-06	2.093E-06	1.921E-07	1.311E-05	6.652E-06
E	8.568E-07	1.395E-05	7.405E-06	1.733E-06	3.497E-05	1.835E-05

*Belief structure of outcome event “A” is [1.054E-06, 1.012E-05]. So, $m(T) = 1.054E-06$, and $m(T, F) = 9.064E-06$

$$Bet(A) = \frac{m(T)}{1} + \frac{m(T,F)}{2} = \frac{1.054E-06}{1} + \frac{9.064E-06}{2} = 5.586E-06$$

results are presented in Table XII. An order of magnitude difference is observed in the “*Bet*” estimation for the outcome event “E.” This difference signifies the importance of defining the dependency relationships in ETA.

The difference of using the DS and Yager combination rules is shown in Fig. 10. In the figure, different kinds of dependencies are labeled on the x-axis. The *belief* and *plausibility* measure for each kind of dependency is plotted on the y-axis. The minimum

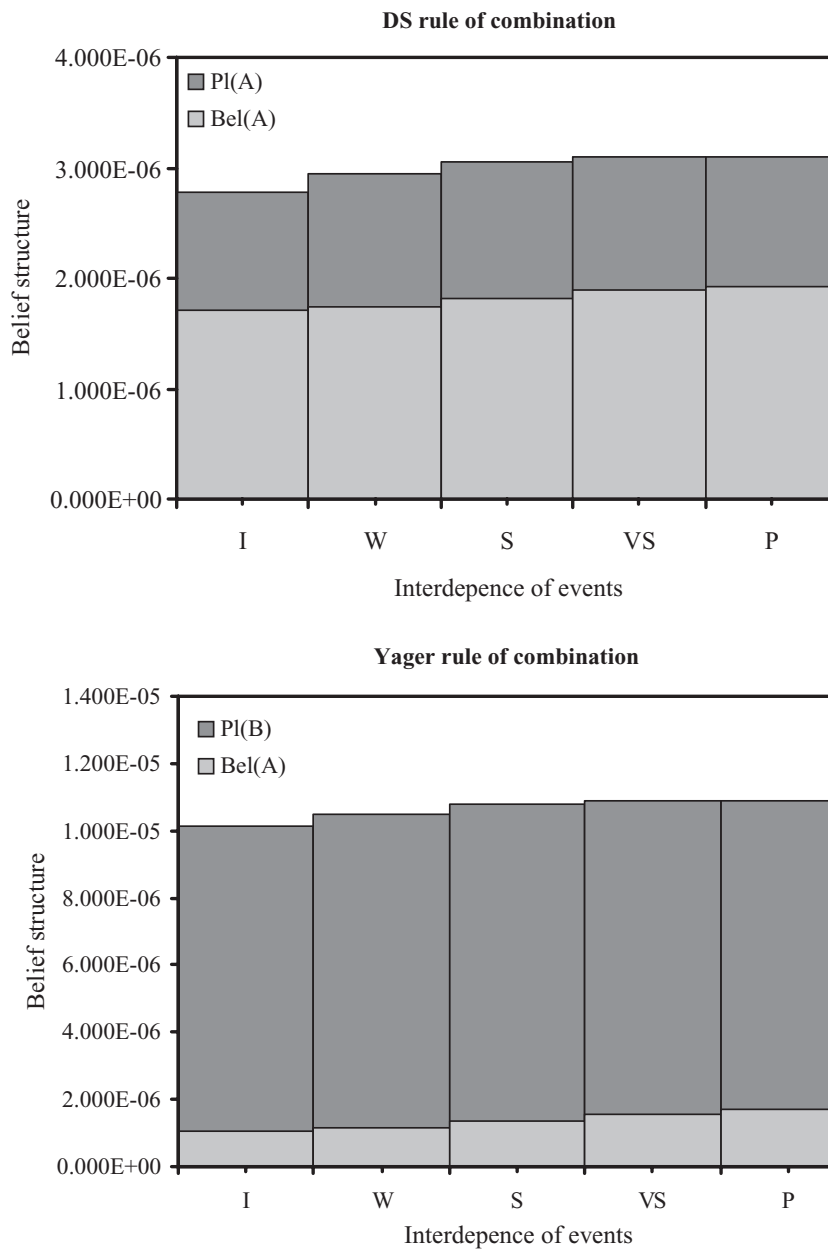

Fig. 10. Belief structure representing the frequency for outcome event “A.”

and maximum values presented in Table VI are considered as the belief structure of dependency coefficient for each kind of dependency. The shaded areas in Fig. 10 represent the *belief* and *plausibility* measures for the outcome event “A.” These areas show that the Yager combination rule measures a large belief structure in comparison to the DS combination rule. Hence, an interpretation can be made that the Yager combination rule yields more conservative results (i.e., a larger belief structure) in the context of existing high conflicts in the sources.

6.2. Runaway Reaction—FTA

6.2.1. Fuzzy-Based Approach

To demonstrate the fuzzy-based approach for FTA, the probability of basic events and their dependencies are defined using expert linguistic expressions. The linguistic expressions are converted into TFNs. The linguistic expressions and the corresponding TFNs are given in Table XIII. A total of seven different trials and the fuzzy arithmetic operations (described in Table VII) are used to evaluate the

Table XIII. Expert’s Knowledge on the Probability of Basic Events

Event	Linguistic Variable	TFNs
BE ₁	L	(0.1, 0.25, 0.4)
BE ₂	VL	(0, 0.025, 0.05)
BE ₃	ML	(0.045, 0.0975, 0.15)
BE ₄	VL	(0, 0.025, 0.05)
BE ₅	VL	(0, 0.025, 0.05)
BE ₆	VL	(0, 0.025, 0.05)

TFN for the top event. The trials are categorized based on different assumptions of dependencies at each node of the fault tree. The TFNs of the top event for the different trials are shown in Fig. 11. In trial 7, when perfect dependencies are assumed, the top event probability bears the maximum uncer-

tainty. Contrary to trial 1, when the events are assumed independent, the top event probability bears the smallest uncertainty.

6.2.2. Evidence-Theory-Based Approach

The fault tree for the runaway reaction as shown in Fig. 2 is studied to demonstrate the application of evidence-theory-based approach in FTA. The probability of basic events and the dependency coefficients for the fault tree are obtained from two independent sources. Tables X(b) and XIV show the experts’ knowledge for defining the probability and dependency coefficients of basic events for the FTA.

DS and Yager combination rules are used to aggregate the knowledge and estimate the belief structures for the basic events and dependency coefficients. The belief structure of the top event is

Trials (T)	Dependency of basic events in different nodes (N)				TFNs of top event probability
	N-1	N-2	N-3	N-4	(P_L, P_m, P_R)
1	I	I	I	I	(0, 0.013, 0.027)
2	VW	VW	VW	VW	(0, 0.061, 0.122)
3	W	W	W	W	(0, 0.122, 0.244)
4	VS	S	W	W	(0, 0.121, 0.243)
5	S	S	S	S	(0, 0.179, 0.359)
6	VS	VS	VS	VS	(0, 0.199, 0.399)
7	P	P	P	P	(0, 0.200, 0.400)

Fig. 11. Uncertainty representation for top event using different trials.

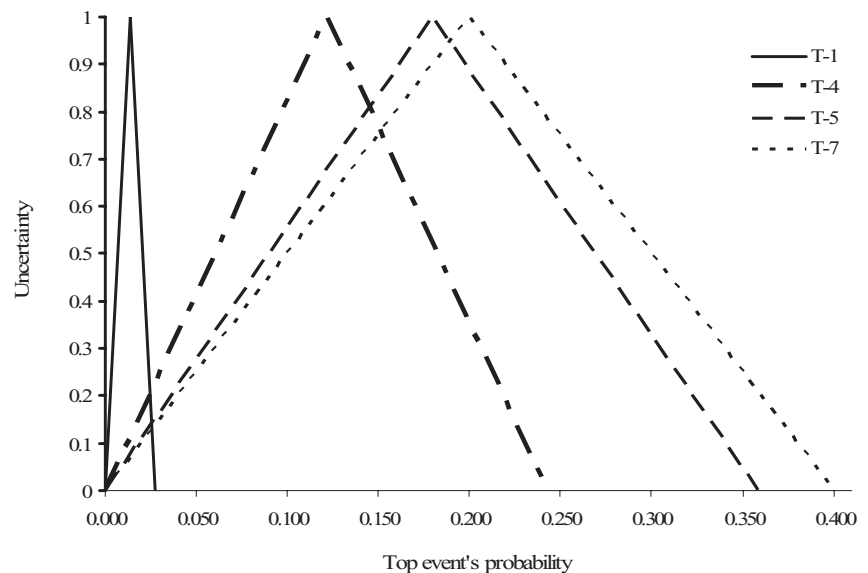

Table XIV. Multisource Knowledge for the Probability of Basic Events

Basic Event	Expert 1 (m_1)			Expert 2 (m)		
	{F}	{S}	{SF}	{F}	{S}	{SF}
BE ₁	0.150	0.750	0.100	0.250	0.650	0.100
BE ₂	0.020	0.800	0.180	0.015	0.900	0.085
BE ₃	0.200	0.700	0.100	0.100	0.800	0.100
BE ₄	0.015	0.950	0.035	0.025	0.950	0.025
BE ₅	0.015	0.900	0.085	0.010	0.980	0.010
BE ₆	0.002	0.950	0.048	0.001	0.940	0.059

S = success; F = failure.

then calculated by using the equations in Table IX. Table XV shows the belief structure and the “*Bet*” estimate of the top event for two combination rules. A total of seven trials are performed using different assumptions of interdependence between the basic events. The belief structure for each kind of dependence is defined in Table VI. Table XV indicates that the uncertainty in calculating the belief structure and “*Bet*” estimate varies accordingly with the change of interdependence at different nodes.

7. UNCERTAINTY-BASED FORMULATIONS FOR FTA AND ETA: A COMPARISON

The level of uncertainty associated with a system is proportional to its complexity, which arises as a result of vaguely known relationships among various entities, and randomness in the mechanisms governing the domain. Sadiq *et al.*⁽⁵⁰⁾ described complex systems such as environmental, sociopolitical, engineering, or economic systems, which involve human interventions, and where vast arrays of inputs and outputs could not all possibly be captured

analytically or controlled in any conventional sense. Moreover, relationships between causes and effects in these systems are often not well understood but can be expressed empirically. Typical complex systems consist of numerous interacting factors or concepts. These systems are highly nonlinear in behavior and the combined effects of contributing factors are often subadditive or superadditive. The modeling of complex dynamic systems requires methods that combine human knowledge and experience as well as expert judgment. When significant historical data exist, model-free methods such as artificial neural networks (ANN) can provide insights into cause-effect relationships and uncertainties through learning from data.⁽⁴⁾ But, if historical data are scarce and/or available information is ambiguous and imprecise, soft computing techniques can provide an appropriate framework to handle such relationships and uncertainties. Such techniques include probabilistic and evidential reasoning (Dempster-Shafer Theory), fuzzy logic, and evolutionary algorithms.⁽⁵⁰⁾ Table XVI provides a qualitative comparison between five soft computing techniques, including ANN, decision trees (DT), fuzzy rule-based models (FRBM), Bayesian networks (BN), and cognitive maps/fuzzy cognitive maps (CM/FCM). Central to this comparison is an assessment of how each technique treats inherent uncertainties and its ability to handle interacting factors that encompass issues specific to engineering systems.⁽⁵⁰⁾

Qualitative and quantitative comparisons have been performed in this section to investigate the features and uncertainty handling abilities of different tools and the proposed approaches for FTA and ETA. The qualitative comparison presented in Table XVII illustrates that most of the tools such

Table XV. Belief Structures and “*Bet*” Estimations of Top Event for Different Trails

Trials (T)	Dependency of Basic Events at Different Nodes				Belief Structure of Top Event’s Probability					
					DS Rule			Yager Rule		
	N-1	N-2	N-3	N-4	<i>Bel</i>	<i>Pl</i>	<i>Bet</i>	<i>Bel</i>	<i>Pl</i>	<i>Bet</i>
1	I	I	I	I	3.440E-05	6.234E-04	3.289E-04	2.579E-05	3.942E-03	1.984E-03
2	VW	VW	VW	VW	3.595E-05	3.865E-02	1.934E-02	2.721E-05	1.133E-01	5.666E-02
3	W	W	W	W	9.650E-05	8.294E-02	4.152E-02	8.555E-05	2.441E-01	1.221E-01
4	VS	S	W	W	1.998E-04	8.292E-02	4.156E-02	1.772E-04	2.483E-01	1.242E-01
5	S	S	S	S	2.506E-04	1.151E-01	5.768E-02	2.440E-04	3.458E-01	1.730E-01
6	VS	VS	VS	VS	3.167E-04	1.222E-01	6.126E-02	3.160E-04	3.718E-01	1.860E-01
7	P	P	P	P	2.000E-04	1.224E-01	6.130E-02	2.000E-04	3.725E-01	1.864E-01

P = perfect dependence; VS = very strong; S = strong; W = weak; VW = very weak; I = independent.

Attributes	Soft Computing Techniques				
	Decision Tree	Fuzzy Rule-Based Models	Artificial Neural Networks	Bayesian Networks	Cognitive Maps/Fuzzy Cognitive Maps
Network capability	N ^a	L ^b	N	H ^c	VH ^d
Ability to express causality	H	M	N	H	VH
Formulation transparency	H	H	N ^e	H	VH
Ease in model development	H	M	M	M	VH
Ability to model complex systems	M	H	VH	H	VH
Ability to handle qualitative inputs	H	H	N	H	VH
Scalability and modularity	VL	L	VL ^f	H	VH ^g
Data requirements	H	L	VH	M	L ^h
Difficulty in modification	VH	H	M	L	N
Interpretability of results	VH	VH	VH	VH	H
Learning/training capability	H	M ⁱ	VH ^j	H ^k	H ^l
Time required for simulation	L	L	H	L	L
Maturity of science	VH	H	H	VH	M
Ability to handle dynamic data	L	H	H	H	M
Examples of hybrid models (ability to combine with other approaches)	H	VH ^m	VH ^m	H	H ⁿ

Table XVI. Comparison of Various Techniques for Complex Systems⁽⁵⁰⁾

Ratings: N = no or negligible; VL = very low; L = low; M = medium; H = high; VH = very high.

^aStructure is hierarchical.

^bDimensionality is a major problem and formulation becomes complicated for network systems.

^cCan manage networks but cannot handle feedback loops; therefore referred to as directed acyclic graphs (DAG).

^dCan handle feedback loops.

^eGenerally, referred to as black-box models.

^fANN needs to be retrained for new set of conditions.

^gVery easy to expand because algorithm is in the form of matrix algebra.

^hMinimal data requirement because causal relationships are generally soft in nature.

ⁱClustering techniques, e.g., fuzzy C-means.

^jAlgorithms, e.g., Hebbian learning.

^kAlgorithms, e.g., evolutionary algorithms and Markov chain Monte Carlo.

^lTraining algorithms are available, which have been successful in training ANNs.

^mExamples are available in the literature to develop models using hybrid techniques, e.g., neuro-fuzzy models.

ⁿHas a potential to be used with other soft techniques.

as Relex V7.7,⁽⁵¹⁾ RAM Commander 7.7⁽⁵²⁾, and PROFAT⁽⁵³⁾ are unable to handle *dependency uncertainty*. Except for PROFAT, the other tools cannot handle subjective uncertainty in the fault and event trees for a system. PROFAT⁽⁵³⁾ is a fuzzy-based tool that can handle subjective uncertainty; however, it fails to account for *epistemic uncertainty*

owing to ignorance or incompleteness of an expert’s knowledge.

Another type of uncertainty arises due to lack of information on dependencies among events. Traditional FTA uses a default assumption of “independence” among the risk events to determine the joint probability (risk) of a parent event. This

Uncertainty	Relax V7.7 ⁽⁵¹⁾ ^a	RAM Commander 7.7 ⁽⁵²⁾ ^a	PROFAT (Khan and Abbasi, 1999) ⁽⁵³⁾	Proposed Approach
Subjective (fuzzy-based)	NC ^b	NC	C ^c	C
Incompleteness (evidence based)	NC	NC	NC	C
Dependency	NC	NC	NC	C

^aA commercial software.
^bNot considered.
^cConsidered.

assumption simplifies the analysis, but may not be very realistic. The relationship between risk events may be positively or negatively correlated (or independent). In the case of two independent events X and Y, the joint probability of their conjunction is simply a product of their individual probabilities.^(12,14) There exist many different methods to express correlation (dependence) but the Frank model (copula) is the most common.

Simple dependency coefficient-based empirical relations (similar to Li approach⁽²⁴⁾) embedded within the proposed approach can concurrently handle the *dependency uncertainty* in FTA and ETA. The proposed approach successfully accounts for the subjective uncertainty using a membership function and evaluates the uncertainty range as a fuzzy interval. The evidence-theory-based approach can describe the *epistemic* and *aleatory uncertainties* in ex-

perts' knowledge using *bpa* and is able to provide a measure of uncertainty using belief structures.

Relax V7.7⁽⁵¹⁾ and RAM Commander 7.7⁽⁵²⁾ are two useful tools for reliability and safety engineering. The probability of top event for the “runaway reaction fault tree” and the frequency of outcome events for the “LPG release event tree” have been analyzed using these tools for the same input (Fig. 1 and Table II). Results (Table XVIII) show that by introducing 10% uncertainty into the input data, these two tools accumulated about 19% and 9% of uncertainty on the calculated top event’s probability and outcome event’s frequency of “B.” The original input data (Fig. 1 and Table II) are reduced by 10% to introduce the uncertainty into the analysis. The traditional (probabilistic) methods used predefined PDFs to describe the uncertainty in the input data (i.e., the probability of basic events or events in FTA

Table XVIII. Quantitative Comparison of Fault Tree Analyses/Event Tree Analyses Tools

Determination of Probability of Top Event for “Runaway Reaction Fault Tree”							
Commercial Packages							
Relax V7.7 ⁽⁵¹⁾		RAM Commander 7.7 ⁽⁵²⁾		Fuzzy-Based Defuzzified Value		Evidence-Theory-Based <i>Bet</i> Estimation	
No Uncertainty	10% Uncertainty	No Uncertainty	10% Uncertainty	No Uncertainty	10% Uncertainty	No Uncertainty	10% Uncertainty
3.16E-04	2.55E-04	3.41E-04	2.74E-04	8.71E-03	8.76E-03	3.16E-04	2.86E-04
Determination of Frequency of Outcome Events for LPG Release							
Outcome Events	Relax V7.7, RAM Commander 7.7 ^(51,52)		Fuzzy-Based Defuzzified Value		Evidence-Theory-Based <i>Bet</i> Estimation		
	No Uncertainty	10% Uncertainty	No Uncertainty	10% Uncertainty	No Uncertainty	10% Uncertainty	
A	6.12E-06	4.95E-06	5.98E-06	5.99E-06	6.12E-06	8.36E-06	
B	5.51E-05	5.01E-05	5.54E-05	5.54E-05	5.51E-05	5.05E-05	
C	2.45E-06	3.76E-06	1.50E-06	1.58E-06	2.45E-06	3.60E-06	
D	2.72E-07	8.84E-07	1.62E-07	1.71E-07	2.72E-07	6.64E-07	
E	4.08E-06	8.27E-06	4.97E-06	4.98E-06	4.08E-06	5.79E-06	

Table XVII. Qualitative Comparisons of Proposed Approach with Available Fault Tree Analyses/Event Tree Analyses Tools

or ETA). When the crisp data or the PDFs for the input data are not known or limited (a very common situation in process systems), the FTA or ETA are highly dependent on expert knowledge. In these situations, traditional tools and probabilistic approaches are not helpful. This makes the FTA/ETA less credible. Both fuzzy set theory and evidence theory are not limited by availability of detailed data. The results using both approaches are presented in Table XVIII. An expert knowledge and assumption of independence among events (or basic events) are used in calculating the top event probability and outcome events frequency. In fuzzy-based approach, the uncertainty is assigned using the membership function. The TFNs corresponding to 90% membership are considered as input data for the analysis. In evidence-theory-based approach, the uncertainty is allocated through the unassigned mass (as ignorance) of the power set. For the 10% uncertainty in the basic event probabilities, the evidence-theory-based approach estimates about 9% and 8% uncertainties in the response, that is, $[2.55 \times 10^{-4}, 3.16 \times 10^{-4}]$ and $[4.46 \times 10^{-5}, 5.63 \times 10^{-5}]$, respectively. Similarly, the fuzzy-based approach measures less than 1% uncertainty results in the response (top event's probability as well as outcome event's frequency "B.") with corresponding fuzzy intervals of $[7.38 \times 10^{-3}, 1.01 \times 10^{-2}]$ and $[5.47 \times 10^{-5}, 5.60 \times 10^{-5}]$.

8. RESULTS AND DISCUSSIONS

Two types of uncertainty, namely, *data uncertainty* and *dependency uncertainty*, were explored. Expert knowledge in terms of fuzzy linguistic grades and *bpas* was used instead of assigning the *likelihood* and interdependencies of basic events/events as crisp probabilities for FTA/ETA. The dependency coefficient in each node of the fault tree and event tree addressed the *dependency uncertainty* and described the relationships among the basic events/events.

Fuzzy linguistic grades were assigned to TFNs and α -cut-based fuzzy empirical relations of the fuzzy-based approach were used to handle the linguistic and subjective uncertainty in expert knowledge. For multisource knowledge, the incomplete and inconsistent *baps* were combined by using combination rules. The dependency coefficients in evidence-theory-based empirical relations were used to describe the *dependency uncertainty* and analyze the fault tree and event tree under uncertainty due to inconsistent, incomplete, and partial ignorance of multisource knowledge.

The developed approaches were applied to two case studies: "LPG release event tree" and "runaway reaction fault tree." The interdependencies among the events (or basic events) were varied in each node of the fault tree or event tree. The impacts of the interdependencies were observed so as to understand the effects of the dependencies of events (or basic events) in FTA/ETA for process systems. For two dependence cases of basic events/events, independent and perfectly dependent, the output results for the FTA and ETA are provided in Tables XIX and XX, respectively. It can be observed in the first three rows of Table XIX that the results remain almost the same. However, when dependency was considered (fourth row in Table XIX), the results varied by an order of magnitude. This highlights the importance of dependencies in ETA.

The results in Table XX are inconsistent mainly because of different types of uncertainties modeled in the different approaches. The perfectly dependent case in FTA determines the probability range for the top event as $[0, 0.400]$, which is a maximum in comparison to the independent case for representing the uncertainty. It can also be observed in Table XX that when the basic events are perfectly dependent, the point estimate (defuzzified value) of the top event exhibits a higher ordered magnitude in comparison to the deterministic approach and MCS-based

Table XIX. Summary of Event Tree Analyses Results

Approach		Dependency of Events	Frequency of Outcome Event "A"
Deterministic approach		Independent	6.12E-06
MCS-based approach	90% confidence interval	Independent	(1.96E-05, 1.02E-04)
	Median		6.10E-06
Fuzzy-based approach	Fuzzy interval	Independent	(2.60E-06, 9.74E-06)
	Defuzzified value		6.17E-06
Fuzzy-based approach	Fuzzy interval	Perfectly dependent	(5.78E-05, 6.49E-05)
	Defuzzified value		6.14E-05

Approach		Dependency of Basic Events	Top Event's Probability (P_{Top})
Deterministic approach		Independent	3.16E-04
MCS-based approach	90% Confidence interval	Independent	(4.24E-05, 2.31E-04)
	Median		1.30E-04
Fuzzy-based approach	Fuzzy interval	Independent	(0, 2.70E-02)
	Defuzzified value		1.35E-02
Fuzzy-based approach	Fuzzy interval	Perfectly dependent	(0, 4.00E-01)
	Defuzzified value		2.00E-01

Table XX. Summary of Fault Tree Analyses Results

approach. This confirms the significance of including the dependencies of the basic events in FTA. Similar observations of using the evidence-theory-based approach for FTA/ETA (Tables XII and XV) confirm that a reliable and robust result cannot be attained without considering the interdependencies of events (or basic events).

9. CONCLUSIONS

FTA and ETA are two fairly established techniques; however, the uncertainty in defining the probabilities and the relationships of events (or basic events) can lead to questionable results for QRA. The traditional approaches require the known probability and the independence assumption of events (or basic events), which are rare and often unrealistic for process systems. Two different approaches to handle these types of uncertainties in FTA and ETA are derived in this study by combining expert knowledge with fuzzy set theory and evidence theory. The application of these approaches to two different case studies shows the proposed approaches are more robust to handle the uncertainty in QRA for the process systems in the following ways:

- (1) Fuzzy-based approaches and evidence-theory-based approaches properly address the uncertainties in expert knowledge and analyze the event trees or fault trees associated with different kinds of uncertainties in expert knowledge.
- (2) Introduction of a dependency coefficient in the fuzzy- and evidence-theory-based approaches describes interdependencies among the events (or basic events) in a fault tree/event tree.
- (3) The proposed approaches can be applied to FTA/ETA for any process systems that have *data* and *dependency uncertainties*.

Including the negative dependencies of events (or basic events), and combining the subjectivity (using fuzzy-based approach) and incompleteness (evidence theory) into a single approach, for example, Fuzzy-Dempster-Shafer, may offer additional future improvement to the approaches developed here.

ACKNOWLEDGMENTS

The authors gratefully acknowledge the financial support provided by the Natural Sciences and Engineering Research Council of Canada (NSERC) through the Strategic Grant Program.

REFERENCES

1. Ferdous R, Khan F, Veitch B, Amyotte PR. Methodology for computer aided fuzzy fault tree analysis. *Process Safety and Environmental Protection*, 2009; 87(4):217–226.
2. Spouge J. A Guide to Quantitative Risk Assessment for Off-shore Installations. Aberdeen, UK: CMPT Publication, 1999.
3. Vesely WE, Goldberg FF, Roberts NH, Haasl DF. *Fault Tree Handbook*. Washington, DC: U.S. Nuclear Regulatory Commission, 1981.
4. Haasl DF. Advanced concepts in fault tree analysis. In *System Safety Symposium*. Seattle, WA, Washington, DC: Boeing Company, 1965.
5. Hauptmanns U. Fault tree analysis of a proposed ethylene vaporization unit. *Industrial & Engineering Chemistry Fundamentals*, 1980; 19(3):300–309.
6. Hauptmanns U. Fault tree analysis for process industries engineering risk and hazard assessment. Pp. 21–59 in Kandel A, Avni E (eds). *Engineering Risk & Hazard Assessment*, vol. 1. Boca Raton, FL: CRC Press, 1988.
7. Kumamoto H, Henley EJ. *Probabilistic Risk Assessment and Management for Engineers and Scientists*, 2nd ed. New York: IEEE, 1996.
8. AIChE. *Guidelines for Chemical Process Quantitative Risk Analysis*. New York: CCPS of the American Institute of Chemical Engineers, 2000.
9. Andrews JD, Dunnett SJ, Tu L. Event tree analysis using binary decision diagrams. *IEEE Transactions on Reliability*, 2000; 49(2):230–238.
10. Ferdous R, Khan F, Sadiq R, Amyotte P, Veitch B. Handling data uncertainties in event tree analysis. *Process Safety and Environmental Protection*, 2009; 87(5):283–292.
11. Mannan MS. *Lees' Loss Prevention in the Process Industries: Hazard Identification, Assessment and Control*, 3rd ed. Burlington: Butterworth-Heinemann, 2005.

12. Sadiq R, Saint-Martin E, Kleiner Y. Predicting risk of water quality failures in distribution networks under uncertainties using fault-tree analysis. *Urban Water Journal*, 2008; 5(4):287–304.
13. Yuhua D, Datao Y. Estimation of failure probability of oil and gas transmission pipelines by fuzzy fault tree analysis. *Journal of Loss Prevention in the Process Industries*, 2005; 18(2):83–88.
14. Ferson S, Hajagos J, Berleant D, Zhang J, Tucker WT, Ginzburg L, et al. Dependence in Dempster-Shafer Theory and Probability Bounds Analysis. Sandia National Laboratories, 2004.
15. Tanaka H, Fan LT, Lai FS, Toguchi K. Fault-tree analysis by fuzzy probability. *IEEE Transactions on Reliability*, 1983; 32(5):453–457.
16. Misra KB, Weber GG. Use of fuzzy set theory for level-I studies in probabilistic risk assessment. *Fuzzy Sets and Systems*, 1990; 37(2):139–160.
17. Singer D. A fuzzy set approach to fault tree and reliability analysis. *Fuzzy Sets and Systems*, 1990; 34(2):145–155.
18. Kenarangui R. Event-tree analysis by fuzzy probability. *IEEE Transactions on Reliability*, 1991; 40(1):120–124.
19. Sawyer JP, Rao SS. Fault tree analysis of fuzzy mechanical systems. *Microelectronics Reliability*, 1994; 34(4):653–667.
20. Suresh PV, Babar AK, Raj VV. Uncertainty in fault tree analysis: A fuzzy approach. *Fuzzy Sets and Systems*, 1996; 83(2):135–141.
21. Rivera SS, Barón HH. Using fuzzy arithmetic in containment event trees. In *International Conference on Probabilistic Safety Assessment*, Washington, DC, 1999.
22. Huang D, Chen T, Wang MJJ. A fuzzy set approach for event tree analysis. *Fuzzy Sets and Systems*, 2001; 118(1):153–165.
23. Wilcox RC, Ayyub BM. Uncertainty Modeling of Data and Uncertainty Propagation for Risk Studies. Pp. 184–191 in *ISUMA '03: Proceedings of the 4th International Symposium on Uncertainty Modelling and Analysis*. Washington, DC: IEEE Computer Society, 2003.
24. Li H. Hierarchical Risk Assessment of Water Supply Systems. PhD Thesis. Department of Civil and Building Engineering, Loughborough University, Loughborough, UK, 2007.
25. Abrahamsson M. Uncertainty in Quantitative Risk Analysis—Characterisation and Methods of Treatment. Sweden: Lund University, Department of Fire Safety Engineering, Report No: 1024, 2002.
26. Skelton B. *Process Safety Analysis: An Introduction*. Warwickshire, UK: IChemE, 1997.
27. Thacker BH, Huysse LJ. Probabilistic assessment on the basis of interval data. *Journal of Structural Engineering and Mechanics*, 2007; 25(3):331–346.
28. Ayyub BM, Klir GJ. Uncertainty modeling and analysis in engineering and the sciences. Pp. 1–381 in Bilal M, Ayyub GJK (eds). *Uncertainty Modeling and Analysis in Engineering and the Sciences*. Boca Raton, FL: Chapman and Hall/CRC, 2006.
29. Agarwal H, Renaud JE, Preston EL, Padmanabhan D. Uncertainty quantification using evidence theory in multidisciplinary design optimization. *Reliability Engineering & System Safety*, 2004; 85(1–3):281–294.
30. Baraldi P, Zio E. A combined Monte Carlo and possibilistic approach to uncertainty propagation in event tree analysis. *Risk Analysis*, 2008; 28(5):1309–1326.
31. Druschel BR, Ozbek M, Pinder GF. Application of Dempster-Shafer theory to hydraulic conductivity. In *CMWR—XVI, Conference Program*, Copenhagen, Denmark, 2006.
32. Bae HR, Grandhi RV, Canfield RA. An approximation approach for uncertainty quantification using evidence theory. *Reliability Engineering & System Safety*, 2004; 86(3):215–225.
33. Zadeh LA. Fuzzy sets. *Information and Control*, 1965; 8(3):338–353.
34. Khan FI, Sadiq R. Risk-based prioritization of air pollution monitoring using fuzzy synthetic evaluation technique. *Environmental Monitoring and Assessment*, 2005; 105(1):261–283.
35. El-Idrissi A, Odum ER. Fuzzy probabilistic reliability assessment of repairable systems. Pp. 96–100 in *Conference of the North American Fuzzy Information Processing Society—NAFIPS (Cat. No.98TH8353)*, Pensacola Beach, FL: 1998.
36. Cheng YL. Uncertainties in fault tree analysis. *Tamkang Journal of Science and Engineering*, 2000; 3(1):23–29.
37. Lai FS, Shenoi S, Fan TL. Fuzzy fault tree analysis theory and applications. Pp. 117–137 in Kandel A, Avni E (eds). *Engineering Risk & Hazard Assessment*, vol. 1. Boca Raton, FL: CRC Press, 1988.
38. Siler W, Buckley JJ. *Fuzzy Expert Systems and Fuzzy Reasoning*. Hoboken, NJ: John Wiley & Sons, 2005.
39. Klir GJ, Yuan B. *Fuzzy Sets and Fuzzy Logic: Theory and Applications*, 1st ed. Upper Saddle River, NJ: Prentice Hall PTR, 1995.
40. Ross T. *Fuzzy Logic with Engineering Applications*. New York: McGraw-Hill, 1995.
41. Ross T. *Fuzzy Logic with Engineering Applications*, 2nd ed. West Sussex, UK: John Wiley & Sons, 2004.
42. Ayyub BM. *A Practical Guide on Conducting Expert-Opinion Elicitation of Probabilities and Consequences for Corps Facilities*. Alexandria, VA: Institute for Water Resources, IWR Report 01-R-1, 2001.
43. Sadiq R, Najjaran H, Kleiner Y. Investigating evidential reasoning for the interpretation of microbial water quality in a distribution network. *Stochastic Environmental Research and Risk Assessment*, 2006; 21(1):63–73.
44. Wang YM, Yang JB, Xu DL, Chin KS. On the combination and normalization of interval-valued belief structures. *Information Sciences: An International Journal*, 2007; 177(5):1230–1247.
45. Sentz K, Ferson S. *Combination of Evidence in Dempster-Shafer Theory*. Albuquerque, NH: Sandia National Laboratories, Sandia Report No: SAND2002-0835, 2002.
46. Lefevre E, Colot O, Vannoorenbergh P. Belief function combination and conflict management. *Information Fusion*, 2002; 3(2):149–162.
47. Smarandache F, Dezert J. Proportional conflict redistribution rules for information fusion. P. 461 in *Applications and Advances of DSMT for Information Fusion*, vol. 2. Rehoboth, MA: American Research Press, 2004.
48. Zadeh LA. In Fehling M (ed). *Reviews of Books*. Pp. 81–83 in *A Mathematical Theory of Evidence*, vol. 5. Menlo Park, CA: AI Magazine, 1984.
49. Yager RR. On the Dempster-Shafer framework and new combination rules. *Information Science*, 1987; 41(2):93–137.
50. Sadiq R, Kleiner Y, Rajani B. *Proof-of-Concept Model to Predict Water Quality Changes in Distribution Pipe Networks (Q-WARP)*. Denver, CO: Water Research Foundation, 2009.
51. *Relx Reliability Software V7.7*. Needham, MA: Relx Software Corporation, 2003.
52. *Reliability, Availability, Maintainability and Safety Software*. Israel: Advanced Logistics Development (ALD) Ltd., 2009.
53. Khan FI, Abbasi SA. PROFAT: A user friendly system for probabilistic fault tree analysis. *Process Safety Progress*, 1999; 18(1):42–49.