

Fault Detection and Classification with Optimization Techniques for a Three-Phase Single-Inverter Circuit

V. Gomathy[†] and S. Selvaperumal^{*}

^{†,*}Department of Electrical and Electronics Engineering, Syed Ammal Engineering College, Tamil Nadu, India

Abstract

Fault detection and isolation are related to system monitoring, identifying when a fault has occurred, and determining the type of fault and its location. Fault detection is utilized to determine whether a problem has occurred within a certain channel or area of operation. Fault detection and diagnosis have become increasingly important for many technical processes in the development of safe and efficient advanced systems for supervision. This paper presents an integrated technique for fault diagnosis and classification for open- and short-circuit faults in three-phase inverter circuits. Discrete wavelet transform and principal component analysis are utilized to detect the discontinuity in currents caused by a fault. The features of fault diagnosis are then extracted. A fault dictionary is used to acquire details about transistor faults and the corresponding fault identification. Fault classification is performed with a fuzzy logic system and relevance vector machine (RVM). The proposed model is incorporated with a set of optimization techniques, namely, evolutionary particle swarm optimization (EPSO) and cuckoo search optimization (CSO), to improve fault detection. The combination of optimization techniques with classification techniques is analyzed. Experimental results confirm that the combination of CSO with RVM yields better results than the combinations of CSO with fuzzy logic system, EPSO with RVM, and EPSO with fuzzy logic system.

Key words: Cuckoo search optimization (CSO), Discrete wavelet transform (DWT), Evolutionary particle swarm optimization (EPSO), Fault detection, Fuzzy logic system, Optimization techniques, Principal component analysis (PCA), Relevance vector machine (RVM)

I. INTRODUCTION

Fault detection and classification are significant in the diagnostic system field to improve system reliability and safety. A circuit is referred as a faulty circuit when it exhibits continuous unexpected behavior. Two types of failure modes occur, namely, catastrophic and parametric faults. Catastrophic fault is the sudden and total failure of a system in which recovery is impossible. Parametric failure only shifts the device parameters and may manifest during stress testing. Different fault diagnosis approaches exist, such as approximation approach, artificial intelligence (AI) technique, fault dictionary approach, fault verification approach, and parameter identification (ID) approach. These approaches can be categorized into two types namely, simulation before testing and simulation after testing.

Different constraints are essential in formulating a fault dictionary. Such constraints are extracted from the operational circuit during simulation after testing.

A fault tolerance system consists of three major components, namely, component redundancy, fault detection and isolation system, and reconfiguration system. Fault diagnosis is a combination of fault detection and isolation. Primary detection of failure prevents damages and enhances fault tolerance.

Failure detection can guarantee the reliability and safety of a circuit. Faults can be categorized into several types, such as phase-to-ground fault, phase-to-phase fault, phase-phase-to-ground fault, and three-phase fault. Other faults in electricity are unimportant but are still considered for power system operation. These faults are open-circuit, inter-turn, and other faults. Among all types of failure in variable-speed AC drives in the industry, 38% are due to power device faults. Maximum inverters use insulated-gate bipolar transistors (IGBTs) as power devices because of their maximum voltage and current ratings, although they cause faults because of the

Manuscript received Sep. 12, 2015; accepted Jan. 24, 2016.

Recommended for publication by Associate Editor Kyo-Beum Lee.

[†]Corresponding Author: gomathyvelmayil@gmail.com

Tel: +914567304156, Fax: +914567304123

^{*}Department of Electrical and Electronics Engineering, Syed Ammal Engineering College, India

excess electrical pressure with many applications.

In this study, novel fault detection and classification techniques are developed, and optimization techniques are analyzed. DWT and PCA are incorporated to extract features from a three-phase inverter circuit. This scheme incorporates most of the processes that have to be conducted during the training phase. The database constructed in this step is called a fault dictionary. Fuzzy logic (FL) system and relevance vector machine (RVM) are utilized for efficient fault classification. Optimization techniques, such as evolutionary particle swarm optimization (EPSO) and cuckoo search optimization (CSO), are applied to validate the proposed fault detection system with classification methods. Four combinations of EPSO and CSO with RVM and fuzzy are analyzed to identify the resultant optimization with classification techniques. The novel contribution of this study is that it integrates optimization with classification techniques to detect faults in a three-phase single-inverter circuit.

The remainder of this paper is organized as follows. Section 2 summarizes the related work in fault detection and classification techniques. Section 3 describes the proposed system. Section 4 presents the performance analysis, and Section 5 provides the conclusion and directions for future work.

II. RELATED WORK

Several methods of fault detection in power systems have been proposed in recent years. Examples of these techniques are bridge circuit method [1], surface wave [2, 3], Petrinets [4], wavelet transform approach [5–10], neural network approach [11–13], AI [14], graph methodology [15], real time [16], and statistical methodology. Singh et al. presented a method for software fault prediction at the design phase. Various software metrics related to module-level faults were utilized to predict fault-prone modules [17]. Medoued et al. classified induction machine faults based on time–frequency representation and particle swarm optimization (PSO). Feature vector size was optimized with the PSO algorithm. A classifier was designed based on artificial neural network [18]. Kong et al. formulated fault-tolerant control for a five-phase induction motor under a single-phase open circuit. Control methods were developed based on the third harmonic current injection [19].

Uppendar et al. proposed a statistical-decision-tree-based fault classification methodology for the protection of power transmission lines. The algorithm was based on the wavelet transform of three-phase current, which was measured with classification and regression tree methods. Wavelet transform generated hidden information about the fault situation. The hidden information was provided as the input for the classification and regression tree algorithms and was used to categorize fault types [20]. Tang et al. formulated a support

vector machine (SVM) based on chaos PSO. A multi-fault classification system was established and proven to be functional for the fault diagnosis of rotating machines [21]. Weiqiang et al. designed a generalized approach for intelligent fault detection and recovery in power electronic systems. Fault detection was based on the correlation between basic measurements and faults. For each power electronic component, open- and short-circuit faults were injected, and diverse voltage was observed. Intelligent control was utilized to engage redundant components to fault recovery [22]. Ding et al. presented fault detection and isolation filters for three-phase AC–DC electronic systems [23].

Chitaliya et al. proposed a feature extraction and classification process based on wavelet PCA and neural networks. DWT was applied to generate features from individual wavelet sub-bands. The wavelet coefficients were utilized as a feature vector for regular processing. PCA was used to reduce the dimensionality of the feature vector. The feature vector was utilized for classification based on Euclidean distance and neural network classifier [24]. Chitaliya et al. also introduced an efficient method for face feature extraction and recognition based on contour let transforms and PCA. Each face was decomposed based on contour let transform. The contour let coefficients at diverse scales and angles were observed for low and high frequencies. The frequency coefficients were used as a feature vector [25]. Estima et al. formulated an algorithm for real-time multiple-open-circuit fault diagnosis in voltage-fed pulse-width-modulated motor drives by reference current errors [26]. Ghimire et al. modeled an integrated and data-driven fault detection and diagnosis scheme for an automotive electric power-steering system [27].

Haddad et al. introduced a fault detection and classification scheme for permanent magnet synchronous machines. This scheme was based on fast Fourier transform (FFT) and linear discriminant analysis. Three types of faults, namely, demagnetization faults, inter-turn short circuit, and static eccentricity, were discussed. The machine was controlled based on three-phase current sources. The harmonics of stator voltage were used as features for the classifier of fault detection. 2D finite element analysis was applied to model the machine under strong and faulty conditions. Linear discriminant analysis was applied as a classification method, and the frequency spectrum was analyzed based on FFT [28]. Hu et al. presented a fault classification method for inverters. This scheme was based on hybrid SVMs and discrete orthogonal wavelet transform. A multi-class classification approach was utilized, which was based on the Huffman tree structure. Hybrid SVM was applied to the features to determine the fault type [29]. Jin et al. formulated a wavelet-based feature extraction approach based on probabilistic finite-state automata for pattern classification [30].

Liu et al. proposed a multi-fault classification method based on wavelet SVM with the PSO algorithm. The algorithms were implemented to analyze the vibration signals from rolling element bearings. The rolling elements were preprocessed through empirical model decomposition. A distance evaluation technique was applied to reduce redundant information and utilize the necessary features for the classification process [31]. Luo et al. proposed a support vector data description scheme of fuzzy classification for analog circuit fault diagnosis. Fractional wavelet transform was applied to extract fault features. Fault samples were preprocessed by implementing the fractional kernel matrix. Two methods were utilized with the genetic algorithm (GA) to obtain the optimal fractional order. A threshold value was also used to reduce the fuzzy region. Based on relative distance, fuzzy faults were diagnosed in fuzzy sets [32]. Malathi et al. formulated a model for fault classification in a series-compensated transmission line. This framework was based on multi-class SVM and multi-class extreme learning machine. These techniques use the information retrieved from wavelet decomposition for the current signal fault [33]. Masrur et al. designed a machine-learning technique to diagnose fault multi-levels. A neural network system was also designed to detect and isolate usual types of failures, such as short circuits, post short circuits, single-switch open-circuit faults, and unknown faults [34].

Ramkumar et al. proposed a GA-based selective harmonic elimination method for the optimization and critical evaluation of a three-level inverter. The method provided control over the harmonic spectrum, which was created by a power electronic converter. This scheme was based on the usage of AI algorithms, such as GA, for single-phase unipolar waveform [35]. Debnath et al. introduced harmonic elimination in a multi-level inverter. This method was based on the usage of GA and PSO algorithm. The total harmonic distortion for output voltage was reduced by maintaining the selected harmonics within allowable limits [36]. Upendar et al. presented a PSO-based approach of harmonic elimination and voltage control for pulse-width-modulated inverters. PSO was utilized to estimate switching pulses based on nonlinear equations. The output waveform was analyzed by Fourier transform. A single, three-phase inverter was established with respect to harmonic distortion by removing unwanted low-harmonic components. The designated feature performance was evaluated by the corresponding waveform [37]. Debnath et al. formulated a CSO algorithm for harmonic elimination in multi-level inverters [38].

III. FAULT DETECTION AND CLASSIFICATION WITH OPTIMIZATION METHODOLOGY

This section describes the fault detection in a three-phase inverter by applying several approaches. In existing systems, amplitude is obtained from phases, and absolute values are

checked with the threshold values. If the absolute value is above the threshold, then the system has no faults. Existing approaches do not effectively identify faults. Several data-mining techniques are applied to efficiently detect faults. Fault detection is an important part of the diagnostic system to guarantee the reliability and safety of the system under study. In this study, the fault analysis system deals with the prediction of faulty components/regions from the features of phase voltage and current. Prediction of faulty components allows for the identification of output signal variation to prevent damage to the load connected at the end of the inverter. This process provides safety to the connected load and precaution for the faulty components in the inverter system.

A circuit that exhibits continuous unexpected behavior is referred to as a faulty circuit. IGBT failures can be classified into intermittent gate-misfiring, open-circuit, and short-circuit faults. Each phase of the three-phase inverter circuit is analyzed based on wavelet transform. The standard deviation (SD) of the transform coefficients is fed as input to the classifier to identify the fault type. The main objectives of this study are listed below.

- To extract fault features from the phase voltage output of the inverter (the PCA–DWT method is accordingly proposed)
- To construct a fault dictionary using the extracted features
- To classify the inverter faults using a RVM classifier
- To optimize the classification accuracy using the CSO technique
- To validate the accuracy of the proposed CSO–RVM with existing techniques

The overall flow of the proposed fault detection and classification mechanism is depicted in Fig.2.

A. Inverter Model

Fig. 1 shows the basic structure of the three-phase voltage-source inverter. The inverter is utilized to convert DC to AC. The pulse-width modulation (PWM) technique is applied to control switches. The inverter comprises IGBT switches and has three phases, in which each phase has two switches. The intersective method is utilized to generate the PWM waveform. In this method, a triangle waveform is used as the reference signal. A comparator is required to compare the modulation waveform and reference signal. Inverter power faults are subdivided into short and open circuits. In the open-circuit fault condition, the IGBT remains off state. In most cases, short circuit causes overcurrent detected by the standard protection system, and shutdown is carried out. An open-circuit fault occurs because of the lifting of bonding wires caused by thermal cycling. Open-circuit faults do not cause system shutdown but degrade the system performance.

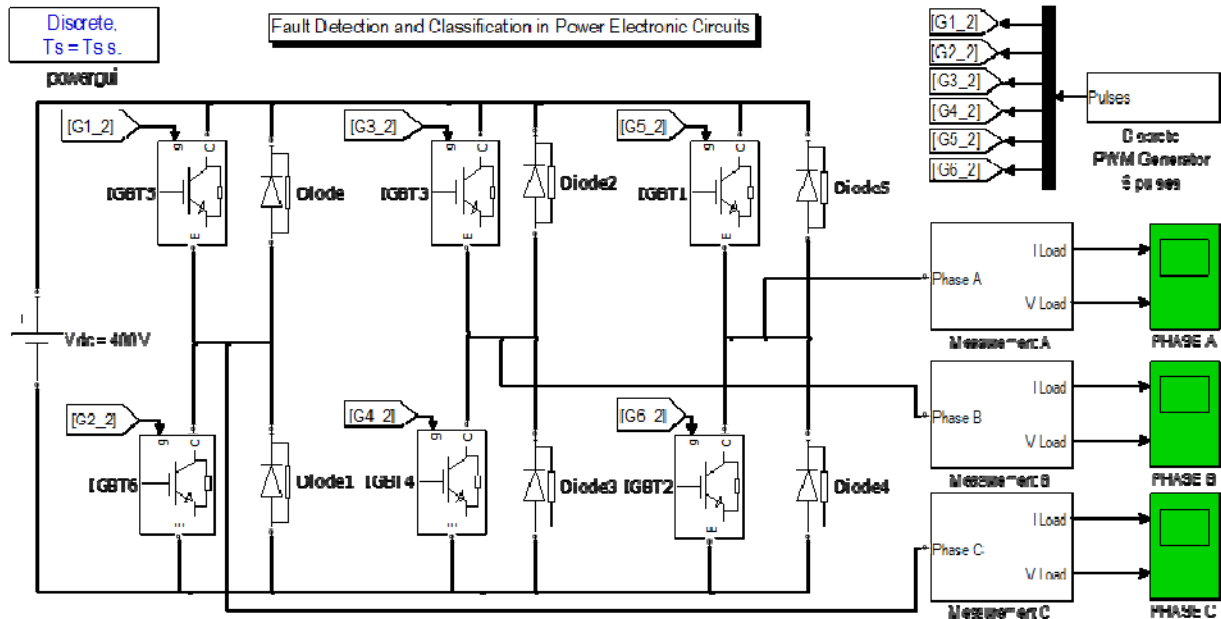

Fig. 1. Schematic of the three-phase inverter circuit.

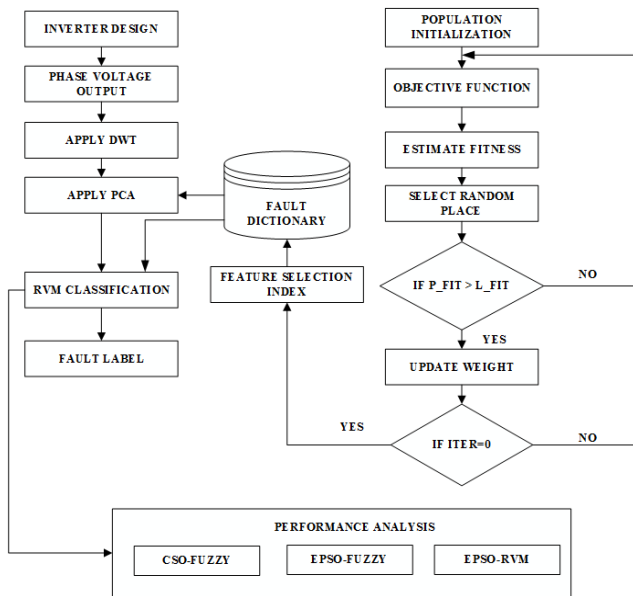

Fig. 2. Structure of the proposed fault detection and classification method.

The fault diagnosis method can be classified into the following steps.

1. Formulation of circuit under test (CUT) system, that is, a three-phase single-level inverter in this instance
2. Application of DWT and PCA for various fault conditions and non-faulty conditions
3. Construction of a fault dictionary by extracting the SD of the transform coefficients
4. Identification of fault type based on CUT parameters in FL and RVM classifiers

B. Feature Extraction Based on DWT and PCA

The feature extraction process is proposed to improve the difference in the current change between transistor-base-drive short- and open-circuit faults and other faults, such as intermittent misfiring across inverter switching devices, load disturbance, and single line-to-ground at the machine terminal. DWT and PCA are combined to perform the feature extraction process.

1) *DWT*: The DWT method is utilized to decompose an input signal of interest into a set of elementary waveforms called wavelets. Signals can be investigated by examining the wavelet coefficients. One of the key advantages of the wavelets is their capability to perform local analysis. A wavelet generally analyzes a localized area of a large signal. Compared with traditional signal-processing techniques, wavelets can produce optimal results in the areas of pattern analysis, breakdown point judgment, and discontinuity examination. Analysis and synthesis of the original signal also can be performed with reduced consumption time. The signals are analyzed by using filters at different frequencies and scales. Low- and high-pass filters are used in the analysis of low and high-frequency signals, respectively.

Wavelet transform is a method to analyze signals. DWT is a distinct case of wavelet transform that provides a dense representation of a signal that can be efficiently calculated. DWT is described as follows:

$$X(j, k) = \sum_j \sum_k x(k) 2^{-j/2} \Psi(2^{-j} n - k) \quad (1)$$

Where $x(k)$ denotes the input signal from three phases and $\Psi(t)$ is a time function with energy and decay termed mother wavelet.

The extracted wavelet coefficients provide a compact depiction that represents the energy distribution of the signal

TABLE I
 FAULT DICTIONARY

S.NO	Fault ID	Faulty Component
1	Fault in Phase 1	T1 open
2	Fault in Phase 1	T2 open
3	Fault in Phase 2	T3 open
4	Fault in Phase 2	T4 open
5	Fault in Phase 3	T5 open
6	Fault in Phase 3	T6 open
7	Fault in Phase 1	Line 1 open
8	Fault in Phase 2	Line 2 open
9	Fault in Phase 3	Line 3 open
10	Fault in Phase 1	T1 and T2 open
11	Fault in Phase 2	T3 and T4 open
12	Fault in Phase 3	T5 and T6 open
13	Fault in Phases 1 and 2	Lines 1 and 2 open
14	Fault in Phases 1 and 3	Lines 1 and 3 open
15	Fault in Phases 2 and 3	Lines 2 and 3 open
16	Fault in Phases 1, 2, and 3	Lines 1, 2, and 3 open
17	Fault in Phases 1 and 2	T1 and T3 open
18	Fault in Phases 2 and 3	T5 and T3 open
19	Fault in Phases 1 and 3	T1 and T5 open
20	Fault in Phases 1 and 2	T2 and T4 open
21	Fault in Phases 2 and 3	T4 and T6 open
22	Fault in Phases 1 and 3	T6 and T2 open
23	Fault in Phases 1, 2, and 3	Transistors open
24	Nil Fault	No fault
25	Fault in Phases 1, 2, and 3	Transistors and line open

based on time and frequency.

2) *PCA*: The optimal projection vectors of PCA, x_1, \dots, x_d , are used to extract features. The mean value of the “X” input obtained from DWT is computed using the following equation.

$$M = \frac{1}{N} \sum_{i=1}^N X_i \quad (2)$$

After the computation of the mean value, the difference between the input vector and the mean value is estimated using the following equation.

$$D = X - M \quad (3)$$

Covariance matrix “C” is generated for the mean difference data using the following equation.

$$C = \frac{1}{N-1} \sum_{i=1}^N (D_i - D_i^T) \quad (4)$$

From the covariance matrix, the Eigen vector is calculated as

$$V = \text{Eig}_{vec}(C) \quad (5)$$

The Eigen matrix is constructed based on the following equation,

$$S = \Sigma \text{Eig}_{Mat}(C) \quad (6)$$

By using the Eigen matrix, the projected features from PCA are obtained as follows:

$$Y_k = SX_k, \quad k=1, 2, \dots, d. \quad (7)$$

The family of projected feature vectors $Y_1 \dots Y_d$ is then obtained. These vectors are called principal component vectors of the sample.

C. Fault Dictionary Generation

The fault dictionary is defined as a database of faults utilized by simulators to determine the fault coverage. When a diagnostic system attempts to diagnose problems, it exploits the fault dictionary to analyze the types of faults. The SDs retrieved for all the three phases for different test faults are presented in Table I.

This table can be utilized as a fault dictionary during the classifier stage of diagnosis. The fault dictionary is then used for fault diagnosis by FL and RVM. In the table, T_1 refers to IGBT₁, T_2 refers to IGBT₂, and so on. Phase 1 denotes Line 1, Phase 2 denotes Line 2, and so on.

D. Fault Classification based on FL System and RVM

1) *FL System*: After generating the standardized peak values of the wavelet coefficients of fault signals, the FL system is used to categorize the fault types. The FL system is well suited to uncertain and fault classification problems. The fuzzy if-then rules for the class G pattern classification problem with k attributes can be stated as rule M_i . If x_1 is A_{i1} and x_k is A_{ik} , then class G_i , $i = 1, 2, \dots, K$, where $x = (x_1 \dots x_k)$ k-dimensional pattern vector A_{ij} is the antecedent linguistic value and K is the number of fuzzy if-then rules. The compatibility grade $\mu_i(x)$ of the fuzzy if-then rules P_i is provided by

$$\mu_i(x) = \min\{\mu_{i1}(x_1), \mu_{i2}(x_2), \dots, \mu_{in}(x_n)\} \quad (8)$$

where,

$\mu_{ij}(x_j)$ is the membership function of the antecedent linguistic value A_{ij} .

The feature vector database is expressed as follows:

$$\omega(t) = \omega_{high} - (\omega_{high} - \omega_{low}) \frac{t}{T_{high}} \quad (9)$$

where,

ω_{low} and ω_{high} are the desired higher and lower bounds of the inertia weight. T_{high} is the maximum allowed number of iterations after the algorithms complete the process. A time-dependent linearly decreasing value of inertia weight is usually considered to solve the global optimization problem.

2) *RVM*: Assuming that $p(m|x)$ is Gaussian $N(m | y(x), \sigma^2)$, the likelihood can be defined as

$$p(m | g, \sigma^2) = (2\pi\sigma^2)^{-N/2} \exp\left[-\frac{1}{2\sigma^2} \|m - \Psi g\|^2\right] \quad (10)$$

where,

g denotes the growth of the weight value utilized to learn the relationship between the training and testing datasets,

m represents the training feature points,

σ^2 denotes the variance of the Gaussian kernel,

ψ is the feature matrix with $\psi_{ba} = F(x_b, x_{a-1})$

$F(x_b, x_{a-1})$ represents the features of the input (x_b, x_{a-1})

x_b represents the row of the input matrix,

x_a represents the columns of the input matrix including the label column, and

x_{a-1} represents the columns of the input matrix excluding the label column.

An explicit zero mean Gaussian prior probability distribution across the weight is constrained as

$$p(m | \alpha) = \prod_{i=0}^N N(w_i | 0, \alpha_i^{-1}) \quad (11)$$

where,

α represents a parameter in the Gaussian distribution function.

When applying the features $F(x_b, x_{a-1})$ to the Gaussian kernel, the classification operation is performed.

3) *CSO*: Cuckoo search is an optimization algorithm that yields better solutions than existing techniques. A recent study [40] has shown that CSO is highly suitable for large-scale problems. Cuckoo search is also a reliable approach for embedded system design and design optimization [41]. A cuckoo egg denotes a new solution, and each host bird egg in a nest denotes a solution. The objective of this optimization is to replace the worst solution with a possibly better solution. Fig. 3 illustrates the overall process of the CSO algorithm, and the step-by-step procedure is explained below.

Three idealized rules are defined for CSO [42].

1. At one time, a cuckoo can lay only one egg and leaves it in a randomly selected nest.
2. The algorithm carries over the better nest with the best-quality solutions (eggs) to the next generations.
3. A host bird can determine a foreign egg (solution) with $P_a = [0, 1]$ probability.

The steps involved in the CSO algorithm is described below.

CSO Algorithm

4. **Step 1:** Initialization of the population
 5. **Step 2:** Cuckoo generation
 6. **Step 3:** Replacement
 7. **Step 4:** New nest generation
 8. **Step 5:** Termination
-

The first step in the CSO algorithm is the initialization of the population number. The user generally provides the

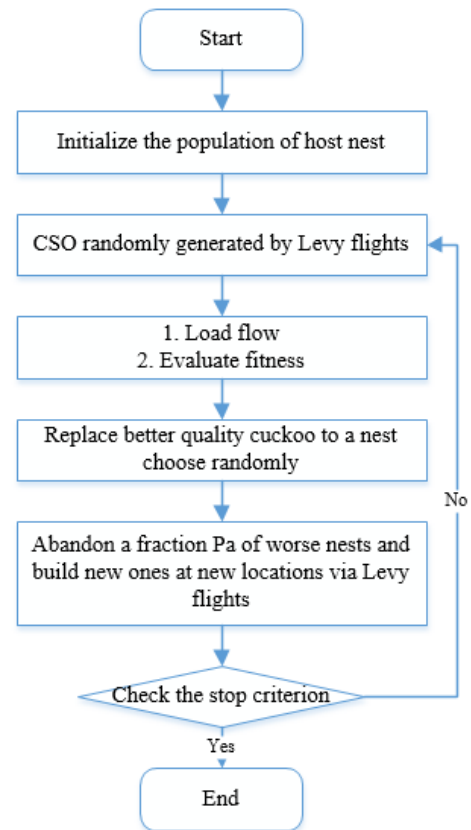

Fig. 3. CSO algorithm.

starting range for the population number. However, if the user does not provide the starting range, the CSO algorithm assumes a default value and initializes the population number. The second step in the CSO algorithm is cuckoo generation. The fixation of the initial population is based on the objective function. The proposed CSO algorithm exploits the Levy flight and generates the cuckoo randomly.

The quality of the generated solution is estimated using the objective function and the load flow. The third and fourth steps of the CSO algorithm are replacement and new nest generation, respectively. A new nest is randomly selected from the “n” number of population to replace the already existing solution with a new one. If the quality of the new solution is better than that of the existing solution, then the existing solution is replaced with the new solution. Based on the probability value (P_a), the low-quality nest is abandoned, and a new nest is built. The last step in the CSO algorithm is termination. After satisfying the stopping criteria, the iteration can be stopped, and the results of the CSO can be obtained.

The steps involved in the proposed RVM–CSO are elaborated below.

Algorithm for the Proposed RVM–CSO

Input: Feature matrix

Output: Updated cuckoo center that has the best fitness value

Step 1: Cuckoo initialization with the training features and the best selection point (BSP)

Step 2: Fitness value initialization using Eq. (12)

Step 3: Extraction of random center position of cuckoo using Eq. (13)

Step 4: Estimation of maximum weight using Eq. (14)

Step 5: Cuckoo egg generation using Eq. (15)

Step 6: Computation of the number of eggs laid in the allocated area

Step 7: Computation of cuckoo radius using Eq. (16)

Step 8: Updating of the cuckoo radius using Eq. (17)

Step 9: Updating of the maximum profit using Eq. (18)

Step 10: Construction of the cuckoo population and egg position set

Step 11: Checking of the updated maximum profit value with the already computed maximum profit

Step 12: Updating of the center and maximum profit values based on Eq. (19)

First, the proposed RVM-CSO initializes the training features $f(x)$ and BSP. BSP is a thresholding process. Second, RVM-CSO initializes the best fitness value using the equation

$$Best_{fit} = ((Var_{high} - Var_{low}) * Rand_{1,2,\dots, npar}) + Var_{low} \quad (12)$$

where,

Var_{high} denotes the high variance of $f(x)$,

Var_{low} represents the low variance of $f(x)$, and

$npar$ is the number of feature particles.

Third, the random center position of the cuckoo is initialized as follows:

$$CK_{center} = (f(x) * ((Var_{high} - Var_{low}) * Rand) + Var_{low}) \quad (13)$$

The maximum profit for the first iteration is estimated as follows:

$$Max_{weight} = 10 * size(f(x)) + \sum_{i=1}^N f(x) i^2 - (10 * \cos(2 * pi * f(x)_i)) \quad (14)$$

With Eq. (14) as the objective function, a cuckoo egg is generated as follows:

For $i = 1$ to Number of iterations

If ($i \leq Max_{iter}$) && ($Max_{weight} > BSP$)

$$Cuckoo_{Egg} = ((Egg_{Max} - Egg_{Min}) * Rand) + Egg_{Min} \quad (15)$$

The number of iterations ranges from 1 to 300. During each iteration, the maximum profit value is checked with the threshold BSP. If the computed profit value is higher than 0.9, cuckoo eggs are generated. The x and y coordinates of the cuckoo egg matrix are estimated using the following equations.

$$X_{Co-ordinate}(n) = x(n-1) + ((Rand^{\frac{1}{alpha}}) * \cos(Rand * 2 * pi))$$

$$Y_{Co-ordinate}(n) = y(n-1) + ((Rand^{\frac{1}{alpha}}) * \cos(Rand * 2 * pi)) \quad (16)$$

where,

$n=1, 2, \dots$ denotes the number of iterations.

With the Levy flight X and Y coordinate points, the cuckoo radius is redefined as follows:

$$Cuckoo_{Radius} = p(m) * (CK_{center} * (Var_{high} - Var_{low})) \quad (17)$$

where,

$P(m)$ is the probability of the number of eggs at each center location.

The radius of egg laying and the maximum profit are updated using the following equations.

$$Radius_{Update}(l) = (-1)^{Rand_{0,1}} * Radius_{Pre} * \cos(Radius_{Num} * (\frac{2}{Radius_{Num} - 1}) + Radius_{Pre} * \sin(Radius_{Num} * (\frac{2}{Radius_{Num} - 1})) \quad (18)$$

$$Max\ Pr o_update = 10 * size(C(x)) + \sum_{i=1}^N C(x) i^2 - (10 * \cos(2 * pi * C(x)_i)) \quad (19)$$

After updating the radius and the maximum profit value, the pre-computed maximum profit value is compared with the updated maximum profit value. If the updated maximum profit value is greater than the pre-computed maximum profit value, the maximum profit and cuckoo center are updated to the new position.

If ($Max_{Pr o_update} > Max_{Pr o}$)

Update $Max_{Pr o_update}$;

Update CK_{center} to New Position

End

The updated profit and cuckoo center are clustered until the iteration size is reached. After the last iteration, the updated cuckoo center is provided as the best fitness value output.

In our proposed work, the feature matrix is provided as input. Cuckoo is initialized, which provides training features and the accuracy value. The center position of the cuckoo is extracted by using equations. The initial fitness value is extracted, and the maximum profit of the initial iteration is estimated to extract cluster formation. Iteration is performed to estimate the number of eggs laid in an allocated area. In the abovementioned algorithm, Var_{high} denotes the high-

TABLE II
HARDWARE SPECIFICATIONS

Specification	Units
Rated Voltage	240 V
Rated Current	5 A
Frequency	50 Hz
Resistive Load, (R in Ω)	10 Ω
Inductive Load (L in H)	0.71469 H
Number of IGBT Gates	6

TABLE III
PARAMETER SPECIFICATION OF THE IGBTs

Internal Resistor	Snubber Resistance	VCE	Forward Voltage
1E-3 Ω	1E5 Ω	0.8 V	1 V

variable limit and Var_{low} represents the low-variable limit. Rand indicates the random value, which ranges from 0 to 2.

IV. PERFORMANCE ANALYSIS

The hardware specifications required for the experimental analysis are represented in Table II.

The parameter specification of the IGBTs is depicted in Table III. The voltages across phases A, B, and C of the inverter circuit are considered input for the evaluation procedure. The input voltage for the three-phase inverter circuit ranges from 230 V to 300 V AC supply. The proposed fault detection and classification mechanisms are validated with existing techniques, such as EPSO–fuzzy, EPSO–RVM, and CSO–fuzzy, to prove their superiority. Optimization techniques, such as EPSO and CSO, optimize the input features of the three-phase inverter circuit. Based on fuzzy rules, the optimized results are classified to identify the fault type in the inverter circuit. The fault conditions for the three-phase inverter circuit are analyzed, and a fault dictionary is formulated. The output signal for the non-faulty conditions of phases A, B, and C is shown in Fig. 4.

The output voltage waveform of phases A, B, and C corresponding to an open-circuit fault is shown in Fig. 5. In this experiment, an open-circuit fault occurs in phase A.

The output voltage waveform of phases A, B, and C corresponding to a short-circuit fault is shown in Fig. 6. In this experiment, a short-circuit fault occurs in phase A. The DWT with PCA projection for a short-circuit fault is shown in Fig. 7. Each projection varies with a phasor angle value of 120°. A fault occurs in phase A because of the inconsistent phasor angle value. Fig. 8 shows the coordinate value observed for the three-phase inverter circuit. Fig. 9 presents the statistical analysis of the wavelet and PCA techniques.

Fig. 10 shows the confusion matrix for the proposed fault detection and classification method. Table IV presents the comparative results of the inverter circuit fault without the

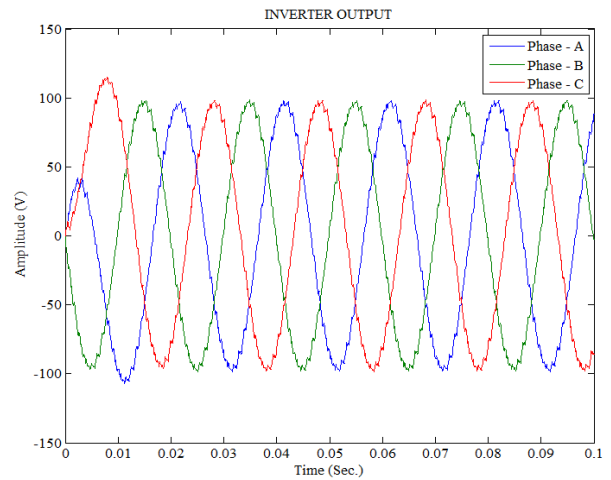

Fig. 4. Output signal for the non-faulty conditions of phases A, B, and C.

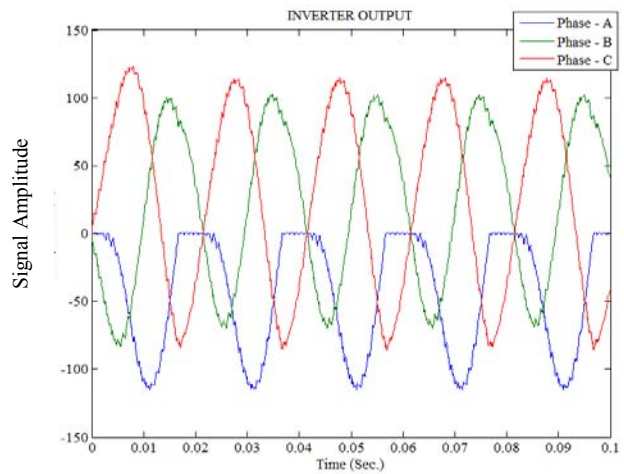

Fig. 5. Output voltage waveform for phase A for an open-circuit fault.

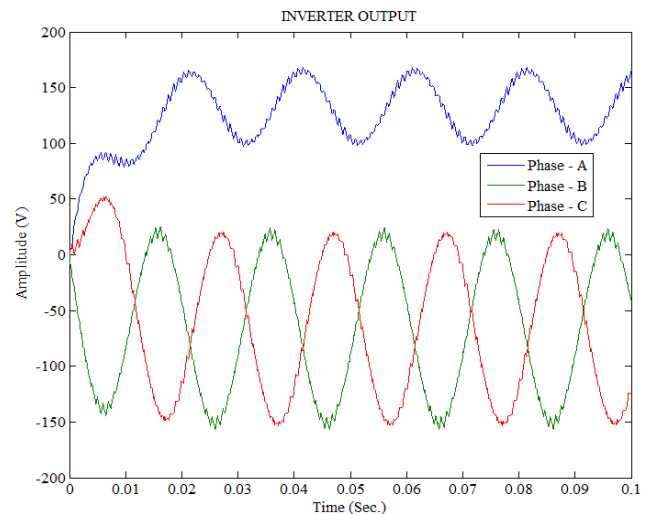

Fig. 6. Output voltage waveform for phase A for a short-circuit fault.

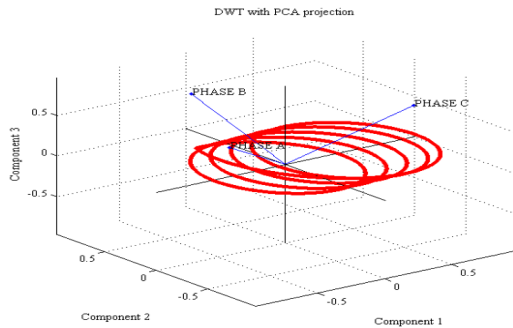

Fig. 7. DWT with PCA projection for a short-circuit fault.

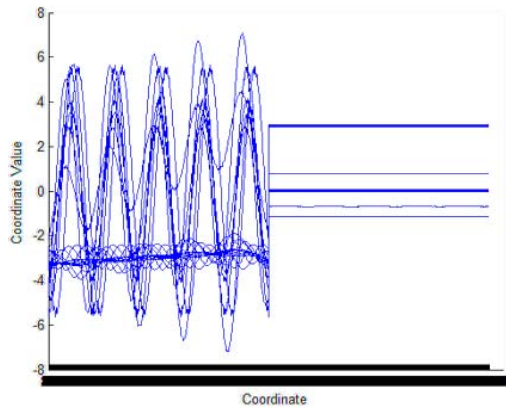

Fig. 8. Wavelet and PCA graph for phases A, B, and C.

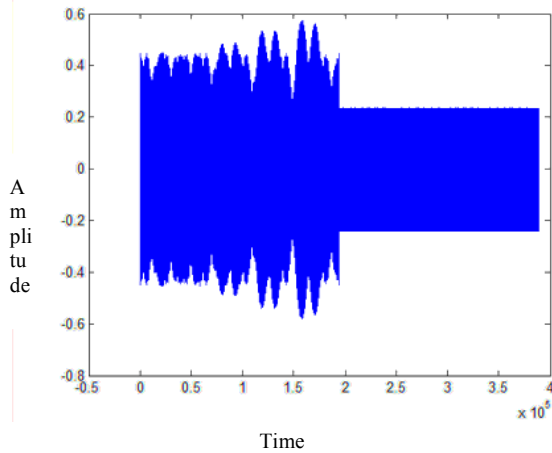

Fig. 9. Statistical analysis of the wavelet and PCA graph for phases A, B, and C.

optimization techniques. Table V defines the values observed for the optimization techniques with the classification techniques.

Table V shows that the combination of CSO-RVM achieves better accuracy, SD, and time than the three other combinations, namely, EPSO-RVM, EPSO-fuzzy, and CSO-fuzzy. The values are graphically shown in Figs. 10 to 12. Fig. 11 and 12 show the comparison of classification without optimization techniques (RVM and fuzzy) and classification with optimization techniques, namely, EPSO

Confusion Matrix

	1	2	3	4	
1	1 25.0%	0 0.0%	0 0.0%	1 25.0%	50.0% 50.0%
2	0 0.0%	1 25.0%	0 0.0%	0 0.0%	100% 0.0%
3	0 0.0%	0 0.0%	1 25.0%	0 0.0%	100% 0.0%
4	0 0.0%	0 0.0%	0 0.0%	0 0.0%	NaN% NaN%
	100% 0.0%	100% 0.0%	100% 0.0%	0.0% 100%	75.0% 25.0%
	1	2	3	4	
	Target Class				

Fig. 10. Illustration of the confusion matrix.

TABLE IV
COMPARATIVE RESULTS OF THE INVERTER CIRCUIT FAULT ANALYSIS WITHOUT OPTIMIZATION FOR TRAINING (30%) AND TESTING (70%)

Techniques	Trainin	Testing		
	g	Accuracy	SD	Time (s)
	Time (s)	%		
RVM	1.46	92.5000	176.83	0.43
Fuzzy	1.6337	87.0228	169.97	0.46

TABLE V
COMPARATIVE RESULTS OF THE INVERTER CIRCUIT FAULT ANALYSIS WITH OPTIMIZATION FOR TRAINING (30%) AND TESTING (70%)

Techniques	Trainin	Testing		
	g	Accurac	SD	Time (s)
	Time (s)	y %		
EPSO-RVM	14.28	84.18	172.62	2.20
EPSO-Fuzzy	16.22	85.66	181.27	2.20
CSO-RVM	12.51	88.78	296.32	0.57
CSO-Fuzzy	8.4	82.53	177.19	1.16

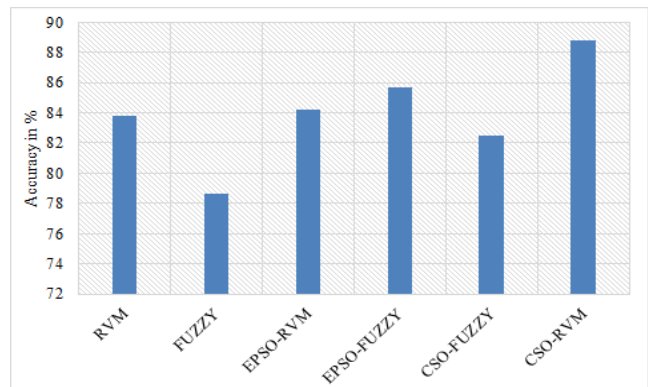

Fig. 11. Comparison of the classification with and without optimization techniques for accuracy.

with RVM, EPSO with fuzzy, CSO with fuzzy, and CSO with RVM, for accuracy and SD, respectively.

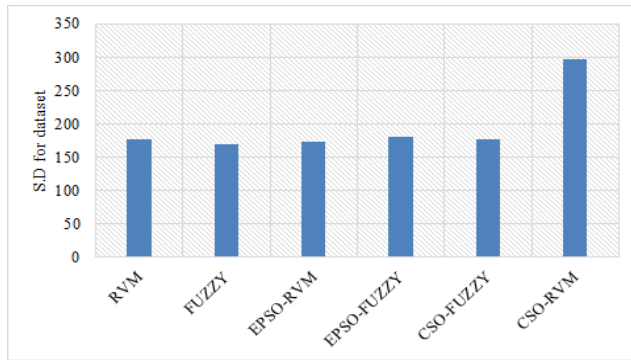

Fig. 12. Comparison of the classification with and without optimization techniques for SD.

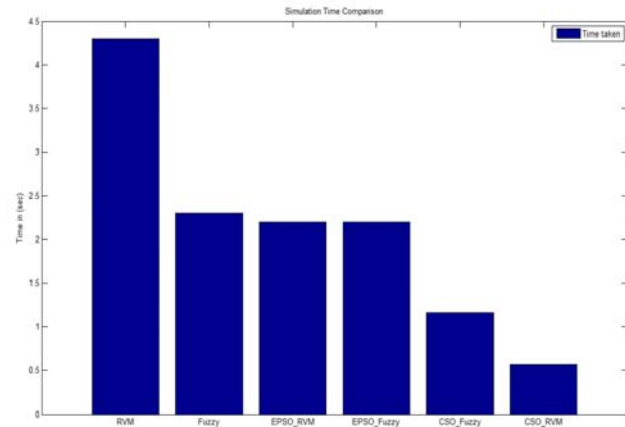

Fig. 13. Comparison of time with and without optimization techniques for SD.

TABLE VI
COMPARISON OF THE PROPOSED CSO METHOD WITH EXISTING SYSTEMS FOR THE FEATURE SELECTION PROCESS

Methods	No. of Selected Features
Without Optimization	19441
EPSO	528
CSO	162

The result shows that the combination of CSO with RVM can provide better accuracy and SD than the above-mentioned techniques. Fig. 13 shows the time comparison between classification with and without optimization techniques. The combination of CSO with RVM requires less time to detect the faulty condition than existing techniques. Table VI shows the number of features selected in the proposed and existing systems. Table VII presents the comparative results between the proposed CSO–RVM and existing techniques, namely, FL, MLP, RBF, and SVM classification [43]. FL approaches require human expertise to form a decision-making system.

They need considerable knowledge that should be constructed manually. Hence, a stable solution is difficult

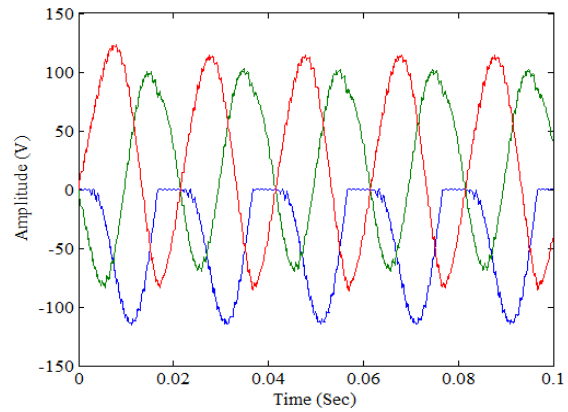

Fig. 14. Faulty waveform for the T1 transistor.

TABLE VII
COMPARISON OF THE PROPOSED CSO–RVM METHOD WITH EXISTING AI SYSTEMS

Techniques	Accuracy (%)
FL	86.7
Multi-layer Perceptron (MLP)	80
Radial Basis Function (RBF)	86.7
SVM	90
CSO–RVM	95.67

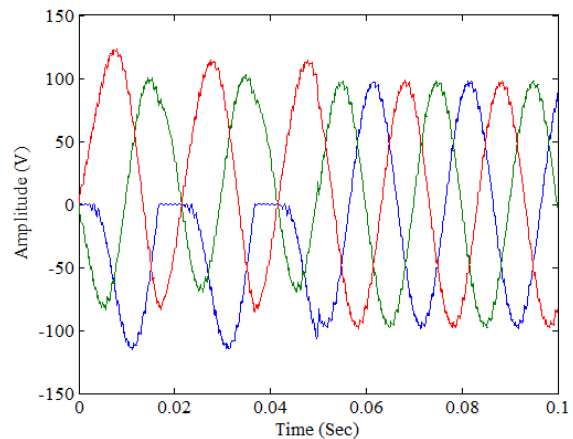

Fig. 15. Fault prediction and rectification by traditional methods.

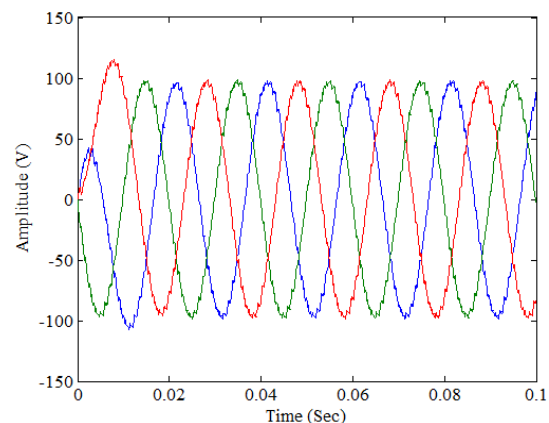

Fig. 16. Fault prediction and rectification by the CSO–RVM method.

TABLE VIII
COMPARISON OF THE CLASSIFICATION WITH AND WITHOUT OPTIMIZATION TECHNIQUES

Techniques	Training (%)	Testing (%)	Switching states						Training Time (s)	Testing		
			T1	T2	T3	T4	T5	T6		Accuracy %	SD	Time (s)
RVM	80	20	N	N	N	N	N	N	32.15	91.6%	293.93	6.55
	90	10	O	N	N	N	N	N	33.42	92.50%	299.25	7.25
Fuzzy	80	20	S	N	N	N	N	N	34.957	86.27	288.12	4.5
	90	10	N	O	N	N	N	N	43.806	87.02	289.42	6.2
EPSO-RVM	80	20	N	S	N	N	N	N	32.22	90.07	291.10	4.44
	90	10	N	N	O	N	N	N	40.58	94.37	297.44	6.14
EPSO-Fuzzy	80	20	N	N	S	N	N	N	27.51	91.24	295.56	3.34
	90	10	N	N	N	O	N	N	37.54	94.86	297.15	4.47
CSO-Fuzzy	80	20	N	N	N	S	N	N	25.41	90.39	293.03	3.43
	90	10	N	N	N	N	O	N	37.15	94.74	289.65	5.47
CSO-RVM	80	20	N	N	N	N	S	N	29.10	92.07	299.87	1.43
	90	10	N	N	N	N	N	O	38.47	95.67	305.71	2.06

to obtain. MLP and RBF also require a large amount of training data and need to adjust the parameters of the hidden activation function. An optimization solution with classification techniques should be introduced to overcome the drawbacks of existing methods. The optimization technique results in discriminant features for classification.

Hence, we evaluate the best four combinations of classification and optimization techniques. Among the combinations, CSO-RVM is the most efficient in determining faults in three-phase single-inverter circuits. The proposed CSO-RVM method results in better accuracy compared with existing methods. Table VIII shows the comparison of the classification with and without optimization techniques for the training and testing phases with the corresponding switching states. The switching states are similar for all results. The faulty waveform for the T1 transistor is depicted in Fig.14. The change in the amplitude with respect to varying time is depicted in Fig.14. The change in the amplitude with respect to the varying time is analyzed. The fault prediction and rectification by the existing traditional methods are depicted in Fig.15. The fault prediction and rectification by the proposed CSO-RVM method is depicted in Fig.16. From Fig.15 and 16 it is clear that the proposed CSO-RVM provides optimal fault prediction and rectification results than the traditional methods.

V. CONCLUSION AND FUTURE WORK

In this study, an effective methodology was developed for fault detection and classification with optimization techniques in a three-phase inverter circuit. Twenty-five faulty components exist, which are included in the proposed fault dictionary to describe faults and their corresponding conditions. The performance of the classification with optimization techniques such as EPSO with RVM, EPSO with fuzzy, CSO with RVM, and CSO with fuzzy are

analyzed. The analysis results prove that the combination of CSO with RVM provides better results than the others during the training and testing phases to detect faulty conditions. Compared with existing methods, the proposed CSO-RVM method provides optimal feature selection, higher fault classification accuracy, minimal time consumption for training and testing processes, and optimal prediction and fault rectification capability. CSO and RVM successfully solve the optimization problem in power systems and minimize the losses and the voltage control problem in the said systems. These optimization techniques easily achieve a solution for complex problems in which existing techniques present difficulties in converging. CSO-RVM also exhibits better performance than existing AI systems in terms of accuracy. In future, faults could be detected in transmission lines based on classification and optimization techniques. The size of the fault dictionary could also be increased.

List of Acronyms

DWT	Discrete Wavelet Transform
PCA	Principal Component Analysis
RVM	Relevance Vector Machine
EPSO	Evolutionary Particle Swarm Optimization
CSO	Cuckoo Search Optimization
IGBT	Insulated-gate Bipolar Transistor
CPSO	Chaos Particle Swarm Optimization
FFT	Fast Fourier Transform
SVDD	Support Vector Data Description
PWM	Pulse-width Modulation
CUT	Circuit Under Test
BSP	Best Selection Point
FL	Fuzzy Logic
MLP	Multi-layer Perceptron
RBF	Radial Basis Function

REFERENCES

- [1] A. Dong, L. Li, L. Huo, and Q. Wang, "Research on the practical detection for a power cable fault point," in *International Conference on Computer and Communication Technologies in Agriculture Engineering(CCTAE)*, Vol. 2, pp. 80-84, Jun. 2010.
- [2] M. N. Alam, R. H. Bhuiyan, R. Dougal, and M. Ali, "Novel surface wave exciters for power line fault detection and communications," in *IEEE International Symposium on Antennas and Propagation(APSURSI)*, pp. 1139-1142, Jul. 2011.
- [3] M. N. Alam, R. H. Bhuiyan, R. A. Dougal, and M. Ali, "Design and application of surface wave sensors for nonintrusive power line fault detection," *IEEE Sensors J.*, Vol. 13, No. 1, pp. 339-347, Jan. 2013.
- [4] A. Ashouri, A. Jalilvand, R. Noroozian, and A. Bagheri, "A new approach for fault detection in digital relays-based power system using Petri nets," in *2010 Joint International Conference on Power Electronics, Drives and Energy Systems (PEDES) & 2010 Power India*, pp. 1-8, Dec. 2010.
- [5] R. Dubey, S. R. Samantaray, A. Tripathy, B. C. Babu, and M. Ehtesham, "Wavelet based energy function for symmetrical fault detection during power swing," in *2012 Students Conference on Engineering and Systems (SCES)*, pp. 1-6, Mar. 2012.
- [6] H. Shu, X. Wang, X. Tian, Q. Wu, and P. Shixin, "On the use of s-transform for fault feeder detection based on two phase currents in distribution power systems," in *2nd International Conference on Industrial and Information Systems (IIS)*, Vol. 2, pp. 282-287, Jul. 2010.
- [7] Z. Long, N. H. Younan, and T. O. Bialek, "Underground power cable fault detection using complex wavelet analysis," in *International Conference on High Voltage Engineering and Application(ICHVE)*, pp. 59-62, Sep. 2012.
- [8] I.-D. Nicolae, P.-M. Nicolae, and L.-D. Popa, "Abilities of a class of wavelet hybrid algorithms related to fault detection in power systems," in *International Conference on Applied and Theoretical Electricity (ICATE)*, pp. 1-6, Oct. 2012.
- [9] S. R. Samantaray, B. K. Panigrahi, and P. K. Dash, "High impedance fault detection in power distribution networks using time-frequency transform and probabilistic neural network," *IET generation, transmission & Distribution*, Vol. 2, No. 2, pp. 261-270, Mar. 2008.
- [10] Y. Xiaohua, Z. Yadong, C. Z. Faqi, and X. Zhongmei, "Wavelet neural network based fault detection method in power system," in *Second International Conference on Mechanic Automation and Control Engineering(MACE)*, pp. 1864-1867, Jul. 2011.
- [11] K. L. V. Iyer, X. Lu, K. Mukherjee, and N. C. Kar, "Fault detection in copper-rotor SEIG system using artificial neural network for distributed wind power generation," in *XXth International Conference on Electrical Machines(ICEM)*, pp. 1700-1705, Sep. 2012.
- [12] G. Rigatos, P. Siano, and A. Piccolo, "Incipient fault detection for electric power transformers using neural modeling and the local statistical approach to fault diagnosis," in *IEEE Sensors Applications Symposium (SAS)*, pp. 1-6, Feb. 2012.
- [13] S. R. Samantaray, P. K. Dash, and S. K. Upadhyay, "Adaptive Kalman filter and neural network based high impedance fault detection in power distribution networks," *International Journal of Electrical Power & Energy Systems*, Vol. 31, No. 4, pp. 167-172, May 2009.
- [14] M. Z. A. El-Hamed, M. Zaki, W. El-Khattam, and R. El-Sharkawy, "Self-healing restoration of a distribution system using hybrid fuzzy control/ant-colony optimization algorithm," in *3rd International Conference on Electric Power and Energy Conversion Systems(EPECS)*, pp. 1-6, Oct. 2013.
- [15] D. Dustegor, S. V. Poroseva, M. Y. Hussaini, and S. Woodruff, "Automated graph-based methodology for fault detection and location in power systems," *IEEE Trans. Power Del.*, Vol. 25, No. 2, pp. 638-646, Apr. 2010.
- [16] J. Ghorbani, M. A. Choudhry, and A. Feliachi, "Real-time multi agent system modeling for fault detection in power distribution systems," in *North American Power Symposium (NAPS)*, pp. 1-6, Sep. 2012.
- [17] P. Singh, S. Verma, and O. Vyas, "Software fault prediction at design phase," *Journal of Electrical Engineering and Technology*, Vol. 9, No. 5, pp. 1739-1745, 2014.
- [18] A. Medoued, A. Lebaroud, A. Laifa, and D. Sayad, "Classification of induction machine faults using time frequency representation and particle swarm optimization," *Journal of Electrical Engineering and Technology*, Vol. 9, No. 1, pp. 170-177, 2014.
- [19] W. Kong, J. Huang, M. Kang, B. Li, and L. Zhao, "Fault-tolerant control of five-phase induction motor under single-phase open," *Journal of Electrical Engineering & Technology*, Vol. 9, No. 3, pp. 899-907, 2014.
- [20] J. Upendar, C. P. Gupta, and G. K. Singh, "Statistical decision-tree based fault classification scheme for protection of power transmission lines," *International Journal of Electrical Power & Energy Systems*, Vol. 36, No. 1, pp. 1-12, Mar. 2012.
- [21] X. Tang, L. Zhuang, J. Cai, and C. Li, "Multi-fault classification based on support vector machine trained by chaos particle swarm optimization," *Knowledge-Based Systems*, Vol. 23, No. 5, pp. 486-490, Jul. 2010.
- [22] W. Chen and A. M. Bazzi, "A generalized approach for intelligent fault detection and recovery in power electronic systems," in *IEEE Energy Conversion Congress and Exposition (ECCE)*, pp. 4559-4564, Sep. 2013.
- [23] X. Ding, J. Poon, I. Celanovic, and A. D. Dominguez-Garcia, "Fault detection and isolation filters for three-phase AC-DC power electronics systems," *IEEE Trans. Circuits Syst. I, Reg. Papers*, Vol. 60, No. 4, pp. 1038-1051, Mar. 2013.
- [24] N. G. Chitaliya and A. I. Trivedi, "Feature extraction using wavelet-PCA and neural network for application of object classification & face recognition," in *Second International Conference on Computer Engineering and Applications (ICCEA)*, Vol. 1, pp. 510-514, Mar. 2010.
- [25] N. G. Chitaliya and A. I. Trivedi, "An efficient method for face feature extraction and recognition based on contourlet transforms and principal component analysis," *Procedia Computer Science*, Vol. 2, pp. 52-61, 2010.
- [26] J. O. Estima and A. J. M. Cardoso, "A new algorithm for real-time multiple open-circuit fault diagnosis in voltage-fed PWM motor drives by the reference current errors," *IEEE Trans. Ind. Electron.*, Vol. 60, No. 8, pp. 3496-3505, Aug. 2013.
- [27] R. Ghimire, C. Sankavaram, A. Ghahari, K. Pattipati, Y. Ghoneim, and M. Howell, "Integrated model-based and data-driven fault detection and diagnosis approach for an automotive electric power steering system," in *IEEE AUTOTESTCON*, pp. 70-77, Sep. 2011.
- [28] R. Z. Haddad and E. G. Strangas, "Fault detection and classification in permanent magnet synchronous machines using fast fourier transform and linear discriminant

- analysis,” in *9th IEEE International Symposium on Diagnostics for Electric Machines, Power Electronics and Drives (SDEMPED)*, pp. 99-104, Aug. 2013.
- [29] Z.-K. Hu, W.-H. Gui, C.-H. Yang, P.-C. Deng, and S. X. Ding, “Fault classification method for inverter based on hybrid support vector machines and wavelet analysis,” *International Journal of Control, Automation and Systems*, Vol. 9, pp. 797-804, Aug. 2011.
- [30] X. Jin, S. Gupta, K. Mukherjee, and A. Ray, “Wavelet-based feature extraction using probabilistic finite state automata for pattern classification,” *Pattern Recognition*, Vol. 44, No. 7, pp. 1343-1356, Jul. 2011.
- [31] Z. Liu, H. Cao, X. Chen, Z. He, and Z. Shen, “Multi-fault classification based on wavelet SVM with PSO algorithm to analyze vibration signals from rolling element bearings,” *Neurocomputing*, Vol. 99, pp. 399-410, Jan. 2013.
- [32] H. Luo, J. Cui, and Y. Wang, “A SVDD approach of fuzzy classification for analog circuit fault diagnosis with FWT as preprocessor,” *Expert Systems with Applications*, Vol. 38, No. 8, pp. 10554-10561, Aug. 2011.
- [33] V. Malathi, N. S. Marimuthu, and S. Baskar, “A comprehensive evaluation of multicategory classification methods for fault classification in series compensated transmission line,” *Neural Computing and Applications*, Vol. 19, No. 4, pp. 595-600, Jun. 2010.
- [34] M. A. Masrur, Z. H. Chen, and Y. L. Murphey, “Intelligent diagnosis of open and short circuit faults in electric drive inverters for real-time applications,” *IET Power Electronics*, Vol. 3, No. 2, pp. 279-291, Mar. 2009.
- [35] S. Ramkumar, V. Kamaraj, and S. Thamizharasan, “GA based optimization and critical evaluation SHE methods for three-level inverter,” in *1st International Conference on Electrical Energy Systems (ICEES)*, pp. 115-121, Jan. 2011.
- [36] S. Debnath and R. N. Roy, “Harmonic elimination in multilevel inverter using Ga and Pso: a comparison,” in *IEEE Students' Conference on Electrical, Electronics and Computer Science*, Mar. 2012.
- [37] J. Uppendar, G. K. Singh, and C. P. Gupta, “A particle swarm optimisation based technique of harmonic elimination and voltage control in pulse-width modulated inverters,” *International Journal of Bio-Inspired Computation*, Vol. 2, No. 1, pp. 18-26, 2010.
- [38] S. Debnath and R. N. Ray, “Cuckoo search: a new optimization algorithm for harmonic elimination in multilevel inverter,” *Journal of Bioinformatics and Intelligent Control*, Vol. 1, No. 1, pp. 80-85, Jun. 2012.
- [39] S. A. Jumaat, I. Musirin, M. M. Othman, and H. Mokhlis, “Evolutionary particle swarm optimization (EPSO) based technique for multiple SVCs optimization,” in *IEEE International Conference on Power and Energy (PECon)*, pp. 183-188, Dec. 2012.
- [40] E. R. Speed, “Evolving a Mario agent using cuckoo search and softmax heuristics,” in *International IEEE Consumer Electronics Society's Games Innovations Conference (ICE-GIC)*, pp. 1-7, Dec. 2010.
- [41] A. Kumar and S. Chakarverty, “Design optimization using genetic algorithm and cuckoo search,” in *IEEE International Conference on Electro/Information Technology (EIT)*, pp. 1-5, May 2011.
- [42] X.-S. Yang and S. Deb, “Engineering optimisation by cuckoo search,” *International Journal of Mathematical Modelling and Numerical Optimisation*, Vol. 1, No. 4, pp. 330-343, 2010.
- [43] K. Bacha, S. Souahlia, and M. Gossa, “Power transformer fault diagnosis based on dissolved gas analysis by support

vector machine,” *Electric Power Systems Research*, Vol. 83, No. 1, pp. 73-79, Feb. 2012.



V. Gomathy received her master's degree in power Electronics and Drives from Government College of Engineering, Tirunelveli, India. She is a Ph.D. scholar in the Department of Electrical and Electronics Engineering at Syed Ammal Engineering College, Ramanathapuram, India. Her research interests include Soft Computing, Intelligent Controllers and Power Quality Management.



S. Selvaperumal received his Ph.D. degree in Electrical Engineering, from Anna University, Chennai, Tamil Nadu, India. He has presented many papers in National and International conferences and has published papers in many international Journals including IEEE Transactions and IET. He is currently Professor and Head (PG Studies) at the Department of Electrical and Electronics Engineering, Syed Ammal Engineering College. His research interests include power electronics, DC-DC converters, UPFC, power systems, and stability analysis.