

# **Fiber Bragg grating-based high temperature sensor and its low cost interrogation system with enhanced resolution**

VENKATA REDDY MAMIDI\*, SRIMANNARAYANA KAMINENI,  
L.N. SAI PRASAD RAVINUTHALA, SAI SHANKAR MADHUVARASU,  
VENKATAPPA RAO THUMU, VENGAL RAO PACHAVA, KISHORE PUTHA

Department of Physics, National Institute of Technology, Warangal-506004, India

\*Corresponding author: mamidivenkatreddy@gmail.com

A fiber Bragg grating-based high temperature sensor together with a low cost, high speed and compact size interrogation system using a long period grating was designed, developed and tested. The designed sensor measures the temperature from room temperature to 550 °C. The sensor head was configured by encapsulating an fiber Bragg grating (type-I) of Bragg resonance wavelength at 1552.88 nm in a capillary tube made of copper. Long period grating with peak transmission loss at 1550 nm was employed to convert the wavelength information from fiber Bragg grating into an intensity modulated signal. Temperature related optical intensity information was again converted into its equivalent electrical signal by using a photodiode. The achieved resolution of the sensor was found to be 0.5 °C.

Keywords: fiber Bragg grating, long period grating, fiber optic temperature sensor, optical intensity modulation.

## **1. Introduction**

Fiber Bragg grating (FBG) sensors have been playing a vital role in many industrial applications owing to their high sensitivity, fast response, immunity to electromagnetic interference, high reliability, distributed and multiplexing capability, and multi-parameter sensing [1, 2]. The past decade has seen a tremendous growth in the number of FBG-based sensor systems [3–5].

Nowadays, temperature measurement encompasses a wide variety of needs and applications in scientific fields, aerospace, metallurgical and civil engineering, solar panels, nuclear power, shipping, petroleum, and thermal power industries [6]. To meet the requirements of all these applications, the industry must develop a large number of sensors and devices. Further, the conventional sensors like thermocouples are point sensors unable to provide distributed data without utilizing a networked plurality of sensors. In order to obtain accurate, three-dimensional spatial information regarding

the temperature distribution, FBG is an intelligent sensing element for real-time monitoring [7].

An FBG illuminated by a broadband light source reflects a particular narrow band wavelength called Bragg wavelength and transmits all others. The Bragg wavelength is mainly dependent on applied temperature and strain. The principle of FBG temperature sensor is based on the measurement of shift in Bragg wavelength corresponds to variation in temperature. In general, the Bragg wavelength shift of FBG is monitored by using an optical spectrum analyzer (OSA). However, OSA has its own limitations in response time, resolution, weight, size, and cost [8, 9]. To overcome these issues, different interrogation techniques have been developed [10–12]. Among them, a simple technique is based on converting the wavelength information into its equivalent intensity modulated signal which can be measured by using a photodiode with simple electronics.

This paper describes the design of an FBG-based temperature sensor, its low-cost and high sensitive interrogation system using long period grating (LPG), the sensor response in terms of wavelength, light intensity, and voltage and an approach to compensate the source power fluctuations.

## 2. Working principle

### 2.1. Sensing principle of FBG

FBG consists of periodically modulated refractive index zones called gratings in a fiber core by exposure to an ultraviolet (UV) laser beam (Fig. 1). The grating structure results in reflection of light at Bragg wavelength due to the coupling between incident and counter propagating modes in the optical fiber. The Bragg condition is expressed as

$$\lambda_B = 2n_{\text{eff}}\Lambda$$

where  $\lambda_B$  is the Bragg wavelength of FBG,  $n_{\text{eff}}$  is the effective index of refraction of the fiber grating, and  $\Lambda$  is the grating period. If the grating is exposed to change in

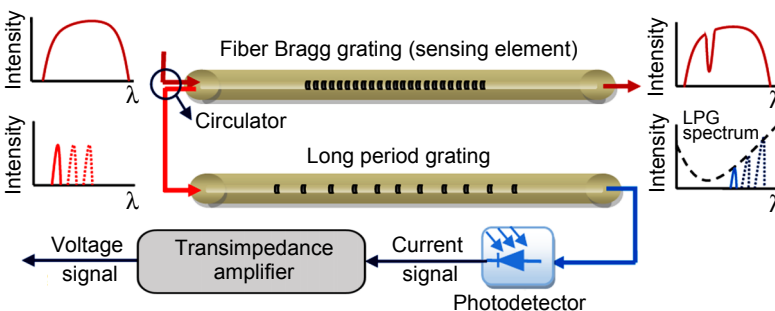

Fig. 1. Working principle of the sensor followed by an interrogation system.

environmental conditions such as temperature and strain, the Bragg wavelength shifts. By sensing the Bragg wavelength shifts accurately, the temperature can be measured where the strain is considered to be negligible. This is the fundamental principle that allows FBG to be used as a temperature sensor [1, 2, 13].

Two parameters that are responsible for the shift of Bragg wavelength with change in temperature are the change in grating period due to the thermal expansion of fiber and the index of refraction. Thus, the wavelength shift for a temperature change  $\Delta T$  could be written as

$$\Delta\lambda_{B(t)} = \lambda_B (\alpha + \xi) \Delta T$$

where  $\alpha$  is the thermal expansion coefficient of the fiber and  $\xi$  is the thermo-optic coefficient [14, 15]:

$$\alpha = \frac{1}{L} \frac{\partial L}{\partial T}$$

$$\xi = \frac{1}{n_{\text{eff}}} \frac{\partial n_{\text{eff}}}{\partial T}$$

## 2.2. Interrogation principle

Long period grating (LPG) having spectral loss at selected wavelength can be used as a linear response edge filter to convert wavelength shifts into intensity changes. The reflected peak power from FBG gets modulated according to LPG transmitted power at raising edge (Fig. 1). At room temperature (20 °C) the reflected peak power is low. While increasing the temperature, the reflected peak gets shifted towards higher wavelengths, which results in an increase in amplitude by following the LPG raising edge (same action will be achieved even if the order of FBG and LPG is interchanged). The change in FBG peak power corresponding to the variation in temperature is detected by a photodiode connected to a simple electronic sub-assembly consisting of a transimpedance amplifier, filters, and is displayed by using a digital multimeter. Thus, a simple and low cost interrogation system is designed for FBG temperature sensor.

## 3. Experimental details

At first, the change in Bragg wavelength and associated peak power of the FBG which is modulated by LPG with respect to the applied temperature were recorded using OSA (Fig. 2). Further, in order to make the system compact and low cost, the OSA has been replaced with a photodiode as shown in Fig. 3. The schematic of the experimental setup shown in Figs. 2 and 3 mainly consists of a broadband source (BBS, Thorlabs SLD source, 1525–1565 nm), 3-port optical circulator, tubular furnace (OTF-1200X,

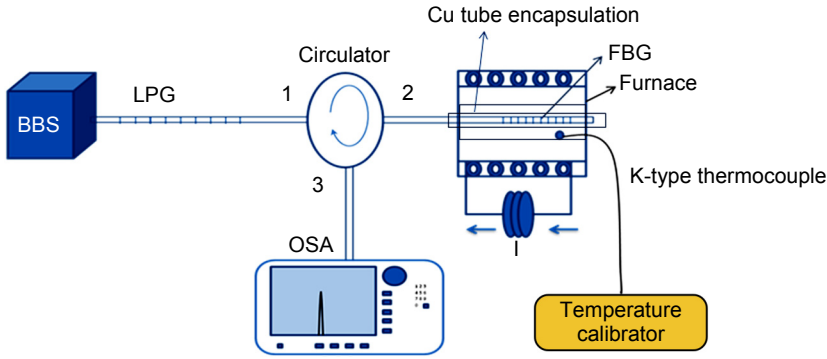

Fig. 2. Schematic of experimental setup using OSA.

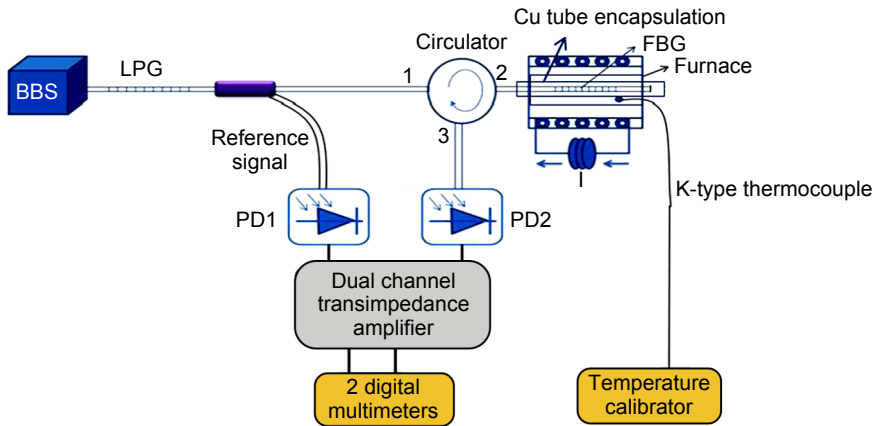

Fig. 3. Schematic of an experimental setup without using OSA.

MTI Corporation), optical spectrum analyzer (OSA, Agilent 86142B), CO<sub>2</sub> laser drawn LPG and polyimide coated type-I FBG with specifications given in Table 1, 1×2 (3 dB) coupler, two fiber coupled InGaAs PIN photodiodes, dual channel transimpedance amplifier board (Twlux TW30), a copper capillary tube of 1 mm diameter hole and 300 mm length, temperature calibrator, two digital multimeters, optical fiber patch cards, and connectors.

Table 1. Specifications of FBG and LPG.

	FBG	LPG
Peak resonance wavelength	1552.88 nm	1550.00 nm
Reflectivity (FBG)	~90%	NA
Peak amplitude	15.95 dB	23.09 dB
FWHM	~0.29 nm	~24 nm
Length	5 mm	20 mm
Linear edge region of LPG (at raising edge)	NA	1552.5–1560 nm

### 3.1. Thermal characterisation of sensor system using OSA

Light from broadband source (BBS) transmitted through an LPG is coupled into the FBG which is encapsulated by a capillary tube made of copper. If bare FBG is subjected to the sensing environment, the sensitivity and reliability of the sensor may be affected by the presence of water vapour, pollutants, *etc.* Moreover, a fragile nature of FBG has drawn the necessity of its encapsulation with good thermal conductors to safe guard and make the sensing element pristine [16–18]. The reflected peak power of the FBG, modulated according to the linear edge slope of LPG transmission spectrum, is redirected to OSA using port-3 of the optical circulator to analyze the parameters: wavelength and power (Fig. 2). Temperature of the encapsulated FBG is increased at the rate 18 °C/min up to 550 °C and corresponding Bragg wavelength shift as well as peak power are measured using OSA.

### 3.2. Replacement of OSA with photodiode and rational output scheme

To make the sensor system cost effective, OSA is replaced by a photodetector PD2, in addition to a reference photodetector PD1, introduced to avoid the effect of source fluctuations (Fig. 3). The light from a BBS transmitted through LPG was divided into two; one illuminates the FBG sensor head through a circulator and the other illuminates PD1. The reflected peak power from FBG is detected by PD2.

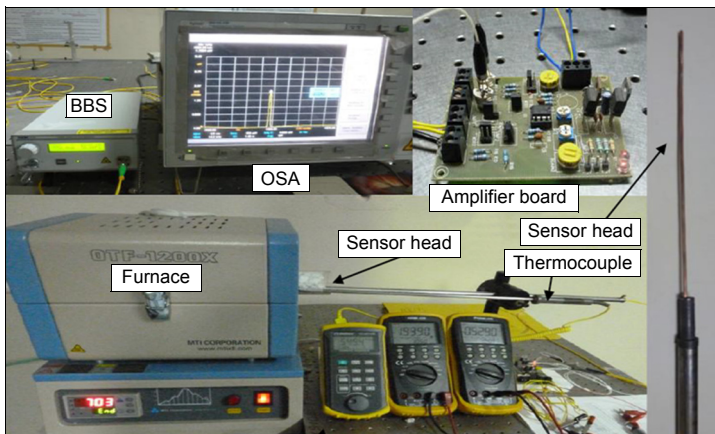

Fig. 4. Photographs of the experimental setup.

The filtering mechanism of the LPG gives a linear relationship between the temperature and light intensity that is coupled to PD2. The light detected by PD1 and PD2 is converted into their equivalent voltage signals, which are processed by a simple electronic circuitry consisting of a dual channel transimpedance amplifier accompanied by digital multimeters. The photographs of the experimental setup are shown in Fig. 4.

In practice, even a small variation in LPG spectrum due to change in ambient temperature, is undesirable which significantly affects the interrogation of the sensor

signal. To compensate this, LPG is placed in a chamber where the temperature is precisely controlled by using semiconductor heaters having an accuracy of  $\pm 0.01$  °C. Moreover, to compensate the source fluctuations in temperature related intensity measurements, the rational output scheme is employed, which can be expressed as

$$\text{Rotational output} = \frac{\text{PD2} - \text{PD1}}{\text{PD1} + \text{PD2}}$$

The experiment is repeated to realise the accuracy and repeatability of the sensing system.

## 4. Results and discussion

### 4.1. Wavelength and power modulation of sensor signal

The wavelength as well as power response of the FBG sensor corresponding to the temperature within the applied range are linear as shown in Fig. 5. The Bragg wavelength of FBG shifted linearly from 1552.88 to 1559.48 nm over a span of 20–550 °C temperature measurement. Temperature sensitivity of the sensor in terms

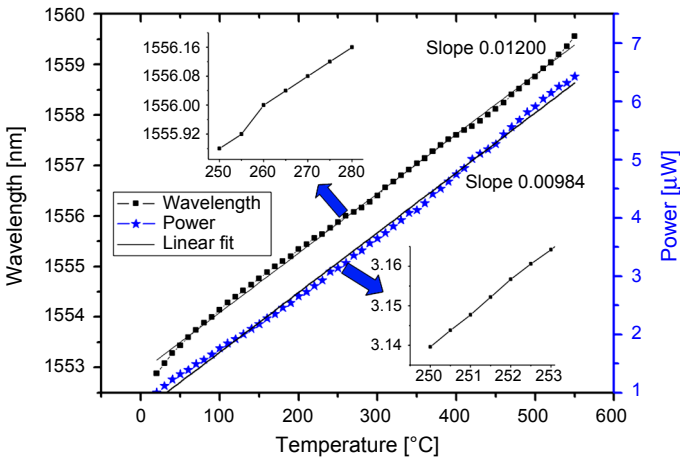

Fig. 5. Temperature response of the sensor in terms of wavelength and power.

of wavelength shift is found to be 12 pm/°C, and its resolution is calculated as  $\sim 5$  °C which is limited by the low resolution, 60 pm of OSA. Whereas in the interrogation scheme using LPG as a linear edge filter, the temperature related optical intensity is varied from 1.0053 to 6.421  $\mu\text{W}$  over the range of applied temperature 20–550 °C. The sensitivity in terms of optical intensity is found to be 9.84 nW/°C and the resolu-

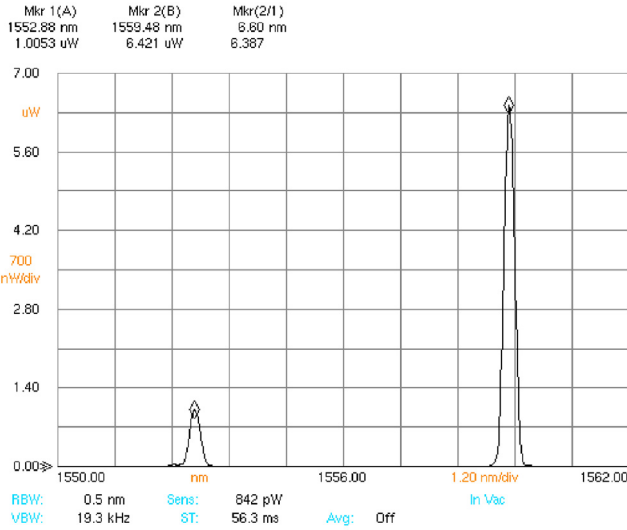

Fig. 6. LPG modulated FBG spectrum at the temperatures 20 and 550 °C, respectively.

tion of the sensor is ~0.5 °C since the resolution of OSA is limited to ~4 nW. Figure 6 shows FBG spectra modulated by LPG at temperatures 20 and 550 °C, respectively.

### 4.2. Temperature related voltage signal

The experimental results of the sensor system after replacing OSA with photodiode followed by a transimpedance amplifier and multimeter are illustrated in Fig. 7. They are recorded over a span of temperature 20–550 °C in the presence and absence of

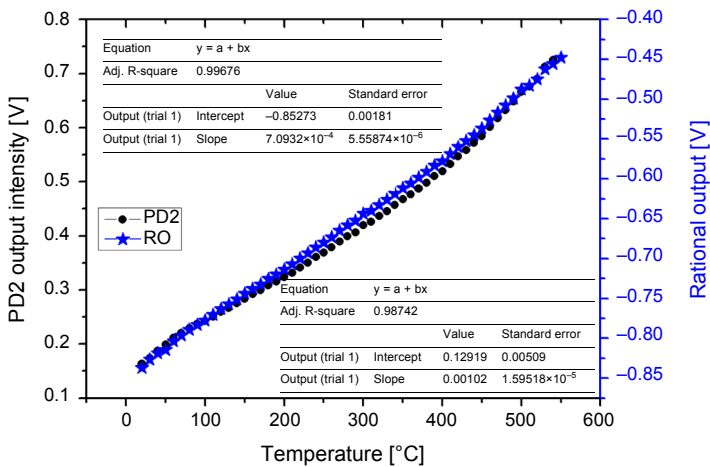

Fig. 7. Comparison between normal and rational outputs of the sensor after interrogation.

a reference arm, respectively. It is evident from the test results that the data points representing the rational output are found to be more linear, stable and consistent than that of PD2, which is desirable in practical applications. From Fig. 7 it is analyzed that for each degree of temperature change the change in PD2 and rational output are found to be 1.02 and 7.09 mV, respectively. Since the accuracy of PD2 is limited by 0.5 mV, the approximate resolution of the sensor system is found to be 0.5 °C which coincides with that of the intensity modulation recorded by using OSA. The resolution of the photodetector and noise generated from the transimpedance amplifier circuit might be responsible for this limitation of resolution by 0.5 °C.

### 4.3. Repeatability of the sensor system

The repeatability of the system has been tested by repeating the experiment in different climate conditions (day and night), and the corresponding results are presented in Fig. 8. The results reveal that the system works accurately from room temperature to 550 °C and accomplishes good repeatability and negligible hysteresis loss. The two important

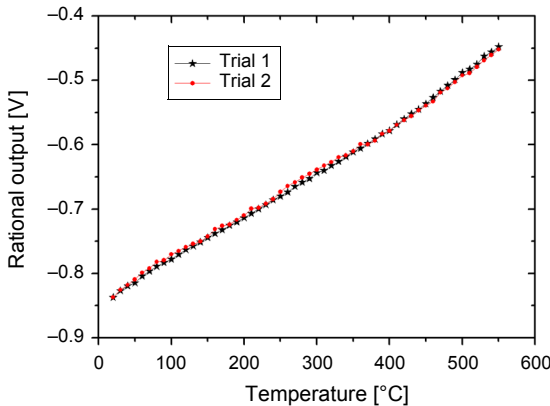

Fig. 8. Repeatability response of the sensor system corresponds to a rational output.

aspects that are involved with the designed sensor system are: *i*) protecting the fragile bare FBG by encapsulating in a metal capillary tube and *ii*) making the measurement system cost effective by replacing the OSA with photodetectors accomplished by a simple electronic circuitry.

## 5. Conclusion

An FBG-based sensor for high temperature measurement is designed, developed and interrogated successfully. Conversion of temperature related FBG Bragg wavelength shift into corresponding light intensity modulation using the LPG, not only enhanced the resolution (0.5 °C), but made the interrogation system simple and low cost.



The experimental results also revealed that the designed sensor system measures up to 550 °C with improved accuracy and repeatability. The maximum speed of temperature that can be measured by the sensor is 18 °C/min. It can be employed as an intelligent sensor for distributed temperature measurement applications.

*Acknowledgements* – The authors acknowledge the fine gesture of Department of Electronics and Information Technology (DEIT) under the Ministry of Communications and Information Technologies, New Delhi for providing financial assistance to carry out this work. Authors also thank to Dr. Balaji Srinivasan, Department of Electrical Engineering, IIT Madras and Dr. Syamal K Bhadra, Fiber Optics and Photonics Division, CGCRI, Kolkata for sparing FBGs and LPGs.

## References

- [1] RAMAN KASHYAP, *Fiber Bragg Gratings*, Academic Press, USA, 1999, pp. 55–101
- [2] OTHAONOS A., KALLI K., *Fiber Bragg Gratings Fundamentals and Applications in Telecommunication and Sensing*, Artech House, 1999, pp. 1–6, 301–389.
- [3] MÉNDEZ A., *Fiber Bragg grating sensors: a market overview*, Proceedings of SPIE **6619**, 2007, article 661905.
- [4] RAJAN G., CALLAGHAN D., SEMENOVA Y., MCGRATH M., COYLE E., FARRELL G., *A fiber Bragg grating-based all-fiber sensing system for telerobotic cutting applications*, IEEE Sensors Journal **10**(12), 2010, pp. 1913–1920.
- [5] XINYONG DONG, LI-YANG SHAO, FU H.Y., TAM H.Y., LU C., *Intensity-modulated fiber Bragg grating sensor system based on radio-frequency signal measurement*, Optics Letters **33**(5), 2008, pp. 482–484.
- [6] MICHALSKI L., ECKERSDORF K., KUCHARSKI J., MCGHEE J., *Temperature Measurement*, John Wiley and Sons, 2001.
- [7] BOWEI ZHANG, MOJTABA KAHRIZI, *High-temperature resistance fiber Bragg grating temperature sensor fabrication*, IEEE Sensors Journal **7**(4), 2007, pp. 586–591.
- [8] AGILENT, *Optical Spectrum Analyzer, A User's Guide*.
- [9] YOKOGAWA, *Optical Spectrum Analyzer, A User's Guide*.
- [10] YAGE ZHAN, HAIWEN CAI, RONGHUI QU, SHIQING XIANG, ZUJIE FANG, XIANGZHAO WANG, *Fiber Bragg grating temperature sensor for multiplexed measurement with high resolution*, Optical Engineering **43**(10) 2004, pp. 2358–2361.
- [11] ABAD S., ARAÚJO F.M., FERREIRA L.A., SANTOS J.L., LÓPEZ-AMO M., *Interrogation of wavelength multiplexed fiber Bragg gratings using spectral filtering and amplitude-to-phase optical conversion*, Journal of Lightwave Technology **21**(1), 2003, pp. 127–131.
- [12] REGO G.M., SALGADO H.M., SANTOS J.L., *Interrogation of a fiber Bragg grating using a mechanically induced long-period fiber grating*, IEEE Sensors Journal **6**(6), 2006, pp. 1592–1595.
- [13] BRADY G.P., HOPE S., LOBO RIBEIRO A.B., WEBB D.J., REEKIE L., ARCHAMBAULT J.L., JACKSON D.A., *Bragg grating temperature and strain sensors*, Proceedings of SPIE **2360**, 1994, p. 510.
- [14] OTHONOS A., *Fiber Bragg gratings*, Review of Scientific Instruments **68**(12), 1997, p. 4309.
- [15] SRIMANNARAYANA K., SAI SHANKAR M., SAI PRASAD R.L.N., KRISHNA MOHAN T.K., RAMAKRISHNA S., SRIKANTH G., RAVI PRASAD RAO S., *Fiber Bragg grating and long period grating sensor for simultaneous measurement and discrimination of strain and temperature effects*, Optica Applicata **38**(3), 2008, pp. 601–608.
- [16] ROSE A.H., *Devitrification in annealed optical fiber*, Journal of Lightwave Technology **15**(5), 1997, pp. 808–814.

- [17] MAJUMDER M., GANGOPADHYAY T.K., CHAKRABORTY A.K., KAMAL DASGUPTA, BHATTACHARYA D.K., *Fibre Bragg gratings in structural health monitoring – present status and applications*, *Sensors and Actuators A: Physical* **147**(1), 2008, pp. 150–164.
- [18] PARNE SAIDI REDDY, RAVINUTHALA LAKSHMI NARAYANA SAI PRASAD, DIPANKAR SEN GUPTA, MADHUVARASU SAI SHANKAR, KAMINENI S. NARAYANA, PUTHA KISHORE, *Encapsulated fiber Bragg grating sensor for high temperature measurements*, *Optical Engineering* **50**(11), 2011, article 114401.

*Received November 15, 2013  
in revised form February 6, 2014*