



Fiber nonlinearity mitigation of WDM-PDM QPSK/16-QAM signals using fiber-optic parametric amplifiers based multiple optical phase conjugations

Hu, Hao; Jopson, Robert M.; Gnauck, Alan H.; Randel, Sebastian; Chandrasekhar, S.

Published in:
Optics Express

Link to article, DOI:
[10.1364/OE.25.001618](https://doi.org/10.1364/OE.25.001618)

Publication date:
2017

Document Version
Publisher's PDF, also known as Version of record

[Link back to DTU Orbit](#)

Citation (APA):

Hu, H., Jopson, R. M., Gnauck, A. H., Randel, S., & Chandrasekhar, S. (2017). Fiber nonlinearity mitigation of WDM-PDM QPSK/16-QAM signals using fiber-optic parametric amplifiers based multiple optical phase conjugations. *Optics Express*, 25(3), 1618-1628. <https://doi.org/10.1364/OE.25.001618>

General rights

Copyright and moral rights for the publications made accessible in the public portal are retained by the authors and/or other copyright owners and it is a condition of accessing publications that users recognise and abide by the legal requirements associated with these rights.

- Users may download and print one copy of any publication from the public portal for the purpose of private study or research.
- You may not further distribute the material or use it for any profit-making activity or commercial gain
- You may freely distribute the URL identifying the publication in the public portal

If you believe that this document breaches copyright please contact us providing details, and we will remove access to the work immediately and investigate your claim.

Fiber nonlinearity mitigation of WDM-PDM QPSK/16-QAM signals using fiber-optic parametric amplifiers based multiple optical phase conjugations

HAO HU,^{1,2,4} ROBERT M. JOPSON,^{1,5} ALAN H. GNAUCK,¹ SEBASTIAN RANDEL,^{1,3} AND S. CHANDRASEKHAR¹

¹Nokia Bell Labs, Crawford Hill, Holmdel, NJ 07733, USA

²Permanent address: DTU Fotonik, Technical University of Denmark, Ørstedes Plads, Building 343, DK-2800 Kgs. Lyngby, Denmark

³Currently with Institute of Photonics and Quantum Electronics, Karlsruhe Institute of Technology, Karlsruhe, Germany

⁴huhao@fotonik.dtu.dk

⁵bob.jopson@nokia-bell-labs.com

Abstract: We demonstrate fiber nonlinearity mitigation by using multiple optical phase conjugations (OPCs) in the WDM transmission systems of both 8×32 -Gbaud PDM QPSK channels and 8×32 -Gbaud PDM 16-QAM channels, showing improved performance over a single mid-span OPC and no OPC in terms of nonlinear threshold and a best achievable Q^2 factor after transmission. In addition, after an even number of OPCs, the signal wavelength can be preserved after transmission. The performance of multiple OPCs for fiber nonlinearity mitigation was evaluated independently for WDM PDM QPSK signals and WDM PDM 16-QAM signals. The technique of multiple OPCs is proved to be transparent to modulation formats and effective for different transmission links. In the WDM PDM QPSK transmission system over 3600 km, by using multiple OPCs the nonlinear threshold (i.e. optimal signal launched power) was increased by ~ 5 dB compared to the case of no OPC and increased by ~ 2 dB compared to the case of mid-span OPC. In the WDM PDM 16-QAM transmission system over 912 km, by using the multiple OPCs the nonlinear threshold was increased by ~ 7 dB compared to the case of no OPC and increased by ~ 1 dB compared to the case of mid-span OPC. The improvements in the best achievable Q^2 factors were more modest, ranging from 0.2 dB to 1.1 dB for the results presented.

© 2017 Optical Society of America

OCIS codes: (060.2330) Fiber optics communications; (190.5040) Phase conjugation; (190.4370) Nonlinear optics, fibers.

References and links

1. P. J. Winzer, "High-Spectral-Efficiency Optical Modulation Formats," *J. Lightwave Technol.* **30**(24), 3824–3835 (2012).
2. R. J. Essiambre, G. Kramer, P. J. Winzer, G. J. Foschini, and B. Goebel, "Capacity Limits of Optical Fiber Networks," *J. Lightwave Technol.* **28**(4), 662–701 (2010).
3. D. Rafique, J. Zhao, and A. D. Ellis, "Digital back-propagation for spectrally efficient WDM 112 Gbit/s PM-ary QAM transmission," *Opt. Express* **19**(6), 5219–5224 (2011).
4. E. Ip and J. M. Kahn, "Compensation of Dispersion and Nonlinear Impairments Using Digital Backpropagation," *J. Lightwave Technol.* **26**(20), 3416–3425 (2008).
5. E. Temprana, E. Myslivets, B. P.-P. Kuo, L. Liu, V. Ataie, N. Alic, and S. Radic, "Overcoming Kerr-induced capacity limit in optical fiber transmission," *Science* **348**(6242), 1445–1448 (2015).
6. X. Liu, A. R. Chraplyvy, P. J. Winzer, R. W. Tkach, and S. Chandrasekhar, "Phase-conjugated twin waves for communication beyond the Kerr nonlinearity limit," *Nat. Photonics* **7**(7), 560–568 (2013).
7. S. L. I. Olsson, B. Corcoran, C. Lundström, T. A. Eriksson, M. Karlsson, and P. A. Andrekson, "Phase-sensitive amplified transmission links for improved sensitivity and nonlinearity tolerance," *J. Lightwave Technol.* **33**(3), 710–721 (2015).
8. H. Hu, R. M. Jopson, A. Gnauck, M. Dinu, S. Chandrasekhar, X. Liu, C. Xie, M. Montoliu, S. Randel, and C. McKinstrie, "Fiber Nonlinearity Compensation of an 8-channel WDM PDM-QPSK Signal using Multiple Phase

- Conjugations,” in: Optical Fiber Communication Conference (OFC), Paper M3C.2, Optical Society of America (2014).
9. H. Hu, R. M. Jopson, A. H. Gnauck, D. Pileri, S. Randel, and S. Chandrasekhar, “Fiber Nonlinearity Compensation by Repeated Phase Conjugation in 2.048-Tbit/s WDM transmission of PDM 16-QAM Channels,” in: Optical Fiber Communication Conference (OFC), Paper Th4F.3, Optical Society of America (2016).
 10. I. Phillips, M. Tan, M. F. Stephens, M. McCarthy, E. Giacomidis, S. Sygletos, P. Rosa, S. Fabbri, S. T. Le, T. Kanesan, S. K. Turitsyn, N. J. Doran, P. Harper, and A. D. Ellis, “Exceeding the Nonlinear-Shannon Limit using Raman Laser Based Amplification and Optical Phase Conjugation,” in: Optical Fiber Communication Conference (OFC), Paper M3C.1, Optical Society of America (2014).
 11. S. Yoshima, Z. Liu, Y. Sun, K. R. Bottrill, F. Parmigiani, P. Petropoulos, and D. J. Richardson, “Nonlinearity Mitigation for Multi-channel 64-QAM Signals in a Deployed Fiber Link through Optical Phase Conjugation,” in: Optical Fiber Communication Conference (OFC), Paper Th4F.4, Optical Society of America (2016).
 12. S. Namiki, H. Nguyen Tan, K. Solis-Trapala, and T. Inoue, “Signal-transparent wavelength conversion and light-speed back propagation through fiber,” in: Optical Fiber Communication Conference (OFC), Paper Th4F.1, Optical Society of America (2016).
 13. A. D. Ellis, M. Tan, M. A. Iqbal, M. A. Z. Al-Khateeb, V. Gordienko, G. S. Mondaca, S. Fabbri, M. F. C. Stephens, M. E. McCarthy, A. Perentos, I. D. Phillips, D. Lavery, G. Liga, R. Maher, P. Harper, N. Doran, S. K. Turitsyn, S. Sygletos, and P. Bayvel, “4 Tb/s Transmission Reach Enhancement Using 10×400 Gb/s Super-Channels and Polarization Insensitive Dual Band Optical Phase Conjugation,” *J. Lightwave Technol.* **34**(8), 1717–1723 (2016).
 14. I. Sackey, F. Da Ros, M. Jazayerifar, T. Richter, C. Meuer, M. Nölle, L. Molle, C. Peucheret, K. Petermann, and C. Schubert, “Kerr nonlinearity mitigation in 5×28 -GBd PDM 16-QAM signal transmission over a dispersion-uncompensated link with backward-pumped distributed Raman amplification,” *Opt. Express* **22**(22), 27381–27391 (2014).
 15. M. Morshed, L. B. Du, B. Foo, M. D. Pelusi, B. Corcoran, and A. J. Lowery, “Experimental demonstrations of dual polarization CO-OFDM using mid-span spectral inversion for nonlinearity compensation,” *Opt. Express* **22**(9), 10455–10466 (2014).
 16. H. Kogelnik and K. Pennington, “Holographic imaging through a random medium,” *J. Opt. Soc. Am.* **58**(2), 273–274 (1968).
 17. B. Ya. Zel’dovich, V. I. Popovichev, V. V. Ragul’skii, and F. S. Faizullov, “Connection between the wave fronts of the reflected and exciting light in stimulated Mandel’shtam-Brillouin scattering,” *JETP Lett.* **15**(3), 109–112 (1972).
 18. D. M. Pepper and A. Yariv, “Compensation for phase distortions in nonlinear media by phase conjugation,” *Opt. Lett.* **5**(2), 59–60 (1980).
 19. K. Kikuchi and C. Lorattanasane, “Compensation for pulse waveform distortion in ultra-long distance optical communication systems by using midway optical phase conjugation,” *IEEE Photonics Technol. Lett.* **6**(1), 104–105 (1994).
 20. A. H. Gnauck, R. M. Jopson, and R. M. Derosier, “10-Gb/s 360-km transmission over dispersive fiber using midsystem spectral inversion,” *IEEE Photonics Technol. Lett.* **5**(6), 663–666 (1993).
 21. P. Kaewplung and K. Kikuchi, “Simultaneous Cancellation of Fiber Loss, Dispersion, and Kerr Effect in Ultralong-Haul Optical Fiber Transmission by Midway Optical Phase Conjugation Incorporated With Distributed Raman Amplification,” *J. Lightwave Technol.* **25**(10), 3035–3050 (2007).
 22. H. Hu, R. Nourozi, R. Ludwig, C. Schmidt-Langhorst, H. Suche, W. Sohler, and C. Schubert, “110 km transmission of 160 Gbit/s RZ-DQPSK signals by midspan polarization-insensitive optical phase conjugation in a Ti:PPLN waveguide,” *Opt. Lett.* **35**(17), 2867–2869 (2010).
 23. H. Hu, R. M. Jopson, A. H. Gnauck, M. Dinu, S. Chandrasekhar, C. Xie, and S. Randel, “Parametric Amplification, Wavelength Conversion, and Phase Conjugation of a 2.048-Tbit/s WDM PDM 16-QAM Signal,” *J. Lightwave Technol.* **33**(7), 1286–1291 (2015).
 24. M.-C. Ho, M. E. Marhic, K. Y. K. Wong, and L. G. Kazovsky, “Narrow-Linewidth Idler Generation in Fiber Four-Wave Mixing and Parametric Amplification by Dithering Two Pumps in Opposition of Phase,” *J. Lightwave Technol.* **20**(3), 469–476 (2002).
 25. L. Grüner-Nielsen, S. Dasgupta, M. D. Mermelstein, D. Jakobsen, S. Herstrom, M. E. V. Pedersen, E. L. Lim, S. Alam, F. Parmigiani, D. Richardson, and B. Palsdottir, “A silica based highly nonlinear with improved threshold for stimulated Brillouin scattering,” in Proceedings of ECOC 2010, paper Tu.4.D3 (2010).
 26. R. M. Jopson and R. E. Tench, “Polarisation-independent phase conjugation of lightwave signals,” *Electron. Lett.* **29**(25), 2216–2217 (1993).
 27. M. Jamshidifar, A. Vedadi, and M. E. Marhic, “Reduction of Four-Wave-Mixing Crosstalk in a Short Fiber-Optical Parametric Amplifier,” *IEEE Photonics Technol. Lett.* **21**(17), 1244–1246 (2009).

1. Introduction

To meet the demand for large-capacity optical fiber transmission, advanced modulation formats with high spectral efficiency (SE), such as polarization-division-multiplexed (PDM) quaternary phase-shift keying (QPSK) and PDM 16-state quadrature amplitude modulation (16-QAM), have become promising candidates for future long-haul optical transmission

systems employing high data-rate signals (100 Gb/s or beyond) [1]. However, these high-order modulation formats require a higher optical signal-to-noise ratio (OSNR) to achieve a given bit-error rate (BER). In order to achieve high OSNR after the long-haul optical fiber transmission, more signal power is required to be launched into the fiber. However, fiber nonlinearity (also known as Kerr nonlinearity in optical fibers) degrades signal quality as the launched signal power is increased [2].

Several approaches have been proposed to mitigate the fiber nonlinearity, in both the digital and the optical domain, such as digital back propagation [3,4], frequency-referenced transmission [5], phase-conjugated twin waves [6], phase-sensitive amplification [7] and optical phase conjugation [8–15]. Among these schemes, optical phase conjugation (OPC) offers unique benefits, including modulation-format transparency, capability of processing high speed and heterogeneous signals, capability of operating on an entire wavelength-division-multiplexed (WDM) band at the same time, and little additional latency.

The use of phase conjugation to mitigate linear impairment was first demonstrated by Kogelnik and Pennington for spatial distortion using static spatial phase conjugation [16] and was later demonstrated with dynamic conjugation by Zeldovich, et al. [17]. Pepper and Yariv proposed using phase conjugation for the compensation of nonlinear phase distortion [18] while Kikuchi and Lorattanasane were the first to propose and simulate nonlinearity mitigation in a fiber link [19].

Mid-span OPC, which is also referred to as mid-span spectral inversion, has become a well-known technique to compensate for chromatic dispersion and nonlinear impairments caused by the Kerr effect such as self-phase modulation (SPM), cross-phase modulation (XPM), four-wave mixing (FWM) and nonlinear phase noise [20–22]. In a mid-span OPC system, the entire signal is phase conjugated after a certain length of transmission and then propagates through another link with similar fiber properties. Subject to certain symmetry conditions, linear and nonlinear effects (excluding odd-order dispersion) are reversed. The non-reversal of odd-order chromatic dispersion results in residual chromatic dispersion that is particularly limiting, making it impossible in any realistic system to exactly compensate the effects of fully nondegenerate four-wave mixing. Similarly, polarization-mode dispersion causes the polarization relationships between various spectral components to not be symmetric around the phase conjugation. This also prevents exact compensation of nonlinearity. Despite this, for reasons incompletely understood, phase conjugation has demonstrated considerable ability to compensate nonlinear impairment. In a recent work [13], 4 Tbit/s transmission reach has been enhanced by using mid-span OPC, where second-order Raman amplification was used to obtain a near-symmetric power profile in order to maximize the efficiency of OPC-based nonlinearity compensation.

The mid-span OPC needs to be placed near the middle of the transmission link, which significantly reduces the flexibility of optically routed networks where the ‘mid-span’ point is hard to identify or changing over time. In addition, in the mid-span OPC the phase-conjugated signal is usually generated and further transmitted at a different wavelength compared to the original signal, which introduces the extra complexity of identifying the signal at the receiver.

By using multiple OPCs, i.e. conjugating the phase of the signal after every certain amount of transmission distance and repeating the phase conjugation after another transmission, the fiber nonlinearity can be mitigated along the transmission link, instead of just at the end of the transmission, which allows the signals to be dynamically routed. Furthermore, the signal wavelength can be preserved after an even number of OPCs, which reduces receiver complexity. More importantly, it has been shown that multiple OPCs have better performance for fiber nonlinearity mitigation than mid-span OPC [8,9]. In addition, the bulk dispersion can also be compensated during the transmission by using multiple OPCs. This reduces the complexity of digital signal processing (DSP), especially in a dynamically routed network where signals might pass through different lengths of the fiber link due to the traffic and blind dispersion compensation is usually needed.

In this paper, expanding on the work presented in [8,9], we experimentally demonstrate fiber nonlinearity mitigation using polarization-insensitive fiber-optic-parametric-amplifier (FOPA) based multiple OPCs for both 1.024 Tbit/s 8-channel WDM PDM QPSK signal and 2.048 Tbit/s 8-channel WDM PDM 16-QAM signal, showing the flexibility and upgradability of the scheme. The use of multiple OPCs results in improved transmission performance (both higher optimal signal launched power and higher Q^2 factor after the transmission) when compared to a mid-span OPC or no OPC. In the experiment, the benefit of using multiple OPCs was partially masked by the presence of idler-band noise at the FOFA input and Raman pump saturation, limiting overall improvement of Q^2 factor after the transmission to 0.2 dB to 1.1 dB. However, better performance is expected by filtering out the idler-band noise at the FOFA input and using stronger Raman pumping when increasing signal launched power.

2. Polarization-Insensitive (PI) FOFA based OPC

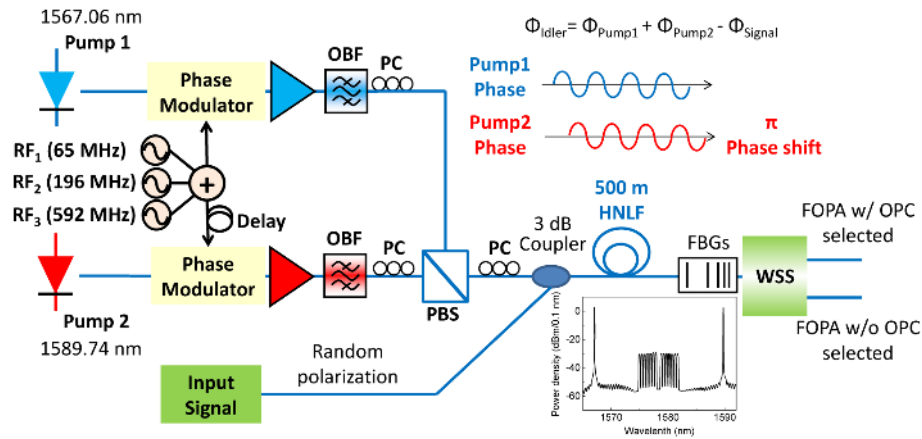

Fig. 1. Configuration of the polarization-insensitive fiber-optic parametric amplifier (PI-FOFA) using two pumps with orthogonal polarizations and counter phasing, simultaneously generating high-quality idlers. Acronyms are: OBF, optical bandpass filter; PC, polarization controller; PBS, polarization beam splitter; and HNLF, highly nonlinear fiber. Inset: optical spectrum at the output the 500-m HNLF.

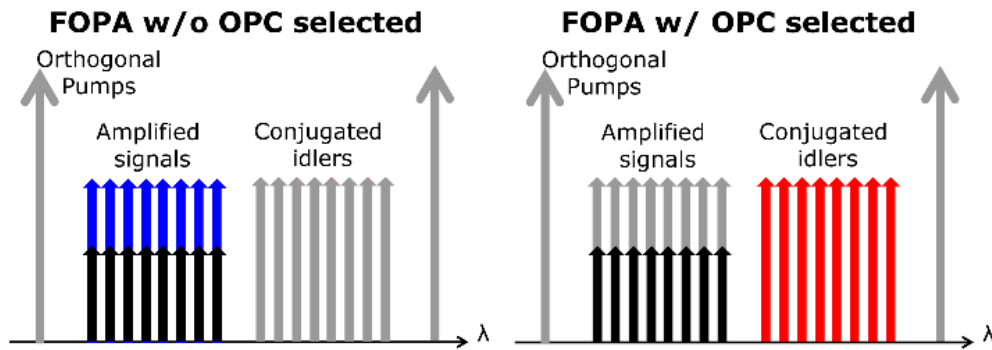

Fig. 2. Schematics of two different selections using a wavelength selective switch (WSS) at the output of the HNLF: FOFA w/o OPC selected (left) and FOFA w/ OPC selected (right).

Figure 1 shows the configuration of a polarization-insensitive (PI) FOFA using two pumps with orthogonal polarizations and counter-phase modulation [23]. In our experiment the input signal with random polarization was combined with two orthogonally polarized continuous-wave (CW) pumps at 1567.06 nm and 1589.74 nm, and launched into a 500-m highly nonlinear fiber (HNLF) with a zero-dispersion wavelength of 1578.5 nm and a nonlinear

coefficient of 20 /W/km. The CW pumps, each having a linewidth less than 100 kHz, were phase modulated by three radio-frequency (RF) tones (65 MHz, 196 MHz and 592 MHz) in order to suppress stimulated Brillouin scattering (SBS). The phases of both pumps and the signal is transferred to the idler, with the idler phase of $\Phi_{\text{idler}} = \Phi_{\text{pump1}} + \Phi_{\text{pump2}} - \Phi_{\text{signal}}$. The two pumps had counter-phased modulation (i.e. a relative phase of π between the pumps), therefore the impact of these RF tones on the idler was nearly cancelled and a high-quality idler was generated [24]. Another way to mitigate the SBS is by using strained fiber with different stresses along its length [25].

After the phase modulation, the two FOPA pumps were amplified, filtered and combined using a polarization beam combiner (PBC), which ensured orthogonal polarizations of the pumps in order to achieve polarization-insensitive operation [26]. A polarization controller placed in front of the HNLf aligned the polarizations of the pumps with the principal states of polarization of the HNLf to minimize polarization-mode-dispersion-induced deviations from pump-polarization orthogonality in the FOPA. The two pumps were then combined with the signal in a 3-dB coupler. Note that a WDM coupler would be a better choice, as it can introduce less insertion loss. At the HNLf input, the pump powers at 1567.06 nm and 1589.74 nm were 25.1 and 24.2 dBm, respectively. The optical spectrum at the output of the 500-m HNLf is shown in the inset of Fig. 1. The signals experienced ~10 dB on-off gain in the FOPA and the phase-conjugated idlers were generated with a positive conversion efficiency of ~9 dB. Note that higher pump power with a shorter HNLf would be more desirable since it could offer broader working bandwidth and less nonlinear effect generated by the signal [27].

At the output of the HNLf, a wavelength selective switch (WSS) was used to separate the signal band (i.e. blue band) labelled “with FOPA w/o OPC selected” and the conjugated idler band (i.e. red band) labelled “with FOPA w/ OPC selected”, as shown in Fig. 2. The amplified signals were output from one port of the WSS and the conjugated idlers were output from another port of the WSS. The two pumps were removed by the combined filtering of cascaded fiber Bragg gratings (FBGs) and the WSS. Note that the signal could also be present at the red band (i.e. the wavelength band of idler in Fig. 2), and then the phase conjugated idler would be generated at the blue band.

3. Fiber nonlinearity mitigation of a 1.024 Tbit/s WDM PDM-QPSK signal using PI-FOPA based multiple OPCs

3.1 Experimental setup

Figure 3 shows the schematic of the experimental setup for fiber nonlinearity mitigation of a 1.024 Tbit/s WDM PDM-QPSK signal using PI-FOPA based multiple OPCs in a loop transmission experiment [8]. Eight L-band external-cavity lasers (ECLs) were operated on a 50 GHz frequency grid extending from 190.00 THz to 190.35 THz and combined using an 8-to-1 coupler. The 8 WDM channels were modulated in a LiNbO₃ waveguide-based PDM I/Q modulator, driven by four 64 GSa/s digital-to-analog converters (DACs). The inputs to the DACs were provided by a field-programmable gate-array (FPGA) based real-time logic circuit with stored signal E-fields. Pseudo-random bit sequences (PRBSs) of $2^{15}-1$ were encoded and mapped to PDM-QPSK symbols for the signal waveforms generation. A root-raised-cosine filter with a roll-off factor of 0.1 was used to confine the optical spectra of the signals. The raw data rate of each channel was 128 Gbit/s, resulting in a total rate of 1.024 Tbit/s. In order to decorrelate the 8-WDM PDM-QPSK signals, a WSS was used to separate them into four paths, with ~600 symbols delay difference between any two paths, and then recombining them in a 4-to-1 coupler.

The transmission link was a recirculating loop consisting of three dispersion-uncompensated 100 km TrueWave[®] reduced slope (TWRS) fiber spans, with an average span loss of ~22 dB. The span loss was compensated by counter-propagating Raman pumps. Compared to using discrete amplifiers, distributed Raman amplification more closely satisfies

the power symmetry condition for efficient fiber nonlinearity mitigation based on OPC. The TWRS had a dispersion of 5.5 ps/nm/km at a wavelength of 1575 nm and a nonlinear coefficient of ~ 1.8 /W/km. A scrambler with a 1 kHz scan rate was used to randomize the loop polarization.

OPC was performed using a PI-FOPA, as shown in Fig. 1. The PI-FOPA in the loop amplified the signals at the input wavelengths and generated phase conjugate idlers at different wavelengths as shown in Fig. 4. A 2-to-1 optical switch controlled by a pulse generator was used to select either the signal band or the idler band to pass through and then propagate in the loop.

The coherent receiver consisted of a polarization-diversity 90-degree hybrid, a local oscillator (LO), four balanced detectors, a 50-GSa/s sampling oscilloscope and off-line digital signal processing.

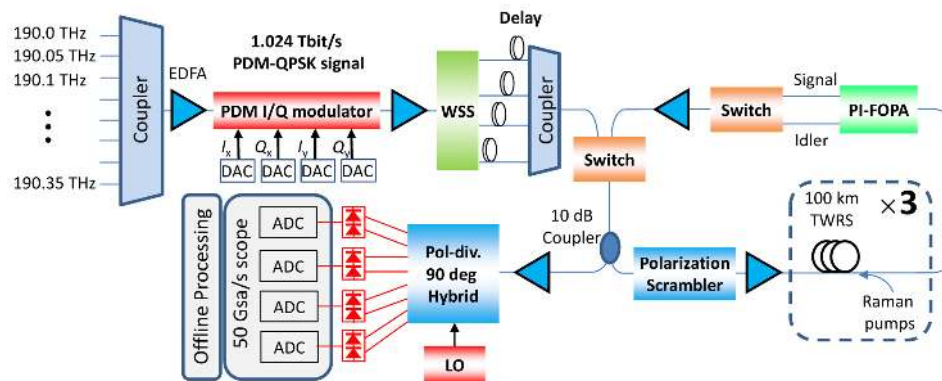

Fig. 3. Schematic of the experimental setup for fiber nonlinearity mitigation of a 1.024 Tbit/s WDM PDM-QPSK signal using PI-FOPA based multiple OPCs in the loop apparatus, including erbium-doped fiber amplifiers (EDFAs), digital-to-analog converters (DACs), polarization-insensitive fiber-optic parametric amplifier (PI-FOPA), True-Wave® reduced-slope fiber (TWRS), a local oscillator (LO) and analog-to-digital converters (ADCs).

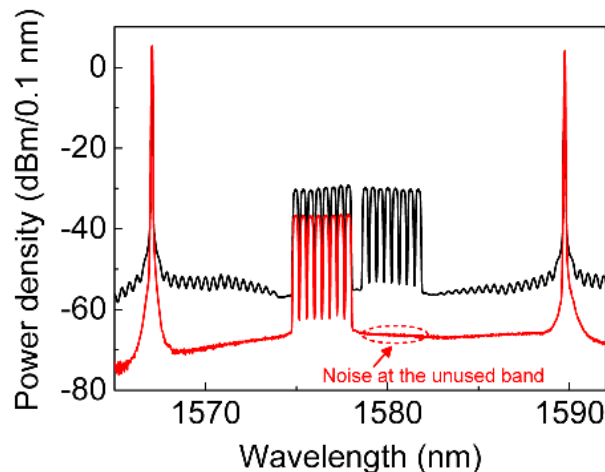

Fig. 4. Spectra at the PI-FOPA input (red) and output (black), showing two orthogonally polarized pumps, a signal band of 8 WDM channels having the same wavelengths as the input channels and an idler band containing the 8 phase conjugates of the signal channels.

3.2 Operation of multiple OPCs

The switch after the PI-FOPA determined whether the signal band was just parametrically amplified or phased conjugated on any particular loop pass. If the switch did not change state, the amplified signal band was transmitted for another loop pass. If the switch changed state, the conjugated band was transmitted for the next loop pass. We compared four cases (shown in Fig. 5) as follows: a) PI-FOPA and the 2-to-1 optical switch bypassed, labelled “w/o FOPA”, b) PI-FOPA inserted with signal band just parametrically amplified but not phase conjugated, labelled “FOPA w/o OPC”, c) phase conjugation only enabled at the midpoint of the link, labelled “FOPA w/ mid-span OPC”, and d) phase conjugation enabled after the first loop and after every 2 loops thereafter, labelled “FOPA w/ multiple OPC”. As shown in Fig. 5, for the case of “FOPA w/ mid-span OPC” the received signals have different wavelengths compared to the signals at the transmitter. In comparison, after an even number of OPCs the wavelengths of the signals can be preserved, which is one of the key features for the ‘black-box’ operation of the transmission system, without touching the transmitter and the receiver.

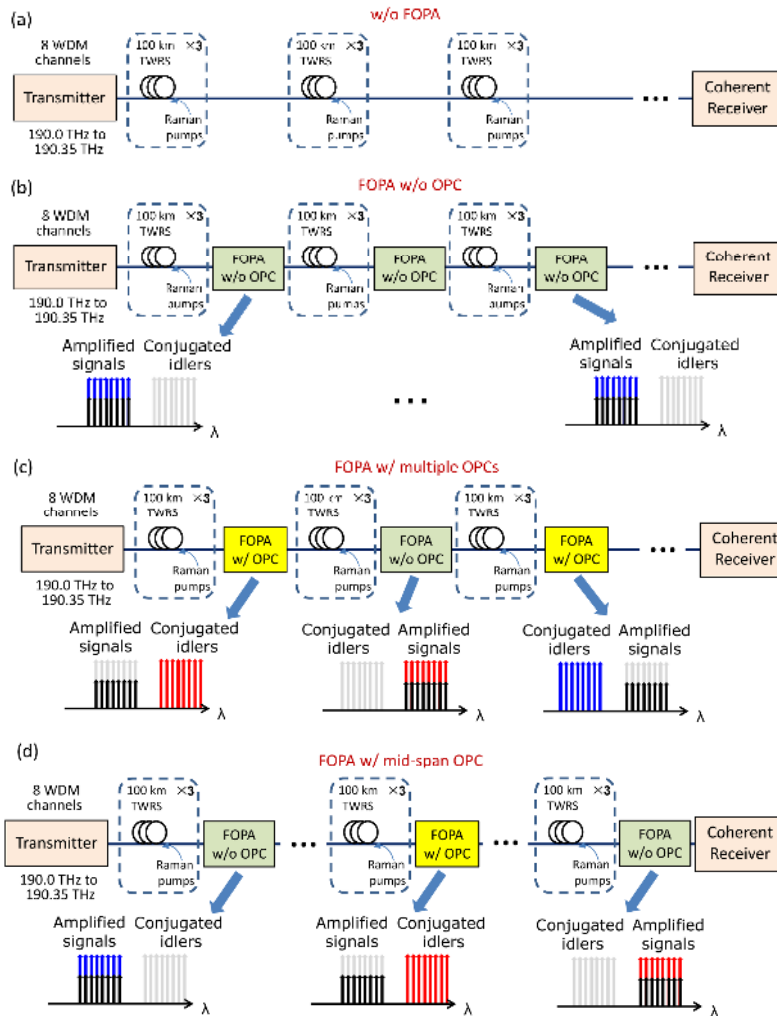

Fig. 5. Schematic of four cases in comparison: (a) w/o FOPA; (b) FOPA w/o OPC; (c) FOPA w/ mid-span OPC; (d) FOPA w/ multiple OPC. The WDM signals at the input of the FOPA are colored black, which could be at the blue band or red band. At the output of the FOPA either amplified signals or conjugated idlers are selected. The unselected one is colored grey.

3.3 Experimental results

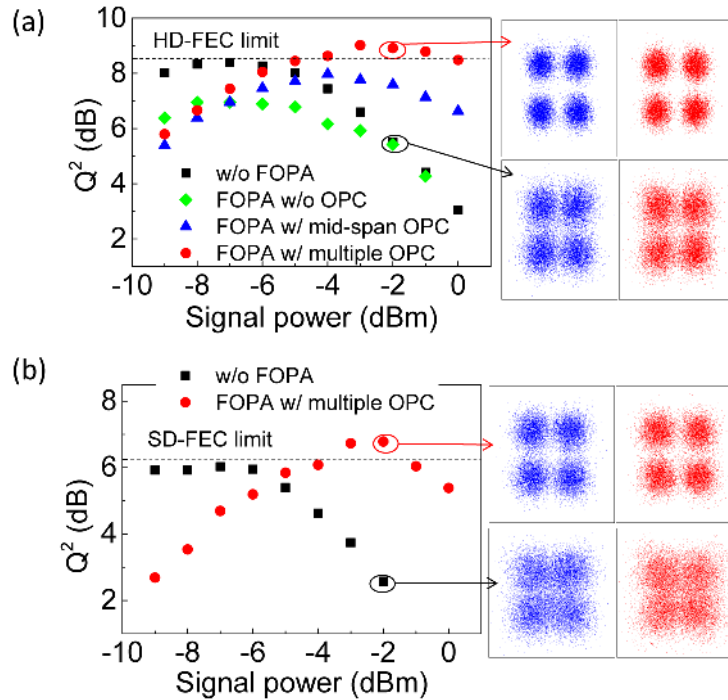

Fig. 6. Measured Q^2 factor (derived from the BER) as a function of launched signal power per channel for the center channel of the WDM signal after 3600 km transmission (a) and after 6000 km transmission (b). Inset: recovered constellations.

The performance of the center channel (190.2 THz) of the WDM signal was measured after transmission over 3600 km for different signal launched powers, as shown in Fig. 6(a). For the case of 'w/o FOPA', the optimum launched power is around -7 dBm per channel, but the bit-error rate (BER) is above the hard-decision forward-error-correction (HD-FEC) limit (3.8×10^{-3}) after the 3600 km transmission. For the case of 'FOPA w/o OPC', the optimum launched power is still around -7 dBm, but the Q^2 factor is 1.4 dB lower than w/o FOPA, mainly due to the OSNR degradation in the FOPA caused by the presence of optical noise in the unused band at the FOPA input. As shown in Fig. 4, the noise at the unused band was not filtered out; therefore the noise was doubled in the process of parametric amplification, which significantly degraded the signal OSNR. As shown in Fig. 7(a), after 3600 km transmission with the same launched power of -7 dBm, the OSNR is 19.5 dB and 17.5 dB the cases of 'w/o FOPA' and 'FOPA w/o OPC', respectively. Note that in a real transmission system the noise at the unused band can be easily filtered out using an optical bandpass filter and the severe OSNR degradation can be avoided. In the recirculating loop, where the signal band will periodically appear at either blue band or red band (as shown in Fig. 5(d)), a WSS followed by a 2-to-1 switch could be used to filter the unwanted noise, but a third WSS was not available when this experiment was performed.

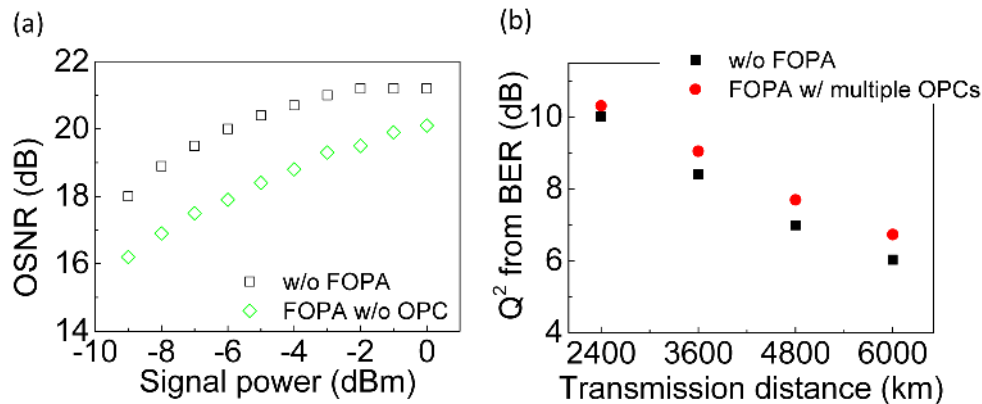

Fig. 7. (a) OSNR after the transmission of 3600 km as a function of launched signal power for the case of 'w/o FOPA' and 'FOPA w/o OPC'; (b) Measured Q^2 factor (derived from the BER) as a function of transmission distance for the case of 'w/o FOPA' and 'FOPA w/ multiple OPC' for optimal powers.

OSNR degradation in the FOPA affects the performance of the OPC and partially masks its benefits. Therefore, in the case of 'FOPA w/ mid-span OPC', the optimum launched power is increased by 3 dB to be -4 dBm, and the highest Q^2 factor is 1 dB higher than that in the case of 'FOPA w/o OPC' but still 0.4 dB lower than that in the case of 'w/o FOPA'. Note that Raman pump saturation causes a 3-dB increase in launched power to result in only a 1.7 dB higher OSNR after transmission for the highest launched power. Nevertheless, in the case of 'FOPA w/ multiple OPC', the optimum launched power is increased by ~ 5 dB to be around -2 dBm, resulting in a 2.5 dB higher OSNR after the transmission. The highest Q^2 factor is 0.5 dB higher than the case of 'w/o FOPA', 0.9 dB higher than the case of 'FOPA w/ mid-span OPC' and 1.9 dB higher than the case of 'FOPA w/o OPC'. For various transmission distances, the Q^2 factors in the case of 'FOPA w/o multiple OPC' are always higher than that in the case of 'w/o FOPA' (shown in Fig. 7(b)) and the improvement becomes larger for longer transmission where fiber nonlinearity is more severe. Note that the performance of using multiple OPCs can be even better if the noise at the unused band is filtered out.

After transmission over 6000 km (shown in Fig. 6(b)), the optimum launched power is still -7 dBm per channel but the Q^2 factor is only 6 dB for the case of 'w/o FOPA' and below the soft-decision FEC (SD-FEC) limit (BER of 2×10^{-2}). For the case of 'FOPA w/ multiple OPC', the optimum launched power remains around -2 dBm and the highest Q^2 factor is increased to be 6.8 dB, above the SD-FEC limit and 0.8 dB higher than that in the case of 'w/o FOPA'.

The BER for all the 8 WDM channels and the optical spectra after transmission over 3600 km and 6000 km at the optimal launched power for each case are measured, for the cases of 'w/o FOPA' and 'FOPA w/ multiple OPC', as shown in Fig. 8(a) and 8(b). After transmission over 3600 km, for the case of 'w/o FOPA', most of the WDM channels have a BER above the HD-FEC limit, but for the case of 'FOPA w/ multiple OPC', all the WDM channels show a BER below the HD-FEC limit. After the transmission of 6000 km, for the case of 'w/o FOPA', all the WDM channels have a BER above the SD-FEC limit, but for the case of 'FOPA w/ multiple OPC', all the WDM channels show a BER below the SD-FEC limit.

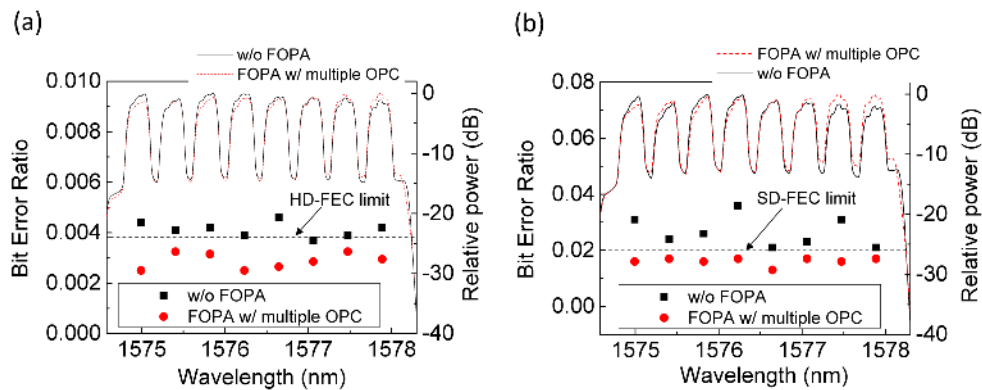

Fig. 8. Spectra (right axis) and BERs (left axis) after 3600 km transmission and 6000 km transmission of 8 channels for the cases of 'w/o FOPA' and 'FOPA w/ multiple OPC'.

4. Fiber nonlinearity mitigation of a 2.048 Tbit/s WDM PDM-16-QAM signal using PI-FOPA based multiple OPCs

4.1 Experimental setup

The experimental setup for fiber nonlinearity mitigation of a 2.048 Tbit/s WDM PDM-16-QAM signal using PI-FOPA based multiple OPCs in a loop transmission experiment is very similar to the setup for fiber nonlinearity mitigation of a 1.024 Tbit/s WDM PDM-QPSK signal (Fig. 3). There are mainly two differences between these two setups. One is that the DACs inputs are replaced with PDM 16-QAM symbols (PRBS of $2^{15}-1$) and the other is that the transmission link is changed to three dispersion-uncompensated 76-km standard-single-mode-fiber (SMF) spans with a dispersion of 19.4 ps/nm/km at a wavelength of 1580 nm in order to test the effective mitigation of fiber nonlinearity for different types of transmission fiber. The multiple OPCs can be kept almost unchanged, which also confirms the flexibility and modulation-format transparency of the scheme.

4.2 Experimental results

The Q^2 factor (derived from the BER) is measured as a function of signal launched power per channel after 912-km SMF transmission for the single channel case and for the WDM channels case, as shown in Fig. 9(a) and 9(b). In the case of single channel transmission, the optimum launched power is around -7 dBm, 0 dBm and $+2$ dBm for the case of 'w/o FOPA', 'FOPA w/ mid-span OPC' and 'FOPA w/ multiple OPC', respectively. The best achievable Q^2 factor is increased from 8.1 dB to 9.2 dB in the cases of 'w/o FOPA' and 'FOPA w/ multiple OPC'. Thus, by using multiple OPCs, the signal launched power is increased by ~ 9 dB compared to the case of without OPC, and ~ 2 dB compared to the mid-span OPC case. Note that the performance of mid-span OPC and multiple OPCs is still masked by the OSNR degradation in the FOPA, caused by the presence of optical noise in the unused band at the FOPA input, as mentioned in the section of 3.3. If the idler-band noise was filtered out before the FOPA, the performance of both mid-span OPC and multiple OPCs would likely improve.

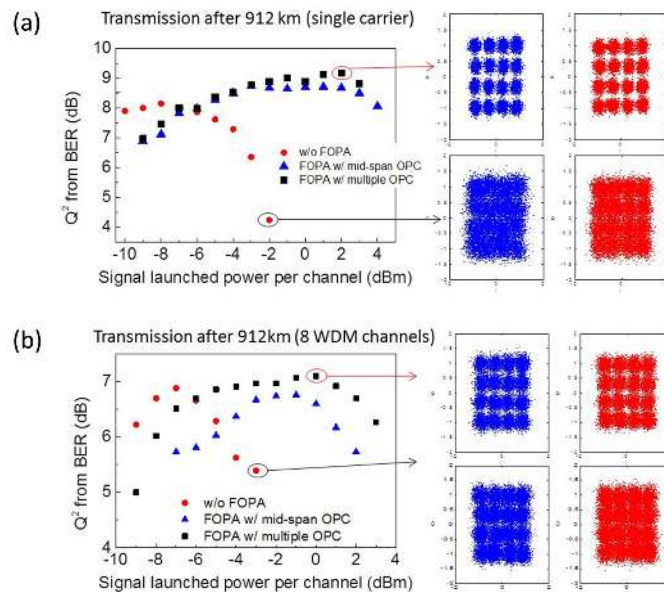

Fig. 9. Measured Q^2 factor (derived from the BER) as a function of signal launched power per channel after the 912 km SMF transmission in the single channel case (a) and the WDM channels case (b). Inset: recovered constellations.

In the WDM channels transmission, the optimum launched power of the center channel (190.2 THz) of the WDM signal is around -7 dBm, -1 dBm and 0 dBm for the case of 'w/o FOFA', 'FOFA w/ mid-span OPC' and 'FOFA w/ multiple OPC', respectively. The best achievable Q^2 factor is increased from 6.9 dB to 7.1 dB in the cases of 'w/o FOFA' and 'FOFA w/ multiple OPC'. By using the multiple OPCs, the optimum signal launched power is increased by ~ 7 dB compared to the case of without OPC, and ~ 1 dB compared to the mid-span OPC case. Again, idler-band noise filtering at the FOFA input would likely improve the performance.

5. Summary

We demonstrated mitigation of fiber nonlinearities using multiple optical phase conjugations (OPCs) in the WDM transmission systems of both 8×32 -Gbaud PDM-QPSK channels and 8×32 -Gbaud PDM-16-QAM channels, showing improved performance over a single mid-span OPC and no OPC. In the WDM-PDM-QPSK transmission system over 3600 km, by using multiple OPCs the nonlinear threshold was increased by ~ 5 dB compared to the case of no OPC and increased by ~ 2 dB compared to the case of mid-span OPC. In the WDM-PDM-16-QAM transmission system over 912 km, by using the multiple OPCs the nonlinear threshold was increased by ~ 7 dB compared to the case of no OPC and increased by ~ 1 dB compared to the case of mid-span OPC. The overall improvement of the Q^2 factor was 0.2 dB to 1.1 dB. Improved performance is expected by filtering out the idler-band noise at the FOFA input and using stronger Raman pumps when increasing signal launched power.

Funding

Danish National Research Foundation (DNRF) Centre of Excellence SPOC (Centre for Silicon Photonics for Optical Communications), ref DNRF123.

Acknowledgments

We would like to acknowledge M. Dinu, C. Xie, X. Liu and C. J. McKinstrie for their help in the experiment and the helpful discussions.