

Finding minimum spanning trees more efficiently for tile based phase unwrapping

Firas Al-Sawaf and Ralph P. Tatam

Optical Sensors Group

Centre for Photonics and Optical Engineering

School of Engineering

Cranfield University

Cranfield,

Bedford MK43 OAL

Tel: 01234 745360

Fax: 01234 752452

Email: r.p.tatam@cranfield.ac.uk

Short Title: Efficient minimum spanning trees for tile based phase unwrapping

PACS: 02.10.0x, 42.30.Ms,

Keywords: Phase unwrapping, minimum spanning tree, graph theory

Abstract

The tile-based phase unwrapping method employs an algorithm for finding the minimum spanning tree (MST) in each tile. We first examine the properties of a tile's representation from a graph theory view point, observing that it is possible to make use of a more efficient class of MST algorithms. We then describe a novel linear time algorithm which reduces the size of the MST problem by half at the least, and solves it completely at best. We also show how this algorithm can be applied to a tile using a sliding window technique. Finally, we show how the reduction algorithm can be combined with any other standard MST algorithm to achieve a more efficient hybrid, using Prim's algorithm for empirical comparison and noting that the reduction algorithm takes only 0.1% of the time taken by the overall hybrid.

Deleted: only

1. Introduction

Automatic fringe analysis techniques, such as the Fourier transform [1, 2] and phase stepping¹ [3- 6], produce phase information which is inherently wrapped onto the range $-\pi$ to π . The restoration of the unknown multiple of 2π is called phase unwrapping, and is central to most such algorithms [7].

Phase unwrapping techniques utilising the tiling approach and the minimum spanning tree (MST) method [9-13] have been shown to have good noise immunity and prevention of error propagation. This is mainly due to dividing the wrapped phase map into tile-like regions. Each tile is then unwrapped independently, and the tiles are finally assembled to obtain the unwrapped phase map. The path for unwrapping in each tile is selected in a way which minimises the probability of error. This is achieved by choosing a path whose total phase difference is minimal. Identifying such a path is in fact the MST graph theory problem. Prim's algorithm [14] is a traditional way of solving the MST problem, and is employed by tile phase unwrapping [15].

Finding a MST for each tile is a computationally demanding, and impacts the efficiency of the overall unwrapping algorithm. We first examine how phase information in a tile is converted into a weighted graph, and how the topology of such a graph enables the use of a more efficient class of MST algorithms. We then describe an algorithm tailored specifically to a tile's topology. We show that it is linear time efficient, $O(n)$, where n is the number of pixels in a tile, and that it can be used to reduce the size of the MST problem by half or more. We then show how it can be applied to a tile using an image processing sliding window technique. Finally, we discuss how any chosen MST algorithm could be attached to ours, creating an efficient hybrid. We use Prim's algorithm for empirical comparison.

2. Tile representation from a graph theory perspective

We give here a brief summary of the relevant graph theory principles [16,17,18,19] which are relied upon in the descriptions given in the subsequent sections.

2.1 Graphs and trees

A graph,

Figure 1, (a), can be described as $G = [n, e]$, and consists of a vertex set n connected by an edge set e .

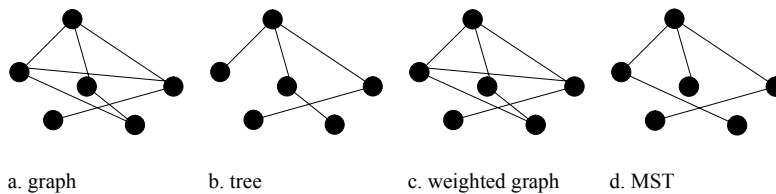

Figure 1 Graph, trees and MST

A graph is said to be connected if each of its vertices is connected to another vertex by at least one edge. A spanning tree,

¹ Phase stepping is also known as quasi-heterodyning.

Figure 1 (b), is an acyclic connected graph. This means that each vertex in a tree is connected to any other vertex via one path only. Thus, an n vertex tree contains n -1 edges. A weighted graph,

Deleted: ¶
Figure 1

Figure 1 (c), is a graph whose edges have a cost associated with each edge. Finding a minimum spanning tree (MST) of such a graph is finding a tree whose total edge cost is minimal,

Deleted: ¶
Figure 1

Figure 1 (d).

Deleted: ¶
Figure 1

2.2 Tile graph topology

The tiling method of phase unwrapping commences by dividing the wrapped phase map image into tiles. The pixels of a tile become the vertices of the graph. These are connected by edges in a grid fashion, as shown in Figure 2. Each edge is then assigned a weight equal to the absolute phase difference of the two pixels it connects.

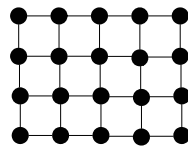

Figure 2 A Topology of a tile's graph

Depending on the application, there are often minimum and maximum tile sizes between which the tiling method provides the best results. There are various considerations taken into account when choosing the tiles' size, such as the expected fringe density and the size of fringe breaks. This is mainly to ensure that tiles are not so small that they often fall in between broken edges, and not so large so that they often contain sections of different fringes [15].

We note that there is another consideration in relation to the maximum tile size from a computational point of view. Some MST algorithms, such as Prim's [14], have a non-linear relationship with the number of vertices (pixels) in the graph. Depending on the particular implementation, this could be $O(n^2)$ in the worst case, for a tile of n vertices (pixels). This could impose a further restriction on computational performance sensitive applications, limiting the maximum usable size for a tile.

3. Finding a minimum spanning tree

The time complexity of an MST algorithm is expressed using the number of its edges, e, and vertices, n. Prim $O(n^2)$ [14], can be implemented more efficiently with modification to achieve $O(e \log n)$ [20, 21]. It can be further improved by the use of priority queues to $O(e + n \log n)$ [22].

The best deterministic algorithms are near linear time [23-27]. Linear time efficiency $O(e)$ was achieved by using a randomised method [28], employing an $O(e)$ MST verification algorithm [29].

However, we note that the actual topology of a tile's graph is planar. A planar graph is a graph which can be drawn in a single plane, such that none of its edges intersect. This allows for the use of deterministic and linear time MST algorithms [30, 31].

One of the properties of any connected planar graph, G, is that it is possible to construct another planar graph, G^* , so that each face of G corresponds to a vertex in G^* . Each pair of faces in G having an edge in common, has a corresponding edge in G^* crossing it. G^* is called a dual graph of G,

Formatted: Normal, Left

Deleted: ve

Figure 3.

Deleted: ¶

Deleted: Figure 3

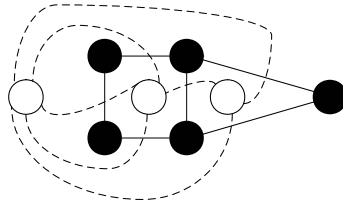

Figure 3 A graph G (solid edges and vertices) and its dual G*

Dual graphs have interesting properties, stemming from the fact that each cycle-set of G's edges is also a cut-set of G*, and vice versa. Matsui [31] relies on these properties to construct a linear time MST algorithm $O(e + n)$, noting that a maximum edge of a vertex in G* can be ruled out of G's minimum spanning tree, and a minimal edge of a vertex in G can be ruled out of G*'s maximum spanning tree.

3.1. Reducing the problem's size

Theoretically, it is only possible to improve on $O(n)$ efficiency by having prior knowledge of the MST itself. This is the case for MST maintenance algorithms which can carry out a single update, such as single weight change, in $O(\sqrt{e})$ [32], and in $O(\log n)$ for planar graphs [33, 34].

Although prior knowledge of the topology of a graph may not improve on $O(n)$, it can help to improve the overall efficiency of the algorithm in empirical terms. This could be by reducing the total number of times the edges and vertices are handled, or minimising the total number of edge weight comparisons necessary.

We describe a novel linear time $O(n)$ algorithm which takes advantage of the prior knowledge of a tile's graph topology to reduce its size from $G(n, e)$ to somewhere between zero, at best, and $G[n/2, e/2]$ at the very most.

This has the effect of reducing the size of the problem needed to be solved by the underlying MST algorithm of choice.

Image processing algorithms often employ a sliding window technique to apply their various operations to the image in question. Similarly, we show how our algorithm can be applied to a tile using a sliding window.

For clarity, we start by describing the four steps of the algorithm separately. The discrete description is used subsequently for time-performance analysis, and for describing the sliding window operations.

4. Algorithm fundamentals and performance analysis

4.1 Initial state

The tile, Figure 2, can have any number of rows and columns of vertices.

Each corner vertex has two edges, the minimum of which can be immediately ruled in the MST (if not, the resultant tree is either disconnected or is not minimum).

Processing the four corners in this way can be carried out in constant time $O(1)$, regardless of the number of vertices, n .

Figure 4 illustrates the representation of a tile's graph G, and its dual G*, once the corners have been processed.

Formatted: Normal, Left

Deleted: ¶
Figure 4

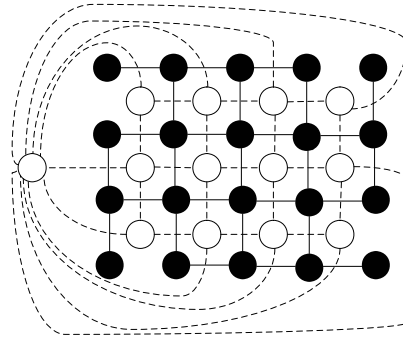

Figure 4 A tile's graph G (solid edges and vertices) and its dual G^* . VO is a G^* vertex corresponding to the outer face of G^2 .

The dual graph G^* need not be constructed in practice, and is only shown here to help clarify the underlying interactions of the various steps of the algorithm.

We observe that at this initial state, due to prior knowledge of the topology, the graph fulfils the following criteria:

- a Both $G[n, e]$ and $G^*[n^*, e^*]$ are connected and naturally planar
- b G and G^* have n vertices each
- c $e = e^*$, $n \approx n^*$ and the size of e approaches the size of $2n$.
- d Neither G or G^* have two vertices connected to each other by more than one edge (this is secured by pre-processing the corners, which removes such edges from G^*)
- e Each vertex³ in G and G^* , has a maximum of 4 edges.
- f Any G vertex can be picked from this initial state of G and processed independently, and its minimum edge can be ruled in the MST.
- g Any G^* vertex can be picked from this initial state of G^* and processed independently. Its maximum edge can be ruled out of the MST.
- h Any edge of G and G^* can be processed in the same independent way as described in f or g, unless one or more of its edges has already been ruled in or out by processing an adjacent vertex in the same graph.

4.2 Step 1 – Process G vertices alternately, ruling in one edge per vertex

The alternate fashion in which the G vertices are targeted,

[Figure 5](#), (a), ensures that they can be processed independently (criteria f and h). In effect, the G vertices which are not being targeted act as an isolating barrier.

Formatted: Normal, Left

Deleted: ¶
Figure 5

² A graph's outer face is also known as the unbounded or infinite face.

³ As G^* 's most outer vertex (VO) does not satisfy this criterion, it will not be relied upon for any of the steps of the algorithm. Although the edges of VO will still be processed by the algorithm, this will be done in the context of the other vertices in G^* which are connected to VO . Therefore, all references to G^* vertices from this point on shall implicitly exclude VO .

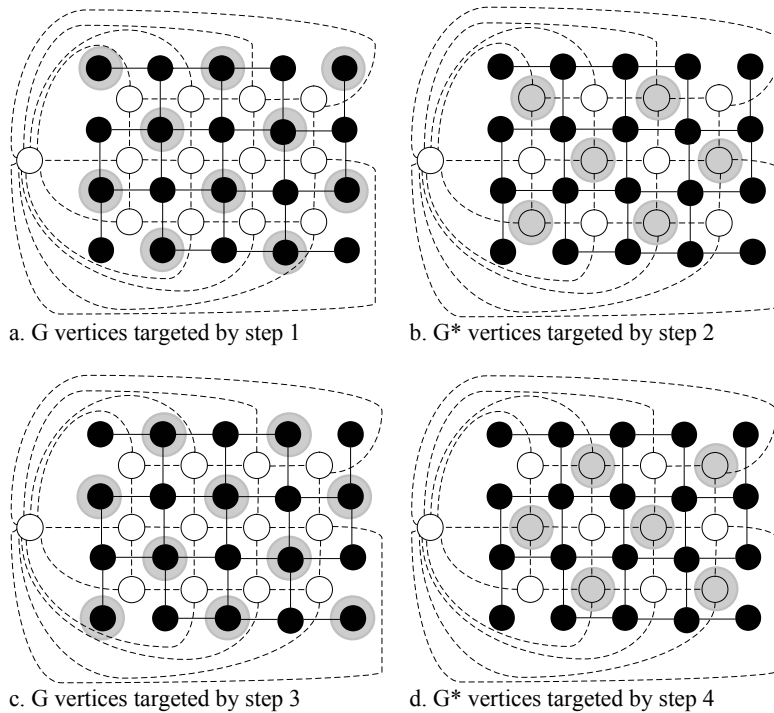

Figure 5 Targeted vertices (shaded)

Each vertex has a maximum of four edges, therefore the minimum edge of each of these vertices can be ruled in the MST in $O(1)$.

4.2 Step 2 – Process G^* vertices alternately, ruling out one edge per vertex

Each targeted G^* vertex,

[Figure 5](#) (b), has a maximum of four edges, therefore the maximum edge of each of these vertices can be found in $O(1)$. This maximum edge of G^* crosses an edge in G , which in turn can be ruled out from the MST.

In a similar way to step 1, G^* vertices which are targeted can be processed independently.

4.3 Step 3 – Ensure each remaining G vertex is connected to at least one ruled-in edge

Each of the remaining G vertices,

[Figure 5](#) (c), is examined in turn. If it has an edge which has been already ruled in the MST, then no further processing is required. Otherwise, it must still have one or more edges which have not been processed, because step 2 could not possibly have deleted all of its edges. This also means that such a vertex can still be processed independently (criteria f and h), and therefore we can rule in its minimum edge in $O(1)$.

4.4 Step 4 - Ensure each remaining G^* vertex is connected to at least one ruled-out edge

The remaining G^* vertices,

Formatted: Normal, Left

Deleted: ¶
Figure 5

Formatted: Normal, Left

Deleted: ¶
Figure 5

Formatted: Normal, Left

Figure 5 (d), are targeted by this step. It can be shown, using argument similar to those of step 3, that each of the targeted vertices in G^* either has a ruled out edge (due to step 2), or, otherwise, its maximum edge can be found in $O(1)$. This maximum edge of G^* crosses an edge in G , which in turn can be ruled out from the MST. The algorithm ends when step 4 has completed. At this point, none of the vertices in either G or G^* can automatically satisfy criteria f , g or h by relying on a prior knowledge of the initial state.

Deleted: ¶
Figure 5

5. Problem reduction analysis

The consequence of steps 1 and 2 is that $n/2$ edges are ruled in the MST and $n/2$ edges are ruled out.

This means that the original $G[n, e]$ graph is now reduced to $G[n/2, e/2]$.

The ruled out edges can be clearly dismissed from the graph. Each ruled in edge, on the other hand, serves to fuse the two vertices it connects into one vertex.

The remaining (i.e. neither ruled in or out) edges of the original two vertices now become incident on the fused vertex.

Deleted: reaming

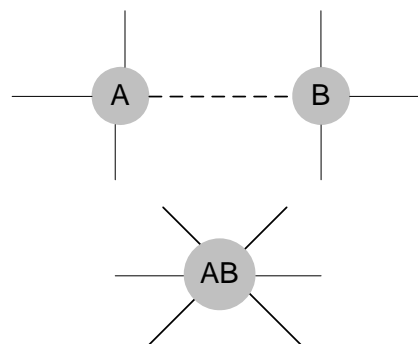

The dashed edge is contracted. The union of edges incident onto A and B becomes incident on the merged vertex, AB.

Figure 6 Edge contraction

This process is known as edge contraction,

Figure 6, and naturally results in the reduction of the number of the vertices in the graph.

Formatted: Normal, Justified

Deleted: ¶

Deleted: Figure 6

If the algorithm were only to perform steps 1 and 2, it would still be guaranteed to reduce the original problem by half. This gives the algorithm the worst case reduction bound. Steps 3 and 4 of the algorithm may improve on the above reduction, but are not guaranteed to do so; it is possible that by some chance every non-targeted vertex has one of its edges contracted or removed by an adjacent targeted vertex. In this case steps 3 and 4 would not perform any further edge contraction or deletion.

Deleted: ¶

At the other extreme, steps 3 and 4 could find $n/2$ edges to contract, therefore completely solving the MST problem. This is because an MST has exactly $n-1$ edges to be identified (i.e. ruled in or contracted).

5.1 Edge contraction and dual graph construction

The edge contraction, described above, serves to illustrate the extent of the problem reduction. Explicit edge contraction as such, however, need not be performed by the algorithm for the above stated reduction in problem size to be realised. The same applies to the construction of the dual graph G^* .

Whether or not edge contraction or G^* construction need to be performed, solely depends on the nature of the algorithm chosen to find the remaining edges of the MST. Matsui [31], for example, requires G^* , and avoids edge contraction by employing a constant time bucketing strategy to keep track of the vertices which are less than four-connected. By contrast, algorithms such as [24, 28] do depend on edge contraction, but do not employ a dual graph as they were not specifically aimed at planar graphs. Such distinction is less obvious in the cases of some algorithms [35, 36, 23] which although make use of edge contraction, their respective asymptotic complexity does not rely on such use.

5.2 Time performance

Steps 1 and 2 visit $n/2$ G vertices, and carry out each operation in $O(1)$ constant time. Similarly, steps 3 and 4 visit $n/2$ G vertices, carrying out each operation in $O(1)$. Therefore the algorithm performs all of its operations in $O(n)$ linear time.

6. A windowing approach

We show here how the various steps of the algorithm are combined and applied to a tile via a sliding window. In addition, we show how the algorithm can be performed without the construction of a dual graph G^* , and how edges to be ruled out can be directly processed in the context of G .

The algorithm is carried out in two phases, processing $n/2$ vertices in each phase.

6.1 Phase 1 – Combining steps 1 and 2

Over all, phase 1 visits $n/2$ vertices.

Figure 7 shows how each of the vertices and edges targeted by steps 1 and 2 can be processed using a sliding window. When the window is in position “a” it performs step 1 on vertex a, ruling in the minimum of a_1, a_2, a_3 and a_4 . It then performs step 2, ruling out the maximum of a_2, a_3, a_5 and a_6 . The window is then moved to position “b” and the same process is similarly repeated, and so on.

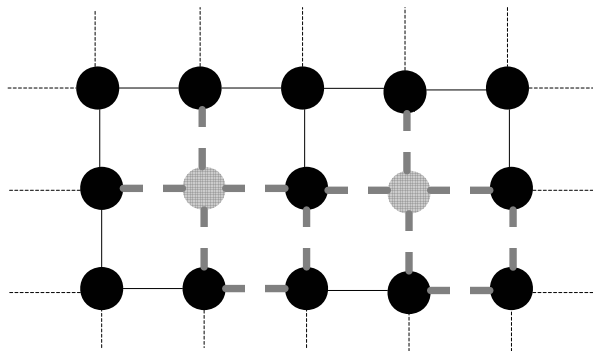

Figure 7 The sliding window visiting position “a” then sliding to position “b”.

Deleted: Although t

Formatted: Font: (Default) Times New Roman

Formatted: Font: (Default) Times New Roman

Formatted: Font: (Default) Times New Roman

Formatted: Font: (Default) Times New Roman

Formatted: Font: (Default) Times New Roman

Formatted: Font: (Default) Times New Roman

Formatted: Font: (Default) Times New Roman

Formatted: Font: (Default) Times New Roman

Formatted: Font: (Default) Times New Roman

Formatted: Font: (Default) Times New Roman

Formatted: Font: (Default) Times New Roman

Formatted: Font: (Default) Times New Roman

Formatted: Font: (Default) Times New Roman

Formatted: Normal, Justified

Deleted: ¶

Figure 7

Operations of Steps 1 and 2 can in fact be carried out in either order. Each sliding window operation will process one vertex and a maximum of 6 edges, and is guaranteed to rule in one edge and rule out another.

6.2 Phase 2 – Combining steps 3, and 4

Phase 2 visits the remaining $n/2$ vertices using the same window shape, [Figure 7](#). The operations of steps 3 and 4 can be carried out, in either order, over the targeted six edges. During this phase there are no guarantees as to the additional number of edges to be ruled in or out, as discussed in a previous section.

Formatted: Normal, Justified

Deleted: ¶
Figure 7

7. Hybrid algorithms

We have shown how our algorithm can be used to reduce the size of the problem to be found by the MST algorithm of choice. We consider here a selection of MST algorithm, with no loss to generality, and how they can be applied to find the remainder of the solution.

7.1 Matsui [31]

Matsui is perhaps the best choice of algorithm for the problem; it is linear time efficient, relatively straightforward to implement, and is specifically targeted at planar graphs.

It is theoretically possible to implement Matsui's algorithm without constructing G^* . On the other hand, G^* provides for a more straightforward implementation.

Regardless of whether G^* is constructed or not, the reduction algorithm needs to keep track of the number of edges incident on G and G^* vertices, as Matsui relies on this information to pick the vertex to be processed next.

This is an additional $O(1)$ operation and does not impact the linearity of the reduction algorithm.

Both the reduction algorithm and Matsui's are linear time efficient, and the resulting hybrid is dominated by Matsui's $O(e + n)$ efficiency.

7.2 Kruskal [37]

Kruskal normally performs worse than Prim [14] in $O(e \log e)$. This is mainly due to its stipulation that all the edges need to be sorted at the start of the algorithm.

This means that even the edge which are eventually ruled out are also sorted, which results in efficiency loss.

The reduction algorithm decreases the number of edges in the graph from $2n$ to n or less. This means that a Kruskal hybrid can be then applied in $O(n \log n)$, which is comparable to using Prim's algorithm without reduction.

7.3 Randomised Karger et al [28]

When Karger is applied to the problem remaining after reduction, it randomly selects half of the remaining n (or less) edges (those neither ruled in or out) to connect the MSF's into a candidate MST. It then uses a linear time $O(e)$ verification algorithm [29] to rule some of these selected edges out of the MST. The process is repeated iteratively until enough edges have been ruled out or a true MST has been identified. The performance of Karger is shown to be exponentially likely $O(e)$, and thus the hybrid is equally exponentially likely $O(n)$.

7.4 Prim [14] hybrid and empirical comparison

Although Prim algorithm is not linear, it is certainly worth consideration as it is one of the simplest to understand and implement of the minimum spanning tree algorithms and is commonly available through most graph theory related computer programming libraries.

Significantly, Prim's is also the algorithm chosen for the tile-based method in its original implementation by Judge [15].

Therefore, we give Prim's algorithm an empirical treatment as well as theoretical.

8. Theoretical analysis

The reduction algorithm need not carry out any additional chores in addition to marking edges when it rules them in or out of the MST.

The ruled out edges help make Prim more efficient by reducing the number of edges it needs to search at each iteration to identify the next edge to connect the next vertex to the MST.

The edges already ruled in by the reduction algorithm effectively define minimum spanning forests (MSF) of vertices. Prim then adds one collection of vertices in a MSF in one of its iterations (as opposed to the usual single vertex), which improves its overall performance. Prim can thus be used to connect the MSFs identified by the reduction algorithm, which amounts to the connected MST.

Prim's algorithm is not linear time efficient, therefore its time complexity dominates the overall performance of the hybrid algorithm.

Deleted:

Deleted: ¶

8.1 Empirical results

For the empirical analysis of our reduction algorithm, we chose to use the Boost Graph Library (BGL) [38] for the following reasons:

- Its credibility. After the Standard Template Library which it extends, the Boost Library is perhaps the most respected in the C++ domain. The BGL in particular is very highly acclaimed.
- Its generality, wide adoption and applicability. The BGL is rapidly becoming the C++ graph library of choice for industry and academia alike.
- It supports an optimised version of Prim's algorithm with a well documented $O(e \log n)$ efficiency.
- Its data structures and algorithms have been designed, implemented, analysed and tested sufficiently rigorously for their respective time efficiency characteristics to be well understood and fully documented.

We implemented our reduction algorithm using the same components which the BGL uses for its native Prim's implementation.

Tile edge size	Vertex count	Time without reduction	Time with reduction	Time for reduction
64	4,096	31	16	0.016

128	16,384	47	16	0.016
256	65,536	156	110	0.094
512	262,144	843	453	0.438
1,024	1,048,576	3,547	2062	2.031
2,048	4,194,304	3,0781	2,0984	20.781

All times shown are in milliseconds. Data obtained using the Boost library version 1.31.0, compiled with Microsoft® Visual Studio .Net 2003, on a Mesh® Computers Plc personal computer: Intel® Pentium® 4 CPU 3.0 GHz, RAM 1 Gigabyte, Microsoft® XP Home Edition 2002 – service pack 2.

Table 1 Worst-case analysis of the enhanced time performance due to the reduction algorithm, in tabular format

Graphs with tile-topology were constructed and assigned random weights using a pseudo-random number generator. The range of edge weights used was 0 – 255, depicting the intensity range of an 8-bit digital camera.

The analysis results are shown in

[Table 1](#), and

[Figure 8](#), and are discussed in the following section.

Formatted: Normal, Justified

Deleted: ¶

Deleted: Table 1

Deleted: ¶

Deleted: Figure 8

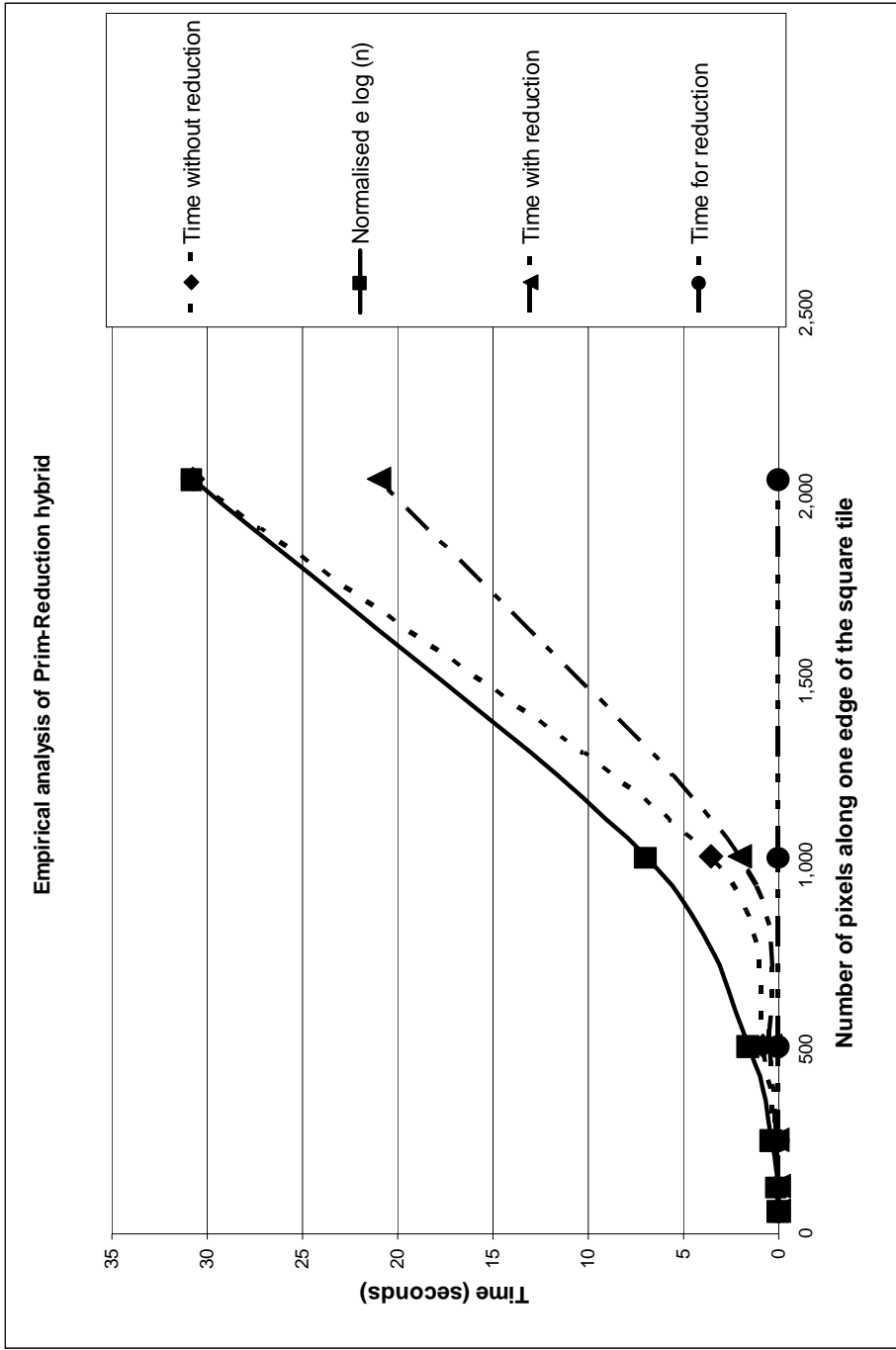

Figure 8 Worst-case analysis of the enhanced time performance due to the reduction algorithm, in chart format

8.1 Empirical worst-case analysis

Phase 1 of our reduction algorithm is guaranteed to reduce the problem's size by one half.

Further reduction by phase 2 is certainly possible, however it is not guaranteed, and its extent is likely to depend on the application in question.

Furthermore, the reduction algorithm is linear by nature. Hence, an estimate of the time performance of phase 2, for a given reduction percentage, can be reliably projected from the analysis results obtained for phase 1.

Therefore, we confined our empirical analysis to phase 1 of the reduction algorithm, and the results of which are shown in the previous section,

Figure 8.

Analysis of tile edge size of less than 64 did not produce meaningful time measurement: Most frequently, the time obtained was zero, indicating that the 1 millisecond resolution of the system clock does not provide sufficient resolution for such measurements.

At the other end of the spectrum, a tile edge size of 2048 (or 4,194,304 vertices) performed less well than the general trend would have otherwise suggested. This is perhaps due to other factors coming into play, such as hard-disk caching⁴.

In general, the results obtained empirically confirm the theoretical performance analysis findings.

It is also interesting to note that the reduction algorithm generally takes 0.1% of the total time taken by the overall hybrid, despite the fact that it reduces the problem's size by 50%.

Although the reduction algorithm halves the problem size, the overall time taken by the hybrid is more than half of that taken by the algorithm without reduction. This is due to the inherent non-linearity of Prim's algorithm.

9. Conclusions

We have shown how the prior knowledge of a tile's graph can help reduce the size of its MST problem by at least one half in linear time. In the best case the problem is completely solved. It would be interesting to learn the probability distribution of the size of reduction for a typical tile, and how this knowledge may further enhance the overall efficiency of the unwrapping algorithm.

It would be interesting to find out if further performance gains can be attained by the relaxation of the criterion of the identification of the unwrapping path from an "absolute minimum" to "minimal. If this was the case, it would be then possible to merely connect any disjoints in the path identified by the problem reduction algorithm, without the need to apply an additional minimum spanning tree algorithm. One could then consider the noise immunity vs. the computational cost achieved by such a partial approach, which ultimately leads to establishing a typical estimate for the computational performance cost vs. the noise immunity gain for a given application.

References

- 1 M Takeda, H Ina and S Khobayashi, S Fourier-transform method of fringe pattern analysis for computer based topography and interferometry, J. Opt. Soc. Am.

⁴ It was observe that hard-disk activity become increasingly pronounced during the progress of this particular tile size.

Formatted: Normal, Justified

Deleted: ¶
Figure 8

Deleted: a

Deleted: p

Formatted: Font: (Default)
Times New Roman, 12 pt

- (1981), 156-60.
- 2 W W Macy Jr., Two-dimensional fringe pattern analysis. *Appl. Optics*, 22 (23), (1983).
 - 3 B Breuckmann and W Thieme, Computer-aided analysis of holographic interferograms using the phase shift method. *Appl. Optics*, 24 (14), (1985), 2145-49.
 - 4 R Thalman and R Dandliker, High-resolution video processing for holographic interferometry applied to contouring and measuring deformations. *SPIE ECOOSA*, Vol. 429, Amsterdam, (1984).
 - 5 B Breuckmann and W Thieme, Computer-aided analysis of holographic interferograms using the phase shift method. *Appl. Optics*, 24 (14), (1985), 2145-49.
 - 6 R Dandliker and R Thalmann, Heterodyne and quasi-heterodyne holographic interferometry, *Optical Engng*, 24(5), (1989), 824-31.
 - 7 J M Huntley and H Saldner, Temporal phase unwrapping algorithm for automated interferogram analysis, *Applied Optics*, 32(17), (1993), 3047-52
 - 8 G T Reid, Automatic fringe analysis - a review, *Optics and Lasers in Engineering*, 7, (1986/7), 37-68.
 - 9 A Etemeyer, U Neupert, H Rottenkolber and C Winter, Schnelle und robuste bildanalyse von streifenmustern - ein wichtiger schritt der automation von hlografischen profprozessen, *Proc. 1st int. Workshop on automatic processing of fringe patterns*. (1989), 23-31.
 - 10 D P Tower, T R Judge and P J Bryanston-Cross, A quasi-heterodyne holograph technique and automatic algorithms for phase unwrapping, *SPIE* 1163, 1989.
 - 11 D P Tower, T R Judge and P J Bryanston-Cross, Analysis of holographic fringe data using the dual reference approach. *Opt. Engng*, 30 (4), (1991), 452-60.
 - 12 D P Tower, T R Judge and P J Bryanston-Cross, Automatic interferogram analysis techniques applied to quasi-heterodyne holography and ESP. *Optics and Lasers in Engng*, 14, (1991), 239-81.
 - 13 T R Judge, T R Quan and P J Bryanston-Cross, Holographic deformation measurements by Fourier reansform technique with automatic phase unwrapping. *Opt Engng*, 31 (3), (1992), 533-43.
 - 14 R C Prim, Shortest connection networks and some generalisations, *Bell Systems Tech. J.*, 36, (1957), 1389-1401.
 - 15 T R Judge, Quantitative digital image processing in fringe analysis and particle image velocimetry, PhD thesis, Warwick university (1992)
 - 16 C Berge, *Graphs and Hypergraphs*, North-Holland, Amsterdam, 1973.
 - 17 J A Bondy and U S R Murty, *Graph theory with applications*, North-Holland, New York, 1976.
 - 18 R G Busacker and T L Saaty, *Finite graphs and networks - an introduction with applications*, McGraw-Hill, New York, 1965.
 - 19 F Harry, *Graph theory*, Addison-Wesley, Reading, MA, 1969.
 - 20 R E Tarjan, Data structures and network algorithms, *Soc Industrial App Math*, Chap 6 (1993), 72-77
 - 21 A Kerschenbaum and R Van Slyke, Computing minimum spanning trees efficiently, *Proc 25th Ann Conf ACM*, (1972), 518-527
 - 22 B M E Moret and H D Shapiro, An empirical analysis of algorithms for constructing a minimum spanning tress, *Lecture notes in computer science* 519, (1991), 400-411
 - 23 M L Fredman and R E Tarjan, Fibonacci heaps and their use in improved

- network optimisation algorithms, *J ACM*, 34 (3), (1987), 596-615
- 24 H N Gabow, Z Galil, T Spencer and R E Tarjan, Efficient algorithms for finding minimum spanning trees in undirected and directed graphs, *Combinatorica*, 6, (1986), 109-122
 - 25 A C Yao, An $O(|E| \log \log |V|)$ algorithm for finding minimum spanning trees, *Information Processing Letters*, 4 (1), (1975), 21-3.
 - 26 B Chazelle, A minimum spanning tree algorithm with inverse-Ackermann type complexity, *J ACM*, 47, (2000), 1028-1047.
 - 27 S Pettie, Finding minimum spanning trees in $O(m\alpha(m, n))$ time, Tech Rep TR99-23, Univ Texas at Austin, 1999.
 - 28 D R Karger, P N Klein and R E Tarjan, A randomised linear-time algorithm to find minimum spanning trees, *J. Assoc. Comput. Machinery*, 42 (2), (1995), 321-28.
 - 29 V King, A simpler minimum spanning tree verification algorithm, *Proc. Workshop on algorithms and data structures*, 1995
 - 30 D Cheriton and R E Tarjan, Finding minimum spanning trees, *SIAM J. Comput.*, 5 (4), (1976), 724-42.
 - 31 T Matsui, The minimum spanning tree problem on a planar graph, *Discrete Applied Mathematics*, 58, (1995), 91-4.
 - 32 G Frederickson, Data structures for on-line updating of minimum spanning tree, with applications, *SIAM J Comp.* 14 (4), (1985), 781-798
 - 33 D Eppstine, G F Italiano, R Tamassia, R E Tarjan, J Westbrook and M Yung, Maintenance of minimum spanning forest in a dynamic planar graph, *Proc 1st ACM/SIAM Symp. Discrete Algorithms*, (1990), 1-11
 - 34 H N Gabow and M Stallman, Efficient algorithms for graphic matroid intersection and priority, *Proc 12th Int. Conf Automata, Languages, and Programming*, Springer-Verlag LNCS, 194, (1985), 210-220
 - 35 O Boruvka, O jistem problemu minimalnim, *Praca Morvavke Prirodovedecke Spolecnosti*, 3, (1926), 37-58 (Czech with summary in German, translated in [36])
 - 36 J Nešetřil, E Milková and H Nešetřilová, Otakar Borůvka on minimum spanning tree problem, *Discrete Mathematics*, 233 (1-3), (2001), 3-36 (English translation of [35])
 - 37 J B Kruskal, On the shortest spanning sub-tree of a graph and the travelling salesman problem, *Proc. Amer. Math. Soc.*, 7, (1956), 48-50.
 - 38 J G Siek, L Q Lee and A Lumsdaine, *The boost graph library*, Addison-Wesley, 2002.

