

AD724192

AD

USAAVLABS TECHNICAL REPORT 71-16
FLIGHT EVALUATION OF ELASTOMERIC BEARINGS
IN AN AH-1 HELICOPTER MAIN ROTOR

By
C. H. Fagan

March 1971

EUSTIS DIRECTORATE
U. S. ARMY AIR MOBILITY RESEARCH AND DEVELOPMENT LABORATORY
FORT EUSTIS, VIRGINIA

CONTRACT DAAJ02-70-C-0020
BELL HELICOPTER COMPANY
A DIVISION OF BELL AEROSPACE CORPORATION
FORT WORTH, TEXAS



Approved for public release;
distribution unlimited.

DDC
RECEIVED
MAY 25 1971
C

Reproduced by
NATIONAL TECHNICAL
INFORMATION SERVICE
Springfield, Va. 22151



**DEPARTMENT OF THE ARMY
U. S. ARMY AIR MOBILITY RESEARCH & DEVELOPMENT LABORATORY
EUSTIS DIRECTORATE
FORT EUSTIS, VIRGINIA 23604**

This report presents the results of a continuing effort in evaluating laminated elastomeric bearings for helicopter rotor applications. The object of this contractual effort was to establish design requirements, to conduct bench tests on pitch change elastomeric bearings, and to publish data resulting from a contractor-sponsored flight test of an all-elastomeric-bearing configured UH-1 helicopter type main rotor.

The feasibility of using only elastomeric bearings in a helicopter main rotor has been proven. Flight test results show that the steady and oscillatory loads for the hub, blade, and controls are comparable to base-line data for the AH-1G production main rotor.

This Directorate concurs in the conclusions contained herein.

The program was conducted under the technical management of Mr. Rouzee E. Givens, Propulsion Division.

Project 1F162203A117
Contract DAAJ02-70-C-0020
USAAVLABS Technical Report 71-16
March 1971

FLIGHT EVALUATION OF ELASTOMERIC BEARINGS
IN AN AH-1 HELICOPTER MAIN ROTOR

Bell Helicopter Report 299-099-485

By

C. H. Fagan

Prepared by

Bell Helicopter Company
A Division of Bell Aerospace Corporation
Fort Worth, Texas

for

EUSTIS DIRECTORATE
U. S. ARMY
AIR MOBILITY RESEARCH AND DEVELOPMENT LABORATORY
FORT EUSTIS, VIRGINIA

Approved for public release;
distribution unlimited.

Unclassified

Security Classification

DOCUMENT CONTROL DATA - R & D

(Security classification of title, body of abstract and indexing annotation must be entered when the overall report is classified)

1. ORIGINATING ACTIVITY (Corporate author) Bell Helicopter Company A Division of Bell Aerospace Corporation Fort Worth, Texas		2a. REPORT SECURITY CLASSIFICATION Unclassified	
		2b. GROUP	
3. REPORT TITLE FLIGHT EVALUATION OF ELASTOMERIC BEARINGS IN AN AH-1 HELICOPTER MAIN ROTOR			
4. DESCRIPTIVE NOTES (Type of report and Inclusive dates)			
5. AUTHOR(S) (First name, middle initial, last name) C. H. Fagan			
6. REPORT DATE March 1971		7a. TOTAL NO. OF PAGES 61	7b. NO. OF REFS 4
8a. CONTRACT OR GRANT NO. DAAJ02-70-C-0020		8b. ORIGINATOR'S REPORT NUMBER(S) USAAVLABS Technical Report 71-16	
b. PROJECT NO. 1F162203A117		8c. OTHER REPORT NO(S) (Any other numbers that may be assigned this report)	
c.			
d.			
10. DISTRIBUTION STATEMENT This document is subject to special export controls, and each transmittal to foreign governments or foreign nationals may be made only with prior approval of the Eustis Directorate, U. S. Army Air Mobility R&D Laboratory, Fort Eustis, Virginia 23604.			
11. SUPPLEMENTARY NOTES		12. SPONSORING MILITARY ACTIVITY Eustis Directorate U. S. Army Air Mobility R&D Laboratory Fort Eustis, Virginia	
13. ABSTRACT Presented in this report are the results of a flight test program conducted to evaluate elastomeric bearings in the main rotor of an AH-1G helicopter. An experimental main rotor was fabricated and tested using only elastomeric bearings in both the flapping and pitch change axes. With this rotor, the flapping bearings carry the rotor drive and lift loads and allow the flapping motions. Two pitch change bearings were used in each grip to carry the blade bending and shear loads and transfer the blade centrifugal force to the rotor yoke. These bearings also accommodate the blade collective and cyclic pitch change motions. Torsional, radial, and axial load deflection curves are given for the flapping and pitch change bearings. In addition, the results from a limited endurance test program are included for the pitch change bearing. The purpose of the endurance tests was to assure that bearing metal parts would not fail prior to elastomer shredding. Thus, visual inspection of the elastomeric bearings was considered sufficient for safety-of-flight during the test program. Flight test results showed satisfactory loads for the blade, hub, and control system. In-flight measured loads are compared with base-line data from the same AH-1G test vehicle at similar operating conditions. Also, calculated natural frequencies and frequency test points, for the experimental rotor, are compared with calculated values for the production rotor. The test results have shown the feasibility of elastomeric bearings for helicopter main rotor applications.			

Unclassified

Security Classification

Unclassified

Security Classification

14.	KEY WORDS	LINK A		LINK B		LINK C	
		NOLE	WT	ROLE	WT	ROLE	WT
	Bearings Elastome r Helicopter Main Rotor UH-1						

Unclassified

2942-71

Security Classification

SUMMARY

Presented in this report are the results of a flight test program conducted to evaluate elastomeric bearings in the main rotor of an AH-1G helicopter. An experimental main rotor (illustrated in Figure 1) was fabricated and tested using only elastomeric bearings in both the flapping and pitch change axes. With this rotor, the flapping bearings carry the rotor drive and lift loads and allow the flapping motions. Two pitch change bearings (as shown in Figures 2 and 3) were used in each grip to carry the blade bending and shear loads and transfer the blade centrifugal force to the rotor yoke. These bearings also accommodate the blade collective and cyclic pitch change motions.

Torsional, radial, and axial load deflection curves are given for the flapping and pitch change bearings. In addition, the results from a limited endurance test program are included for the pitch change bearing. The purpose of the endurance tests was to assure that bearing metal parts would not fail prior to elastomer shredding. Thus, visual inspection of the elastomeric bearings was considered sufficient for safety-of-flight during the test program.

Flight test results showed satisfactory loads for the blade, hub, and control system. In-flight measured loads are compared with base-line data from the same AH-1G test vehicle at similar operating conditions. Also, calculated natural frequencies and frequency test points, for the experimental rotor, are compared with calculated values for the production rotor. The test results have shown the feasibility of elastomeric bearings for helicopter main rotor applications.

FOREWORD

This report was prepared under Contract DAAJ02-70-C-0020, Project 1F162203A117, with the Eustis Directorate, U. S. Army Air Mobility Research and Development Laboratory. The work conducted during Phase I was initiated on 3 March 1970 (bearing fabrication and bench tests) and was completed 1 September 1970. The test results showed the bearings to be satisfactory for the flight test program.

Phase II of the program consisted of rotor hardware fabrication and 9 hours of flight testing on an AH-1G helicopter as a part of Bell's IR&D program. The flight test program was conducted using USAAVLABS "Phase I" flapping and pitch change bearings.

The contracted work was conducted under the technical cognizance of Messrs. J. N. Daniels and E. R. Givens of the Aircraft Subsystems and Equipment Division of USAAVLABS. Principal Bell personnel associated with the program were Messrs. W. Cresap, C. Fagan, R. Lynn, and D. Snyder. In addition, technical assistance was received from Messrs. J. Gorndt, D. Myers, R. Nicoll, and R. Peterson of the Lord Manufacturing Company.

TABLE OF CONTENTS

	<u>Page</u>
SUMMARY	iii
FOREWORD	v
LIST OF ILLUSTRATIONS	viii
INTRODUCTION	1
FLAPPING BEARINGS	5
Description	5
Endurance Tests	5
Spring Rate Test Results	5
PITCH CHANGE BEARINGS	10
Design	10
Radial Spring Rate	12
Torsional Spring Rate	12
Axial Spring Rate	12
Spring Rate Test Results	12
Endurance Test Results	13
Ultimate Axial Load Test	14
FLIGHT TEST EQUIPMENT DESCRIPTION	21
Test Vehicle	21
Main Rotor Configuration	21
FLIGHT TEST PROGRAM RESULTS	24
Introduction	27
Main Rotor Dynamics	27
Flight Test Data	28
Load and Motion Spectrum	29
CONCLUSIONS	50
LITERATURE CITED	51
DISTRIBUTION	52

LIST OF ILLUSTRATIONS

<u>Figure</u>		<u>Page</u>
1	Elastomeric Bearing Rotor Hub	2
2	Pitch Change Bearing and Yoke Extension	3
3	Rotor Hub Components	4
4	Flapping Bearing	6
5	Flapping Hinge Assembly	6
6	Axial Spring Rate and Hysteresis for the Flapping Bearing	7
7	Torsional Spring Rate and Hysteresis for the Flapping Bearing	8
8	Radial Spring Rate of the Flapping Bearing	9
9	Elastomeric Pitch Change Bearing	11
10	Sectioned Pitch Change Bearing	11
11	Radial Spring Rate for the Pitch Change Bearing	15
12	Torsional Spring Rate and Hysteresis for the Pitch Change Bearing	16
13	Axial Load Deflection Curves	18
14	Endurance Tested Pitch Change Bearing	19
15	Axial Load Deflection Curve	20
16	Comparison of Rotor Hub Assemblies	22
17	Elastomeric Pitch Change Bearings	23
18	AH-1G Helicopter Test Vehicle	23

<u>Figure</u>		<u>Page</u>
19	Main Rotor Hub Instrumentation	24
20	Cyclic and Collective Boost Tube Instrumentation	25
21	Main Rotor Blade Instrumentation	26
22	Calculated Rotor Frequency Comparisons - Cyclic Mode	30
23	Calculated Rotor Frequency Comparisons - Collective Mode	31
24	Right-Hand Cyclic Boost Tube Loads Versus Airspeed	32
25	Collective Boost Tube Loads Versus Airspeed	33
26	Main Rotor Red Pitch Link Loads Versus Airspeed	34
27	Main Rotor Red Drag Brace Loads Versus Airspeed	35
28	Main Rotor Yoke Beam Bending Moments (Sta. 5) Versus Airspeed	36
29	Main Rotor Yoke Chord Bending Moments (Sta. 8) Versus Airspeed	37
30	Main Rotor Blade Beam Bending Moments (Sta. 135) Versus Airspeed	38
31	Main Rotor Blade Chord Bending Moments (Sta. 135) Versus Airspeed	39
32	Right-Hand Cyclic Boost Tube Loads Versus Airspeed	40
33	Collective Boost Tube Loads Versus Airspeed	41
34	Main Rotor Red Pitch Link Loads Versus Airspeed	42

<u>Figure</u>		<u>Page</u>
35	Main Rotor Red Drag Brace Loads Versus Airspeed	43
36	Main Rotor Yoke Beam Bending Moments (Sta. 5) Versus Airspeed	44
37	Main Rotor Yoke Chord Bending Moments (Sta. 8) Versus Airspeed	45
38	Main Rotor Blade Beam Bending Moments (Sta. 135) Versus Airspeed	46
39	Main Rotor Blade Chord Bending Moments (Sta. 135) Versus Airspeed	47
40	Collective Boost Tube Load Versus Collective Stick Position	48

INTRODUCTION

Elastomeric bearings are a relatively new development with much promise for oscillatory motion applications. The laminated pad in the bearing consists of alternate layers of elastomer and metal, which are quite thin when compared with the bearing's overall size. The pad is molded (or formed) in a particular shape to accept the specific bearing load and motion design requirements. Thicker metal housings are bonded to each side of the pad to distribute the loads over the bearing surface. This type of bearing, when properly designed and fabricated, is capable of carrying high compressive loads, perpendicular to the laminates, and accommodating oscillatory motions in the elastomer shear direction.

In 1964, Bell Helicopter Company initiated a program to investigate elastomeric bearings for application to helicopter rotor systems. Since that time, the company has flight tested two tail rotor configurations which used only elastomeric bearings in both the flapping and pitch change axes. The satisfactory flight test results for the two rotors are reported in References 1 and 2. An Elastomeric Bearing Symposium was conducted in March 1969 at the Eustis Directorate, U.S. Army Air Mobility Research and Development Laboratory, Fort Eustis, Virginia. The symposium discussions (Reference 3) summarized most of the elastomeric bearing work conducted in the United States prior to that time.

This report presents the results of an all-elastomeric-bearing main rotor test program conducted on an AH-1G "Cobra" helicopter as well as the preliminary qualification testing to verify component design characteristics and to establish fatigue data. The two-bladed seesaw type experimental rotor used elastomeric bearings in both the flapping and pitch change axes. The rotor was evaluated during maneuvers and throughout the speed range of the test vehicle. This program proved the feasibility of the concept and demonstrated the potential of elastomeric bearings for rotor applications.

It is believed that the only elastomeric bearing rotors flown up to the present time are the systems discussed above. The efforts leading up to and including the current tests were joint tasks supported by USAVLABS and Bell Helicopter Company.

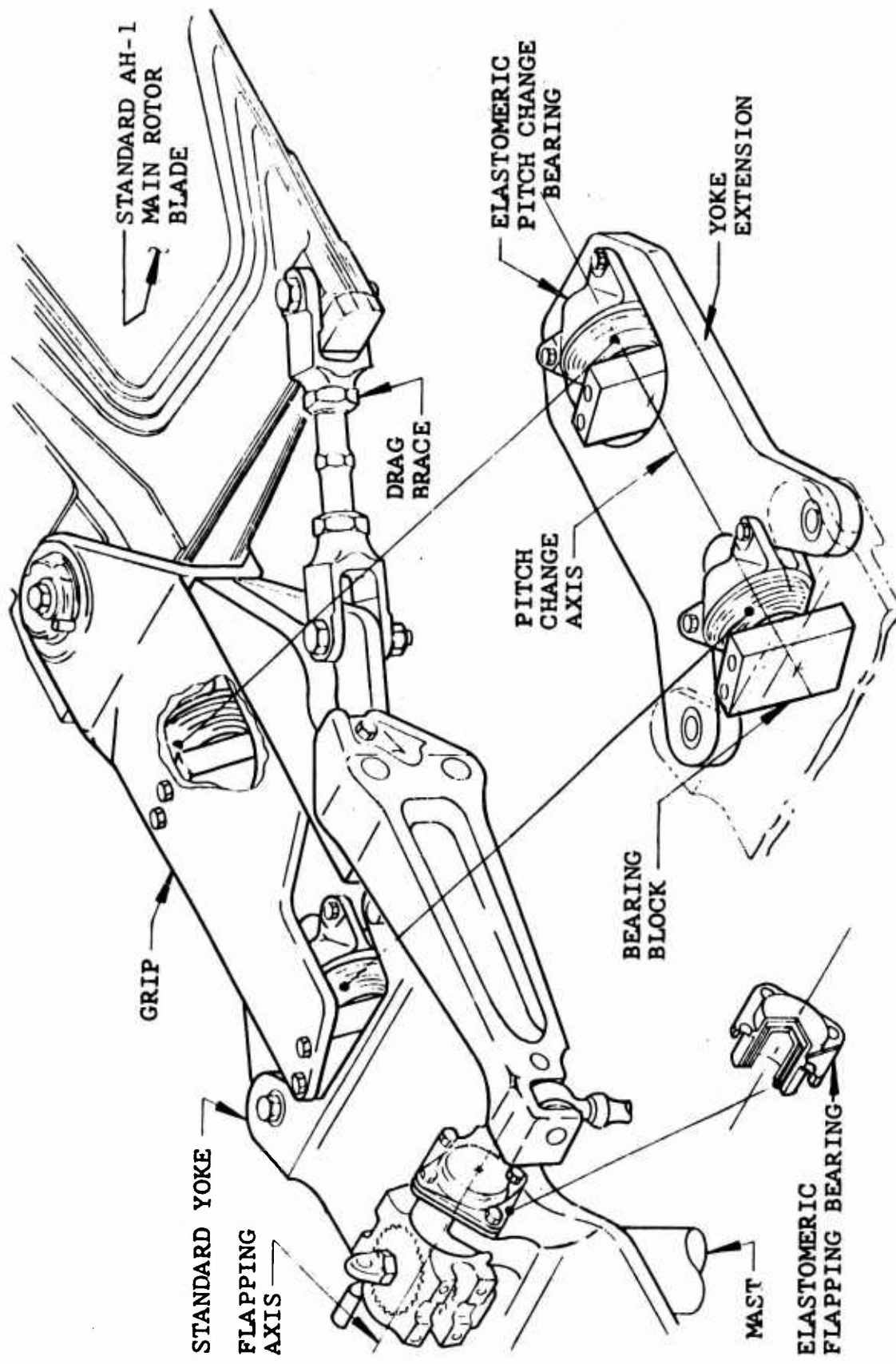

Figure 1. Elastomeric Bearing Rotor Hub.

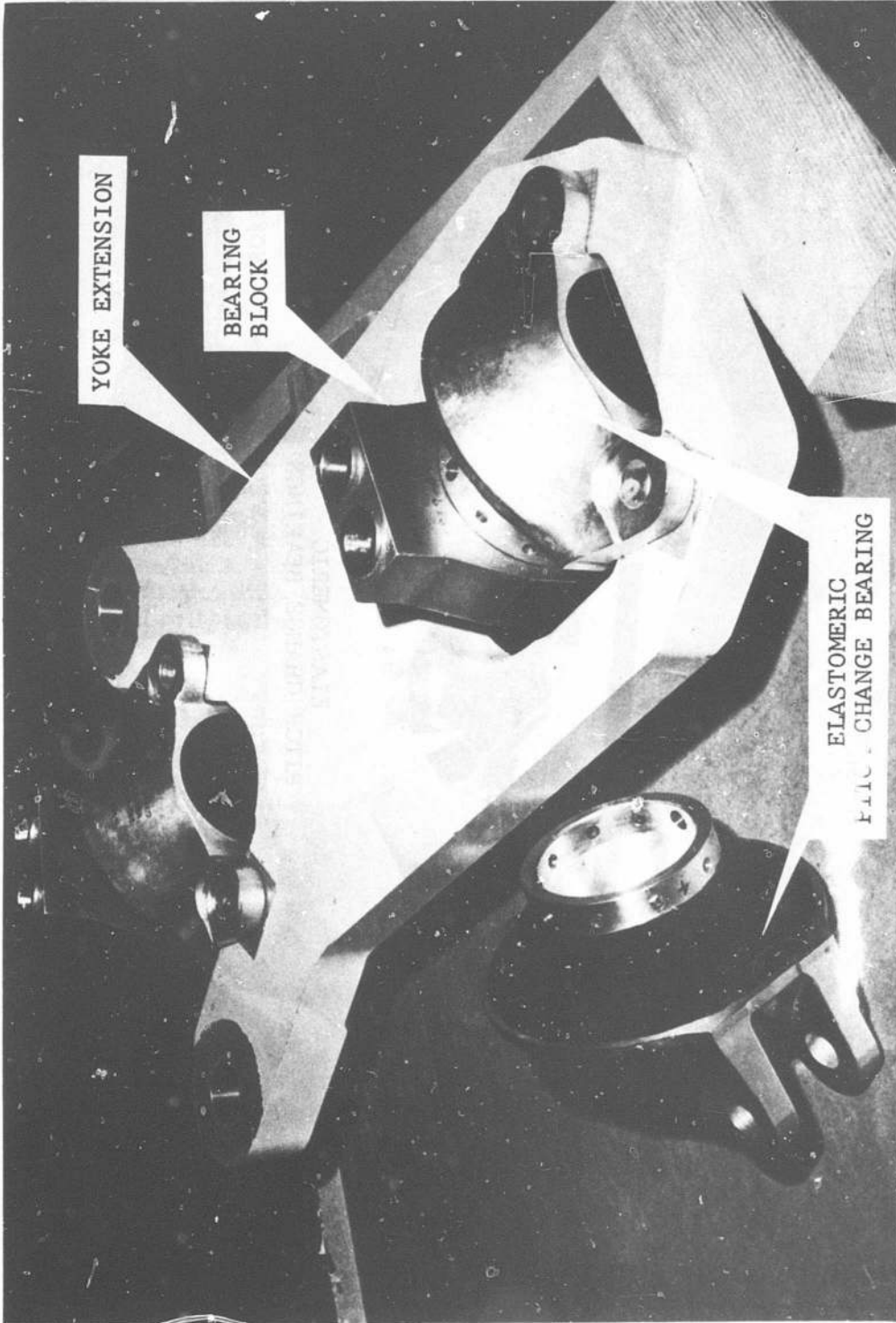

Figure 2. Pitch Change Bearings and Yoke Extension.

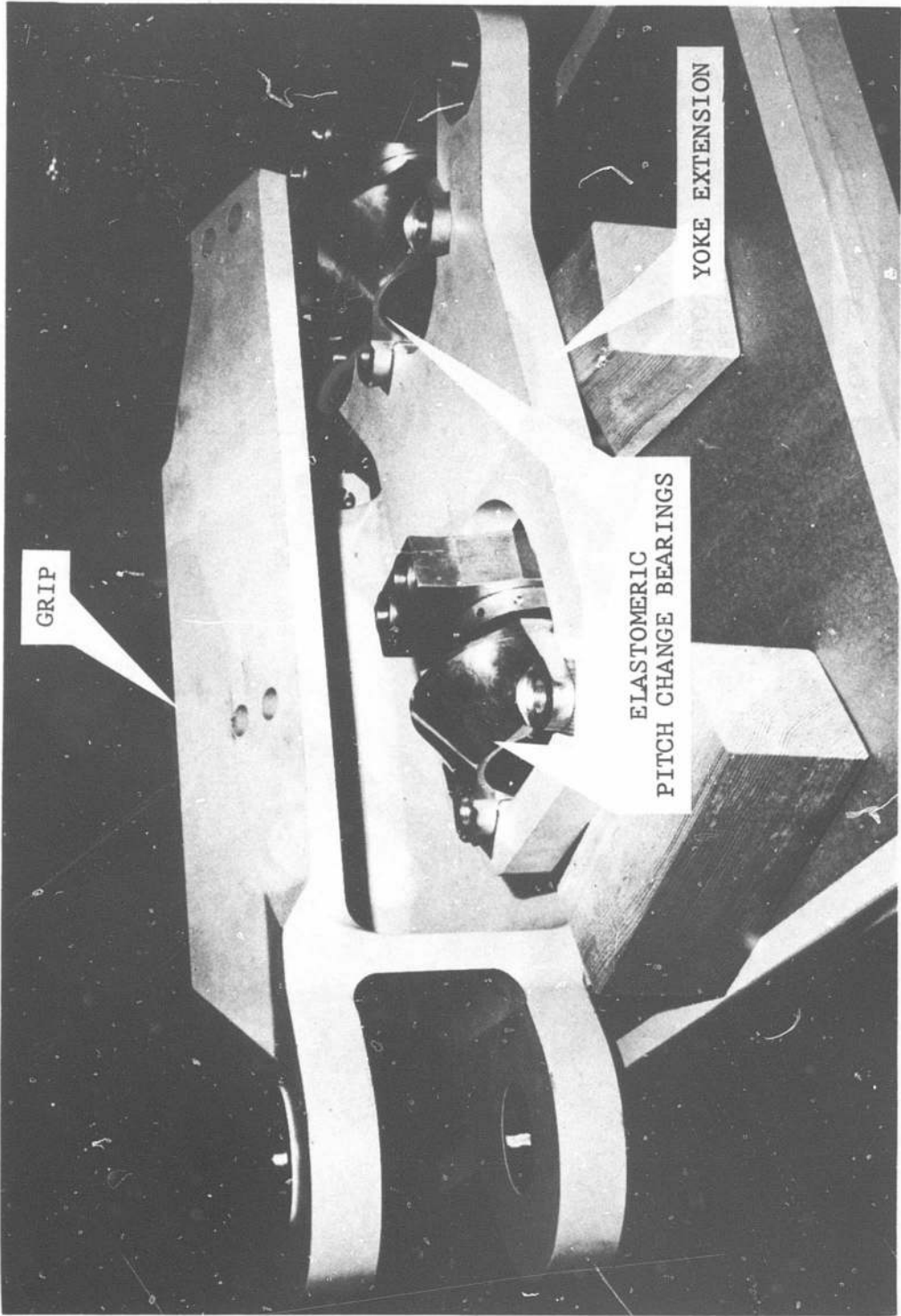

Figure 3. Rotor Hub Components.

FLAPPING BEARINGS

DESCRIPTION

The radial bearing, shown in Figure 4, was designed for use in the main rotor flapping axis of an AH-1 helicopter. Two bearings spaced 9 inches apart are required to carry the rotor lift and drive torque as well as to allow the flapping motions (see Figure 1). The flapping axis assembly is shown in Figure 5.

The bearings consist of concentric layers of elastomer separated by steel cylinders, both of which are approximately 0.05 inch thick. The elastomer pad is 2.5 inches long with an I.D. of 2.0 inches and an O.D. of 3.0 inches. Also, the elastomer pad is contained between thicker steel inner and outer housings. The flapping bearing is shown sectioned in Figure 4b.

ENDURANCE TESTS

During a previous program, endurance tests were conducted to estimate a service life for a similar bearing in the main rotor flapping application. The test conditions selected were believed to be the loads and motions the bearing would receive during normal operation. Thus, 1 hour of testing represented 1 hour of service during helicopter operation. The test program consisted of loading the bearing radially to 27,000 pounds and cycling it torsionally at a frequency of 324 cycles per minute. During 1000 hours of testing, the bearing rotation was ± 4 degrees for 760 hours, ± 6 degrees for 225 hours, ± 8 degrees for 12.5 hours, and ± 10 degrees for 2.5 hours. Three bearing specimens were tested for the 1000-hour spectrum and were in good condition after the tests. Calculations show that 4 degrees of torsional motion develops a shear strain of 0.28 in the elastomer. The radial load (on the elastomer pad) was 5400 pounds per square inch.

SPRING RATE TEST RESULTS

Figures 6, 7, and 8 show load deflection curves for axial, torsional, and radial loading respectively. All bearing load deflection characteristics are considered satisfactory for the AH-1 main rotor application.

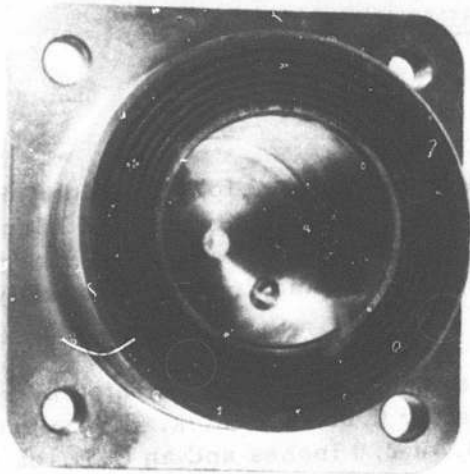

a. Inboard End

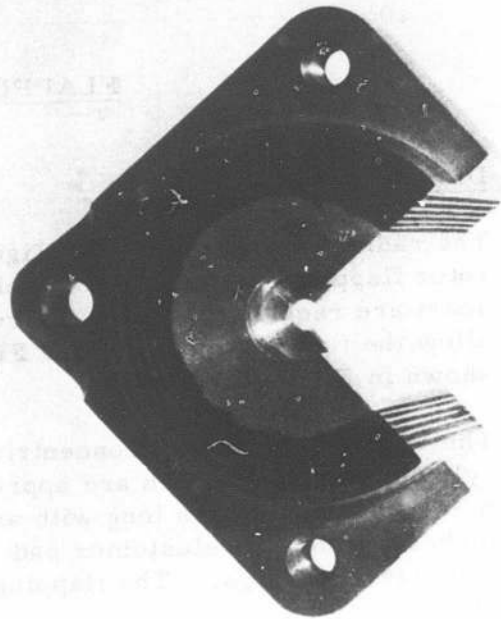

b. Sectioned Bearing

Figure 4. Flapping Bearing.

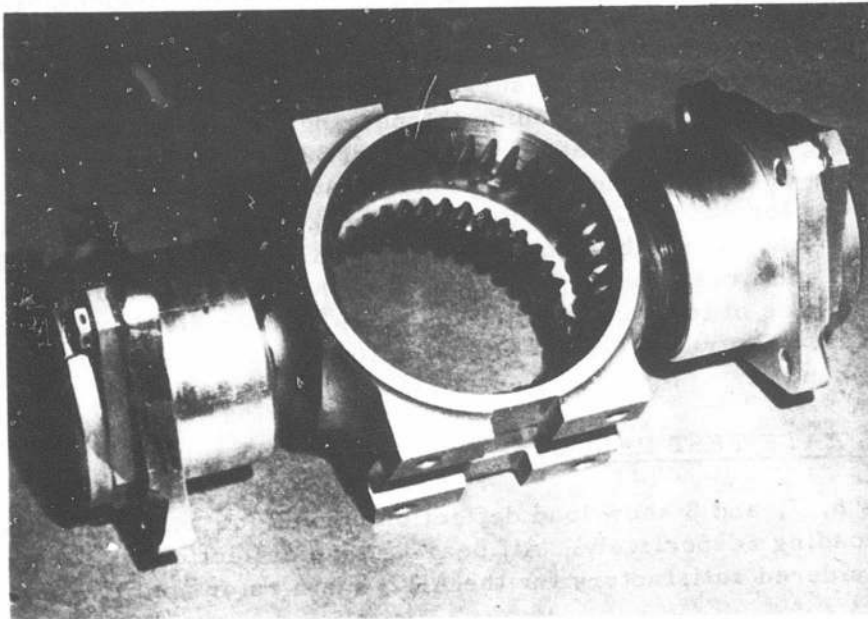

Figure 5. Flapping Hinge Assembly.

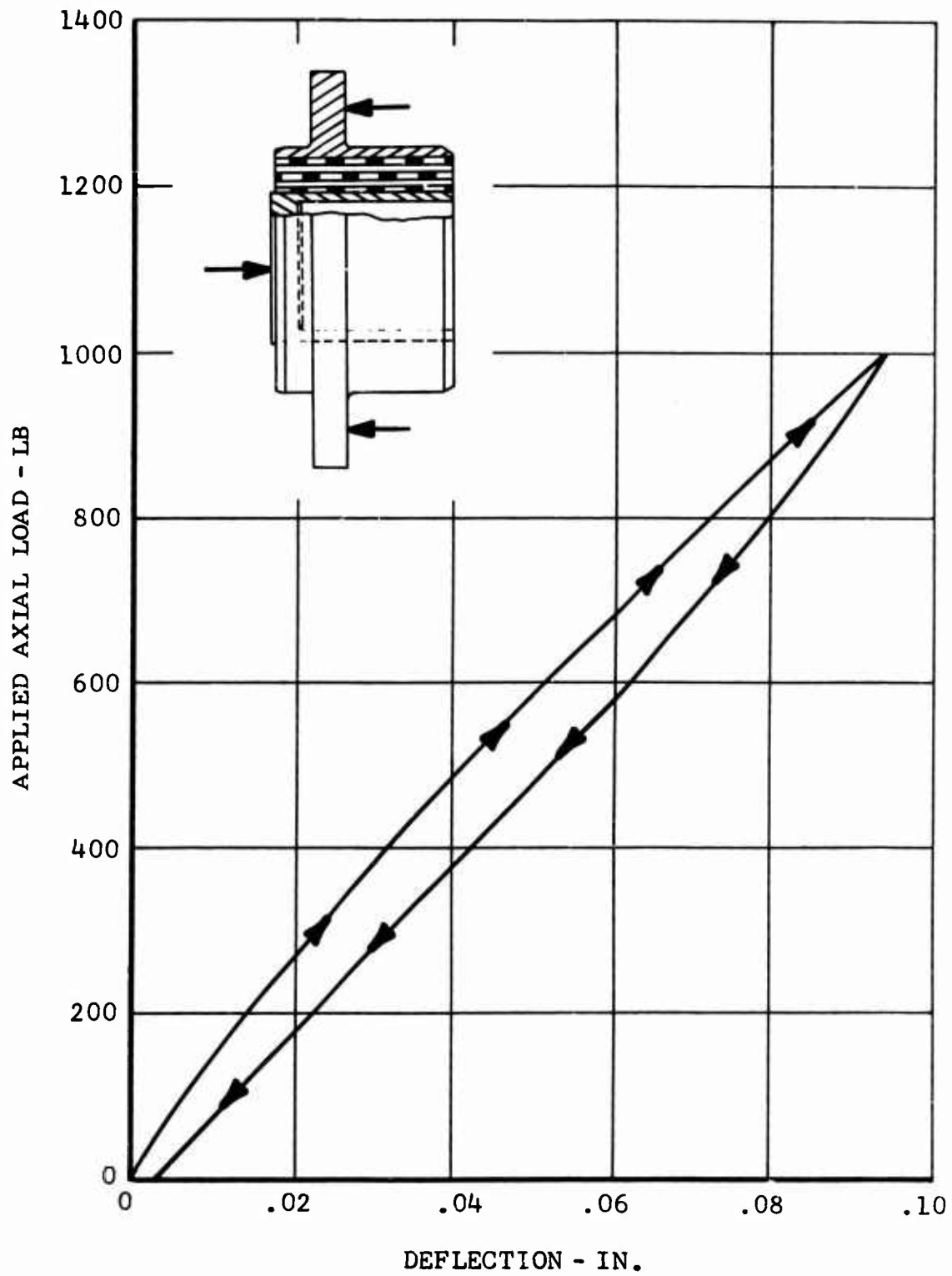

Figure 6. Axial Spring Rate and Hysteresis for the Flapping Bearing (S/N 007).

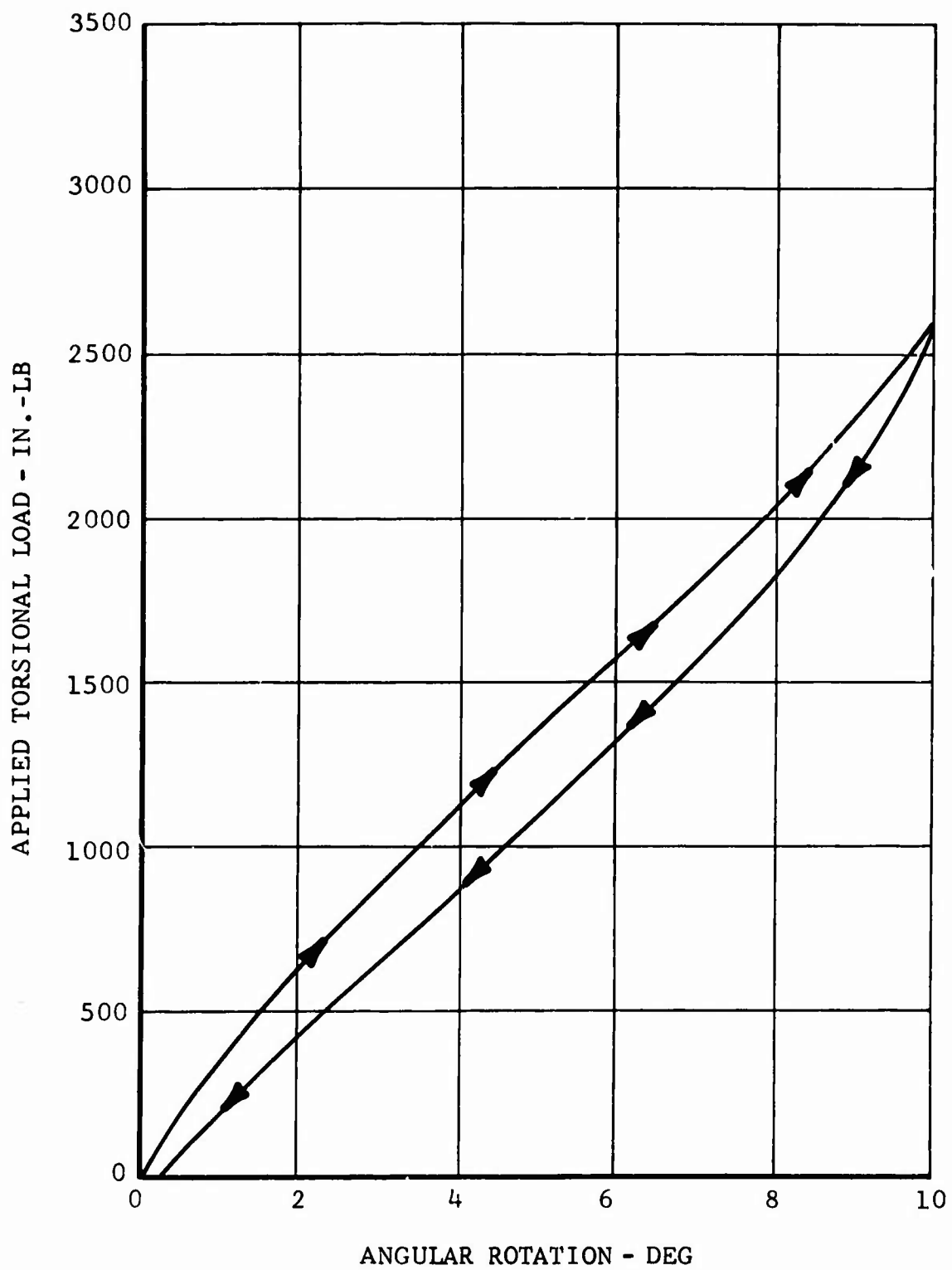

Figure 7. Torsional Spring Rate and Hysteresis for the Flapping Bearing (S/N 007).

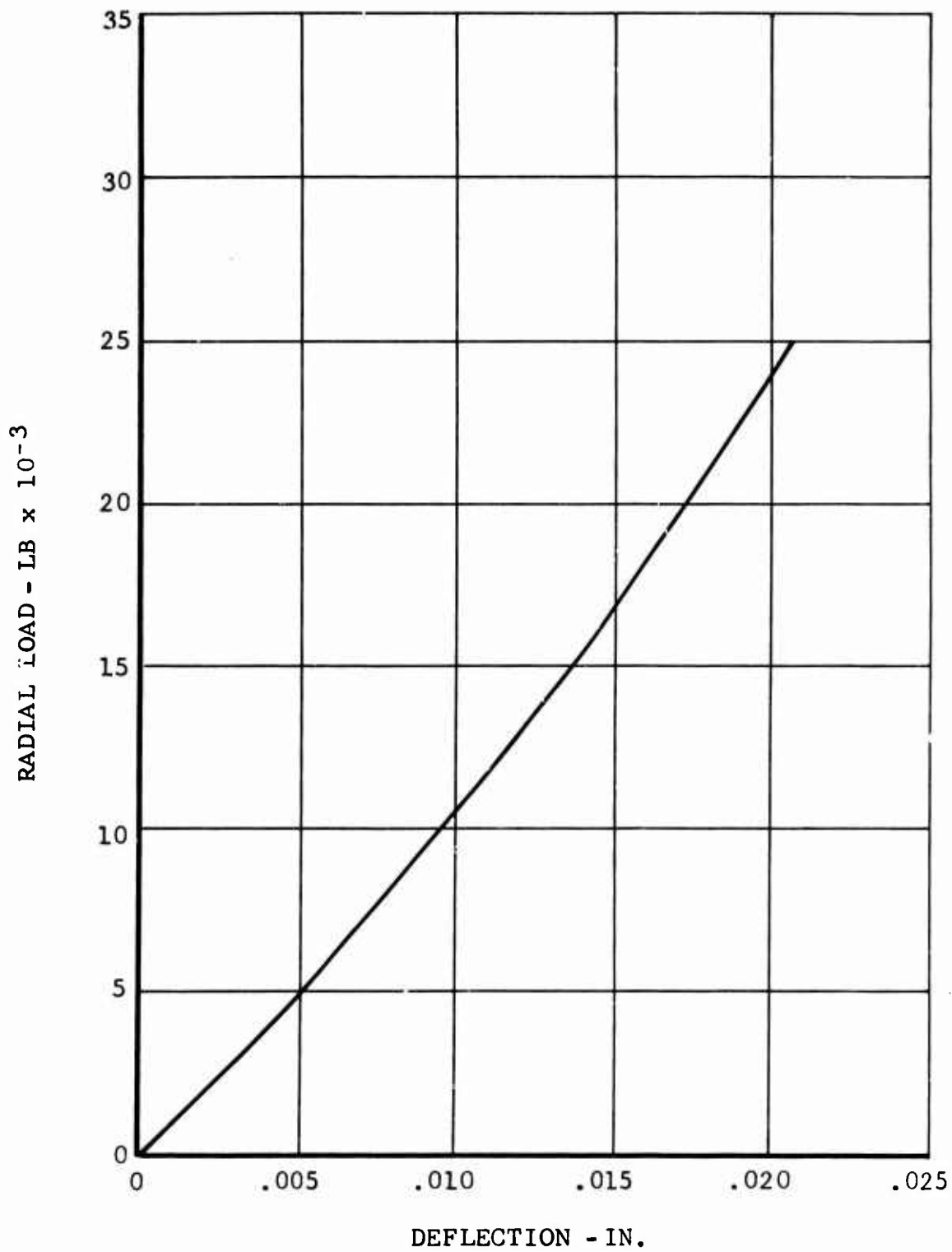

Figure 8. Radial Spring Rate of the Flapping Bearing (S/N 007).

PITCH CHANGE BEARINGS

DESIGN

Two elastomeric pitch change bearings, spaced 15.2 inches apart, are used in each rotor grip as shown in Figure 1. The two bearings are required to carry the blade centrifugal force and to transfer the blade shear and bending loads to the rotor yoke. Also, the bearings accommodate the blade collective and cyclic pitch change motions.

The magnitude of the bearing's radial, torsional, and axial spring rates was a major design consideration. The radial and torsional spring rate values discussed are those for a single bearing while under a 56,000-pound axial load, since each bearing is required to carry one-half of the blade centrifugal force of 112,000 pounds. Operational service life, for the AH-1 main rotor application, was another important factor which affected the design of the bearing.

The final design resulted in a conical part 4.9 inches long, 6.2 inches in diameter at the large end, and 3.7 inches in diameter at the small end (see Figure 9). The elastomer pad is made up of alternating 0.05-inch-thick layers of elastomer and steel. The layers are conic shaped with a 60-degree angle included. Figure 10 shows the final part with a quarter section removed.

The following load and motion criteria (Table I) were used for design purposes. Since establishing these criteria, a more precise load and motion spectrum (which is slightly less severe and should be used for endurance testing) has been developed and is presented in the Flight Test Results section (Table II).

TABLE I. ESTIMATED LOAD AND MOTION CONDITIONS			
Helicopter Operating Condition	Load (lb)		Torsional Motion (deg)
	Axial	Radial	
Parked	0	2,640	0 ± 20
Ground Run (Idle)	12,500	2,640	-11 ± 5
Ground Run (Full RPM)	56,000	10,000	-11 ± 5
Cruise 40% of Flight Time	56,000	10,000 ± 4,000	+ 4 ± 4
Cruise 30% of Flight Time	56,000	10,000 ± 4,000	+ 4 ± 5
Cruise 20% of Flight Time	56,000	10,000 ± 4,000	+ 6 ± 8
Maneuver 10% of Flight Time	56,000	11,800 ± 7,800	+11 ± 12

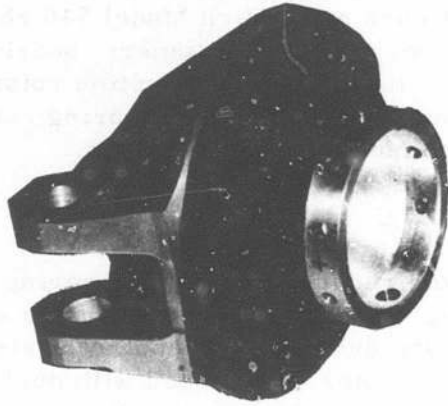

Figure 9. Elastomeric Pitch Change Bearing.

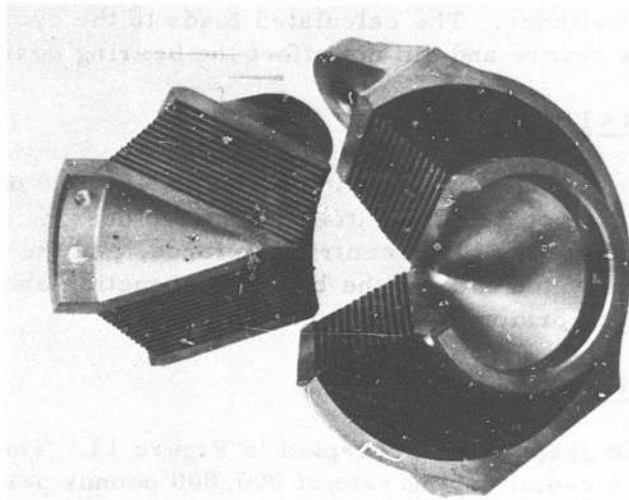

Figure 10. Sectioned Pitch Change Bearing.

RADIAL SPRING RATE

The bearing's radial spring rate was predicated on the rotor assembly's bending stiffness requirement. A design requirement for the new grip assembly was that its in-plane stiffness be equal to that of an existing grip assembly (Bell's Cobra production Model 540 rotor). Thus, the operating frequency modes for the elastomeric bearing rotor were expected to be the same as those of the production rotor. Calculations indicated that a minimum chordwise radial spring rate of 600,000 pounds per inch is necessary to meet this requirement.

TORSIONAL SPRING RATE

The torsional spring rate requirement of the bearing was established as 190 inch-pounds per degree maximum, on the basis of the pitch change bearing's effect on the steady collective control system load. For safety-of-flight, the AH-1G helicopter is equipped with dual hydraulic boost systems, with each system capable of providing satisfactory control. To maintain this provision, the total torsional load of the four bearings (with 15-percent allowable for friction and blade pitch coupling forces) was limited to that which could be accommodated by one boost system. The total collective blade displacement is 23 degrees; assuming bearing installation (for no windup) at 8 degrees, the maximum bearing torsional displacement is 15 degrees. At the established spring rate, the maximum steady load on the collective controls will not exceed the capability of a single boost cylinder. The calculated loads to the cyclic control system were less severe and did not affect the bearing design.

AXIAL SPRING RATE

The bearing axial spring rate was established as 466,000 pounds per inch per bearing and was not a critical item during the design. Two pitch change bearings share the blade centrifugal force, and the established spring rate was expected to keep the blade axial motion about the same as the present tension-torsion strap retention system.

SPRING RATE TEST RESULTS

Radial results are graphically presented in Figure 11. The values show that the part has a radial spring rate of 800,000 pounds per inch, in the blade chord direction. Also, the figure shows that the stiffness in the blade beam direction is 500,000 pounds per inch for the operational range loading, which is less than 200 pounds. Both values are considered satisfactory for the dynamic and flight load-carrying requirement. The

bearing lugs provide additional outer housing support in the chordwise plane, which accounts for the higher spring rate in that direction.

Torsional spring rates were measured while the bearing was under axial loads of 12,500 and 56,000 pounds. Hysteresis curves for torsional rotation to ± 30 degrees are shown in Figures 12a (12,500-pound axial load) and 12b (56,000-pound axial load). Figure 12b shows that the bearing has an operating torsional spring rate of approximately 150 inch-pounds per degree. This value is well below the calculated maximum allowable of 190 inch-pounds per degree.

An axial load deflection curve, for the pitch change bearing, is shown in Figure 13. The curve shows that the bearing will deflect about 0.11 inch under its share of the blade centrifugal force (56,000 pounds). The 0.11-inch blade motion is considered satisfactory based on the deflection of the existing tension-torsion straps.

ENDURANCE TEST RESULTS

Two pitch change bearings were loaded axially from 0 to 150 percent of their normal operating axial load (84,000 pounds each) for 5000 cycles. The condition of one specimen, after the 5000 cycles of testing, is shown in Figure 14. The total axial deflection for each bearing when loaded from 0 to 84,000 pounds was measured after every 1000 cycles. The values recorded are as follows:

<u>Number of Cycles</u>	<u>Deflection (in.)</u>	
	<u>Bearing No. 1</u>	<u>Bearing No. 2</u>
0	.146	.140
1000	.145	.137
2000	.151	.140
3000	.158	.146
4000	.168	.154
5000	.181	.165

Axial load deflection curves for the bearing before and after the test program are shown in Figure 13. Visual appearance of both test specimens after the test program was the same.

The purpose of the fatigue tests was to assure that the bearing metal parts would not fail prior to extrusion or shredding of the elastomer. Thus, the condition of the elastomer can be used as an indication of fatigue load history during the flight test program. Extruded elastomer in areas near the outer housing lugs is shown in Figure 14a. This

condition indicates that the load was not evenly distributed across the bearing. Redesign of the metal outer housing, to obtain additional stiffness perpendicular to the lugs, could result in a part with increased service life.

ULTIMATE AXIAL LOAD TEST

One pitch change bearing was loaded in the axial direction to 200,000 pounds--three and one-half times the operating load. Inspection after the test revealed no damage to the bearing. The load deflection curve in Figure 15 shows the bearing's compression characteristics from 0 to a 200,000-pound axial load.

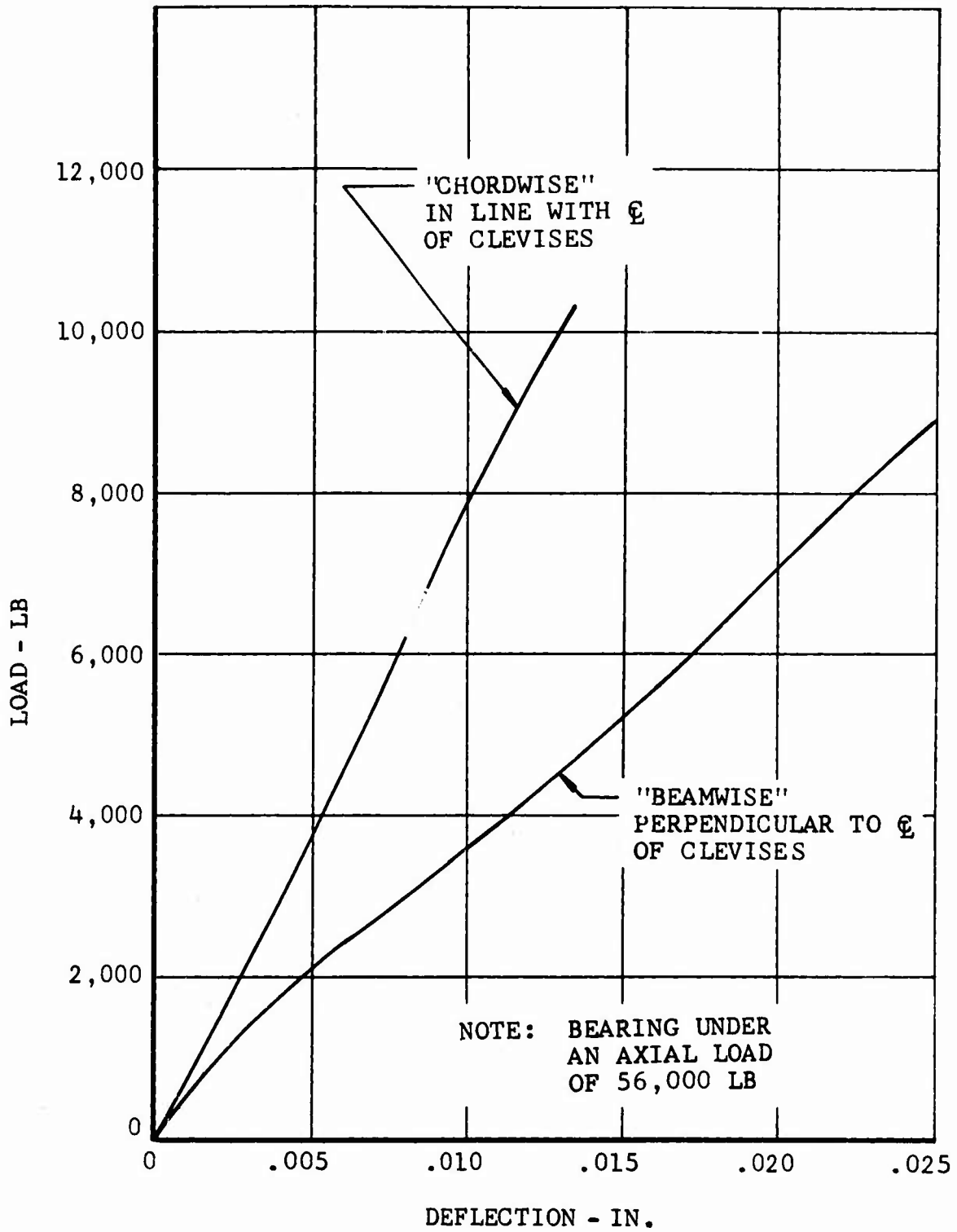
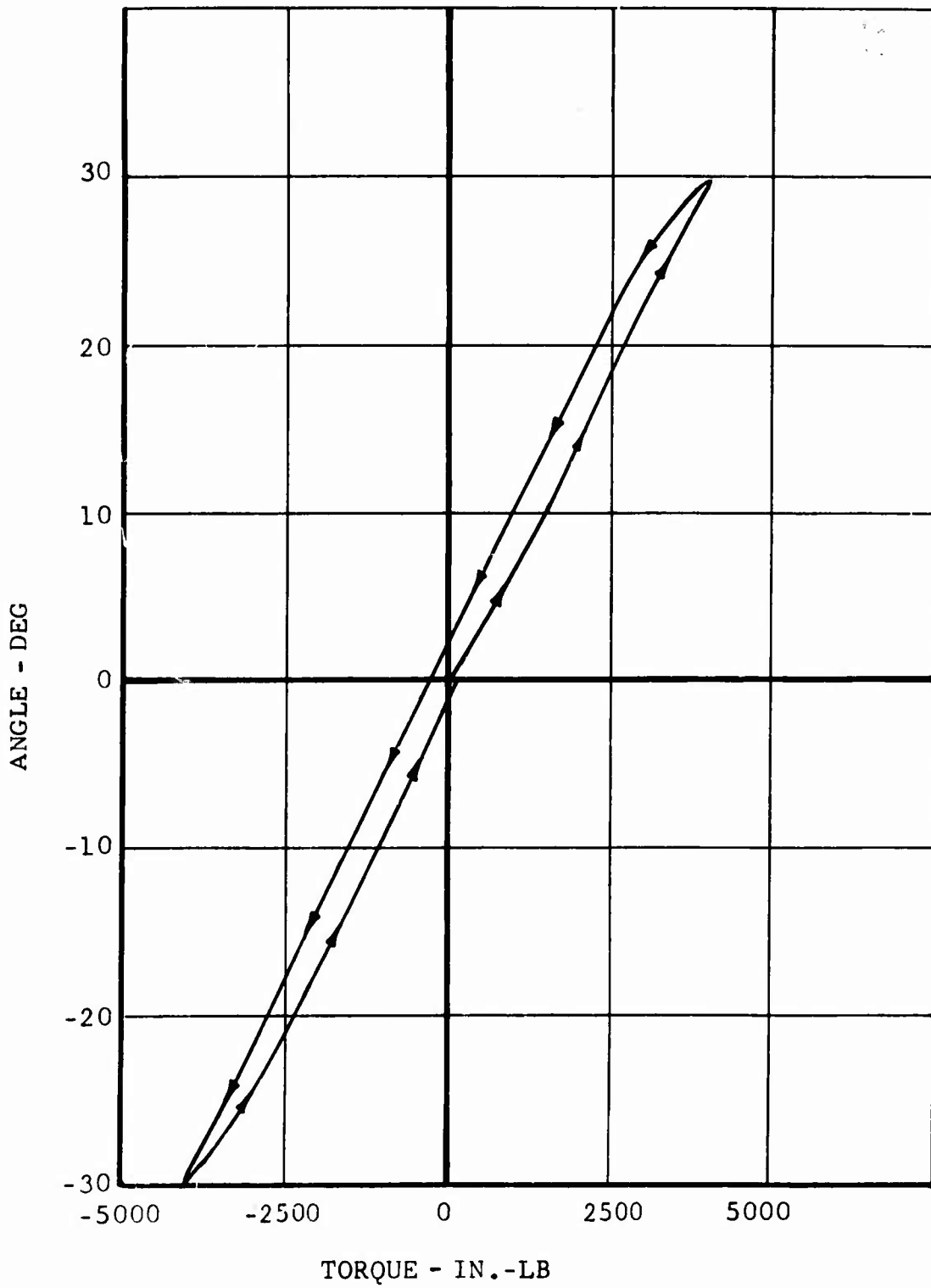
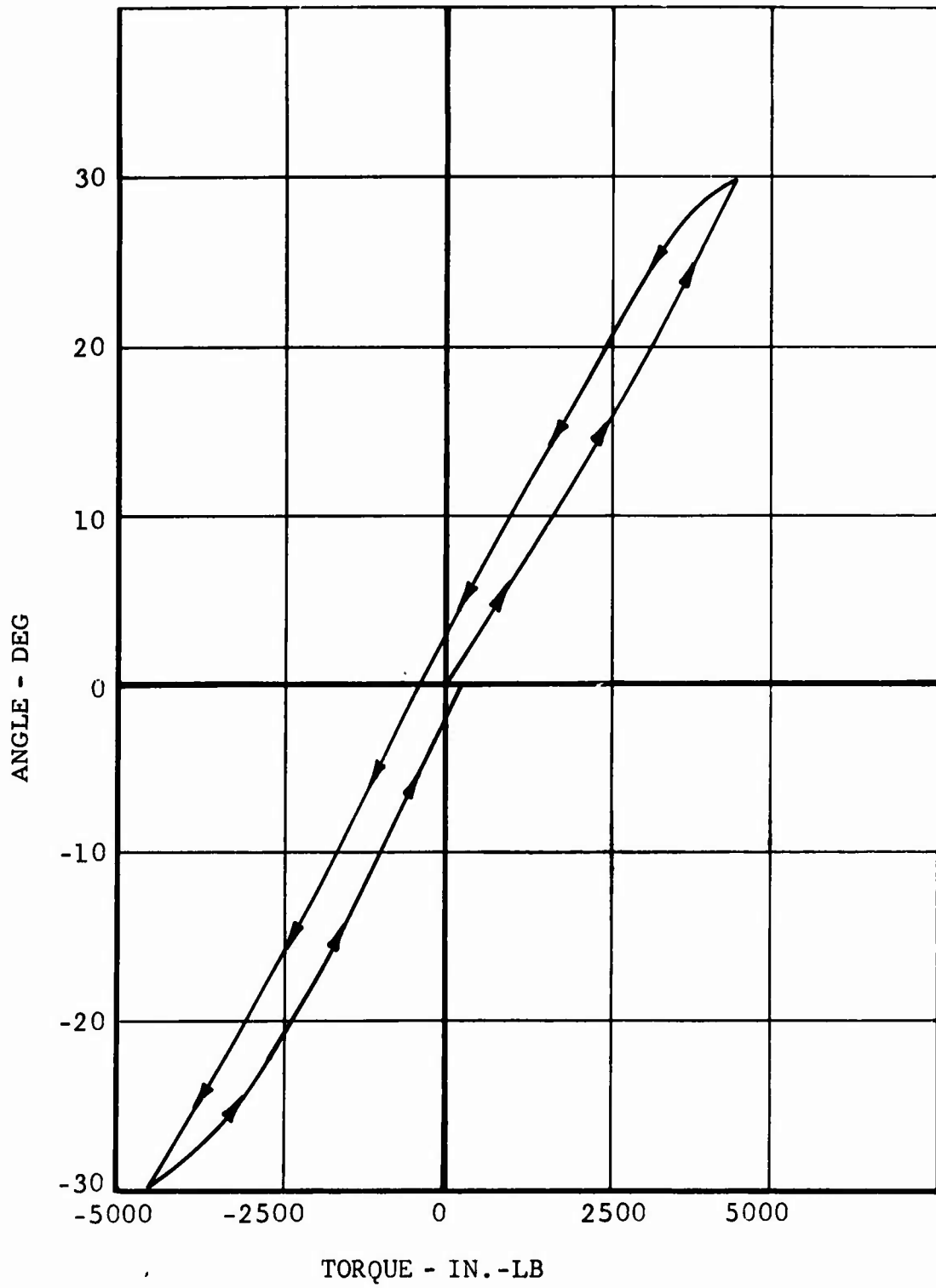

Figure 11. Radial Spring Rate for the Pitch Change Bearing.



a. 12,500-POUND AXIAL LOAD

Figure 12. Torsional Spring Rate and Hysteresis for the Pitch Change Bearing.



b. 56,000-POUND AXIAL LOAD

Figure 12. Continued.

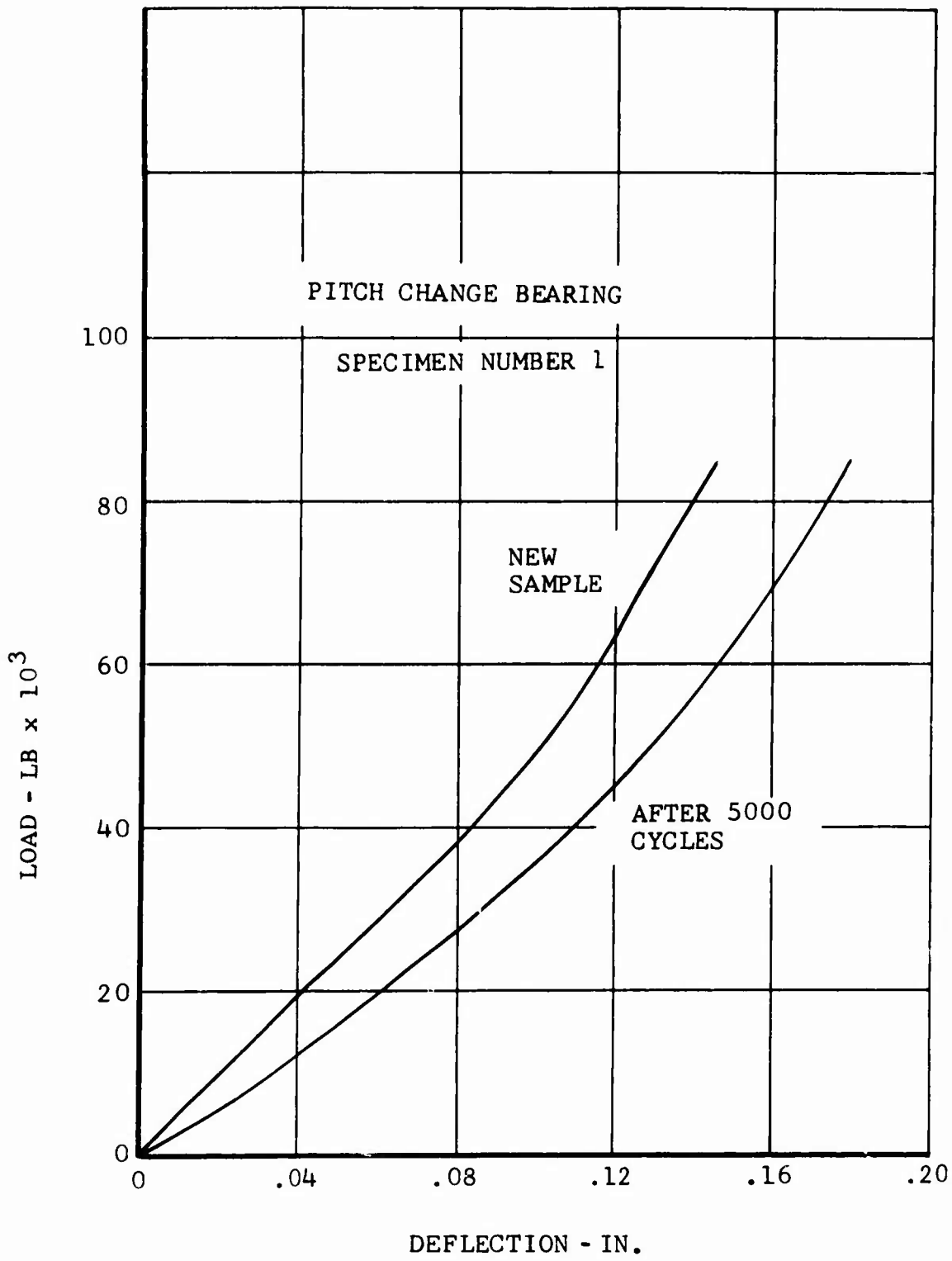
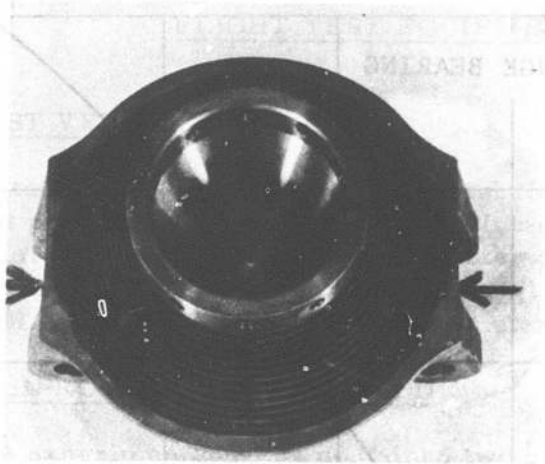
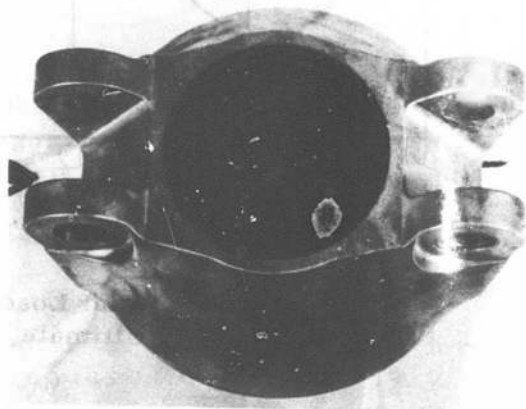

Figure 13. Axial Load Deflection Curves (84,000-Pound Axial Load Endurance Test).



a. Inboard End.



b. Outboard End.

Figure 14. Endurance Tested Pitch Change Bearing.

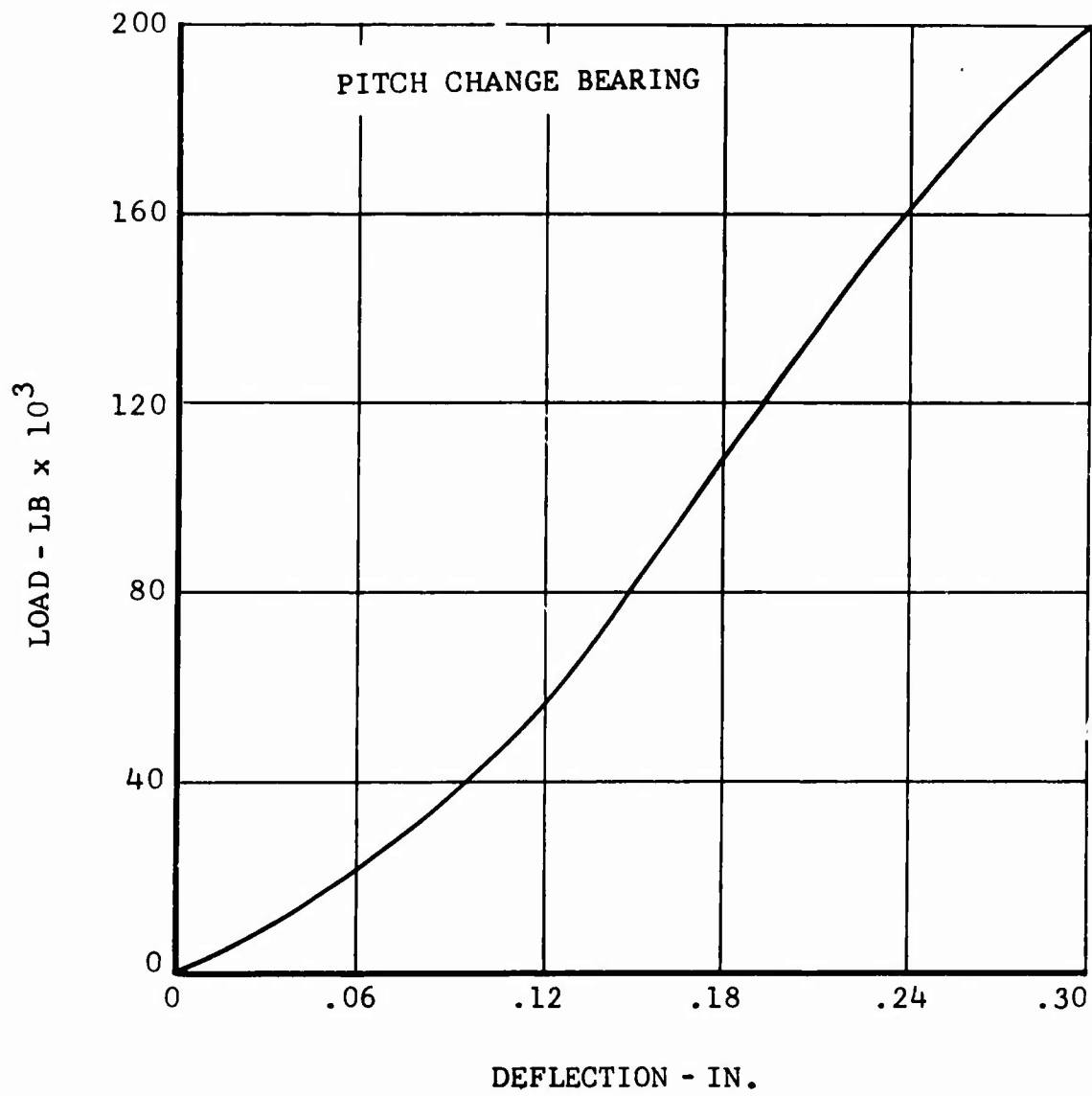

Figure 15. Axial Load Deflection Curve (Ultimate Loading).

FLIGHT TEST EQUIPMENT DESCRIPTION

TEST VEHICLE

A standard AH-1G helicopter, Serial No. 20153, was used for the flight test program. A complete description of the helicopter is given in Reference 4. The standard helicopter differed only in that an experimental rotor was used. Standard AH-1G, 27-inch-chord blades were used, and the production rotor diameter of 44 feet was maintained.

MAIN ROTOR CONFIGURATION

The experimental rotor contained two elastomeric bearings in the flapping axis and two elastomeric pitch change bearings in each rotor grip. Figure 16 shows a comparison of the elastomeric bearing and standard AH-1G rotor hub assemblies. The rotor yoke flexures and pitch horns are the same for both rotors. The mast trunnions are the same except the spindle size of the experimental part was changed to accommodate the small inside diameter of the elastomeric flapping bearing. Figure 17 is a close-up view of the elastomeric pitch change bearing installed in the hub. Figure 18 shows the test helicopter with the experimental rotor installed.

The test rotor was approximately 135 pounds heavier than the production system, as a result of designing the experimental hardware for low-cost, one-of-a-kind fabrication. A weight study was made for a new rotor of the elastomeric bearing type, redesigned to use titanium in lieu of steel and a single-piece flexure and yoke extension. The new rotor weight when compared to the present production AH-1G rotor showed a reduction of 52 pounds.

Instruments were installed to monitor the loads and motions during the flight test program. Locations are presented in Figures 19, 20, and 21.

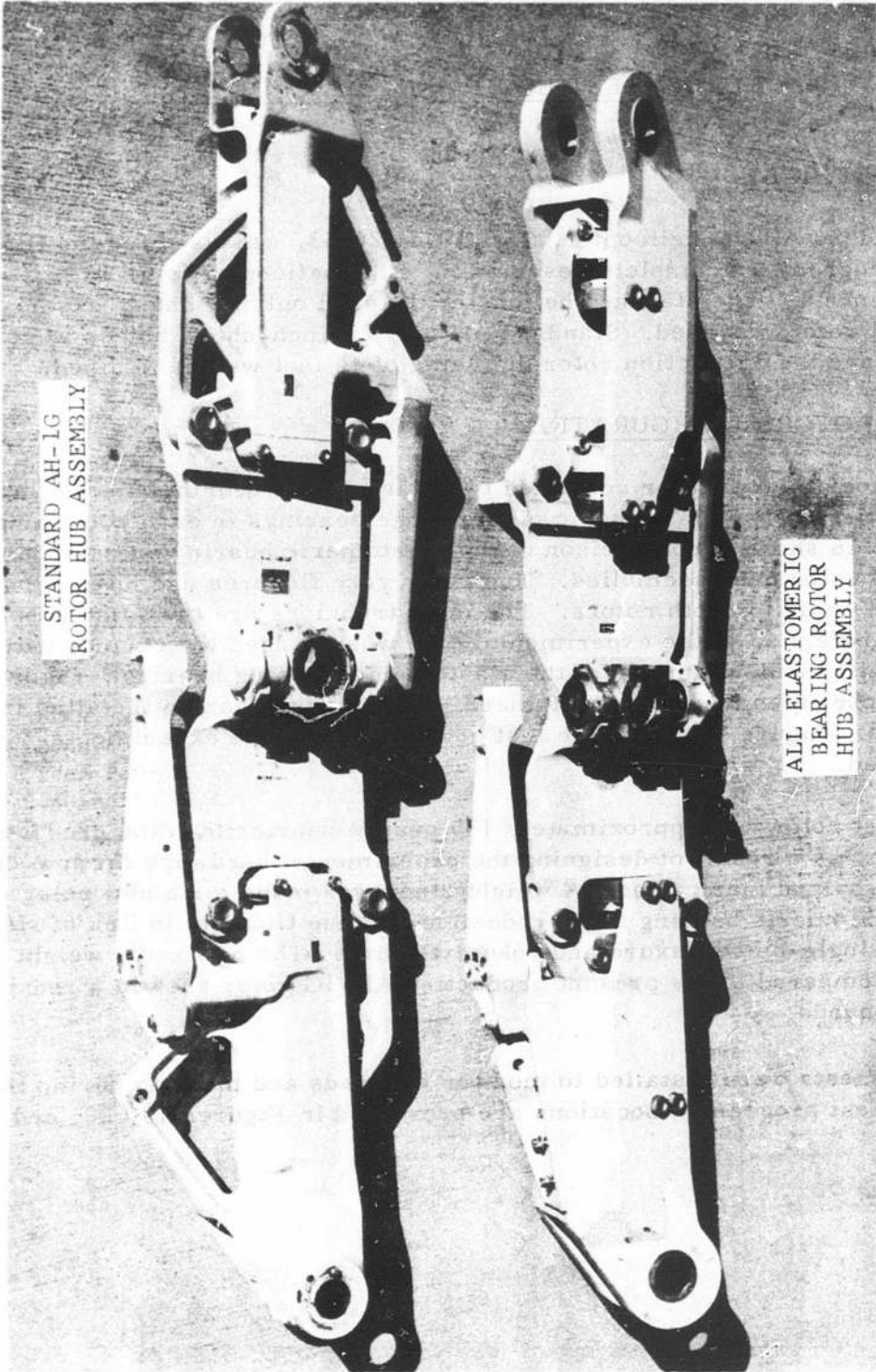

Figure 16. Comparison of Rotor Hub Assemblies.

ELASTOMERIC PITCH
CHANGE BEARINGS

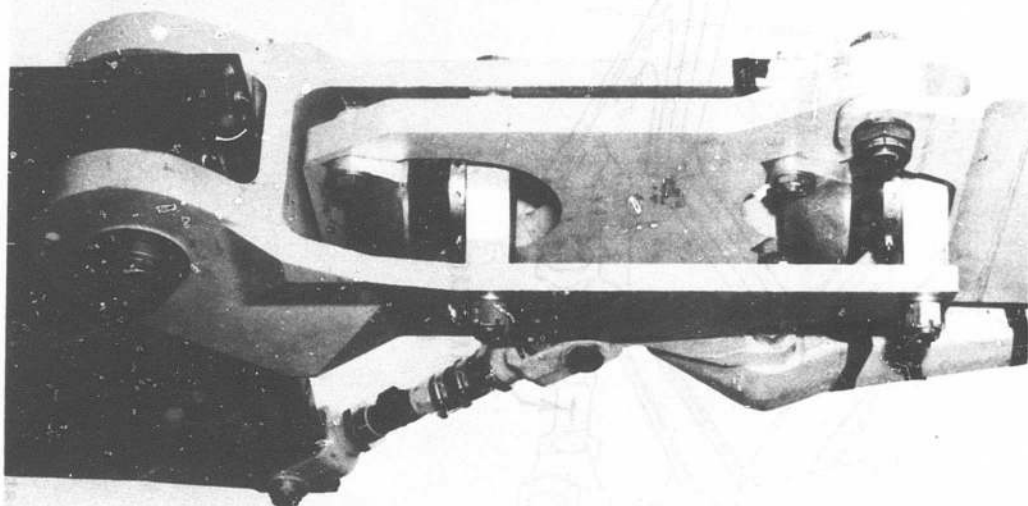

Figure 17. Elastomeric Pitch Change Bearings.

AH-1G HELICOPTER
TEST VEHICLE



Figure 18. AH-1G Helicopter Test Vehicle.

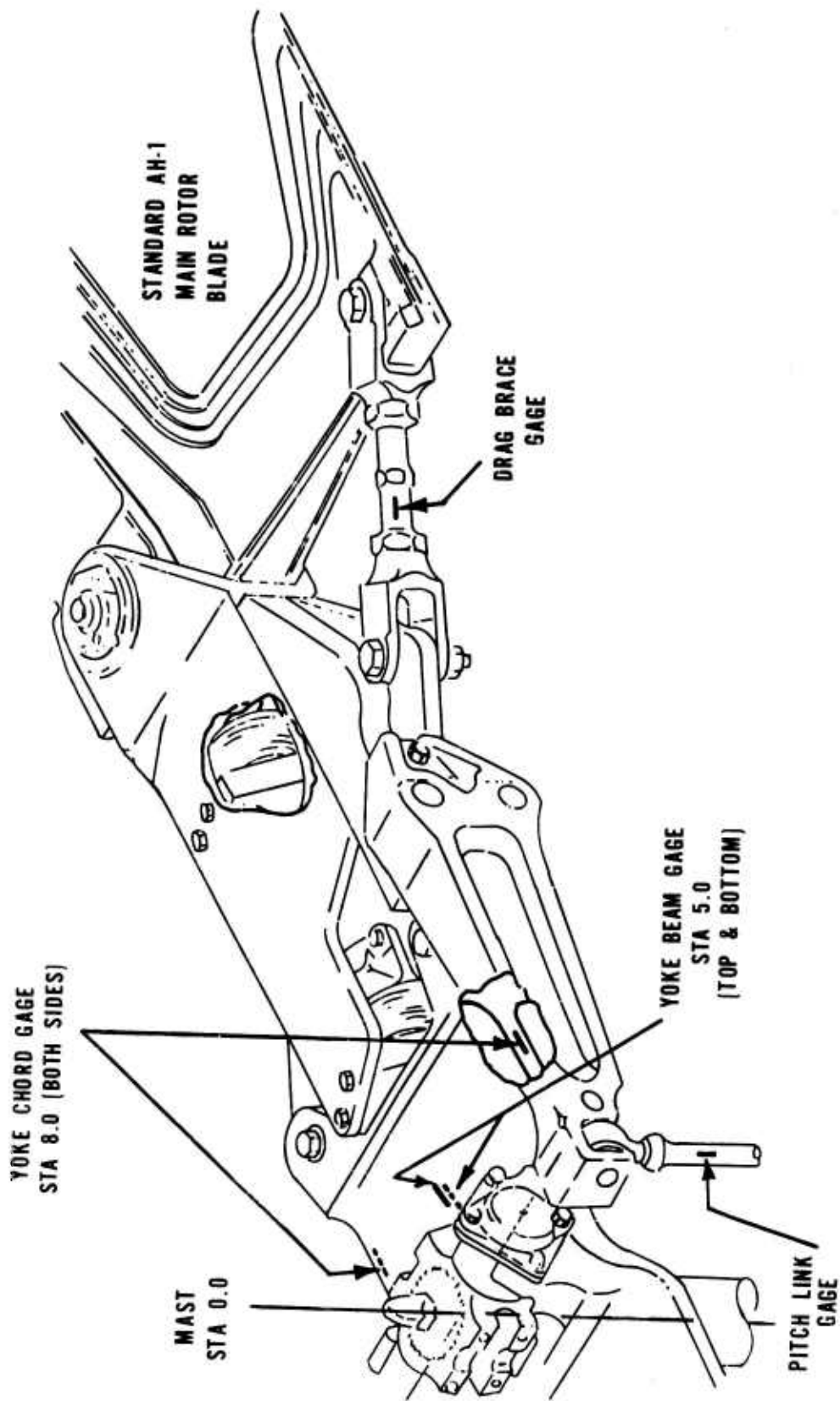

Figure 19. Main Rotor Hub Instrumentation.

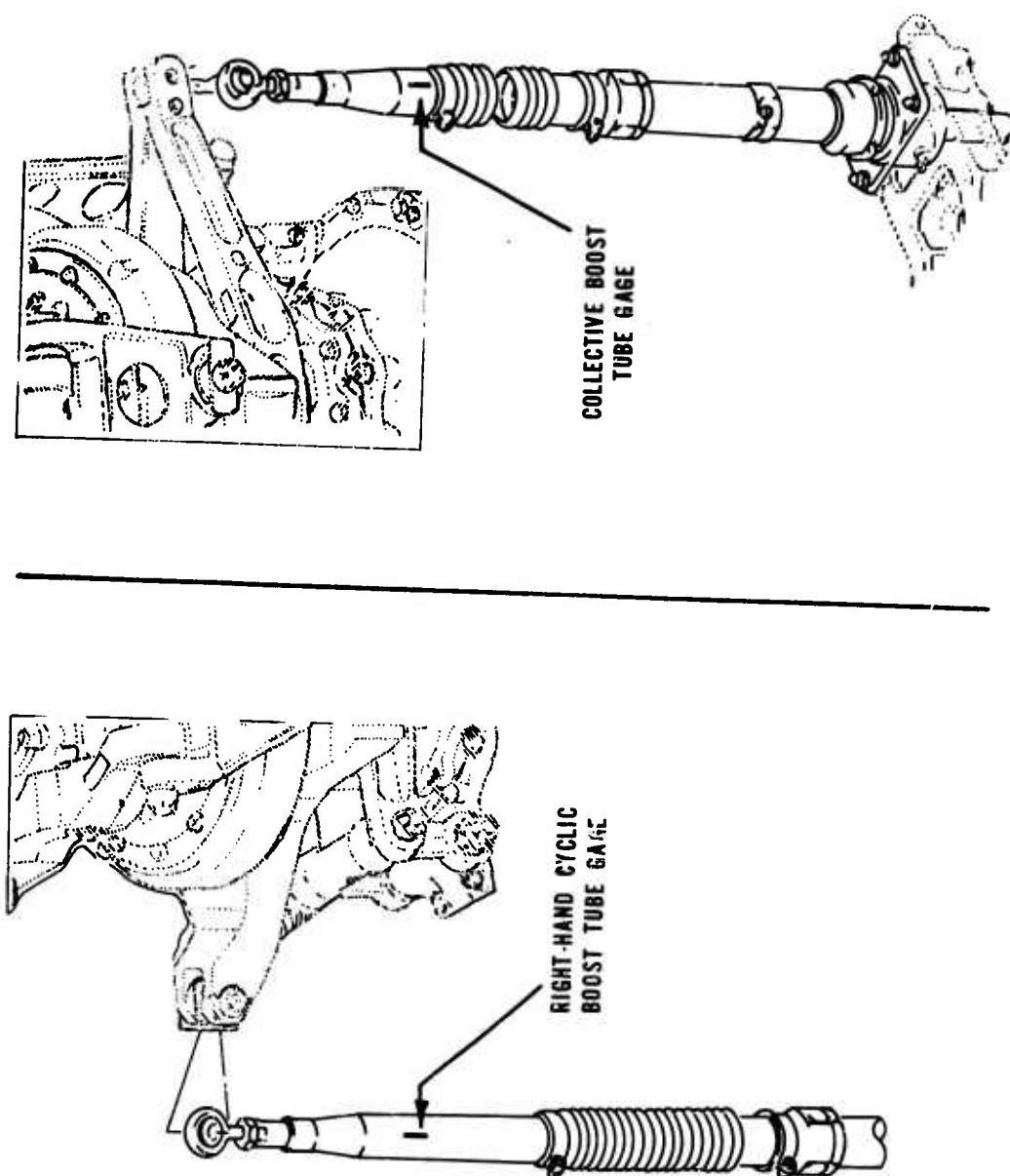

Figure 20. Cyclic and Collective Boost Tube Instrumentation.

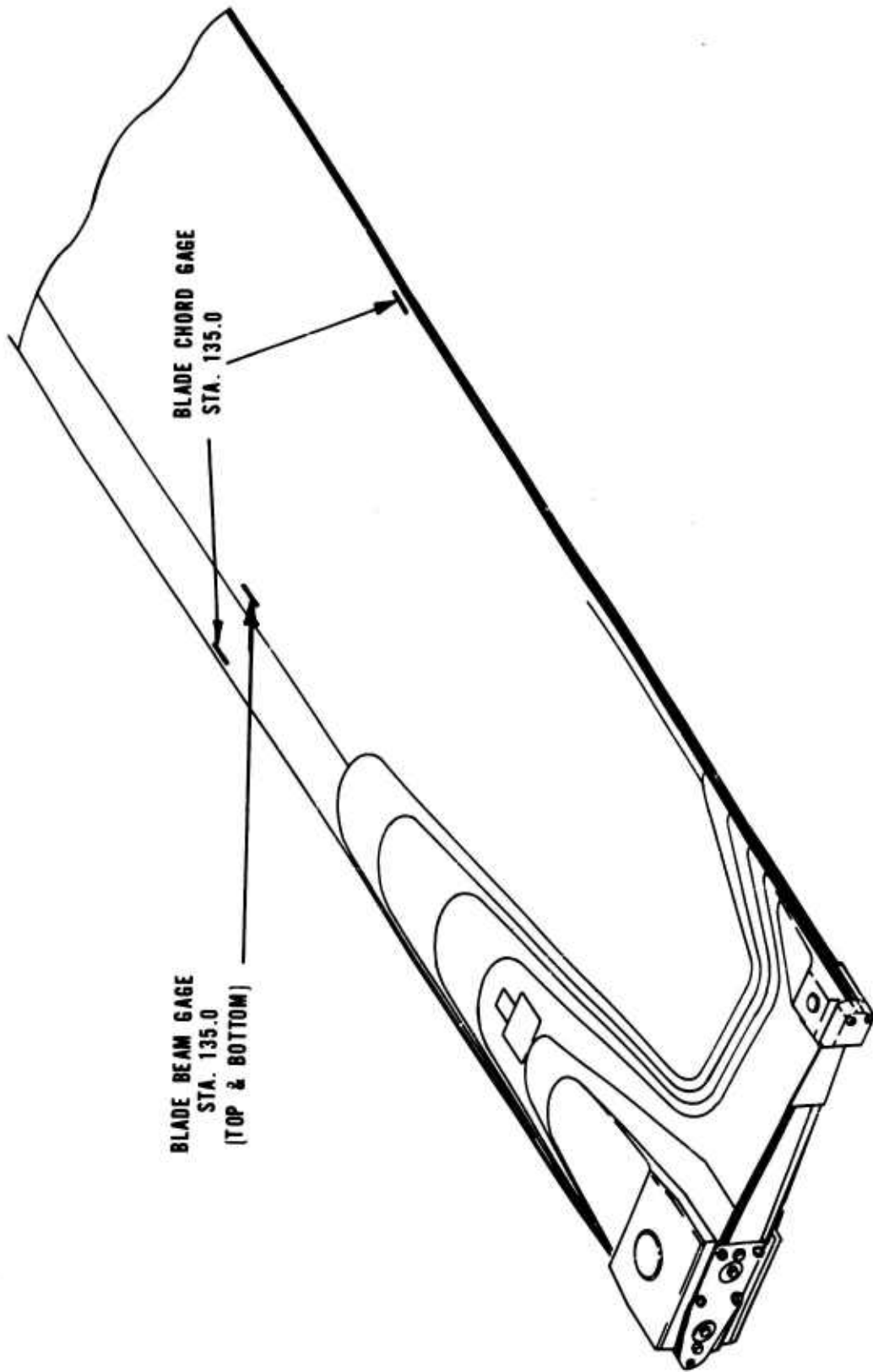

Figure 21. Main Rotor Blade Instrumentation.

FLIGHT TEST PROGRAM RESULTS

INTRODUCTION

The flight test program with the all-elastomeric bearing main rotor was conducted in three phases.

Phase I was a preliminary evaluation at 8000 and 9500 pounds gross weights at neutral cg, and was limited to level flight (at two main rotor speeds), dives, and mild maneuvers. The blades used in this phase were P/N 540-011-001. The desired indexing of the feathering bearings was established, and the concept feasibility was demonstrated.

Phase II was an extension of the preliminary program and evaluated both level flight conditions and medium severity maneuvers at the cg extremes at 9500 pounds gross weight. During this phase, the standard collective friction unit in the rotating controls was successfully deleted due to the inherent damping characteristics of the elastomeric bearings.

Phase III was conducted to evaluate the effects of the latest production configuration main rotor blades P/N 540-011-250 (strengthened trailing edge). This portion of the program was conducted at 9500 pounds gross weight, aft cg, and only level flight conditions at 324 rpm and hover maneuvers were evaluated.

MAIN ROTOR DYNAMICS

Calculated natural frequencies served as a design guide for avoiding dynamic problems in the elastomeric bearing main rotor. The design objective was to preserve the natural frequency characteristics of the AH-1G main rotor. Shown on Figures 22 and 23 are the calculated cyclic and collective mode frequencies for both the all-elastomeric rotor and the standard 540 (Cobra) rotor with P/N 540-011-001 main rotor blades. It can be seen that while the higher modes with the elastomeric rotor are slightly different from the standard rotor, the more important lower modes are very similar. Frequency verification points were obtained during ground-run rpm sweeps and are also shown on the figures. These points indicate that the calculated beam modes are slightly low, the calculated chord modes are high, and the error increases as frequency increases. With this information on actual frequency placement of the prototype rotor, the precise stiffness requirements for a production

system can be established. The production rotor would be "tuned" to avoid all important rotor modes.

FLIGHT TEST DATA

Mean and oscillatory load data from Phase I level flight and dive conditions are presented in Figures 24 through 39. Data are given for flight tests at gross weights of 8000 and 9500 pounds neutral cg, and at main rotor speeds of 314 and 324 rpm. For comparison, data obtained under similar conditions with a standard AH-1G Cobra rotor are also shown on these figures.

Right-hand cyclic and collective boost tube loads are shown in Figures 24, 25, 32, and 33, and main rotor pitch link loads are shown in Figures 26 and 34. The magnitudes of the oscillatory loads obtained with the elastomeric bearing hub are very similar to those obtained with the standard hub. Changes can be made in the steady loads by changes in the indexing of the elastomeric bearings. Figure 40 shows steady collective boost tube loads versus collective stick position. It can be seen that the slope of the line for the elastomeric configuration is slightly greater than the base line. This is caused by the differences in the torsional spring rates between the elastomeric bearings and the standard blade retention strap. The principal factor producing steady collective loads is the chordwise mass distribution of the blades, operating in a centrifugal field, which creates a strong tendency for the blades to return to a low pitch setting. This "tennis racquet" moment is the same for the test and the base-line configuration.

Drag brace loads are given in Figures 27 and 35. Oscillatory loads are similar for the elastomeric bearing configuration and the base line. The steady load increase obtained with the elastomeric bearing hub is the result of a design improvement in the test hub which located the pitch change axis 0.5 inch forward of the production design. This pitch change axis offset was incorporated in the test hub to minimize steady chordwise loads on the bearings by using blade centrifugal force to counterbalance the driving torque loads at cruise conditions.

Rotor yoke and blade loads are given in Figures 28 through 31 and 36 through 39. These figures show comparable loads between the elastomeric configuration and the base line data.

Data from Phase II and Phase III tests are still being analyzed. General conclusions are that the overall load picture with the elastomeric hub is very similar to base-line standard hub data. Some high-frequency

characteristics appear during maneuvers: the placement of the second cyclic chord mode close to 9/rev results in a more objectionable vibration in the ship than the 6/rev buildup during maneuvering with the standard rotor. Flight tests with the latest production main rotor blades (P/N 540-011-250) produced similar results, even though the higher mode natural frequency placements are somewhat different.

Another significant result of the flight test program was the ability to remove the collective friction unit from the rotating controls system. In the standard hub configuration, this friction unit is necessary to prevent intermittent 1/rev rotor-induced vibrations.

Cabin vibration levels with the elastomeric bearing rotor were comparable to, and in many conditions better than, those achieved with the standard configuration.

LOAD AND MOTION SPECTRUM

The load and motion spectrum given in Table II was compiled from actual flight loads and more nearly represents average flight conditions than those available when the bearings were designed. These data do not include adverse environmental conditions; however, flight conditions have been weighted to cover the AH-1G helicopter flight spectrum.

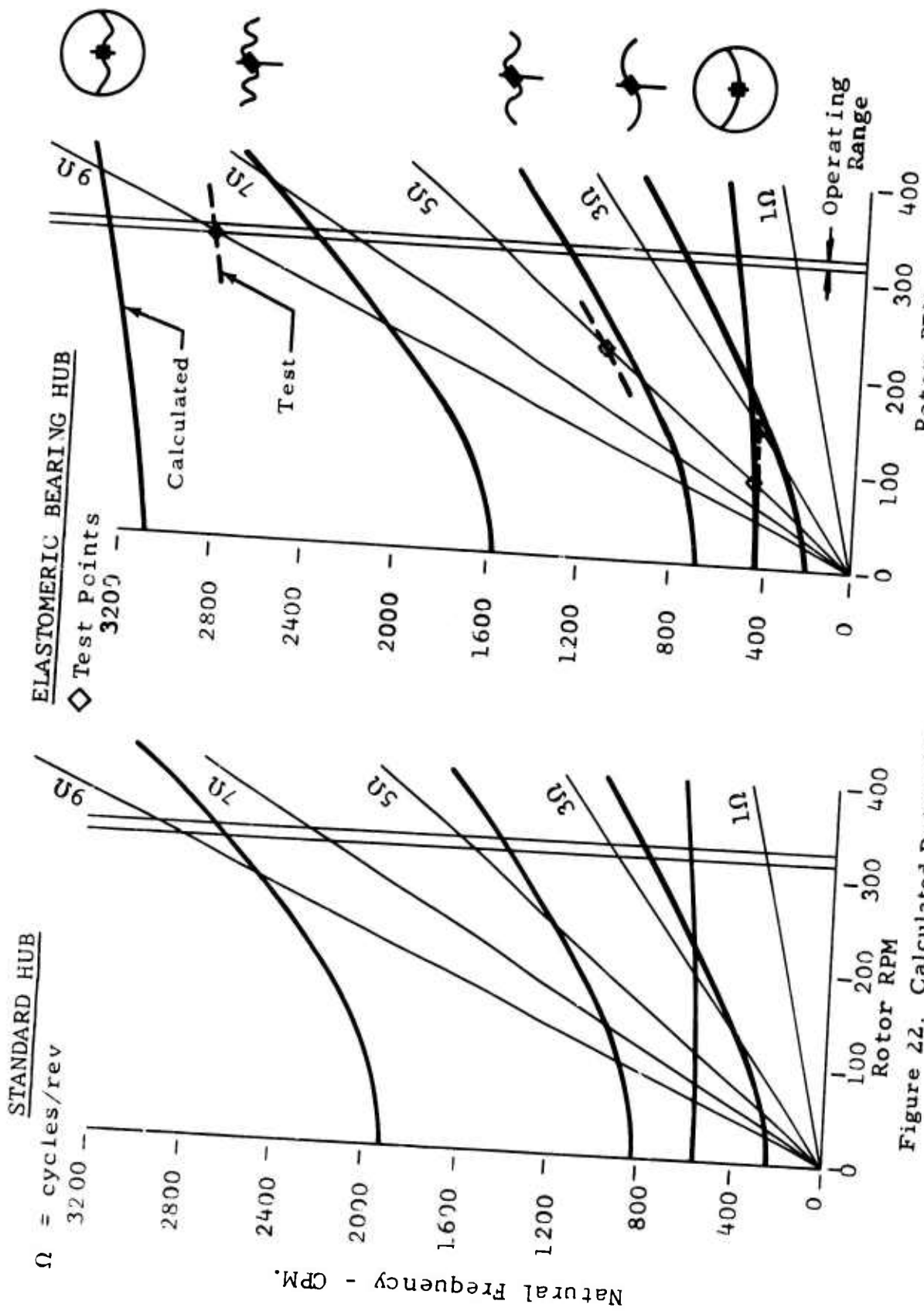

Figure 22. Calculated Rotor Frequency Comparisons - Cyclic Mode.

STANDARD HUB

ELASTOMERIC BEARING HUB

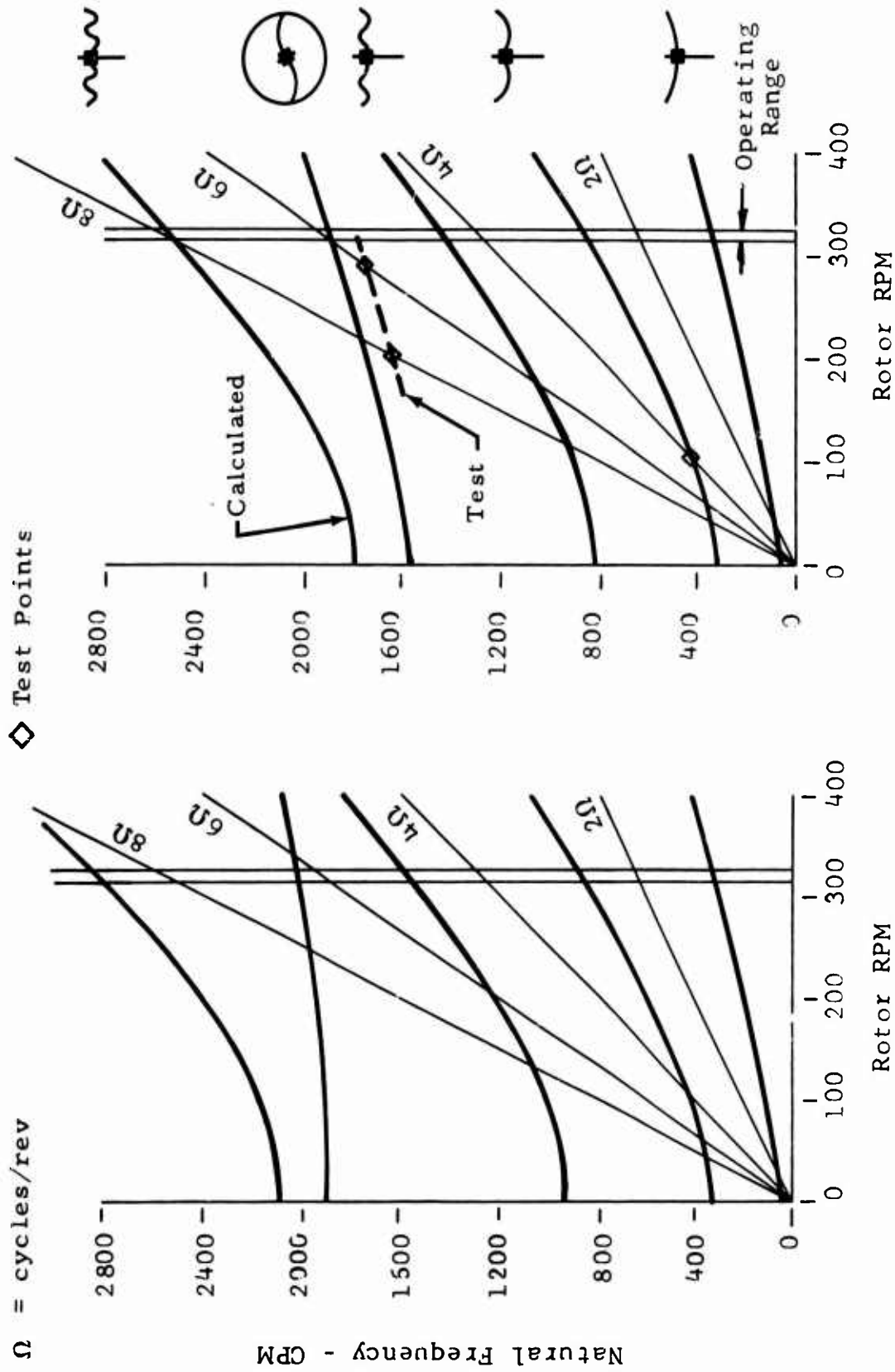
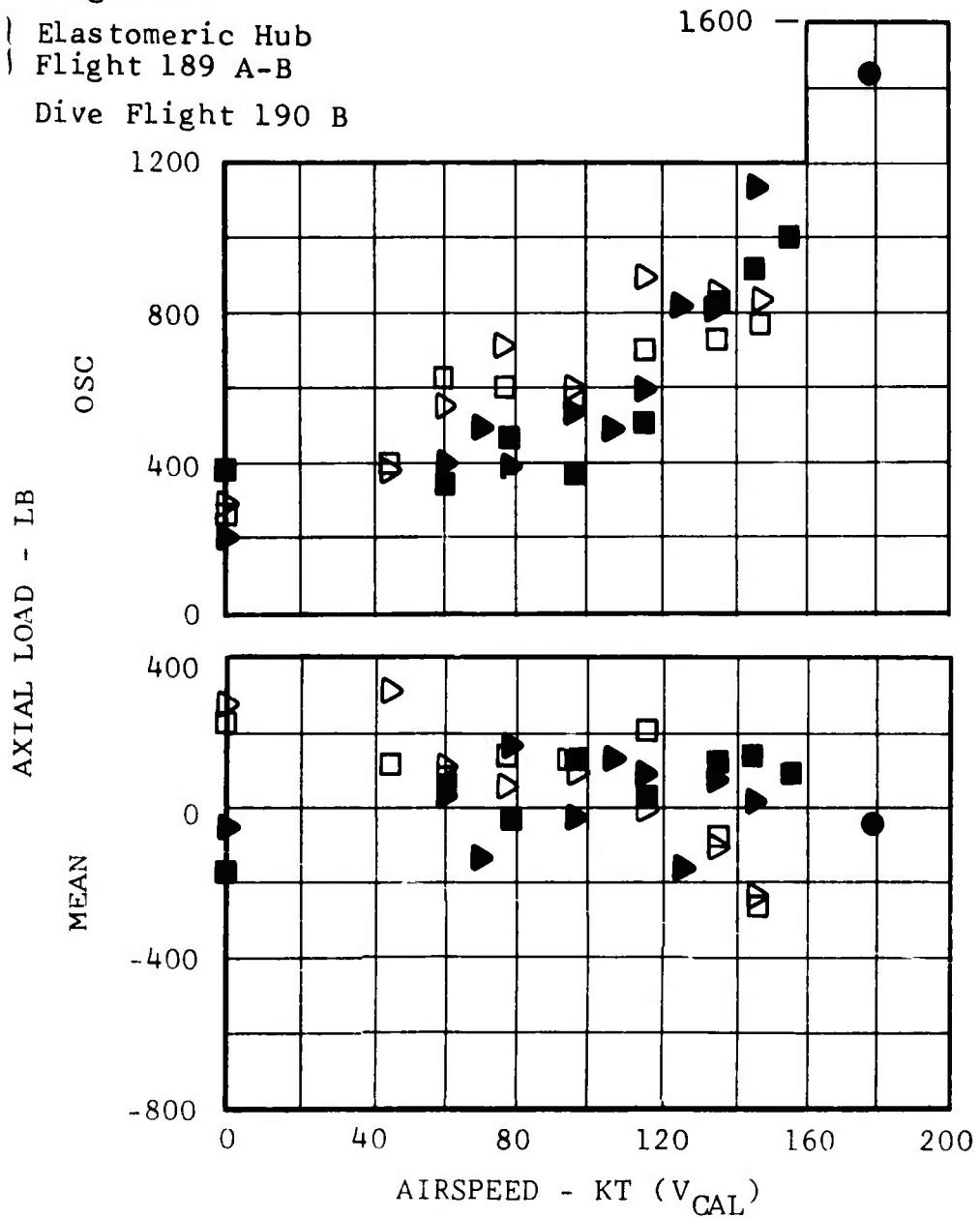

Figure 23. Calculated Rotor Frequency Comparisons - Collective Mode.

BELL AH-1G #20153

- SYM RPM
- 314 | Standard Hub
 - ▽ 324 | Flight 185
 - 314 | Elastomeric Hub
 - ▼ 324 | Flight 189 A-B
 - 324 | Dive Flight 190 B



GW 8000 LB CG 195.9 IN. DENSITY ALT 3000 FT

Figure 24. Right-Hand Cyclic Boost Tube Loads Versus Airspeed.

BELL AH-1G #20153

- | SYM | RPM | |
|-----|-----|-------------------|
| □ | 314 | Standard Hub |
| ▽ | 324 | Flight 183 |
| ■ | 314 | Elastomeric Hub |
| ▼ | 324 | Flight 189 A-B |
| ● | 324 | Dive Flight 190 B |

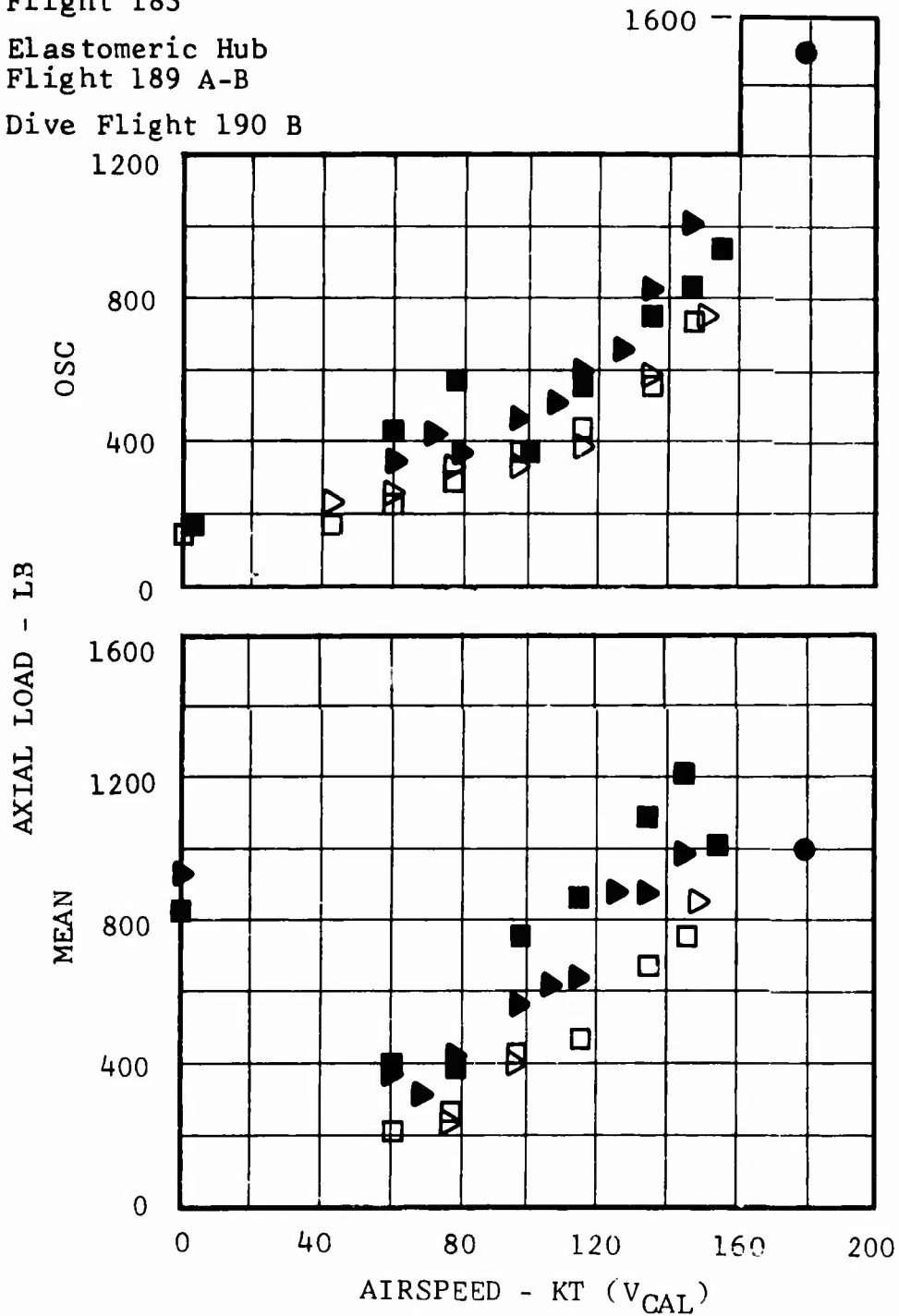

GW 8000 LB

CG 195.9 IN.

DENSITY ALT 3000 FT

Figure 25. Collective Boost Tube Loads Versus Airspeed.

BELL AH-1G #20153

SYM	RPM	
□	314	Standard Hub
▽	324	Flight 183
■	314	Elastomeric Hub
▴	324	Flight 189 A-B
●	324	Dive Flight 190 B

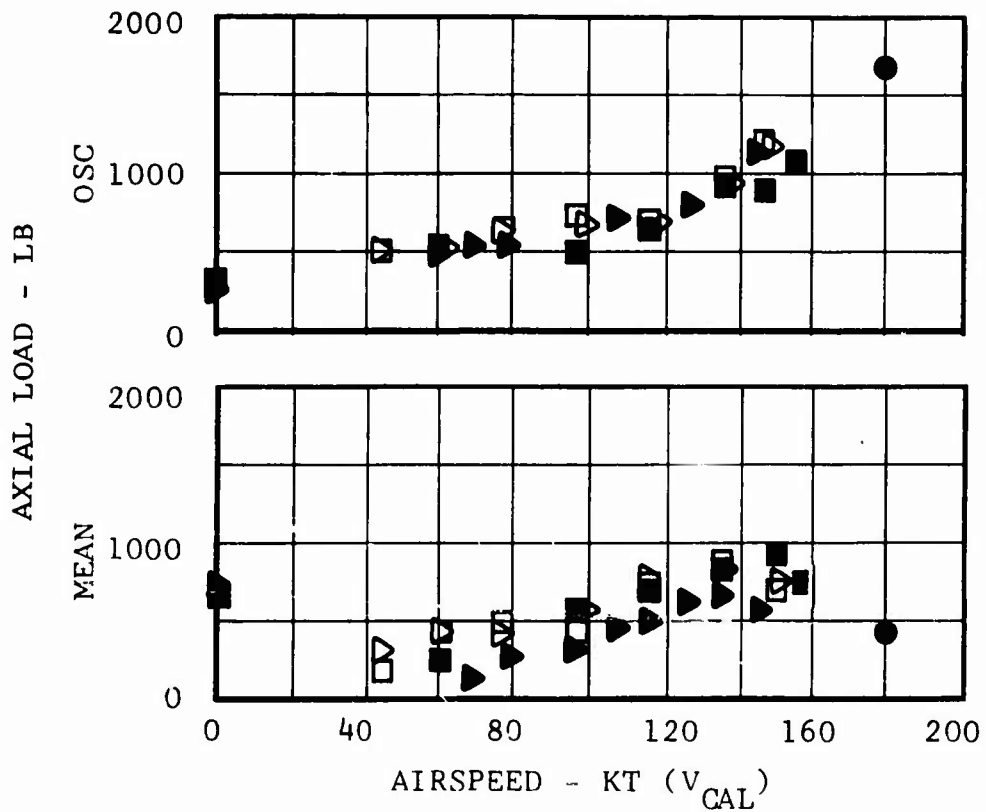

GW 8000 LB

CG 195.9 IN.

DENSITY ALT 3000 FT

Figure 26. Main Rotor Red Pitch Link Load Versus Airspeed.

BELL AH-1G #20153

- | SYM | RPM | |
|-----|-----|-------------------|
| □ | 314 | Standard Hub |
| ▽ | 324 | Flight 183 |
| ■ | 314 | Elastomeric Hub |
| ▼ | 324 | Flight 189 A-B |
| ● | 324 | Dive Flight 190 B |

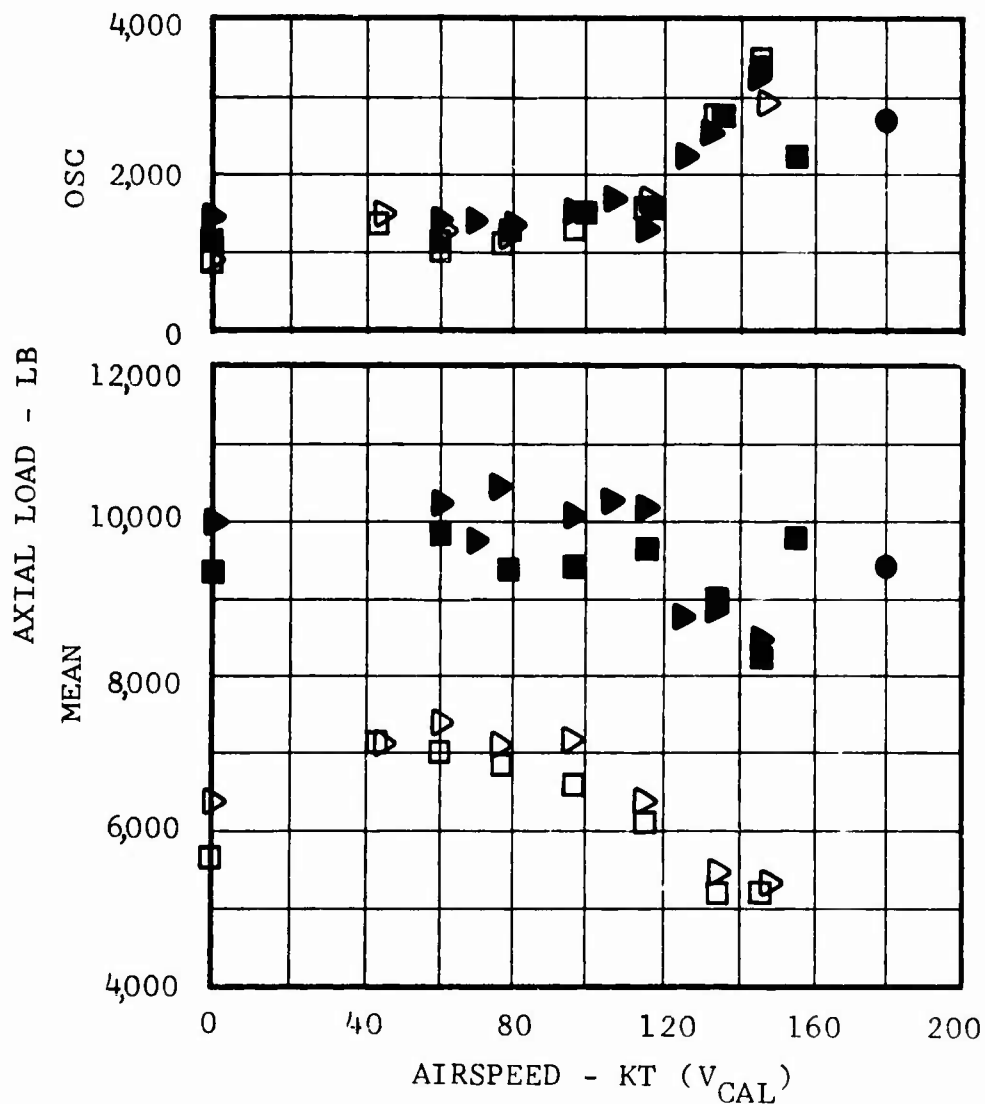

GW 8000 LB

CG 195.9 IN.

DENSITY ALT 3000 FT

Figure 27. Main Rotor Red Drag Brace Loads Versus Airspeed.

BELL AH-1G #20153

SYM RPM

- 314 | Standard Hub
- ▽ 324 | Flight 183
- 314 | Elastomeric Hub
- ▼ 324 | Flight 189 A-B
- 324 | Dive Flight 190 B

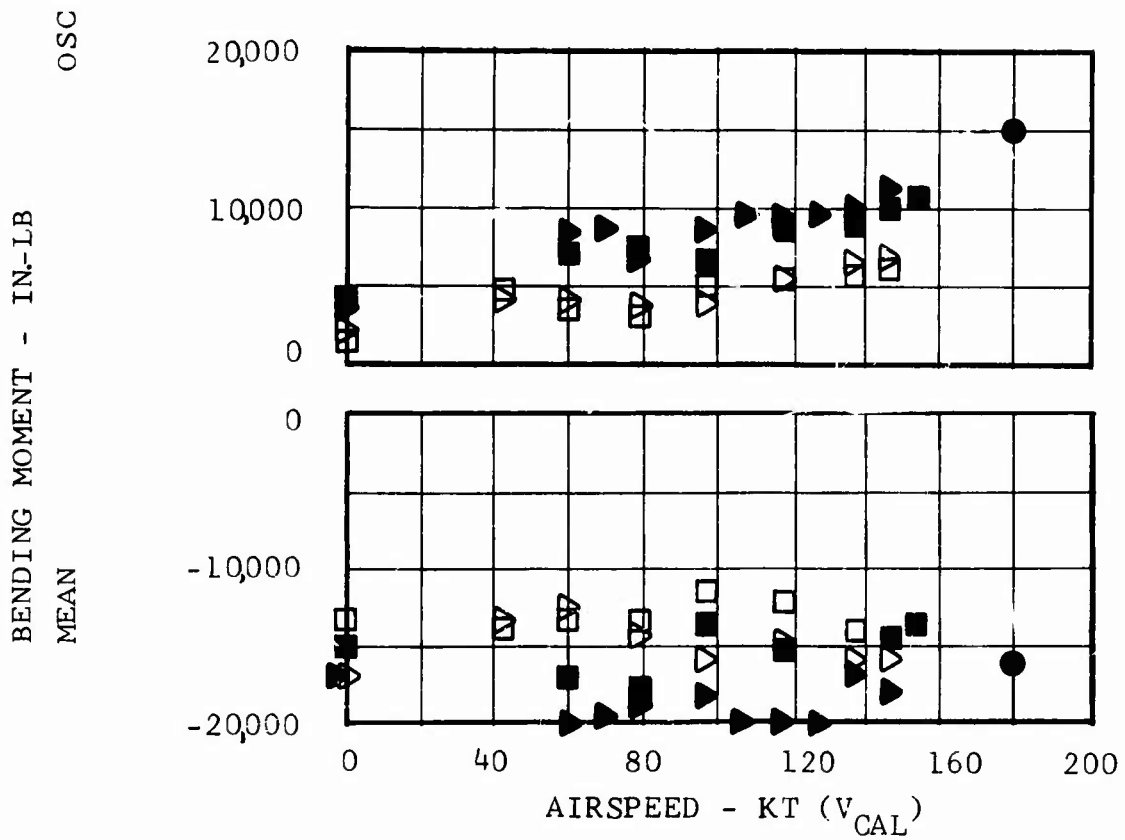

GW 8000 LB CG 195.9 IN. DENSITY ALT 3000 FT

Figure 28. Main Rotor Yoke Beam Bending Moments (Sta. 5) Versus Airspeed.

BELL AH-1G #20153

- | SYM | RPM | |
|-----|-----|-------------------|
| □ | 314 | Standard Hub |
| ▷ | 324 | Flight 183 |
| ■ | 314 | Elastomeric Hub |
| ▲ | 324 | Flight 189 A-B |
| ● | 324 | Dive Flight 190 B |

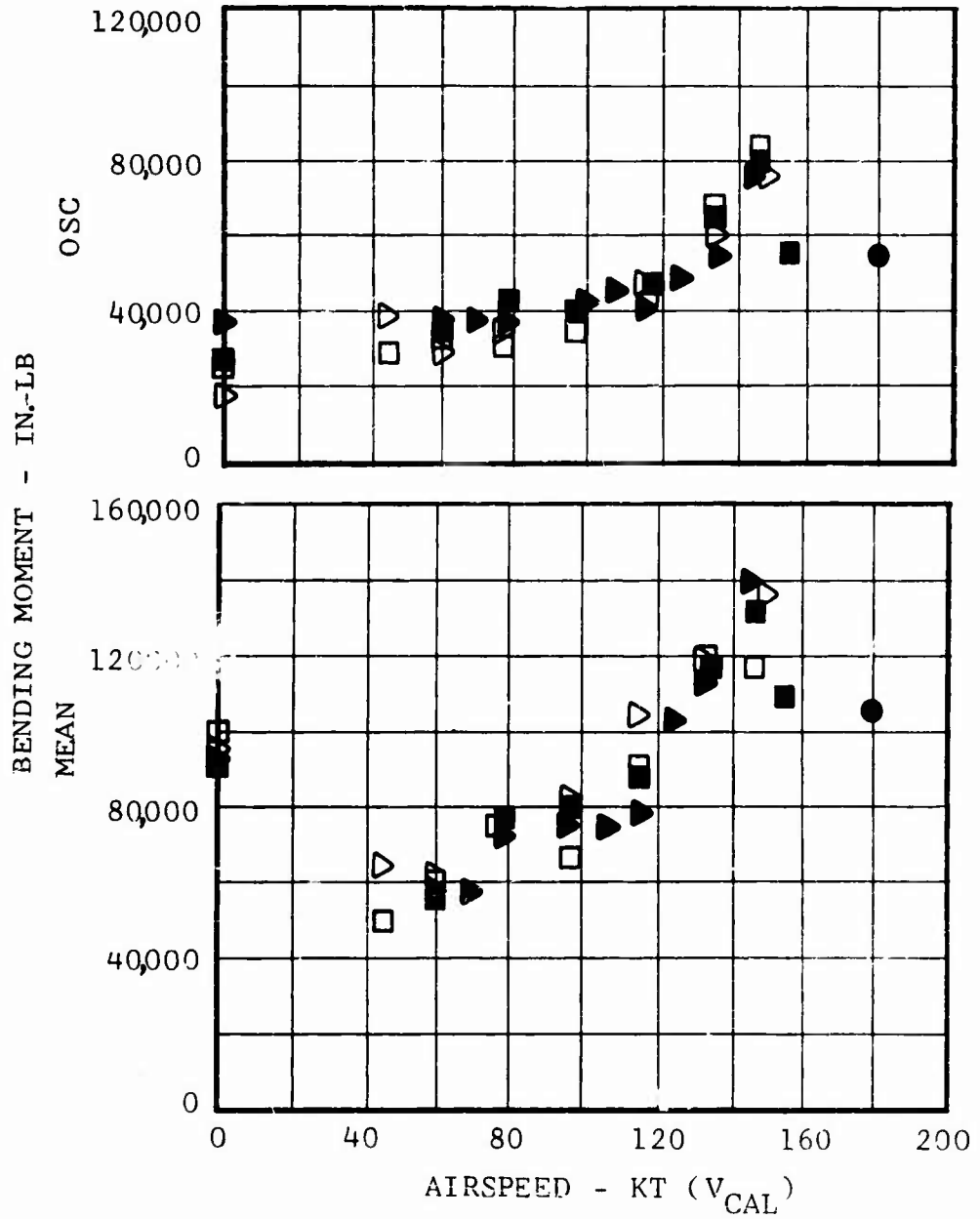

GW 8000 LB CG 195.9 IN. DENSITY ALT 3000 FT

Figure 29. Main Rotor Yoke Chord Bending Moments (Sta. 8) Versus Airspeed.

BELL AH-1G #20153

SYM	RPM	
□	314	} Standard Hub
▽	324	
■	314	} Elastomeric Hub
▼	324	
●	324	Dive Flight 190 B

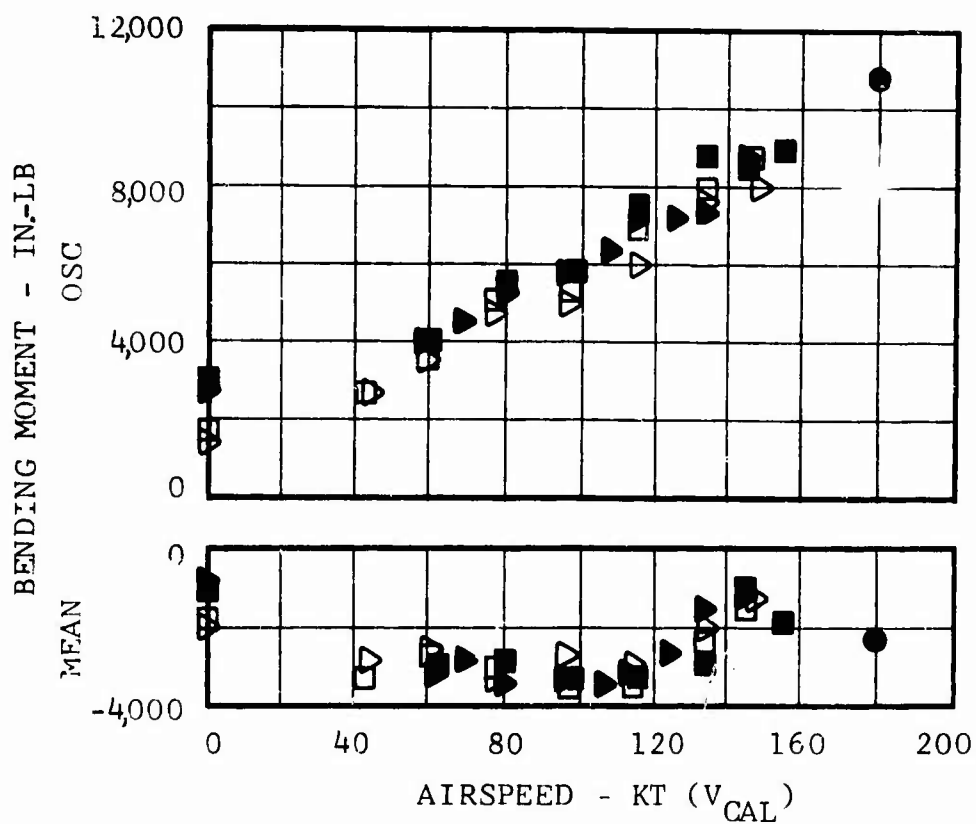

GW 8000 LB CG 195.9 IN. DENSITY ALT 3000 FT

Figure 30. Main Rotor Blade Beam Bending Moments (Sta. 135) Versus Airspeed.

BELL AH-1G #20153

- | | | |
|-----|-----|-------------------|
| SYM | RPM | |
| □ | 314 | } Standard Hub |
| ▽ | 324 | } Flight 183 |
| ■ | 314 | } Elastomeric Hub |
| ▶ | 324 | } Flight 189 A-B |
| ● | 324 | Dive Flight 190 B |

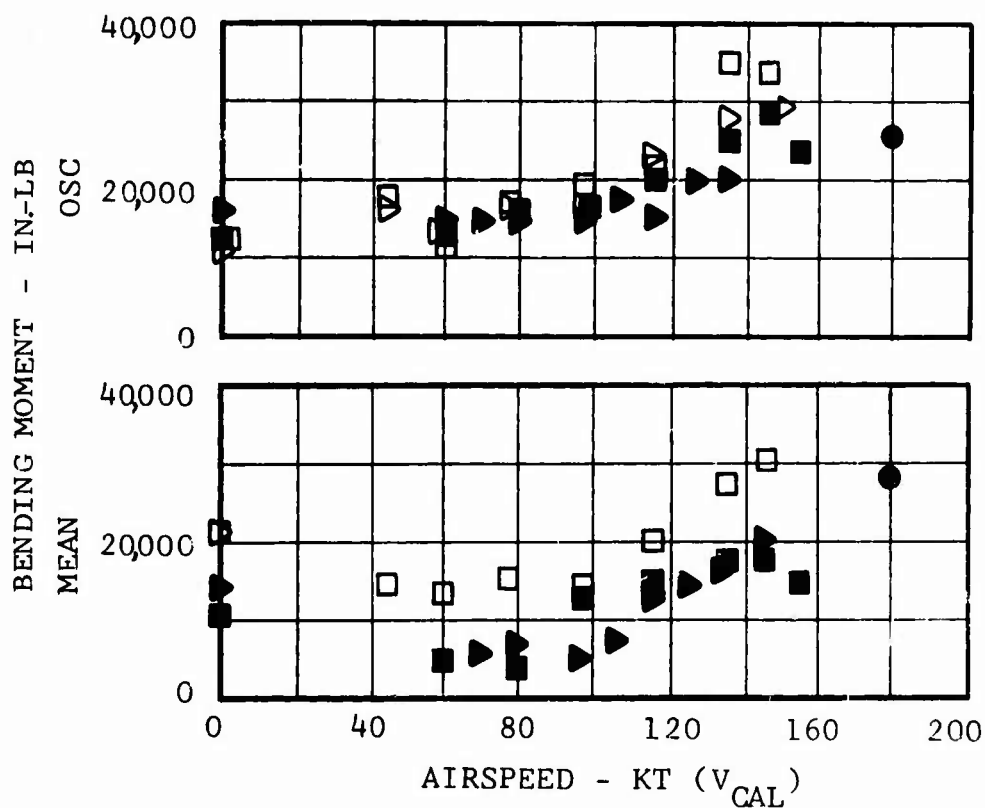

GW 8000 LB CG 195.9 IN. DENSITY ALT 3000 FT

Figure 31. Main Rotor Blade Chord Bending Moments (Sta. 135) Versus Airspeed.

BELL AH-1G #20153

SYM	RPM	
□	314	Standard Hub
▽	324	Flight 184
■	314	Elastomeric Hub
▼	324	Flight 190 A

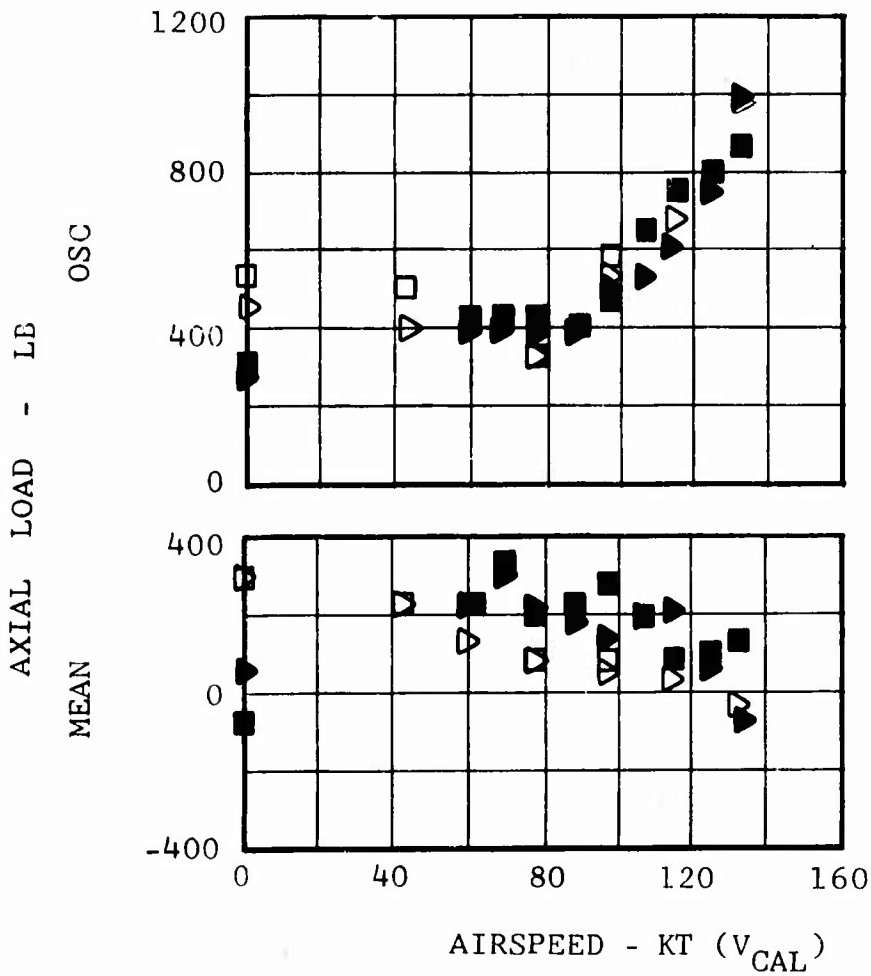

GW 9500 LB CG 197.9 IN. DENSITY ALT 3000 FT

Figure 32. Right-Hand Cyclic Boost Tube Loads Versus Airspeed.

BELL AH-1G #20153

SYM	RPM	
□	314	Standard Hub
▷	324	Flight 184
■	314	Elastomeric Hub
▶	324	Flight 190 A

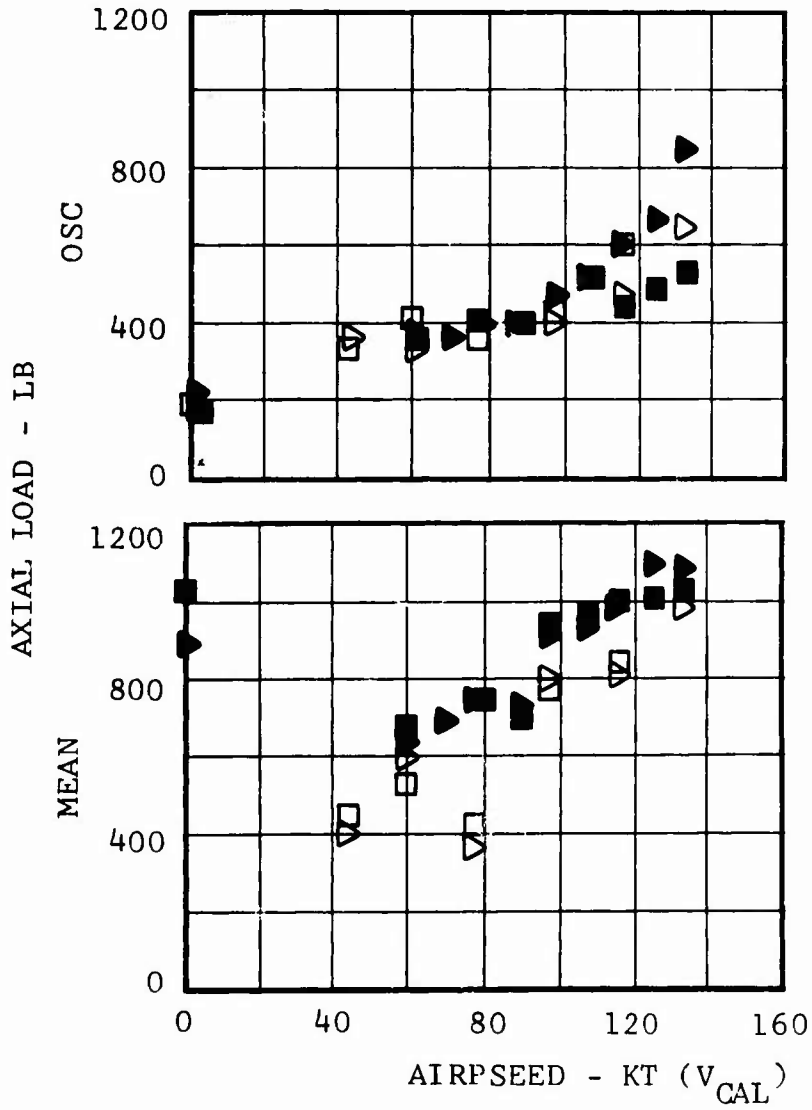

GW 9500 LB CG 197.9 IN. DENSITY ALT 3000 FT

Figure 33. Collective Boost Tube Loads Versus Airspeed.

BELL AH-1G #20153

SYM	RPM	
□	314	Standard Hub
▽	324	Flight 184
■	314	Elastomeric Hub
▼	324	Flight 190 A

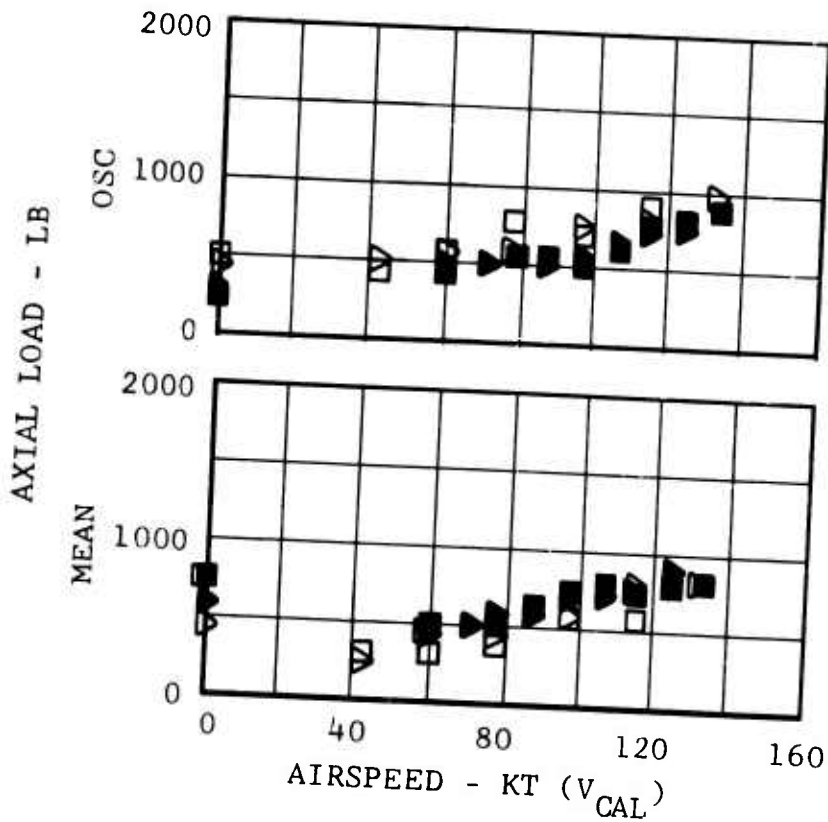

GW 9500 LB

CG 197.9 IN.

DENSITY ALT 3000 FT

Figure 34. Main Rotor Red Pitch Link Loads Versus Airspeed.

BELL AH-1G #20153

SYM	RPM	
□	314	Standard Hub
▽	324	Flight 184
■	314	Elastomeric Hub
▼	324	Flight 190 A

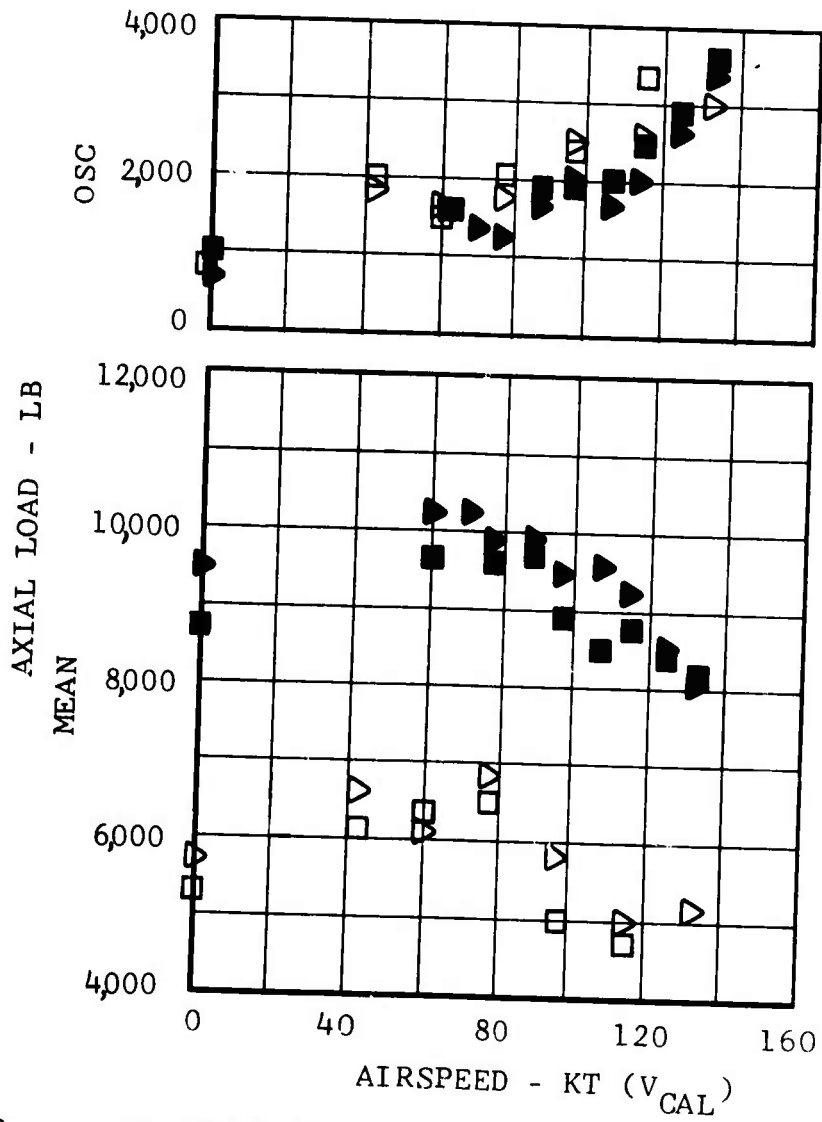

GW 9500 LB

CG 197.9 IN. DENSITY ALT 3000 FT

Figure 35. Main Rotor Red Drag Brace Loads Versus Airspeed.

BELL AH-1G #20153

SYM	RPM	
□	314	Standard Hub
▽	324	Flight 184
■	314	Elastomeric Hub
▶	324	Flight 190 A

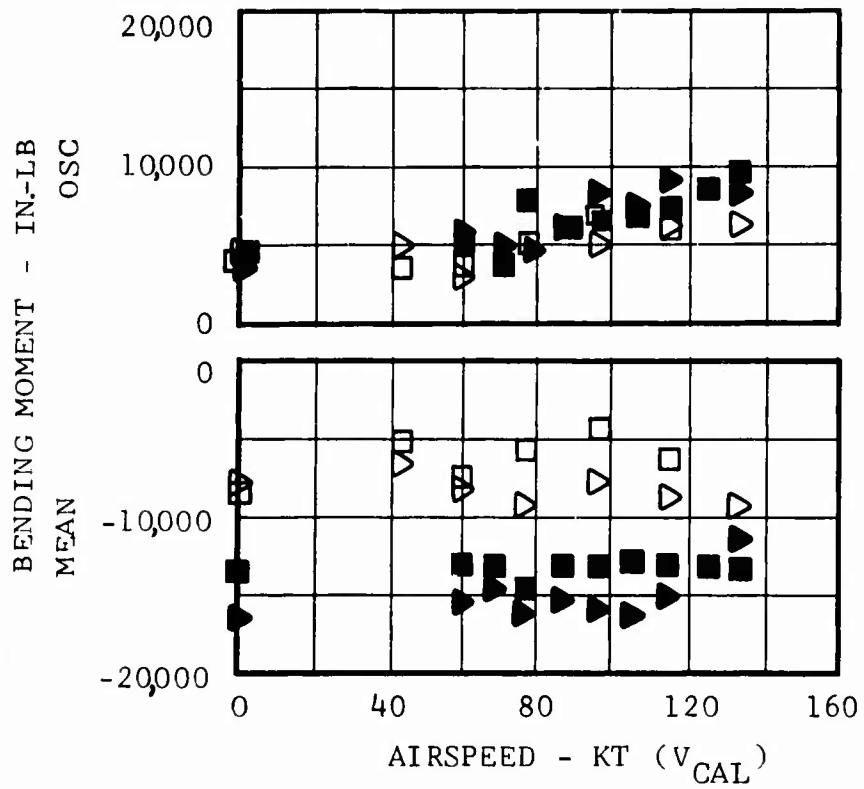

GW 9500 LB CG 197.9 IN. DENSITY ALT 3000 FT

Figure 36. Main Rotor Yoke Beam Bending Moments (Sta. 5) Versus Airspeed.

BELL AH-G #20153

SYM	RPM	
□	314	Standard Hub
▽	324	
■	314	Elastomeric Hub
▶	324	

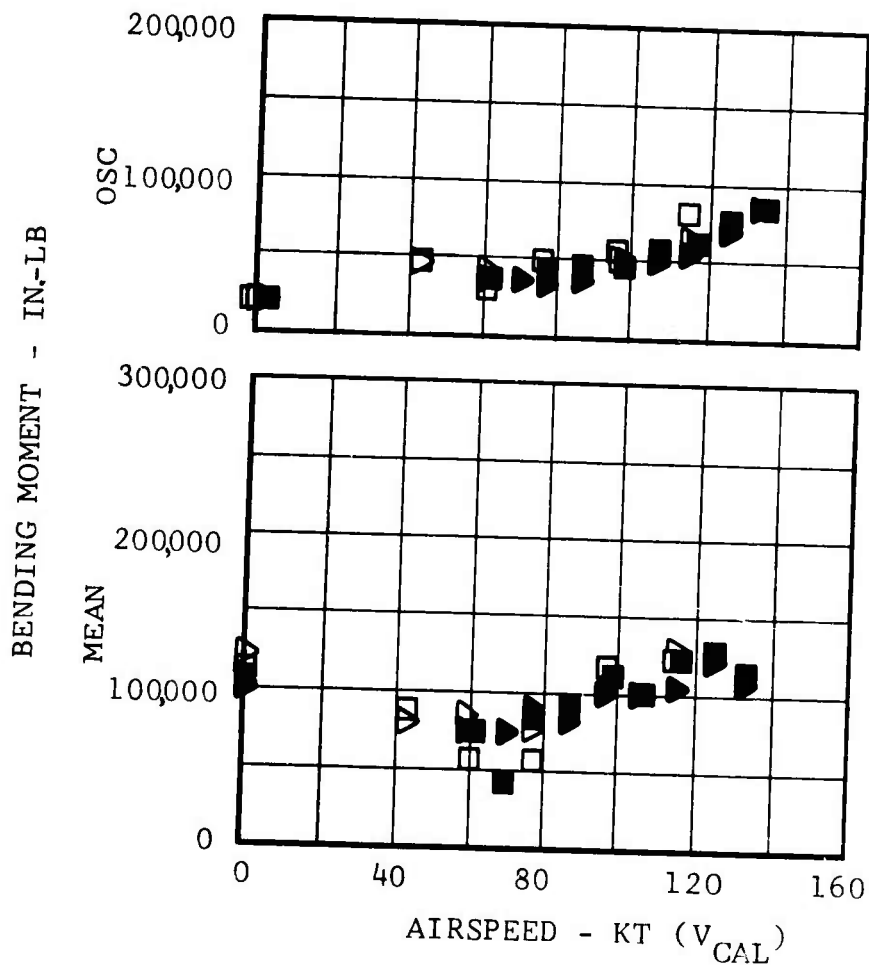

GW 9500 LB CG 197.9 IN. DENSITY ALT 3000 FT

Figure 37. Main Rotor Yoke Chord Bending Moments (Sta. 8) Versus Airspeed.

BELL AH-1G #20153

SYM	RPM	
□	314	Standard Hub
▽	324	Flight 184
■	314	Elastomeric Hub
▲	324	Flight 190 A

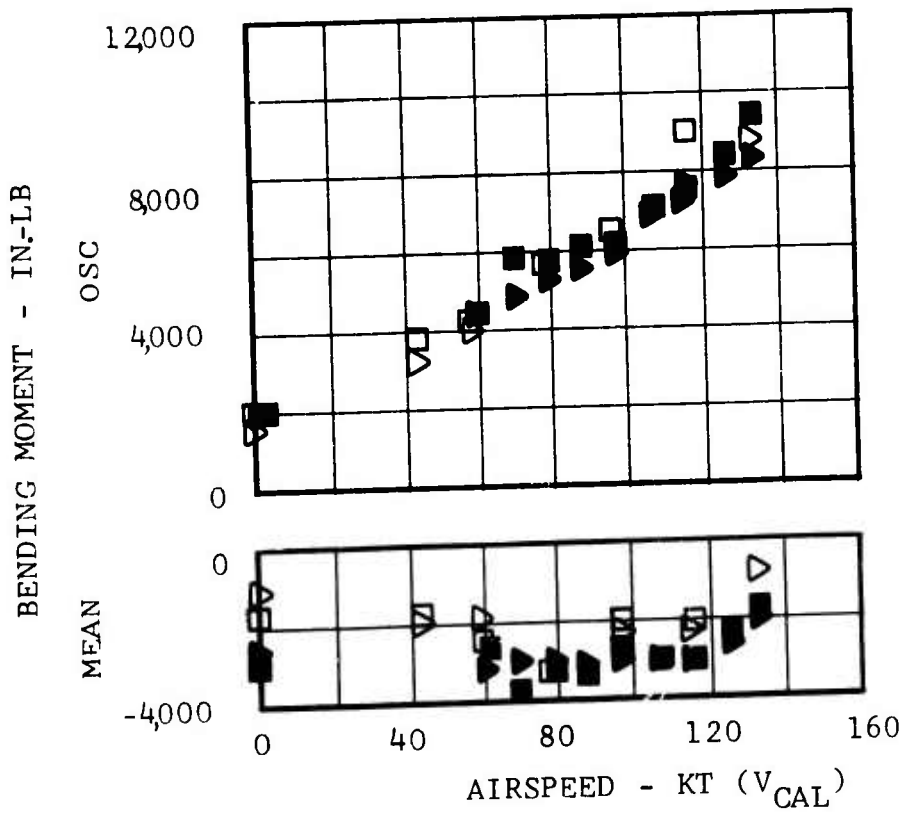

GW 9500 LB CG 197.9 IN. DENSITY ALT 3000 FT

Figure 38. Main Rotor Blade Beam Bending Moments (Sta. 135) Versus Airspeed.

BELL AH-1G #20153

SYM	RPM	
□	314	} Standard Hub
▷	324	
■	314	} Elastomeric Hub
◀	324	

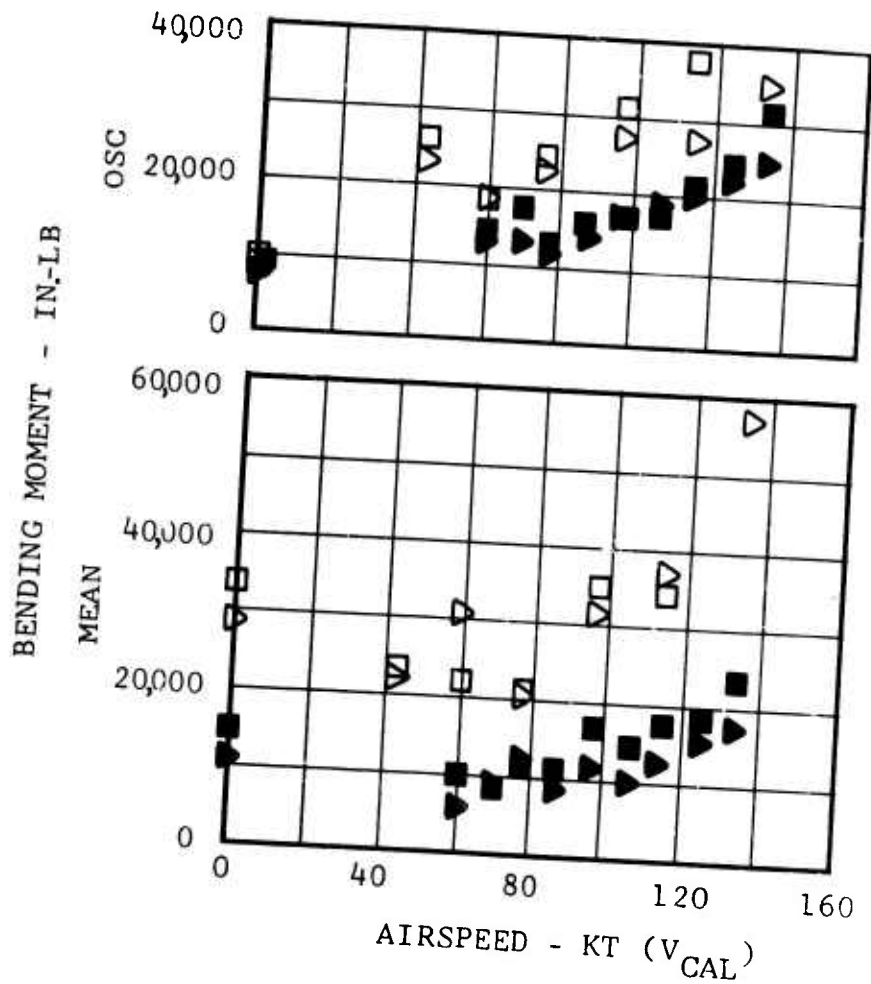

GW 9500 LB

CG 197.9 IN. DENSITY ALT 3000 FT

Figure 39. Main Rotor Blade Chord Bending Moments (Sta. 135) Versus Airspeed.

SYM	RPM	
▷	324	Standard Hub GR 38, AH-1G #20004
▶	324	Elastomeric Hub GR 22, AH-1G #20153

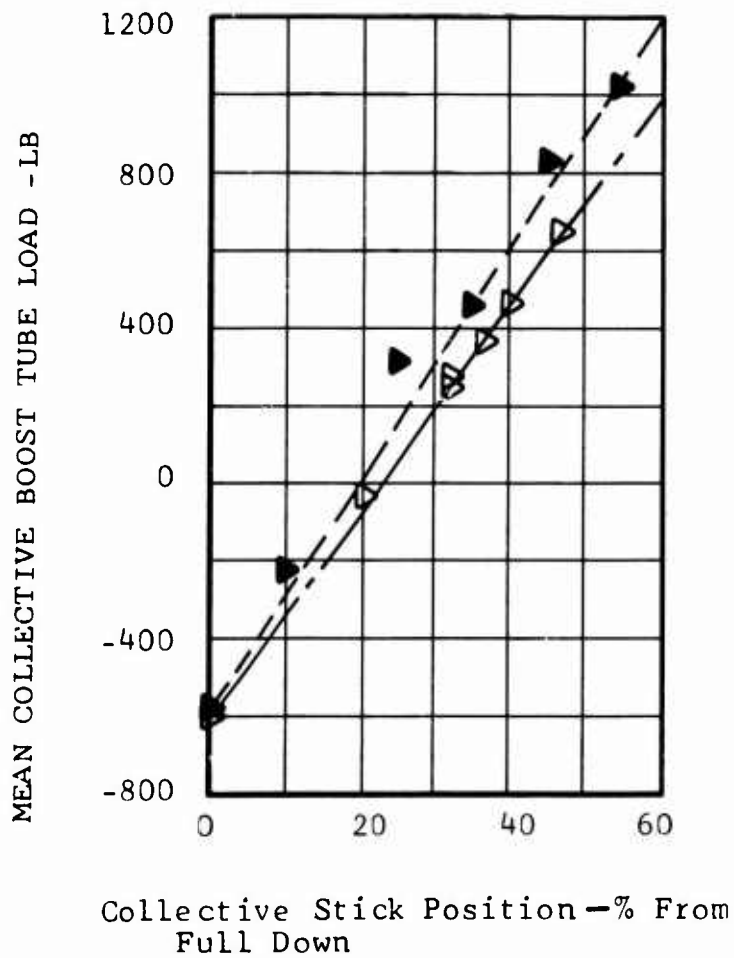

Figure 40. Collective Boost Tube Load Versus Collective Stick Position.

Based on a survey of actual flight loads on the AH-1G Cobra helicopter, the spectrum listed below has been established as representative of normal service operations. The steady pitch motions are based on the bearing as installed during the experimental flights (no twist in bearing at 14 degrees above low blade angle).

TABLE II. LOADS AND MOTIONS FOR AH-1G MAIN ROTOR PITCH CHANGE BEARINGS

Time (pct)	Pitch Motion		Radial Load (lb)		Axial Load (lb)	Dynamic Freq (cpm)
	Steady (deg)	Osc (deg)	Steady	Osc		
0.25	14	± 9.5	10000	± 9400	56000	324
2	4	± 9.5	9000	± 8000	56000	324
6.75	4	± 9.5	7000	± 6500	56000	324
22.5	2	± 8.2	6000	± 5000	56000	324
22	2	± 7.0	4000	± 3600	56000	324
32	0	± 5.7	3000	± 2200	56000	324
14.5	6	± 3.2	2000	± 2200	56000	324
Accomplish the following every 200 hours of testing:						
800 cycles	0	± 12	2640	-	0	5
800 cycles	0/0/0	0	0	-	0/56000/0	5
Note: The radial load was derived by dividing the measured Sta. 8 chordwise moment by the 15.2-inch bearing spacing. This approach is believed to be about 5-percent conservative since the beam load contribution is neglected and the chord loads diminish toward the tip of the blade (center of bearings is about Sta. 21).						

CONCLUSIONS

The feasibility of using only elastomeric bearings in a helicopter main rotor has been proven. Flight test results show that the steady and oscillatory loads for the hub, blade, and controls are comparable to base-line data for the AH-1G production main rotor.

Historically, rotor hub bearings and related parts (such as oil and dust seals, close-tolerance sleeves, bearing retainers, and oil reservoirs) have been a prime source of service maintenance problems. The use of elastomeric bearings for helicopter rotor applications is expected to virtually eliminate bearing replacements and greatly reduce unscheduled maintenance downtime and costs.

Another advantage of the elastomeric bearing is that the appearance of the elastomer can be used as an indicator of the severity of previous rotor oscillatory loads and motions. This feature and the visible gradual wear of the elastomer adds to safety of flight and reduces inspection time. Endurance test results and calculations indicate that the bearings used during this program would have a service life of several thousand hours. However, the bench tests performed on the pitch change bearing did not simulate the wide variety of load and motion conditions that the rotor will experience during flight. Additional endurance and environmental tests and/or an in-flight service evaluation are needed to determine the actual service life and also to establish failure criteria.

LITERATURE CITED

1. Fagan, C. H., EVALUATION OF LAMINATED ELASTOMERIC BEARINGS IN THE UH-1 HELICOPTER TAIL ROTOR, USAAVLABS Technical Report 67-36, Bell Helicopter Company Report No. 572-099-004, U. S. Army Aviation Materiel Laboratories, Fort Eustis, Virginia, July 1967, AD 661614.
2. Fagan, C. H., IMPROVED CONCEPT OF ELASTOMERIC BEARINGS FOR UH-1 TAIL ROTOR ASSEMBLY, USAAVLABS Technical Report 68-84, Bell Helicopter Company Report No. 572-099-008, U. S. Army Aviation Materiel Laboratories, Fort Eustis, Virginia, October 1968, AD 681244.
3. PAPERS PRESENTED AT THE ELASTOMERIC BEARING SYMPOSIUM, U. S. Army Aviation Materiel Laboratories, Fort Eustis, Virginia, March 1969, AD 698477.
4. Bell Helicopter Company Report No. 209-947-015, DETAIL SPECIFICATION FOR MODEL AH-1G HELICOPTER, 15 April 1966.