

MICROCOPY RESOLUTION TEST CHART  
NATIONAL BUREAU OF STANDARDS 1963-A

**Bolt Beranek and Newman Inc.**

12



Report No. 4981

**Flowing Waters or Teeming Crowds:  
Mental Models of Electricity**

Dedre Gentner and Donald R. Gentner

May 1982

Prepared for:  
Office of Naval Research  
Personnel and Training Research Programs

DTIC  
ELECTE  
S JUN 9 1982 D  
B

This research was sponsored by the Personnel and Training Research Programs, Psychological Sciences Division, Office of Naval Research, under Contract No. N00014-79-C-0338, Contract Authority Identification No. NR157-428. Approved for public release; distribution unlimited. Reproduction in whole or in part is permitted for any purpose of the United States Government.

82 06 09 071

AD A115300  
DTIC FILE COPY

UNCLASSIFIED

SECURITY CLASSIFICATION OF THIS PAGE (When Data Entered)

REPORT DOCUMENTATION PAGE		READ INSTRUCTIONS BEFORE COMPLETING FORM
1. REPORT NUMBER Technical Report No. 5	2. GOVT ACCESSION NO. AP-A115 300	3. RECIPIENT'S CATALOG NUMBER
4. TITLE (and Subtitle)  Flowing Waters or Teeming Crowds: Mental Models of Electricity		5. TYPE OF REPORT & PERIOD COVERED Technical Report
		6. PERFORMING ORG. REPORT NUMBER
7. AUTHOR(s)  Dedre Gentner and Donald R. Gentner		8. CONTRACT OR GRANT NUMBER(s)  N00014-79-C-0338
9. PERFORMING ORGANIZATION NAME AND ADDRESS Bolt Beranek and Newman Inc. 50 Moulton Street Cambridge, Massachusetts 02238		10. PROGRAM ELEMENT, PROJECT, TASK AREA & WORK UNIT NUMBERS  NR 157-428
11. CONTROLLING OFFICE NAME AND ADDRESS Personnel and Training Research Programs Office of Naval Research (Code 458) Arlington, Virginia 22217		12. REPORT DATE May 1982
		13. NUMBER OF PAGES 63
14. MONITORING AGENCY NAME & ADDRESS (if different from Controlling Office)		15. SECURITY CLASS. (of this report) Unclassified
		15a. DECLASSIFICATION/DOWNGRADING SCHEDULE
16. DISTRIBUTION STATEMENT (of this Report)  Approved for public release; distribution unlimited.		
17. DISTRIBUTION STATEMENT (of the abstract entered in Block 20, if different from Report)		
18. SUPPLEMENTARY NOTES  To appear in D. Gentner & A. L. Stevens (Eds.) <u>Mental Models</u> . Hillsdale, N.J.: Erlbaum, in press.		
19. KEY WORDS (Continue on reverse side if necessary and identify by block number)  Mental Models, Complex Systems		
20. ABSTRACT (Continue on reverse side if necessary and identify by block number) Analogical comparisons are commonly used in the discussion and teaching of scientific topics. This paper explores the conceptual role of analogy. We compare two positions: (1) the <u>generative analogy hypothesis</u> , that analogies are an important determinant of the way people think about a domain; (2) the <u>surface terminology hypothesis</u> , that analogies merely provide a convenient vocabulary for describing concepts in the domain.		

UNCLASSIFIED

SECURITY CLASSIFICATION OF THIS PAGE (When Data Entered)



We present evidence from interviews and experimental studies in the domain of simple electronics that when using analogies, people map conceptual structures from one domain to another. This imported conceptual structure is shown to influence inferences a person makes about the target domain. These results support the generative analogy hypothesis.



UNCLASSIFIED

SECURITY CLASSIFICATION OF THIS PAGE (When Data Entered)

Report No. 4981

**FLOWING WATERS OR TEEMING CROWDS:  
MENTAL MODELS OF ELECTRICITY**

Dedre Gentner and Donald R. Gentner

May 1982

Prepared for:  
Office of Naval Research  
Personnel and Training Research Programs

This research was sponsored by the Personnel and Training Research Programs, Psychological Sciences Division, Office of Naval Research, under Contract No. N00014-79-C-0338, Contract Authority Identification No. NR 157-428. Approved for public release; distribution unlimited. Reproduction in whole or in part is permitted for any purpose of the United States Government.

Abstract

Analogical comparisons are commonly used in the discussion and teaching of scientific topics. This paper explores the conceptual role of analogy. We compare two positions: (1) the generative analogy hypothesis, that analogies are an important determinant of the way people think about a domain. (2) the surface terminology hypothesis, that analogies merely provide a convenient vocabulary for describing concepts in the domain.

We present evidence from interviews and experimental studies in the domain of simple electronics that when using analogies, people map conceptual structures from one domain to another. This imported conceptual structure is shown to influence inferences a person makes about the target domain. These results support the generative analogy hypothesis.



Accession For	
NTIS GRA&I	<input checked="" type="checkbox"/>
DTIC TAB	<input type="checkbox"/>
Unannounced	<input type="checkbox"/>
Justification	
By _____	
Distribution/ _____	
Availability Codes	
Dist	Avail and/or Special
A	

Flowing Waters or Teeming Crowds:  
Mental Models of Electricity<sup>1</sup>

Question: When you plug in a lamp and it lights up, how does it happen?

Subject Delta: . . . basically there is a pool of electricity that plug-in buys for you . . . the electricity goes into the cord for the appliance, for the lamp and flows up to - flows - I think of it as flowing because of the negative to positive images I have, and also because...a cord is a narrow contained entity like a river.

Analogical comparisons with simple or familiar systems occur often in people's descriptions of complex systems, sometimes as explicit analogical models, and sometimes as implicit analogies, in which the person seems to borrow structure from the base domain without noticing it. Phrases like "current being routed along a conductor," or "stopping the flow" of electricity are examples.

In this paper we want to explore the conceptual role of analogy. When people discuss electricity (and other complex phenomena) in analogical terms, are they thinking in terms of analogies, or merely borrowing language from one domain as a convenient way of talking about another domain? If analogies are to be taken seriously as part of the apparatus used in peoples' scientific reasoning, it must be shown that they have real conceptual effects.



There are two lines of observational evidence (aside from the protocols cited) for the proposition that analogies can have genuine effects on a person's conception of a domain. First, analogies are often used in teaching, as in the following introduction to electricity (Koff, 1961, p. 73).

The idea that electricity flows as water does is a good analogy. Picture the wires as pipes carrying water (electrons). Your wall plug is a high-pressure source which you can tap simply by inserting a plug . . . A valve (switch) is used to start or stop flow.

Thus, educators appear to believe that students can import conceptual relations and operations from one domain to another.

A more direct line of evidence is that working scientists report that they use analogy in theory development. The great astronomer Johannes Kepler wrote: "And I cherish more than anything else the Analogies, my most trustworthy masters. They know all the secrets of Nature, and they ought to be least neglected in Geometry." (quoted in Polya, 1973). The Nobel Prize lecture of nuclear physicist Sheldon Glashow (1980) makes constant reference to the analogies used in developing the theory of the unified weak and electromagnetic interactions:

It soon became clear that a more far-reaching analogy might exist between electromagnetism and the other forces. . . .

I was lead to the group  $SU(2) \times U(1)$  by analogy with the approximate isospin-hypercharge group which characterizes strong interactions. . . .

Part of the motivation for introducing a fourth quark was based on our mistaken notions of hadron spectroscopy. But we also wished to enforce an analogy between the weak leptonic current and the weak hadronic current. . . .

These kinds of remarks are strongly suggestive of the conceptual reality of generative analogy. But people's understanding of their own mental processes is not always correct. It could be that, despite these introspections, the underlying thought processes proceed independently of analogy and that analogies merely provide a convenient terminology for the results of the process. This hypothesis, the Surface Terminology hypothesis, contrasts with the Generative Analogy hypothesis that analogies are used in generating inferences.

Our goal is to test the Generative Analogy hypothesis: that conceptual inferences in the target follow predictably from the use of a given base domain as an analogical model. To confirm this hypothesis, it must be shown that the inferences people make in a topic domain vary according to the analogies they use. Further, it must be shown that these effects cannot be attributed to shallow lexical associations; e.g., it is not enough to show that the person who speaks of electricity as "flowing" also uses

related terms such as "capacity" or "pressure." Such usage could result from a generative analogy, but it could also occur under the Surface Terminology hypothesis.

The plan of this paper is to (1) set forth a theoretical framework for analogical processing, called structure-mapping; (2) use this framework to explore the analogies people use in the domain of electronic circuitry, based on evidence from introductory texts and from interviews; (3) present two experimental studies that test the Generative Analogy hypothesis; and finally, (4) discuss the implications of our findings for a general treatment of analogy in science.

### A Structure-mapping Theory of Analogical Thinking

Just what type of information does an analogy convey? The prevailing psychological view rejects the notion that analogies are merely weak similarity statements, maintaining instead that analogy can be characterized more precisely (Miller, 1979; Ortony, 1979; Rumelhart & Abrahamson, 1973; Sternberg, 1977; Tourangeau & Sternberg, 1981; Verbrugge & McCarrell, 1977). We argue in this section that analogies select certain aspects of existing knowledge, and that this selected knowledge can be structurally characterized.

An analogy such as Rutherford's comparison

1. The hydrogen atom is like the solar system.

clearly does not convey that all of one's knowledge about the solar system should be attributed to the atom. The inheritance of characteristics is only partial. This might suggest that an analogy is a kind of weak similarity statement, conveying that only some of the characteristics of the solar system apply to the hydrogen atom. But this characterization fails to capture the distinction between literal similarity and analogical relatedness. A comparable literal similarity statement is

2. There's a system in the Andromeda nebula that's like our solar system.

The literal similarity statement (2) conveys that the target object (The Andromeda system) is composed of a star and planets much like those of our solar system, and further, that those objects are arranged in similar spatial relationships and have roughly the same kind of orbital motion, attractive forces, relative masses, etc. as our system.

Like the literal comparison, the analogy (statement 1) conveys considerable overlap between the relative spatial locations, relative motions, internal forces, and relative masses of atom and solar system; but it does not convey that the objects in the two domains are similar. One could argue with the literal statement (2) by saying "But the star in the Andromeda system isn't yellow and hot." if the star happened to be a white dwarf. To argue with the analogical statement (1) by saying "But the nucleus of the atom isn't yellow and hot." would be to miss the point. On the other hand, one could argue with the analogy by

challenging the relational implications. For example, one might object "But the electron can't revolve around the nucleus; if it did, it would emit light and thereby lose energy and spiral into the nucleus." To challenge the relation REVOLVE (electron,<sup>2</sup> nucleus) is to raise a legitimate problem with the analogy. The analogy, in short, conveys overlap in relations among objects, but no particular overlap in the characteristics of the objects themselves. The literal similarity statement conveys overlap both in relations among the objects and in the attributes of the individual objects.<sup>3</sup>

The analogical models used in science can be characterized as structure-mappings between complex systems. Such an analogy conveys that like relational systems hold within two different domains. The predicates of the base domain (the known domain) - particularly the relations that hold among the objects - can be applied in the target domain (the domain of inquiry). Thus, a structure-mapping analogy asserts that identical operations and relationships hold among nonidentical things. The relational structure is preserved, but not the objects.

In such a structure-mapping,<sup>4</sup> both domains are viewed as systems of objects and predicates. Among the predicates, we must distinguish between object attributes and relationships. In a propositional representation, the distinction can be made explicit in the predicate structure: attributes are predicates taking one argument, and relations are predicates taking two or

more arguments. For example, COLLIDE (x,y) is a relation, while RED (x) is an attribute. We will use a schema-theoretic representation of knowledge as a propositional network of nodes and predicates (cf. Miller, 1979; Rumelhart, 1979; Rumelhart & Norman, 1975; Rumelhart & Ortony, 1977; Schank & Abelson, 1977). The nodes represent concepts treated as wholes and the predicates express propositions about the nodes. The predicates may convey dynamic process information, constraint relations, and other kinds of knowledge (e.g., de Kleer & Sussman, 1978; Forbus, 1982; Rieger & Grinberg, 1977). Figure 1 shows the structure-mapping conveyed by the atom/solar system analogy. Starting with the known base domain of the solar system, the object nodes of the base domain (the sun and planets) are mapped onto object nodes (the nucleus and electrons) of the atom. Given this correspondence of nodes, the analogy conveys that the relationships that hold between the nodes in the solar system also hold between the nodes of the atom: for example, that there is a force attracting the peripheral objects to the central object; that the peripheral objects revolve around the central object; that the central object is more massive than the peripheral objects; and so on.

Structure-mapping: Interpretation Rules

Assume that the hearer has a particular propositional representation of a known domain B (the base domain) in terms of object nodes  $b_1, b_2, \dots, b_n$  and predicates such as A, R, R.

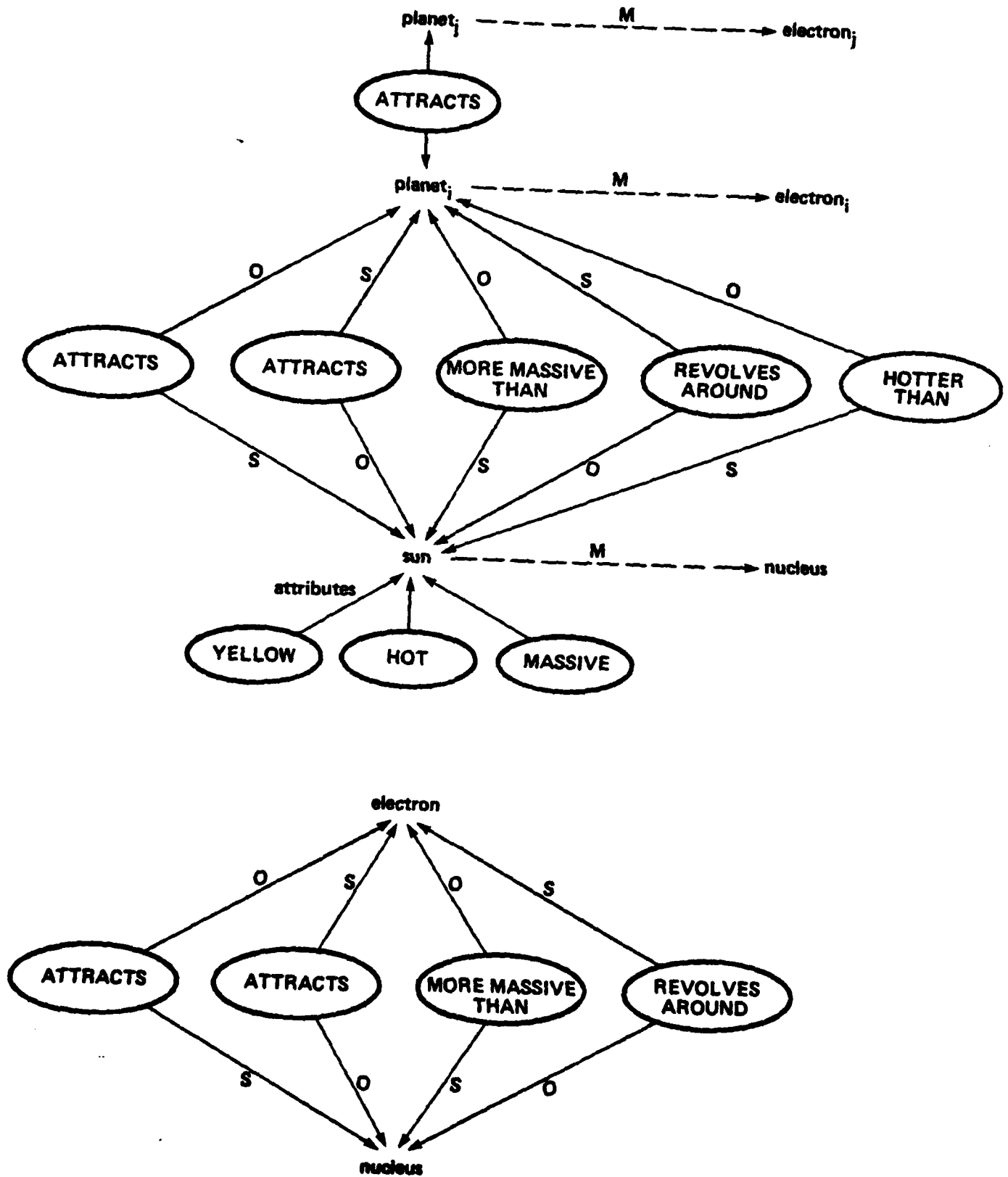

Figure 1. Representations of knowledge about the solar system and the hydrogen atom, showing partial identity in the relational structure between the two domains.

Assume also a (perhaps less specified) representation of the domain of inquiry (the target domain) in terms of at least some object nodes  $t_1, t_2, \dots, t_m$ . Then a structure-mapping analogy maps the nodes of B into the nodes of T:

$$M: b_i \text{ --> } t_i$$

The hearer derives analogical predications by applying predicates valid in the base domain B to the target domain T, using the node substitutions dictated by the mapping:

$$M: [R(b_i, b_j)] \text{ --> } [R(t_i, t_j)]$$

where  $R(b_i, b_j)$  is a relation that holds in the base domain B. These analogical predications are subject to two implicit structural rules:

1. Preservation of relationships. If a relation exists in the base, then predicate the same relation between the corresponding objects in the target:

$$M: [R(b_i, b_j)] \text{ --> } [R(t_i, t_j)]$$

In contrast, attributes (one-place predicates) from B are not strongly predicated in T:

$$[A(b_i)] \text{ -/-> } [A(t_i)].$$

2. Systematicity. Sets of interconstraining relations are particularly important in explanatory analogy. Therefore, a relation that is dominated by a potentially valid higher-



order relation is more strongly predicated than an isolated relation. For example, in the following expression, relations  $R_1$  and  $R_2$  are each dominated by the higher-order relation  $R$  that connects them. To the extent that any of these relations can be validly imported into the target, the strength of predication of the others is increased.

$$M: [R_1(R_{ij}(b_i, b_j), R_{kl}(b_k, b_l))] \rightarrow [R_1(R_{ij}(t_i, t_j), R_{kl}(t_k, t_l))]$$

Preservation of relationships. Assertion (1) states that relational predicates, and not object attributes, carry over in analogical mappings. This differentiates analogy from literal similarity, in which there is also strong attribute overlap. This follows from the central assertion that analogical mappings convey that identical propositional systems apply in two domains with dissimilar objects. For example, in the solar system model of the atom, the ATTRACTS relation and the REVOLVES AROUND relation between planet and sun are carried across to apply between electron and nucleus, while the separable attributes of the base objects, such as the color or temperature of the sun, are left behind. Mass provides a good illustration: The relation "MORE MASSIVE THAN" between sun's mass and planet's mass carries over, but not the absolute mass of the sun. We do not expect the nucleus to have a mass of 10<sup>30</sup> kilograms, any more than we expect it to have a temperature of 25,000,000 F.

Systematicity. Assertion (2) states that predicates are more likely to be imported into the target if they belong to a system of coherent, mutually constraining relationships, the others of which map into the target. These interconnections among predicates are explicitly structurally represented by higher-order relations between those predicates (e.g., Smith, in preparation). One common higher-order relation is CAUSE; for example, CAUSE ( $R_1, R_2$ ) expresses a causal chain between the lower-order relations  $R_1$  and  $R_2$ . Focusing on such causal chains can make an analogical matcher more powerful (Winston, 1981).

Figure 2 shows the set of systematically interconnected relations in the Rutherford model, a highly systematic analogy. Notice that the lower-order relations--DISTANCE (sun, planet), REVOLVES AROUND (planet, sun), etc.--form a connected system, together with the abstract relationship ATTRACTIVE FORCE (sun, planet). The relation MORE MASSIVE THAN (sun, planet) belongs to this system. In combination with other higher-order relations, it determines which object will revolve around the other. This is why MORE MASSIVE THAN is preserved while HOTTER THAN is not, even though the two relations are, by themselves, similar comparisons. HOTTER THAN does not participate in this systematic set of interrelated predicates. Thus, to the extent that people recognize (however vaguely) that gravitational forces play a central role in the analogy they will tend to import MORE MASSIVE THAN, but not HOTTER THAN into the target.

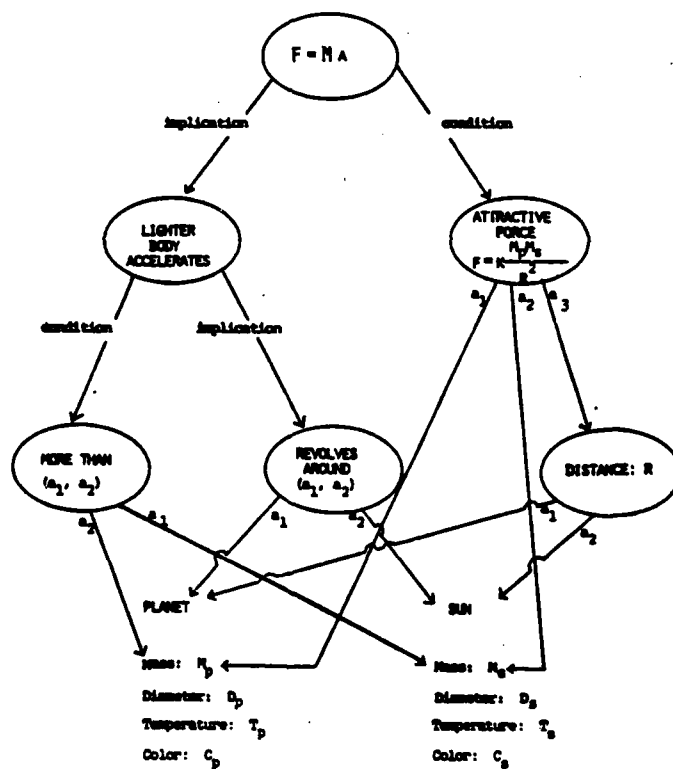

Figure 2. More detailed representation of knowledge about (a) the solar system and (b) the atom, showing partial identity in the higher-order relational structures between the two domains.

The systematicity rule aims to capture the intuition that explanatory analogies are about systems of interconnected relations. Sometimes these systems can be mathematically formalized. Some of the interrelations within this solar system are described in this equation:<sup>5</sup>

$$(1) \quad F_{\text{grav}} = Gmm'/R^2$$

This equation embodies a set of simultaneous constraints on the parameters of the objects, where  $m$  is the mass of the sun,  $m'$  is the mass of the planet,  $G$  is the gravitational constant, and  $F_{\text{grav}}$  is the gravitational force. For example, if  $F_{\text{grav}}$  decreases while the masses are constant, then the distance  $R$  between the sun and the planet must increase. Equation (1) summarizing the interrelations in the base maps into a corresponding target equation:

$$(2) \quad F_{\text{elec}} = -qq'/R^2$$

where  $q$  is the charge on the proton,  $q'$  the charge on the electron,  $R$  the distance between the two objects, and  $F_{\text{elec}}$  is the electromagnetic force.<sup>6</sup>

All these analogical predications are attempted predications, to use Ortony's (1979) term; they must be checked against the person's existing knowledge of the target domain. But the structural bias for relationality and systematicity provides an implicit guide to which predications to check.

### Two Analogies for Electricity

The domain of simple electricity is ideal for investigating the role of analogy. It is a familiar phenomenon; everyone in our society knows at least a little about it. Further, it is tractable: We can define ideal correct understanding. Yet because its mechanisms are essentially invisible, electricity is often explained by analogy. Moreover, because no single analogy has all the correct properties, we can compare different analogies for the same target domain. Finally, a great advantage of electronics is that, using simple combinations of circuit elements, it is easy to devise problems that require quantitative inferences that cannot be mimicked by mere lexical connections.

#### The Water-Flow Analogy

The analogy most frequently used to explain electricity is the water-flow analogy. We begin with this analogy, and later discuss an alternative analogy for electricity. The following passage is part of the instructions for a miniature lamp kit (Illinois Hobbycraft Inc., 1976).

#### Electricity and Water - An Analogy

An electrical system can be compared to a water system. Water flows through the pipes of a water system. Electricity can be considered as "flowing" through the wires of an electrical system.

Wire is the pipe that electricity "flows" through.

Volts is the term for electrical pressure.

Milliamperes is the term for electrical "volume."

Here the base domain is a plumbing system and the object mappings are that a water pipe is mapped onto a wire, a pump or reservoir is mapped onto a battery, a narrow constriction is mapped onto a resistor, and flowing water is mapped onto electric current. What predicates is this analogy supposed to convey? Not that electricity shares object attributes with water, such as being wet, transparent, or cold to the touch. This analogy is meant to convey a system of relationships that can be imported from hydraulics to electricity. In the next passages we discuss this relational structure, first for hydraulics and then for electricity. This will serve both to explicate the analogy and to provide some insight into electricity for readers who are unfamiliar with the domain. Then we compare the hydraulic analogy with another common analogy for electricity, the moving-crowd model.

Simple hydraulics. We begin with a reservoir with an outlet at its base. The pressure of the water at the outlet is proportional to the height of water in the reservoir. (See Figure 3 and Figure 6 below.) The rate of flow through any point in the system is the amount of water that passes that point per unit time. Pressure and flow rate are clearly distinguishable: Rate of flow is how much water is flowing,

while pressure is the force per unit area exerted by the water. Yet there is a strong relation between pressure and flow: The rate of flow through a section is proportional to the pressure difference through that section. This means that the greater the height of water in the reservoir, the greater the flow rate, all else being equal.

A constriction in the pipe leads to a drop in pressure. Water pressure, which is high when the water leaves the reservoir, drops across the constriction. The narrower the constriction, the greater the pressure drop. A constriction also affects flow rate: The greater the constriction in a section, the lower the flow rate through that section. Figure 3b shows the relations among flow rate, pressure and degree of constriction for a hydraulics system.

The analogy with electricity. An electrical circuit is analogous to the plumbing system just described. Table 1 shows the object correspondences, as well as some of the predicates that are imported from base to target. Notice that the predicates that are shared are relational predicates: for example, that increasing voltage causes an increase in current.

The first insight derivable from the analogy is the distinction between the flow rate and pressure, which maps onto an analogous distinction between current (the number of electrons passing a given point per second) and voltage (the pressure difference through which the current moves). This aspect of the analogy is important because novices in electricity often fail to differentiate current and voltage; they seem to merge the two of them into a kind of generalized-strength notion. For example, one subject, defining voltage, says:

". . . Volts is . . . the strength of the current available to you in an outlet. And I don't know if it means there are more of those little electrons running around or if they're moving faster; . . . "

Besides the current-voltage distinction, the analogy conveys the interrelation between current, voltage and resistance. Figure 3a shows the structural description of the circuit induced by the mapping. The batteries, wire, and resistors of an electrical circuit correspond to the reservoirs, pipes, and constriction of a plumbing system. Note the parallel



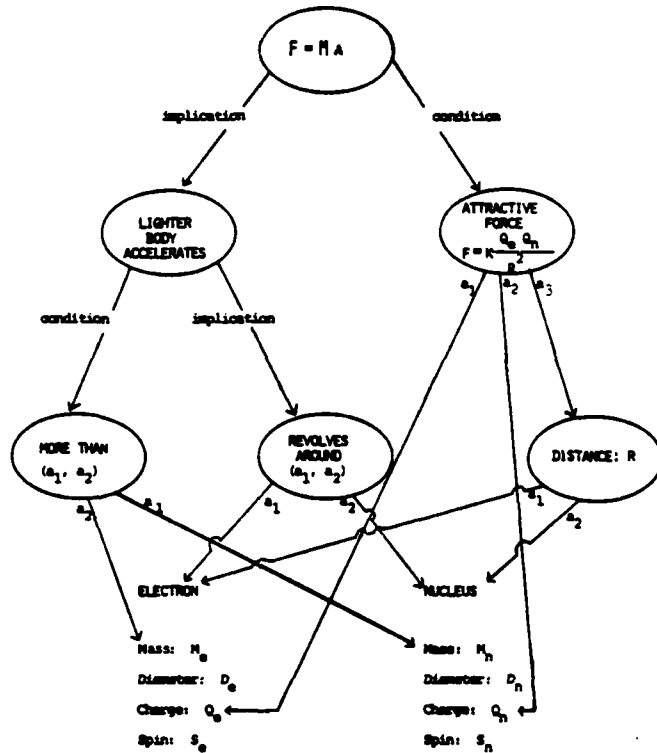
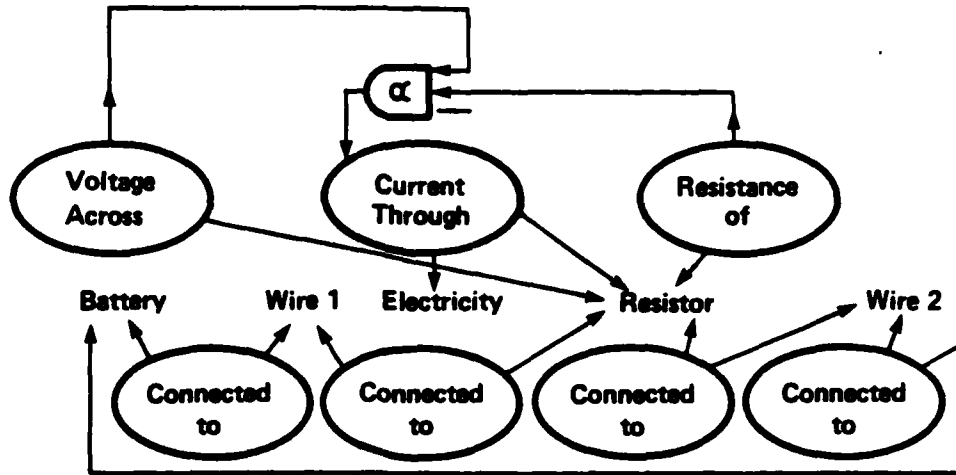

Figure 3a

Figure 3. Representation of knowledge about (a) simple electric circuits and (b) simple hydraulic systems, showing overlap in relational structures. The relation stands for a higher-order qualitative division relation: The output (e.g., current) varies monotonically with the positive input (e.g., voltage) and negative--monotonically with the negative input (e.g., resistance).

**SIMPLE CIRCUIT**



**WATER SYSTEM**

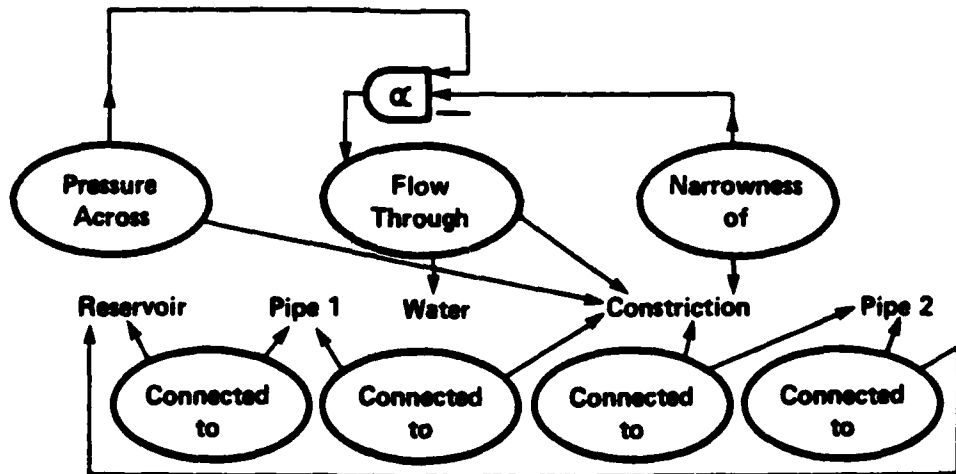

Figure 3b

TABLE 1

MAPPINGS BETWEEN WATER FLOW AND ELECTRICITY

BASE - HYDRAULIC SYSTEM

TARGET - CIRCUIT

OBJECT MAPPINGS:

pipe  
pump  
narrow pipe

wire  
battery  
resistor

PROPERTY MAPPINGS:

PRESSURE of water  
NARROWNESS of pipe  
FLOW RATE of water

VOLTAGE  
RESISTANCE  
CURRENT  
(FLOW RATE of electricity)

RELATIONS IMPORTED:

CONNECT  
(pipe, pump, narrow pipe)  
INCREASE WITH  
(flow rate, pressure)  
DECREASE WITH  
(flow rate, narrowness)

CONNECT  
(wire, battery, resistor)  
INCREASE WITH  
(current, voltage)  
DECREASE WITH  
(current, resistance)

interdependency relations in the two systems (Figures 3a and 3b): e.g., Electrons flow through the circuit because of a voltage difference produced by the battery, just as water flows through the plumbing system because of a pressure difference produced by the reservoir. Thus, the analogy conveys the dependency relations that constitute Ohm's Law,  $V=IR$ . Of course, naive users of the analogy may derive only simpler proportional relations such as "More force, more flow" and "More drag, less flow." These qualitative-proportion relationships (see Forbus, in preparation) may be phenomenological primitives, in the sense discussed by diSessa (1982).

#### The Moving-crowd Model

Besides the hydraulics model, the most frequent spontaneous analogy for electricity is the moving-crowd analogy. In this analogy, electric current is seen as masses of objects racing through passageways, as in these passages from interviews:

- (1) You can always trick the little devils to go around or through . . . Because they have to do that. I mean, they are driven to seek out the opposite pole. In between their getting to their destination, you can trick them into going into different sorts of configurations, to make them work for you . . .
- (2) If you increase resistance in the circuit, the current slows down. Now that's like a highway, cars on a

highway where . . . as you close down a lane . . . the cars move slower through that narrow point.

The moving-crowd model can provide most of the relations required to understand electrical circuits. In this model current corresponds to the number of entities that pass a point per unit time. Voltage corresponds to how powerfully they push. Like the water analogy, the moving-crowd model establishes a distinction between current and voltage. Further, the moving-crowd model allows a superior treatment of resistors. In this model we can think of a resistor as analogous to a barrier containing a narrow gate. This "gate" conception of resistors is helpful in predicting how combinations of resistors will behave, as we will describe in the following section. However, it is hard to find a useful realization of batteries in this model.

### Experiments on Analogies for Electricity

#### Rationale and Overview

The language used in the protocols suggests that people base their understanding of electronics at least in part on knowledge imported from well-known base domains. But are these true generative analogies or merely surface terminology? In order to verify that the use of a particular model leads to predictable inferences in the target domain, we performed two studies of analogical models in electronics. In Experiment 1, we elicited subjects' models of electronics and asked whether their models

predict the types of inferences they make. In Experiment 2, we taught subjects different analogical models of electronics and compared their subsequent patterns of inference.

### The Four Combinatorial Problems

We wished to test deep indirect inferences that could not be mimicked by surface associations. At the same time, we needed to keep our problems simple enough for novices to attempt. The solution was to ask about different combinations of simple components. There were four basic combination circuits, namely the four circuits generated by series and parallel combinations of pairs of batteries or resistors, as shown in Figure 4. For example, we asked how the current in a simple circuit with one battery and resistor compares with that in a circuit with two resistors in series, or with two batteries in parallel.

The chief difficulty in these combination problems is differentiating between serial and parallel combinations. The serial combinations are straightforward: More batteries lead to more current and more resistors to less current. This accords with the first level of novice insight: the "More force, more flow/more drag, less flow" model, in which current goes up with the number of batteries and goes down with the number of resistors. But the parallel combinations do not fit this naive model: As Figure 4 shows, parallel batteries give the same current as a single battery, and parallel resistors lead to more current than a single resistor (always assuming identical batteries and resistors).

	CURRENT	VOLTAGE DIFFERENCE BETWEEN X AND Z
<p>Simple Circuit</p>  <p><math>I = V/R</math></p>	I	V
<p>Serial Batteries</p> 	2I	2V
<p>Parallel Batteries</p> 	I	V
<p>Serial Resistors</p> 	I/2	V
<p>Parallel Resistors</p> 	2I	V

Figure 4. Current and voltage for the four combination circuits: serial and parallel pairs of batteries or resistors. A simple battery-resistor circuit is shown at top.

Combinations of batteries. To gain some intuition for these combinations, we return briefly to the water domain for a review of serial and parallel reservoirs. Consider what happens when two reservoirs are connected in series, one on top of the other. Because the pressure produced by the reservoirs is determined by the height of the water and the height has doubled, two reservoirs in series produce twice the original pressure, and thus twice the original flow rate. This conforms to the intuition that doubling the number of sources doubles the flow rate. However, if two reservoirs are connected in parallel, at the same level, the height of the water will be the same as with the single reservoir. Because pressure depends on height, not on total amount of water, the pressure and flow rate will be the same as that of the original one-reservoir system (although the capacity and longevity of the system will be greater).

Figure 5 shows the higher-order relationships comparing flow rate given parallel or serial reservoirs with flow rate in the simple one-reservoir system. The same higher-order relationships hold in the domain of electricity: The current in a circuit with two serial batteries is greater than the current with a single battery. Current given two parallel batteries is equal to that

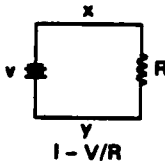
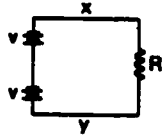
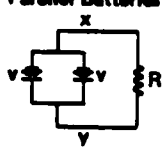
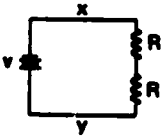
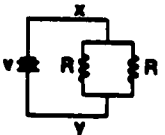

given a single battery.

Combinations of resistors. These combinations are understood most easily through the moving-crowd model, in which resistors can be thought of as gates. In the serial case, all the moving objects must pass through two gates, one after the other, so the rate of flow should be lower than for just one gate. In the parallel case, the flow splits and moves through two side-by-side gates. Since each gate passes the usual flow, the overall flow rate should be twice the rate for a single gate.<sup>7</sup> Applying these relationships in the domain of electricity, we conclude that serial resistors lead to less current than a single resistor; whereas parallel resistors lead to more current.

#### Predicted Differences in Patterns of Inference

The flowing-water and moving-crowd models should lead to different patterns of performance on the four combination circuits. Both models can yield the first-stage "More force, more flow/more drag, less flow" law. Where the models should differ is in the ease with which further distinctions can be perceived. Subjects with the flowing-water model should be more likely to see the difference between the two kinds of battery combinations. Subjects with the moving-crowd model should be more likely to see the difference between the two kinds of resistor combinations.

Flowing-fluid model. Subjects who use the flowing-fluid

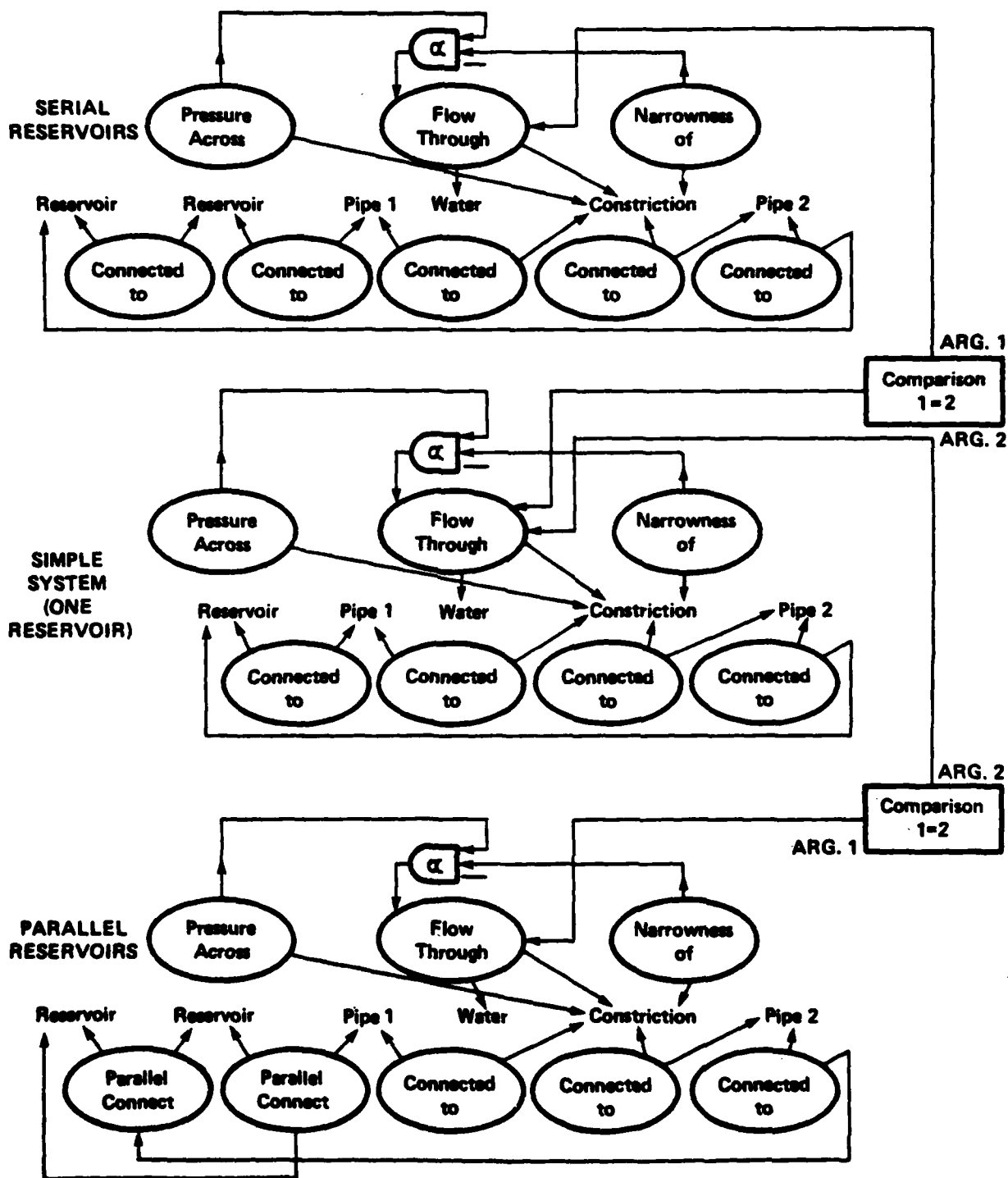

Figure 5. Representation of knowledge in the hydraulic domain, showing higher-order comparison relations between rate of water flow in systems with parallel reservoirs and systems with serial reservoirs as compared with simple one-reservoir systems.

model should do well on the battery questions. This is because, as described earlier, serial and parallel reservoirs combine in the same manner as serial and parallel batteries; thus already-familiar combinational distinctions can be imported from the water domain. However, subjects with the fluid flow model should do less well on resistor combinations. In the hydraulic model resistors are viewed as impediments. This often leads people to adopt the "More drag, less flow" view. Here people focus on the idea that in both parallel and serial configurations the water is subjected to two obstacles rather than one. They conclude that two resistors lead to less current, regardless of the configuration.

Moving-crowd model. For subjects with the moving-crowd model, the pattern should be quite different. In this model, configurations of batteries should be relatively difficult to differentiate, since it is hard to think of good analogs for batteries with the correct serial-parallel behavior. In contrast, resistors should be better understood, because they can be seen as gates. This should lead to better differentiation between the parallel and serial configurations, as described earlier. Subjects using this model should correctly respond that parallel resistors give more current than a single resistor; and serial resistors, less current.

The following protocol excerpt illustrates the superiority of the moving-crowd model for understanding parallel resistors.

The subject began with the flowing-fluid model and incorrectly predicted less current in a parallel-resistor circuit:

We started off as one pipe, but then we split into two . . . We have a different current in the split-off section, and then we bring it back together. That's a whole different thing. That just functions as one big pipe of some obscure description. So you should not get as much current.

The experimenter then suggested that the subject try using a moving-crowd analogy. With this model, the subject rapidly derived the correct answer of more current for parallel resistors:

Again I have all these people coming along here. I have this big area here where people are milling around. . . . I can model the two gate system by just putting the two gates right into the arena just like that . . . There are two gates instead of one which seems to imply that twice as many people can get through. So that seems to imply that the resistance would be half as great if there were only one gate for all those people.

Figure 6 shows drawings of the analogs in the two systems, similar to those drawn by the subject. (Drawings of simple and serial-resistor systems are shown for comparison.)

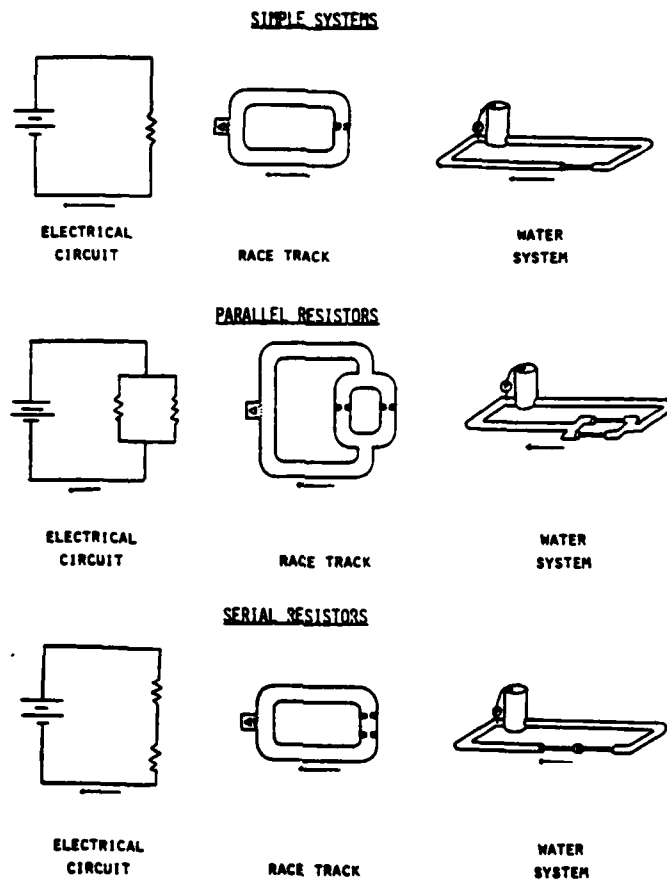

Figure 6. Diagrams of electrical circuits, moving-crowd tracks and hydraulic systems, showing analogous systems for simple circuits, parallel-resistors circuits and serial-resistors circuits.

These two sections of protocol suggest that models do affect inferences. The subject who drew incorrect conclusions using the water analogy later drew correct inferences using the moving-crowd analogy. The following study tests this pattern on a larger scale. If these models are truly generative analogies, we should find that the fluid-flow people do better with batteries than resistors, and the moving-crowd people do better with resistors than with batteries.

### EXPERIMENT 1

#### Subjects

The subjects were 36 high school and college students, screened to be fairly naive about physical science. They were paid for their participation. Only subjects who used the same model throughout the study, as determined from their questionnaire responses, are included in the results discussed below. Also, among subjects who used a fluid-flow model, only those who correctly answered two later questions about the behavior of water systems were included. There were seven subjects who consistently used fluid flow models and eight subjects who consistently used moving object models. The responses of subjects who were inconsistent in their use of models were analyzed separately and are not reported here.

#### Method

Qualitative circuit comparisons. Subjects were given

booklets containing a series of questions and allowed to work at their own pace. The first page showed a simple circuit with a battery and a resistor, like the simple circuit in Figure 4. Succeeding pages showed the four series-and-parallel combination circuits (see Figure 4). They were asked to circle whether the current (and voltage) in each of the combination circuits would be greater than, equal to, or less than that of the simple battery-resistor circuit.

Questions about models. After the subjects gave their answers for all four combination circuits, they were asked on a separate page to describe the way they thought about electricity. In order not to prejudice their answers, they were simply given a blank area to fill in. On the next page, they were given a more specific choice: For each of the four circuit problems, they were asked to circle whether they had thought about flowing fluid, moving objects, or some other view of electricity while working on the problem. On the final page of the booklet they were asked questions about the behavior of reservoirs in the water domain.

### Results

Figure 7 shows the results for subjects who reported using either the flowing-fluid analogy or the moving-crowd analogy consistently, on all four problems.

The patterns of inference are different depending on which

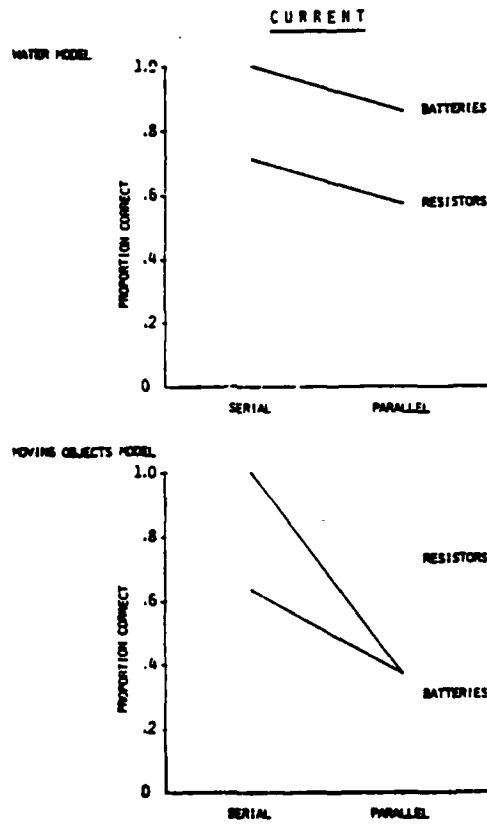

Figure 7. Results of Experiment 1: Proportions correct, for subjects with either a water-flow model or a moving-crowd model of electricity, on serial and parallel problems for batteries and resistors.



model the subject had. As predicted, people who used the flowing-fluid model performed better on batteries than on resistors. The reverse is true for the moving-crowd people: they performed better with resistors, particularly in parallel, than with batteries. A Model X Component X Topology 2 X 2 X 2 analysis of variance was performed on the proportions of correct answers. Here Model refers to whether the subject was using a flowing-fluid or moving-crowd model of electricity; Component refers to whether the combination was of batteries or resistors; and Topology refers to whether the problem involved a serial or parallel configuration. As predicted, the interaction between Model and Component was significant;  $F(1,13) = 4.53$ ;  $p < .05$ . No other effects were significant.

### Conclusions

The results of the study indicate that use of different analogies leads to systematic differences in the patterns of inferences in the target domain. Subjects with the flowing fluid model did better with batteries, while moving objects subjects did better with resistors. These combinatorial differences cannot be attributed to shallow verbal associations. These analogies seem to be truly generative for our subjects; structural relations from the base domain are reflected in inferences in the target domain.

Experiment 2

In this study we taught subjects about electricity, varying the base domain used in the explanation. We then compared their responses to a series of questions about the target domain. Three different models of electronic circuitry were used. The first two models were versions of the hydraulic model, with fluid flow mapping onto current, pumps or reservoirs mapping onto batteries, pipes onto wires, and narrow pipes onto resistors. The two versions of this model varied according to what maps onto the battery: either a pump (Model P) or a reservoir (Model R). The third model was a moving-crowd model (Model M). In this model, current was seen as a moving crowd of mice and voltage was the forward pressure or pushiness of the mice.

The basic method was to present different groups of subjects with different models of electronics and then observe their responses to circuit problems. As in Experiment 1, the dependent measure is not merely percent correct but the pattern of responses. Each model should cause particular incorrect inferences as well as particular correct inferences. We also presented problems in the base domains. It seemed possible that subjects might have misconceptions in the base domains (such as hydraulics); in this case the knowledge available for importing into the target would deviate from the ideal knowledge.

Predicted Results

In the two hydraulics models, reservoirs (R) or pumps (P) are sources of pressure (voltage), which results in a flow of liquid (current) depending on the narrowness of the pipes (resistance). In the moving-crowd model, M, the forward pressure on the crowd (voltage), is generated by a loudspeaker shouting encouragement. This pressure creates a certain number of mice past a point per unit time (current) depending on the narrowness of the gates (resistance). Table 2 shows the correspondences among the three models.

Our major predictions were:

1. that the moving-crowd model (M) would lead to better understanding of resistors, particularly the effects of parallel resistors on current, than the hydraulics models.
2. that the reservoir model (R) would lead to better understanding of combinations of batteries than either the moving-crowd model (M) or the pump model (P). With reservoirs, the correct inferences for series versus parallel can be derived by keeping track of the resulting height of water, as discussed earlier. Neither the pump analog nor the loudspeaker analog has as clear a combination pattern.

Method

Subjects. Eighteen people participated, all either advanced high school or beginning college students from the Boston area.

Table 2

Comparison of Water Flow, Moving Crowd, and Electricity Domains

<u>Water Flow Models (R,P)</u>	<u>Crowd of Mice Model(M)</u>	<u>Electrical Circuit</u>
hydraulic system		
water pipe	race course	circuit
pump or reservoir	mice	electricity or electrons
constriction in pipe	wide corridor	wire
	loudspeaker	battery
	gate in barrier	resistor
	<u>Attribute Mappings</u>	
PRESSURE OF water	PRESSURE OF mice	VOLTAGE
NARROWNESS OF pipe	NARROWNESS OF gate	RESISTANCE
FLOW OF pipe	PASSAGE RATE OF mice	CURRENT
	<u>Relations between Objects that Hold in All Domains</u>	
pump CONNECTED TO pipe	loudspeaker CONNECTED TO corridor	battery CONNECTED TO wire
pipe CONNECTED TO constriction	corridor CONNECTED TO gate	wire CONNECTED TO resistor
	<u>Higher-order Relations that Hold in All Domains</u>	
(FLOW OF water) INCREASES WITH (PRESSURE ACROSS constriction)	(PASSAGE RATE OF mice) INCREASES WITH (PRESSURE ACROSS gate)	(CURRENT) INCREASES WITH (VOLTAGE ACROSS resistor)

TABLE 2 continued

(FLOW OF water) DECREASES WITH (NARROWNESS OF constriction)	(PASSAGE RATE OF mice) DECREASES WITH (NARROWNESS OF gate)	(CURRENT) DECREASES WITH (RESISTANCE)
[SUM OF (FLOW INTO point)]EQUALS[SUM OF (FLOW OUT OF point)]	[SUM OF (PASSAGE RATE INTO POINT)]EQUALS [SUM OF (PASSAGE RATE OUT OF point)]	[SUM OF (CURRENT INTO point)] EQUALS [SUM OF (CURRENT OUT OF point)]
RATIO OF (cross-section WIDTHS OF pipe and constrictions) is typically 100:1	RATIO OF (WIDTHS OF corridor and gate) is typically 10:1	RATIO OF (RESISTANCES OF resistor and wire) is typically 1,000,000:1

Relations that Do Not Hold in All Domains

Subjects had little or no previous knowledge of electronics. They were paid for their participation. Due to experimenter's error, there were seven subjects in the M group, six in the P group and five in the R group.

Procedure. After filling out a questionnaire concerning their general backgrounds, subjects were divided into three groups, each receiving different models. The procedure was as follows:

1. Model-teaching. Subjects were given a brief introduction to electricity consisting of Ohm's Law ( $I=V/R$ ) together with an explanation of one of the three models.
2. Simple test. All three groups were given an identical set of five simple circuit problems to calculate. In each case the circuit was a simple battery-plus-resistor circuit, and subjects solved for current, voltage or resistance by applying Ohm's Law. We required that subjects solve at least four problems correctly to be included in the study.
3. Qualitative comparisons. Subjects were next shown diagrams of the four complex circuits (SB, PB, SR, and PR, as shown in Figure 4) along with a diagram of a simple battery-resistor circuits. For each such complex circuit, we asked subjects to compare current and voltage at several points in the circuit with that of the corresponding point in a simple circuit; e.g., they were asked whether current just before the resistors in a parallel-resistor circuit is greater than,

equal to or less than the corresponding current in a simple circuit.

4. Quantitative scaling. Each subject received each of the four kinds of complex circuits (SB, SR, PB or PR) and filled out a series of scales indicating current and voltage at the same test points as in task (3).
5. Drawing base given target analog. Each subject received, for each of the four complex circuits, a sheet containing a simple base version of the standard simple system (analog of battery plus resistor); and a circuit drawing of one of the four complex circuits (SB, SR, PB or PR). They were told to draw the base version of the complex circuit shown.
6. Base qualitative questions. To test knowledge of the base system, subjects were given a picture of one of the four complex systems in the base, and answered qualitative questions about pressure and flow rate in the base system. Each sheet showed a simple system (the analog of battery plus resistor) plus a complex system (the analog of SB, SR, PB or PR). The subjects made judgments at the same points as in tasks (3) and (4).
7. Thought questions. Subjects were asked to write out answers to questions such as "What will happen if there is no resistor in the circuit?"; and "Do electrons go faster, slower or the same speed through the resistor as through the wire?"

Results: Prediction 1

Results supported the first prediction, that the moving-crowd model (M) would lead to better performance on parallel-resistor problems than the water models (P and R).

Quantitative comparisons. In the M group, 93% of the subjects answered that current given two parallel resistors would be greater than or equal to current given a single resistor, as compared with .63 for the combined P and R groups. This difference between the M group and the P and R groups combined was significant by a  $\chi^2$  test ( $p < .05$ ). Table 3 shows the results for current given parallel resistors both for the qualitative comparisons task and for the quantitative scaling task.

The pattern of M-superiority on parallel-resistor problems also obtained for voltage. The proportions of questions in which subjects (correctly) answered that the voltage in a circuit with two parallel resistors is equal to the voltage in the simple circuit with one resistor were, for the M group, .86; for the P group, .42; and for the R group, .50. Again, the M group is significantly different from the combined P and R groups by a  $\chi^2$  test ( $p < .025$ ); M differs from P significantly as well (Fisher test,  $p < .05$ ).

Quantitative scaling. The differences, though nonsignificant, were in the predicted direction, as shown in Table 3. The proportions of times subjects answered that current



Table 3

Results of Experiment 2: Performance on Problems  
Involving Current with Parallel Resistors

	M	P	R
Qualitative Comparisons <sup>a</sup>	.93	.58	.70
Quantitative Scaling <sup>b</sup>	.71	.50	.40

- a. Proportions of responses that current in parallel-resistor circuit is greater than or equal to current in simple one-resistor circuit.
- b. Proportions of responses that current in parallel-resistor circuit is greater than current in simple circuit.

in a parallel-resistor circuit would exceed current given a single resistor were .71 for M, .50 for P, and .40 for R. For voltage, the proportions of times subjects answered that voltage in a PR circuit equals that in a simple circuit were .86 for M, .83 for P and .60 for R.

Results: Prediction 2

Our second prediction, that the R group would be superior to the M and P groups on parallel-batteries problems, was not supported.

Qualitative comparisons. The proportions of times subjects correctly answered that the voltage given parallel batteries is equal to the voltage given a single battery were .40 for the R group, .64 for the M group, and .33 for the P group. None of these differences was statistically significant.

For serial-battery problems, we expected less difference between the groups. This is because the correct answer--that voltage is greater in a circuit with two batteries in serial than with just one battery--is derivable from several different models, even from the naive "More force, more flow" view. The results are that the proportion of correct responses was .60 for R and .50 for P; for the M group, it was .57 (no significant differences).

Quantitative scaling. Again we failed to find clear evidence that the R group understood parallel-battery problems

better than the P group. The proportions of correct answers (that voltage is the same for PB as for a simple circuit) were .2 for R and .33 for P. The R group did perform better on the serial battery problems: .8 of the R answers indicated more voltage with serial batteries, whereas only .33 of the P answers did so. None of these differences is significant. (This lack of significance may seem surprising; however, we had only one data point per subject.) Rather surprisingly, the M group, with .86 correct, was significantly better than the other two groups on parallel batteries ( $p < .025$ ,  $X^2$ ).

#### Other Results in the Qualitative Comparison and Quantitative Scaling Tasks

There were two other significant differences. First, in the qualitative comparisons task, the P group was superior to the R group for current in a serial-resistor circuit. The proportion of times subjects correctly answered that current is lower with two serial resistors than with a single resistor was .58 for P and .10 for R ( $p < .05$ ). There were no other significant differences on the qualitative comparison task.

The other remaining significant result is that, in the quantitative scaling problems, the R group performed better (at .40 correct) than the M group (0 correct) or P group (0 correct) on answering that current is constant everywhere in a purely serial circuit (such as SB or SR). The difference between R and P is significant ( $p < .05$ ) as well as the difference between R and

M ( $p < .025$ ). This issue of constant study-state current flow seems quite difficult for subjects, as discussed next.

Subjects' knowledge of the base. We were puzzled by the failure of Prediction 2: the finding that the R group did not excel at combinations of batteries, in spite of the seeming transparency of the corresponding combinations in the reservoir domain. One possible explanation is that, contrary to our intuitions, our subjects did not understand serial and parallel reservoirs any better than they understood serial and parallel pumps or loudspeakers. To check this possibility, we examined the subjects' answers in the base domains.

The results of the Base Qualitative Comparisons task revealed that subjects indeed failed to grasp the distinction between parallel and serial pressure sources in the base domains. Scores on the qualitative comparison problems concerning rate of flow of water or animals (analogous to current) was .35 for R, .42 for P and .32 for M. It is not surprising, then, that the R subjects failed to make correct inferences in the target domain of electricity.

Subsequent interviews have borne out the suspicion that even college-educated people fail to understand the way water behaves. They have difficulties not only with series versus parallel combinations of reservoirs or pumps, but also with the notion of steady-state flow. Current is seen not as a steady flow, constant throughout the system, but rather as a

progression: Flow is strong and rapid at the source and gradually weakens as it goes through the pipes, with a drastic cut-back as it goes through the constriction. Moreover, people often fail to make the distinction between flow rate and related physical variables. Many people seem to have a generalized strength-attribute which is a composite of velocity, pressure, force of water, and rate of flow. This strength is thought to be very high at the outset, just after the reservoir, to diminish as the water travels around the water system, and to decrease sharply at the constriction.

Similar misconceptions show up in electronics. People in interviews do appear to have a kind of composite strength attribute that is interchangeably referred to as current, voltage, velocity of the electrons, power, pressure, or force of the electrons. This strength attribute fails to obey steady-state: It decreases as the stuff flows around the circuit, with the sharpest diminution occurring at the resistor.

The subjects' misconceptions in electronics are strikingly analogous to those in hydraulics. Therefore, subjects' failure to import veridical differentiations from the base domain does not constitute evidence against the Generative Analogies hypothesis. Even a fully generative, rigorous structure-mapping process cannot produce correct distinctions in the target domain unless subjects have grasped these differentiations in the base domain. Our investigations bring home the point that an analogy

is only useful to the extent that the desired relational structure is present in the person's representation of the base domain.

#### DISCUSSION

It is an appealing notion that analogies function as tools of thought (Clement, 1981; Darden, 1980; Dreistadt, 1968; Hesse, 1966; Hoffman, 1980; Jones, in preparation; Oppenheimer, 1955). In this research we have sought to bring psychological evidence to bear on this claim.

We first noted that we find analogical references in people's spontaneous discussions of natural phenomena; for example, when a person discusses electric current in terms of traffic or in terms of flow of water. Our protocols suggest that people use analogies to help structure unfamiliar domains. The pervasiveness and generative quality of people's analogical language suggests that the analogies are used in thinking (Lakoff & Johnson, 1980; Quinn, 1981; Reddy, 1979; Schon, 1979). But to make this conclusion it must be demonstrated that the thinking truly depends on the analogy: that the analogy is more than a convenient vocabulary in which to discuss the results of independent inferential processes.

Evidence for the conceptual role of analogy comes from the introspections of creative scientists. The journals and self-descriptions of scientists from Johannes Kepler (1969; see also

Koestler, 1963) to Sheldon Glashow (1980) seem to lean heavily on analogical comparisons in discovering scientific laws. Glashow's account of his use of generative analogies in nuclear physics was quoted earlier. Kepler's journals show several signs of generative analogy use. First, Kepler makes reference to the analogy in stating his theory. Second, he appears to derive further insights from the analogy over time. Finally, as quoted earlier in this chapter, Kepler himself states that he uses analogy to further his thinking. The tempting conclusion is that, for scientists like Kepler and Glashow, analogies are genuine conceptual tools.

However, self-reports concerning psychological processes are not conclusive evidence, as Nisbett and Wilson (1977) have argued. In this research we tested the Generative Analogy hypothesis that analogy is an important source of insight by asking whether truly different inferences in a given target domain are engendered by different analogies. We chose as our target domain simple electricity, partly because it has the right degree of familiarity, and partly because there are two good, readily available base domains--flowing water and moving crowds--that support different inferences in the target domain.

To test this hypothesis, we needed to find problems for which the inferences required in the target could not be mimicked by verbal patterns, but would reflect structural relations imported from these different base domains. We chose the four

combinatorial problems described earlier: serial and parallel combinations of resistors and batteries. These problems are simple enough to be posed even to a novice, yet are nontransparent enough that they require some sustained thought. We predicted that the parallel-serial distinction for batteries should be clearer using flowing fluid as the base. This is because the pressure difference between serial and parallel reservoirs can be understood in terms of height of fluid, a relatively accessible distinction. Therefore, use of the water system as a base domain should improve understanding of batteries. In contrast, the parallel-serial distinction for resistors should be more obvious using the moving-crowd base domain. In the moving-crowd model, resistors can be thought of as gates (inferior passages) rather than as obstructions. Subjects who use that model should see that parallel resistors, analogous to gates side by side, will allow more flow than a single resistor. The opportunity is there to find effects of thinking in different analogical models.

In Experiment 1, we divided subjects according to which analogy they reported using for electricity and compared their inferences about the current in our four combination problems. We found, as predicted, that subjects using the water model (given that they understood the way water behaves) differentiated batteries more correctly than resistors, and that subjects who used the moving-crowd model were more accurate for resistors than for batteries. These results support the generative analogies



claim of a true conceptual role for analogical models. The pattern of inferences a subject made in the target domain did indeed match the pattern that should have been imported from the base domain.

Experiment 1 provided evidence for the Generative Analogies hypothesis for people's preexisting spontaneous analogies. Experiment 2 examined the effects of analogical models that were taught to subjects. In Experiment 2, we taught people to use one of three models and compared their subsequent patterns of inference. If people's inferential patterns varied according to the model they were taught, this would provide a second line of evidence for analogical reasoning. We found some of the predicted effects in Experiment 2. Subjects who were taught the moving-crowd analogy could differentiate parallel versus serial resistor configurations more accurately than subjects who had learned either of the water models. However, we did not find the predicted differences in ability to differentiate the two types of battery combinations.

We suspect that there are two main reasons that the results of Experiment 2 were weaker than those of Experiment 1. The first problem was that we did not screen people for knowledge of the water domain in Experiment 2. In many cases people simply did not understand that serial reservoirs and parallel reservoirs yield different pressure in the domain of water. Because we had information concerning subjects' knowledge of the respective base

domains, we were able to demonstrate that in many cases the failure of the analogical inference was due to the lack of the corresponding inference in the original base domain.

The phenomenon of mapping erroneous knowledge may be fairly widespread. Several independent researchers have reported that mental representations of physical phenomena - even among college populations - often contain profound errors. Yet, although these initial models may be fragmentary, inaccurate, and even internally inconsistent, nonetheless they strongly affect a person's construal of new information in the domain (Brown & Burton, 1975; Brown, Collins, & Harris, 1978; Clement, 1981, 1982; diSessa, 1982; Eylon & Reif, 1979; Gentner, 1980, 1982; Hayes, 1978; Hollan, Williams, & Stevens, 1982; Larkin, 1982; McCloskey, 1982; Sayeki, 1981; Stevens & Collins, 1980; Stevens, Collins, & Goldin, 1979; Wiser & Carey, 1982). Our research, and that of other investigators, suggests that these domain models, whether correct or incorrect, are carried over in analogical inferencing in other domains (Collins & Gentner, in preparation; Darden, 1980; Gentner, 1979; Johnson-Laird, 1980; Riley, 1981; VanLehn & Brown, 1980; Winston, 1978, 1980, 1981; Wiser & Carey, 1982).

Aside from the subjects' lack of insight in the base domain, the second problem with Experiment 2 is that the teaching sessions may have been inadequate to convince all the subjects to use the models. People simply read a one-page description of the

model that they were to learn, and then began answering questions. Accepting a new model often requires considerable time and practice. The problem of convincing subjects to use a particular model did not exist in Experiment 1; subjects were sorted according to the model they reported using a priori. This possible pattern of conservatism in use of new models accords with that found in experimental studies of analogical transfer by Gick and Holyoak (1980), and Schustack and Anderson (1979). Both these studies found that although subjects are demonstrably able to import relational structure from one domain to another, they often fail to notice and use a potential analogy. We suspect that one reason subjects may be slow to begin using a new analogy for an area is that they normally enter a study with existing models of the domain.

However, although Experiment 1 produced stronger results than Experiment 2, the results of the two experiments taken together provide clear evidence for the Generative Analogies hypothesis. People who think of electricity as though it were water import significant physical relationships from the domain of flowing fluids when they reason about electricity; and similarly for people who think of electricity in terms of crowds of moving objects. Generative analogies can indeed serve as inferential frameworks.

## References

- Brown, J. S., & Burton, R. R. Multiple representations of knowledge for tutorial reasoning. In D. G. Bobrow & A. Collins (Eds.), Representation and understanding. New York: Academic Press, 1975.
- Brown, J. S., Collins, A., & Harris, G. Artificial intelligence and learning strategies. In H. F. O'Neil (Ed.), Learning strategies. New York: Academic Press, 1978.
- Chi, M. T. H., Feltovich, P. J., & Glaser, R. Categorization and representation of physics problems by experts and novices. Cognitive Science, 1981, 5, 121-152.
- Clement, J. Analogy generation in scientific problem solving. Proceedings of the Third Annual Meeting of the Cognitive Science Society, Berkeley, California, August 1981.
- Collins, A. M., & Gentner, D. Constructing runnable mental models. In preparation.
- Darden, L. Theory construction in genetics. In T. Nicklles (Ed.) Scientific discovery: Case studies. D. Reidel Publishing Co., 1980.

de Kleer, J., & Sussman, G. J. Propagation of constraints applied to circuit synthesis (A.I.M. 485). Artificial Intelligence Laboratory, Massachusetts Institute of Technology, Cambridge, Mass, 1978.

Dreistadt, R. An analysis of the use of analogies and metaphors in science. The Journal of Psychology, 1968, 68, 97-116.

Eylon, B., & Reif, F. Effects of internal knowledge organization on task performance. Paper presented at the meeting of the American Educational Research Association, April, 1979.

Forbus, K. D. Qualitative process theory (A.I.M. 664). Artificial Intelligence Laboratory, Massachusetts Institute of Technology, February 1982.

Gentner, D. The structure of analogical models in science. Technical Report No. 4451, Bolt Beranek and Newman, July 1980.

Gentner, D. Are scientific analogies metaphors? In D. S. Miall (Ed.), Metaphor: Problems and perspectives, Brighton, Sussex, England: Harvester Press Ltd., 1982.

Gick, M. L., & Holyoak, K. J. Analogical problem solving. Cognitive Psychology, 1980, 12, 306-355.

Glashow, S. L. Toward a unified theory: Threads in a tapestry. Nobel prize lecture; Stockholm, December 1979. Reprinted in Science, 1980, 210, 1319-1323.

Hayes, P. J. The naive physics manifesto. Unpublished manuscript, University of Essex, Colchester, May 1978.

Hesse, M. B. Models and analogies in science. Notre Dame, Indiana: University of Notre Dame Press, 1966.

Hoffman, R. R. Metaphor in science. In R. P. Honeck & R. R. Hoffman (Eds.), The psycholinguistics of figurative language. Hillsdale, N.J.: Erlbaum, 1980.

Johnson-Laird, P. N. Mental models in cognitive science. Cognitive Science, 1980, 4, 71-115.

Jones, R. S. Physics as metaphor. In preparation.

Kepler, J. Epitome of Copernical astronomy, Books IV and V, Volume 1. New York: Kraus Reprint Company, 1969.

Koff, R. M. How does it work? New York: Doubleday, 1961.

Koestler, A. The sleepwalkers. New York: The Universal Library, Grosset & Dunlap, 1963.

Lakoff, G., & Johnson, M. Metaphors we live by. Chicago, Ill.: University of Chicago Press, 1980.

Miller, G. A. Images and models: Similes and metaphors. In A. Ortony (Ed.), Metaphor and thought. Cambridge, England: Cambridge University Press, 1979.

Oppenheimer, R. Analogy in science. Paper presented at the 63rd Annual Meeting of the American Psychological Association, San Francisco, Calif., September 1955.

Nisbett, R. E., & Wilson, T. D. Telling more than we know: Verbal reports on mental processes. Psychological Review, 84, 1977, 231-259.

Ortony, A. The role of similarity in similes and metaphors. In A. Ortony (Ed.), Metaphor and thought. Cambridge, England: Cambridge University Press, 1979.

Polya, G. Mathematics and plausible reasoning (Vol. 1). Princeton, N.J.: Princeton University Press, 1973.

Quinn, N. Marriage is a do-it-yourself project: The organization of marital goals. In Proceedings of the Third Annual Conference of the Cognitive Science Society, Berkeley, California, August 1981.

Reddy, M. J. The conduit metaphor: A case of frame conflict in our language about language. In A. Ortony (Ed.), Metaphor and thought. Cambridge, England: Cambridge University Press, 1979.

Rieger, C., & Grinberg, M. The declarative representation and procedural simulation of causality in physical mechanisms. Proceedings of the Fifth International Joint Conference on Artificial Intelligence, 1977, 250-255.

Riley, M. S. Representations and the acquisition of problem-solving skill in basic electricity/electronics. Paper presented at the Computer-based Instructional Systems and Simulation meeting, Carnegie-Mellon University, January 1981.

Rumelhart, D. E. Some problems with the notion of literal meaning. In A. Ortony (Ed.), Metaphor and thought. Cambridge, England: Cambridge University Press, 1979.

Rumelhart, D. E., & Abrahamson, A. A. A model for analogical reasoning. Cognitive psychology, 1973, 5, 1-28.

Rumelhart, D. E., & Norman, D. A. The active structural network. In D. A. Norman, D. E. Rumelhart & the LNR Research Group, Explorations in Cognition. San Francisco: W.H. Freeman & Co., 1975.



Rumelhart, D. E., & Ortony, A. Representation of knowledge. In R. C. Anderson, R. J. Spiro, & W. E. Montague (Eds.), Schooling and the acquisition of knowledge. Hillsdale, N.J.: Erlbaum, 1977.

Sayeki, Y. "Body analogy" and the cognition of rotated figures. Quarterly Newsletter of the Laboratory of Comparative Human Cognition, 1981, 3, 36-40.

Schank, R., & Abelson, R. Scripts, plans, goals, and understanding. Hillsdale, N.J.: Erlbaum, 1977.

Schon, D. A. Generative metaphor: A perspective on problem-setting in social policy. In A. Ortony (Ed.), Metaphor and thought. Cambridge, England: Cambridge University Press, 1979.

Schustack, M. W., & Anderson, J. R. Effects of analogy to prior knowledge on memory for new information. Journal of Verbal Learning and Verbal Behavior, 1979, 18, 565-583.

Smith, B. C. Computational reflection. Doctoral dissertation, Electrical Engineering and Computer Science. Massachusetts Institute of Technology, in preparation.

Sternberg, R. J. Component processes in analogical reasoning. Psychological review, 1977, 84, 353-378.

Stevens, A., & Collins, A. Multiple conceptual models of a complex system. In R. E. Snow, P. Federico, & W. E. Montague (Eds.), Aptitude, learning and instruction (Vol. 2). Hillsdale, N.J.: Erlbaum, 1980.

Stevens, A., Collins, A., & Goldin, S. E. Misconceptions in student's understanding. Journal of Man-Machine Studies, 1979, 11, 145-156.

Tourangeau, R., & Sternberg, R. J. Aptness in metaphor. Cognitive Psychology, 1981, 13, 27-55.

Tversky, A. Features of similarity. Psychological Review, 1977, 84, 327-352.

VanLehn, K., & Brown, J. S. Planning nets: A representation for formalizing analogies and semantic models of procedural skills. In R. E. Snow, P. A. Federico, & W. E. Montague (Eds.), Aptitude, learning and instruction (Vol. 2). Hillsdale, N.J.: Erlbaum, 1980.

Verbrugge, R. R., & McCarrell, N. S. Metaphoric comprehension: Studies in reminding and resembling. Cognitive psychology, 1977, 9, 494-533.

Winston, P. H. Learning by creating and justifying transfer frames. Artificial Intelligence, 1978, 10, 147-172.

Winston, P. H. Learning and reasoning by analogy. CACM, 1980,  
23, No. 12.

Winston, P. H. Learning new principles from precedents and  
exercises: The details (A.I.M. 632). Artificial  
Intelligence Laboratory, Massachusetts Institute of  
Technology, November 1981.

## Footnotes

<sup>1</sup> This research was supported by the Department of the Navy, Office of Naval Research under Contract No. N00014-79-0338.

We would like to thank Allan Collins and Al Stevens, who collaborated on the development of these ideas, and Susan Carey, Ken Forbus, David Rumelhart, Billy Salter and Ed Smith for helpful comments on earlier versions of this paper. We also thank Molly Brewer, Judith Block, Phil Kohn, Brenda Starr and Ben Teitelbaum for their help with the research and Cindy Hunt for preparing the manuscript.

<sup>2</sup> Indeed, this problem was a chief reason that Bohr was forced to modify the solar system model, adding the notion of fixed orbital shells and allowable quanta of energy. Still later, this shell model was superseded by the idea that the position of the electron is best described by a probability distribution.

<sup>3</sup> An adequate discussion of literal similarity within this framework would require including a negative dependency on the number of nonshared features as well as the positive dependency on the number of shared features (Tversky, 1977). However, for our purposes, the key point is that, in analogy, a structural distinction must be made between different types of predicates. In Tversky's valuable characterization of literal similarity, the relation-attribute distinction is not utilized; all predicates are considered together, as "features". This suggests that

literal similarity (at least in the initial stages of study) does not require as elaborate a computational semantics as metaphor and analogy.

<sup>4</sup> The "objects" in terms of which a person conceptualizes a system need not be concrete tangible objects; they may be simply relatively coherent, separable component parts of a complex object, or they may be idealized or even fictional objects. Moreover, often a target system can be parsed in various ways by different individuals, or even by the same individual for different purposes. [See Greeno, Vesonder, and Majetic (1982) and Larkin (1982).] The important point is, once the objects are determined they will be treated as objects in the mapping.

<sup>5</sup> Mathematical models represent an extreme of systematicity. The set of mappable relations is strongly constrained, and the rules for concatenating relationships are well-specified. Once we choose a given mathematical system - say, a ring or a group - as base, we know thereby which combinatorial rules and which higher-order relations apply in the base. This clarifies the process of deriving new predictions to test in the target. We know, for example, that if the base relations are addition ( $R_1$ ) and multiplication ( $R_2$ ) in a field (e.g., the real numbers) then we can expect distributivity to hold:  $c(a+b) = ca + cb$ , or

$$R_2 [(c, R_1(a,b))] = R_1 [R_2(c,a), R_2(c,b)]$$

A mathematical model predicts a small number of relations which

are well-specified enough and systematic enough to be concatenated into long chains of prediction.

6

Notice that the analogy shown in Figure 2 actually involves two different systems of mappings that do not completely overlap. Each system is dominated by a different higher-order relation. Although the object mappings are the same in both cases, the attribute mappings are different. (Recall that object attributes, like objects themselves, can be mapped onto arbitrarily different elements of the target, according to the structure-mapping theory; only the resulting relations need be preserved.)

The first system is dominated by the attractive force relation

$$(F = G m_1 m_2 / R^2).$$

In this system, the mass of objects in the solar system is mapped onto the charge of objects in the atom, and gravitational force maps onto electromagnetic force. This system includes the higher-order relation that attractive force decreases with distance.

The other system is dominated by the inertial relation ( $F = ma$ ); in this system, the mass of objects in the solar system maps into the mass of objects in the atom. This system includes the inference (expressed as a higher-order relation in Figure 2) that the less massive object moves more than the more massive object.

7

In combinations of resistors, the key principle is that the voltage changes significantly only when current encounters a resistance. When the circuit contains two identical resistors in a row, the total voltage drop gets divided between the two resistors. Thus the voltage drop across each resistor is only half as great. Since the current is proportional to the voltage drop, the current through each resistor is only half the original current. By conservation of charge, this reduced current is constant throughout the system.

Navy	Navy
1 Dr. Ed Aiken Navy Personnel R&D Center San Diego, CA 92152	1 CAPT Richard L. Martin, USN Prospective Commanding Officer USS Carl Vinson (CVN-70) Newport News Shipbuilding and Drydock Co Newport News, VA 23607
1 Meryl S. Baker NPRDC Code P309 San Diego, CA 92152	1 Dr. James McBride Navy Personnel R&D Center San Diego, CA 92152
1 Dr. Robert Breau Code N-711 NAVTRAEQUIPCEN Orlando, FL 32810	1 Dr William Montague Navy Personnel R&D Center San Diego, CA 92152
1 CDR Mike Curran Office of Naval Research 800 N. Quincy St. Code 270 Arlington, VA 22217	1 Ted K. J. Yellen Technical Information Office, Code 201 NAVY PERSONNEL R&D CENTER SAN DIEGO, CA 92152
1 DE. PAT FEDERICO NAVY PERSONNEL R&D CENTER SAN DIEGO, CA 92152	1 Library, Code P301L Navy Personnel R&D Center San Diego, CA 92152
1 Dr. John Ford Navy Personnel R&D Center San Diego, CA 92152	1 Technical Director Navy Personnel R&D Center San Diego, CA 92152
1 LT Steven D. Harris, MSC, USN Code 6021 Naval Air Development Center Warminster, Pennsylvania 18974	6 Commanding Officer Naval Research Laboratory Code 2627 Washington, DC 20390
1 Dr. Jim Hollen Code 204 Navy Personnel R & D Center San Diego, CA 92152	1 Psychologist ONR Branch Office Bldg 114, Section D 666 Summer Street Boston, MA 02210
1 Dr. Norman J. Kerr Chief of Naval Technical Training Naval Air Station Memphis (75) Millington, TN 38054	1 Office of Naval Research Code 497 800 N. Quincy Street Arlington, VA 22217
1 Dr. William L. Mcloy Principal Civilian Advisor for Education and Training Naval Training Command, Code 00A Pensacola, FL 32502	5 Personnel & Training Research Programs (Code 450) Office of Naval Research Arlington, VA 22217

Copy available to DTIC does not  
permit fully legible reproduction



Navy

Navy

Psychologist  
 ONR Branch Office  
 1070 East Green Street  
 Pasadena, CA 91101

1 Dr. Alfred F. Snodgrass  
 Training Analysis & Evaluation Group  
 (TAEG)  
 Dept. of the Navy  
 Orlando, FL 32812

1 Special Asst. for Education and  
 Training (OP-01E)  
 Rm. 2705 Arlington Annex  
 Washington, DC 20370

1 Dr. Richard Sorenson  
 Navy Personnel R&D Center  
 San Diego, CA 92152

Office of the Chief of Naval Operations  
 Research Development & Studies Branch  
 (OP-115)  
 Washington, DC 20350

1 Roger Weissinger-Poyton  
 Department of Administrative Sciences  
 Naval Postgraduate School  
 Monterey, CA 93940

1 LT Frank C. Patho, MSC, USN (Ph.D)  
 Selection and Training Research Division  
 Human Performance Sciences Dept.  
 Naval Aerospace Medical Research Laboratory  
 Pensacola, FL 32502

1 Dr. Robert Wisher  
 Code 200  
 Navy Personnel R&D Center  
 San Diego, CA 92152

1 Dr. Gary Poock  
 Operations Research Department  
 Code 55PK  
 Naval Postgraduate School  
 Monterey, CA 93940

1 Mr. John H. Wolfe  
 Code PC10  
 U. S. Navy Personnel Research and  
 Development Center  
 San Diego, CA 92152

1 Roger W. Remington, Ph.D  
 Code LEP  
 NAMPL  
 Pensacola, FL 32502

1 Dr. Bernard Rimland (OSP)  
 Navy Personnel R&D Center  
 San Diego, CA 92152

1 Dr. Worth Scanland, Director  
 Research, Development, Test & Evaluation  
 M-5  
 Naval Education and Training Command  
 NAS, Pensacola, FL 32502

1 Dr. Robert G. Smith  
 Office of Chief of Naval Operations  
 OP-027H  
 Washington, DC 20350

Copy available to DTIC does not  
 permit fully legible reproduction

## Army

- 1 Technical Director  
U. S. Army Research Institute for the  
Behavioral and Social Sciences  
5001 Eisenhower Avenue  
Alexandria, VA 22304
- 1 Mr. James Baker  
Systems Manning Technical Area  
Army Research Institute  
5001 Eisenhower Ave.  
Alexandria, VA 22304
- 1 Dr. Beatrice J. Fann  
U. S. Army Research Institute  
5001 Eisenhower Avenue  
Alexandria, VA 22304
- 1 DR. FRANK J. HARRIS  
U.S. ARMY RESEARCH INSTITUTE  
5001 EISENHOWER AVENUE  
ALEXANDRIA, VA 22304
- 1 Dr. Michael Kaplan  
U.S. ARMY RESEARCH INSTITUTE  
5001 EISENHOWER AVENUE  
ALEXANDRIA, VA 22304
- 1 Dr. Milton S. Katz  
Training Technical Area  
U.S. Army Research Institute  
5001 Eisenhower Avenue  
Alexandria, VA 22304
- 1 Dr. Harold F. O'Neil, Jr.  
Attn: PERI-OK  
Army Research Institute  
5001 Eisenhower Avenue  
Alexandria, VA 22304
- 1 Dr. Robert Sasmor  
U. S. Army Research Institute for the  
Behavioral and Social Sciences  
5001 Eisenhower Avenue  
Alexandria, VA 22304

## Army

- 1 Dr. Frederick Steinheiser  
Dept. of Navy  
Chief of Naval Operations  
OP-112  
Washington, DC 20350
- 1 Dr. Joseph Ward  
U.S. Army Research Institute  
5001 Eisenhower Avenue  
Alexandria, VA 22304

Copy available to DTIC does not  
permit fully legible reproduction

Air Force

Marines

U.S. Air Force Office of Scientific  
Research  
Life Sciences Directorate, ML  
Bolling Air Force Base  
Washington, DC 20332

1 H. William Greenup  
Education Advisor (EO31)  
Education Center, MCDEC  
Quantico, VA 22134

1 Dr. Genevieve Haddad  
Program Manager  
Life Sciences Directorate  
AFOSR  
Bolling AFB, DC 20332

1 Special Assistant for Marine  
Corps Matters  
Code 1001  
Office of Naval Research  
800 N. Quincy St.  
Arlington, VA 22217

2 2700 TCHTW/TTGH Stop 22  
Sheppard AFB, TX 76211

1 DR. A.L. SLAFKOSKY  
SCIENTIFIC ADVISOR (CODE RD-1)  
HQ, U.S. MARINE CORPS  
WASHINGTON, DC 20380

Copy available to DTIC does not  
permit fully legible reproduction

Coast Guard

- 1 Chief, Psychological Research Branch  
U. S. Coast Guard (G-P-1/2/TP42)  
Washington, DC 20592

Other DoD

- 12 Defense Technical Information Center  
Cameron Station, Bldg 5  
Alexandria, VA 22314  
Attn: TC
- 1 Military Assistant for Training and  
Personnel Technology  
Office of the Under Secretary of Defense  
for Research & Engineering  
Room 3D129, The Pentagon  
Washington, DC 20301
- 1 DAFPA  
1400 Wilson Blvd.  
Arlington, VA 22209

Copy available to DTIC does not  
permit fully legible reproduction

Civil Govt

Non Govt

Dr. Susan Chipman  
 Learning and Development  
 National Institute of Education  
 1200 19th Street NW  
 Washington, DC 20208

Dr. John Mays  
 National Institute of Education  
 1200 19th Street NW  
 Washington, DC 20208

William J. McLaurin  
 65010 Howie Court  
 Camp Springs, MD 20746

Dr. Arthur Melmed  
 National Institute of Education  
 1200 19th Street NW  
 Washington, DC 20208

Dr. Andrew R. Molnar  
 Science Education Dev.  
 and Research  
 National Science Foundation  
 Washington, DC 20550

Dr. Joseph Psotka  
 National Institute of Education  
 1200 19th St. NW  
 Washington, DC 20208

Dr. Frank Withrow  
 U. S. Office of Education  
 400 Maryland Ave. SW  
 Washington, DC 20202

Dr. Joseph L. Young, Director  
 Memory & Cognitive Processes  
 National Science Foundation  
 Washington, DC 20550

1 Dr. John E. Anderson  
 Department of Psychology  
 Carnegie Mellon University  
 Pittsburgh, PA 15213

1 Anderson, Thomas W., Ph.D.  
 Center for the Study of Reading  
 174 Children's Research Center  
 51 Gerty Drive  
 Champaign, IL 61820

1 Dr. John Annett  
 Department of Psychology  
 University of Warwick  
 Coventry CV4 7AL  
 ENGLAND

1 1 psychological research unit  
 Dept. of Defense (Army Office)  
 Campbell Park Offices  
 Canberra ACT 2600, Australia

1 Dr. Alan Piddoley  
 Medical Research Council  
 Applied Psychology Unit  
 15 Chaucer Road  
 Cambridge CB2 2EF  
 ENGLAND

1 Dr. Patricia Paggott  
 Department of Psychology  
 University of Colorado  
 Boulder, CO 80309

1 Mr Avron Farr  
 Department of Computer Science  
 Stanford University  
 Stanford, CA 94305

1 Liaison Scientists  
 Office of Naval Research,  
 Branch Office, London  
 Box 29 FPO New York 09510

1 Dr. Lyle Rounse  
 Department of Psychology  
 University of Colorado  
 Boulder, CO 80309

Copy available to DTIC does not  
 permit fully legible reproduction

Non Govt

- 1 Dr. John S. Brown  
XEROX Palo Alto Research Center  
3203 Coyote Road  
Palo Alto, CA 94304
- 1 Dr. Bruce Puchanan  
Department of Computer Science  
Stanford University  
Stanford, CA 94305
- 1 DR. C. VICTOR BUNDERSON  
WICAT INC.  
UNIVERSITY PLAZA, SUITE 10  
1166 SO. STATE ST.  
OREM, UT 84057
- 1 Dr. Pat Carpenter  
Department of Psychology  
Carnegie-Mellon University  
Pittsburgh, PA 15213
- 1 Dr. John B. Carroll  
Psychometric Lab  
Univ. of No. Carolina  
Davis Hall 012A  
Chapel Hill, NC 27514
- 1 Dr. William Chase  
Department of Psychology  
Carnegie Mellon University  
Pittsburgh, PA 15213
- 1 Dr. Micheline Chi  
Learning R & D Center  
University of Pittsburgh  
2932 O'Hara Street  
Pittsburgh, PA 15213
- 1 Dr. Allan M. Collins  
Rolt Beranek & Newman, Inc.  
50 Moulton Street  
Cambridge, Ma 02138
- 1 Dr. Lynn A. Cooper  
LRPC  
University of Pittsburgh  
2932 O'Hara Street  
Pittsburgh, PA 15213

Non Govt

- 1 Dr. Meredith P. Crawford  
American Psychological Association  
1200 17th Street, N.W.  
Washington, DC 20036
- 1 Dr. Kenneth P. Cross  
Anodaps Sciences, Inc.  
P.O. Drawer C  
Santa Barbara, CA 93102
- 1 COL J. C. Eggenberger  
DIRECTORATE OF PERSONNEL APPLIED RESEARCH  
NATIONAL DEFENCE HQ  
101 COLONEL BY DRIVE  
OTTAWA, CANADA K1A 0K2
- 1 Dr. Ed Feigenbaum  
Department of Computer Science  
Stanford University  
Stanford, CA 94305
- 1 Dr. Richard L. Ferguson  
The American College Testing Program  
P.O. Box 168  
Iowa City, IA 52240
- 1 Mr. Wallace Feurzeig  
Rolt Beranek & Newman, Inc.  
50 Moulton St.  
Cambridge, MA 02138
- 1 Dr. Victor Fields  
Dept. of Psychology  
Montgomery College  
Rockville, MD 20850
- 1 Univ. Prof. Dr. Gerhard Fischer  
Liebiggasse 5/2  
A 1010 Vienna  
AUSTRIA
- 1 DR. JOHN D. FOLLEY JR.  
APPLIED SCIENCES ASSOCIATES INC  
VALENTIA, PA 16050
- 1 Dr. John P. Frederiksen  
Rolt Beranek & Newman  
50 Moulton Street  
Cambridge, MA 02138

Copy available to DTIC does not  
permit fully legible reproduction



## Non Govt.

- 1 Dr. Marcy Lensman  
Department of Psychology, NT 25  
University of Washington  
Seattle, WA 98195
- 1 Dr. Jill Larkin  
Department of Psychology  
Carnegie Mellon University  
Pittsburgh, PA 15213
- 1 Dr. Alan Lesgold  
Learning R&D Center  
University of Pittsburgh  
Pittsburgh, PA 15260
- 1 Dr. Michael Levine  
Department of Educational Psychology  
210 Education Bldg.  
University of Illinois  
Champaign, IL 61801
- 1 Dr. Robert Linn  
College of Education  
University of Illinois  
Urbana, IL 61801
- 1 Dr. Erik McWilliams  
Science Education Dev. and Research  
National Science Foundation  
Washington, DC 20550
- 1 Dr. Hank Miller  
TX Computer Science Lab  
C/O 2824 Winterplace Circle  
Plano, TX 75075
- 1 Dr. Allen Munro  
Behavioral Technology Laboratories  
1825 Elena Ave., Fourth Floor  
Redondo Beach, CA 90277
- 1 Dr. Donald A Norman  
Dept. of Psychology C-009  
Univ. of California, San Diego  
La Jolla, CA 92092

## Non Govt

- 1 Committed on Human Factors  
JH 211  
2101 Constitution Ave. NW  
Washington, DC 20418
- 1 Dr. Jesse Orlansky  
Institute for Defense Analysis  
400 Army Navy Drive  
Arlington, VA 22202
- 1 Dr. Seymour A. Papert  
Massachusetts Institute of Technology  
Artificial Intelligence Lab  
545 Technology Square  
Cambridge, MA 02139
- 1 Dr. James A. Poulson  
Portland State University  
P.O. Box 751  
Portland, OR 97207
- 1 Dr. James W. Pellegrino  
University of California,  
Santa Barbara  
Dept. of Psychology  
Santa Barbara, CA 93106
- 1 MR. LUIGI PETRULLO  
2431 N. EDGEWOOD STREET  
ARLINGTON, VA 22207
- 1 Dr. Martha Polson  
Department of Psychology  
Campus Box 346  
University of Colorado  
Boulder, CO 80309
- 1 DR. PETER POLSON  
DEPT. OF PSYCHOLOGY  
UNIVERSITY OF COLORADO  
BOULDER, CO 80309
- 1 Dr. Steven E. Poltrock  
Department of Psychology  
University of Denver  
Denver, CO 80202

Copy available to DTIC does not  
permit fully legible reproduction



Non Govt.

MINRAT M. L. PAUCH  
P. II #  
BUNDESMINISTERIUM DER VERTEIDIGUNG  
POSTFACH 1328  
D-57 BONN 1, GERMANY

Dr. Fred Reif  
SFSAME  
c/o Physics Department  
University of California  
Berkeley, CA 94720

Dr. Lauren Resnick  
LPDC  
University of Pittsburgh  
3030 O'Hara Street  
Pittsburgh, PA 15210

Mary Filey  
LFDC  
University of Pittsburgh  
3030 O'Hara Street  
Pittsburgh, PA 15210

Dr. Andrew M. Rose  
American Institutes for Research  
1055 Thomas Jefferson St. NE  
Washington, DC 20007

Dr. Ernst Z. Rothkopf  
Bell Laboratories  
600 Mountain Avenue  
Murray Hill, NJ 07974

Dr. David Rumelhart  
Center for Human Information Processing  
Univ. of California, San Diego  
La Jolla, CA 92093

DR. WALTER SCHNEIDER  
DEPT. OF PSYCHOLOGY  
UNIVERSITY OF ILLINOIS  
CHAMPAIGN, IL 61820

Dr. Alan Schoenfeld  
Department of Mathematics  
Hamilton College  
Clinton, NY 13323

Non Govt.

1 DR. ROBERT J. SEIDEL  
INSTRUCTIONAL TECHNOLOGY GROUP  
HUMRRC  
200 N. WASHINGTON ST.  
ALEXANDRIA, VA 22304

1 Committee on Cognitive Research  
of Dr. Lonnie E. Sherrod  
Social Science Research Council  
605 Third Avenue  
New York, NY 10016

1 Robert S. Siegler  
Associate Professor  
Carnegie-Mellon University  
Department of Psychology  
Schenley Park  
Pittsburgh, PA 15213

1 Dr. Edward F. Smith  
Bolt Beranek & Newman, Inc.  
50 Moulton Street  
Cambridge, MA 02139

1 Dr. Robert Smith  
Department of Computer Science  
Rutgers University  
New Brunswick, NJ 08903

1 Dr. Richard Snow  
School of Education  
Stanford University  
Stanford, CA 94305

1 Dr. Robert Sternberg  
Dept. of Psychology  
Yale University  
Box 117, Yale Station  
New Haven, CT 06520

1 DR. ALBERT STEVENS  
BOLT BERANEK & NEWMAN, INC.  
50 MOULTON STREET  
CAMBRIDGE, MA 02139

1 David E. Stone, Ph.D.  
Hazelting Corporation  
7600 Old Springhouse Road  
McLean, VA 22102

Copy available to DDC does not  
permit fully legible reproduction

Non Govt

Non Govt

1 DR. PATRICK SUPPES  
 INSTITUTE FOR MATHEMATICAL STUDIES IN  
 THE SOCIAL SCIENCES  
 STANFORD UNIVERSITY  
 STANFORD, CA 94305

1 Dr. Keith T. Mescourt  
 Information Sciences Dept.  
 The Rand Corporation  
 1700 Main St.  
 Santa Monica, CA 90406

1 Dr. Kikumi Tatsuoka  
 Computer Based Education Research  
 Laboratory  
 252 Engineering Research Laboratory  
 University of Illinois  
 Urbana, IL 61801

1 Dr. John Thomas  
 IBM Thomas J. Watson Research Center  
 P.O. Box 218  
 Yorktown Heights, NY 10598

1 DR. PERRY THORNDYKE  
 THE RAND CORPORATION  
 1700 MAIN STREET  
 SANTA MONICA, CA 90406

1 Dr. Douglas Towne  
 Univ. of So. California  
 Behavioral Technology Labs  
 1645 S. Elena Ave.  
 Redondo Beach, CA 90278

1 Dr. J. Uhlander  
 Perceptronics, Inc.  
 6271 Variel Avenue  
 Woodland Hills, CA 91364

1 Dr. Denton J. Underwood  
 Dept. of Psychology  
 Northwestern University  
 Evanston, IL 60201

1 Dr. David J. Weiss  
 #660 Elliott Hall  
 University of Minnesota  
 75 E. River Road  
 Minneapolis, MN 55455

1 DR. GERSHON WELTMAN  
 PERCEPTONICS INC.  
 6271 VARIEL AVE.  
 WOODLAND HILLS, CA 91367

Copy avail to DDC does not  
 permit fully legible reproduction

DATE  
FILMED  
7-8