



CHALMERS
UNIVERSITY OF TECHNOLOGY

Forecasting of Spare Parts Based on Vehicle Condition Monitoring Data

A Case Study at Volvo Group

Master's Thesis in the Supply Chain Management Master's Programme

ANTON OTTOSSON

OLOF WIREKLINT

Department of Technology Management and Economics
Division of Supply and Operations Management
CHALMERS UNIVERSITY OF TECHNOLOGY
Gothenburg, Sweden 2018
Report No. E 2018:010

MASTER'S THESIS 2018:010

Forecasting of Spare Parts Based on Vehicle Condition Monitoring Data

A Case Study at Volvo Group

ANTON OTTOSSON

OLOF WIREKLINT



CHALMERS
UNIVERSITY OF TECHNOLOGY

Department of Technology Management and Economics
Division of Supply and Operations Management
CHALMERS UNIVERSITY OF TECHNOLOGY
Gothenburg, Sweden 2018

Forecasting of Spare Parts Based on Vehicle Condition Monitoring Data
A Case Study at Volvo Group
ANTON OTTOSSON
OLOF WIREKLINT

© ANTON OTTOSSON, OLOF WIREKLINT, 2018.

Examiner, Chalmers: Patrik Jonsson
Tutor, Chalmers: Joakim Andersson
Tutors, Volvo Group: Max Engvall & Josef Larsson

Master's Thesis 2018:010
Department of Technology Management and Economics
Division of Supply and Operations Management
Chalmers University of Technology
SE-412 96 Gothenburg
Telephone +46 31 772 1000

Printed by Chalmers Reproservice
Gothenburg, Sweden 2018

Forecasting of Spare Parts Based on Vehicle Condition Monitoring Data
A Case Study at Volvo Group
ANTON OTTOSSON
OLOF WIREKLINT
Department of Technology Management and Economics
Chalmers University of Technology

Abstract

An accurate aftermarket demand forecast is critical for companies within the automotive industry. However, due to erratic and intermittent demand patterns of spare parts, achieving an accurate demand forecast through currently used time-based methods is difficult. Therefore, this thesis aims to predict future demand with causal-based forecasting methods using condition monitoring data, specifically fault codes, as explanatory variable. Furthermore, an evaluation is made on what effects an implementation would result in for the case company Volvo Group.

The thesis method combines qualitative as well as quantitative data collection and analysis. Findings from the qualitative part of the study are a list of fault codes as well as a list of part types where a forecast based on condition monitoring data could be appropriate. To maximize potential economic benefits of an improved forecast the initial list of part types was subsequently filtered, which results in the part types: turbos and batteries. Those results were then validated through quantitative analysis using correlation and regression to determine causality between fault codes and spare part demand for three individual turbochargers. The causal relationships were used to create causal-based forecasts on different time horizons. These causal-based models were then compared with currently used time-based models, which show an overall better performance of the causal-based models.

Based on the research findings it is discussed that the developed causal-based forecasting method is appropriate for parts with a positive demand trend. Furthermore, it is argued that the developed model is unable to accurately detect single period fluctuations since they are caused by customer behavior which can not be explained by fault codes. The thesis contributions include an analysis approach which can be used in future research, and recommendations for future actions within the case company to further develop the research findings.

Keywords: forecasting, spare part logistics, condition monitoring data, fault codes, correlation analysis, regression analysis.

Acknowledgements

This master's thesis was conducted during the spring of 2018 at Chalmers University of Technology as a part of the M.Sc. program Supply Chain Management. The thesis is a collaboration with Volvo Service Market Logistics, where the case study was conducted.

We would like to thank our tutors at Volvo, Max Engvall & Josef Larsson, who have been immensely helpful throughout the entire project. Their commitment and resourcefulness has contributed significantly to the thesis work. We would also like to thank the involved people at Volvo Group for their time, interest and encouragement throughout the spring.

A special thanks is directed to our exceptional tutor, Joakim Andersson as well as our exceptional examiner, Patrik Jonsson, at Chalmers, whose dedication, inputs and guidance have been of utmost importance to the thesis work. Lastly, we thank our friends and family for their constant support in all of our endeavors.

Anton Ottosson & Olof Wireklint
Gothenburg, June 2018

Abbreviations

CBM	Condition-Based Maintenance
CDC	Central Distribution Center
CM	Corrective Maintenance
DIM	Dealer Inventory Management
DIP	Demand and Inventory Planning
DTC	Diagnostic Trouble Code
EOQ	Economic Order Quantity
FCQ	Forecast Quality
FGI	Function Group Index
FOIP	Flow Optimization and Inventory Planning
GTO	Group Trucks Operations
GTP	Group Trucks Purchasing
GTT	Group Trucks Technology
KPI	Key Performance Indicator
LPA	Logistic Partner Agreement
MAPE	Mean Absolute Percentage Error
PM	Preventive Maintenance
RDC	Regional Distribution Center
RQ	Research Question
SDC	Support Distribution Center
SML	Service Market Logistics
Volvo	Volvo Group
VOR	Vehicle Off Road

Contents

List of Figures	xiii
List of Tables	xv
1 Introduction	1
1.1 Theoretical Background	1
1.2 Company Background	2
1.3 Purpose	3
1.4 Scope	3
2 Method	5
2.1 Literature Review and Theoretical Framework	6
2.2 Phase 1: Qualitative Data Collection	6
2.2.1 Primary Data Collection in Phase 1	7
2.2.2 Secondary Data Collection in Phase 1	8
2.3 Phase 2: Quantitative Data Collection and Analysis of Data	9
2.4 Phase 3: Prediction and Comparison to Current Forecast	11
2.5 Validity and Reliability	13
3 Literature Review and Theoretical Framework	15
3.1 Forecasting of Spare Parts	15
3.2 Maintenance	17
3.3 Classification of Spare Parts	19
3.4 Condition Monitoring and CBM Process	20
3.4.1 Extraction of Signal Data	21
3.4.2 Correlation Between Sensor Data and Failure	23
3.4.3 Prediction of Component Breakdowns	23
3.4.4 Scheduling of Maintenance Operations	24
3.5 Correlation Analysis	24
3.6 Regression Analysis	25
3.7 Conceptual Framework	27
4 Case Description	29
4.1 Volvo Group Organization	29
4.2 Volvo Service Market Logistics	30
4.2.1 Volvo's Service Market Supply Chain	31

4.2.2	Responsibilities Within the Supply Chain	32
4.3	Forecasting Process	35
4.3.1	Forecast Quality and Other KPIs	38
4.4	Fault Codes at Volvo	38
5	Result & Analysis	41
5.1	Identified Fault Codes and Part Types	41
5.1.1	Fault Codes	41
5.1.2	Part Types	42
5.2	Selected Parts	43
5.3	Finding Associations Through Correlation Analysis	44
5.4	Forecast Through Regression Analysis	45
5.4.1	Analysis on Part Type Level	45
5.4.2	Analysis on Part Number Level	50
5.5	Comparison with Current Forecast	52
6	Discussion	57
6.1	Forecasting and Maintenance	57
6.2	Links Between Measurements	59
6.3	Implications of Findings	59
6.3.1	Implications on Forecasting Process Activities	60
6.3.2	Implications on Availability and Stock	62
6.3.3	Implications on Supply Chain Interactions	64
6.4	Underlying Assumptions	65
6.5	Limitations	66
7	Conclusion	69
7.1	Research Findings	69
7.2	Practical and Theoretical Contribution	70
7.3	Recommendations and Future Research for the Case Company	70
7.4	Future Research within Academia	72
	Bibliography	75
A	Appendix: Interview Questions	I
A.1	Interview Template	I
A.2	Interview Questions for Dealer Visit	III
B	Appendix: Safety Stock and Service Level Equations	V
C	Appendix: Resulting Changes in Safety Stock and Service Level	VII

List of Figures

2.1	Illustration of the thesis' method containing the literature review and the three method-phases, as well as their connections.	5
2.2	Illustration of the logic used when identifying part numbers for the analysis.	9
2.3	Illustration of the filtration of parts with potential impact.	10
2.4	Simplified illustration of how the correlation test and time translation is performed.	11
3.1	Classification of maintenance activities used in the thesis. Based on Schmidt and Wang (2016).	19
3.2	Illustration of an adapted CBM process based on Wang (2008) & Vachtsevanos and Wang (2001).	21
3.3	Conceptual framework over how theory contributes to answering the thesis' research questions.	27
4.1	Organizational chart of Volvo Group.	30
4.2	Simplified organizational chart of Volvo GTO.	30
4.3	Volvo's service market supply chain.	31
4.4	Simplified illustration of responsibilities within the spare part supply chain.	33
4.5	Illustration of the segmentation of spare parts.	34
4.6	Process chart for capture of demand and forecasting processes at Volvo Group.	36
5.1	Graph over total reports per period in Europe for studied fault codes.	42
5.2	Illustration of the relationship between time between service, assumed occurrence of fault codes and dealer demand.	45
5.3	Regression analysis between D1A9Z and total turbo demand from 2015/08 to 2018/03 with two months time horizon.	46
5.4	Regression analysis between D1AD9 and total battery demand from 2015/08 to 2018/03 with two months time horizon.	47
5.5	Regression analysis between D1CXH and total battery demand from 2015/08 to 2018/03 with two months time horizon.	48
5.6	Regression analysis between D1CVH and total battery demand from 2015/08 to 2018/03 with two months time horizon.	48

5.7	Regression analysis between D1B4H and total battery demand from 2015/08 to 2018/03 with two months time horizon.	49
5.8	Regression analysis between D1A98 and total battery demand from 2015/08 to 2018/03 with two months time horizon.	49
5.9	Comparison between forecast based on fault code D1BSQ five months ahead of time, the system generated forecast five months ahead of time and actual demand of the turbo part 85013511.	54
5.10	Comparison between forecast based on fault codes D1A9Z and D1ARK two months ahead of time, the system generated forecast two months ahead of time and actual demand of the turbo part 85020372.	55
5.11	Comparison between forecast based on fault codes D1A9Z & D1A98 two months ahead of time, the system generated forecast two months ahead of time and actual demand of the turbo part 85013758.	56
6.1	Illustration of how the forecast process at Volvo could change, for selected parts, in the short term with an implementation of forecasting based on fault code occurrence.	60
6.2	Illustration of how the forecast process at Volvo could change to in the long term with an implementation of forecasting based on fault code occurrence. Changes to the current process are highlighted within the green boxes.	62
6.3	Simplified illustration of the demand information flow within the spare part supply chain before and after implementation.	65
7.1	Illustration of recommended future actions for the case company based on the thesis findings.	72

List of Tables

2.1	Summary of semi-structured interviews performed throughout the thesis.	8
3.1	Comparison of different literature views on methods included in PM.	18
3.2	Example of implementations of common sensors and monitoring techniques.	22
3.3	Correlation classification in absolute terms based on Mason et al. (1983).	24
4.1	KPIs used by FOIP.	38
5.1	List of identified and initially selected part types.	42
5.2	Filtration of articles.	43
5.3	Example of correlation results with mockup data.	44
5.4	Results of conducted regression analyses on individual turbos.	51
5.5	Conversion coefficients for evaluated parts.	53
5.6	Comparison of Mean Absolute Percentage Error (MAPE) between regression forecast and system forecast.	53
6.1	Forecast horizon and lead time for evaluated parts. The lead time includes a two week transportation time from CDC to dealer.	62
6.2	Resulting changes in service level when using the causal-based forecasts compared to the time-based, and keeping the current safety stock.	63
6.3	Resulting changes in required safety stock when using the causal-based forecasts compared to the time-based, and keeping the current desired service level.	64
B.1	Conversion table between service function and service constant.	VI
C.1	Resulting changes in service level with a smoothing constant of 0.2 when using the causal-based forecasts compared to the time-based, and keeping the current safety stock.	VII
C.2	Resulting changes in required safety stock with a smoothing constant of 0.2 when using the causal-based forecasts compared to the time-based, and keeping the current desired service level.	VII

C.3	Resulting changes in service level with a smoothing constant of 0.1 when using the causal-based forecasts compared to the time-based, and keeping the current safety stock.	VIII
C.4	Resulting changes in required safety stock with a smoothing constant of 0.1 when using the causal-based forecasts compared to the time-based, and keeping the current desired service level.	VIII
C.5	Resulting changes in service level with a smoothing constant of 0.05 when using the causal-based forecasts compared to the time-based, and keeping the current safety stock.	VIII
C.6	Resulting changes in required safety stock with a smoothing constant of 0.05 when using the causal-based forecasts compared to the time-based, and keeping the current desired service level.	VIII

1

Introduction

In this chapter, the theoretical background of the thesis and the background of Volvo Group Service Market Logistics (SML) is presented. Two different background sections, one theoretical background and one company background, provides a problematization of the topic investigated within this thesis. Following is the thesis' purpose, research questions and scope.

1.1 Theoretical Background

In most manufacturing industries, including the automotive industry, after-sales services are a significant source of revenue, profit and competitive advantage (Gaiardelli et al., 2007). According to Dombrowski and Engel (2013), long-lasting relationships are supported by customer satisfaction, which is increased by having effective value adding services in the vehicle aftermarket. Dombrowski and Engel (2013) further mean that the foundation of these value-adding services is the distribution of spare parts. Distribution of spare parts involves inventory holding which affects inventory carrying cost, total order cost as well as shortage cost (Dobrican, 2013). Equipment which the parts are used for can quickly change, production-, design- and demand-wise, which creates a high risk of obsolescence for spare parts (Cobbaert and Van Oudheusden, 1996). Moreover, it is challenging to achieve a balance between reducing obsolescence, inventory holding and shortage costs while offering competitive service to customers (Dekker et al., 2013). The supply chain network and planning of spare parts is therefore important to an automotive company since it affects revenue, customer satisfaction and costs.

One of the most important aspects of inventory management is an accurate demand forecast (Vasumathi and Saradha, 2014). Furthermore, Vasumathi and Saradha (2014) also state that the specific characteristics of spare parts make achieving an accurate demand forecast difficult. These spare parts characteristics are, among others, that the demand often is sporadic and service requirements are high due to large costs of stock-outs (Huiskonen, 2001). Spare part control activities are made more complex due to the large number of stock keeping units and highly varying demands, from thousands of units per month to a few units per year (Rego and Mesquita, 2015).

Historically, forecast of spare parts has mainly been based on historical demand (Saccani and Bacchetti, 2012). However, Syntetos and Boylan (2010) state that forecasts based on historical demand are not appropriate for items with intermittent demand. A way to manage this shortcoming is to use causal-based methods, such as Condition-Based Maintenance (CBM) (Boylan and Syntetos, 2008). CBM is a maintenance program that predicts future requirements of maintenance, and thereby also future requirement of spare parts, by monitoring and evaluating the operating condition of the equipment (Ahmad and Kamaruddin, 2012). A core part of CBM is condition monitoring (Randall, 2011). Condition monitoring means that the operating condition of equipment is monitored by the usage of sensors or other types of indicators, such as fault codes (Campos, 2009). Fault codes are messages that are sent when sensors detect abnormal events or when sensors indicate values deviating from normal operation (Baptista et al., 2017). Using sensor data gathered through condition monitoring has significant potential, especially if consideration is taken to Bloch and Geitner (1983), who claim that most equipment failures are preceded by certain signs and conditions. In the thesis, sensor data and condition monitoring data are seen as equivalent.

1.2 Company Background

Volvo Group SML, which is where the thesis was performed, has the scope of globally managing, developing and optimizing the service market supply chain for all Volvo Group (Volvo) brands with the aim to secure customer up-time. At Volvo SML, the forecast of spare parts is primarily calculated by a system and mainly based on historical demand data.

For parts within the mature part of their life cycle, Volvo has seen that demand is relatively stable and therefore a forecast based on historical data performs well. However, for parts in early or late phases (when demand is continuously changing over time) the historical-based forecast does not perform as well. The same applies for parts with seasonal patterns or quality issues affecting demand. This indicates that there is a potential to improve forecasting performance at Volvo by using other forecasting methods. This logic is in line with the findings of Syntetos and Boylan (2010), i.e. that forecasting based on historical demand data is not appropriate for parts with intermittent demand.

Moreover, Volvo are currently equipping their vehicles with more advanced as well as a larger quantity of sensors which are able to record fault codes through monitoring and detecting abnormalities in the condition of their vehicles. This in combination with an increasing size of the fleet of connected vehicles (in 2017 the fleet size reached around 1.5 million) gives Volvo accessibility to a vast amount of information about the condition of their vehicles. However, this information is currently not utilized to its full capacity. Volvo Trucks have started several projects with the intent to improve their service offerings to customers. Furthermore, representatives at Volvo believe that there exists potential of improving decision making within

aftermarket forecasting on a Central Distribution Center (CDC) level if further research is conducted in the condition monitoring data area.

1.3 Purpose

The purpose of the thesis is to evaluate the potential of using condition monitoring data for spare parts at Volvo Group Trucks Operations (GTO) to improve accuracy of demand forecast on a CDC level and to evaluate the impact an implementation would result in.

To reach the purpose of the thesis work, the following *research questions* were formulated:

1. For which spare parts at Volvo Trucks is there a potential to predict future spare part demand by usage of fault codes?
2. How would usage of condition monitoring data for selected parts affect their forecast accuracy and forecast process?

The first research question aims to explore for which spare part types at Volvo Trucks there might be a correlation between fault codes and spare part demand, and potential economic benefits of improving forecast accuracy are large. This question is examined and addressed in Chapter 5. Research question two primarily aims to explore the impact of using condition monitoring data on forecast accuracy. Exploration of this involves a comparison between accuracy of currently used forecasting models and the proposed condition monitoring data model for selected parts, and is addressed in Chapters 5 and 6. Research question two secondarily aims to examine potential effects on the forecast process at Volvo Trucks. This is addressed in Chapter 6 by discussing implications of an implementation.

1.4 Scope

In order to fulfill the purpose of the thesis, a limitation through focusing on a certain scope was made. Spare parts in the Volvo Trucks brand service market in Europe are considered within the scope, as condition monitoring data is available for that area. An addition reason is that there are several projects working with usage of condition monitoring data for maintenance at Volvo Trucks within Europe, which indicates that it is a relevant area to explore, and that synergy effects can be achieved.

In order to facilitate the analysis, and due to time limits, a limited amount of spare parts and fault codes were considered. The evaluated spare parts were prioritized based on high potential of achieving benefits. Therefore, parts critical to business and with active demand were considered. Furthermore, the thesis focuses on parts and vehicles where condition monitoring data is available and of adequate quality. A majority of customers within the scope have a service contract, as they have a high availability of condition monitoring data.

2

Method

In this chapter, the method used to fulfill the thesis' purpose is described. Initially a graphical illustration of the project method is presented. Following the illustration, the literature review process, the three project phases, as well as reliability & validity concerns are described.

The project was split into three phases, with a literature review spanning across the entire project. Each phase corresponds to a Research Question (RQ). Phase 1 and 2 both correspond to RQ 1, with Phase 1 having a qualitative perspective, whereas Phase 2 has a quantitative perspective. A combination of qualitative and quantitative research creates a mixed research strategy where strengths from both perspectives can be drawn (Johnson and Onwuegbuzie, 2004). The project started with the first phase and moved continuously to the third phase, however it was during the project possible to revisit previous phases. In Figure 2.1, an illustration of the three phases, and what is included in each phase, is presented.

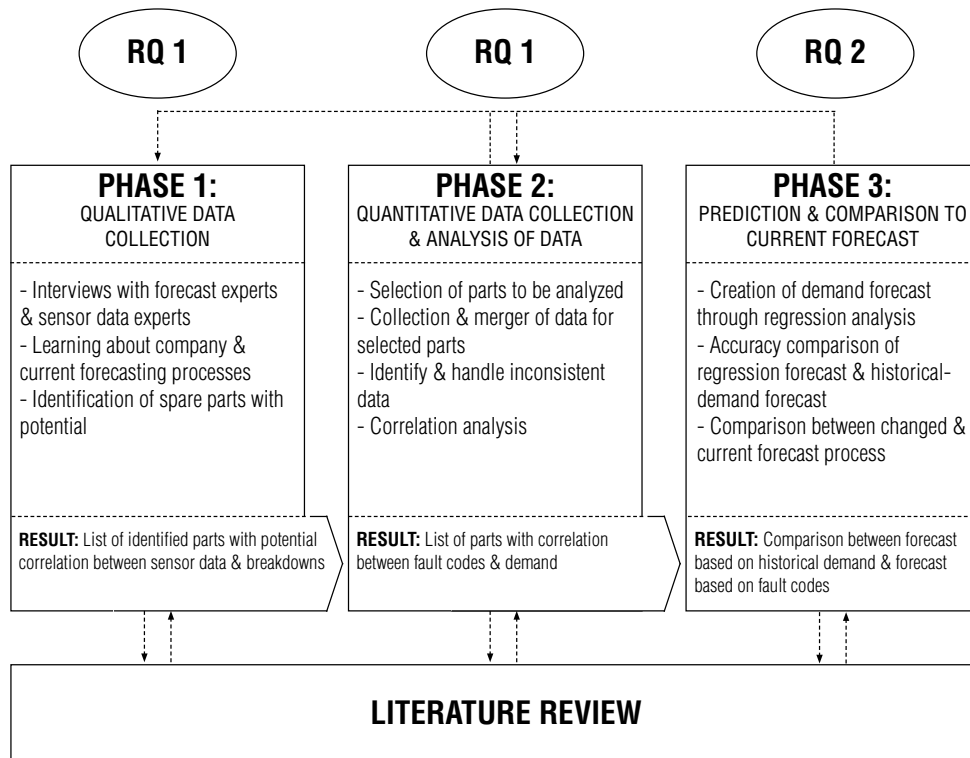

Figure 2.1: Illustration of the thesis' method containing the literature review and the three method-phases, as well as their connections.

2.1 Literature Review and Theoretical Framework

Every empirical study, quantitative, qualitative or mixed, must have a connection to literature (Rocco and Plakhotnik, 2009). Rocco and Plakhotnik (2009) explains that a theoretical framework is a presentation of a specific theory, and empirical work related to that theory. Green (2014) writes that the literature review and theoretical framework should complement the purpose and research questions. According to Rocco and Plakhotnik (2009), the literature review and theoretical framework has the function to:

1. Build a foundation through providing an overview of the literature base
2. Conceptualize the study by defining terms and describing hypothesis/propositions of previous studies
3. Provide a reference point for interpretation of findings

Based on the above, a theoretical framework was created to support the research questions, and thus aid the three phases with achieving the thesis' purpose. The relationship between literature review and theoretical framework is diffuse and difficult to define, however the theoretical framework is often embedded into the literature review (Green, 2014). Therefore, the framework was embedded in the literature review in this thesis. The theoretical framework is often shaped in the initial design phase of a study and then redefined as data collection and analysis takes place (Green, 2014). According to Bryman and Bell (2011), literature review conducted before data collection should be regarded as provisional. Since the phase including the data collection could be revisited throughout the entire project, the framework was redefined over time. The literature review therefore spanned from the beginning to the end of the project.

The literature review was conducted through searching in electronic databases, mainly Summon and Google scholar, and Chalmers Library for literature relevant to the thesis. Search phrases that were used in the databases include combinations of: *forecasting, spare parts, condition monitoring data, sensor data, fault codes, availability, condition based maintenance, regression analysis, correlation analysis, supply chain, inventory management*. Scientific journals, articles, e-books and physical books were all used in the literature review.

2.2 Phase 1: Qualitative Data Collection

The first phase of the study is of a qualitative nature. In this phase, both primary and secondary data was collected. Primary data is data which is collected by the researchers first hand, whereas secondary data is gathered from secondary sources, i.e. not directly compiled by the researchers (Rabianski, 2003). Primary data for this phase was gathered from interviews with actors working with Volvo's service market supply chain, see Table 2.1 further below for a summary of the conducted

semi-structured interviews. Information in the shape of secondary data was gathered through internal documents which were found within the organization's internal platforms and from explanatory presentations held by company employees. The result of Phase 1 is a list of identified parts with potential correlation between sensor data and breakdowns.

2.2.1 Primary Data Collection in Phase 1

Bryman and Bell (2011) argues that qualitative interviews tend to be flexible and responsive to the direction in which the interviewees steer the interview. As a result, the emphasis in the research can be adjusted in accordance to significant issues that emerge in the interviews (Bryman and Bell, 2011). Therefore, the conducted interviews were semi-structured or unstructured as that allows for a responsive steering based on results gathered during the interviews. Both unstructured and semi-structured interviews were held with different forecasting experts at Volvo SML from the Demand and Inventory Planning (DIP) and Dealer Inventory Management (DIM) teams. Interviews were also conducted with actors, from other parts of the organization, that have worked with and/or have extensive knowledge of the usage of sensor data.

Unstructured interviews, where only the subject was predetermined but not the questions, were used in order to clarify any concepts and/or questions that arose throughout the thesis. Unstructured interview could be conducted more quickly and did not require as much time to prepare as semi-structured interviews. Semi-structured interviews were used to learn about the organization and to gain an initial picture of where the forecast needs to be improved and in what possible ways it might be done using sensor data. In all of the semi-structured interviews, questions about which spare parts are deemed of high potential for usage of sensor data to predict breakdowns were asked. During the semi-structured interviews one of the authors was responsible for taking notes whereas the other was responsible for leading the interview, follow up on interesting points made, as well as prompting and probing when necessary. In order to capture all information from the answers, the semi-structured interviews were recorded. This enables, among other things, repeated as well as a more thorough examination of the interviewees answers (Bryman and Bell, 2011). During the thesis, the recordings were listened to whenever information from them needed clarification. After the project ended, all recordings were deleted to ensure personal integrity. In Table 2.1, a summary of the semi-structured interviews performed for the thesis is presented. The interview templates used in the semi-structured interviews are presented in Appendix A.

Table 2.1: Summary of semi-structured interviews performed throughout the thesis.

Title	Interview Topic	Date
Demand and Inventory Planner	Organization and Forecast	2018-02-08
Demand and Inventory Planner	Organization and Forecast	2018-02-13
Performance Manager	Sensor Data	2018-02-14
DIM Analyst	Organization and Forecast	2018-02-15
Demand and Inventory Planner	Organization and Forecast	2018-02-19
DIM, SRM & Supply Planner	Contracts and Sensor data	2018-02-22
PhD, Production Manager	Sensor data	2018-02-27
Data Scientist	Sensor data	2018-03-07
Service Manager & Spare Part Manager	Organization and Sensor data	2018-03-21

In the semi-structured interviews with forecasting experts, emphasis was put on understanding the currently used forecast processes as well as discovering which types of parts that could have large potential for improvement by changing the forecast. In semi-structured interviews with sensor data experts, the purpose was to discover parts where sensor data could potentially be used to predict breakdowns. During all semi-structured interviews, general questions were also asked to achieve an overall understanding of Volvo’s organization, supply chain and service market.

2.2.2 Secondary Data Collection in Phase 1

In Phase 1, secondary data containing information about the organization and where there is potential to find correlation between sensor data and breakdowns was collected. According to Emanuelson and Egenvall (2014), one main advantage of using secondary data is that it is generally more easy to obtain compared to primary data, thereby reducing time spent collecting data for a project. However, Emanuelson and Egenvall (2014) continues that it is difficult, or occasionally even impossible, to validate the initial collection of data. There is a high availability of information within Volvo’s internal platform. Due to the high availability, and the limited time frame of the project, the internal information was used. Information was also gathered through listening to presentations held internally at Volvo. For example, a presentation by a team working with predictive maintenance was attended, and related material about potential fault code data and parts was used to as a starting point for the analysis. Additionally, examples of information from internal documents that were used are descriptions of the case company service market supply chain, forecasting process and focused departments, as well as information regarding fault code descriptions. In order to handle the issue of validity described by Emanuelson and Egenvall (2014), the information was confirmed with a second source of data; either through unstructured interviews with employees or through reviewing other internal documents.

2.3 Phase 2: Quantitative Data Collection and Analysis of Data

In the second phase, the result of the data collection in the previous phase was used to guide further work. The result of Phase 2 is a list of parts with correlation between fault codes and demand. Correlation analysis is a way to determine the degree of association between two variables, and is explained in detail in Chapter 3. The quantitative data used in this phase is secondary data, meaning it was not gathered purposely for the researchers, but rather extracted from already existing databases.

Through the previous phase, it was identified that approximately 200 Diagnostic Trouble Codes (DTCs), otherwise called fault codes, have shown potential in other projects at Volvo when optimizing maintenance scheduling of certain parts. It was therefore decided to focus on fault codes in the remaining parts of the projects. A fault code is a type of sensor data directly related to certain sensors within the vehicles. If the related sensors indicate values above threshold values, a fault code will register for the specific vehicle. All fault codes have a text description, and keywords within it were found to identify what types of parts, for example batteries, could be connected to the identified codes. Volvo's Function Group Indexes (FGIs) were then used to classify the identified part types. The FGI is a classification of parts based on the part function, regardless of vehicle type. Each part has a specific function group. The part types previously identified were matched with a function group, and then all part numbers within those function groups were gathered. The identification logic described is illustrated in Figure 2.2.

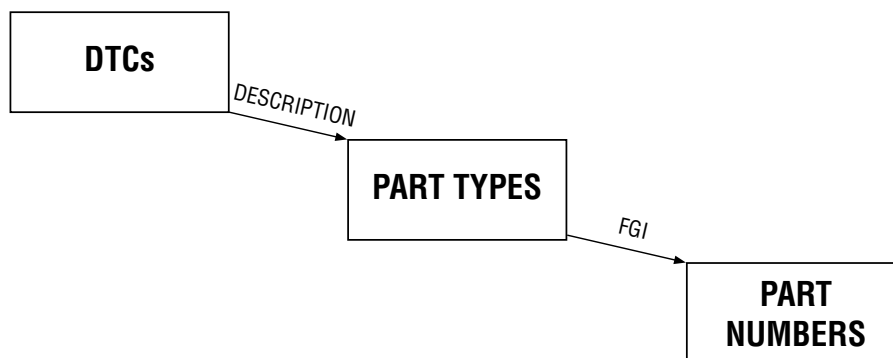

Figure 2.2: Illustration of the logic used when identifying part numbers for the analysis.

In order to reduce complexity of calculations, and to maximize benefits an improvement of forecast accuracy could lead to, the identified part numbers were then filtered based on potential impact. Potential impact was evaluated on the parts' criticality, life-cycle, demand pattern and value. All dimensions within potential impact are based on the literature review and findings from interviews with forecasting experts. Critical parts where demand is existing and the value is significant should have the greatest economic impact. Parts with too few data points to perform analysis were disregarded through filtering on a minimum of 50

demanded pieces per year. Consequently, the part numbers were filtered based on the mentioned criteria. After this filtration, it was discovered that the majority of remaining parts were either batteries or turbochargers (henceforth referred to as turbos). A turbo is a component used in vehicles to improve engine power and efficiency by compressing air which flows into the engine’s cylinders. (Tsai, 2004). Due to a majority of remaining parts being turbos or batteries, it was decided to focus on parts within those types in order to achieve a more thorough analysis. The filtration is illustrated in Figure 2.3.

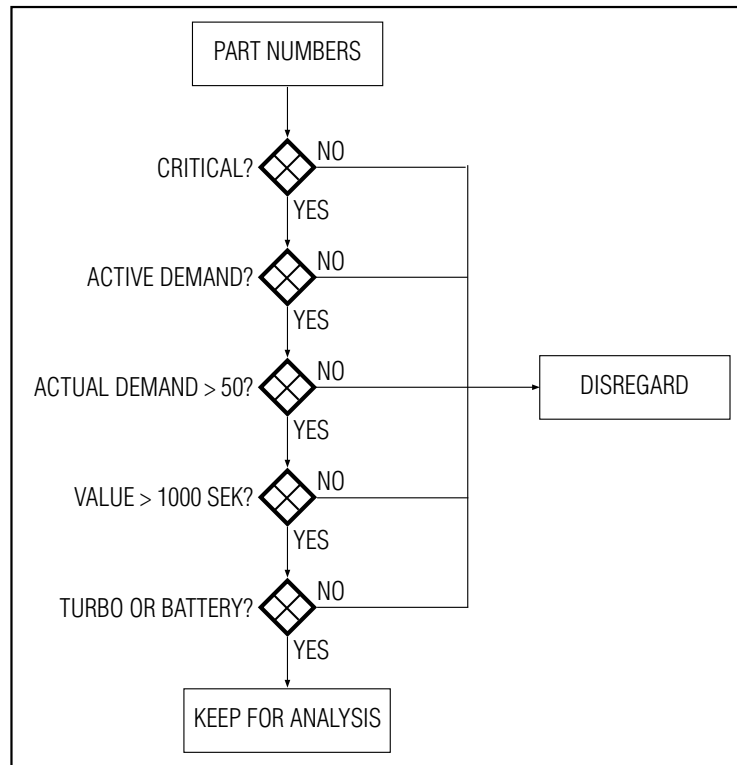

Figure 2.3: Illustration of the filtration of parts with potential impact.

Fault code data was extracted from different databases, and merged together using Qlikview and Python models. After the merger, calculations were conducted on the data in order to count the frequency of different fault codes in different time periods (months). This data was then used to calculate correlation between the fault codes and demand from dealers for different parts. Due to vehicles being on the road at the time of fault code occurrence, and the fact that vehicles are often only checked for fault codes when they arrive at a service point, there is bound to be a time difference between the occurrence of fault codes and customer demand of parts. Therefore, frequencies of fault codes and demand of parts were checked for correlation at every possible time difference. In Figure 2.4 it is illustrated how the time translation within the correlation analysis is performed.

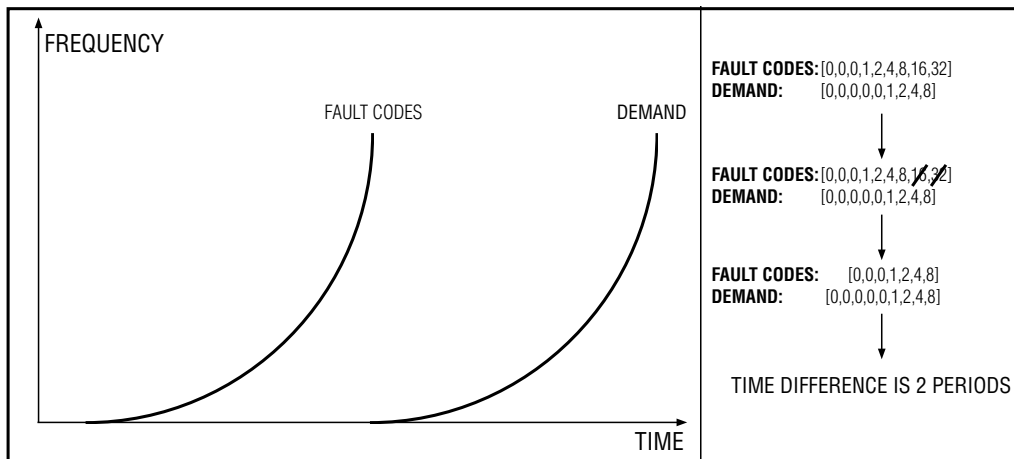

Figure 2.4: Simplified illustration of how the correlation test and time translation is performed.

Bryman and Bell (2011) argues that quality issues in data can be handled through assigning appropriate values to irregular data fields. Based on this, data quality issues in the thesis work were handled by assigning appropriate values in the event of irregular values. For example, after looking at a sample of the fault code data, it was found that there is a fault frequency counter for each vehicle and fault code. However, this counter can be sporadically reset to zero by either the service technician or vehicle operator. Therefore, frequency of fault codes was calculated as the sum of updates in the time of latest occurrence for a specific vehicle and fault code. If a fault code has been triggered multiple times in between updates of data, the calculation counts this as one occurrence. Thereby it is assumed that, for the service technician making a maintenance decision, an update in fault frequency is more important than the real number of times the fault has been triggered. This way of calculating also handles some deviating values, since if there are vehicles where a fault code is triggered an unusually large amount of times (due to for example a sensor failure) their inputs will be counted based on if there is an update from the last input, which would even out the counted frequencies.

2.4 Phase 3: Prediction and Comparison to Current Forecast

Parts with high level of correlation between fault codes and spare part demand from dealers found in Phase 2 were analyzed through linear regression analysis with least-squares estimation. Regression analysis is used to estimate a relationship between variables, and is explained in detail in Chapter 3. The regression analysis considers fault code frequency to be the predictor and demand as the outcome variable. Since there is a determined time difference within the correlation, the estimated linear equation of demand is a prediction/forecast of demand at a time horizon equal to the time difference in the correlation.

The correlation analysis resulted in a large amount of correlations on different time horizons. Therefore, a selection based on time difference and correlations was made before the regression analysis. The most reasonable time horizon was chosen in order to facilitate and improve the regression analysis. The chosen time horizon was then increased to a time span in order to reduce the risk of estimating an incorrect time horizon and thereby missing meaningful relationships. In order to increase the chance of continuing analyzing meaningful associations (associations which are not random), an evaluation of correlations between single fault codes and all part numbers within a part type was conducted. If one such group had correlation with high correlation coefficients, it was chosen for further analysis. For example, a fault code has a high correlation with multiple individual parts within the part type turbos. Thereby, it is likely that the fault code has meaningful associations with demand of turbos. This was done by finding fault codes with a match between part type name and fault code description and evaluating the Pearson's correlation coefficient (described in detail in Chapter 3) for that fault code and total demand for all parts within that part type. If the correlation was strong for one given fault code and all of the parts for a given part type, the result from the correlation analysis was deemed strong.

In order to evaluate the quality of the prediction, historical fault code inputs for all connected trucks were collected for a past period which was not included when calculating correlation and regression. In practice, this meant that the correlation and regression analyses were conducted for the period 2015/06 to 2017/09, whereas the prediction and comparison were made for the period 2017/10 to 2018/03. As such, spare part demand for dealers within Europe was predicted through the estimated equation for the period 2017/10 to 2018/03. The predicted spare part demand was then compared against the real demand for the same period in order to evaluate the forecast accuracy. Lastly, the regression forecast accuracy was compared to the system calculated historical-demand forecast accuracy by evaluating both methods' Mean Absolute Percentage Error (MAPE), which is a measurement of the forecast performance and is described in detail in Chapter 3.

Furthermore, the steps taken to achieve a prediction of demand based on fault code data were summarized and adapted into a proposed changed forecasting process for the analyzed parts. The proposed process was then compared to the process currently used to evaluate the impact an implementation would result in. The result of Phase 3 is a comparison for the evaluated spare parts between forecast based on fault code data and forecast based on historical data, i.e. how usage of condition monitoring data can affect the forecasting process and accuracy of demand forecast. Further method descriptions in Phase 3, which are dependent on results from preceding analyses, are presented and described in Chapter 5 in the order of usage.

2.5 Validity and Reliability

Two of the most important aspects when evaluating the quality of research are according to Bryman and Bell (2011) reliability and validity. Reliability is concerned with consistency of measures, whereas validity handles whether a measure of a concept actually measures that concept (Bryman and Bell, 2011).

In the qualitative phase of the thesis, reliability was increased by considering inter-observer consistency. Inter-observer consistency is, according to Bryman and Bell (2011), an issue of inconsistent interpretation that may arise when there are multiple observer-constellations judging information subjectively. To avoid this issue, all interviews were conducted and analyzed with the same observers present. Furthermore, after each interview the interpretations were discussed and agreed upon. Validity in qualitative research can be increased through internal validity, i.e. that the findings from observations should match the theoretical ideas developed (Bryman and Bell, 2011). This was covered in the thesis through verifying information from interviews with actual calculations in the later phases. For instance, findings from interviews in the shape of parts with potential of improving forecast through usage of fault codes were verified with actual calculations of correlation, causality and forecast accuracy. The action of cross-checking the results from different methods can be classified as triangulation and will, according to Bryman and Bell (2011), lead to an increased validity and reliability.

During the quantitative phases of the thesis, validity was increased by the usage of face and convergent validity. Face validity is, according to Bryman and Bell (2011), when an outside expert evaluates the model and deems if it is reasonable. A forecasting expert from the department where the thesis is conducted evaluated the correlation between demand and sensor data in order to increase the validity of the study. Convergent validity is, according to Bryman and Bell (2011), when the outcome of a method is compared to the outcome of other methods of the same thing. Convergent validity was used on the forecast based on fault codes when its results were compared with the result of the currently used forecast. If the fault code based forecast produces similar values to that of the current forecast it can be seen as that the new model is valid. Reliability during the quantitative phases was handled as described above when discussing data quality; i.e. by assigning appropriate values in the event of irregular values. As previously mentioned, triangulation by cross-checking qualitative results with quantitative results also increases the reliability.

External validity, which according to Bryman and Bell (2011) is the extent to which findings can be generalized to other studies, is limited within the thesis. The reason is that the study considers a limited scope of one company and a limited set of part types and evaluates specific solutions within that scope. However, some external validity exists in that the concept of using fault codes for forecasting of spare part demand is evaluated. Studies using other cases might not be able to replicate the findings, however parts of the thesis can be used as a basis for evaluating other cases. Validity of the correlation results was increased by analysis of correlation between

a single fault code and a part type. This was done by evaluating the correlation coefficients for a fault code and the demand of all parts within a part type. If the correlation was strong for one given fault code and all of the parts for a given part type, the result from the correlation analysis was deemed as strong. This approach also increases the probability of finding meaningful associations, which according to Barrowman (2014) is difficult when analyzing a large amount of data.

Throughout the thesis, assumptions had to be made. These assumptions are presented as they are made in the report. Some assumptions have a general effect on the result and its reliability. Section 6.4 presents a discussion of the general assumptions and what effects they have had on the results. Moreover, the thesis findings have several limitations, which are presented and scrutinized in Section 6.5.

3

Literature Review and Theoretical Framework

To reach the purpose of the thesis and answer the research questions, a theoretical framework is shaped through a literature review. The framework consists of an assembly and comparison of literature relevant for the thesis. The chapter is divided into six subsections covering different theoretical areas followed by a summary in the form of a conceptual framework

3.1 Forecasting of Spare Parts

In order to make qualified decisions about the future, information and assessment of the future state is required (Jonsson and Mattsson, 2009). Assessment of future factors' influence on a company's operations can be done with a forecast. Forecast is defined by Jonsson and Mattsson (2009) as: "*a future assessment of external factors that can be expected to influence the company and which the company itself cannot fully influence*". External factors could, for instance, be future market conditions.

Forecasting methods used for demand forecasting can, according to Jonsson and Mattsson (2009), be divided into two groups, quantitative methods and qualitative methods. Qualitative methods are methods that use little quantitative calculation and instead use different individual's experience and subjective judgment in order to evaluate the future state. In contrast, quantitative methods mainly use calculations, often based on time series of sales, usage or other historical data. Quantitative methods can be further divided into causal-based methods and time-based methods (Boylan and Syntetos, 2008). Boylan and Syntetos (2008) further state that causal-based methods are methods that base the forecast on explanatory variables, whereas time-based methods base the forecast on the history of demand. A similar description can be found for intrinsic and extrinsic forecast described by, for instance, Jonsson and Mattsson (2009). Jonsson and Mattsson (2009) describes that extrinsic methods are characterized by making a model between the variable to be forecasted and some explanatory variables which the forecast variable is dependent on. In contrast, intrinsic methods only analyze data from the variable to be forecasted (Jonsson and Mattsson, 2009). Due to these similar descriptions of the terms, intrinsic & time-based, and extrinsic &

causal-based forecasting methods will be regarded as equivalent in this thesis. Boylan and Syntetos (2008) argues that causal-based methods are especially useful in the initial phase of a product life cycle, due to the lack of adequate length of demand history for a time-series method.

Some commonly used time-based methods are *moving average* and *exponential smoothing* (Jonsson and Mattsson, 2009). Moving average forecast is a calculation of the average demand for a number of historical periods. By calculating the average from more than one period the effect of random fluctuation is reduced (Jonsson and Mattsson, 2009). The mathematical formula for moving average provided by Jonsson and Mattsson (2009), is presented in Equation 3.1.

$$\mathbf{F}(t+1) = \frac{(D(t) + D(t-1) + \dots + D(t-n+1))}{n} \quad (3.1)$$

Where:

$F(t+1)$: Forecast demand for period t+1

$D(t)$: Actual demand during period t

n : number of periods in moving average forecast

Jonsson and Mattsson (2009) continues to state that the moving average method puts equal considerations to each and every month that is considered. However, it might also be interesting to give the most recent periods heavier weights compared to the least recent periods. The exponential smoothing method is one way to achieve this weight distribution (Jonsson and Mattsson, 2009). The formula for exponential smoothing provided by Jonsson and Mattsson (2009) is presented in Equation 3.2. In exponential smoothing the smoothing factor α decides how much weight should be applied on the most recent demand compared to previous forecast and is defined between zero and one. The selection of smoothing factor effects how responsive to demand changes the forecast should be. A high α will make the forecast more responsive to systematic changes in demand but also make it more exposed to random variations (Jonsson and Mattsson, 2009).

$$\mathbf{F}(t+1) = \alpha \times D(t) + (1 - \alpha) \times F(t) \quad (3.2)$$

Where:

$F(t+1)$: Forecast value for period t+1

$D(t)$: Actual demand during period t

α : Smoothing factor

Forecasts are more or less precise in comparison to actual future demand. In order to evaluate and control forecasts a forecast error can be calculated. Forecast errors are measured per period and can, according to Jonsson and Mattsson (2009), be defined as: "*the difference between the forecast of one period and the actual demand for that period*". The aim with calculation of forecast errors is to evaluate the occurrence of random, individual and systematic errors, when the forecast generally is either too high or too low. There are many different methods to evaluate forecast error. Some of the more commonly used ones are: mean absolute deviation, mean error, mean percentage error & Mean Absolute Percentage Error (MAPE) (Jonsson and Mattsson, 2009). MAPE measures the spread of the of the forecast relative to actual demand and puts it in relation to the size of the actual demand. The mathematical equation for calculation of MAPE, provided in Jonsson and Mattsson (2009), is presented in Equation 3.3.

$$\mathbf{MAPE} = \frac{1}{n} \sum_{t=1}^n \left| \frac{F(t) - D(t)}{D(t)} \right| \times 100 \quad (3.3)$$

Where:

$F(t)$: Forecast at time t

$D(t)$: Demand at time t

Forecast of spare parts is especially difficult due to the intermittent demand which arises from the requirement of parts in the event of a breakdown (Cohen et al., 2006; Willemain et al., 2004). The intermittent demand also decreases the performance of time-based methods (Boylan and Syntetos, 2008). Jardine et al. (2006) argues that rising costs are driving companies to implement more causal-based forecast, such as a forecast based on condition monitoring data, in order to increase efficiency.

3.2 Maintenance

If companies move from using a "fail and fix" to a "predict and prevent" maintenance approach, the potential savings are large (Muller et al., 2007). The importance of the maintenance function in companies has increased due to trends of profit margin decrease, and customers demanding higher availability, quality and safety (Al-Najjar and Alsyouf, 2003). Due to these trends, the mission of maintenance is to provide customers with safe physical assets and excellent support by reducing and, if possible, eliminating the need for maintenance services (Levitt, 2011).

There are two main types of maintenance; corrective and preventive maintenance (Tsang, 1995). Tsang (1995) continues that Corrective Maintenance (CM) is also called breakdown maintenance, and is performed after a system or equipment has already broken down. The need for this type of maintenance is triggered by an unscheduled event causing a failure. Usage of CM means high maintenance costs due to: equipment has to be restored under crisis conditions, there is a risk of

secondary damages to health and safety, and lost production for the customer. Preventive Maintenance (PM) is an approach designed to avoid the costs of CM. PM is the practice of replacing or servicing parts in equipment at different intervals, and by doing so avoiding unscheduled failures and down-time in the equipment (Mobley, 2002). Preventive maintenance can be divided further into different methods, however there are multiple views in literature regarding what those methods are. In Table 3.1, a comparison of these views is presented.

Table 3.1: Comparison of different literature views on methods included in PM.

Author(s)	Different Methods of PM
Mobley (2002)	Equipment-driven Predictive Time-driven
Tsang (1995)	Time-directed CBM
Jardine et al. (2006)	Time-based/Planned CBM
Schmidt and Wang (2016)	Predetermined CBM Predictive

The classification of maintenance activities as described by Schmidt and Wang (2016) is chosen for the thesis, since it is written more recently, and thereby should reflect the current situation and new findings better compared to the other alternatives. However, predetermined maintenance is merely mentioned and not thoroughly explained by Schmidt and Wang (2016). Time-based maintenance is described in all other alternatives found, and Mobley (2002) means that timed-based can also be called scheduled maintenance, which is regarded as equivalent to predetermined maintenance. Therefore, predetermined maintenance is replaced with time-based maintenance in the thesis. In Figure 3.1, an adapted classification of maintenance activities based on Schmidt and Wang (2016) is presented.

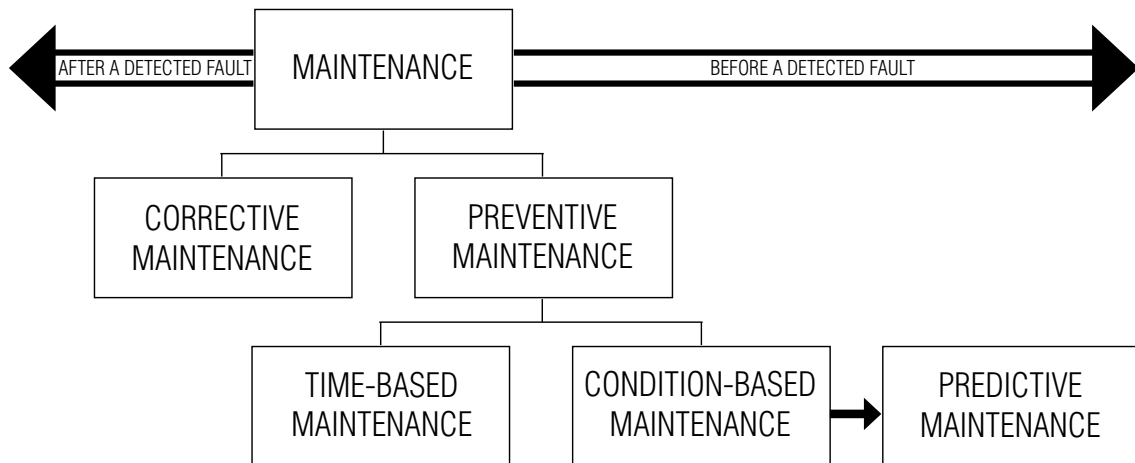

Figure 3.1: Classification of maintenance activities used in the thesis. Based on Schmidt and Wang (2016).

Time-based maintenance activities are performed at fixed time intervals (Tsang, 1995). The maintenance is performed at set times regardless of the status of the equipment (Jardine et al., 2006). According to Mobley (2002), this type of maintenance should only be used if failures that are impossible to predict can be reduced. Due to developments in technology, product complexity, as well as higher quality and reliability demands, the cost of preventive maintenance has increased (Jardine et al., 2006). Jardine et al. (2006) continues explaining that because of this development, companies have moved towards using CBM and predictive maintenance methods.

3.3 Classification of Spare Parts

There are large variations in spare part attributes such as stock-out effects, item value and demand pattern (Molenaers et al., 2012). According to Syntetos et al. (2009), classification through grouping spare parts with similar attributes allow identification of which spare parts are most important for a specific business function. The importance of spare parts differ between business functions, since different business functions have different goals and motivations (Molenaers et al., 2012). Molenaers et al. (2012) continue that from a maintenance point of view, parts are often classified based on machine failure, lead times, supplier reliability and item criticality. From an inventory management perspective, common classification attributes are demand pattern, unit price and inventory holding cost. Moreover, Yamashina (1989), highlight the impact of life-cycle phases on spare part importance and Persson and Saccani (2009) argue that classifications of parts should include life-cycle phase. Huiskonen (2001) has developed a classification which incorporates both the maintenance and the inventory management perspectives. The classification by Huiskonen (2001) includes criticality, specificity, demand pattern and parts value. At Volvo DIP, the classification of importance is made based on life-cycle phase, criticality, value and frequency of orders. In order

to match the literature with the case company, the attributes criticality, value, demand pattern and life-cycle phase are used in the thesis work to determine the importance of spare parts. Below, these attributes are explained in detail.

Criticality: Criticality can be split into two different categories; process criticality and control criticality (Huiskonen, 2001). Huiskonen (2001) continues that process criticality relates to the consequences for the process if there is a failure and no spare part is available. Control criticality defines the possibility to control the situation, and includes predictability of failure, availability of spare part suppliers and lead times. Molenaers et al. (2012) argue that substitutability and commonality could be included in the criticality attribute. The description by Huiskonen (2001) of specificity, the degree to which parts are tailored for a particular user or standardized to fit many users, incorporates both substitutability and commonality. Specificity is therefore also used to define criticality in the thesis.

Value: The value of a part correlates with inventory holding costs, and therefore high valued parts make stocking a non-attractive alternative throughout the entire supply chain (Huiskonen, 2001). Huiskonen (2001) continues explaining that even though value is a continuous parameter, it can be referred to in discrete terms such as low or high.

Demand pattern: The demand pattern is defined by both volume and predictability (Huiskonen, 2001). Spare parts often have erratic and intermittent demand, making it difficult to find the right balance between inventory costs and parts availability (Dekker et al., 2013). Boylan and Syntetos (2008) describes that demand can be described as intermittent if it is *“infrequent in the sense that the average time between consecutive transactions is considerably larger than the unit time period, the latter being the interval of forecast updating”*. Boylan and Syntetos (2008) also describes erratic demand as *“having primarily small demand transactions with occasional very large transactions”*. According to Huiskonen (2001), demand volume can, similarly to value, be described in discrete terms. Huiskonen (2001) further explains that a large portion of parts have very low and irregular demand, making control activities difficult.

Life-cycle phase: The life-cycle phase is defined by the number of years a vehicle is in production, and by the time passed since production ended (Persson and Saccani, 2009). According to Persson and Saccani (2009) the four phases of a life-cycle are launch, prime, decline and phase-out.

3.4 Condition Monitoring and CBM Process

The use of condition monitoring techniques to guide maintenance has grown steadily over the years since its introduction in 1979 (Wang, 2008). There exists a multitude of different methods and techniques that use different signals and decision variables. However, the working principle of condition monitoring is the

same regardless of the method used; namely condition data becomes available, is interpreted, and actions are taken accordingly (Wang, 2008). One example of a method using condition monitoring data is CBM. Wang (2008) describes that the CBM process generally can be divided into two stages. The first stage relates to the acquisition of monitoring data and its technical interpretation. The second stage is maintenance decision making, which roughly can be described as what to do when the data and its interpretation are available.

Additionally, Vachtsevanos and Wang (2001) argues that the CBM process can be divided further into four substeps. Vachtsevanos and Wang’s (2001) four-step architecture of CBM is:

1. Extraction of signal data
2. Finding correlation between sensor measurements and failure to determine health state of components
3. Using historical failure rate data and input from previous stage to predict when components will break
4. Scheduling of maintenance operations, i.e. deciding when and how to take action

In Figure 3.2, an illustration is presented of an adapted CBM process using both Wang’s two stages & Vachtsevanos and Wang’s four steps. The four steps architecture provided by Vachtsevanos and Wang (2001) will be explained in greater detail in the following sections.

STAGE 1: ACQUISITION AND TECHNICAL INTERPRETATION OF MONITORING DATA	STAGE 2: MAINTENANCE DECISION MAKING
<p>1. EXTRACTION OF SIGNAL DATA</p> <p>2. FINDING CORRELATION BETWEEN SENSOR MEASUREMENTS AND FAILURE</p>	<p>3. PREDICTION OF COMPONENT BREAKDOWN</p> <p>4. SCHEDULING OF MAINTENANCE OPERATIONS</p>

Figure 3.2: Illustration of an adapted CBM process based on Wang (2008) & Vachtsevanos and Wang (2001).

3.4.1 Extraction of Signal Data

The first step of the CBM process relates to the extraction of different types of data about the performance and/or condition of the equipment. There exists numerous different monitoring techniques and correlating sensors, signal data and fault codes. Some techniques or sensors that are commonly used to monitor the

condition or degeneration state of a component are: vibration, pressure, temperature and lubricating oil & wear particle analysis (Lee and Wang, 2008). Some different component applications of the different sensors are presented in Table 3.2.

Table 3.2: Example of implementations of common sensors and monitoring techniques.

Sensor or Monitoring Techniques	Components
Vibration monitoring	Bearing in airplane engines (Goodenow et al., 2000) Gas turbine (Chen et al., 1994)
Pressure monitoring	Gas turbine (Chen et al., 1994) Fuel Nozzle in gas turbine (Byington et al., 2002)
Temperature monitoring	Gas turbine (Chen et al., 1994) Fuel Nozzle in gas turbine (Byington et al., 2002)
Lubricating oil & wear particle analysis	Marine diesel engines (Wang et al., 2012) Gas turbine or diesel engines, drive components or hydraulic systems (Wilson et al., 1999)

Tsang (1995) describes the different sensors and monitoring techniques as follows:

Vibration Monitoring: Vibration monitoring is a technique that is used to detect wear, fatigue, misalignment and loosened assemblies in systems with rotating or reciprocating parts. Each operation in such a system releases energy in the form of vibration with frequency components. The vibrations can thereby be traced back to a specific part of the system. Unless there is a change in the operating dynamics of the system the amplitude of each vibration will remain constant. In essence, changes in the vibration is the result of some loosened assemblies, misalignment, fatigue or wear in the system.

Pressure Monitoring: Pressure monitoring is a normal part of the operational routine for monitoring system performance and the value can serve as an indicator of the system's health condition. Pressure monitoring, in addition to rotating or reciprocating parts, is applicable to non-mechanical parts such as filtration units, boilers, heat exchangers and pipework.

Temperature Monitoring: Temperature monitoring is the measurement of infrared energy as a means to determine the operational condition of a system. Anomalies in temperature, i.e. being either hotter or colder than normal, are taken as alarm signals that something is potentially wrong within the system. Temperature monitoring is especially suitable for systems that are reliant on heat retention or heat transfer.

Lubricating Oil & Wear Particle Analysis: Lubricating oil analysis and wear particle analysis are two different methods to determine the condition of the component. Lubricating oil analysis evaluates the condition of the lubricant in order to determine if the oil can continue to be used for its lubrication requirements. It evaluates the condition by using spectrographic techniques to analyze the elements contained in the oil. This information can be used in combination with other diagnostic procedures to identify the failure which might have caused the degrading oil quality. Wear particle analysis works in a similar manner. It evaluates the condition of the component by monitoring the occurrence, quantity, size, and composition of particles in the oil. In essence, increased quantity of debris is the result of wear and/or fatigue on the component.

3.4.2 Correlation Between Sensor Data and Failure

In this step, the correlation between failure and some sensor data parameter is determined. In order for CBM to be an appropriate method, there has to exist a correlation between failure and at least one measurable sensor parameter (Tsang, 1995). According to Chen et al. (1994), the relationship between sensor values and failure can be determined using statistical analysis or other mathematical approaches. One example is provided by Wang (2008) who modeled the relationship between observed sensor data and part lifetime through correlation analysis.

Lee and Wang (2008) argue that due to the increased information base, it is superior to use data from multiple sensors when implementing CBM. However, the model and calculations become very complex if correlations between multiple types of sensor data and failure are analyzed individually (Wang, 2008). Wang (2008) continue explaining that different sensor data may be correlated, which would further increase the complexity. There are methods designed to reduce this complexity. Examples of such methods can be found in Jardine et al. (2006), who describe that principal component analysis or independent correlation analysis can be used to reduce the number of sensor dimensions to be analyzed.

3.4.3 Prediction of Component Breakdowns

When predicting component breakdowns, the first milestone is to determine a threshold level of sensor value indicating that a monitored item is in a potentially defective state (Wang, 2002). Fault codes are indicators, where messages are sent when sensor values deviate from normal operation (Baptista et al., 2017). Thereby, when using fault codes, the threshold level has already been determined. Wang (2002) continues explaining that there are two different approaches to determine the threshold level. The first is a subjective approach where engineers use their judgment by looking at available data. This approach has the disadvantages of requiring multiple sources of data which may require a physical presence of the engineer and due to its subjective nature, the judgment varies between different

persons. In the second approach, a control chart is used to determine deviations from normal values. This method is statistically based, reducing the subjectivity, and does not require in depth engineering knowledge of the item.

3.4.4 Scheduling of Maintenance Operations

The last step of the CBM process relates to optimizing maintenance activities by using information derived from the previous steps (Wang, 2008). However, since the thesis scope is to predict requirements of components, this step is considered outside the scope and will not be evaluated in detail.

3.5 Correlation Analysis

According to Asuero et al. (2006), correlation is a measure of the direction and degree of linear association between variables. When using quantitative data, fine differences can be discovered and relationships between different variables can be detected through correlation analysis (Bryman and Bell, 2011). Dekking (2005) describes that the strength of correlation between two variables X and Y can be measured through Pearson's correlation coefficient $\rho(X, Y)$. Dekking (2005) continues that two variables have maximal correlation if the correlation coefficient is 1 or -1. Mason et al. (1983) describes that the correlation can, seen in absolute terms, be classified into three different groups, see Table 3.3.

Table 3.3: Correlation classification in absolute terms based on Mason et al. (1983).

Correlation	Classification
0.00-0.35	Weak/Low
0.36-0.67	Modest/Moderate
0.68-1.00	Strong/High

If there are n measurements of X and Y , the equation for calculating the $\rho(X, Y)$ is according to Crawford (2006) the following:

$$\rho(\mathbf{X}, \mathbf{Y}) = \frac{\sum_{i=1}^n (X_i - \bar{X})(Y_i - \bar{Y})}{\sqrt{\sum_{i=1}^n (X_i - \bar{X})^2 \sum_{i=1}^n (Y_i - \bar{Y})^2}} \quad (3.4)$$

Where:

\bar{X} : Sample mean of X

\bar{Y} : Sample mean of Y

$$-1 \leq \rho(\mathbf{X}, \mathbf{Y}) \leq 1$$

Correlation calculations do not take into account the nature of the relationship between variables (Wright, 1921). Wright (1921) continues explaining that due to

this, expectations or hypotheses that certain factors directly cause other factors is not taken into consideration. Moreover, correlation between factors does not necessarily mean they are causally related, meaning that a factor causes another factor (Barrowman, 2014). Barrowman (2014) also explains that when calculating correlation coefficients on large data sizes, many of the found correlations will be due to chance. This results in a challenge to find the meaningful correlations since they are easily hidden under a mass of chance findings.

3.6 Regression Analysis

Regression is a way of indicating if two variables, X and Y , are associated (Crawford, 2006). Crawford (2006) continues explaining that when using regression, one of the variables (X) is considered as a predictor/independent variable, whereas the other variable (Y) is considered as an outcome/dependent variable. Linear regression is used to estimate the linear equation describing the relationship between X and Y . According to Dekking (2005), the following equation is used in linear regression and is called the regression line:

$$Y = \beta_0 + \beta_1 X \tag{3.5}$$

In equation 3.5, β_0 is the intercept and β_1 is the slope coefficient (Crawford, 2006). Crawford (2006) continues that β_1 and β_0 can be estimated respectively by a least-squares estimation, which leads to the following equations:

$$\hat{\beta}_1 = \rho \frac{\sigma_y}{\sigma_x} \tag{3.6}$$

Where:

σ : Standard deviation

ρ : Correlation coefficient

$$\hat{\beta}_0 = \bar{Y} - \hat{\beta}_1 \bar{X} \tag{3.7}$$

Where:

\bar{X} : Sample mean of X

\bar{Y} : Sample mean of Y

Through so called multiple regression analysis, it is possible to find a linear relationship between multiple predictors and one dependent variable (Mason and Perreault Jr, 1991). If multiple regression is used, the equation is equal to Equation 3.5, with an inclusion of additional slope coefficients β_i and predictors X_i (Jawlik, 2016). The multiple regression equation is thereby the following:

$$\mathbf{Y} = \beta_0 + \beta_1 X_1 + \beta_2 X_2 + \beta_3 X_3 + (\dots) + \beta_{n-1} X_{n-1} + \beta_n X_n \quad (3.8)$$

When using multiple or single regression, the accuracy of prediction can be determined through statistical significance, F, and explanatory power (Mason and Perreault Jr, 1991). Explanatory power, measured by the coefficient of determination (R^2), is the percentage of variation in the dependent variable that can be explained by variation in the predictive variables (Eisenhauer, 2009). Eisenhauer (2009) further states that statistical significance, F, indicates the probability that the result of regression is due to chance. Only using statistical significance is enough if the purpose is to discover the existence of a relationship. However, when an accurate prediction is required, explanatory power should also be taken into consideration. The coefficient of determination is the square of multiple R, which is the multiple correlation coefficient (Jawlik, 2016). Jawlik (2016) continues explaining that multiple R measures the strength of correlation between the values of the dependent variable predicted by the regression model and the actual values of the dependent variable. Moreover, adjusted R^2 is a measure similar to R^2 , which does not automatically increase as the number of predictor values increase. It can therefore be used when new predictors are added in multiple regression to determine whether the newly added variable makes the regression output more accurate.

Multicollinearity, i.e. the extent that predictor variables are correlated with each other, increases the complexity and difficulty in interpreting results of regression (Kraha et al., 2012). Moreover, as stated by Nimon et al. (2010): "*Although correlated variables in a canonical set present no analytical difficulties, they do complicate result interpretation because it becomes less clear where the effects observed originate*". Kraha et al. (2012) also state that it is extreme to consider absence of multicollinearity as a prerequisite for conducting analysis. However, according to Jawlik (2016), the amount of predictors should be limited in order to reduce effects of multicollinearity and make the interpretation of results simpler. Jawlik (2016) continues that the whole purpose of conducting regression analysis is to accurately predict the future.

3.7 Conceptual Framework

The different sections with theory in this chapter contribute to answering the thesis' research questions. The connections between theory and research questions are illustrated as a conceptual framework in Figure 3.3.

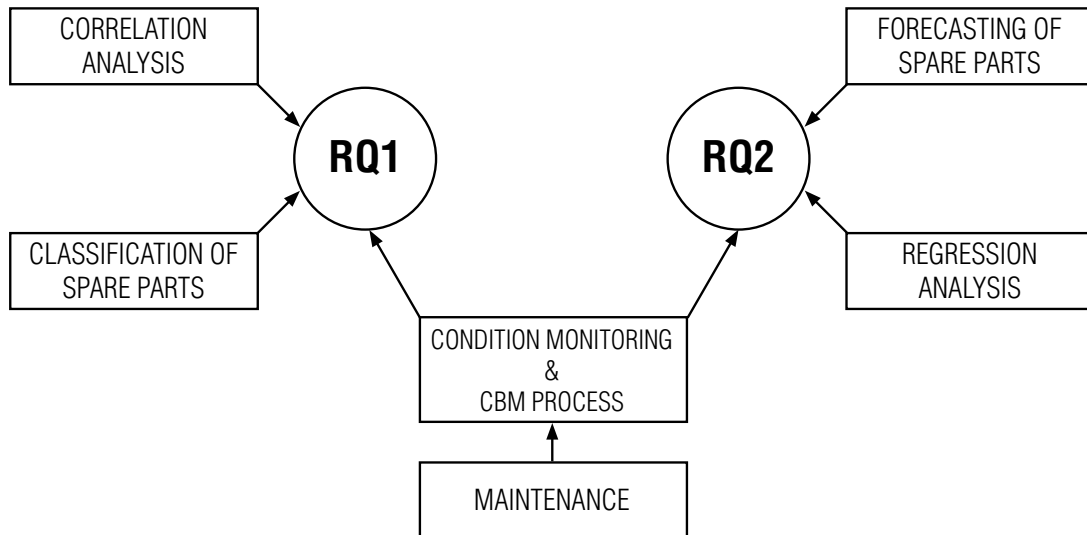

Figure 3.3: Conceptual framework over how theory contributes to answering the thesis' research questions.

Literature about classification of spare parts theory is used to focus the thesis scope to parts where maximum benefits can be achieved, thereby contributing to the first research question. Correlation analysis theory is also used to answer the first question, since correlation is the method used to find parts and fault codes with an association.

The theory regarding forecasting of spare parts is used to formulate a forecast based on fault codes, and to evaluate the forecast accuracy. Therefore, it contributes to the second research question. The forecast is based on calculations with regression analysis where a linear relationship between fault codes and spare part demand is estimated. Consequently, theory about regression analysis is used to answer the second research question.

Theory regarding maintenance, condition monitoring and the CBM process contributes to answering both research questions. Maintenance theory aids in the contextual understanding of condition monitoring, CBM and importance of data driven decision making. Condition monitoring and CBM process theory describes a methodology, part of which is applied when determining what steps should be taken in order to achieve the thesis purpose. Moreover, CBM process theory also aids in the conceptual understanding of condition monitoring by providing practical examples of applications.

4

Case Description

In this chapter a description of relevant parts of the case company is provided. Additionally, the forecasting process as well as fault code usage at the case company is described. If nothing else is stated, the subsequent text in this chapter is based on information from conducted interviews, internal documents and presentations from Volvo Group.

4.1 Volvo Group Organization

Volvo is a Swedish multinational publicly traded manufacturing company with headquarters in Gothenburg, Sweden. Volvo's core operations are related to production, distribution and sales of trucks, buses, construction equipment as well as marine and industrial drive systems. Additionally, Volvo also offers financial solutions and services to its customers. Volvo has around 95,000 employees and production operations in 18 countries. Their products are sold in more than 190 markets around the world.

Volvo is organized into group corporate functions, three truck divisions and ten different business areas, see Figure 4.1. The three truck divisions are Group Trucks Technology (GTT), Group Trucks Operations (GTO) and Group Trucks Purchasing (GTP). GTT's main focus is research and product development of complete vehicles, powertrain, components and service offerings. GTP's main focus is on purchase of automotive products and parts including aftermarket, for all truck brands as well as all indirect products & services purchasing. GTO's main focus is the manufacturing of cabs and trucks for the Volvo, Renault Trucks, Mack and UD trucks brands as well as production of Group's engines and transmissions in addition to spare part supply to the Group's customers and logistics operations.

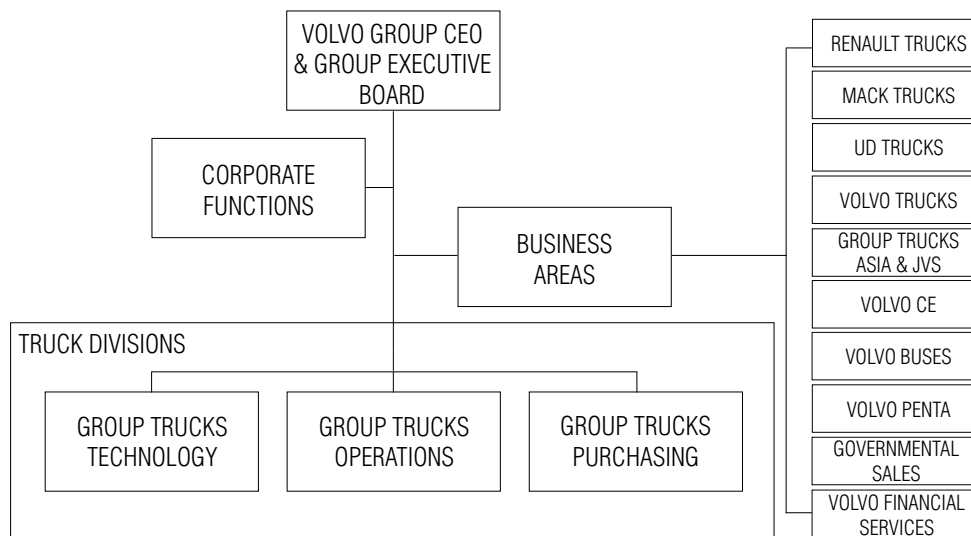

Figure 4.1: Organizational chart of Volvo Group.

4.2 Volvo Service Market Logistics

The thesis was performed within the Service Market Logistics (SML) part of GTO at the department Flow Optimization and Inventory Planning (FOIP). The scope of SML is managing, developing and optimizing the service market supply chain for all Volvo Group brands with the aim to secure customer up-time. SML is divided into numerous parts of which FOIP is in focus in the thesis. FOIP's aim is to form, steer and analyze the service market supply chain on a global level. FOIP is divided into ten different teams, of which DIP VTB/Penta, Refill and DIM work with the supply chain of parts for Volvo trucks in the European market, and are thus considered within the thesis scope. See Figure 4.2 for a simplified illustration of the Volvo GTO organization, including parts relevant for the thesis.

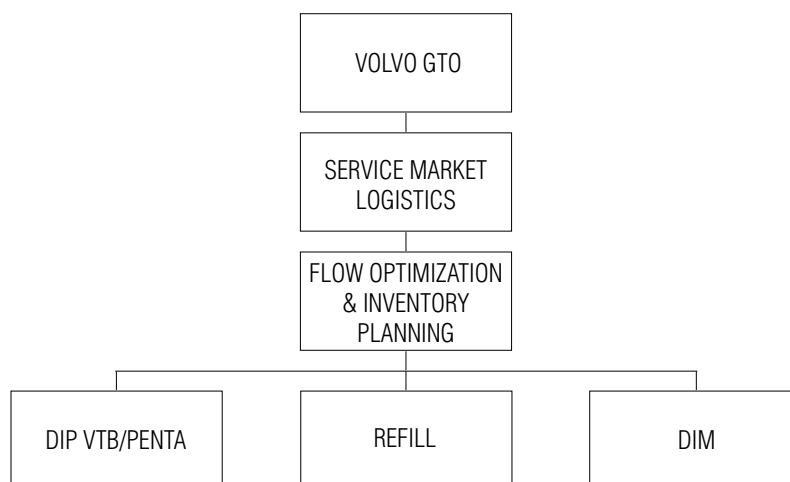

Figure 4.2: Simplified organizational chart of Volvo GTO.

4.2.1 Volvo's Service Market Supply Chain

Volvo's service market supply chain constitutes of six different roles. Namely suppliers, CDC, Regional Distribution Center (RDC), Support Distribution Center (SDC), dealers as well as end customers. The connections between the actors are illustrated in Figure 4.3. The overall aim of the supply chain is to provide short lead times and a high accessibility of parts to the end customer at the same time as cost are kept to a minimum.

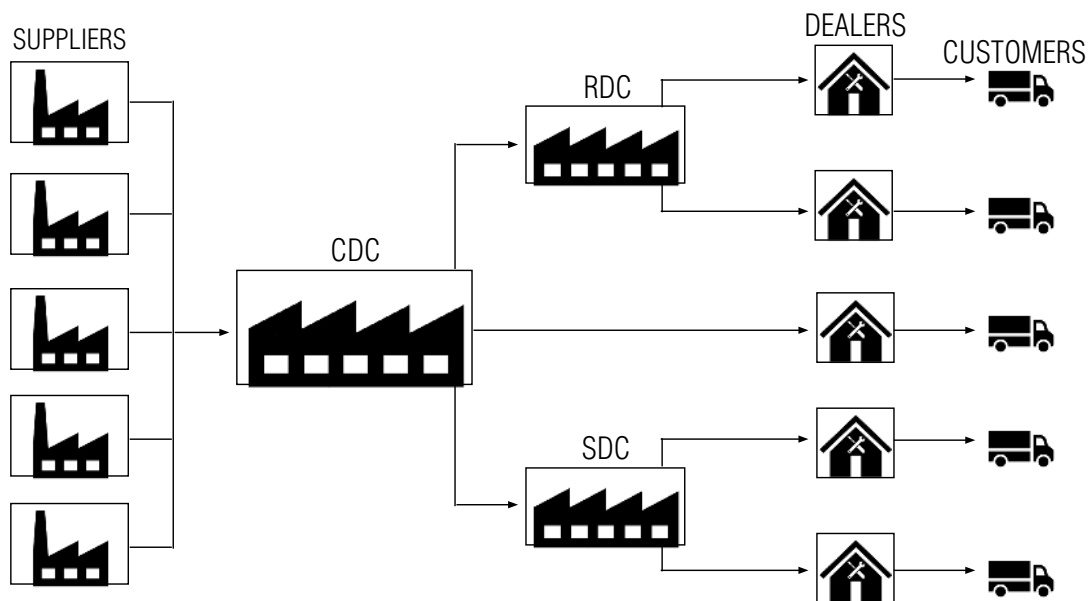

Figure 4.3: Volvo's service market supply chain.

Volvo SML deals with approximately 5000 suppliers that ship their products to 6 CDCs around the world. In Europe, there is one CDC, which is located in Belgium. As the thesis considers only the European market, this CDC is focused on. The CDCs distribute the parts to around 30 RDCs and 10 SDCs which in turn are supplying over 3000 individual dealers. The dealers are divided into dependent and independent dealers, where the dependent dealers are owned by Volvo and the independent are owned by an external party.

Different distribution centers fill different roles within the supply chain. More precisely, a CDC's function is to deliver the full range of parts to support warehouses, regional warehouses, importers and dealers. The function of an RDC is to provide availability to a specific region. This is done both with scheduled deliveries and emergency orders to dealers in the region. The product range stored at an RDC is based on the demand for the region that the RDC is supplying. An SDC's function is to quickly distribute emergency orders to dealers when the RDCs or CDCs are unable to deliver in time. The SDCs are located at strategic locations close to the end of the supply chain and, when compared to CDCs and RDCs, are therefore able to provide quicker and cheaper emergency orders to

certain geographical areas. The different actors acquires parts from their closest upstream actor by placing orders. There exists three different types of orders:

Stock orders: Standard orders that are placed well in advance and are transported by either ship or truck in order to keep costs down as well as minimize the environmental impact. Lead times are longer compared to the other order types.

Day orders: Orders that are placed for delivery the next day, or even the same day depending on geographical location. Lead times are shorter compared to stock orders but are more expensive.

Vehicle Off Road orders: Vehicle Off Road (VOR) orders are emergency orders that are extremely urgent and are highly prioritized. Transports can be made by airplane and/or taxi in order to make deliveries as quickly as possible. Thereby, the lead times are the shortest, but costs are highest when compared to the other order types.

Within Europe the lead time for parts from the CDC in Belgium to dealers is on average two weeks. Moreover, the lead time from suppliers to CDC is a sum of supplier production time, transportation time and time to stock the part in the CDC. Therefore, the lead time from suppliers to customers varies for different parts.

4.2.2 Responsibilities Within the Supply Chain

The responsibilities within the spare part supply chain can be divided between DIP, Refill and DIM in the following, simplified, way:

- **DIP:** Responsible for setting forecasts to manage and optimize availability & inventories on a CDC level.
- **Refill:** Responsible for the placement of refill orders to manage availability and inventory levels of the RDCs and SDCs.
- **DIM:** Responsible for the placement of stock orders to manage and optimize availability & inventory levels of the dealers.

In Figure 4.4, an illustration of the supply chain responsibilities is presented. This is followed by a more extensive explanation of the departments.

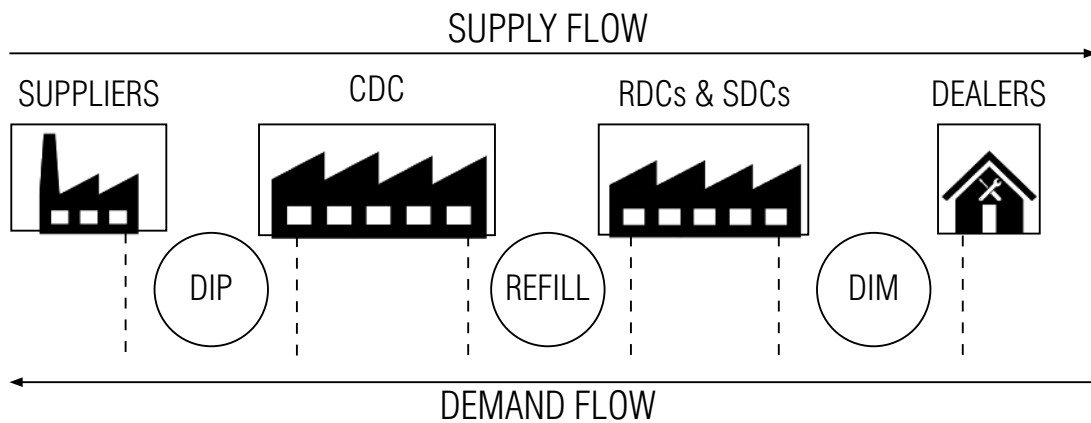

Figure 4.4: Simplified illustration of responsibilities within the spare part supply chain.

Demand and Inventory Planning

Demand and Inventory Planning (DIP) VTB/Penta are responsible for optimizing and planning spare parts inventories for Volvo Trucks, Volvo Buses and Volvo Penta on a CDC level. The planning is done based on forecasts which are calculated from historical demand as well as additional input parameters from different sales areas. There are also projects in initial stages with the intent to develop causal-based forecasting methods. The focus of the department is to create as accurate forecast as possible in order to provide a high availability of spare parts whilst lowering the corresponding inventories. Thereby, optimizing service levels and total costs.

The work in the DIP-department is divided based on the life-cycle of a part. Furthermore, a classification is used at DIP to create segments of parts with similar characteristics. Based on this classification, different people within the department are responsible for products within a specific segment. The classification is divided into the phases initial, prime, decline and phase-out. The time for each phase varies between different parts. However, for a majority of parts, the period when Volvo is responsible for part availability is 15 years after production has ended. Parts in the initial segment are parts that are recently introduced into the service market and have an increasing frequency of orders. Due to the recent introduction, no or very limited historical demand data is available in this segment. The prime segment is characterized by a high and stable demand and a mature market. Following is the decline segment, which is characterized by a steady decline in demand and a reduction of inventories. Lastly is the phase-out segment, which includes parts that are being phased out and have a demand that is decreasing to zero and inventories being decreased and scrapped. Figure 4.5 provides a graphical illustration of the order frequency in the different segments.

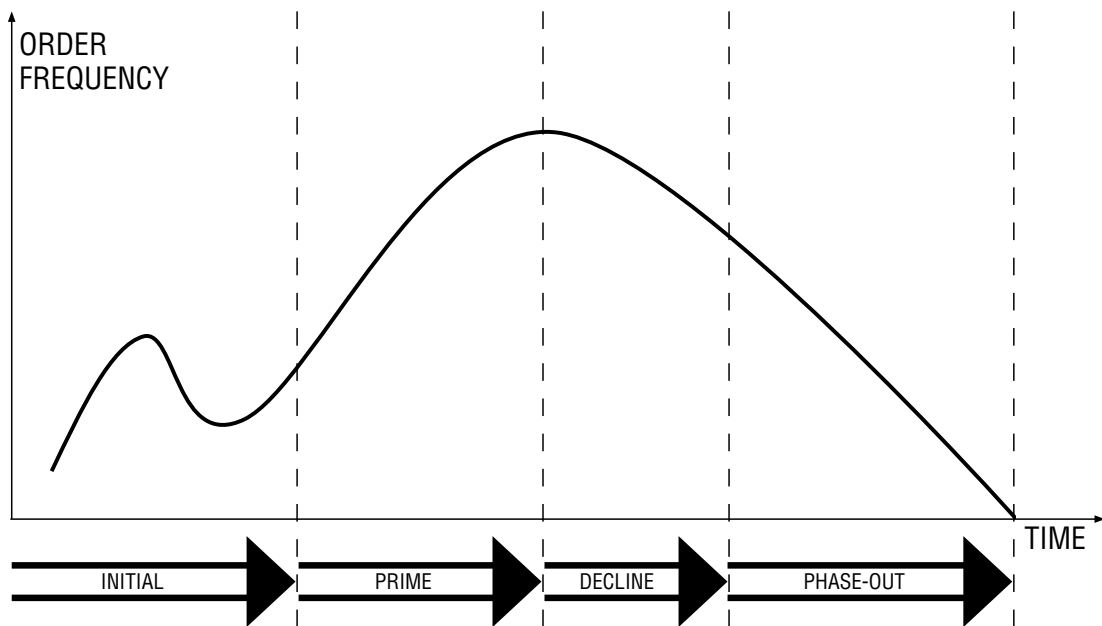

Figure 4.5: Illustration of the segmentation of spare parts.

Refill

The Refill-department is responsible for placing replenishment orders to ensure availability of parts in the RDCs and SDCs. More specifically, the goals of the department is to achieve high availability to customers, low supply chain costs and to balance capital tied up with order handling costs.

Operationally, Refill works with accepting, changing, and/or denying system generated suggestions/proposals of replenishment orders. A large part of these suggestions are automatically approved by the system, however a portion of them are handled by persons within the department. The decision whether a proposal should be approved or not is based on a refill concept with three policies. The first policy is called Stock Holding Policy and creates guidelines for whether a part should be stocked at specific RDCs and SDCs. This policy is based on amount of order hits and price of the part. Policy two is called the Refill Policy and guides the timing and quantity of part orders. The basis of this policy is the sales forecast on RDC/SDC level, unit price, lead time consumption, safety stock and Economic Order Quantity (EOQ). The final policy relates to buyback and scrapping of parts, and is called the Return/Scrap Policy. This policy guides the timing and scope of parts to scrap and/or return to CDC. Generally, these activities are performed four times each year and are based on sales frequency.

Refill also performs follow-up activities on the lead time from CDC to RDC and SDC. The reason for this is that longer and/or more fluctuating lead times have a negative impact on availability, inventory levels and freight costs. By monitoring actual lead times and lead time deviations, Refill ensures that the system contains

correct lead times, which makes the system generated replenishment suggestions more accurate.

Dealer Inventory Management

The DIM-department is responsible for optimizing, managing and monitoring the spare part inventory levels for dealers with a Logistic Partner Agreement (LPA). LPA is a vendor managed inventory agreement where Volvo manages, controls and replenishes spare part inventories. DIM aims to achieve the right customer service while balancing inventory and cost levels. The part of the supply chain within DIM's scope is from the CDC, through RDC or SDC to the dealer-shelves.

DIM, similarly to Refill, works with stock management based on a stock holding policy split into the three parts. The aim of the stock holding policy is to ensure high availability to customers, low supply chain costs, and strengthening partnerships with dealers. The three parts are described in detail below:

1. **Picks Table:** Answers whether a part should be stocked as well as if the stock orders should be automatically managed by LPA or manually managed by the dealer. The decision is based on order line frequency and unit price.
2. **Refill Table:** Decides how much should be ordered to the dealers, the EOQ, and when it should be ordered, the re-order point. The EOQ and re-order point are based on the part unit price and demand forecast per month for the dealer in question. This demand forecast is calculated through historical demand data. The parameter design, i.e. the calculations of limits deciding timing and quantities, is optimized through advanced stock control theories, feed-back from dealers & markets and practical experience within Volvo.
3. **Return Selection Criteria:** There are two types of return activities carried out within the LPA. The first type is an initial buy back, where stock is cleaned from parts without demand for dealers who sign a new LPA. The second type is a periodical buy back, meaning that in regular intervals, stock is returned from dealers to maintain a low level of non-moving parts. Dealers with an LPA are compensated for parts which are bought back. The level of compensation is higher if the part was automatically refilled by the system, and lower if the part was manually refilled by the dealer.

4.3 Forecasting Process

As the main focus of the DIP-department is generating forecasts and planning inventory levels for different parts, processes for these activities have been developed. In this section, the forecasting process is described in detail.

Within Group Trucks Processes, there are processes to plan and schedule service market parts. One of the key processes which constitutes the planning and scheduling of parts is to manage demand. The processes to manage demand

4. Case Description

include (but are not limited to) capture & realignment of historical demand, forecasting, and inventory planning. These three processes are managed by DIP. The trend within management at Volvo is to reduce dependency on chance, which increases the importance of forecasting. The forecasting process input is created from the capture of demand process. Therefore, this process will be described first. The capture of demand and forecasting process charts are illustrated in Figure 4.6.

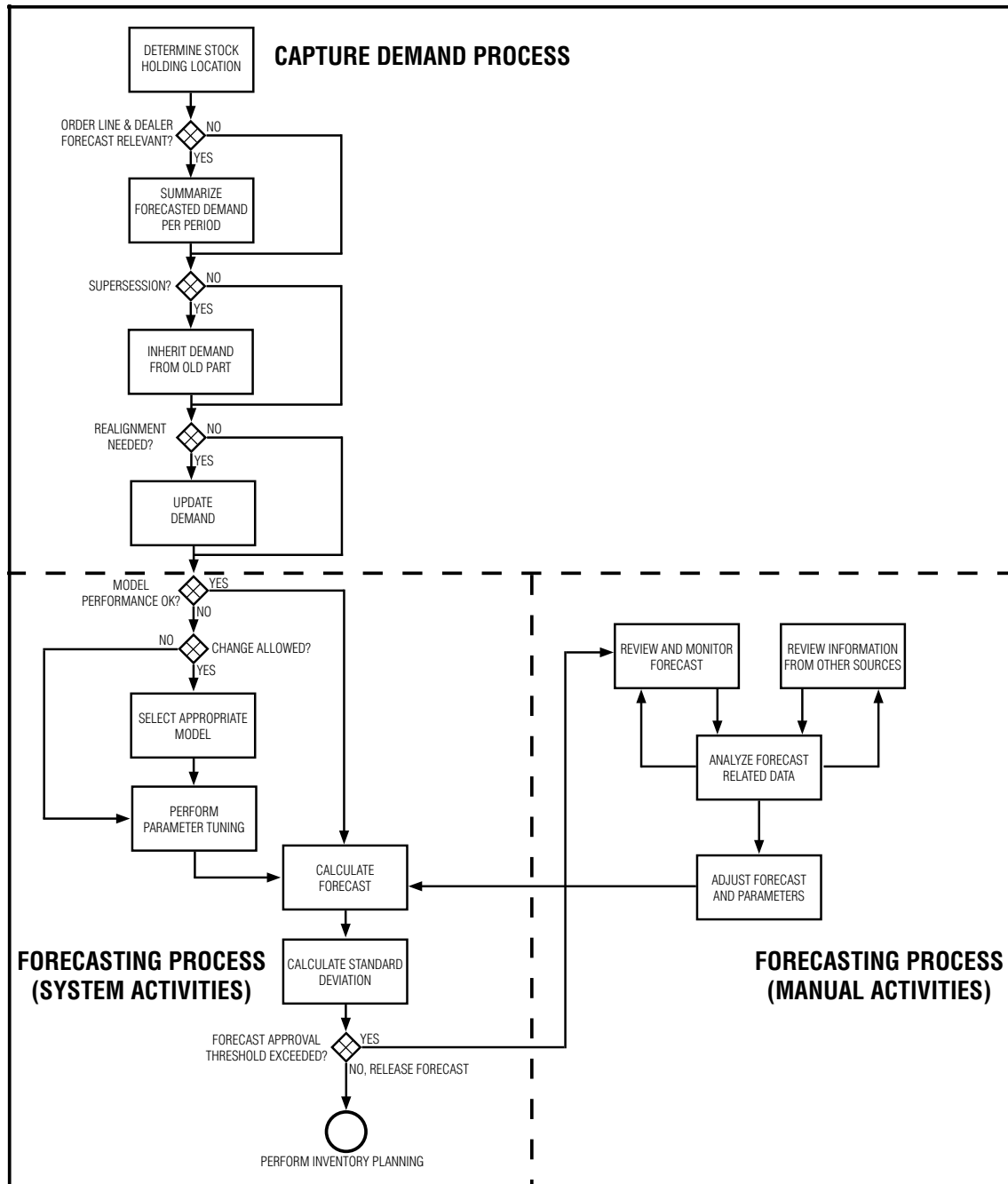

Figure 4.6: Process chart for capture of demand and forecasting processes at Volvo Group.

Activities within the capture of demand process include determination of where a part should initially be stocked, evaluation of whether a realignment/update of the historical demand data is required before the information is sent as input to the forecasting process. The realignment/update of historical demand data is made if there are large deviations which are regarded as outliers, and thus should not be the basis of future forecasts.

The forecasting process contains activities that are either system performed or manually performed by members of the DIP-department. The system activities calculate a forecast based on the historical data input. The system activities start with checking whether the currently used forecasting model has a sufficiently good performance in terms of Forecast Quality (FCQ), which will be described in detail in the following section. The forecasting model is selected based on a parts' demand flag, which can be new, obsolete, non-moving, slow, lumpy, fast, negative trend, positive trend or erratic. The system selects a demand flag for each part based on measurements such as active periods, number of zero demand periods and standard deviation between periods. Based on the demand flag, a time-based forecast method is chosen. Slow and lumpy items are forecasted either through simple moving average or through the Boylan-Syntetos method, which combines a moving average of non-zero demands and moving average of the interval between non-zero demands. For fast items, which have an even demand pattern, moving average with exponential smoothing is used. For trending items, a trend adjusted moving average with exponential smoothing is used. For all different forecast methods adjustments according to seasonality can be made if the demand is marked as seasonal. If the model performance is above the allowed threshold value, the new forecast is calculated using the same model. If not, another model is selected and parameter tuning is performed before the new forecast is calculated. If the new forecast performs as expected, which is true for a majority of the cases, the forecast is released. However, occasionally the system forecast deviates strongly from previous forecasts. If this is the case, an alert is sent to the DIP-department, initiating the work loop within the manual activities.

In the manual activities, a review is initially carried out on a part number level to see which parts have a deviating forecast level. The forecasts are also monitored continuously to follow up on forecast accuracy and other related performance indicators. A demand plan is then created through analysis of information from various sources such as input from sales area, seasonality and quality issues. Finally, the system generated forecast is adjusted and parameters are tuned to optimize the forecast for analyzed parts.

Based on the produced forecast, a delivery schedule is calculated weekly. The delivery schedule is a 12 month expected demand plan for suppliers. For each part and supplier, a time when the delivery schedule is fixed, a freeze time, is negotiated.

4.3.1 Forecast Quality and Other KPIs

A forecast's quality is evaluated by a mathematical formula for Forecast Quality (FCQ). Equation 4.1 shows the mathematical equation for calculation of FCQ that is used by the DIP-team on items with fast or normal demand. The formula evaluates in absolute terms how much the forecast differs from the actual demand. Thereby, over- and underestimations are regarded as equally undesirable. The formula is also weighted so that articles with many order hits are given more significance than articles with few order hits. By doing this articles which have high customer impact are given importance over articles with low customer impact. In essence, it drives accurate forecast on high frequent articles and disregards low frequent articles.

$$\mathbf{FCQ} = \frac{\sum \left(\frac{|D-FC|}{\max(D;FC)} \times OH \right)}{\sum OH} \quad (4.1)$$

Where:

D: Demand

FC: Forecast

OH: Order hits

FCQ is the main Key Performance Indicator (KPI) used by the DIP department, some other KPIs used by FOIP are shown in Table 4.1. There are other KPIs used by FOIP as well, but the ones presented in Table 4.1 are the ones which are of interest to the thesis.

Table 4.1: KPIs used by FOIP.

Category	KPI
Environment	CO ₂ Emission from Transports
Delivery	Dealer Service Index
Delivery	Aftermarket Parts Backorder Recovery
Delivery	Aftermarket Parts Availability
Cost	Aftermarket Logistics Cost per Volume
Cost	Aftermarket Inventory Days
Cost	Transport Products Inventory Days

4.4 Fault Codes at Volvo

In the interview with the Spare Part Manager and Service Manager at a Volvo-certified dealer, information was gathered about the usage of sensor data and fault codes in maintenance operations. The dealer is able to monitor fault codes and other sensor data from vehicles which are affiliated with that specific dealer. From the beginning of 2018, all vehicles with a Volvo-contract are connected and sends data

when on the road. The fault codes are directly related to certain sensors within the vehicles. If the related sensors indicate values above predefined threshold values, a fault code will register for the specific vehicle.

Since the dealer can continuously monitor affiliated vehicles for fault codes and sensor data, the dealer has the option of interpreting data and call customers to schedule service of parts before they break. However, due to the nature of the transportation business, i.e. long trips and low margins, it is difficult to motivate customers to abort a transportation mission to service the truck and potentially avoid breakdown of certain components. Furthermore, the task of analyzing telematics data and contacting customers based on the findings is time consuming. One reason for the process being time consuming is that within the system that the dealer uses, fault codes of vehicles is not continuously stored. Instead, to see the fault code situation within a specific vehicle the dealer must connect to it in real time, which either takes time or is non-successful due to the vehicle being unavailable for connection during that specific moment. Therefore, this option is not widely used. However, these findings show that there is available data from vehicles which could be used to predict breakdowns.

When a vehicle has arrived for service at the dealer, fault codes are read through connecting the vehicle with a wire. The codes are then translated with a program to enable understanding for the service technician performing maintenance. Based on the translation, the technician tries to find the root cause which could explain why the fault code has been triggered. Often, the technician can through experience determine possible root causes and take a maintenance decision based only on the translated fault code and its frequency. If this is not the case, there is diagnostics documentation within the program. This documentation can provide the technician with the most likely reasons of the fault code and thereby suggest a starting point of diagnosing the root cause. Within internal documents describing the vehicle maintenance and process at Volvo, it was confirmed that inspecting fault codes is a key activity within this process. Fault codes are used by service technicians to determine the root cause and solution of problems, as well as an aid when performing PM.

5

Result & Analysis

In this chapter the results from the qualitative and quantitative data collection is presented. Through the results and the theoretical framework, an analysis of fault code usage in forecasting at Volvo Group is then performed. Data of reported fault codes and dealer sales is used to create a demand forecast. The new demand forecast is then compared and evaluated to the currently used forecast.

5.1 Identified Fault Codes and Part Types

In Phase 1, the qualitative data collection, emphasis was put on two different areas, potential fault codes and potential part types. The findings of each are presented in detail in the following subsections.

5.1.1 Fault Codes

In the quantitative data collection, approximately 200 DTCs, otherwise called fault codes, were found with potential impact on part breakdowns. In total over 80 million code inputs have been logged by the trucks since 2013. Figure 5.1 illustrates the total number of reported fault code occurrences from studied fault codes. From the graph it can be seen that number of fault code reports were relatively low until mid 2015, which is due to a lower amount of connected vehicles. Reported fault codes from vehicles outside Europe are excluded in the report and analysis. The geographical location of vehicles reporting fault codes was determined by the reporting vehicles' logged country of operation, country where the vehicle has been repaired the most amount of times and/or which market is associated with the vehicle's service contract. If any of the criteria are marked as outside of Europe, the vehicle and all of its reported fault codes is disregarded.

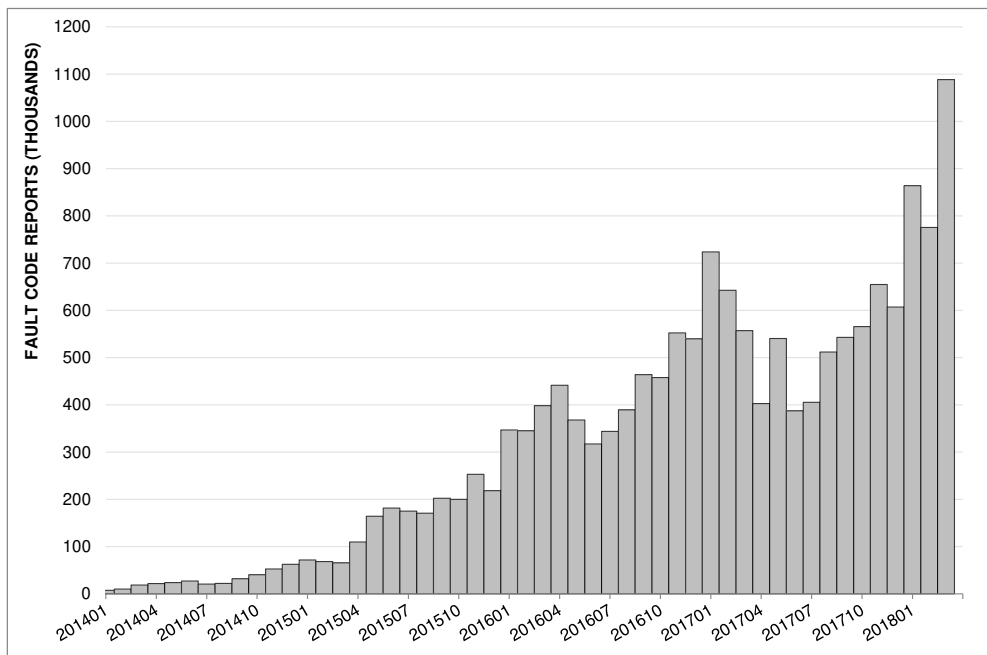

Figure 5.1: Graph over total reports per period in Europe for studied fault codes.

5.1.2 Part Types

During the interviews with different sensor data experts at Volvo information was gathered about which part types that were expected to have a correlation between sensor data/fault codes and breakdowns of trucks. This, in addition to presentations and different active initiatives for usage of condition monitoring data was used to create a list of potential part types which is presented in Table 5.1. The information gathered from the presentations combined with a description of identified fault codes guided a selection of part types which are believed to hold the most potential of being connected to the fault codes. They were therefore chosen to advance to the next phase, the quantitative analysis. The selected part types are also shown in Table 5.1. Each of the selected part types has around 900 different part numbers.

Table 5.1: List of identified and initially selected part types.

Identified Part Types	Initially Selected Part Types
Batteries	Batteries
Nozzles	Nozzles
Brakes	Throttles
Suspensions	Fuel control units
Gearboxes	Injectors
Tires	Turbos
Pumps	Sensors
Throttles	
Fuel control units	
Injectors	
Turbos	
Sensors	

5.2 Selected Parts

During the interviews with different forecast experts at Volvo's service market supply chain, information was gathered about which criteria for filtration of potential part types and part numbers that might be considered. The main criteria presented by the forecast experts were parts that are vital for the customers' up-time, i.e. parts that are required in order to ensure truck up-time such as for example engine components or battery. Shortage of such a part would always result in truck down-time. The concept of customer perceived availability, which is related to the customer up-time, was also presented as an important criteria. Customer perceived availability can roughly be interpreted as a customer's tolerance for lack of availability of a part. Perceived availability and actual availability often differ from one another. Customers are understanding and acceptable for waiting time for some parts and very uncomprehending for lack of availability of some other parts. Examples to illustrate this are start engines and oil filters. Start engines are perceived to be a complex product in the eyes of the customer and there is some amount of acceptance that it is not always available on stock without any notice. In contrast, oil filters are perceived to be a simple part which should always be available and down-time caused by lack of availability of it is unacceptable by the customers. Due to this variation in customer importance, the forecast experts argued that parts with high customer perceived availability should be prioritized. Some experts also argued that the parts must have a significant value in order to justify the more advanced analysis which is explored.

The parts were filtered based on the found criteria. The filtration is conducted by subsequently applying different filtration criteria, see Figure 2.3 for a graphical illustration of the process. Initially there were 5775 different articles which were reduced by subsequently applying different filtering criteria. Table 5.2 illustrates how the considered number of parts are filtered as different criteria are applied.

Table 5.2: Filtration of articles.

Filter	Part Numbers
Initial Selection	5775
Criticality	409
Active Demand Flag	310
Actual Demand	122
Item Value	62
Turbo or Battery	48

The criticality filter is an evaluation of whether the parts are deemed as up-time critical for the vehicles. The active demand flag filter evaluates if the parts are logged as having an active demand or not in the internal systems. Actual demand is an evaluation if the demand is larger than 50 items per year, which is made in order to ensure that the result is applicable on parts that has some economical contribution. Item value is a filtration on items cost which removes the items that cost less than 1000 SEK. The item value of 1000 SEK was chosen as it is a significant

value according to interviewed forecasting experts. After this step, there was a clear majority of battery and turbos remaining why the other parts were removed by the last filter. After the last filtration only 48 part numbers that fulfilled all the filtration criteria remained for further analysis.

5.3 Finding Associations Through Correlation Analysis

Based on the selected part numbers and selected fault codes a correlation analysis was conducted. In the analysis each fault code and each part number were checked for correlation on different time horizons. A time horizon is equal to the amount of periods fault code reports are shifted before analyzing correlation. For example, a time horizon of two periods means that the relationship between the fault code and the part demand is separated by an interval of two months. Due to the low amount of data points before 2015/06 the analysis was conducted on data from 2015/06 to 2017/09. The result of the analysis was 3819 different correlations that were stronger than 0.80. Table 5.3 shows an example of the result of the analysis.

Table 5.3: Example of correlation results with mockup data.

Part Number	Fault Code	Correlation	Time Horizon
123456789	A12345	0.921072024	1
123456789	A12345	0.922494224	2
123456789	B12345	0.941635975	14
987654321	B12345	0.952213533	5
987654321	C12345	1	12
987654321	C12345	0.942193017	3

The result from the correlation analysis was further refined by the reduction of correlations with a coefficient of 1, also called a perfect correlation. Kuma (1984) stated that: "*In real life, there are always random variations in our observations; hence a perfect linear relationship is extremely rare*". Based on Kuma's statement and the logic that it is extremely unlikely that fault codes can pick up on everything that causes a article demand, the correlations of 1 was removed from the result.

Additionally, results with a time horizon over 12 months were discarded since it is, based on the interview with a Volvo-certified dealer, an unreasonably long time difference between registration of fault codes and article demand. After the reduction of correlations of 1 and time horizons over 12 months 554 correlations between part number and fault code on different time horizons remained.

5.4 Forecast Through Regression Analysis

With basis on results from the correlation analysis a regression analysis was conducted. In order to facilitate the regression analysis, a single time horizon span was chosen. The first step to choose this span is that the interview at a Volvo-certified dealer showed that vehicles have a time between service of two to five months. Because dealer demand occurs when a vehicle is serviced, the time horizon should be equal to the average time between fault code occurrence and service. Assuming continuously and evenly distributed occurrence of fault code, the average time between fault occurrence and service is between one to two and a half months, depending on which end of the interval is chosen. Furthermore, by calculating the average of suggested time between services for all vehicles with a service contract, a time period of roughly five months was found. Based on this, the upper end of the interval, i.e. five months, was chosen as the time between service. Thereby, the most reasonable time horizon was set to three months (rounded up from two and a half months). In Figure 5.2, an illustration of the relationship between service interval, assumed occurrence of fault codes and dealer demand is presented. In order to reduce the risk of making an incorrect assumption and thereby not finding meaningful relationships, the time horizon was expanded to a span between two and five months.

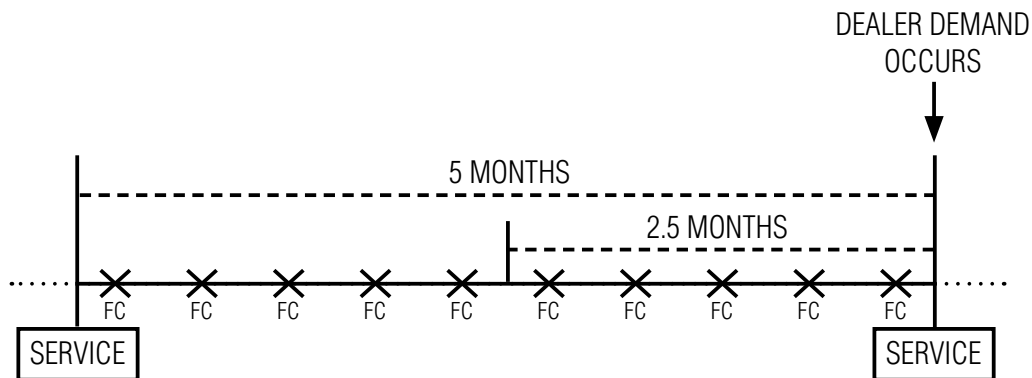

Figure 5.2: Illustration of the relationship between time between service, assumed occurrence of fault codes and dealer demand.

5.4.1 Analysis on Part Type Level

The description of one studied code, D1A9Z, includes the word *turbo*, and was therefore analyzed on the total demand of studied turbos. The time horizon with highest correlation between occurrence of D1A9Z and total demand of turbo is two months. A regression analysis with D1A9Z occurrence as the predictor and total turbo demand as the outcome variable was performed. The linear equation from regression was calculated between the same periods as the correlation analysis, i.e. 2015/06 to 2017/09. The total demand was then predicted using the linear equation between 2017/10 to 2018/03. In Figure 5.3, the regression analysis between fault code D1A9Z and total turbo demand is presented. In the 'Linear Equation

Calculation'-area, the regression based forecast is tuned for the occurrence of fault code and demand by minimizing the mean square error. In the 'Demand Prediction'-area, the regression based forecast is tested on subsequent fault code data.

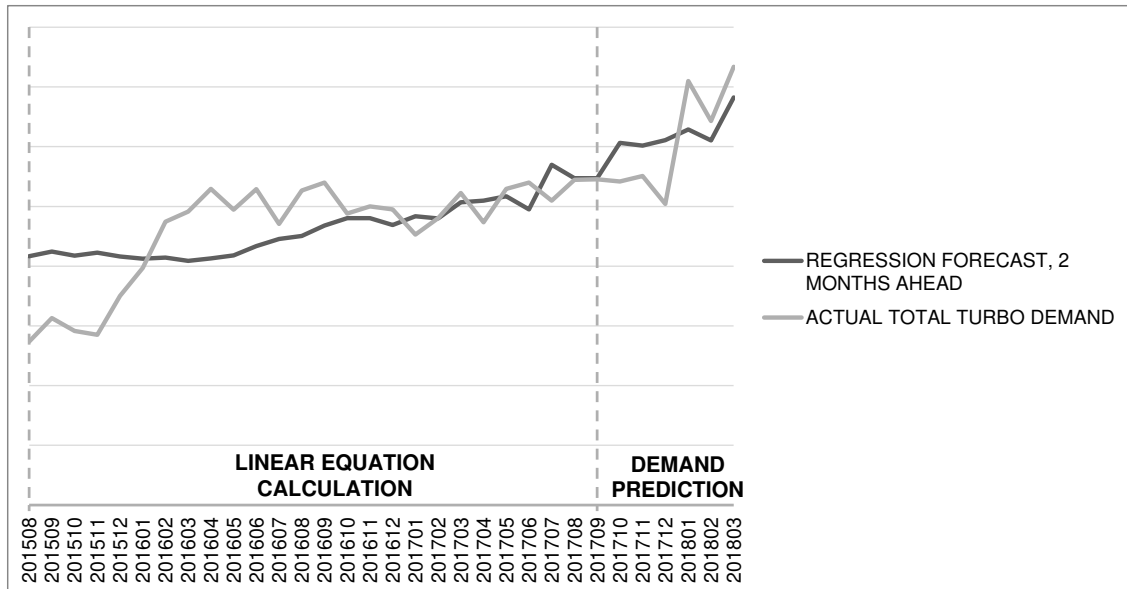

Figure 5.3: Regression analysis between D1A9Z and total turbo demand from 2015/08 to 2018/03 with two months time horizon.

Figure 5.3 shows that the fault code D1A9Z can predict the demand of total turbos well, the MAPE (calculated on the last six months where the regression model is used to predict demand) is roughly 11 %. Based on this, a belief was created that the individual turbo part numbers are able to be predicted with the fault code D1A9Z on a time horizon of two months.

A similar approach was tested for the total demand of batteries. A fault code, D1AD9, was found with a description containing the word *battery*. The highest correlation between occurrence of D1AD9 and total battery demand is on a time horizon of two months. However, due to the erratic nature of the battery demand, and the spike in demand in the beginning of 2018, no good prediction of the demand could be found, the MAPE is roughly 40 %. Figure 5.4 shows the result of the regression analysis between the fault code D1AD9 and total battery demand with two months time horizon. One of the main reasons for the poor performance is the missed rapid increase in demand in the beginning of 2018. The increase might be classified as a outlier and thus disregarded in the forecast. One explanation to it might be a potential promotion of batteries, which lead to an unforeseen rise in demand. However, after inquiring the subject no explanation that neither support the promotion theory nor in any other way explains the increase was found. Additionally, calculations using Tukey's fences, as per Tukey (1977), were made on one year of demand data to determine whether the demand increase could be classified as an outlier or not. The calculations showed that the months in the beginning of 2018 with increased demand are not outliers.

Consequently, the demand spike in 2018 was not seen as an outlier and was considered in the forecast.

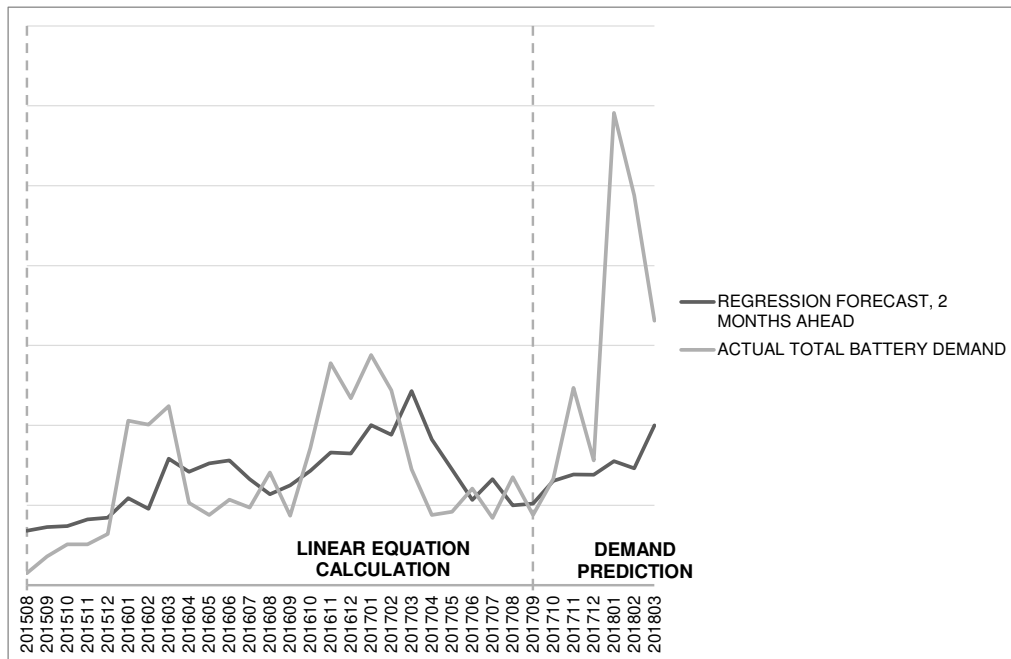

Figure 5.4: Regression analysis between D1AD9 and total battery demand from 2015/08 to 2018/03 with two months time horizon.

Moreover, due to the poor performance of the prediction with fault code D1AD9 additional tests were conducted for batteries. The fault codes with a correlation coefficient over 0.70 with the total battery demand were tested. However, all of the tested fault codes performed poorly and were unable to predict the demand increase in beginning of 2018, see Figures 5.5, 5.6, 5.7 and 5.8 for illustrations of performed analyses. The poor performance is due to the low causal effect between fault code and demand. This is the case even though the correlation between the two is high. This is in line with Barrowman (2014) who stated that correlation does not necessarily imply a causal relationship. Moreover, several tests were conducted on individual part numbers to validate the findings that there is a low causal effect between considered fault codes and battery demand. The conclusion of the tests were that the statistical measurements and forecast accuracy indicate that the fault codes can not accurately predict battery demand. Consequently it was deemed that the considered fault codes are unable to predict the considered battery demand. However, it is still believed that the battery demand might be predicted by fault codes which are not within the considered scope.

5. Result & Analysis

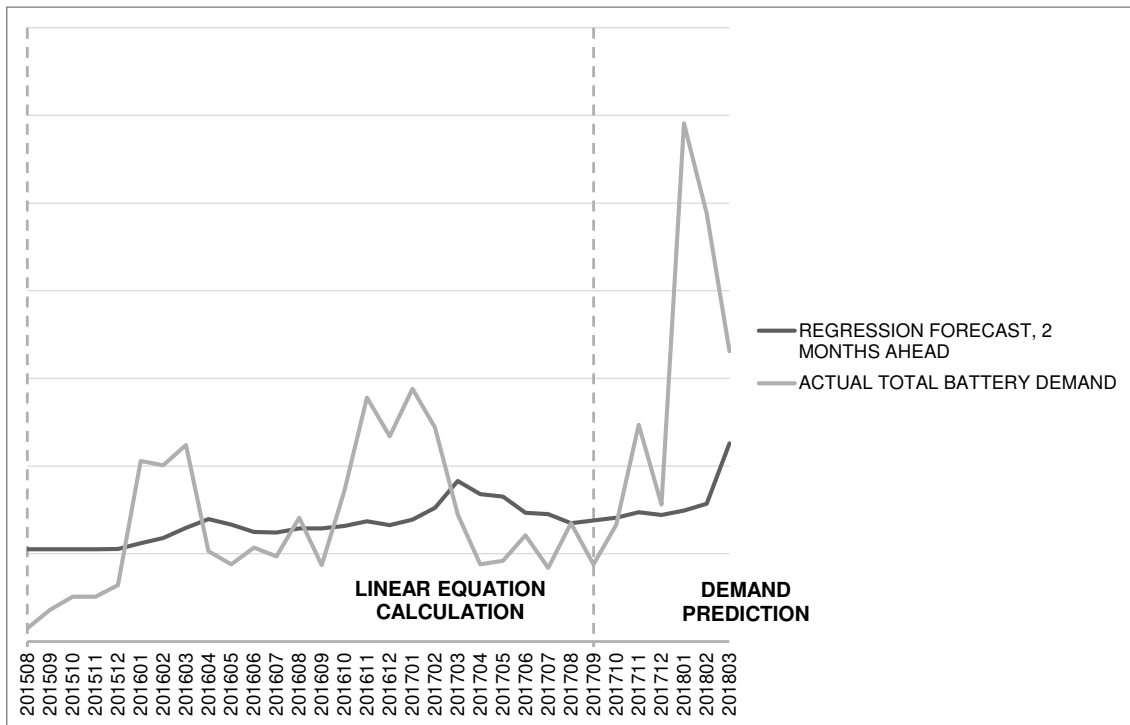

Figure 5.5: Regression analysis between D1CXH and total battery demand from 2015/08 to 2018/03 with two months time horizon.

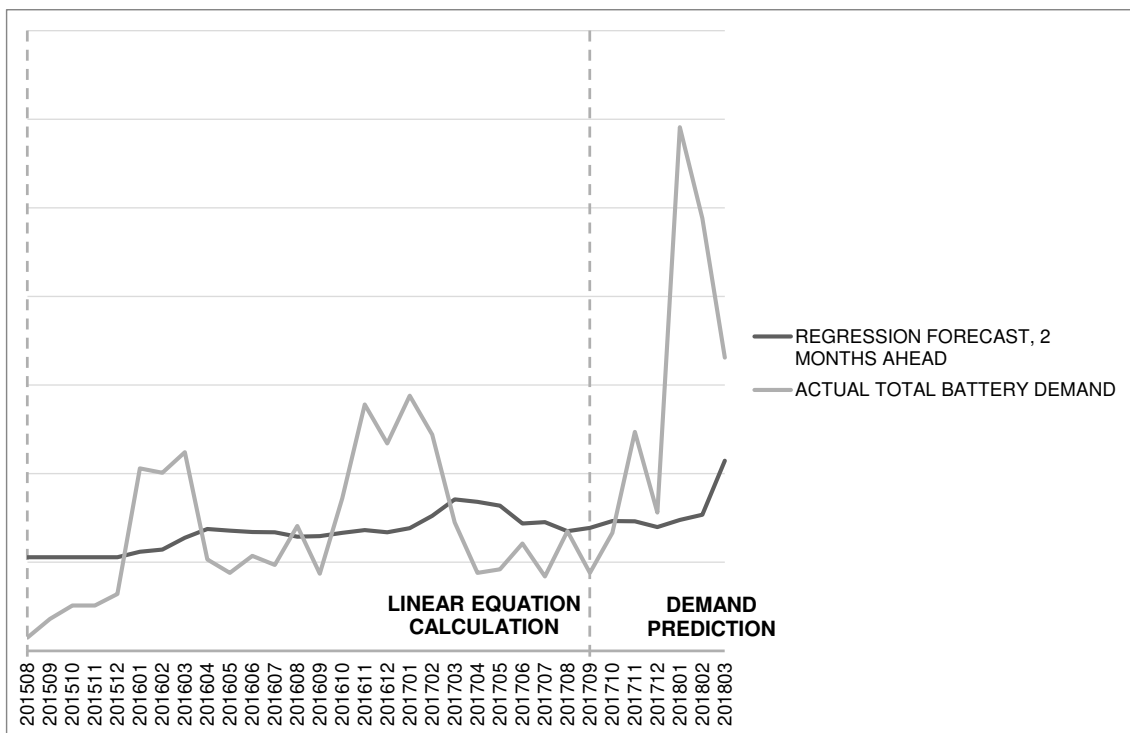

Figure 5.6: Regression analysis between D1CVH and total battery demand from 2015/08 to 2018/03 with two months time horizon.

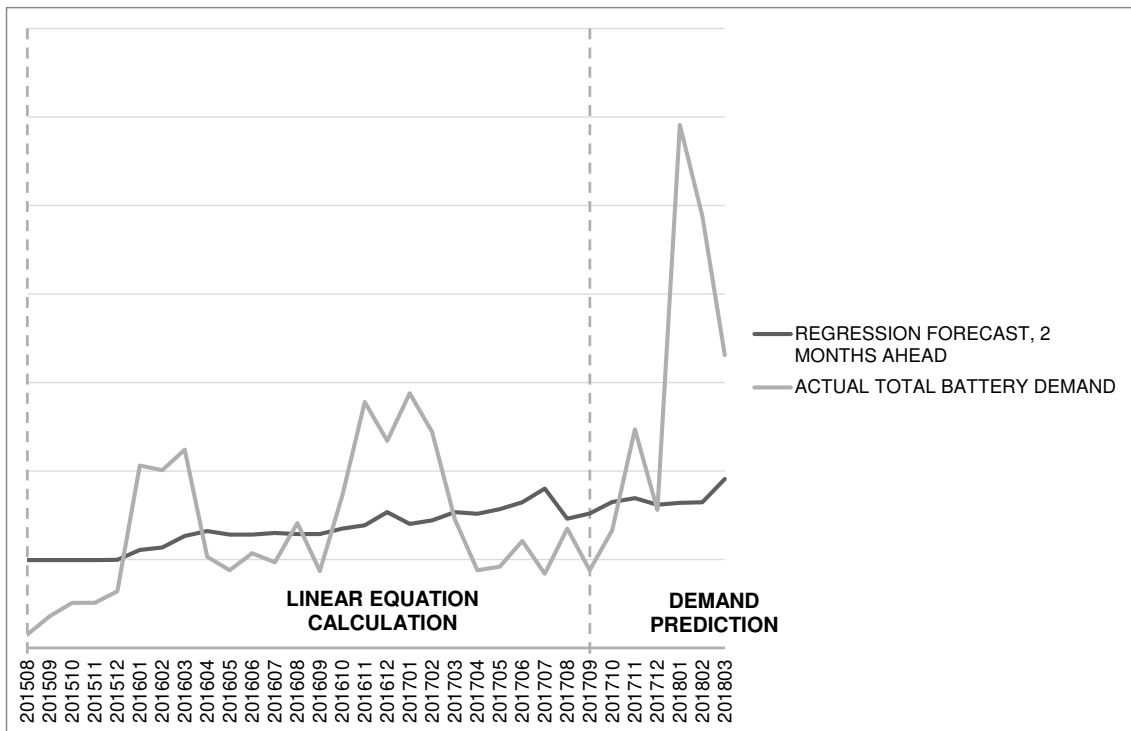

Figure 5.7: Regression analysis between D1B4H and total battery demand from 2015/08 to 2018/03 with two months time horizon.

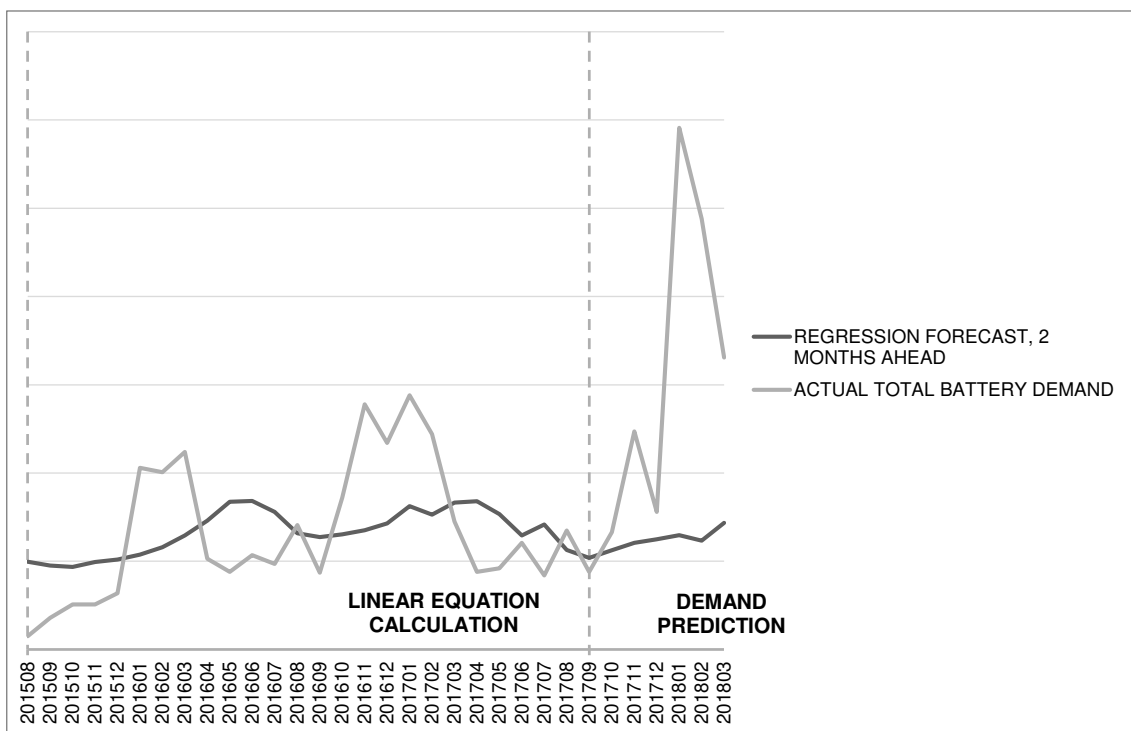

Figure 5.8: Regression analysis between D1A98 and total battery demand from 2015/08 to 2018/03 with two months time horizon.

5.4.2 Analysis on Part Number Level

Regression analyses could not be conducted for all different combinations of parts and fault codes due to time limitations. In order to test and evaluate the potential effects on forecast performance when using fault code based forecast, it is enough to analyze a small selection of part numbers. Moreover, a focused selection allows for deeper interpretation and discussion of results. Therefore, a limited amount of individual parts were analyzed extensively. The parts were chosen and prioritized based on strength of correlation, i.e. the regression analyses were conducted for parts and fault codes with the highest correlations. As such, several regression analyses were conducted for the three turbos with the highest average correlation. These parts have part numbers 85020372, 85013511 & 85013758.

Based on the findings that total turbo demand can be predicted well with a single fault code, an approach was created for testing the different parts. The turbos 85020372, 85013511 & 85013758 were all tested by using an iterative learning strategy, where tests were conducted to gain understanding about where the best results are likely to be found. In line with the opinions of Jawlik (2016) and Kraha et al. (2012), the number of predictors are kept low. However, even though faults codes are correlated internally, multiple fault codes were tested as the resulting forecast for future periods sometimes shows to be more accurate when more predictors are considered. This led to the creation of an analysis approach where a satisfactory result would be found for all three parts. The approach is based on the belief that turbo demand should be explained by D1A9Z on a time horizon of two months, and that high correlation coefficients could imply high causality. The steps of the approach are as follows:

1. Perform regression analysis with D1A9Z on two months horizon
2. Perform regression analysis with D1A9Z and the fault code with highest correlation coefficient on two months horizon
3. Perform regression analysis with the fault code with highest correlation coefficient on three months horizon
4. Perform regression analysis with the fault code with highest correlation coefficient on four months horizon
5. Perform regression analysis with the fault code with highest correlation coefficient on five months horizon

In Table 5.4, results of regression analyses for the three turbos using the created approach are presented.

Table 5.4: Results of conducted regression analyses on individual turbos.

Part	Code	Horizon	MAPE (%)	Mult. R	R ²	Adj. R ²	F
85013511	D1A9Z	2	19.33	0.939	0.882	0.877	1.24E-12
85013511	D1A9Z & D1A9P	2	16.11	0.945	0.893	0.883	7.07E-12
85013511	D1A9Z	3	21.97	0.941	0.886	0.881	2.51E-12
85013511	D1BSQ	4	10.39	0.911	0.831	0.823	6.00E-10
85013511	D1BSQ	5	6.28	0.889	0.790	0.780	1.46E-08
85020372	D1A9Z	2	5.53	0.447	0.200	0.158	4.21E-02
85020372	D1A9Z & D1ARK	2	4.74	0.468	0.219	0.132	1.08E-01
85020372	D1ARK	3	11.14	0.475	0.226	0.185	2.92E-02
85020372	D1AQO	4	10.15	0.315	0.099	0.052	1.64E-01
85020372	D1AQO	5	10.36	0.272	0.074	0.025	2.32E-01
85013758	D1A9Z	2	47.06	0.696	0.485	0.463	7.81E-05
85013758	D1A9Z & D1A98	2	43.48	0.727	0.529	0.488	1.73E-04
85013758	D1BSQ	3	49.32	0.592	0.350	0.322	1.83E-03
85013758	D1A9Z	4	48.79	0.639	0.408	0.381	7.81E-04
85013758	D1BSQ	5	48.44	0.554	0.307	0.274	6.10E-03

From Table 5.4, statistical outputs from the regression analyses, as well as a measure (MAPE) of the forecast accuracy for the forecasted period of 2017/09 to 2018/03 are presented. As per Jawlik (2016), the purpose of conducting regression analysis is to accurately predict the future outside the period where the regression forecast is tuned. Moreover, according to Nimon et al. (2010), multicollinearity complicates the determination of the effects of individual predictors. The thesis purpose is not to determine the exact effects of individual fault codes, but to explore the effects on forecast accuracy. Based on this, the most important factor to evaluate the quality of regression is deemed to be MAPE, since it measures the forecast performance.

In Table 5.4, it is shown that for part 85013511, the best forecast was found with the fault code D1BSQ on the time horizon of five months. On this horizon the forecast MAPE was relatively low with the value of 6.28 %. Notably, the forecast with code D1BSQ on the horizon of five months is also the forecast which has the least satisfactory values on the statistical measurements. However, the statistical measurements are still relatively good with a low significance of 1.46E-08 and a high adjusted R² of 0.780. Furthermore, with the same logic as described above, i.e. that the thesis primarily aims to explore the effects on forecast accuracy, improvements in MAPE are the most interesting values to focus on. It is therefore still seen as a good result. For part 85020372, R² is relatively low for all regression analyses conducted. This is due to that it was discovered that the part 85020372 substituted another part in the beginning of 2016. In order to handle this, demand for the substituted part was added to the demand of 85020372 before the regression analysis was conducted. Consequently, R² was reduced and significance was increased. The forecast with D1A9Z and D1ARK on two months horizon performed best with a MAPE of 4.74 %.

For part 85013758 it can be seen that the statistical measurements of the regression analyses are varied for the different cases. The regression forecast based on fault codes D1A9Z & D1A98 on two months horizon has the lowest MAPE of 43.48 %. The same forecast also produces the best results in terms of R^2 and adjusted R^2 with 0.529 and 0.488 respectively.

5.5 Comparison with Current Forecast

In order to further evaluate the quality of the regression forecast a comparison to the currently used forecast was made. The current forecast is produced by a system, and based on historical demand data. The system uses different demand flags in order to use optimal forecast methods, and the forecasts it produces are therefore seen as fair representations of a time-based forecasts.

Before the different forecasts can be compared some adjustments needs to be made. Since the system produced forecast is in 13 periods of four weeks each, whereas the regression based forecast is in months, one of the forecasts had to be converted. This was done by converting the periods in the system made forecast to months. Moreover, the system forecast on CDC-level has a wider scope than the regression produced CDC forecast. More precisely, the system forecast considers everything that goes out from the Central Distribution Center whereas the regression forecast only considers parts that are sold at European dealers. Consequently, the different forecasts had to be converted to a common level in order for a comparison to be made. This was conducted by calculating the sum of the demand for the whole period considered (2015/06-2018/03) on both CDC-level and dealer-level. These sums where then divided in order to produce a conversion ratio, C , for each article, see Equation 5.1.

$$C_a = \frac{\sum DD_a}{\sum DC_a} \quad (5.1)$$

Where:

DC: CDC Demand

DD: Dealer Demand in Europe

a: Article

Table 5.5 shows the calculated conversion ratios for the evaluated parts. The ratio can on average be seen as roughly 70 % for the parts which implies that the dealer sales constitute to a clear majority of the CDC demand. However, it can also be seen that the roughly 30 % remaining does not constitute to sales at European dealers. These 30 % can be explained by two arguments. Firstly, not all of the CDC demand is created in Europe as a share of demand originates from dealers outside Europe. Secondly, buildup of stock at dealers, RDC and SDC creates an imbalance

between CDC and dealer demand. This imbalance for the studied parts can partly be explained by increased stock levels due to substitution of parts and thereby increased demand. Which is the case for part 85013511 & 85020372 where the demand has increased during the observed period due to substitution. However, this increase in demand is only marginal and should not affect the overall inventory levels considerably. Moreover, the part 85013758 did not substitute any part during the observed time period but still has a conversion coefficient of 0.55. This is explained by a larger portion of this part being sold outside of Europe.

Table 5.5: Conversion coefficients for evaluated parts.

Part	Conversion Coefficient
85013511	0.8024
85020372	0.7929
85013758	0.5484

After converting the system made CDC forecast to the same level as the regression forecast by multiplying with the conversion coefficients, MAPE for the different forecast on months 2017/10 to 2018/03 could be compared. Table 5.6 shows a comparison of the different forecast methods' MAPE for the analyzed parts and time horizons.

Table 5.6: Comparison of MAPE between regression forecast and system forecast.

Part	Code	Horizon	Regression MAPE (%)	System MAPE (%)
85013511	D1A9Z	2	19.33	25.23
85013511	D1A9Z & D1A9P	2	16.11	25.23
85013511	D1A9Z	3	21.97	36.95
85013511	D1BSQ	4	10.39	47.51
85013511	D1BSQ	5	6.28	51.58
85020372	D1A9Z	2	5.53	10.66
85020372	D1A9Z & D1ARK	2	4.74	10.66
85020372	D1ARK	3	11.14	10.56
85020372	D1AQO	4	10.15	11.66
85020372	D1AQO	5	10.36	12.95
85013758	D1A9Z	2	47.06	43.76
85013758	D1A9Z & D1A98	2	43.48	43.76
85013758	D1BSQ	3	49.32	50.53
85013758	D1A9Z	4	48.79	52.79
85013758	D1BSQ	5	48.44	50.82

It can be seen in Table 5.6 that the regression forecast based on fault codes has a lower MAPE in a majority (13/15) of presented analyses. The highest regression MAPEs can be found for part 85013758 for which all the MAPEs are over 40 %. However, the system MAPE on the same horizons are on similar levels. Moreover, the best regression MAPE for all three parts respectively is better than the

corresponding system MAPE. For part 85013511, the regression MAPE is significantly lower than the system MAPE on time horizons four and five months. Similarly, for part 85020372, the regression MAPEs with fault code D1A9Z and fault codes D1A9Z & D1ARK respectively are significantly better than the system MAPE on two months horizon. Moreover, for all three parts the regression MAPE on two months horizon is lowered when an additional fault code is included.

MAPE is seen as the most important factor for evaluating quality of regression. Therefore, for each of the parts, the regression forecast with the lowest MAPE is compared with the actual demand and system calculated forecast. This comparison is illustrated in Figures 5.9, 5.10 and 5.11. In the 'Linear Equation Calculation'-areas, the regression based forecast is tuned for the occurrence of fault code and part demand by minimizing the mean square error. In the 'Demand Prediction'-area, the regression based forecast is tested on subsequent fault code data, and compared with actual demand as well as system based forecast.

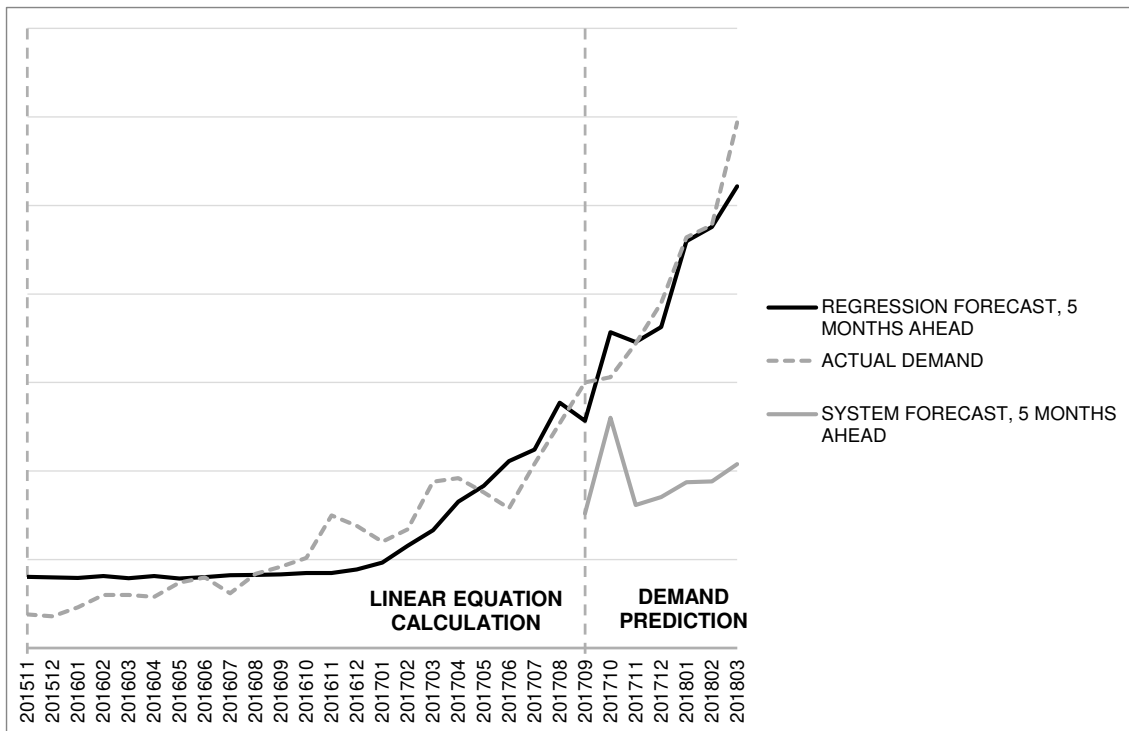

Figure 5.9: Comparison between forecast based on fault code D1BSQ five months ahead of time, the system generated forecast five months ahead of time and actual demand of the turbo part 85013511.

In Figure 5.9, it can be seen that the system forecast five months ahead has not been able to predict the increased demand trend of part 85013511. Notably, the forecasting system has flagged the item as positively trending and taken actions accordingly. However, the large amplitude of the trend is not realized in time by the system why the forecast still misses the up-rise in demand. On a shorter time horizon, the system forecast performs notably better but is still unable to follow the strong positive trend. The regression forecast, however, manages to predict and

follow the strong increasing trend of demand. Even though the demand increases by approximately 100 % during months 2017/10 to 2018/03, the regression forecast has a good performance.

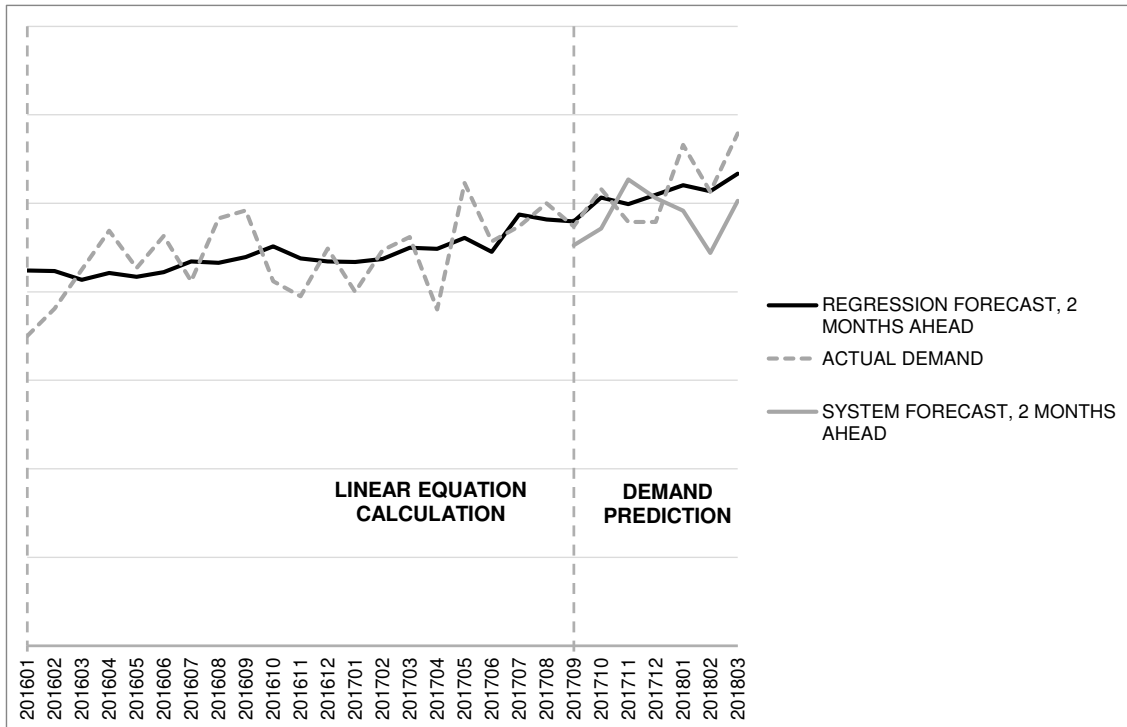

Figure 5.10: Comparison between forecast based on fault codes D1A9Z and D1ARK two months ahead of time, the system generated forecast two months ahead of time and actual demand of the turbo part 85020372.

In Figure 5.10, it is shown that the part 85020372 has a somewhat erratic demand, with a small positive trend. The system has marked the item as 'fast' and is therefore predicting the demand with moving average of previous periods. Due to this, the system forecast two months ahead lowers its demand prediction for 2018/02 because the demand in 2017/11 and 2017/12 dropped to a slightly lower level. In contrast, the regression forecast manages to follow the demand trend more stably, without amplifying the fluctuations.

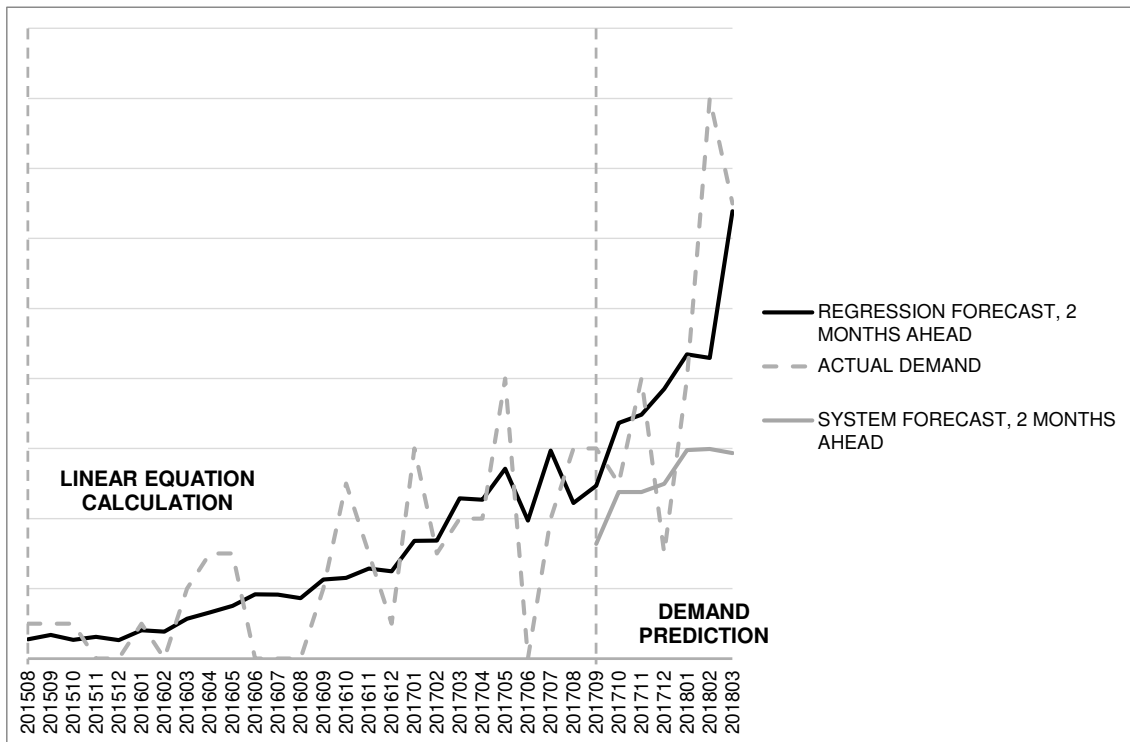

Figure 5.11: Comparison between forecast based on fault codes D1A9Z & D1A98 two months ahead of time, the system generated forecast two months ahead of time and actual demand of the turbo part 85013758.

Figure 5.11, shows that the actual demand of part 85013758 is both intermittent and trending. During the period 2017/09 to 2018/03 a noticeable increase in actual demand is seen. The regression based forecast manages to follow the increasing demand trend, without being as volatile as the actual demand. Notably, the system forecast for part 85013758, which has an equivalent MAPE, under-forecasts almost consistently during the period 2017/09 to 2018/03 due to a large demand increase, thereby producing a systematic error. In contrast, the regression based forecast evens out fluctuations, and thereby does not have a systematic error. When systematically under-forecasting there is a risk of back orders. As the part is critical for customer up-time, back orders should be avoided to ensure customer satisfaction. Therefore, the regression forecast is seen as the better alternative.

6

Discussion

In this chapter, the analysis and results of the thesis are discussed and interpreted. Firstly, the findings are reviewed and compared with forecasting and maintenance literature. Secondly, a discussion is made about links between different measurements in the results. Thirdly, implications of findings for the case company are discussed. Lastly, underlying assumptions and limitations within the study are presented and scrutinized.

6.1 Forecasting and Maintenance

Performing corrective maintenance means that a reaction has to be made to an unscheduled event causing a failure (Tsang, 1995). Causal-based forecasting methods use explanatory variables, whereas in time-based methods, the forecast is based solely on historical demand (Boylan and Syntetos, 2008). Thereby, the forecast based on fault code data used in the thesis is a causal-based forecasting method. As showed by the results of the analysis, the forecast based on fault codes *predicts* future demand trends whereas the forecast based on historical data *reacts* to previous demand trends. A link can be seen between issues that arise when reacting to unscheduled failures through corrective maintenance and reacting to future changes in demand trends which are unexplained by historical trends. Costs of corrective maintenance are high due to that equipment has to be repaired under crisis conditions and that there is lost production for the customer (Tsang, 1995). Similarly, for all parts, the historical demand forecast reacted to historical demand which was not indicative of the future demand trend, thereby causing a need for unscheduled orders and transports throughout the supply chain. Unscheduled transports through day orders or Vehicle Off Road (VOR) orders are more expensive than standard orders placed well in advance. Therefore, it can be seen that using a causal-based forecast can reduce costs compared to a time-based forecast similarly to how predictive maintenance reduces costs compared to corrective maintenance. Moreover, VOR and day orders are occasionally transported with less environmentally friendly transportation modes (taxi or airfreight). The choice of transportation mode by companies has a large influence on whether environmental sustainability policies are able to reach their targets (Bask and Rajahonka, 2017). Thus, a positive impact on environmental sustainability could also be achieved if a causal-based forecast is used.

Additionally, the fault code based forecast can also be seen to have an positive environmental impact as the increased forecast accuracy will lead to less return transportation and less scrapping due to obsolescence.

As mentioned by Cohen et al. (2006), forecasting of items with intermittent demand is especially difficult. Additionally, Boylan and Syntetos (2008) argues that intermittent demand decreases the performance of time-based forecasting methods. Even though spare part demand often is described as erratic and intermittent, see for instance Dekker et al. (2013), the demand patterns found in the result are mainly erratic and not as intermittent as expected. This can be explained by the aggregation of the demand data. Even though each dealer is experiencing highly intermittent demand patterns an aggregation over the whole population of dealers in Europe makes the demand less intermittent and more stable. However, for one part, 85013758, the demand is intermittent even on a CDC-level. For this item, both forecast methods have problems predicting the intermittent demand, with MAPEs of over 40 %, which is in line with the difficulty highlighted by Cohen et al. (2006). As such, it can be noted that even though the causal-based method follows the demand trend, it is not sensitive enough to exactly predict intermittent and small scale demand fluctuations. If different explanatory variables and/or different combinations of variables are explored, there is a possibility of matching the mentioned fluctuations.

Another explanation of why the evaluated causal-based method can not exactly predict fluctuations is that the predictor, in form of the fault code, is able to predict the "actual demand" of the part on a certain time horizon and thereby follow the demand trend. However, the erratic nature of the demand is due to behaviour of the customer. More precisely, the customers are not entirely dictated by their truck's need for service, and they might not service their truck when it is required. Instead, if the part has not already broken down, they decide when to service their vehicle, which causes differences in the time horizon between fault code occurrence and part demand for individual customers. Thereby, the demand for the part arises when the customer chooses to service their truck, rather than when it is actually required, thus creating the erratic demand. Consequently, the forecast is able to predict the trend which is caused by the fault codes but not the exact fluctuations since they are dependent on customer behaviour. Exact effects of customer behavior is not mapped in the thesis, however it would be an interesting aspect to research in the future. If a shift toward CBM is conducted where customer service follows a predefined schedule based on condition monitoring data, the demand fluctuation effects of customer behavior could be reduced and forecast accuracy increased.

In the results, it can be seen that most developed causal-based methods perform better compared to the currently used time-based forecast methods in terms of MAPE. This might be explained by strong increasing trends for parts 85013511 & 85013758 which are typical for parts in the initial part of their life-cycle. This is in line with Boylan and Syntetos (2008), who claim that causal-based methods perform better than time-based in the initial part of their life cycle. However, the causal-based methods also perform better for part 85020372 which is not in the

initial part of its life-cycle. Consequently, the better performance of the causal-based forecasting method can not be explained solely by the life cycle of the parts. A common attribute for all three parts is that their demand is increasing, which indicates that the causal-based forecast is appropriate for parts with a weak or strong positive trend.

6.2 Links Between Measurements

In the results, it can be seen that high correlation between fault code occurrence and spare part demand does not always imply that there is a causal relationship between a given fault code and demand. This is in line with Barrowman (2014) who means that correlation does not necessarily imply a causal relationship. However, some of the explored high correlations have resulted in high performing causal-based forecasting models. Thereby, analyzing correlation can be used as a sub-step towards finding meaningful relationships. Similarly, a strong explanatory power (high value of adjusted R^2) and low significance value do not necessarily mean that a low MAPE will be achieved. This is due to that the MAPE calculations are made on periods after 2017/09, whereas the regression calculations are made on periods prior to that. If both calculations were made on the same periods, there would have been a stronger connection between adjusted R^2 and MAPE.

For all studied system forecasts, MAPE is generally improved as the forecast horizon is lowered, i.e. the system forecast on a short horizon has a lower MAPE than the forecast on longer horizon. This is a natural effect of the historical structure of the time-based forecasting methods used in the system. The time-based methods uses calculations on historical values in order to predict the future, which leads to a decreased uncertainty as the time horizon approaches the forecasted period. In contrast, the same pattern of increased forecast accuracy as time horizon is reduced is not observed for the regression based forecasts. This is likely due to that the causality of fault codes on part demand is strong for certain time horizons. However, strong causality on a given time horizon does not necessarily imply strong causality on all horizons. In other words, it is possible to have a strong causality on a long time horizon and a weak causality on a shorter time horizon. Thereby, the uncertainty of the causal-based forecast does not always increase as the forecasting horizon increases. Consequently, if the causal relationship is strongest at a specific time horizon, the accuracy of forecast will be equal on all time horizons shorter than that time horizon.

6.3 Implications of Findings

Forecasting of spare parts is difficult due to breakdowns being difficult to predict, and due to demand not being stable (Cohen et al., 2006; Willemain et al., 2004). When a company acts reactively, costs are high due to a loss in customer's production and parts having to be restored under crisis conditions (Tsang, 1995). The findings that spare parts demand can be predicted more accurately by use of fault codes implies that if the forecasting process activities at Volvo are changed, availability can be

increased and/or supply chain costs reduced. Using this logic, the thesis findings could have several implications for the case company, namely on the forecasting process activities and the related aspects part availability, stock levels and supply chain interactions. Those implications are presented and discussed below.

6.3.1 Implications on Forecasting Process Activities

Findings from the thesis were discussed with forecasting experts at FOIP, and a suggestion of modified forecasting process charts were developed in consultation with said forecasting experts. Implications of the forecasting process are divided into two different time perspectives; one short term perspective and one long term perspective. Those perspectives are presented in detail in the following subsections.

Short Term Implications

In the short term, the causal-based forecasting concept should initially be followed-up and evaluated for a longer time period. This means that the forecast for selected parts are manually handled and evaluated. In the forecasting process at Volvo, this affects manual activities performed and disconnects the system activities from determining the forecast. More specifically, analyzing forecast related data changes to have fault code inputs as a principle part of analysis. In Figure 6.1, a new process chart, which handles fault code based forecast is presented.

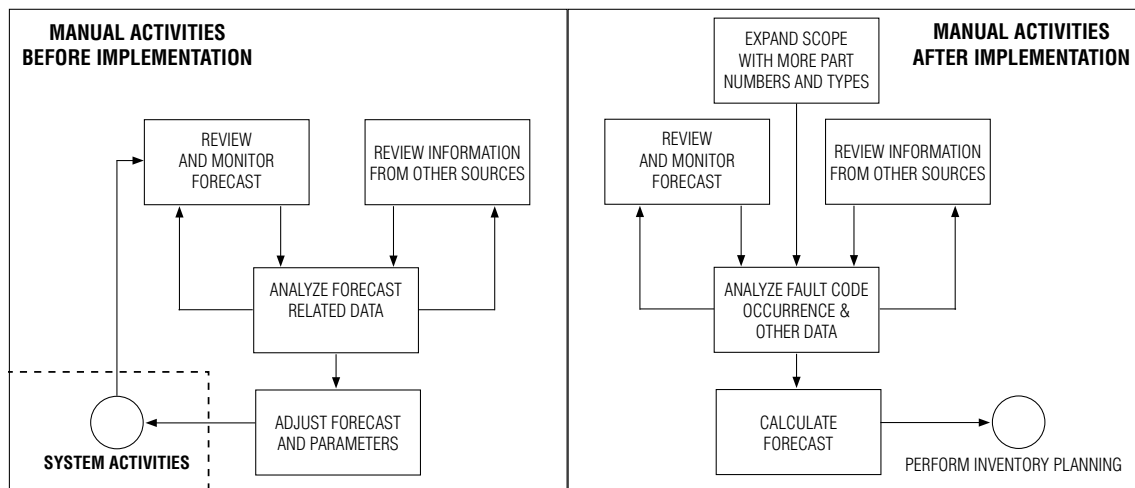

Figure 6.1: Illustration of how the forecast process at Volvo could change, for selected parts, in the short term with an implementation of forecasting based on fault code occurrence.

Initially, the part types considered for fault code based forecast are the analyzed turbos, however as time progresses additional parts and part types are analyzed and included if connections between fault codes and demand are found. A prioritization is made on parts with an increasing trend, as it has been shown by the results in this thesis that fault code based models perform well compared to time-based models for such parts. Moreover, in order to ensure optimal performance, the regression

forecast is continuously monitored, re-evaluated and optimized as time passes. A re-calculation of the coefficients in the linear regression forecasts is performed on a frequency equal to the currently used process or if the forecast quality would drop below the quality of a forecast based on historical demand. In Figure 6.1, all activities are performed continuously and iteratively except 'Calculate Forecast', which is done once every month.

Long Term Implications

In the long term, i.e. in a couple of years, the concept could be implemented in the automatic system activities if the short term implementation has shown promising results over a longer period of time. Thereby, forecasts based on fault codes would become a natural part of the forecasting process at Volvo. In order for this to happen, more parts, part types & fault codes are included in the scope continuously as connections between fault codes and spare part demand are proven. The system activities in the process chart would then be changed so that articles within part types where demand is affected by fault codes are forecasted based on fault code occurrence. This changed process chart is illustrated in Figure 6.2. Depending on which type of forecasting model, fault code based or historical based, the manual activities are performed differently. The difference is that analyzed data is either fault code data or historical demand data, depending on which type of model is used. Similarly to the short term perspective, the system re-calculates the coefficients of regression forecasts continuously, in order to ensure optimal performance.

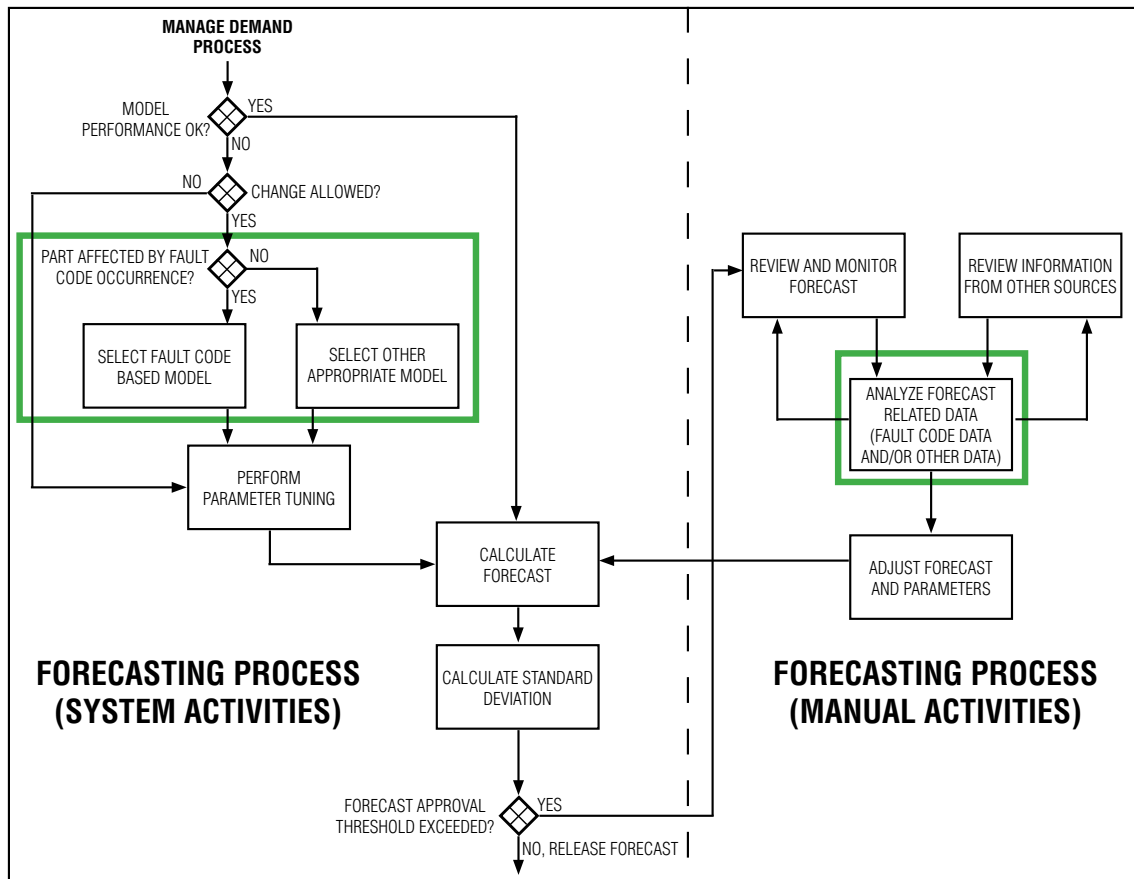

Figure 6.2: Illustration of how the forecast process at Volvo could change to in the long term with an implementation of forecasting based on fault code occurrence. Changes to the current process are highlighted within the green boxes.

6.3.2 Implications on Availability and Stock

For the selected parts, a forecast will be created on a monthly basis. In the beginning of a new month, fault code data is gathered to be used in forecasting. As the time horizon for the regression forecasts are 2, 2 and 5 months respectively, the forecast will be set 2 or 5 months ahead of time. A comparison for the three parts between their lead times from supplier to dealer and the time horizon of their regression forecast is presented in Table 6.1.

Table 6.1: Forecast horizon and lead time for evaluated parts. The lead time includes a two week transportation time from CDC to dealer.

Part	Forecast Horizon	Lead Time
85013511	5	1.5
85020372	2	2
85013758	2	1.75

As can be seen in Table 6.1, the studied parts all have lead times from supplier to dealer which are shorter or equal to the amount of months ahead the regression

forecast predicts. This means that it will be possible to place orders from the supplier which can arrive at the CDC before the truck is serviced and demand triggered. Thereby, availability is increased on a CDC level and truck drivers do not have to wait as long for delivery of parts since the waiting time from supplier to CDC is removed. Additionally, there is enough time to move the parts from CDC to dealer which would increase the customer experienced availability. However, the forecasting method presented in this thesis does not predict how many parts each specific dealer requires. That being said, there are currently systems and operations in place with the purpose to predict how many parts should be moved from CDC to each specific dealer. As long as the availability at CDC is high, these systems should be adequate to distribute the parts to dealers. Furthermore, the long forecasting horizon would also enable a higher usage of stock orders instead of day orders as well as VOR orders. This change in order types would constitute to considerable savings since stock orders are many times cheaper than VOR and day orders. Consequently, changing to fault code based forecasting, for the evaluated parts, could lead to cost savings as well as increased availability and customer experienced availability.

When ensuring that the service level, which is a measurement of availability, is kept at a desired level, the size of required safety stock is affected (Jonsson and Mattsson, 2009). One service level definition is based on demand fill rate and can, according to Jonsson and Mattsson (2009), be explained as the percentage of customer demand which can be satisfied directly through inventory. In order to exemplify potential effects on service level and safety stock by using the causal-based forecast, calculations were made based on demand fill rate service level equations used in forecasting systems. The equations used in calculations are presented in Appendix B. Two scenarios were explored: Firstly, it was determined how the service level would be affected by using the causal-based forecast compared to the time-based and keeping the safety stock at the current level. Secondly, it was determined how the required safety stock would be affected when keeping the desired service level at the current level. In Tables 6.2 and 6.3, the results of calculations for the two scenarios are presented.

Table 6.2: Resulting changes in service level when using the causal-based forecasts compared to the time-based, and keeping the current safety stock.

Part	Service Level Causal-Based	Service Level Time-Based	Change (Percentage Points)
85013511	98.30 %	19.06 %	79.24 %
85020372	99.93 %	97.27 %	2.66 %
85013758	93.68 %	65.03 %	44.06 %

In Table 6.2 it can be seen that if the current safety stock is kept fixed, usage of the causal-based forecasts would result in higher service levels compared to the time-based forecast. This is especially prominent for parts 85013511 and 85013758 where the change is above 80 and 40 percentage points respectively. Moreover, all causal-based forecasts would result in a service level above 93 %. Consequently, it

is determined that service level, i.e. availability, can be increased significantly by using the causal-based forecast.

Table 6.3: Resulting changes in required safety stock when using the causal-based forecasts compared to the time-based, and keeping the current desired service level.

Part	Change in Safety Stock
85013511	-98.16 %
85020372	-83.36 %
85013758	-49.74 %

Table 6.3 shows that if the current desired service level is kept fixed, usage of causal-based forecasts would result in lower required safety stock compared to the time-based forecast. The potential safety stock reductions are significant for all evaluated parts, with the largest reduction being over 98 %. Thereby, it is shown that usage of causal-based forecast can lead to considerable reductions in safety stock levels.

As can be seen in Tables 6.2 and 6.3, part 85013758 has prominent potential improvements in either safety stock or availability through using the causal-based forecasts. These results are deemed unintuitive as the improvement in MAPE when using the causal-based method compared to the time-based method is merely 0.28 percentage points for that part. The reason why the potential improvements in safety stock or availability are high is that the equations behind Tables 6.2 and 6.3 use a smoothing constant of 0.2 which applies more weight on later months. The time-based forecast for part 85013758 under-forecasts notably for the latest months whereas the causal-based method forecasts more accurately for the latest months. Thereby, potential improvements in availability or safety stock are high when using the causal-based forecast. In order to examine the effects of applying less weight to later months, additional calculations were made with lower smoothing constants values (0.1 and 0.05 respectively). The results of safety stock and service level calculations using smoothing constant values 0.1 and 0.05 show that when applying less weight on later months, potential improvements for all three parts are smaller, however still significant. The results of calculations with smaller smoothing constants are presented in detail in Appendix C.

6.3.3 Implications on Supply Chain Interactions

By changing from a forecast based on historical demand to a forecast based on condition monitoring, the supply chain interactions will change. In the case of forecast based on historical demand, the different actors in the supply chain act mainly on the information given by their downstream actor. Such behavior, according to Panda and Mohanty (2013), enables and creates risk of stock-ups, shortage gambling and bull-whip effects throughout the supply chain since the different actors are acting on aggregated demand which might be distorted. Bull-whip effect is when demand order fluctuations are amplified as information moves up the supply chain(Lee et al., 1997). By basing the forecast on the real

customer demand, in form of the condition of the trucks, the supply chain becomes more responsive and causes the actors to act on more updated information. Thereby, a form of point-of-sales data is used, which according to Lee et al. (1997) reduces the risk of bull-whip effects. Symptoms of bull-whip effects include inefficiencies and problems such as increased difficulties in calculating forecasts, unnecessarily high stock levels, and low availability (Lee et al., 1997). Thereby, by reducing the risks of bull-whip effects through basing the forecast on condition monitoring information, the risk of experiencing inefficiencies within the supply chain is reduced. Figure 6.3 illustrates the changed information path after implementing an utilization of condition monitoring data for the general case. The illustration is a simplified picture of the real situation, as a few dealers are supplied directly from the CDC.

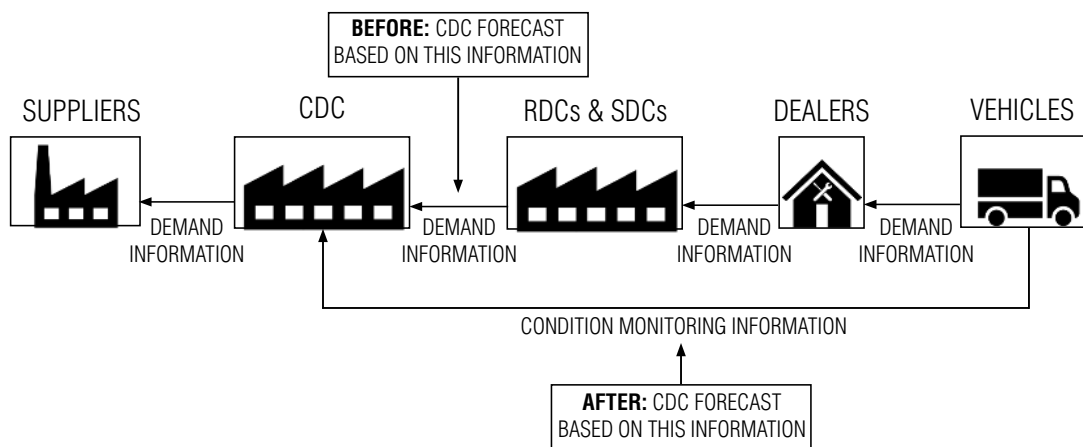

Figure 6.3: Simplified illustration of the demand information flow within the spare part supply chain before and after implementation.

6.4 Underlying Assumptions

It is assumed that the representativeness of the data that is used in the thesis is high. In other words, the data taken from different databases is assumed to be representative for the whole population. This is assumed even though the whole population might not be represented in the data. This would most likely change the different correlations coefficients and the causality found on different time horizons. However, this would probably not change the broader result, that customer demand can be predicted by fault codes. It would merely change to which extent different fault codes causes specific customer demand. In addition, the same databases used in the thesis are also used for forecasting purposes by other projects and teams within Volvo, which indicates that the databases are usable for forecasting intents.

Occurrence of fault codes are assumed to be evenly distributed between vehicle services. It could be argued that fault code occurrence should be more concentrated closer to the next service, since the vehicle has then been in operation for a longer period without being controlled. On the other hand, it could also be argued that the concentration of fault code occurrence should not be affected by a service instance as

all fault codes are not solved at every service. It can, in some examples, be seen that the fault code counter is reset in a vehicle by a service technician, after which the fault code continues to occur for that vehicle. As such, the assumption made is seen as the most reasonable considering the different arguments. The assumption affects the results since the focused time horizon is based on the average time between fault code occurrence and dealer demand. Thereby, the regression-based forecast would probably have different fault codes as predictors, and also result in a different forecast quality.

In cases where geography of dealer demand and/or vehicles could not be determined due to a lack of data, it is assumed that the location of the dealer or vehicle is in Europe. A calculation was made to calculate how many vehicles that send fault code data are within Europe. This calculation showed that over 96 % of vehicles where geographic location could be determined are within Europe. Based on this, it was determined that disregarding fault code inputs from vehicles without a determined geographical location would have a greater risk of removing wanted inputs than chance of removing unwanted inputs. Furthermore, Europe is the largest market for Volvo Trucks, thus a logical assumption is that most vehicles should be located there.

6.5 Limitations

A notable limitation for the thesis is that only three individual parts have been analyzed in detail. As such, the concept of forecasting using fault codes is shown to improve the forecast accuracy for all parts it was tested on. However a sample size of three is not enough to safely assume that it will function for all parts. Therefore, the concept has to be tested on more parts and fault codes in order to determine the general applicability. Moreover, the parts analyzed in detail are all turbochargers, i.e. of the same part type. For other part types, where a potential of predicting breakdowns by using fault codes has been found, it is not necessarily possible to create an improved demand forecast. The research conducted in this thesis is not enough to determine whether a fault code based forecast can be created for all part types. However, the findings show that there is a potential of creating such a forecast.

Another limitation for the thesis is that a limited amount of interviews were conducted. Thereby, it is possible that not all possible parts types were detected and evaluated in the thesis. As such, the scope of parts for which it is possible to predict future spare part demand by usage of fault codes might be larger than what is found in the thesis. However, this is only seen as a minor limitation as the interviewees have extensive knowledge within the subject. Moreover, since the thesis project is conducted as a case study at a single company, the generalizability is limited. Similarly, only one business area and one geographical area is considered in the thesis project which also might limit the generalizability. Thereby, the results presented in the thesis should not be seen as a general result which is applicable for all different scenarios and industries without any

adjustment. Instead the results should be viewed as an example of how condition monitoring could be used and what implications it might have.

The regression forecasts are limited to being tested for a time period of six months. There is a risk that the found associations between fault codes and spare part demand are random, which is reduced by the forecast comparison of six months. However, the risk is merely reduced by this, and a continuous follow up and evaluation for subsequent months is required to nullify the risk completely. Furthermore, it is possible to use all possible combinations of fault codes in multiple regression to forecast spare part demand. Merely a small subset of the possible combinations have been explored in the thesis due to time restrictions, and to facilitate a deeper analysis of evaluated parts. Consequently, the combinations which would result in the best possible forecast are not necessarily considered in the thesis.

7

Conclusion

In this chapter, the conclusions of the study are presented. The order of subsections is research findings, practical & theoretical contributions, recommendations & future research for the case company and future research within academia.

7.1 Research Findings

The research findings are presented through answering the thesis' research questions. Below, the research questions are stated followed by the answers provided by the thesis work.

- 1. For which spare parts at Volvo Trucks is there a potential to predict future spare part demand by usage of fault codes?*

Through the thesis, it was found that parts of certain types are appropriate for development of a causal-based forecasting method using condition monitoring data. At first, a list was created including part types where sensor data experts within Volvo Group believe there is a possibility of finding correlation between fault codes and spare part demand. The explored part types are batteries, nozzles, brakes, suspensions, gearboxes, tires, pumps, throttles, fuel control units, injectors, turbos and sensors. Furthermore, in order to focus on parts with high potential (where the economic benefit of improving forecast accuracy is maximized), the initial identified part types were filtered on certain criteria. Those criteria are criticality to up-time, active demand and high value. After the filtration, mainly turbos and batteries remained, and those part types are thereby believed to have a high potential of predicting future spare part demand by usage of fault codes.

- 2. How would usage of condition monitoring data for selected parts affect their forecast accuracy and forecast process?*

In the thesis it is shown that the forecast accuracy can be improved for evaluated turbos by implementing a forecast based on condition monitoring data. However, no such improvement could be found for evaluated batteries. This is believed to be because of the evaluated fault codes not being appropriate indicators of battery demand. Moreover, it is shown that the forecast process, in the short term, can change to manually create a regression based forecast for turbos, and over time

include fault code based forecasts for additional parts. In the long term, it is foreseen that condition monitoring data can be used in the automatic system forecast as an alternative to currently used time-based methods. Furthermore, it is also discussed that basing forecast on condition monitoring data instead of demand information from the closest downstream supply chain actor mitigates risk of bull-whip effect and reduce inefficiencies in the supply chain. Additionally, forecast based on fault codes can, compared to currently used time-based methods, predict demand more accurately on a time horizon longer than the part lead time from supplier to dealer. Thereby, availability can be increased and/or safety stock levels decreased.

7.2 Practical and Theoretical Contribution

The practical contribution of the thesis work is a proof of concept for forecasting based on fault codes. It has been shown that the total demand for studied turbos can be predicted by usage of fault code data. It has also been shown that for three individual turbos with low and high positive trends the forecast can be made more accurate compared to currently used time-based forecasts. A higher forecasting accuracy would result in reduced safety stocks and/or increased service levels for the evaluated parts. Moreover, the forecasts based on fault codes are able to predict actual demand, and thereby demand trends. However due to individual customer behavior, fluctuations can not be accurately forecasted by aggregating fault codes over an entire population. Additionally, an exploration of available fault code data has shown that there is an abundance of data which could be exploited in demand planning to a higher extent. Qlikview and Python scripts have been created to extract, process and make calculations on fault code as well as demand data. Furthermore, an analysis approach has been developed with a logic to create new fault code based forecasting models through regression analysis. This analysis approach could be used as a starting point for finding causality between additional part types and fault codes, thereby laying a foundation for creation of fault code based forecasts for a greater scope of parts.

The theoretical contribution of the thesis is that it provides a practical example of how condition monitoring data can be used to forecast spare part demand in the automotive industry. Furthermore, the effects an implementation of a causal-based forecasting method would have on the forecasting process is discussed for a company in the automotive industry. Moreover, a comparison between the performance of a causal-based forecast method and a time-based forecast method on spare parts with positive demand trend as well as erratic and intermittent demand patterns is conducted.

7.3 Recommendations and Future Research for the Case Company

The accuracy of regression based forecasts created should be evaluated for a time period longer than six months in order to further prove or disprove the suitability

of developed forecast models. Evaluations should be made for all regression based forecast models created in order to enable a comparison, thereby increasing the information-base to be analyzed. Furthermore, limited by the scope of the thesis only a share of the existing parts and fault codes was explored. A natural step to further develop the model would therefore be to include a larger number of fault codes and parts in the analysis. More fault codes and parts could be included by integrating expertise within vehicle diagnostics, components and/or maintenance. Preferably stakeholders from each of these operations should be involved in the project. Thereby, additional qualitative hypotheses of where correlation between fault code data and spare part demand could be created. Alternatively, the scope could be widened by searching for part-related keywords in the fault code description.

Additional regression analysis could also be conducted. Particularly considerations to the effects that integrating multiple fault codes can have on the regression based forecast should be taken, since it is not evaluated in depth in the thesis due to time constraints. This could for instance be made with principle component analysis and multiple hierarchical regression in order to clearly map out which combinations of fault codes best model the dealer demand. Additionally, multiple regression using fault codes and other explanatory variables in the shape of other condition monitoring data could be explored. Combining the forecasts of multiple fault codes on different time horizons can also be performed, where forecasts with high forecast accuracy are included. For example, if a part has high performing regression based forecasts on time horizons four & five months for different fault codes, a new forecast is created using the same fault codes and time horizons in combination. Another aspect which could be evaluated is a combination of regression forecast and time-based forecast in order to draw from each method's advantages. For instance, a regression forecast based on fault codes can be used early in a part's life cycle, and a time-based forecast can be used in the mature phase when demand is relatively stable. Another application of combining the methods could be to use both methods simultaneously and assigning different weights to the two forecasts.

Additionally, more research could be conducted in the the effects of geographical area. The analysis can be expanded to include more geographical regions than Europe in order to apply the result on other markets. Similarly, business areas besides Volvo Trucks could also be considered. Moreover, analyses on a more dispersed level than CDC, on for example country, dealer or vehicle level, could be performed in order to explore the effects an approach similar to the thesis would have on forecast on a less aggregated level. If a dispersed level analysis is conducted there is potential of predicting precisely at which dealer/region parts are needed ahead of time. This would enable a supply chain with less stocking points, fewer transports and higher availability. Analyses on part number level could also be conducted where occurrence of fault codes is only counted for vehicles containing a specific part in order to further improve quality of data, thereby optimizing the forecast. Furthermore, if the forecast can be improved on a CDC level by analyzing dealer demand, this information should be shared with actors responsible for the spare part demand in other parts of the supply chain; RDCs, CDCs and dealers. Moreover, connections found between fault codes and

spare part demand should be shared within parts of the company working with maintenance and diagnostics, as it may aid in the process of moving toward predictive maintenance.

When performing the recommended activities, documentation should be written to enable future improvements and learning. After widening of the scope and identifying key connections and patterns, with the help of experts within different fields, system automation can be used to facilitate the analyses. System automation is deemed to be applicable due to the high degree of repetitiveness in the calculations when searching for correlations as well as creating regression forecasts. The calculation is time consuming if all possible combinations are to be tested, why automation is deemed to have a high potential. Furthermore, if the process would be automated the amount of tested associations could be increased which in turn would increase the probability to find a greater number of accurate forecasts. A summary of all recommended actions, as well as a prioritization, both in order of execution and short or long term, is presented in Figure 7.1.

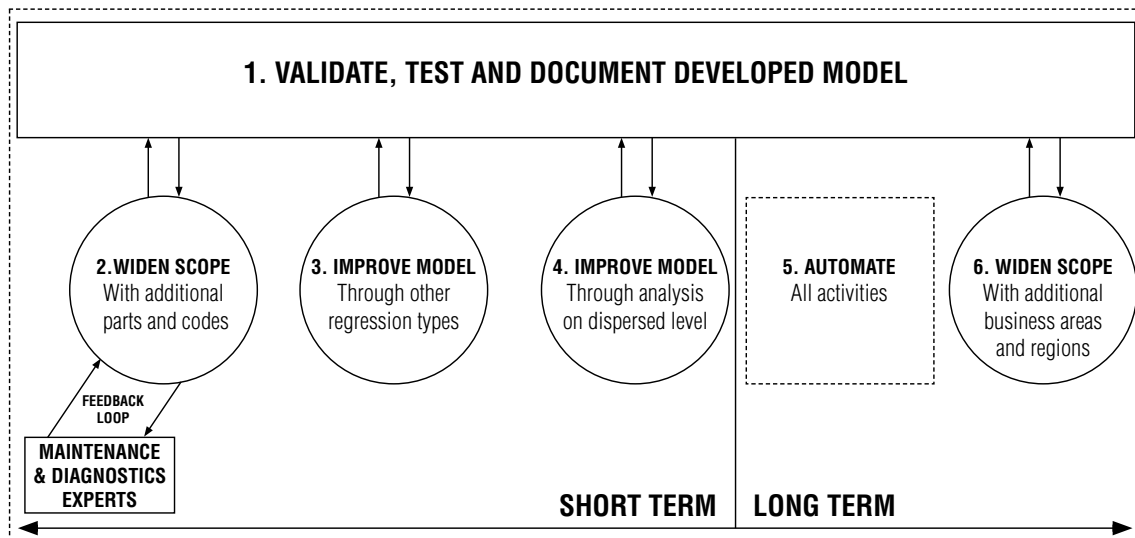

Figure 7.1: Illustration of recommended future actions for the case company based on the thesis findings.

7.4 Future Research within Academia

This thesis is focused on researching the effects of using fault codes in the forecast of spare part demand for trucks, i.e. within the automotive industry. Usage of fault codes, or other condition monitoring data, for forecasting of spare parts should also be researched in other industries. Preferably in industries where data is being gathered in large proportions and with high cost of shortage and/or down-time, for example the airline industry. Similar approaches to the ones explored in this thesis could potentially be used in other industries. An exploration of correlation with spare part demand and condition monitoring data other than fault codes could, such as "raw sensor data" with vibration, pressure, noise or temperature might also be conducted. Moreover, the approach of using

models based on multiple explanatory variables should be explored in order to increase the degree to which the model explains fluctuations in demand. One example of an explanatory variable which could be incorporated is a factor explaining customer behavior. The effects of using different types of models, such as multiple hierarchical or non-linear regression models, should also be explored further. Additionally, implications of using time-based forecasting methods compared to causal-based forecasting methods on parts early in their life cycle and/or with increasing demand trend should be further evaluated to optimally determine when the different methods should be used. Using a combination of causal-based and time-based forecasting with different weights should also be evaluated. Lastly, customer behaviour effects on service requirements are briefly discussed in the thesis, however it should be researched further in order to better understand reasons for spare part demand fluctuations.

Bibliography

- Ahmad, R. and Kamaruddin, S. (2012), ‘An overview of time-based and condition-based maintenance in industrial application’, *Computers & Industrial Engineering* **63**(1), 135–149.
- Al-Najjar, B. and Alsyof, I. (2003), ‘Selecting the most efficient maintenance approach using fuzzy multiple criteria decision making’, *International Journal of Production Economics* **84**, 86–100.
- Asuero, A., Sayago, A. and Gonzalez, A. (2006), ‘The correlation coefficient: An overview’, *Critical reviews in analytical chemistry* **36**(1), 41–59.
- Baptista, M., de Medeiros, I. P., Malere, J. P., Nascimento Jr, C., Prendinger, H. and Henriques, E. M. (2017), ‘Comparative case study of life usage and data-driven prognostics techniques using aircraft fault messages’, *Computers in Industry* **86**, 1–14.
- Barrowman, N. (2014), ‘Correlation, causation, and confusion’, *The New Atlantis* pp. 23–44.
- Bask, A. and Rajahonka, M. (2017), ‘The role of environmental sustainability in the freight transport mode choice: A systematic literature review with focus on the eu’, *International Journal of Physical Distribution & Logistics Management* **47**(7), 560–602.
- Bloch, H. and Geitner, F. (1983), *Machinery failure analysis and troubleshooting*, Gulf Pub, Co, Houston.
- Boylan, J. and Syntetos, A. (2008), *Complex System Maintenance Handbook*, Springer, London, chapter Forecasting for Inventory Management of Service Parts, pp. 479–506.
- Bryman, A. and Bell, E. (2011), *Business Research Methods*, 3rd edn, Oxford University Press, Oxford.
- Byington, C. S., Roemer, M. J. and Galie, T. (2002), Prognostic enhancements to diagnostic systems for improved condition-based maintenance [military aircraft], in ‘Aerospace Conference Proceedings, 2002. IEEE’, Vol. 6, IEEE, pp. 6–6.

- Campos, J. (2009), 'Development in the application of ict in condition monitoring and maintenance', *Computers in Industry* **60**(1), 1–20.
- Chen, W., Meher-Homji, C. and Mistree, F. (1994), 'Compromise: an effective approach for condition-based maintenance management of gas turbines', *Engineering Optimization* **22**(3), 185–201.
- Cobbaert, K. and Van Oudheusden, D. (1996), 'Inventory models for fast moving spare parts subject to "sudden death" obsolescence', *International Journal of Production Economics* **44**(3), 239–248.
- Cohen, M., Agrawal, N. and V., A. (2006), 'Winning in the aftermarket', *Harvard Business Review* **84**(5), 129–138.
- Crawford, S. L. (2006), 'Correlation and regression', *Circulation* **114**(19), 2083–2088.
- Dekker, R., Pinçe, C., Zuidwijk, R. and Jalil, M. (2013), 'On the use of installed base information for spare parts logistics: A review of ideas and industry practice', *International Journal of Production Economics* **143**(2), 536–545.
- Dekking, F. M. (2005), *A Modern Introduction to Probability and Statistics: Understanding why and how*, Springer Science & Business Media.
- Dobrican, O. (2013), 'Forecasting demand for automotive aftermarket inventories', *Informatica Economica* **17**(2/2013), 119–129.
- Dombrowski, U. and Engel, C. (2013), 'After sales strategies for the original equipment manufacturer of electric mobiles', *Re-engineering Manufacturing for Sustainability : Proceedings of the 20th CIRP International Conference on Life Cycle Engineering, Singapore, 17-19 April* pp. 347–352.
- Eisenhauer, J. G. (2009), 'Explanatory power and statistical significance', *Teaching Statistics* **31**(2), 42–46.
- Emanuelson, U. and Egenvall, A. (2014), 'The data-sources and validation', *Preventive veterinary medicine* **113**(3), 298–303.
- Gaiardelli, P., Sacconi, N. and Songini, L. (2007), 'Performance measurement of the after-sales service network—evidence from the automotive industry', *Computers in Industry* **58**(7), 698–708.
- Goodenow, T., Hardman, W. and Karchnak, M. (2000), Acoustic emissions in broadband vibration as an indicator of bearing stress, *in* 'Aerospace Conference Proceedings, 2000 IEEE', Vol. 6, IEEE, pp. 95–122.
- Green, H. (2014), 'Use of theoretical and conceptual frameworks in qualitative research', *Nurse researcher* **21**(6), 34–38.
- Huiskonen, J. (2001), 'Maintenance spare parts logistics: Special characteristics and strategic choices', *International Journal of Production Economics* **71**(1), 125–133.

- Jardine, A., Lin, D. and Banjevic, D. (2006), 'A review on machinery diagnostics and prognostics implementing condition-based maintenance', *Mechanical Systems and Signal Processing* **20**(7), 1483–1510.
- Jawlik, A. (2016), *Statistics from A to Z: Confusing Concepts Clarified*, John Wiley & Sons.
- Johnson, R. B. and Onwuegbuzie, A. J. (2004), 'Mixed methods research: A research paradigm whose time has come', *Educational researcher* **33**(7), 14–26.
- Jonsson, P. and Mattsson, S. (2009), *Manufacturing planning and control*, McGraw-Hill Education, London.
- Kraha, A., Turner, H., Nimon, K., Zientek, L. and Henson, R. (2012), 'Tools to support interpreting multiple regression in the face of multicollinearity', *Frontiers in psychology* **3**, 44.
- Kuma, J. (1984), *Basic Statistics for the Health Science*, Mayfield Publishing Co., Palo Alto, pp. 158–169.
- Lee, H. L., Padmanabhan, V. and Whang, S. (1997), 'The bullwhip effect in supply chains', *Sloan management review* **38**(3), 93.
- Lee, J. and Wang, H. (2008), *Complex System Maintenance Handbook*, Springer, London, chapter New Technologies for Maintenance, pp. 49–78.
- Levitt, J. (2011), *Complete guide to preventive and predictive maintenance, (2nd Edition)*, Industrial Press, New York.
- Mason, C. H. and Perreault Jr, W. D. (1991), 'Collinearity, power, and interpretation of multiple regression analysis', *Journal of marketing research* pp. 268–280.
- Mason, R., Lind, D. and Marchal, W. (1983), *Statistics: An Introduction*, Harcourt Brace Jovanovich, Inc, pp. 368–383.
- Mobley, R. K. (2002), *An introduction to predictive maintenance*, Butterworth-Heinemann, New York.
- Molenaers, A., Baets, H., Pintelon, L. and Waeyenbergh, G. (2012), 'Criticality classification of spare parts: A case study', *International Journal of Production Economics* **140**(2), 570–578.
- Muller, A., Suhner, M. and Iung, B. (2007), 'Maintenance alternative integration to prognosis process engineering', *Journal of Quality in Maintenance Engineering* **13**(2), 198–211.
- Nimon, K., Henson, R. K. and Gates, M. S. (2010), 'Revisiting interpretation of canonical correlation analysis: A tutorial and demonstration of canonical commonality analysis', *Multivariate Behavioral Research* **45**(4), 702–724.

- Panda, T. K. and Mohanty, P. K. (2013), 'Adoption of supply chain management strategies as a response to bull whip effect: From the perspective of indian retailers', *IUP Journal of Supply Chain Management* **10**(3), 19.
- Persson, F. and Saccani, N. (2009), 'Managing the after-sales logistic network-a simulation study', *Production Planning & Control* **20**(2), 125–134.
- Rabianski, J. S. (2003), 'Primary and secondary data: Concepts, concerns, errors, and issues', *Appraisal Journal* **71**(1), 43–43.
- Randall, R. B. (2011), *Vibration-based condition monitoring: industrial, aerospace and automotive applications*, John Wiley & Sons.
- Rego, J. and Mesquita, M. (2015), 'Demand forecasting and inventory control: A simulation study on automotive spare parts', *International Journal of Production Economics* **161**, 1–16.
- Rocco, T. and Plakhotnik, M. (2009), 'Literature reviews, conceptual frameworks, and theoretical frameworks: Terms, functions, and distinctions', *Human Resource Development Review* **8**(1), 120–130.
- Saccani, N. and Bacchetti, A. (2012), 'Spare parts classification and demand forecasting for stock control: Investigating the gap between research and practice', *Omega* **40**(6), 722–737.
- Schmidt, B. and Wang, L. (2016), 'Cloud-enhanced predictive maintenance', *International Journal of Advanced Manufacturing Technology* .
- Syntetos, A. and Boylan, J. (2010), 'On the variance of intermittent demand estimates', *International Journal of Production Economics* **128**(2), 546–555.
- Syntetos, A., Keyes, M. and Babai, M. (2009), 'Demand categorisation in a european spare parts logistics network', *International Journal of Operations & Production Management* **29**(3), 292–316.
- Tsai, L. L. E. (2004), Design and performance of a gas-turbine engine from an automobile turbocharger, PhD thesis, Massachusetts Institute of Technology.
- Tsang, A. (1995), 'Condition-based maintenance: tools and decision making', *Journal of Quality in Maintenance Engineering* **1**(3), 3–17.
- Tukey, J. W. (1977), *Exploratory data analysis*, Vol. 2, Reading, Mass.
- Vachtsevanos, G. and Wang, P. (2001), Fault prognosis using dynamic wavelet neural networks, in 'AUTOTESTCON Proceedings, 2001. IEEE Systems Readiness Technology Conference', IEEE, pp. 857–870.
- Vasumathi, B. and Saradha, A. (2014), 'Forecasting of sporadic demand patterns with spare parts', *International Journal of Innovation and Applied Studies* **8**(1), 237.

- Wang, W. (2002), 'A model to predict the residual life of rolling element bearings given monitored condition information to date', *IMA Journal of Management Mathematics* **13**(1), 3–16.
- Wang, W. (2008), *Complex System Maintenance Handbook*, Springer, London, chapter Condition-based Maintenance Modelling, pp. 111–131.
- Wang, W., Hussin, B. and Jefferis, T. (2012), 'A case study of condition based maintenance modelling based upon the oil analysis data of marine diesel engines using stochastic filtering', *International Journal of Production Economics* **136**(1), 84–92.
- Willemain, T., Smart, C. and Schwarz, H. (2004), 'A new approach to forecasting intermittent demand for service parts inventories', *International Journal of Forecasting* **20**(3), 375–387.
- Wilson, B. W., Hansen, N. H., Shepard, C. L., Peters, T. J. and Greitzer, F. L. (1999), Development of a modular in-situ oil analysis prognostic system, *in* 'Proceedings of the International Society of Logistics (SOLE) 1999 Symposium, August'.
- Wright, S. (1921), 'Correlation and causation', *Journal of agricultural research* **20**(7), 557–585.
- Yamashina, H. (1989), 'The service parts control problem', *Engineering Costs and Production Economics* **16**(3), 195–208.

A

Appendix: Interview Questions

In this Appendix, interview questions asked during the thesis' interviews are presented. During most interviews, a template was used and some different questions in addition to those in the template were asked depending on the interview subject. At the dealer visit, a different set of questions was used. The template is presented first, followed by the set of questions asked at the dealer visit.

A.1 Interview Template

Start of interview:

- Explanation of the thesis scope and purpose
- Explanation of purpose with interview

The interviewee:

- What department are you working in?
- What is your role within the department?
- Are you responsible for a certain part of the supply chain, part life-cycle or part segment?
- What are your operational responsibilities?
- What are your strategic responsibilities?

Forecasting:

- How is the forecasting of spare part demand currently conducted?
 - By you personally?
 - By the department?
- How do you measure the accuracy of forecasts at the department?
- What improvements of forecasts are you currently working with?

A. Appendix: Interview Questions

- Do you differentiate the forecasts between different regions?
- Do you see any potential areas where improvements could be found?
- In what segment(s) of parts do you see potential for improving the forecast and achieving large (economic) benefits?
 - Critical parts?
 - High value parts?
 - High demand parts?
 - Specific life-cycle phase?

Data used for forecasting:

- What type(s) of data do you use for forecasting?
- Do you use any aggregations, assumptions or simplifications to fill gaps in data?

Predicting breakdowns with data:

- Do you think it is possible to predict breakdowns by using sensor data?
 - Why/why not?
 - For what parts?
 - Using what indicators?
 - Which indicators do you believe correlate with spare part demand?
- Do you see a potential in using sensor data and/or fault codes to improve forecasting accuracy?
 - If so, in what way(s) could this be done?
- Do you think it is possible to predict breakdowns by using other types of data?
 - Why/why not?
 - For what parts?
 - Using what indicators?
 - Which indicators do you believe correlate with spare part demand?
- Do you see a potential in using other types of data to improve forecasting accuracy?

- If so, in what way(s) could this be done?

End of interview:

- Do you have any recommendation for other people with knowledge/interest in usage of sensor data?
- Anything else you would like to add, discuss or ask?

A.2 Interview Questions for Dealer Visit

Start of interview:

- Explanation of the thesis scope and purpose
- Explanation of purpose with interview

Decision-making:

- How do you decide which trucks to call in for service?
- Do you have any information about the condition of the truck before they arrive at the service-point?
- How do you select which parts to replace/repair/fix?
- How is the investigation-process conducted?
- Do you use data which is uploaded from the vehicle?
 - If so, which data?
- Do you know any specific sensor data which correlates to a specific problem/breakdown?
- Is there some parts that are always changed at every service-instance?
- Is there some parts that are always changed together? (KIT?)
 - If so, how do you know this?
 - Through experience or documentation?
- Do you log when parts are switched?
- Do some parts break together, i.e. one part breaks means other parts needs to be switched as well?
 - If so, how do you know this?

A. Appendix: Interview Questions

- Through experience or documentation?
- How large part of decision making is experience-based/documentation-based?

Service-planning:

- On average, how far in advance is a service planned?
- How often are trucks serviced?
- Do you know before a vehicle has arrived at the depot if you are going to replace certain parts?
 - If so, what do you base this on?
- Do you reserve parts for this service?
- Does this create demand in the system?

B

Appendix: Safety Stock and Service Level Equations

In this Appendix, safety stock and demand fill rate service level calculations used by forecasting systems at Volvo are presented. Below, the used equations and constants are presented in Equation B.1, B.2 & B.3.

$$\mathbf{E}(k) = \frac{OQ \times (1 - SL)}{SD \times \sqrt{LT}} \quad (\text{B.1})$$

$$\mathbf{SS} = k \times \sqrt{LT} \times SD \quad (\text{B.2})$$

$$\mathbf{SD} = (1 - \alpha) \times SD_{t-1} + \alpha \times |FC - D| \quad (\text{B.3})$$

Where:

α : Smoothing Constant

D : Demand

FC : Forecast

k : Service Constant

LT : Lead Time

OQ : Order Quantity

SD : Standard Deviation

SL : Service Level

Equation B.1 is the service function which is used to calculate the service constant for a given service level. The conversion table between service function and service constant is provided in Table B.1. Equation B.2 is the equation for calculation of safety stock for a given service constant. Equation B.3 shows how the standard

deviation between forecast and actual demand is calculated. The smoothing constant (α) in Equation B.3 decides how much emphasis should be put on historical values. It is defined between 0 to 1 and the value of 0.2 was used in the initial calculations. By using Equations B.1 to B.3, both the service level and the safety stock can be calculated given a known safety stock or service level respectively.

E(K)	K	E(K)	K	E(K)	K	E(K)	K
0.3990	0.0	0.1400	0.7	0.0370	1.4	0.0070	2.1
0.3500	0.1	0.1200	0.8	0.0290	1.5	0.0050	2.2
0.3070	0.2	0.1000	0.9	0.0230	1.6	0.0040	2.3
0.2700	0.3	0.0830	1.0	0.0180	1.7	0.0030	2.4
0.2300	0.4	0.0700	1.1	0.0140	1.8	0.0020	2.5
0.2000	0.5	0.0560	1.2	0.0110	1.9	0.0010	2.6
0.1790	0.6	0.0500	1.3	0.0090	2.0	0.0010	2.7

Table B.1: Conversion table between service function and service constant.

C

Appendix: Resulting Changes in Safety Stock and Service Level

In this Appendix, resulting changes in safety stock and service level when using smoothing constants of 0.2, 0.1 and 0.05 respectively are presented. Resulting changes in service level or safety stock when using causal-based compared to time-based forecasts are presented in Tables C.1, C.2, C.3, C.4, C.5 and C.6.

Table C.1: Resulting changes in service level with a smoothing constant of 0.2 when using the causal-based forecasts compared to the time-based, and keeping the current safety stock.

Part	Service Level Causal-Based	Service Level Time-Based	Change (Percentage Points)
85013511	98.30 %	19.06 %	79.24 %
85020372	99.93 %	97.27 %	2.66 %
85013758	93.68 %	65.03 %	44.06 %

Table C.2: Resulting changes in required safety stock with a smoothing constant of 0.2 when using the causal-based forecasts compared to the time-based, and keeping the current desired service level.

Part	Change in Safety Stock
85013511	-98.16 %
85020372	-83.36 %
85013758	-49.74 %

Table C.3: Resulting changes in service level with a smoothing constant of 0.1 when using the causal-based forecasts compared to the time-based, and keeping the current safety stock.

Part	Service Level Causal-Based	Service Level Time-Based	Change (Percentage Points)
85013511	98.85 %	55.45 %	43.40 %
85020372	99.97 %	99.34 %	0.63 %
85013758	95.49 %	85.29 %	10.20 %

Table C.4: Resulting changes in required safety stock with a smoothing constant of 0.1 when using the causal-based forecasts compared to the time-based, and keeping the current desired service level.

Part	Change in Safety Stock
85013511	-97.48 %
85020372	-80.47 %
85013758	-37.31 %

Table C.5: Resulting changes in service level with a smoothing constant of 0.05 when using the causal-based forecasts compared to the time-based, and keeping the current safety stock.

Part	Service Level Causal-Based	Service Level Time-Based	Change (Percentage Points)
85013511	98.86 %	76.65 %	28.97 %
85020372	99.97 %	99.85 %	0.12 %
85013758	96.68 %	93.99 %	2.69 %

Table C.6: Resulting changes in required safety stock with a smoothing constant of 0.05 when using the causal-based forecasts compared to the time-based, and keeping the current desired service level.

Part	Change in Safety Stock
85013511	-94.96 %
85020372	-74.28 %
85013758	-13.22 %