

Frequency Domain Laser Velocimeter Signal Processor

by

James F. Meyers
NASA - Langley Research Center
Hampton, Virginia 23665

and

R. Jay Murphy
Macrodyne, Inc.
Clifton Park, New York 12065

Abstract

A new scheme for processing signals from laser velocimeter systems is described. The technique utilizes the capabilities of advanced digital electronics to yield a signal processor operating in the frequency domain maximizing the information obtainable from each signal burst. This allows a sophisticated approach to signal detection and processing with a more accurate measurement of the chirp frequency resulting in an eight-fold increase in measurable signals over present high-speed burst counter technology. Further, the required signal-to-noise ratio is reduced by a factor of 32 allowing measurements within boundary layers of wind tunnel models. Measurement accuracy is also increased up to a factor of five.

Introduction

Laser velocimetry is a technique that nonintrusively measures the velocity of micron sized particles embedded in fluids or microscopic flaws in surfaces. The optical system creates an interference fringe pattern using two crossed laser beams, figure 1. The measurement volume created by the crossing beams is typically 0.2 mm in diameter and 2.0 mm in length resulting in basically a point measurement. As a particle passes through the fringes, it will scatter light from the lighted bands. A portion of this oscillating scattered light is collected by a photomultiplier tube where it is converted to an electrical signal. This signal, a burst of about a microsecond in length illustrated in figure 2, contains a chirp whose frequency is directly related to the rate at which the particle passed through the lighted bands. The burst can range from photon resolved to a complete analog signal up to 400 mV in amplitude. The signal can be masked by extraneous noise from collected photons originating from background light, laser light scattered from very small particles—too small to be individually realizable, and/or from laser light scattered from surfaces.

Originally laser velocimeter signals were processed using standard spectrum analyzers or specially built wide-band frequency trackers.¹ These frequency domain approaches worked well with continuous signals obtained from liquid flows, but the analog circuitry could not reliably process the individual signal bursts obtained from air flow measurements.² If a single signal burst could be detected, a timer can be used to measure the time between the first cycle of the chirp and the n^{th} cycle. This time domain approach became the basis of the high-speed burst counter, now the standard signal processor for laser velocimeter applications.^{3,4,5} While the high-speed burst counter provides good measurement capability, it suffers from two limitations. It uses only two points to determine the cycle time, and it requires the chirp to fit the classic model of a signal burst. The high-speed burst counter provides measurement accuracies in the 0.5- percent range with residual turbulence intensities (indicated turbulence intensity with no turbulence in the flow) in the neighborhood of 0.5- percent. Theoretical

investigations show that turbulence intensity measurements below 1.0-percent are unreliable. The lack of low turbulence measurement capability and the requirement for an experienced operator to keep the measurement inaccuracies within the above ranges led to an investigation to develop new technology to reduce these limitations.

This investigation resulted in the following conclusions: (1) Increased accuracy was directly dependent on the number of measurement samples obtained during the duration of the signal burst. (2) Multiple thresholds or multiple bit measurements from an analog-to-digital converter (ADC) coupled with proper signal processing would remove the requirement for classic signal bursts. (3) Processing in the frequency domain provided increased efficiency with better measurement accuracy given the increased number of multiple bit measurement samples. Fortunately digital signal processing hardware is now available which eliminates the problems found with the previous analog frequency domain processing techniques.

A signal processor utilizing a high-speed 2-bit transient recorder for signal capture and a bank of adaptive digital filters with energy and/or zero crossing detection was developed via computer model.⁶ This model was tested using real and simulated laser velocimeter signal bursts at various amplitudes under various signal-to-noise conditions. The results of these simulations indicated the device would increase measurement accuracy over the high-speed burst counter by five times from signals with as few as 150 photons per burst. The residual turbulence intensity was reduced by a factor of 2.5 and turbulence intensity measurements down to 0.2-percent were reliable. Minimum acceptable signal-to-noise ratio was reduced by a factor of 32 as compared to the high-speed burst counter.

Although the simulated signal processor yielded impressive results, the device was impractical to build. The overhead required to implement the digital filter bank would limit the processor to a maximum measurement rate of less than 10 measurements per second. Utilizing optimized digital signal processing large scale integrated circuits to perform fast Fourier transforms and changing the filter bank to analog circuitry, a practical frequency domain signal processor was constructed—the FDP-3100.

Desired System Characteristics

The design studies leading toward the computer simulation of the frequency domain processor, FDP, began by evaluating the characteristics of laser velocimeter signal bursts and by developing the desired system characteristics. The evaluation indicates that the signal bursts are of short duration and obey Poisson occurrence statistics with very low average rates. The signal amplitudes have little variation if the particles are all approximately the same size. The turbulence intensity parameter f'/F must not be allowed to exceed 20 percent to prevent frequency aliasing at 0 Hz. The signal processor should contain a transient recorder to capture the signal burst with a triggering circuit designed to maximize the data acceptance rate while minimizing the number of false triggers. The transient recorder should contain a multi-bit analog-to-digital converter. The processing of the captured signal should be as rapid as possible to minimize processor dead time. Signal validation circuitry should be included to give confidence that the acquired and processed data are indeed from valid signals.

Studies indicate that a signal processor is usually waiting for a signal burst to arrive. If the presence of the signal burst can be detected and the waveform captured and stored in a digital memory, ample time would be available for processing prior to the arrival of the next signal burst. This forms the basic strategy of the ideal signal processor: A high-speed burst capture circuit followed by signal analysis circuitry furnishing data to digital feedback loops for gain and average frequency adjustments and for the measurement of the chirp frequency in each signal burst.

Although the signal bursts are digitized by other laser velocimeter signal processing techniques, the only true multibit digitization of signal bursts has occurred by using transient recorders with computer processing of the captured bursts.⁷ The major advantage of the transient recorder is the ability to capture

* When u'/U is greater than 20 percent, a Bragg cell is used to bias the signal frequency away from 0 Hz; thus f'/F is reduced below 20 percent.

the entire burst without the assumption of symmetry or high signal visibility as in the other techniques. A secondary advantage of the transient recorder is its maintenance of amplitude information which could be input to circuitry for controlling signal amplification. The disadvantages of a transient recorder, however, are manual setting of signal amplification and sampling rate, and the slow transfer of the data to the external computer. If these problems can be overcome, this approach would seem to have a distinct advantage over classical laser velocimetry signal processing.

Computer Simulation of the Proposed Frequency Domain Processor

A computer simulation of a frequency domain processor was developed based on the above characteristics.⁶ This system utilized a high-speed transient recorder to capture the signal burst and a bank of seven adaptive digital bandpass filters to develop an energy histogram which was then interrogated to determine the chirp frequency contained within the signal burst. Digital feedback loops were included to control the gain circuits in the input amplifiers and to control the reference clock frequency to maintain an average digitizing rate of 10 samples per cycle.

The transient recorder was designed to operate in the manner of a shift register with the digitized signal continuously passing through the recorder, allowing the contents to be integrated to detect a signal burst. When a signal burst has been found, the shifting process would be halted and the data transferred to data latches to provide the input to the signal processor section. This technique allows processing the laser velocimeter output only when signal bursts are present. By using the amplitude and frequency information obtained from the signal burst, the amplification and sampling rate can be adjusted to maximize measurement accuracy. In practice, the system should not adjust the sampling rate while acquiring data, since this would require the output of the rate along with the desired measurement information. Thus the system should be designed to operate in two phases, a setup phase to establish the sampling rate and a data acquisition phase with the rate held constant. The information on signal amplitude can be used to continuously control an automatic gain circuit to keep the signal amplitude within the optimum bounds. This basic approach is illustrated in the block diagram in figure 3.

Although it would appear that the most straight-forward approach to determine the oscillation frequency of the captured signal burst would be to perform a fast Fourier transform, FFT, and to determine the location of the peak, this approach is not necessarily the most efficient for laser velocimeter signal burst processing. (As will be shown later, this thought is incorrect considering the new state-of-the-art digital signal processing large scale integrated circuits that have been optimized for FFT calculations.) The FFT performs many unnecessary calculations to determine the energy distributions for frequencies above and below the oscillation frequency, since it calculates the entire frequency spectrum. It would be much more efficient if only those frequencies surrounding the oscillation frequency were investigated. This ideal can be realized by using a digital bandpass filter bank with control of the sampling frequency during the above-mentioned setup phase to approximate the desired Fourier energy calculations. By using $f/F = 20$ percent and ± 3 standard deviations, 99.73 percent of the energy contained in the Gaussian frequency (velocity) distribution will be obtained for the maximum measurement conditions. Therefore, a bank of seven digital bandpass filters, each with a bandwidth of at least $f/F = 0.2$ and a center frequency separation of 20- percent of the sampling frequency can be used to obtain the equivalent energy distribution as an FFT with an increase in computation speed, figure 4.

The use of digital bandpass filters offers several signal processing possibilities. The peak of the energy distribution passing through the filter bank can be determined by using curve fit or statistical procedures to yield the oscillation frequency. The filter passing the greatest energy for a given signal burst could be used as a narrow bandpass filter for a high-speed burst counter. The signal-to-noise ratio may be increased for low f/F by changing the coefficients of the filters to reduce both the bandwidth and the frequency spacing. These possibilities may even be combined by using a control algorithm designed to maximize measurement accuracy of the input signals.

The resulting simulation was composed of a transient recorder with unfiltered automatic gain amplification, analog-to-digital conversion, shift register storage, and burst detection circuitry; and a computation signal processor including a bank of seven adaptive digital bandpass filters, and energy detection, zero crossing detection, and automatic frequency control algorithms. The processor would use the techniques of automatic frequency control and automatic gain control to keep the input signal bursts at the optimum sampling and amplitude points. The unit would be insensitive to input signal-to-noise ratio while processing individual signal bursts. The overall system function diagram is shown in figure 3 and with increased detail in figure 4.

Testing of the Simulated Frequency Domain Processor

The operation of the control algorithms and the characteristics of the frequency domain laser velocimeter signal processor were tested by means of computer simulation of laser velocimeter signal bursts and by modeling of the signal processor. The simulation of the signal burst was by means of Poisson shot noise models generated in the manner described in reference 8. These models could be adjusted from the photon-resolved regime, through photon pileup, to photomultiplier saturation. The model of the signal processor includes the analog-to-digital converter, the automatic gain control and the automatic frequency control circuitry; signal detection circuitry; digital filter banks; zero crossing detection circuitry; energy detection circuitry; and signal processing algorithms to be implemented in the controlling microprocessor firmware. A typical test consisted of generating a series of signal bursts with a selected average photon count, average signal visibility, average oscillation frequency, and standard deviation of oscillation frequency. The oscillation frequency for each signal burst was statistically selected based on Monte Carlo methods with a Gaussian probability distribution of signal frequencies based on the requested average and standard deviation. The theoretical signal burst is generated based on the selected oscillation frequency and input visibility function and used as the driver for generation of the signal burst based on the algorithm from reference 8, figure 2. This burst is then input to the model of the frequency domain processor for setup and/or processing. Once the setup phase is completed, 100 signal bursts are input to and processed by the frequency domain processor. The statistics of the measured results are calculated and compared with the statistics of the input ensemble used to generate the signal bursts. This direct comparison of data removes the assumption that the characteristics of the 100 signal bursts agree with the requested average frequency and standard deviation. A model of a high-speed burst counter was developed to serve as a performance comparison. It used 4-pole Butterworth low- and high-pass filters, double threshold signal detection, zero crossing measurement by using a 500 MHz reference clock, and 5:8 count comparison error detection. Again the statistics of the input ensemble of signal bursts were compared to the output statistics of the measurement ensemble from the high-speed burst counter. It is noted that signal bursts that did not satisfy either the double threshold detection check and/or 5:8 error detection were not included in the measurement ensemble, whereas all measurements were included in the results from the frequency domain processor.

The first series of comparison tests determined the measurement accuracy of f'/F for high-level signals (approximately 1500 photons per burst at a signal frequency of 25 MHz—example given in figure 2(b)) for 0 to 5 percent. The comparison of measured f'/F with the input f'/F as a function of mean frequency for the high-speed burst counter is shown in figure 5(a). The companion comparison for the frequency domain processor is shown in figure 5(b).

The effect of signal-to-noise ratio on the measurements were tested by reducing the average photon count per signal burst from approximately 3000 per burst to approximately 150 per burst at a mean frequency of 25.0 MHz. As shown in figure 6, the high-speed burst counter has a residual f'/F approximately 2.5 times larger than the FDP down to 300 photons per burst. As the input f'/F is increased from 0 to 1.0 percent (figures 7 through 12), the results from the FDP match the input at an f'/F of 0.2 percent with bursts containing at least 900 photons. Signals with photon counts down to 500 match at 0.3 percent and signals down to 300 photons match at 0.4 percent. The high-speed burst counter results did not match until f'/F reached 1.0 percent and then had a great deal of scatter.

Translation to the Real World

The translation of an idea to hardware has a different set of constraints than translation to computer simulation. Simulation allows a full range of processing and control algorithms where time is unimportant. However, the hardware version must be designed for simplicity and speed to be usable. Unfortunately the simulated frequency domain processor is neither. The digital filter bank is complicated with excessive overhead reducing the anticipated data rate to unacceptably low levels. The control circuits for automatic gain and triggering for the transient recorder require up/down counters running at 1.0 GHz which would be difficult to construct even using GaAs technology. The automatic frequency control circuit is not necessary when fast Fourier transform approaches are used. Although these casualties may seem to completely change the character of the processor, many of the elements in these approaches are still incorporated, but in different ways. For example, the digital filter bank has been converted to a bank of analog filters and placed in the transient recorder to serve as an integral part of the triggering circuit.

To help keep the hardware as simple as possible, which in turn keeps the costs down, the automatic capability of the simulated processor was removed and manual adjustments provided for the gain and threshold settings. The user is aided in setting these controls by a graphic display on the front panel which shows the captured signal burst (updated once per second with the latest captured burst), the triggering threshold level and the Fourier transform of the burst.

Other modifications include increasing the analog-to-digital converter from 2-bits to 8-bits for increased resolution and allowing the record length to be user adjustable from 32 to 4096 samples per burst. The increased resolution of the analog-to-digital converter is necessary to minimize harmonics in the frequency domain. The adjustable record length allows the user to choose from a high data acquisition rate, but at reduced measurement accuracy, using the minimum record length or maximum precision with 4096 samples per record if data rate is not important. The optimum compromise between acquisition rate and measurement accuracy was found through simulation to be 256 sample records.

The FDP-3100

The resulting hardware system, embodied as the FDP-3100 shown in figure 13, consists of the transient recorder and the signal processing section. The transient recorder contains an anti-alias filter, a variable gain amplifier, the analog-to-digital converter, the triggering circuitry, and the high-speed memory used as the shift register. The signal processing section consists of the digital signal processing chip with its program and data memories, and the input/output circuitry. The operation of the FDP-3100 can be best described by following a signal burst as it is processed.

The signal obtained from the photomultiplier in the laser velocimeter is conditioned by an anti-aliasing filter which removes high frequency noise attributable to the random arrival of photons (shot noise) and any harmonics from the chirp frequency. The conditioned signal is amplified by the variable gain amplifier whose gain is set from the front panel or controlling computer. The amplified signal is simultaneously passed to an analog filter bank for signal detection and to the 8-bit analog-to-digital converter, ADC, for digitizing. The output from the ADC is passed to high-speed static RAM operating as a shift register. The shift register can be set to capture from 32 to 4096 samples in a binary progression at the master clock rate. The analog filter bank divides the input bandwidth of 20 MHz into 16 sections with 4-pole bandpass filters. The bandwidth of each filter is $1/6^{\text{th}}$ of the center frequency of that filter. The center frequency of each filter is set so adjacent filters overlap at their respective 3 dB points. These filters provide a signal-to-noise improvement of 5-6 dB to any signal burst passing through the bank. The output from each filter is compared to the selected threshold setting. If any output exceeds the threshold, a trigger pulse is sent to the shift register to latch its contents, thus capturing the signal burst.

The latched signal burst is passed to the digital signal processor, DSP, for conversion to the frequency domain using a fast Fourier transform. The resulting frequency spectrum is interrogated to determine

if a signal burst was indeed captured. The user can select whether the peak ratio or the energy ratio validation algorithm is used. The peak ratio algorithm compares the ratio of amplitudes from the highest and next highest peak in the frequency spectrum to the user selected validation ratio. The energy ratio algorithm compares the ratio of energy contained in the highest peak and the total remaining energy to the user selected validation ratio. If the validation is successful, the measurement frequency is determined by a weighted statistical analysis of the peak in the spectrum. The result is then passed to the data acquisition system for analysis and storage.

Concluding Remarks

The development of a frequency domain signal processor for laser velocimeter applications has been described. The historical discussion showed that the early work was on the right track with frequency domain processing, but technology at the time did not provide the tools necessary to accomplish the task. The development of large scale integrated circuits and high-speed digital circuitry now makes a frequency domain processor possible. The development and verification of the approach was performed using computer simulation. While direct conversion to hardware was impractical in many cases, the basic approaches were. The resulting hardware system, the FDP-3100, increases the performance envelope of laser velocimeter signal processing while making it easier to obtain good quality measurements than present technology.

References

1. Huffaker, Robert M.; Fuller, Charles E.; and Lawrence, T. R.: Application of Laser Doppler Velocity Instrumentation to the Measurement of Jet Turbulence. [Preprint] 690266, Soc. Automotive Engineers, Jan. 1969.
2. Fridman, J. D.; Kinnard, K. F.; and Meister, K.: Laser Doppler Instrumentation for the Measurement of Turbulence in Gas and Fluid Flows. *Proceedings of the Technical Program - Electro-Optical Systems Design Conference*, Karl A. Kopetzky, ed., Industrial and Scientific Conference Management, Inc., c.1970, pp. 128-146.
3. Iten, Paul D.; and Mastner, Jiri: Laser Doppler Velocimeter Offering High Spatial and Temporal Resolution. *Flow - Its Measurement and Control in Science and Industry*, Volume One, Part Two, R.E. Wendt, Jr., ed., Instrument Soc. of America, 1974, pp. 1007-1013.
4. Lenert, A. E.; Smith, F. H., Jr.; and Kalb, H. T.: Application of Dual Scatter, Laser Doppler Velocimeters for Wind Tunnel Measurements. *International Congress on Instrumentation in Aerospace Simulation Facilities - ICLASF '71 Record*, IEEE Publ. 71-C-33 AES, Inst. of Electrical and Electronic Engineers, Inc., c.1971, pp. 157-167.
5. Asher, J. A.: LDV Systems Development and Testing. *The Use of the Laser Doppler Velocimeter for Flow Measurements*, W. H. Stevenson and H. D. Thompson, eds., Contract N00014-67-A0226-005, Purdue Univ., Nov. 1972, pp. 338-347. (Available from DTIC as AD 753 243.)
6. Meyers, J. F.; and Clemmons, J. I., Jr.: Frequency Domain Laser Velocimeter Signal Processor - A New Signal Processing Scheme. NASA TP-2735, Sep. 1987.
7. Griskey, R. G.; Balmer, R. T.; and Brinkley, J. L.: An Automatic Scanning LDV System. *Minnesota Symposium on Laser Anemometry - Proceedings*, E. R. G. Eckert, ed., Univ. of Minnesota, Jan. 1976, pp. 217-230.

8. Mayo, W. T., Jr.: Modeling Laser Velocimeter Signals as Triply Stochastic Poisson Processes. *Minnesota Symposium on Laser Anemometry - Proceedings*, E. R. G. Eckert, ed., Univ. of Minnesota, Jan. 1976, pp. 455-484.

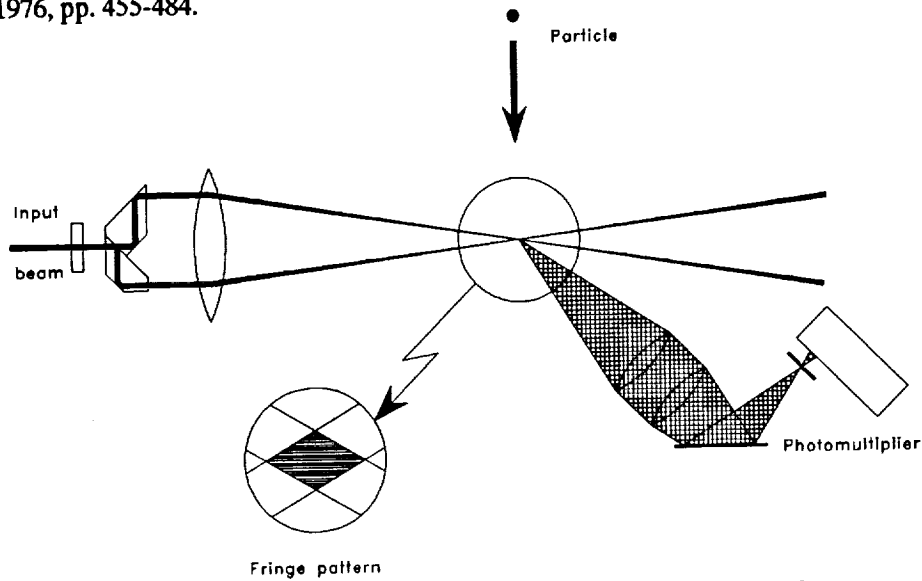
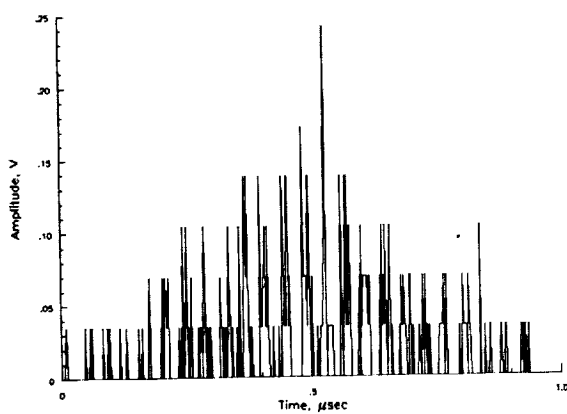
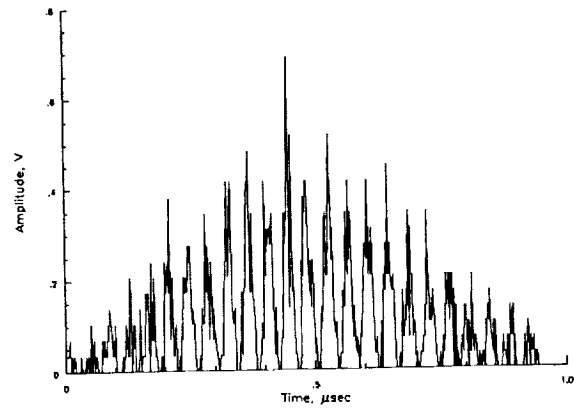

Figure 1. Schematic of a single component, fringe-type laser velocimeter.



(a) Signal burst containing 310 photons.



(b) Signal burst containing 1500 photons.

Figure 2. Signal burst from fringe-type laser velocimeter with modulation frequency of 25.0 MHz.

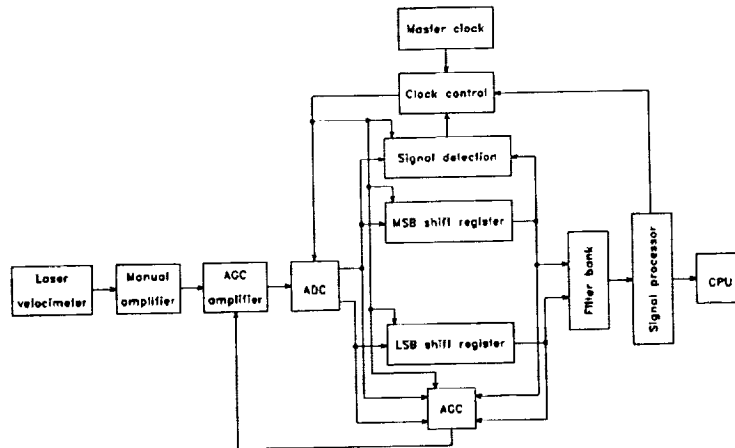

Figure 3. Block diagram of proposed frequency domain signal processor.

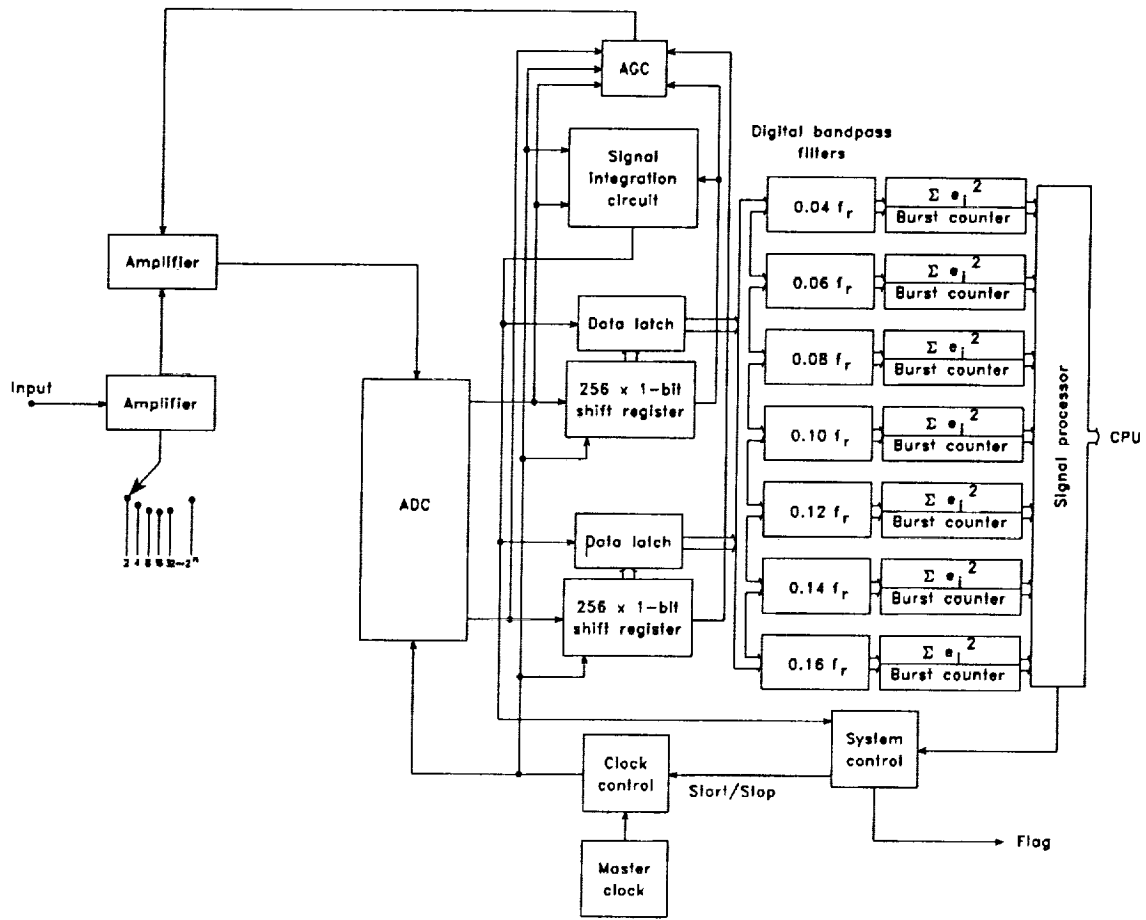
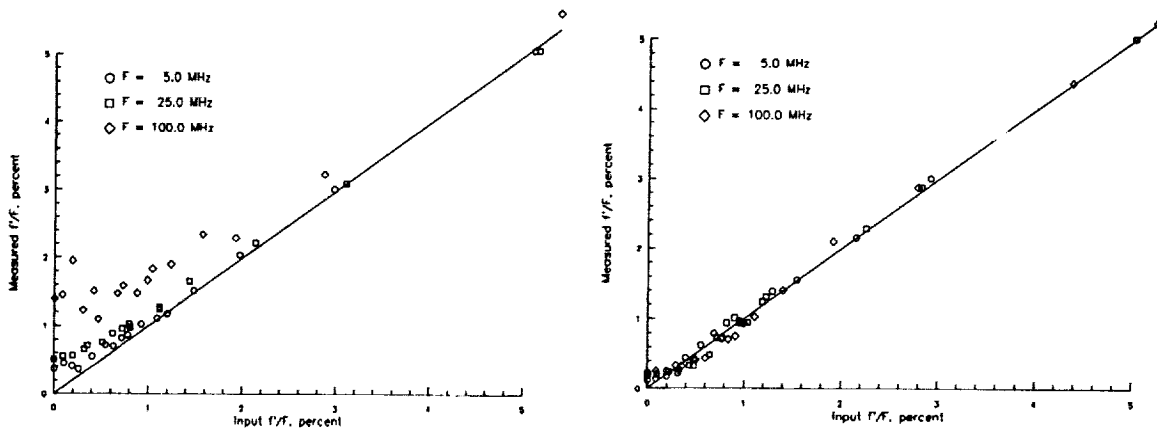

Figure 4. Schematic diagram of proposed frequency domain signal processor.



(a) High-speed burst counter.

(b) Frequency domain processor.

Figure 5. Simulation comparisons of input f/F to measured f/F with mean oscillation frequencies of 5.0 MHz, 25.0 MHz, and 100.0 MHz.

ORIGINAL PAGE IS
OF POOR QUALITY

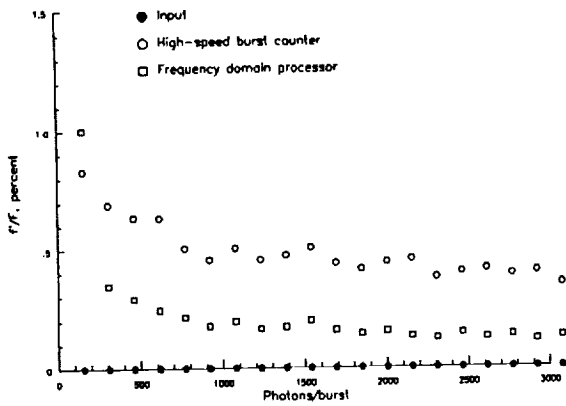

Figure 6. Simulation comparisons of input $f'/F = 0$ to measured f'/F for high-speed burst counter and frequency domain processor as a function of signal-to-noise ratio (photons/burst) at mean oscillation frequency of 25.0 MHz.

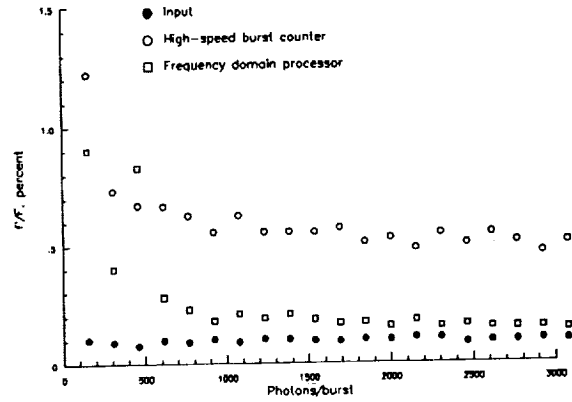

Figure 7. Simulation comparisons of input $f'/F = 0.1$ to measured f'/F for high-speed burst counter and frequency domain processor as a function of signal-to-noise ratio (photons/burst) at mean oscillation frequency of 25.0 MHz.

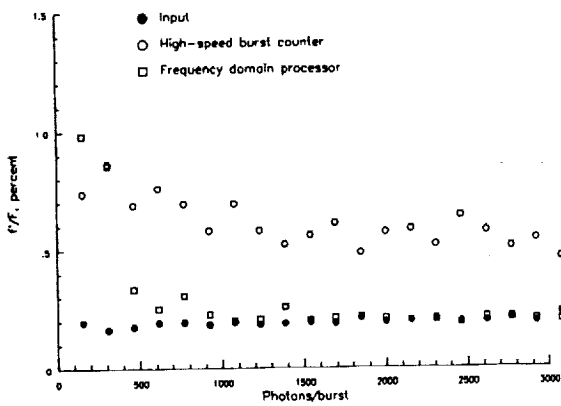

Figure 8. Simulation comparisons of input $f'/F = 0.2$ to measured f'/F for high-speed burst counter and frequency domain processor as a function of signal-to-noise ratio (photons/burst) at mean oscillation frequency of 25.0 MHz.

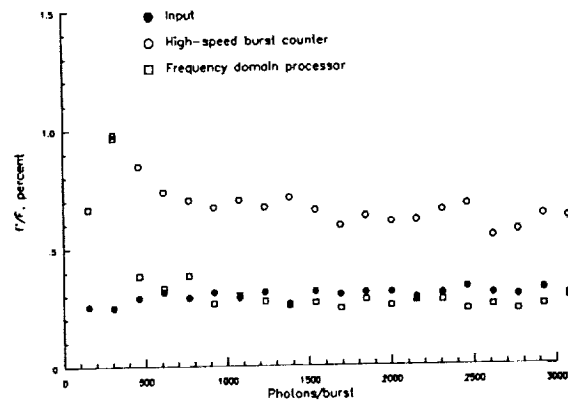

Figure 9. Simulation comparisons if input $f'/F = 0.3$ to measured f'/F for high-speed burst counter and frequency domain processor as a function of signal-to-noise ratio (photons/burst) at mean oscillation frequency of 25.0 MHz.

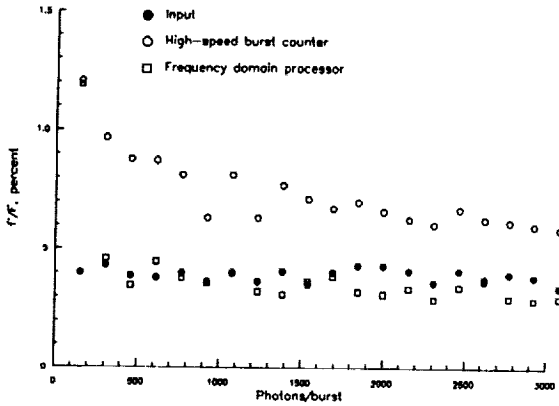

Figure 10. Simulation comparisons of input $f'/F = 0.4$ to measured f'/F for high-speed burst counter and frequency domain processor as a function of signal-to-noise ratio (photons/burst) at mean oscillation frequency of 25.0 MHz.

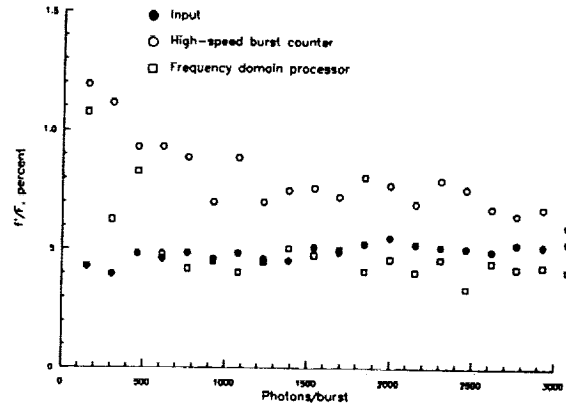

Figure 11. Simulation comparisons of input $f'/F = 0.5$ to measured f'/F for high-speed burst counter and frequency domain processor as a function of signal-to-noise ratio (photons/burst) at a mean oscillation frequency of 25 MHz.

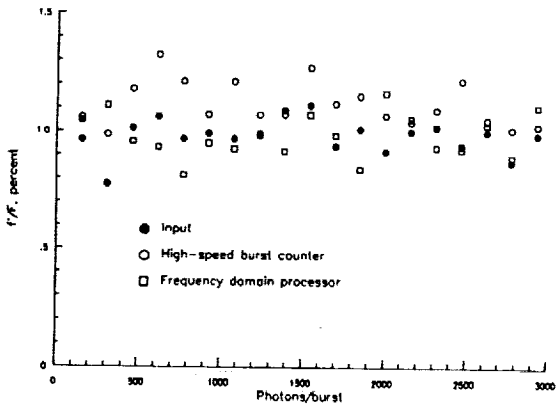

Figure 12. Simulation comparisons of input $f'/F = 1.0$ to measured f'/F for high-speed burst counter and frequency domain processor as a function of signal-to-noise ratio (photons/burst) at mean oscillation frequency of 25.0 MHz.

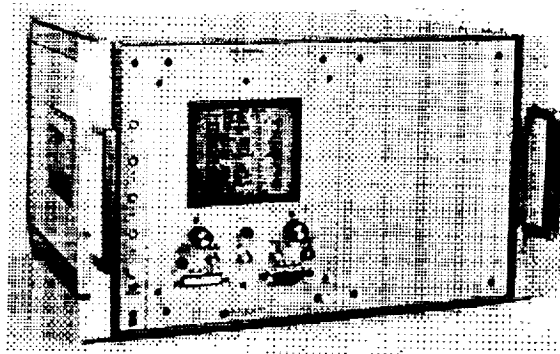

Figure 13. The FDP-3100 frequency domain processor.

ORIGINAL PAGE IS
OF POOR QUALITY