

5-2010

## Frequency Space Measurement of the Spectrum of a Mode-Locked Diode Laser

Brian Richards  
*College of William and Mary*

Follow this and additional works at: <https://scholarworks.wm.edu/honorstheses>



Part of the [Physics Commons](#)

---

### Recommended Citation

Richards, Brian, "Frequency Space Measurement of the Spectrum of a Mode-Locked Diode Laser" (2010). *Undergraduate Honors Theses*. Paper 705.  
<https://scholarworks.wm.edu/honorstheses/705>

This Honors Thesis is brought to you for free and open access by the Theses, Dissertations, & Master Projects at W&M ScholarWorks. It has been accepted for inclusion in Undergraduate Honors Theses by an authorized administrator of W&M ScholarWorks. For more information, please contact [scholarworks@wm.edu](mailto:scholarworks@wm.edu).

# Frequency Space Measurement of the Spectrum of a Mode-Locked Diode Laser

A thesis submitted in partial fulfillment of requirements for the degree of Bachelor of Science in  
Physics from the College of William and Mary in Virginia.

By

Brian Richards

Accept for: BS in Physics \_\_\_\_\_

(Honors)

\_\_\_\_\_  
Advisor: Dr. Seth Aubin

\_\_\_\_\_  
Dr. Charles Perdrisat

\_\_\_\_\_  
Dr. John Delos

\_\_\_\_\_  
Dr. Chi-Kwong Li

Williamsburg, Virginia

April 2010

## **Abstract**

This thesis presents the development of a method for the direct measurement of the spectrum of a mode-locked diode laser using the beat note between the mode-locked laser and a continuous wave laser. This beat note frequency allows for the measurement of the optical frequency comb created by the mode-locked diode laser. The spectrum of the mode-locked diode laser was optimized using a spectrometer and an electronic amplification and filtering circuit was created to try and see the beat note frequency as it is expected to be small compared to the higher frequency terms created by the mode-locked diode laser. A beat note was observed with the diode laser in continuous wave mode and in a partially mode-locked state. The beat note with the diode laser in full mode-locking was not seen and various methods are suggested to explain and resolve this difficulty.

## **Acknowledgements**

I would like to thank Dr. Seth Aubin for the time and help that he has given me as I have taken this project from start to finish. I would like to thank Megan Ivory, Jim Fields, and Austin Ziltz for all of their help in the lab. I would also like to thank Brian DeSalvo and Trevor Harrison for all the work they did on this project before me that has allowed me to do all the work I have done. Finally, I would like to thank my family and friends for everything they have done to get me to where I am today.

<b>Table of Contents:</b>	<b>Page:</b>
<b>1. Introduction</b>	<b>6</b>
<b>2. Theory</b>	<b>7</b>
2.1 Optical Frequency Comb	7
2.2 Mode-Locked Lasers	9
2.2.1 Methods of Mode-Locking	9
2.2.2 Mode-Locked Diode Laser Testing	11
2.3 Beat Frequency	12
<b>3. Experimental Setup and Approach</b>	<b>16</b>
3.1 Optimization of Mode-Locked Diode Laser	16
3.2 Beat Frequency Measurement	19
3.2.1 Femtosecond Mode-Locked Titanium-Sapphire Laser	19
3.2.2 Mode-Locked Diode Laser	21
3.3 Electronic Filtering and Amplification	23
3.3.1 Stub Filter	23
3.3.2 Characterization of Filtering and Amplification	24
<b>4. Experimental Results and Analysis</b>	<b>27</b>
4.1 Continuous Wave Beat Frequency	27
4.2 Partially Mode-Locked Beat Frequency	28
4.3 Mode-Locked Beat Frequency	29
4.3.1 Stabilization	31
4.3.2 Changes in Optical Spectrum due to Optical Filtering	32
<b>5. Outlook</b>	<b>35</b>

	<b>Page:</b>
5.1 Future Recommendations	37
<b>6. References</b>	<b>38</b>
<b>7. Appendix</b>	<b>39</b>

## 1. Introduction

Frequency and wavelength measurements of a laser are difficult to make with extreme precision. A high-resolution spectrometer can provide a precision of 0.5 nanometers (approximately 500 GHz at 780 nm) at Full-Width-Half-Maximum (FWHM). A FWHM measurement is one where the width of a spectrum is measured at half of the maximum of the spectrum. A wavemeter can provide precision of approximately 300 MHz depending on the quality of the meter. To get precision measurements of frequencies below 300 MHz, other methods must be employed. Higher precision is necessary to stabilize the frequency of a laser for use in precision spectroscopy. To reach this higher precision, an optical frequency comb may be employed to give measurements with an accuracy of 1 MHz or smaller. The optical frequency comb will act as a ruler to measure the difference between two lasers and stabilize one laser to another.

The primary objective of this research was to make a measurement of the optical frequency spectrum of a mode-locked diode laser. Optical frequency combs have been implemented in the past primarily using a femtosecond Titanium-Sapphire (Ti:Sapph) laser in mode-locking. For our research, the laser used to implement the comb was a mode-locked diode laser which is considerably cheaper though it does not have the bandwidth of a femtosecond Ti:Sapph laser. The measurement of the spectrum can be done by measuring the beat note frequency between a continuous-wave mode laser and the mode-locked diode laser.

This research also examines methods to characterize and optimize the comb width and pulse duration of the mode-locked diode laser by making adjustments to the laser cavity, RF modulation frequency and amplitude, and temperature control. The goal for this was to optimize the bandwidth of the optical frequency comb and create the most symmetric comb possible. A

brief examination of active and passive mode-locking was also made in regards to passive mode-locking being done by the diode laser outside of typical active mode-locking. This involved methods to stabilize the optical frequency comb of the mode-locked diode laser. Eventually, the optical frequency comb will be used as part of a stabilization system tied to an atomic or molecular transition of ultra-cold molecules being produced in the Ultra-Cold AMO Laboratory of Professor Seth Aubin. In section 2 of this thesis I will present the theory surrounding optical frequency combs, mode-locked lasers, and beat notes. In section 3 I will present the experimental setup and approach used in optimizing the mode-locked diode laser, measuring the beat frequency between a mode-locked diode laser and a continuous wave laser, and the electronic filtering and amplification used. In section 4 I will present the results of these experiments and show a beat note frequency with both beams in continuous wave mode, one of them partially mode-locked, one of them fully mode-locked. Section 4 will show that though a beat note was seen without the mode-locking, the existence of the optical frequency comb is in question. In section 5 I will present the outlook for this project and what can be done to improve the quality of the experiment.

## **2. Theory**

### **2.1 Optical Frequency Comb**

The optical frequency comb is a set of evenly spaced Dirac delta functions in frequency space created by overlapping frequencies that will be separated by the free spectral range (FSR) or an RF modulation matched to the FSR of the laser cavity. These evenly spaced Dirac delta functions act as a ruler in frequency space as seen in Figure 1, allowing the frequencies of others lasers to be measured. The optical frequency comb can be implemented using a laser in either active mode-locking or passive mode-locking and will be detailed later.



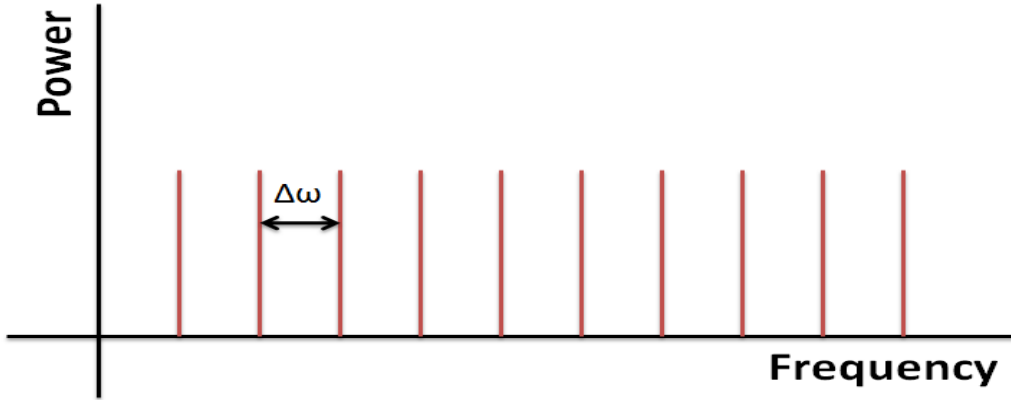

Figure 1: Evenly spaced Dirac delta functions create a comb-like structure in frequency space that can act as a frequency ruler.

The optical frequency comb can be used to measure the frequency difference between two lasers using the nature of the evenly spaced comb teeth as seen in Figure 2. To measure  $\Delta F_{TOTAL}$  a wavemeter is used to get a general reading of the frequency of the two lasers. From that, the general position of the laser within the comb can be determined along with the number of comb teeth separating the two lasers. From there, the frequency difference between each laser and the nearest comb tooth can be determined by overlapping the optical frequency comb signal with the continuous wave laser signal and measuring the beat note frequency. The production and measurement of the beat note frequency is discussed in greater detail in section 2.3. Once the beat note frequency has been determined for both lasers, it is summed with the number of comb teeth between the lasers to give  $\Delta F_{TOTAL}$ .

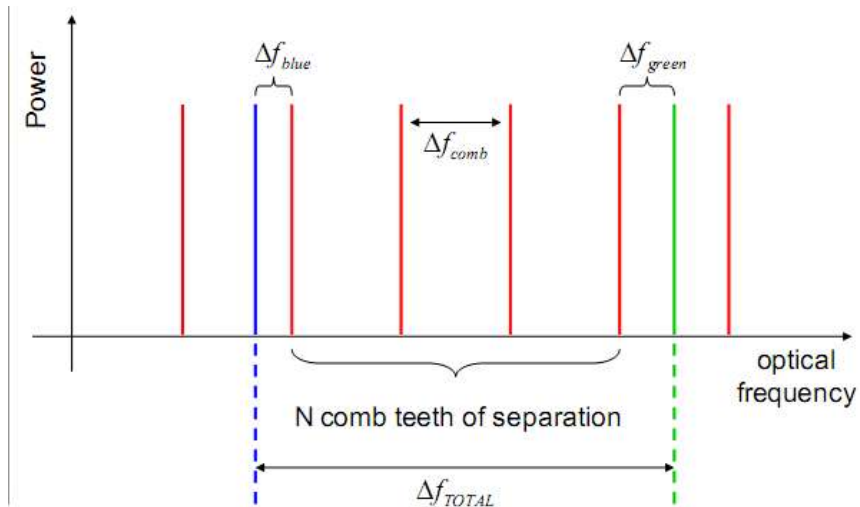

Figure 2: The even spacing of the comb teeth as well as the separation between two lasers can be seen. The green and blue lasers represent two continuous wave lasers being compared using the optical frequency comb.

## 2.2 Mode-Locked Lasers

### 2.2.1 Methods of Mode-Locking

Mode-locking occurs when a laser has a pulsed output in the time domain. There are two standard ways of achieving pulsed output; passive mode-locking and active mode-locking. Passive mode-locking relies on the FSR of the laser cavity to provide the pulse repetition rate and uses a saturable absorber as an output coupler. The saturable absorber selectively transmits beams of high intensity while reflecting beams of low intensity [1]. As the beams return to the gain medium and reflect again, they will be amplified and slowly more will escape the laser cavity as seen in Figure 3. If the beam returns to the gain medium when the gain medium is at a maximum, then the beam will gain an extra amount of power. If this is enough to go past the threshold of the saturable absorber, then a pulse will be emitted. If it is not intense enough, it will reflect and either be selectively amplified if it returns to the gain medium at a maximum of the gain medium modulation or not be amplified if it returns at a minimum. Eventually a pulsed output will be achieved with a time between pulses equal to the FSR of the laser cavity. The FSR

of the laser cavity should be chosen such that the pulses will return to the gain medium at a maximum in the modulation.

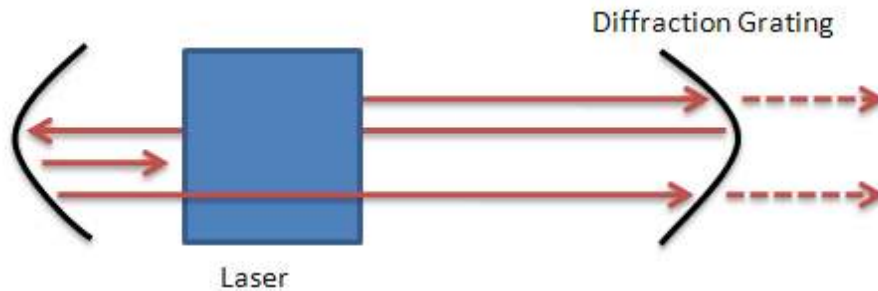

Figure 3: Schematic for the cavity of a diode laser. The blue square is the gain medium used to create the laser. In the case of a diode laser making use of passive mode-locking, the diffraction grating would be replaced with a saturable absorber. The diffraction grating would be used in the case of a diode laser in active mode-locking.

For this research, active mode-locking was used to create the optical frequency comb.

Active mode-locking uses an RF generator to create an oscillation within the gain medium. The RF generator provides a driving frequency of approximately the FSR of the laser cavity to the diode laser and leads to a pulsed output by the laser. Pulsed output is obtained the same way as with passive mode-locking. Instead of a saturable absorber as the output coupler, a diffraction grating is used that reflects most of the signal back into the laser cavity. The signal will be selectively amplified if the RF modulation is set to the FSR of the laser cavity because the signals will be returning to the gain medium at a peak of the RF modulation as seen in Figure 4. If the reflection reaches the gain medium during the low point of the RF modulation, the beam will not be amplified and eventually dissipate. This will lead to pulsed output as the only signal that remains is the signal that was continuously amplified.

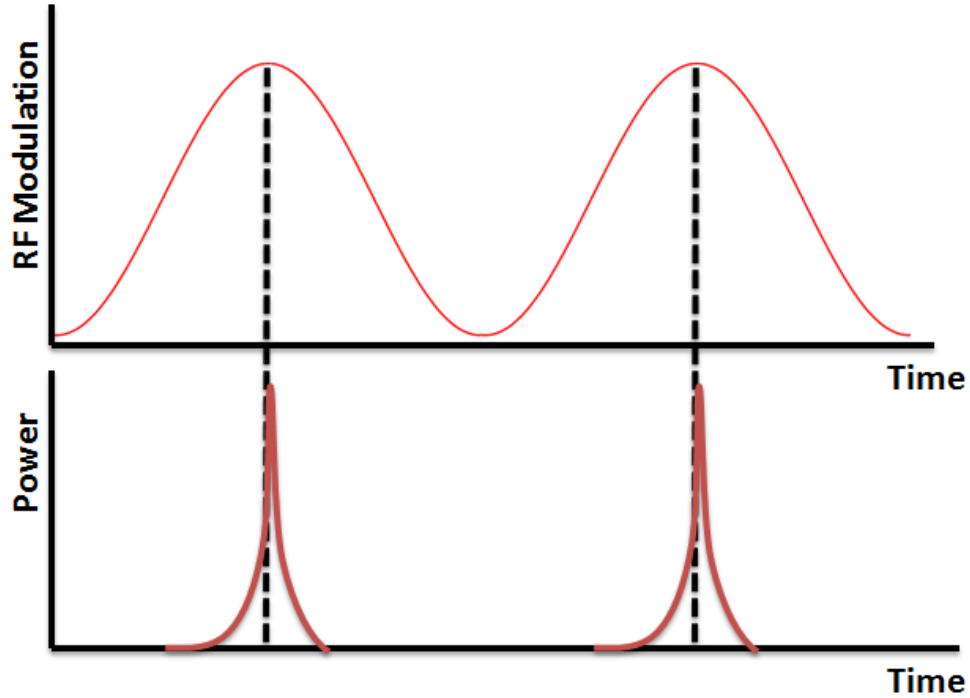

Figure 4: This shows the RF modulation and power of the diode laser as a function of time. The maximum of the RF modulation falls when the laser signal returns to the gain medium and gets amplified. Over time this will lead to a pulsed output as the pulses will continue to be amplified while everything else will eventually fade out.

### 2.2.2 Mode-Locked Diode Laser Testing

The performance of the mode-locked laser needed to be verified before any experiment could begin. This was done by focusing the laser signal onto a fast photodiode and reading the data on a 1 GHz bandwidth oscilloscope. The setup used to verify mode-locking can be seen in Figure 5.

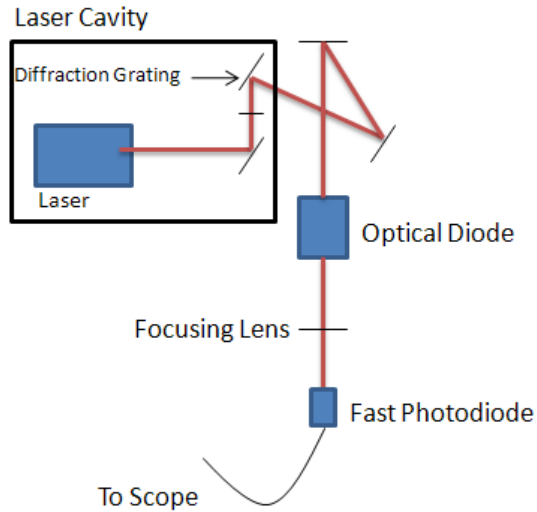

Figure 5: Setup used to verify active mode-locking

After several adjustments to the mirrors and focusing lens, mode-locking was observed. To achieve mode-locking, the mirrors had to be adjusted several times and cleaned using compressed air. The dust buildup on the mirrors appears to have caused previous attempts to mode-lock the laser to fail. The 1 GHz oscilloscope was also tested to verify that the oscilloscope was able to handle signals of up to 1 GHz. Data from these previous attempts can be seen in the Appendix and the mode-locked laser output can be seen in Figure 6.

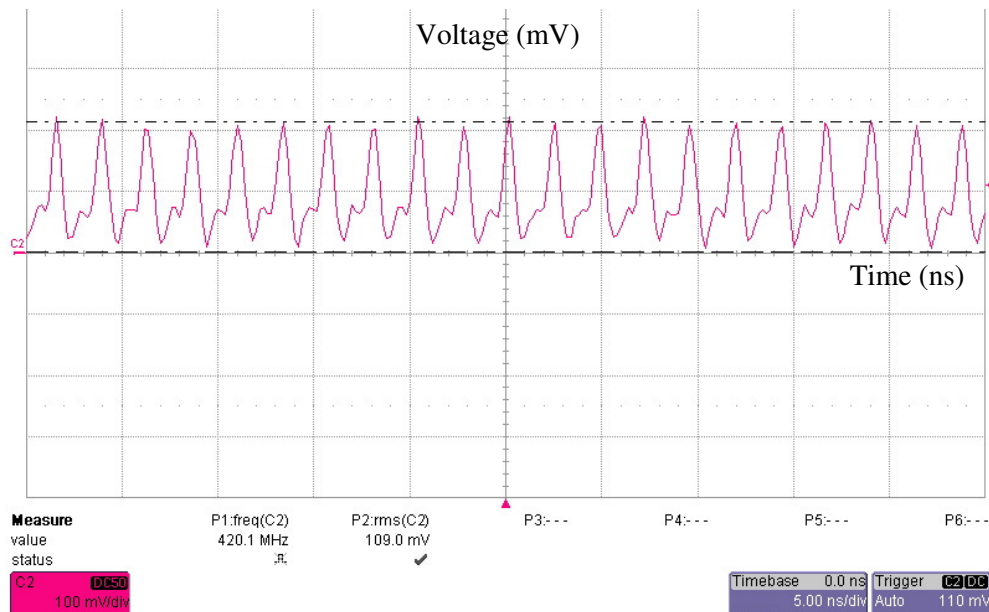

Figure 6: Pulsed output of a diode laser in active mode-locking.

### 2.3 Beat Frequency

To determine the frequency difference between a continuous wave laser and the nearest comb tooth of the optical frequency comb the beat note frequency of the two lasers is examined. The beat note frequency is the frequency of the envelope seen when the two laser beams are made collinear and have parallel polarization such that they interfere with one another. When the two laser beams are combined, the beat note will give the relative position of the continuous wave laser to one of the comb teeth. The beat note frequency is determined according to equation 1 below.

$$|\mathbf{E}_1 + \mathbf{E}_2|^2 = \frac{1}{2}(E_1^2 + E_2^2) + \frac{1}{2}E_1^2 \cos(2\omega_1 t) + \frac{1}{2}E_2^2 \cos(2\omega_2 t) + E_1 E_2 \cos((\omega_1 + \omega_2)t) + E_1 E_2 \cos((\omega_1 - \omega_2)t) \quad (1)$$

where  $\mathbf{E}_1$  and  $\mathbf{E}_2$  are the electric fields of the two lasers and  $\omega_1$  and  $\omega_2$  are the frequencies of the respective laser beams. All terms other than the beat note term will produce a frequency that is too large to be measured by the equipment available in the laboratory. Therefore, the only frequency that will be seen by the oscilloscope will be the beat note frequency (the last term in equation 1). The beat note frequencies of the two lasers being compared by the optical frequency comb can then be determined and summed with the number of comb teeth separating the beams to give the total frequency separation. In the time domain, the pulse train created by the mode-locked laser diode and the additional continuous wave laser can be seen below in Figure 7. This simulation used a comb spacing of 10 ns and a frequency of 3/5 the comb spacing for the continuous wave laser and was created by summing over 20 iterations of the pulse (sum over electric fields of frequency  $\omega$  to frequency  $\omega + 20\Delta\omega$ ) and the continuous wave electric field and taking the square of the sum.

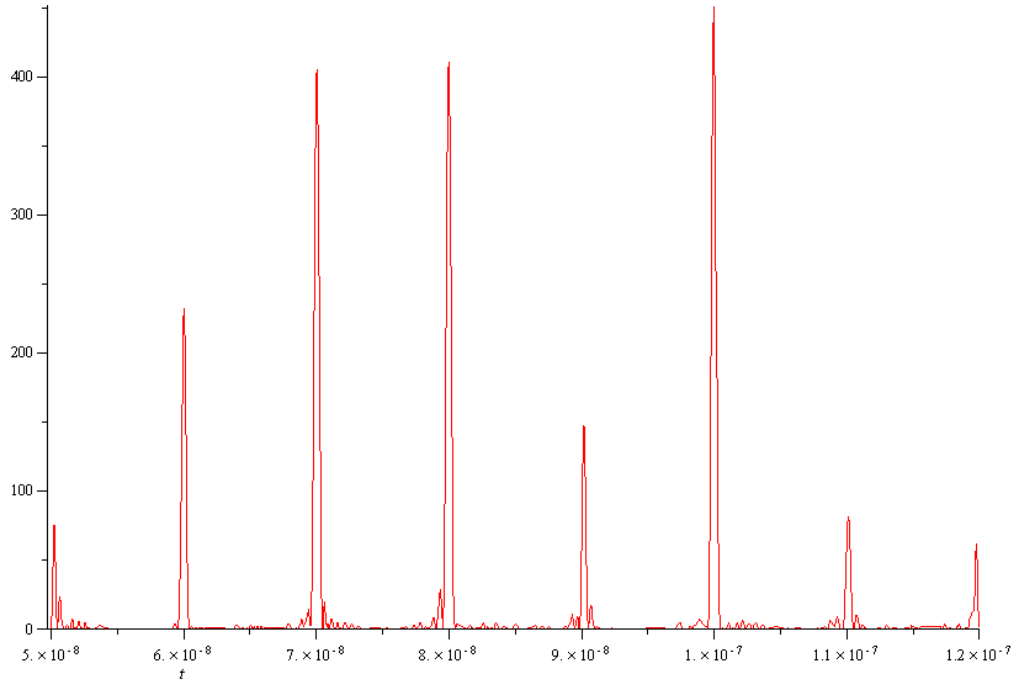

Figure 7: Simulated mode-locked laser in the time domain with the added continuous wave laser.

The peaks seen in Figure 7 are actually artifacts of the plotting process in Maple. The actual peak of one of the pulses can be seen in Figure 8. This peak was found by zooming in on the individual peak so that the program could resolve the peak itself. This was done for the first 32 peaks in the simulation and eventually gave the actual heights of the pulses.

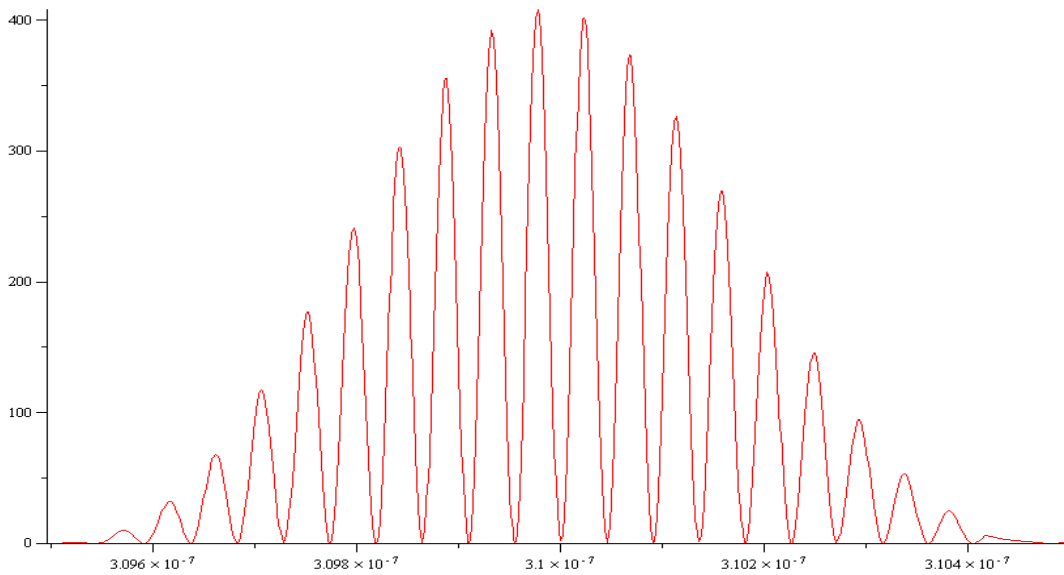

Figure 8: Single pulse of the overlapping electric fields as simulated by Maple.

The peaks of each pulse were recorded and then plotted using Microsoft Excel as can be seen below in Figure 9. Low values were included between the pulses to make the data in the plot appear closer to the pulse shape that should appear. This was also done to allow the Fourier analysis program included with Excel to return a larger range of frequencies.

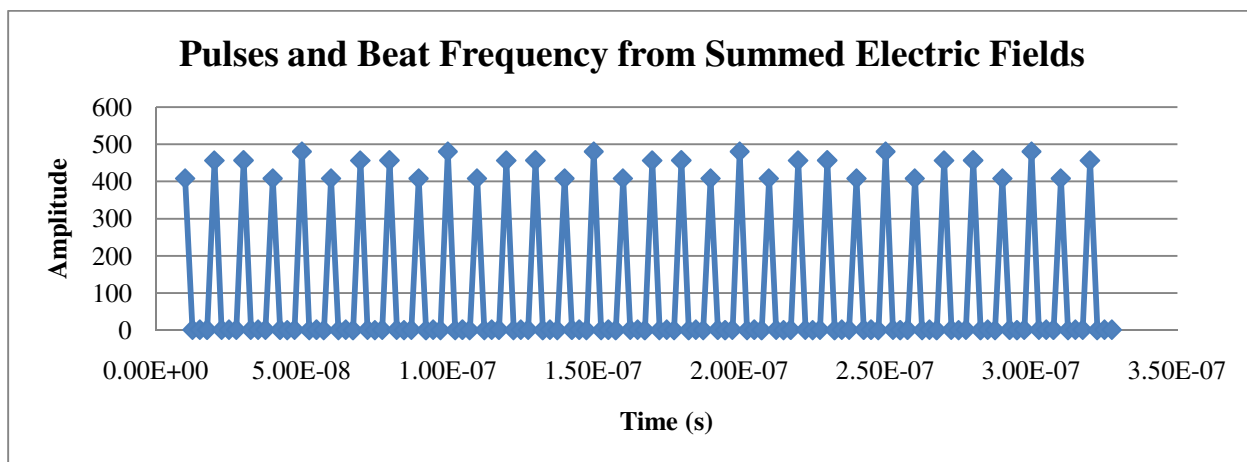

Figure 9: Pulses and Beat Frequency from summation of electric fields.

This data was then transformed into frequency space using the Fourier Analysis tool included with Excel. The data returned from the Fourier transform shows large peaks at 100 MHz and its harmonics as well as peaks at 60 MHz and 40 MHz, the frequencies expected for the beat note frequency. There are also peaks at 160 and 140 MHz, which would be the beat note frequency between the continuous wave laser and the next highest comb tooth in the optical frequency comb. The Fourier transform of the data can be seen below in Figure 10. This is what we expect to see when we look at the overlapping electric fields of the mode-locked diode laser and the continuous wave Ti:Sapph laser.



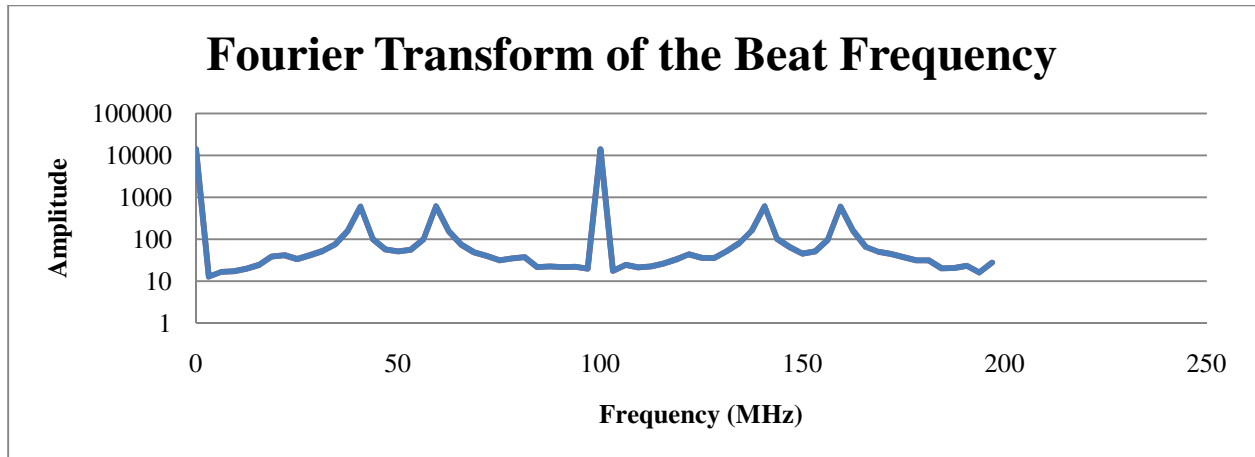

Figure 10: Fourier transform of the beat frequency data. A large peak is seen at both the DC point and the 100 MHz point. The 100 MHz peak corresponds to the beat note between the peaks of the optical frequency comb. The peaks at 40 and 60 MHz are the beat frequency peaks of the continuous wave laser and the nearest comb. The 140 and 160 MHz terms are the beat frequency peaks of the continuous wave laser and the next nearest comb.

The signal that is the beat frequency can be determined by adjusting the frequency of the continuous wave laser and observing how the peaks move. The two beat notes (40 and 60 MHz above) should move in opposite directions as the frequency is adjusted. This will let you know that the peaks are the beat note frequencies and note an artifact of the measurement and analysis techniques.

### 3. Experimental Setup and Approach

#### 3.1 Optimization of Mode-Locked Diode Laser

The first step of the research was to optimize the bandwidth of the mode-locked spectrum of the optical frequency comb. This was done by sending the mode-locked diode laser signal to a high resolution Ocean Optics spectrometer as seen in Figure 11. To prevent saturation of the high resolution spectrometer, various apertures both inside and outside of the laser cavity were closed and a neutral density filter was placed before the spectrometer.

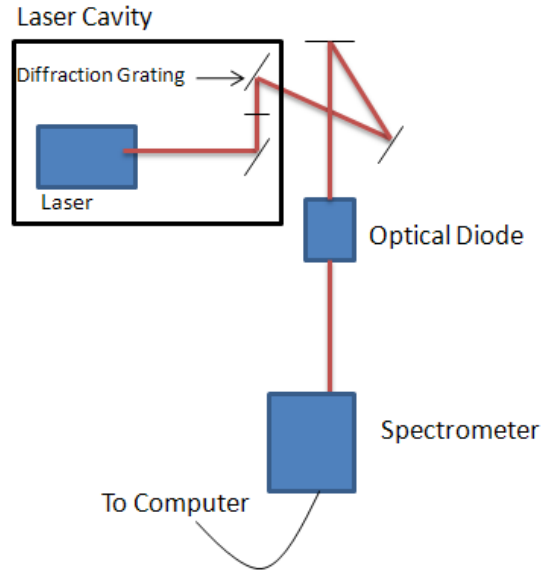

Figure 11: Setup to record the spectrum of the mode-locked diode laser

The data from the spectrometer was read using the OOIBase32 software that came with the spectrometer. The FWHM of the spectrum was measured visually as the frequency, amplitude, set current, and temperature of the mode-locked diode laser were varied. The width was found by measuring the two points on the curve at half of the maximum of the intensity. Once these points were found, their difference was taken to find the width of the spectrum. Due to the limitations of the software, the FWHM had to be determined by hand and could not be automated for better accuracy. The spectrum of the mode-locked diode laser can be seen in Figure 12.

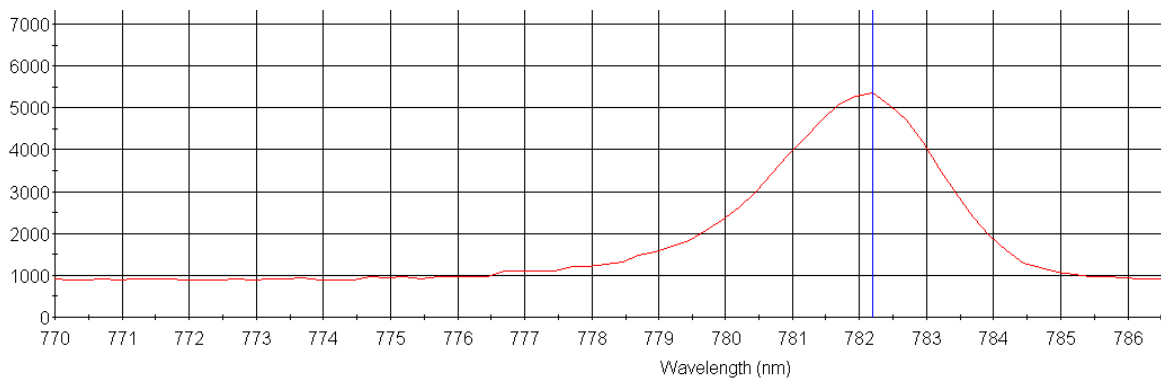

Figure 12: Spectrum of the mode-locked diode laser at 460 MHz and -7 dBm

The resolution limitations of the spectrometer may have led to incorrect measurements and the bandwidth of the spectrums being wider than they actually are. According to specifications provided by Ocean Optics [2], the high resolution spectrometer should have a FWHM resolution of 0.75 nm. Due to the resolution, outputs with multiple modes may resolve as a single mode from the spectrometer. This can be seen below in Figure 13 where the output has multiple bumps or peaks that better resolution may have shown to be separate modes. The possibility of multiple modes was seen when the iris within the laser cavity was opened and the frequency of the RF modulation was tuned to 420 MHz.

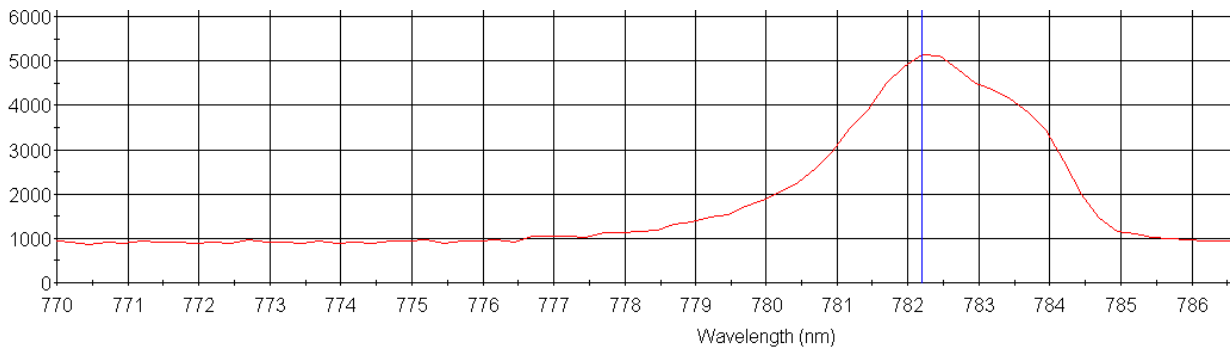

Figure 13: Spectrum of the mode-locked diode laser at 420 MHz displaying the possible existence of multiple modes. This was observed by opening the iris within the laser cavity which may have led to a partial hybrid passive and active mode-locking system

The values of the FWHM spectral width were plotted to show the optimal values and the results can be seen in Figures 14 and 15 below. The results have allowed for a better adjustment of the laser for as large of a spectral width as possible. The wider the spectral width is, the larger the range of frequencies the optical frequency comb will cover. The temperature optimization of the mode-locked diode laser showed that the spectral width stayed mostly constant with the only major change being the center point of the spectrum shifting. This will help in tuning the optical frequency comb to a certain center wavelength.

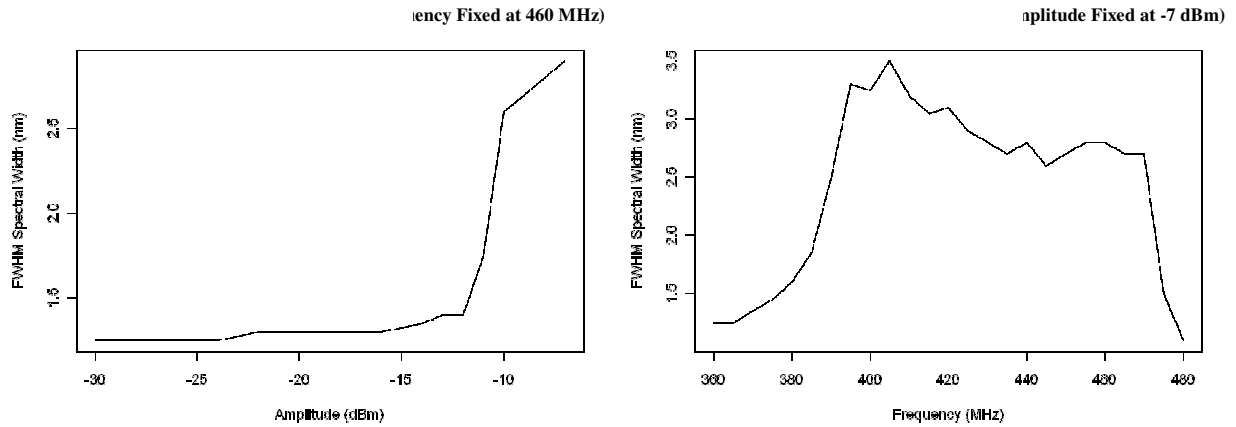

Figure 14: Amplitude Optimization of Mode-Locked Diode Laser Spectrum (Left)  
 Frequency Optimization of Mode-Locked Laser Spectrum (Right)

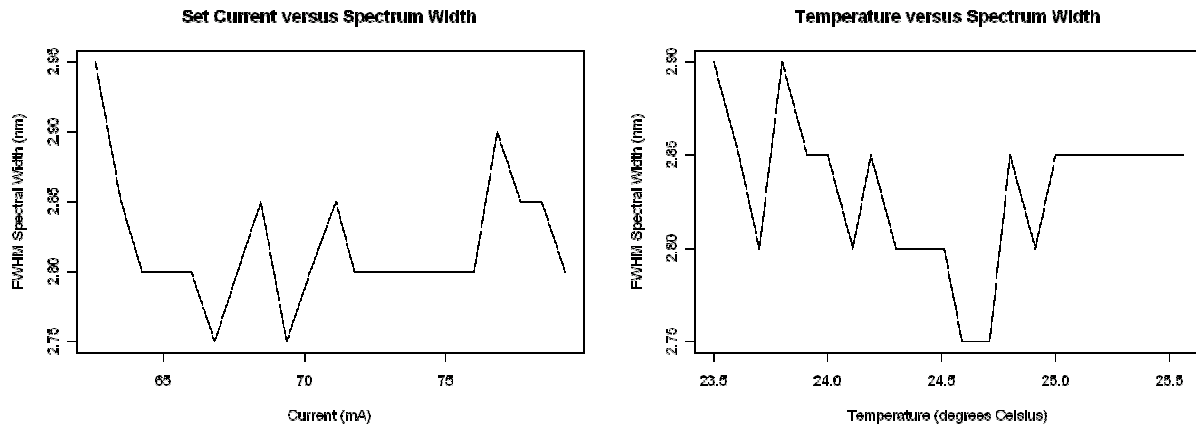

Figure 15: Set Current Optimization of Mode-Locked Diode Laser Spectrum (Left)  
 Temperature Optimization of Mode-Locked Diode Laser Spectrum (Right)

### 3.2 Beat Frequency Measurement

#### 3.2.1 Femtosecond Mode-Locked Titanium-Sapphire Laser

To create and test the setup for the beat frequency experiment, a femtosecond mode-locked titanium-sapphire laser was used to create the optical frequency comb. The Ti:Sapph laser was used because previously most optical frequency combs have been implemented using a femtosecond Ti:Sapph laser. The femtosecond Ti:Sapph laser has been well-characterized and a well-characterized continuous laser was used to create the beat frequency. The two beams were combined using a 50-50 beam splitter and sent to a photodiode as seen in Figure 16.

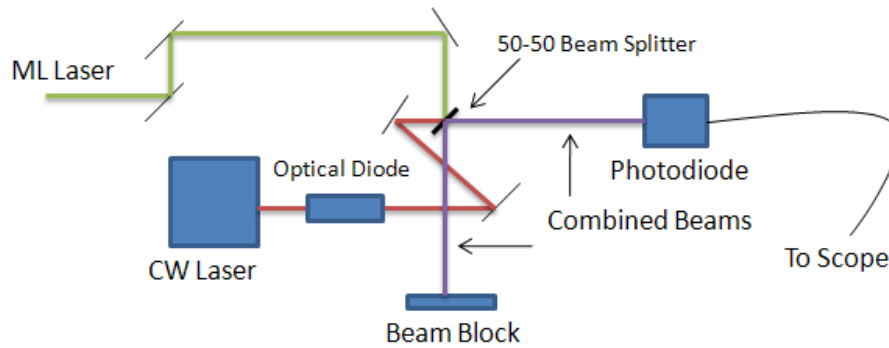

Figure 16: Setup for the beat frequency measurement using the femtosecond mode-locked Ti:Sapph laser.

To prepare for actual measurements of the optical frequency comb, the average power per tooth of the femtosecond titanium-sapphire laser was calculated. First, the FWHM spectral width was converted into frequency and found to be 48 THz. From that, the number of teeth in the comb was calculated to be approximately 560000 teeth. The average power of the laser was measured to be 450 mW, leading to an average power per tooth of  $0.8 \mu\text{W}/\text{tooth}$ . The spectrum of the femtosecond Ti:Sapph laser was measured using the spectrometer. The spectrometer showed that the majority of the signal was centered over approximately 830 nm with only a small amount of signal in the range of 784 nm as seen in Figure 17 below. The spectrum also displayed multiple modes which may have meant that two separate optical frequency combs were created. Reproducing the mode-locked state of the femtosecond Ti:Sapph emerged as a problem when the position of the prism used in the laser cavity could not be reproduced. The translation stage that the prism sat on would occasionally move to a different position, meaning that the prism had to be moved by hand in order to achieve mode-locking. Also, the femtosecond Ti:Sapph laser would typically fall out of mode-locking within a few minutes of achieving it.

Because the power per comb tooth of the femtosecond Ti:Sapph laser was so low, the power per comb tooth of the mode-locked diode laser was also computed to see if the beat note would be easier to see there. The FWHM spectral width of the diode laser, after being converted to frequency, was 1.5 THz and the number of comb teeth was approximately 3600 teeth. The

average power of the beam was measured to be 16.2 mW, leading to a power per tooth of 4.5  $\mu\text{W}/\text{tooth}$ . Since the power per comb tooth of the diode laser was higher than that of the femtosecond Ti:Sapph, the decision was made to attempt the beat note measurement with the mode-locked diode laser instead of the femtosecond Ti:Sapph laser. The chances of seeing the beat frequency here was minimal and the Ti:Sapph was not stable enough to be used reliably. Also, the spectrum of the Ti:Sapph proved difficult to move closer to the 784 nm wavelength of the continuous wave laser used in this part of the experiment.

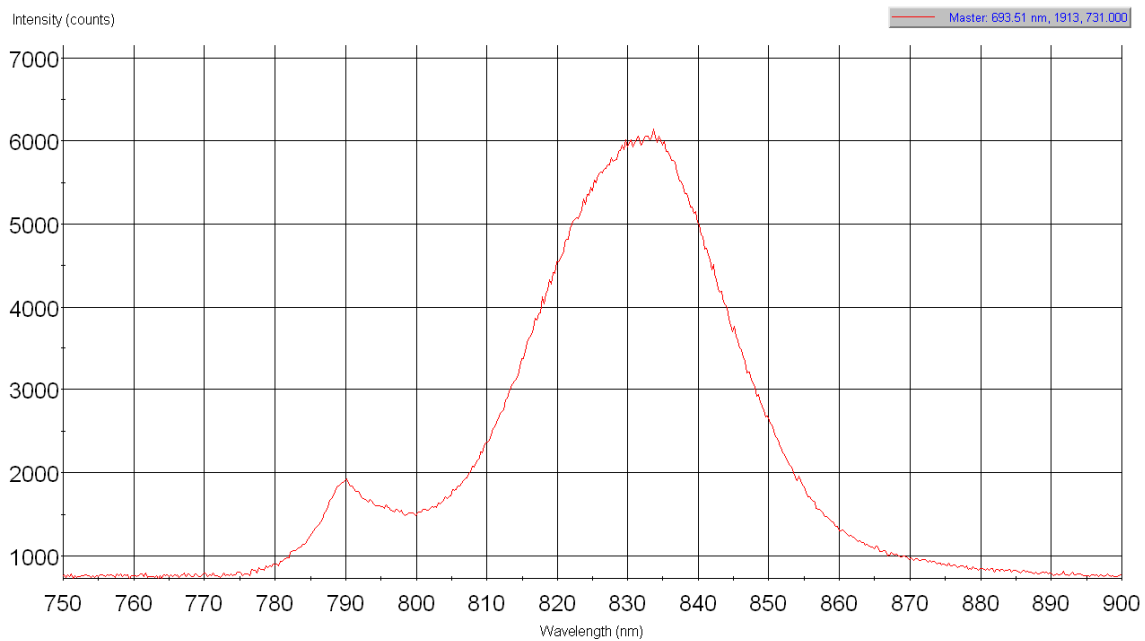

Figure 17: Spectrum of the femtosecond Ti:Sapph laser showing little signal over the 784 nm range and multiple modes.

### 3.2.2 Mode-Locked Diode Laser

After shifting away from the experiment with the femtosecond Ti:Sapph laser, the mode-locked diode laser was moved into the main laboratory and setup to look for the beat note frequency. Again, a 50-50 beam splitter was used to combine the signals from the mode-locked diode laser and a tunable continuous wave Ti:Sapph laser. The Ti:Sapph laser was kept on a separate table and the signal from it was brought over using a single-mode optical fiber. The

beams were made co-linear and one of the combined beams was sent to a fast photodiode while the other beam was sent to a wavemeter by optical fiber. A glass plate was also used to pick off a reflection that was sent to the spectrometer. The experimental setup can be seen below in Figure 18.

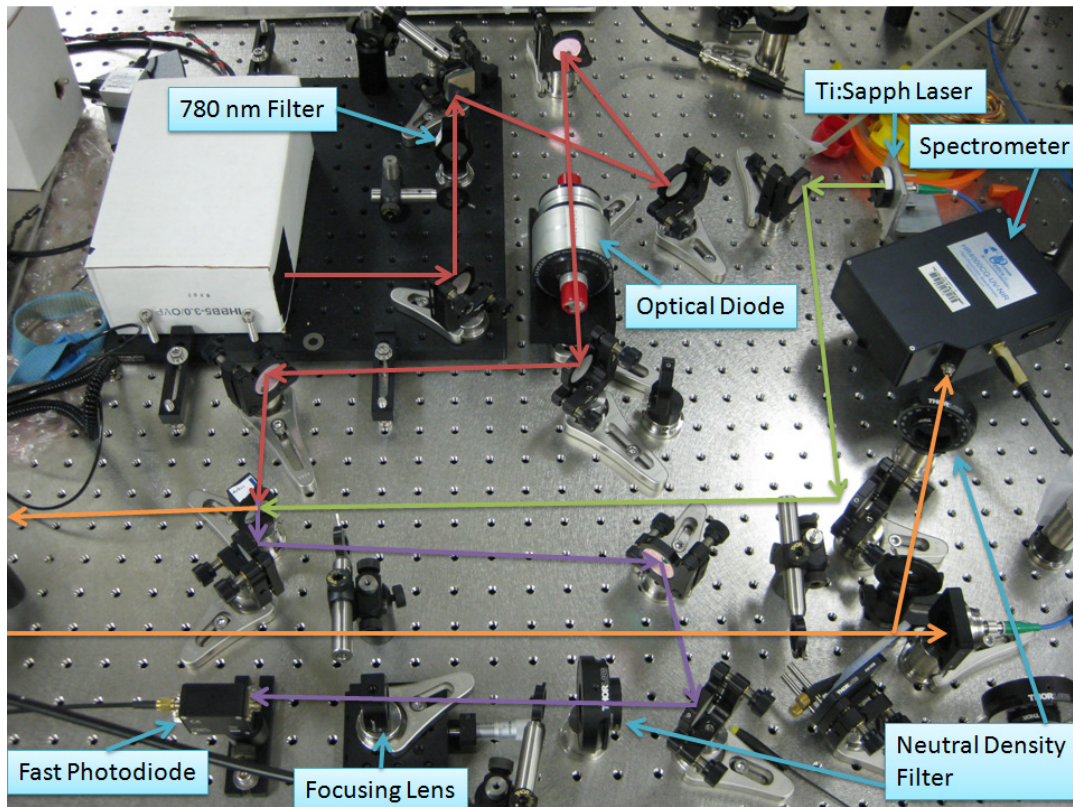

Figure 18: Setup for the beat note frequency experiment using the mode-locked diode laser. The diode laser is shown in red. The Ti:Sapph is shown in green. The combined beam sent to the spectrometer and fiber coupler is shown in orange. The combined beam sent to the photodiode is shown in purple.

The signal from the fast photodiode was sent to an amplifier and an electronic filtering setup that will be described later and eventually sent to a 1 GHz oscilloscope. The neutral density filters pictured above were used to prevent saturation of both the spectrometer and the fast photodiode. The 780 nm filter pictured was used to attempt to stabilize the optical frequency comb and will be discussed later.

The beat note frequency was searched for by making the diode laser and Ti:Sapph laser collinear. From here, the interference between the two should have produced a beat note

frequency. The signal was sent to an oscilloscope with a Fast Fourier Transform function. This function was used to display the signals in frequency space. Here the 460 MHz signal was seen as well as the higher harmonics. The 460 MHz signal appeared to dominate the other signals coming through, so filtering was implemented to prevent the 460 MHz signal and higher harmonics from swamping the lower frequency beat note signal. An amplifier was then used to magnify the beat note frequency signal. The beat frequency was first searched for with both lasers in continuous wave mode and then with the diode laser being slowly brought into mode-locking.

### **3.3 Electronic Filtering and Amplification**

#### **3.3.1 Stub Filter**

The first filter implemented to reduce the impact of the 460 MHz signal was a stub filter. A stub filter is a notch filter made entirely using coaxial cable and acts as a Michelson Interferometer using cables and electrical signals instead of mirrors and optics. The incoming signal is split into two different signals, one which eventually goes to the output and a second branch that has a specially chosen length ( $1/4$  the wavelength that needs to be filtered). By not terminating the end of the second path, the signal will be reflected perfectly out of phase with the output path. This will lead to destructive interference of the signal that needs to be filtered. In our stub filter, a coupler was used to prevent the reflections from filter returning by the way of the input and breaking the equipment. The setup for the stub filter can be seen below in Figure 19.

The filter was characterized to see how well it filtered out the signal by connecting it to the RF generator used by the diode laser. The RF generator was then scanned through a range of frequencies and the voltage was recorded as seen in Figure 20. The characterization showed that the stub filter reduced the target frequency by a factor of 16. Unfortunately, the stub filter had a



rather large FWHM and did not remove higher harmonics that could now dominate the signals. Because of this the stub filter was removed and a low-pass filter was put in its place.

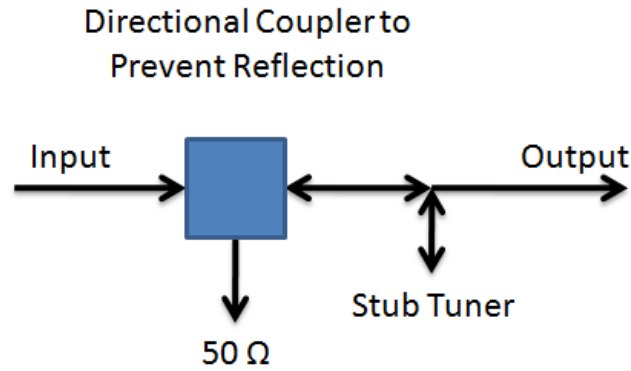

Figure 19: Setup for the stub filter. The path labeled “Stub Tuner” was the path set to  $\frac{1}{4}$  the wavelength of the target frequency and was left without termination. A directional coupler was used to prevent reflections from returning to the source.

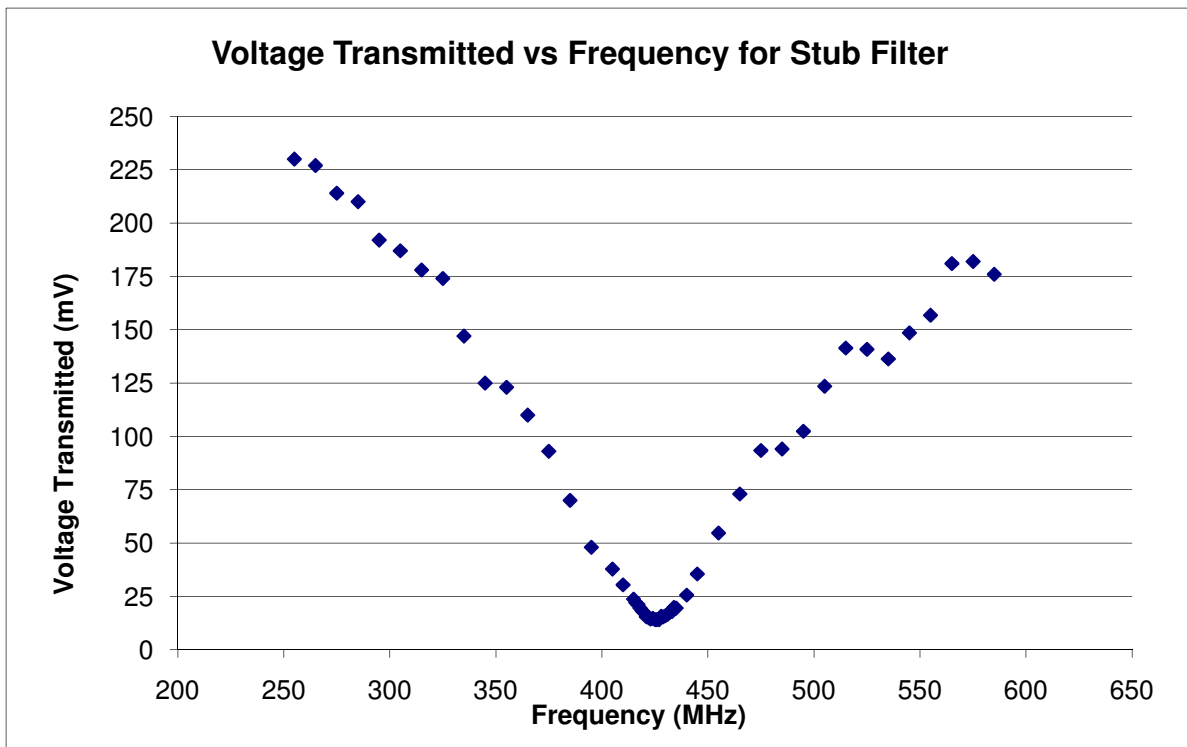

Figure 20: The characterization of the stub filter showing that the target frequency was reduced by a factor of 16 but that it does not prevent higher harmonics from coming through.

### 3.3.2 Characterization of Filtering and Amplification

Since the stub filter was unable to filter the higher harmonics of the RF modulations, two low-pass filters were purchased to reduce all of the signals above 400 MHz. These filters were

characterized by attaching them to the RF generator and scanning through the relevant range of frequencies (1 to 700 MHz) and reading the voltage output. The characterization of the PLB-250+ low-pass filter can be seen below in Figure 21 and the characterization of the PLB-300+ low-pass filter can be seen below in Figure 22. The PLB-250+ was shown to have a sharp cutoff starting at 260 MHz and leveling off at about 460 MHz with a reduction of close to a factor of 200. The PLB-300+ was shown to have a sharp cutoff starting at 300 MHz and leveling off at about 540 MHz with a reduction of close to a factor of 200. The PLB-300+ was eventually chosen as the filter for the circuit because it allowed the most of the lower frequencies to pass which would be helpful looking for the beat frequency at the lower frequencies.

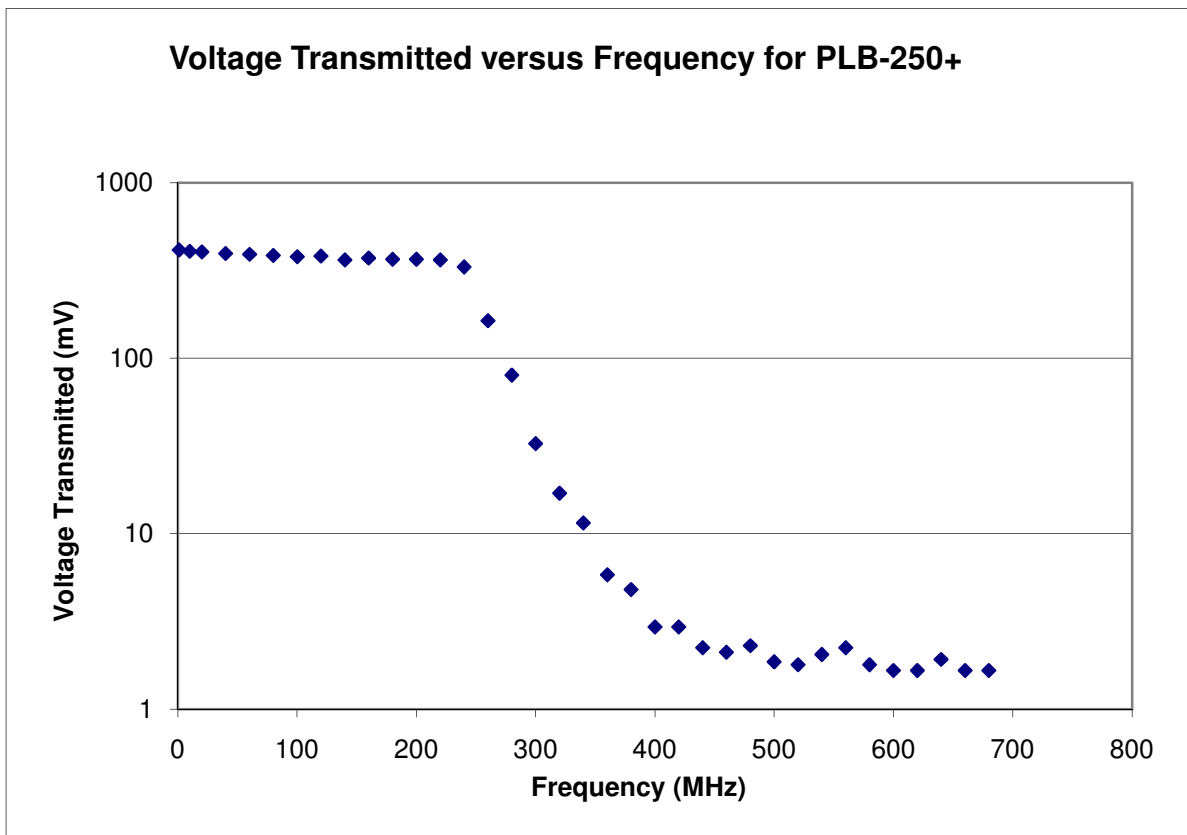

Figure 21: Characterization of the PLB-250+ low-pass filter showing a sharp cutoff at 260 MHz and a reduction of a factor of 200 in the signal of higher frequencies.

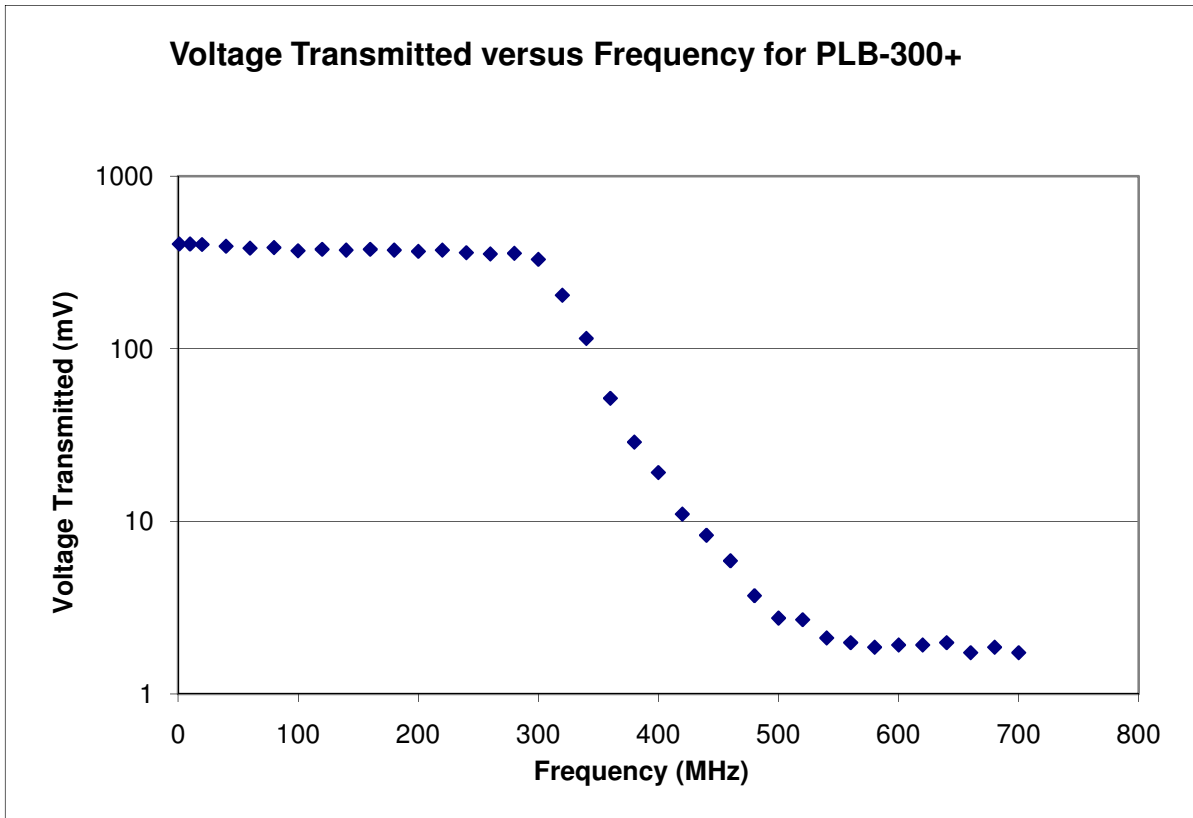

Figure 22: The characterization of the PLB-300+ low-pass filter showing a sharp cutoff at 300 MHz and a reduction of a factor of 200 in the higher frequencies.

The PLB-300+ was added into the filter and amplification circuit directly after the fast photodiode. This helped both reduce the signal going into the later amplifiers and filter out the 460 MHz signal before it could be amplified. The signal was then sent into a 20 dB low-noise amplifier. This amplifier was powered by an external +15 V power supply. The signal was then sent into another 20 dB amplifier with a modest attenuation to prevent it from saturating. The circuit diagram of the filter and amplification circuit can be seen below in Figure 23. The circuit was tested to see how well the amplification and filter was working. At 50 MHz, the signal was increased by a factor of 45, at 300 MHz the signal was amplified by a factor of 36, and at 500 MHz, the signal was reduced by a factor of 6.7. This shows that the filter and amplification circuit was performing well and should have given us a good reading of the beat note frequency.

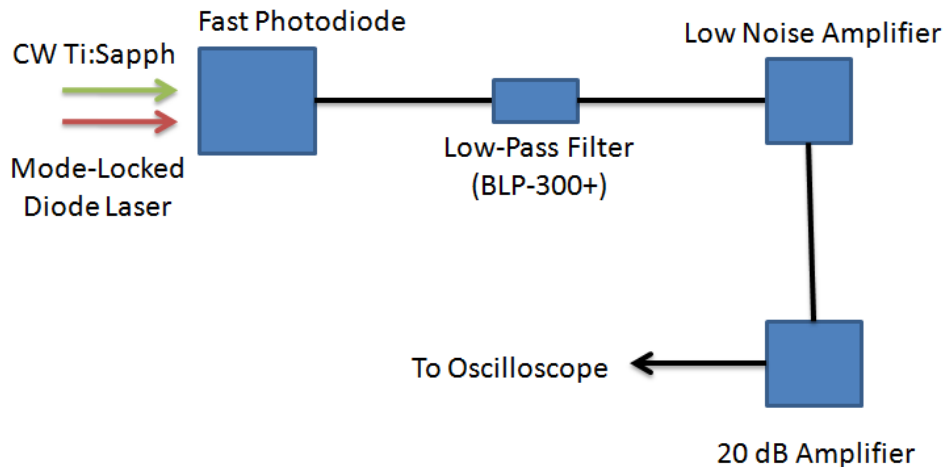

Figure 23: Circuit diagram for the filter and amplifiers.

## 4. Experimental Results and Analysis

### 4.1 Continuous Wave Beat Frequency

The first part of the experiment was to measure the beat note frequency of both lasers while they were in continuous wave mode. This would help verify the existence of a beat note and provide confidence in the experimental setup. The first problem in getting this to happen was that the diode laser did not have a stable wavelength and tended to wander around a range of 300 GHz. The diode and Ti:Sapph lasers needed to be within 1 GHz of one another for the beat note to be visible on the oscilloscope. The instability of the mode-locked diode laser was seen using the wavemeter as it has a resolution of approximately 300 MHz. Based on the readings from the wavemeter, the diode laser was stabilized by adjusting the aperture within the laser cavity and applying slight pressure to the diffraction grating. Once the diode laser was stabilized, the beat note frequency was seen and appeared to travel a fair amount. This was due to changes in the frequency of both the diode laser and the Ti:Sapph laser.

Once the beat note was seen with both lasers in continuous wave mode, the RF generator was turned on and slowly ramped up. As the amplitude of the RF signal increased, the RF frequency appeared in the oscilloscope along with the several sidebands. These sidebands were

the beat frequency plus and minus the frequency separation between it and the RF signal. These sidebands could be easily identified as one moved with the beat note and the other moved in the opposite direction. The beat note frequency with its sidebands can be seen below in Figure 24.

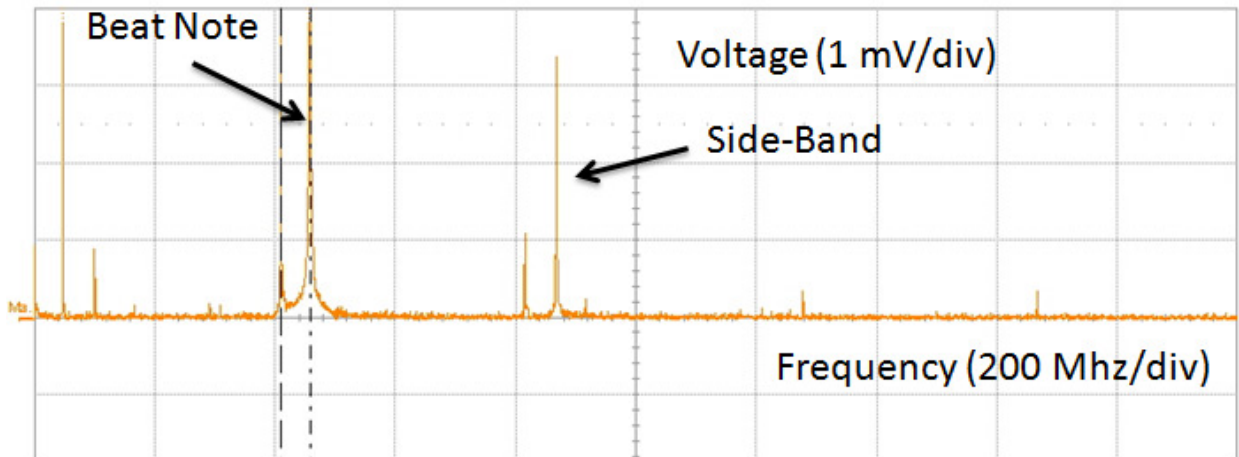

Figure 24: The beat note frequency can be seen above along with the sidebands associated with it (one sideband on either side of the beat note).

#### 4.2 Partially Mode-Locked Beat Frequency

After seeing the beat note as the amplitude was increased, the attempt was made to bring the diode laser into full mode-locking. As the amplitude was increased further, the diode laser appears to enter a state of partial mode-locking and the beat note itself disappears. What replaces it is a noisy large signal that appears to still be the beat note frequency and can be seen below in Figure 25. When the frequency of the Ti:Sapph laser was adjusted, this beat note signal appeared to respond and move around. While this is not quite what we are looking for, the existence of this noisy beat note signal gave us hope that we would see something similar in full mode-locking. Unfortunately, as the diode laser was pushed into full mode-locking, the noisy beat note frequency signal disappeared and was replaced by noise that did not appear to be related to the frequency of the diode or Ti:Sapph lasers.

The disappearance of the beat note signal may have been due to the overwhelming presence of the RF signal and was the motivation for the filter and amplifier circuit described earlier. Also, during the optimization of the mode-locked spectrum, the spectrum appeared to shift by about half a nanometer to a nanometer when the laser entered mode-locking. The disappearance of the beat note signal at this point may have been because the frequency of the mode-locked laser had shifted by more than 2 GHz and could no longer be picked up by the oscilloscope. This was partially fixed by using the spectrometer to match the spectrum of the Ti:Sapph laser to that of the diode laser. Unfortunately, the resolution limitations of the spectrometer discussed earlier prevent the spectrums from being perfectly aligned and only allow for a general estimate.

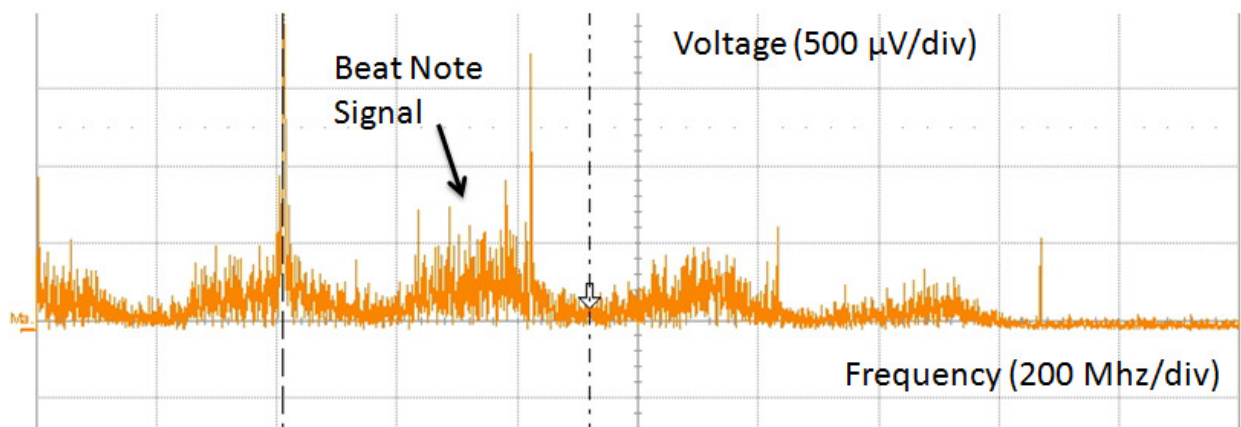

Figure 25: Noisy beat note signal seen as the amplitude of the RF signal was increased. This showed that there may have been some partial mode-locking occurring at the low amplitudes.

#### 4.3 Mode-Locked Beat Frequency

Since the beat note signal had disappeared, the amplifier and filter circuit were introduced to attempt to recover it. With the circuit added, the noise in the circuit was much clearer and various transmissions from the room were picked up. The scale on the oscilloscope was set to 10  $\mu\text{V}$  per division, allowing any small signal to be easily seen. The Ti:Sapph was aligned with the

spectrum of the diode laser to get a general fit and then slowly varied to scan the region of the optical frequency comb. A result of this scanning can be seen below in Figure 26.

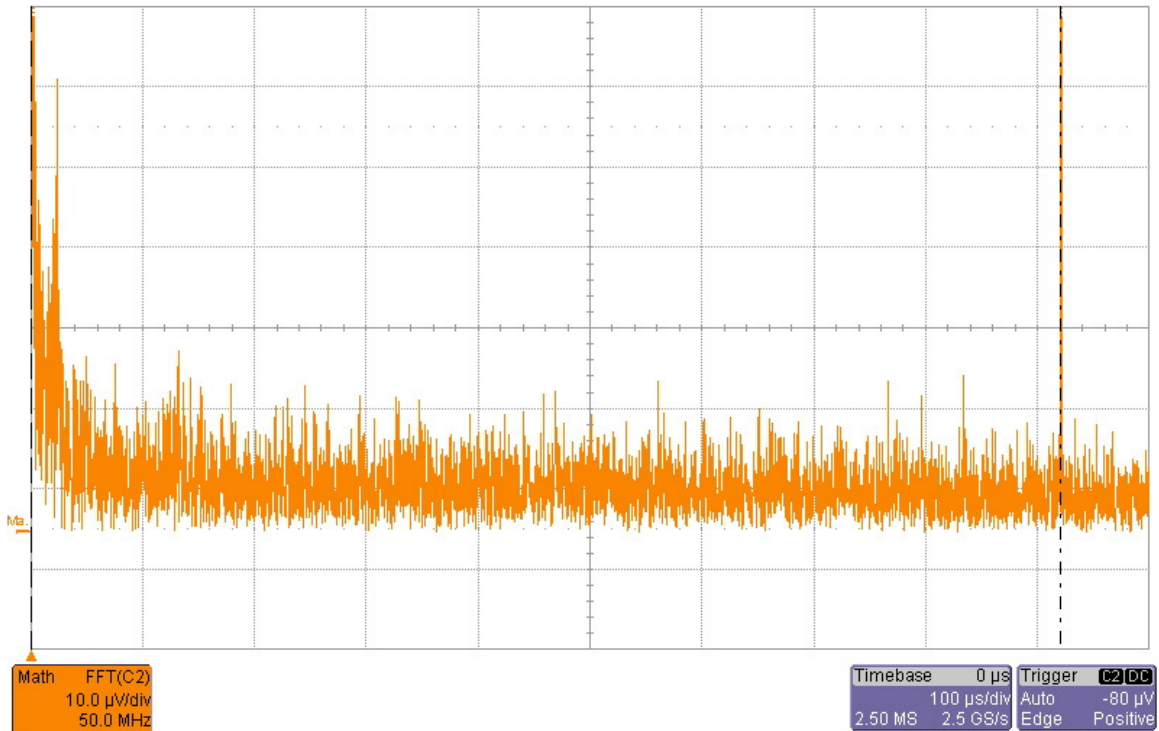

Figure 26: Beat frequency measurement with the diode laser in mode-locking. Several large signals are seen in the low RF range and the 460 MHz signal can be seen.

What is seen in Figure 26 is that the beat note frequency is not present even with the amplification and filter circuit. The circuit has managed to filter out all of the higher frequencies and leave most of the lower frequencies unharmed. The beat frequency is either not there or too small to be measured by the oscilloscope. Our first thought was that the beat frequency was being obscured by jitter in the optical frequency comb. If the optical frequency comb is not perfectly stabilized, the comb may move slightly. If that movement is fast enough then the beat frequency will be obscured as the comb teeth do not provide the continuous wave laser with anything to interfere with. Also, the laser diode may have been entering passive mode-locking and producing a second optical frequency comb. The presence of this second comb could

contribute to the lack of a beat note frequency. Steps were taken to stabilize the optical frequency comb.

### 4.3.1 Stabilization

The lack of stabilization could be seen in spurious noisy signals that would pop up occasionally when the diode laser was not in mode-locking. These signals appeared to be periodic and more than electronic noise. The noisy signal can be seen in Figure 27. Our first thought was that the noisy signal was being introduced because the diode laser was attempting to self mode-lock passively. To fix this, the aperture inside of the laser cavity was adjusted until the noisy signal was minimized. The correct placement of the aperture was with it just barely cutting off the fringes of the laser beam. If the opening was too large or too small, the noisy signal would return. We believe that this means the diode laser was being prevented from entering passive mode-locking due to the laser cavity.

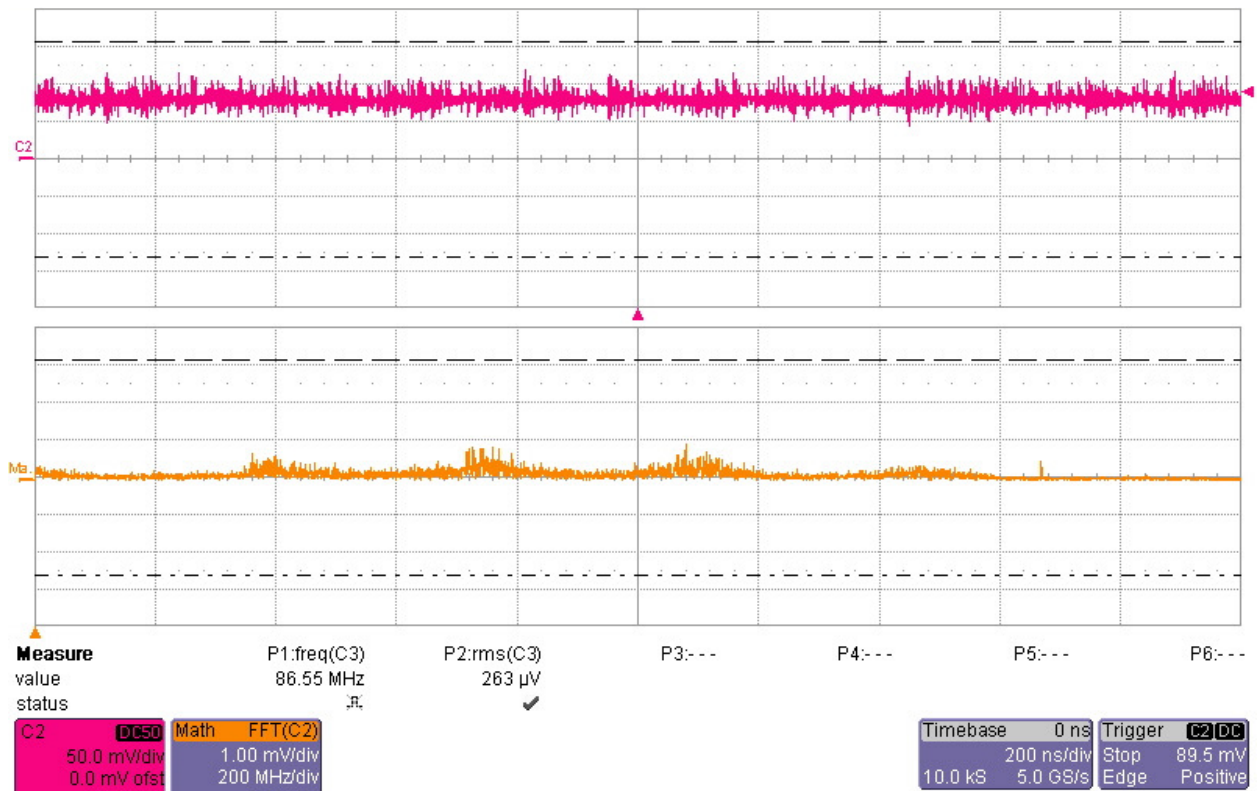



Figure 27: Noisy signal that appears to be caused by the diode laser entering into passive mode-locking. This was prevented by adjusting the aperture in the laser cavity until the signal was gone.

With the passive mode-locking of the diode laser stopped, other methods of stabilization had to be considered. One suggestion of stabilizing a mode-locked diode laser was using an optical bandpass filter. The suggestion came from a doctoral thesis by Kevin Holman in which an optical bandpass filter of approximately 1 nm was used to stabilize an optical frequency comb produced by a hybrid mode-locked diode laser. In our setup we used a 10 nm optical bandpass filter centered at 780 nm. The result of this stabilization is that no beat note frequency was seen and very little changed in the frequency space representation of the overlapped laser beams as seen in Figure 28. However, the optical bandpass filter did cause changes in the spectrum of the mode-locked diode laser as seen by the spectrometer.

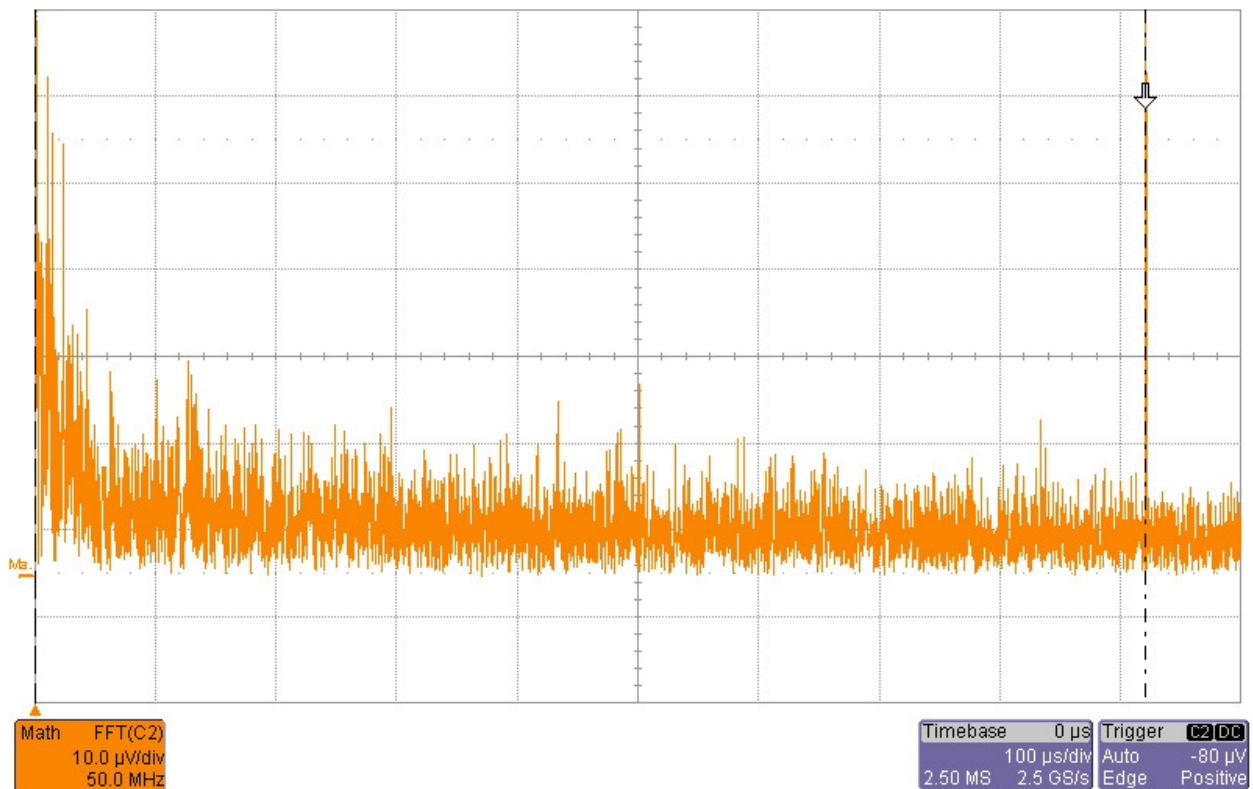

Figure 28: Frequency space representation of the overlapped laser beams showing no beat note frequency with the 780 nm optical bandpass filter added to the laser cavity.

### 4.3.2 Changes in Optical Spectrum due to Optical Filtering

With the introduction of the optical bandpass filter, the spectrum of the mode-locked diode laser changed. Originally, the spectrum of the diode laser was centered at 783.69 nm and appeared slightly asymmetric as seen in Figure 29.

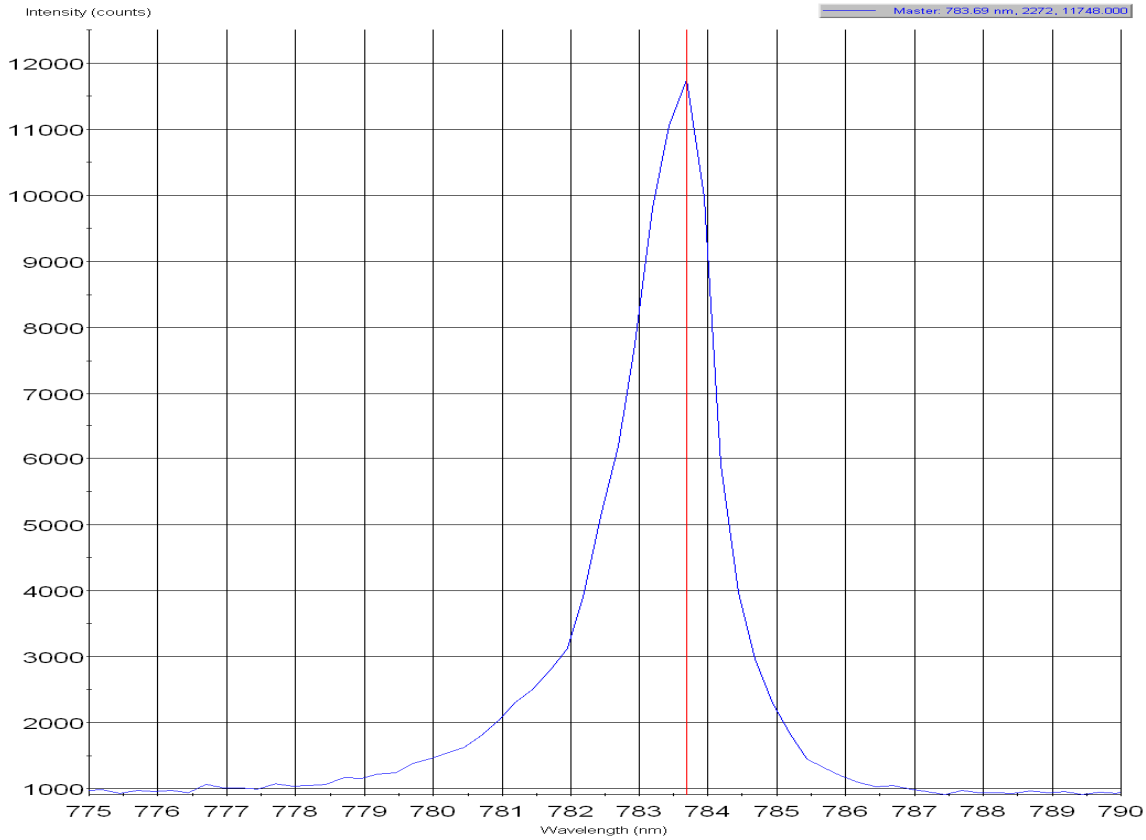

Figure 29: Spectrum of the mode-locked diode laser without any filters within the laser cavity

When the optical bandpass filter is added to the laser cavity the center line, width, shape, and intensity of the spectrum changes as seen in Figure 30. The new center of the spectrum is 782.94 nm and the spectrum itself has been broadened. The spectrum maintains some of the asymmetry seen without the filter, but it is less pronounced. This shows that there is at least a slight change being caused by the optical bandpass filter to the optical frequency comb.

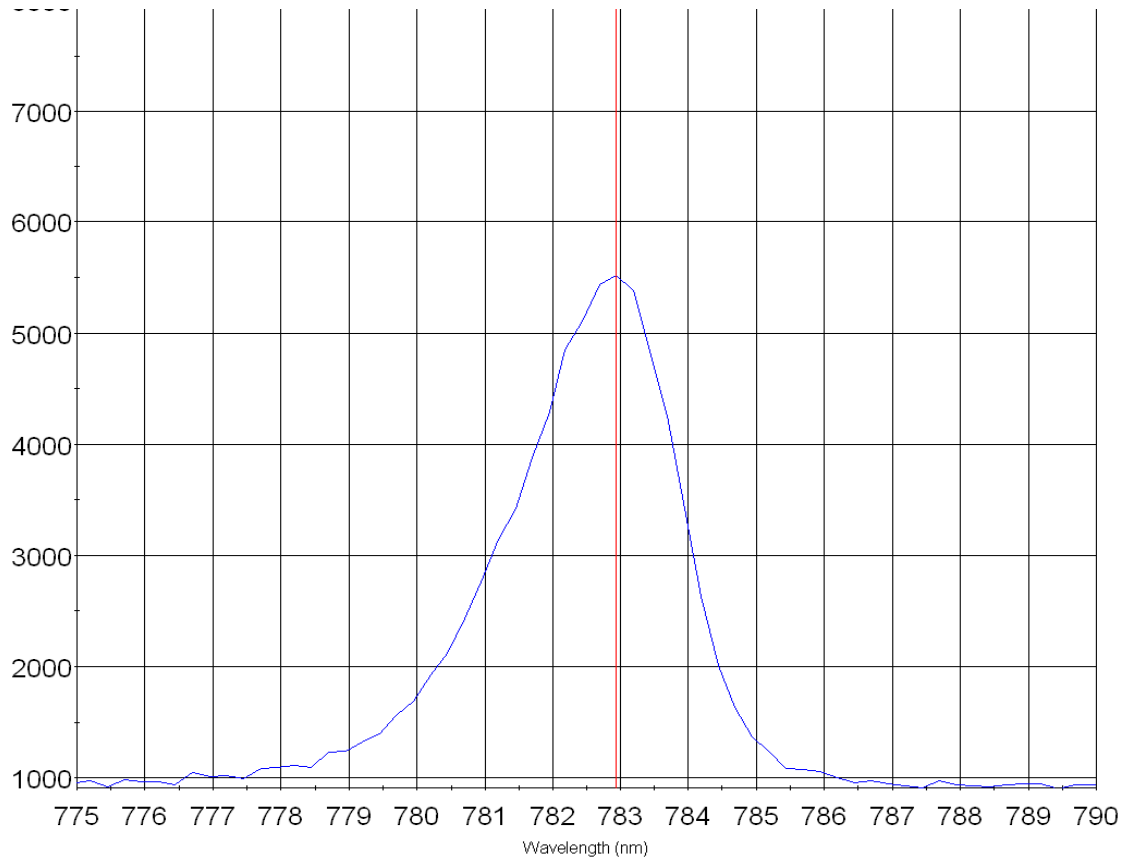

Figure 30: Spectrum of the mode-locked diode laser with the 780 nm optical bandpass filter in the laser cavity. The intensity of the spectrum, bandwidth, centerline, and general shape all appear to have changed.

After seeing the effects of the optical bandpass filter on the spectrum of the diode laser, a piece of glass was used in place of the filter to see what would change. The glass appeared to act like the filter by broadening the spectrum, decreasing the intensity, and shifting the center of the spectrum to 783.19 nm. These changes can be seen in Figure 31 below.

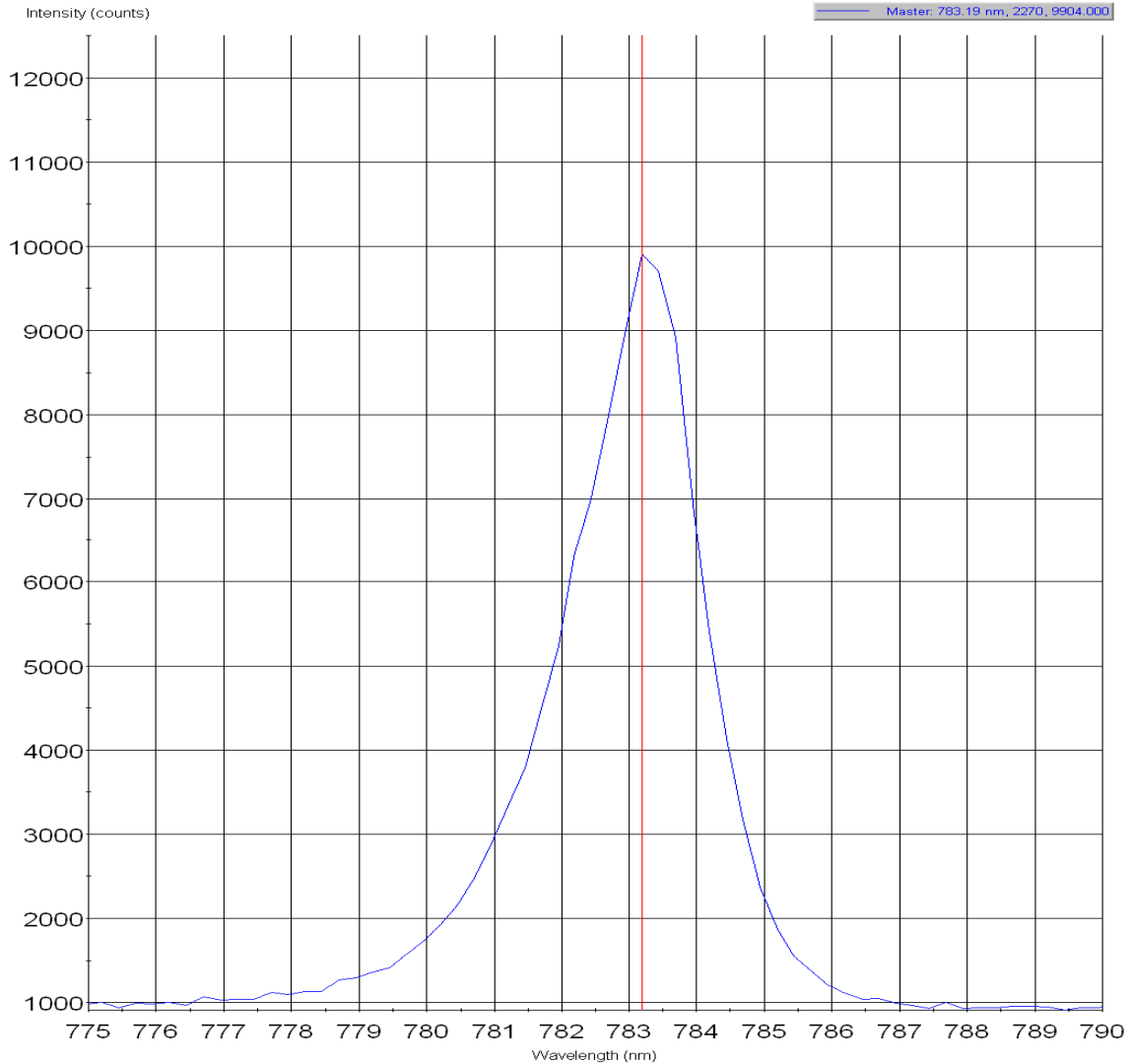

Figure 31: Spectrum of the mode-locked diode laser with a piece of glass placed inside the laser cavity in place of the optical band pass filter.

## 5. Outlook

According to the data, no optical frequency comb was seen by measuring the beat note frequency of the mode-locked diode laser and continuous wave Ti:Sapph laser. This may have been due to two possible problems. The first problem is that there may not actually be an optical frequency comb or it is too unstable to be usable. The second problem is that our experimental technique was unable to observe the optical frequency comb and needs to be refined.

In the case of the optical frequency comb not existing, there are several ways that this could be fixed. The primary change that would need to be made is with the mode-locked diode laser itself. Previously, the optical frequency comb has been seen using a hybrid passive and active mode-locked diode laser [3]. This system uses a mixture of a saturable absorber as the output coupler for the laser and an RF modulator to control the parameters for the laser pulses. As the system we are using is an actively mode-locked diode laser, our system may benefit in stability by adding in the passive portion and turning it into a hybrid laser. Optical filtering within the laser cavity should also assist in creating an optical frequency comb. Currently, our laser cavity has a 10 nm optical bandpass filter, but a sub-nanometer optical bandpass filter is recommended for removing timing jitter in the mode-locked diode laser setup. Without the filter, the timing jitter could be as high as 1.7 ps. With pulse times of close to 1 ps and separation in pulses of close to 1 ns, a 1.7 ps timing jitter could cause the optical frequency comb to not be present. The other option to remedy the stability of the mode-locked diode laser is to stabilize it using a mode-locked Ti:Sapph laser. Mode-locked Ti:Sapph lasers producing optical frequency combs have already been well characterized and could be implemented should a Ti:Sapph laser become available. Using the Ti:Sapph laser, the mode-locked diode laser can be stabilized as stated in the doctoral thesis by Kevin Holman [4].

For the case of the comb being there and us being unable to see it, the problem may be that the timing jitter of the mode-locked diode laser is too large. This large amount of jitter could be covering up the optical frequency comb itself. This could be fixed by introducing a sub-nanometer optical bandpass filter as done by Jiang et al [3]. Also, the timing jitter could be eliminated through use of high-bandwidth feedback as shown by Jones et al [5]. To assure us that the signal from the laser is making it entirely onto the photodiode, the polarization of the mode-

locked diode laser must be made to match that of the continuous wave laser. If not, the two beams will not interfere and no beat note frequency will be produced. In the data above, the mode-locked diode laser was not polarized so that only about half of the signal was interfering with that of the continuous wave Ti:Sapph. Other improvements to the experimental design would include increased filtering of the higher frequency terms and increased amplification of the lower frequency terms. If the optical frequency comb is there, then with enough amplification and filtering, the beat frequency term should appear.

### **5.1 Future Recommendations**

To determine whether or not our experimental setup worked, a well-characterized mode-locked Ti:Sapph laser could be used. A continuous wave Ti:Sapph laser can also be used to produce the beat frequency. Since the mode-locked Ti:Sapph laser will have a well defined optical frequency comb, there will be less of a question as to whether the comb is actually there. Once the comb has been seen with the Ti:Sapph laser and the setup has been verified, the mode-locked diode laser can then be used in the beat frequency experiment. The mode-locked diode laser could also be completely removed from the experiment and the mode-locked Ti:Sapph laser used instead. With a mode-locked Ti:Sapph laser being available for use within the lab, the mode-locked diode laser may no longer be needed if the optical frequency comb can be implemented without it.

## References

- [1] R. Paschotta. "Encyclopedia of Laser Physics and Technology." Wiley 2008. Electronic Version.
- [2] "HR4000CG-UV-NIR Specifications." Ocean Optics.  
<http://www.oceanoptics.com/Products/hr4000cg.asp>
- [3] Leaf A. Jiang, Matthew E. Grein, Erich P. Ippen, Cameron McNeilage, Jesse Searls, and Hiroyuki Yokoyama, "Quantum-limited noise performance of a mode-locked laser diode," *Opt. Lett.* **27**, 49-51 (2002)
- [4] K. Holman, "Distribution of an Ultrastable Frequency Reference using Optical Frequency Combs" Ph.D. Thesis. The University of Colorado. (2005).
- [5] David J. Jones, Kevin W. Holman, Mark Notcutt, Jun Ye, Juhi Chandalia, Leaf A. Jiang, Erich P. Ippen, and H. Yokoyama, "Ultralow-jitter, 1550-nm mode-locked semiconductor laser synchronized to a visible optical frequency standard," *Opt. Lett.* **28**, 813-815 (2003)

## Appendix

Figure 32 below shows the bandwidth test for the 1 GHz oscilloscope. The sharp drop after 1 GHz is the expected output from the oscilloscope. Testing this showed that there were in fact signals below 1 GHz being shown and that the lower frequency signals were not being prematurely filtered.

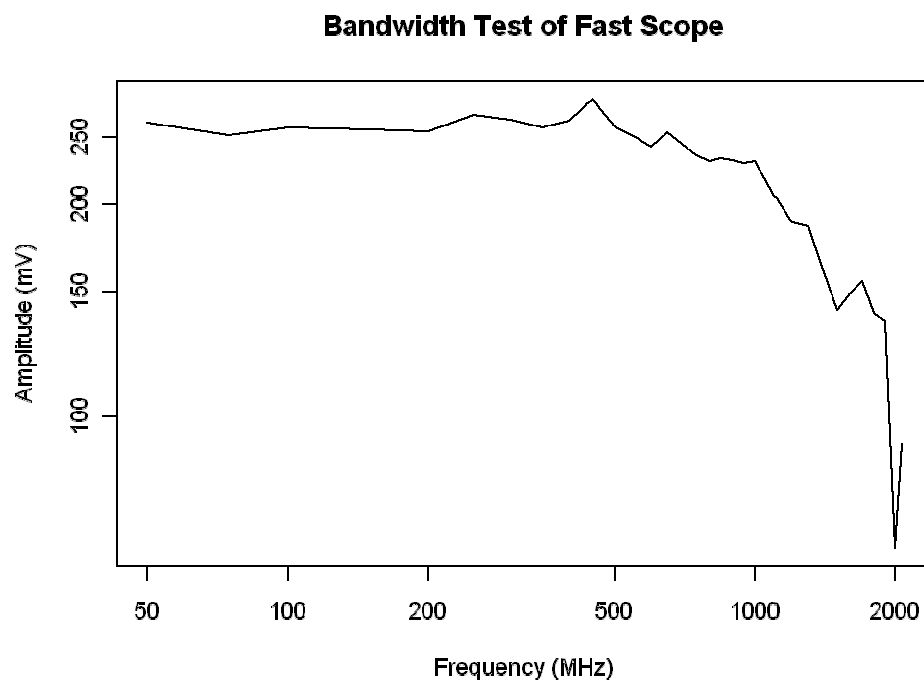

Figure 32: Bandwidth test of the 1 GHz oscilloscope. Shows a sharp drop off after 1 GHz and a mostly stable signal before 1 GHz.