

DOE/NASA/50306-11  
NASA TM-107082

# **Friction and Wear Characteristics of Candidate Foil Bearing Materials From 25 °C to 800 °C**

J.A. Laskowski  
Parks College  
Cahokia, Illinois

and

C. DellaCorte  
National Aeronautics and Space Administration  
Lewis Research Center  
Cleveland, Ohio

Work performed for  
**U.S. DEPARTMENT OF ENERGY**  
**Conservation and Renewable Energy**  
**Office of Vehicle and Engine R&D**

Prepared for  
the Annual Meeting  
sponsored by the Society of Tribologists and Lubrication Engineers  
Cincinnati, Ohio, May 19-23, 1996

## DISCLAIMER

This report was prepared as an account of work sponsored by an agency of the United States Government. Neither the United States Government nor any agency thereof, nor any of their employees, makes any warranty, express or implied, or assumes any legal liability or responsibility for the accuracy, completeness, or usefulness of any information, apparatus, product, or process disclosed, or represents that its use would not infringe privately owned rights. Reference herein to any specific commercial product, process, or service by trade name, trademark, manufacturer, or otherwise, does not necessarily constitute or imply its endorsement, recommendation, or favoring by the United States Government or any agency thereof. The views and opinions of authors expressed herein do not necessarily state or reflect those of the United States Government or any agency thereof.

Printed in the United States of America

Available from  
National Technical Information Service  
U.S. Department of Commerce  
5285 Port Royal Road  
Springfield, VA 22161

NTIS price codes<sup>1</sup>  
Printed copy:  
Microfiche copy: A01

<sup>1</sup>Codes are used for pricing all publications. The code is determined by the number of pages in the publication. Information pertaining to the pricing codes can be found in the current issues of the following publications, which are generally available in most libraries: *Energy Research Abstracts (ERA)*; *Government Reports Announcements and Index (GRA and I)*; *Scientific and Technical Abstract Reports (STAR)*; and publication, NTIS-PR-360 available from NTIS at the above address.

## **Friction and Wear Characteristics of Candidate Foil Bearing Materials From 25 °C to 800 °C**

J.A. Laskowski  
Parks College  
Cahokia, Illinois

and

C. DellaCorte  
National Aeronautics and Space Administration  
Lewis Research Center  
Cleveland, Ohio

Work performed for  
U.S. DEPARTMENT OF ENERGY  
Conservation and Renewable Energy  
Office of Vehicle and Engine R&D  
Washington, D.C. 20545  
Under Interagency Agreement DE-AI01-91CE-50306

Prepared for the  
Annual Meeting  
sponsored by the Society of Tribologists and Lubrication Engineers  
Cincinnati, Ohio, May 19-23, 1996

FRICION AND WEAR CHARACTERISTICS OF CANDIDATE FOIL  
BEARING MATERIALS FROM 25 °C TO 800 °C

by

J.A. Laskowski, Parks College

and

C. DellaCorte  
National Aeronautics and Space Administration  
Lewis Research Center

Abstract

The friction and wear behavior of unlubricated metal/metal sliding couples was investigated to screen potential candidates for high temperature foil bearings. The tribo-tests were run in an induction-heated high temperature pin-on-disk tribometer in an air atmosphere at a load of 4.9 N and at a sliding velocity of 1 m/s. The friction and wear properties of several nickel based alloys (Rene´ 41, Inconel X-750, Inconel 713C), iron based alloys (MA956 and Inconel 909) and a ceramic ( $Al_2O_3$ ) were tested at 25, 500, and 800 °C. In general, at elevated temperatures the alloys oxidized and formed a tenacious and lubricous oxide surface film or layer. At 800 °C, Inconel X-750 versus Rene´ 41 had the lowest friction coefficient (0.27) and at 500 °C, Inconel X-750 versus Inconel 909 the lowest pin wear ( $2.84 \times 10^{-6}$  mm<sup>3</sup>/N-m). Gouging and severe wear of the softer material occurred whenever a significant difference in hardness existed between the pin and disk specimens.

INTRODUCTION

Foil bearings are self acting, hydrodynamic bearings which use ambient air as the working fluid (1). The bearing consists of a thin, flexible, top foil supported by a corrugated bump foil which is, in turn, supported by a rigid bearing housing (2). The bumps act as springs which deflect under load, offering compliance for the top foil and resulting in a larger film thickness than in an equivalent rigid bearing (2,3). Figure 1 is a sketch of a foil air bearing showing typical components.

Foil bearings have been successfully applied to a wide range of high-speed aerospace rotating machinery such as auxiliary power units for military and aircraft applications and automotive gas turbine engines (4). Other applications include turbocompressors and turboalternators for aircraft and space power systems (2,5). A very successful application of a foil bearing has been in aircraft air cycle machines (ACM) for cabin pressurization and cooling. They have demonstrated long service lives with no scheduled

maintenance. Foil bearings used in the Boeing 747 ACM have accumulated more than a million flight hours and demonstrated a mean time between failure of over 100,000 hours (6).

Compared to conventional rigid gas bearings or rolling element bearings, foil air bearings are an attractive alternative because they allow centrifugal and thermal growth of the rotor, as well as readily accommodating impact loading and elastic and thermal distortions. These bearings also provide damping to increase stability (3,7). Misalignments are readily accommodated and endurance at extreme temperatures where oil and grease lubrication cannot be used is possible (2,3).

However, the lack of effective high temperature solid lubricant coatings and/or alternate materials currently limits the use of foil bearings to operating temperatures below 300 °C. Although there is no sliding contact in the steady state operation of the foil bearing, contact between the foil and journal surfaces will occur at startup and shutdown and occasionally during overload situations. The number of startup/shutdown cycles required in a lifetime varies, but typical values lie in the range of 5,000 to 50,000 cycles (7). At these times a lubricous interface is necessary (8).

In order to develop effective high temperature foil bearings, new material combinations that exhibit good high temperature tribological characteristics must be found. Both the foil and journal materials should be readily available from commercial vendors and resistant to high temperature corrosion. In addition, potential foil materials must be capable of developing the required strength and spring properties (7).

Described in this report are efforts now underway to identify improved tribological candidate materials for use up to 650 °C. The goal is to allow the foil air bearing to be functional from low-temperature start-up conditions to the maximum temperatures encountered during engine operation without the use of additional solid lubricants. Pin-on-disk testing was used to screen the alternate candidate materials.

## EXPERIMENTAL DETAILS

Pins which simulate the foil bearing surface were made from Inconel X-750 (INCX-750), the most commonly used foil material, and were slid against various nickel and iron based high temperature alloys in an atmosphere of air with 50% relative humidity at 25 °C. Sliding velocity was 1 m/s (370 rpm). For comparison purposes, pins were also made from the oxide dispersion strengthened iron alloy (MA956) and a ceramic ( $\text{Al}_2\text{O}_3$ ). These two comparative pin materials are considerably softer and harder than INCX-750, respectively. Disk materials included several metal alloys described below and which, based upon their mechanical and

physical properties, are suitable as bearing journal materials. A 0.5kg load was used at temperatures of 25, 500, and 800 °C with testing times between 30 and 60 minutes. Wear measurements and calculations were performed to determine pin and disk wear coefficients.

## MATERIALS

Table 1 summarizes the six different materials used in these experiments. Inconel X-750 (INCX-750), the current foil bearing material, is a nickel-chromium based alloy. INCX-750, Inconel 909 (INC 909), Rene´ 41 (R41) and Inconel 713C (IN713C) are all precipitation hardened and exhibit high temperature corrosion and oxidation resistance (9,10,11,12).

INC 909 is an iron-nickel-cobalt based superalloy which contains about 0.4% silicon. This addition gives substantial improvements in both tensile and rupture properties and permits the use of shorter, more economical heat-treatment cycles. Of the materials selected, INC 909 has the highest hardness at room temperature (71-75 RC) as well as the highest density, 8.3 g/cc (10).

R41 is a nickel-chromium based superalloy which exhibits the highest tensile strength (1420 MPa) at room temperature among the materials tested in this study. R41 has excellent high-temperature oxidation resistance and strength and can be forged into a variety of complex shapes or easily welded. It is a commonly used aerospace material with a hardness (Rc) of 35 to 40 at 25 °C (11). IN713C is a readily-castable nickel based alloy and is chosen because casting bearing journals represents a possible method for cost reduction (12).

MA956 is a mechanically alloyed iron-chromium-aluminum based alloy which is oxide dispersion strengthened (ODS) by the use of a small yttria ( $Y_2O_3$ ) addition. MA956 has high temperature strength and corrosion resistance and provides a long service life under extreme conditions. An aluminum content of 4.5% allows the material to form a nongalling and adherent  $Al_2O_3$  scale at elevated temperatures. The hardness of MA956 is in the range of 20 to 23 Rc (13).

Candidate bearing journal materials were fabricated into test disks 64 mm in diameter and 12.5 mm thick. Pins were cut from 9.5 mm diameter rods and fabricated with a hemispherical tip at each end, using conventional machining techniques, to a curvature of 25.4 mm. The surface finish was approximately 0.01  $\mu$ m rms.

$\text{Al}_2\text{O}_3$  has been used in previous testing and proven to have a desirable combination of properties such as high temperature stability, low thermal conductivity and good wear resistance (14). Properties for the  $\text{Al}_2\text{O}_3$  specimens are given in Table 2 (15). Alumina test pins were made by diamond grinding a 25.4 mm long, 9.52 mm diameter rods. The roughness of the wear surface was typically 0.1 to 0.15  $\mu\text{m}$  rms. Clean water was used as the grinding coolant/lubricant to prevent surface contamination which can occur when using typical grinding lubricants. The hardness of  $\text{Al}_2\text{O}_3$  is beyond the Rockwell C scale and is typically 2200 to 2500  $\text{kg}/\text{mm}^2$  on the Vickers scale.

## APPARATUS AND TEST PROCEDURES

### *Specimen Preoxidation Treatment*

Heat treating of the MA956 in air was performed to grow an oxide layer on the surface of the disks. The tenacious oxide formed on this alloy at high temperatures may reduce friction and wear. A limited study was performed to determine oxide growth rates and establish a heat treatment to grow a 2.5  $\mu\text{m}$  oxide layer on the MA956 material. Specimens were placed into a furnace at 1100 °C for various lengths of time (up to 264 hours) to produce a wear resistant protective layer of aluminum oxide ( $\text{Al}_2\text{O}_3$ ). The specimens (4 mm x 12 mm x 12 mm) were then placed in a mounting press and diamond polished until a submicron finish was obtained on the cross section. The samples were examined in a scanning electron microscope (SEM) and the oxide scale thickness was measured.

After approximately 264 hours, a 4.9  $\mu\text{m}$  oxide scale formed along the surface of the sample. X-ray Energy Dispersive Spectroscopy (EDS) of the scale indicated the presence of only Al and oxygen suggesting an alumina layer was formed. A heat treatment of 20 hr at 1100 °C was chosen to form a 2.5  $\mu\text{m}$  thick oxide scale a sample of which is shown in Figure 2.

### *Test Procedure*

Friction and wear tests were performed in an air atmosphere using the pin-on-disk apparatus shown in Figure 3. Prior to each test, both the pin and disk were cleaned with ethyl alcohol and scrubbed with a paste of levigated alumina and water. The specimens were then rinsed with deionized water and air dried.

To run a test, a hemispherically tipped pin was loaded against a disk using dead weights. The normal load used was 4.9 N and friction force was measured continuously by means of a strain gauge bridge. The pin

generated approximately a 51 mm diameter wear track on each disk. Sliding was unidirectional and the velocity in these experiments was 1 m/s to screen start/stop lubricants for foil bearings. This velocity was chosen as an approximate average between initial start/stop conditions (0 m/s) and initial lift off (2 m/s). The specimens were heated by a low frequency induction coil and an infrared pyrometer or thermocouple was used to measure the disk surface temperatures on the wear track. Each test was run between 30 and 60 minutes at temperatures of 25, 500, and 800 °C. Typically, three repeat tests were conducted to assess data scatter.

Wear volumes were calculated from the diameters of the circular wear scars on the hemispherically tipped pins and from surface profiles of the disk wear tracks. The unit of wear used is the wear factor  $k$ , which is defined as the wear volume divided by the product of the load and sliding distance. The wear factor  $k$  has units of  $\text{mm}^3/\text{N}\cdot\text{m}$ . Values of  $k$  above  $10^{-4} \text{ mm}^3/\text{N}\cdot\text{m}$  are considered high wear and values below  $10^{-7} \text{ mm}^3/\text{N}\cdot\text{m}$  are considered low wear for many sliding applications (16).

## RESULTS

The primary goal of this research is to identify material combinations offering improved tribological properties over the baseline INCX-750 foils sliding against INCX-750 journals. The results of the friction and wear testing are summarized in Table 3 and shown graphically in Figures 4 to 6. A typical friction coefficient versus time graph is plotted for the  $\text{Al}_2\text{O}_3$  versus INCX-750 test at 500 °C in Figure 7. The range of friction coefficients of all tests performed was 0.27 to 1.02 and pin and disk wear factors were between  $10^{-2}$  and  $10^{-6} \text{ mm}^3/\text{N}\cdot\text{m}$ . Results for specific combinations are given below.

### INCX-750/INCX-750

In self-mated sliding, INC X-750 exhibited high friction and wear at 25 and 500 °C. Wear factors were greater than  $10^{-4} \text{ mm}^3/\text{N}\cdot\text{m}$  and friction was between 0.4 and 0.54. At 800 °C, excessive material transfer and subsequent vibration occurred which precluded the completion of testing and any meaningful wear measurements. Measured friction was actually reduced, in this case, but the reduction actually reflects “bouncing” and “skipping” of the pin over the disk surface. Clearly a material change or lubricant is required when using both INCX-750 foil bearings and journals under these sliding conditions (i.e., high temperatures).



#### INCX-750/MA956

When INCX-750 pins were slid against MA956 disks, wear performance similar to self-mated INCX-750 was observed at room temperature. Friction for both MA956 and pre-oxidized (MA956-OX) was about 0.6 and wear factors are around  $10^{-4}$  mm<sup>3</sup>/N-m. At 500 °C friction increased substantially to 0.9 to 1.0 and disk wear increased by one order of magnitude to  $10^{-3}$  mm<sup>3</sup>/N-m. For INCX-750 versus MA956, at 800 °C the tests had to be interrupted due to severe galling and stick/slip behavior.

#### INCX-750/INC909

INCX-750 versus INC 909 testing showed a high friction coefficient at 25 °C of 0.61. Excessive transfer (galling) occurred at 500 °C and 800 °C causing rough and erratic sliding and the average measured friction coefficient varied from 0.36 to 0.40. As in the case of self-mated INCX-750 at 800 °C, dynamic effects due to the roughened surfaces hindered accurate friction measurements at these rotational speeds (370 rpm). Although the pin wear decreased from  $10^{-3}$  at 25 °C to  $10^{-6}$  mm<sup>3</sup>/N-m at 500 °C, no pin or disk wear measurements could be obtained at 800 °C due to severe wear and galling.

#### INCX-750/IN713C

Initial testing of IN713C was done with ground (Ra = 0.2 μm rms) surface finished disks rather than lapped samples due to availability of the specimens. At all test temperatures, disk wear or transfer from the pin, was indistinguishable from the unworn, ground disk surface due to the roughness peaks being larger than any wear track or material transfer. Three additional tests (one at each temperature) using lapped disk surfaces (Ra=0.1 μm rms) were run to quantify disk wear. At 25 °C the disk wear was  $1.62 \times 10^{-3}$  mm<sup>3</sup>/N-m and the friction coefficient was 0.68. At 500 °C pin wear was  $1.07 \times 10^{-4}$  mm<sup>3</sup>/N-m, the friction (0.64) was nearly the same as at 25 °C. Disk wear could not be quantified as a result of material transfer (determined from surface profilometry) from the pin to the disk. At 800 °C, friction decreased to 0.34. As was the case at 500 °C, disk wear not detectable due to material transfer from the pin. The pin wear increased to  $6.6 \times 10^{-4}$  mm<sup>3</sup>/N-m.

#### INCX-750/Rene´ 41

When R41 was the counterface disk, room temperature friction and wear became comparable to INCX-750 disks. Friction was 0.5, pin wear was  $2.0 \times 10^{-4}$  mm<sup>3</sup>/N-m, and disk wear was  $1.3 \times 10^{-4}$  mm<sup>3</sup>/N-m. At 500 °C, friction decreased to 0.31 and pin wear was reduced by an order of magni-

tude to  $7.3 \times 10^{-6} \text{ mm}^3/\text{N-m}$ , the lowest INCX-750 pin wear observed. Disk wear however increased slightly to  $2.0 \times 10^{-4} \text{ mm}^3/\text{N-m}$ . At 800 °C, no measurable wear occurred for both the pins and the disks during these tests and friction was further reduced to 0.27.

### ***Alternate Pin Material Tests***

Although the lack of spring properties at elevated temperatures precludes their use as foil materials, MA956 and  $\text{Al}_2\text{O}_3$  were tested as pins for comparative purposes and for screening their potential as coatings.

#### MA956 PINS

In self-mated sliding, MA956 exhibited high friction and wear under almost all conditions tested. Using an oxidized MA956 disk resulted in a friction coefficient of 0.4 at 800 °C, about one-half that of other tests. The corresponding amount of wear, however, was high for both pin and disk.

#### $\text{Al}_2\text{O}_3/\text{MA956}$

The average friction coefficient of alumina pins sliding against MA956 at 25 °C was 0.68. Friction decreased at 500 °C to 0.47 and to 0.30 at 800 °C. Average disk wear at 25 °C was  $1.12 \times 10^{-3} \text{ mm}^3/\text{N-m}$  and of the same magnitude at 500 °C. Pin wear at each temperature was of the order of  $10^{-5} \text{ mm}^3/\text{N-m}$ . Surface profilometry of the disks at 800 °C indicated that material build-up occurred.

#### $\text{Al}_2\text{O}_3/\text{INCX-750}$

The tribocombination of  $\text{Al}_2\text{O}_3$  sliding against INCX-750 produced friction and wear properties similar to that of  $\text{Al}_2\text{O}_3$  versus MA956. Figure 8 shows the plot of friction at each temperature. At 25 °C the average friction was 0.67 and decreased to 0.29 at 800 °C. Disk wear at 25 and 500 °C was 5.4 and  $1.6 \times 10^{-4} \text{ mm}^3/\text{N-m}$  respectively. Pin wear was  $4.15 \times 10^{-5} \text{ mm}^3/\text{N-m}$  at 25 °C and decreased to  $7.0 \times 10^{-6} \text{ mm}^3/\text{N-m}$  at 500 °C. At 800 °C, pin wear was  $1.1 \times 10^{-5} \text{ mm}^3/\text{N-m}$  and disk wear was  $-8.6 \times 10^{-8} \text{ mm}^3/\text{N-m}$ . The negative disk wear factor at 800 °C indicated that a slight buildup of material occurred between the two materials.

### DISCUSSION

In existing foil bearing applications, INCX-750 foils are typically operated against journals made from INCX-750 or lower cost stainless steels, like A286 (4). Solid lubricants are required to prevent wear, ensure long life, low starting torque and smooth bearing surfaces. Commonly used solid lubricants are polymer (PTEE,

polyimides), graphite or molybdenum disulfide coatings. These coatings are capable of operating at temperatures to about 300 °C. The development of suitable solid lubricants which can endure higher temperatures has been slow and therefore alternate approaches have been considered.

The approach used in this current research is to identify new material combinations which show improved tribological properties over the baseline self-mated INCX-750 without the need for additional solid lubrication. None of the combinations tested however, offer significantly improved friction and wear properties over the entire temperature range. Under specific conditions some materials performed better than self-mated INCX-750. To better understand the observed results, the friction and wear properties will be discussed in more detail.

Considerable research has already been done to study and understand the phenomena of self-mated metal sliding combinations in air at elevated temperatures. The results presented in the literature by Stott and his colleagues are quite comprehensive and detailed and conclusively demonstrate that metal oxides form during rubbing and reduce friction and wear (17, 18). At elevated temperatures the oxides soften and become more lubricious.

Although thorough and enlightening on tribological mechanisms, their work does not consider the baseline material for foil bearings (INCX-750) or the more recently available mechanically alloyed, oxide dispersion strengthened materials like MA956. Our results, despite being collected under different contact conditions (unidirectional versus oscillating contact) and with different alloys, mirror their work in many respects. Namely, at elevated temperatures oxide surface layers form and reduce friction.

Figure 6, which shows the friction vs. temperature behavior for the metal disk surfaces tested against Inconel X-750 pins suggests a distinct grouping. At room temperature, all of the six metal disk surfaces tested have similar friction coefficients of around 0.5 to 0.6. At 500 °C and 800 °C, the alloys which readily form Ni-Cr oxide surface layers (INCX-750, INC909, and R 41) show a noticeable reduction in friction. The presence of Ni-Cr oxides was inferred from Energy Dispersive Spectroscopy (EDS) analyses which identified Ni, Cr, and O in the surface. Alloys which contain aluminum (IN713C, MA956, and MA956-OX) and tend to form Al<sub>2</sub>O<sub>3</sub>-rich oxide layers, (inferred from EDS detection of Al and O) generally do not show a reduction in friction until 800 °C is reached.

These results suggest that the friction level may be controlled by the oxide layer hardness as well as

formation kinetics. Since NiO and Cr<sub>2</sub>O<sub>3</sub> are considerably softer than Al<sub>2</sub>O<sub>3</sub>, lower friction observed for the INCX-750 and INC909 at 500 °C may result from a lower shear stress for the nickel and chromium oxides at 500 °C.

### FRICITION

Figure 8 which plots friction behavior for Al<sub>2</sub>O<sub>3</sub> pins sliding against a disk made from INCX-750 ( a high Ni-Cr alloy) and MA956 (an Al<sub>2</sub>O<sub>3</sub> former) shows that disk composition has little effect on friction when the pin material is ceramic. The reason(s) for this lack of sensitivity is not obvious, but may be due to the differences in thermal conductivity of Al<sub>2</sub>O<sub>3</sub> and INCX-750 pins. During sliding, the pin is under continuous contact and therefore the pin surface experiences considerable frictional heating. The lower thermal conductivity of the Al<sub>2</sub>O<sub>3</sub> pins compared to metals, leads to a high surface temperature regardless of the disk counterface material composition. Lack of friction coefficient sensitivity to the disk material composition, in this case, suggests that the pin surface temperature increase is reducing the friction of even the Al<sub>2</sub>O<sub>3</sub>-forming MA956 material at 500 °C. Thus, if friction reduction is a critical factor in material selection, the sliding component in continuous contact should be made from the lowest thermal conductivity material to encourage softening of surface oxide layers.

### WEAR

Wear (wear factors) varied over a wide range from 10<sup>-6</sup> to 10<sup>-2</sup> mm<sup>3</sup>/N-m. In some instances, especially at 800 °C, material transfer and buildup on the pin and/or disk confounded the wear measurements suggesting little or no discernible wear.

At 25 °C, INC909, which has a high room temperature hardness (71-75 RC), exhibited five times lower wear than the INCX-750 counterface pin. INC909, however, loses much of its hardness at elevated temperature and at 800 °C galling of the disk and severe transfer occurred. Similar behavior was exhibited by the combination of INCX-750 and MA956. Clearly, poor tribological performance is obtained if the hardnesses of the two mating materials are significantly divergent.

Hardness compatibility, however is apparently not a sufficient prerequisite for good wear combination performance. When INCX-750 was slid against itself, galling and severe transfer occurred at 800 °C despite

the reduction in friction from 0.54 to 0.36. Self-mated sliding of MA956 produced severe wear and galling especially at higher temperatures and was accompanied by stick/slip behavior. Preoxidation of the MA956 disks provide a lubrication effect at 800 °C perhaps by altering the sliding combination from self-mated MA956 to MA956 versus an Al<sub>2</sub>O<sub>3</sub> layer.

The best tribological combinations tested were INCX-750 pin versus R41 disks and Al<sub>2</sub>O<sub>3</sub> pins versus INCX-750 disks. The wear data suggests that in addition to retained (and possible comparable) hot hardness, tribological performance is improved when the pin and disk were made from different materials.

A plausible explanation for this behavior is that the adhesive component of friction and wear is reduced by using different material compositions hereby reducing the tendency for junction growth and welding. The retained high hot hardness values of the materials (Al<sub>2</sub>O<sub>3</sub>, INCX-750 and R41) further improve the sliding performance by providing a hard substrate for self forming surface oxide layer “lubricants”. Nonetheless, even the most promising combinations tested in this study (INCX-750/R41 and Al<sub>2</sub>O<sub>3</sub>/INCX-750) exhibited high wear ( $10^{-4}$  mm<sup>3</sup>/N-m) at 25 and 500 °C. For a practical application, solid lubrication will be necessary.

#### SUMMARY REMARKS

The sliding couples tested in these experiments yielded moderate to high wear indicating a need for solid lubrication. Baseline data collected at the various temperatures (25, 500, 800 °C) provided insight in the role of material properties such as hardness and the effect of oxides on friction and wear. A few conclusions can be made from these tests and give guidance for selecting suitable alternate foil bearing materials.

Elevated temperatures tend to lead to the formation of oxides on specimen surfaces. The types of oxides formed are important as the degree to which they reduce friction and wear at different temperatures is dependent on the oxide properties. The Ni-Cr oxides formed on INCX-750, INC909, and R41 reduce friction and wear at 500 °C and 800 °C. However, the alumina forming materials (IN713C, MA956, and MA956-OX) do not show a reduction in friction until 800 °C is reached. Preoxidation treatments where a thin oxide ceramic layer was formed on the disk surface can be useful in reducing friction, wear and galling. These results suggest that a higher temperature (800 °C) is required to form a lubricating oxide for Al<sub>2</sub>O<sub>3</sub> forming alloys than for

NiO-Cr<sub>2</sub>O<sub>3</sub> forming alloys. Therefore, for applications where the operating temperatures are not expected to exceed 500 °C, NiCr oxide forming alloys may be preferred.

At higher temperatures (500 and 800 °C) catastrophic gouging, galling or stick/slip behavior may occur. The softness of the MA956 material proved to be critical when coupled with the INCX-750 pin materials. Deep gouging wear occurred at the higher temperatures although a preformed oxide layer existed. In general, when materials of significantly differing hardness are in contact, the softer material is more likely to wear faster than its counterface. Therefore, hardness comparability is also necessary when coupled materials of dissimilar compositions are being considered for applications. Self-mated sliding produces galling and high friction at elevated temperatures, suggesting that for the materials tested comparable hardness and dissimilar compositions are required for good tribological performance.

High temperature applications require materials which are capable of performing from startup to shutdown temperatures and provide low friction and wear. The results presented in this paper suggest that unlubricated metal/metal combinations are not likely candidates for long term practical applications. Further research is needed to develop high temperature solid lubricants capable of surviving the foil bearing environment and providing lubrication from low ambient temperatures to over 650 °C. These materials or their combinations considered in this report may be a good starting point for future research.

#### REFERENCES

1. Heshmat, H., "Advanced Development of Air-Lubricated Foil Thrust Bearings," ASME/STLE Lubrication Conference, Washington D.C., Preprint 82-LC-6B-1 (Oct. 1982).
2. Heshmat, H. And Hermel, P., "Compliant Foil Bearings Technology and Their Application to High Speed Turbomachinery," in Thin Films in Tribology, Dowson, D., et al., eds., Elsevier, Amsterdam, Tribology Series, 25, (1993), pp. 559-575.
3. Heshmat, C.A. and Heshmat, H., "An Analysis of Gas-Lubricated, Multileaf Foil Journal Bearings With Backing Springs," J. Tribol., 117, pp. 437-443, (1995).
4. Gray, S., Heshmat, H., and Bhushan, B., "Technology Progress on Compliant Foil Air Bearing Systems for Commercial Applications," in 8th International Gas Bearing Symposium, BHRA Fluid Engineering, Cranfield, Bedford, England, (1981), pp. 559-575.
5. Heshmat, H., "Advancements in the Performance of Aerodynamic Foil Journal Bearings: High Speed and Load Capability," J. Tribol., 116, pp. 287-295, (1994).
6. Heshmat, H., Shapiro, W., and Artiles, A., "Application of Compliant Foil Fluid Film Bearings to the High-Pressure Oxygen Turbopump of the SSME," in 1992 Conference on Advanced Earth-to-Orbit Propulsion Technology, Vol. 2, (1992), pp. 429-438.

7. Walton, J.F., and Heshmat, H., "Compliant Foil Bearings for Use in Cryogenic Turbopumps," vol. 2, NASA CP-3282, (1994) pp. 372-381.
8. DellaCorte, C., and Wood, J.C., "High Temperature Solid Lubricant Materials for Heavy Duty and Advanced Heat Engines," NASA, Cleveland, OH., NASA TM-106570, (1994).
9. "Inconel alloy X-750," Product Handbook, Inco Alloys international, "Huntington, West Virginia, (1988), p. 11.
10. ASM Internation, "Metals Handbook," 10th ed., (1990), p. 963.
11. Morris, R.J., "Rene' 41...New Higher-Strength Nickel-Base Alloy," Metal Prog. 76, 6, pp. 67-70, (1959).
12. Metals Handbook, 9th ed., Vol. 3, Properties and Selection: Stainless Steels, Tool Materials and Special Purpose Metals, American Society for Metals, Metals Park, Ohio, 1978, p. 247.
13. "Incoloy alloy MA956," IncoMAP, Inco Alloys International, Huntington, West Virginia, (1990).
14. Benoy, P.A., and DellaCorte, C., "Au/Cr Sputter Coating for the Protection of Alumina During Sliding at High Temperatures," NASA, Cleveland, Ohio, NASA TM-106853, (1995).
15. DellaCorte, C., and Pepper, S.V., "Tribological Properties of Ag/Ti Films on Al<sub>2</sub>O<sub>3</sub> Ceramic Substrates," NASA, Cleveland, Ohio, NASA TM-103784, (1991).
16. DellaCorte, C., "Composition Optimization of Chromium Carbide Based Solid Lubricant Coatings for Foil Gas Bearings at Temperatures to 650 °C," NASA, Cleveland, Ohio, NASA CR-179649, July 1987.
17. Stott, F.H., Lin, D.S., and Wood, G.C., "The Structure and Mechanism of Formation of the 'Glaze' Oxide Layers Produced on Nickel-Based Alloys During Wear at High Temperature," Corros. Sci., vol. 13, pp. 449-469, (1973).
18. Barnes, D.J., Stott, F.H., and Wood, G.C., "The Frictional Behaviour of Iron and Iron-Chromium Alloys at Elevated Temperatures," Wear, vol. 45, pp. 199-209, (1977).

TABLE 1.—DISK MATERIAL PROPERTIES

Test materials wt% composition	INCX-750	INC909	MA956	Rene´ 41	IN713C
Cr	14-17		20.0	19.0	12.5
Fe	5-9	42.16	74.0	0.30	
Al	0.4-1	0.03	4.50	1.50	6.1
Ti	2.25-2.75	1.50	0.50	3.10	0.8
Y <sub>2</sub> O <sub>3</sub>			0.50		
Ni	balance	38.2		55.1	74
Nb + Ta	0.7-1.20				
Mn	1.00				
Si	0.50	0.40			
W	0.01				
Cu	0.50				
C	0.08	0.01			0.12
Co	1.00	13.0		11.0	
Nb		4.70			2
B					0.012
Mo				10.0	4.2
Zr					0.1
Melting point (°C)	1390-1430	1395-1430	1480	1400	1260-1290
Density (g/cc) at RT	8.25	8.30	7.20	8.25	7.91
Hardness, Rc (at R.T)	32-38	71-75	20-23	35-40	38-42
Elastic modulus, E(GPa)	214	159	269	219	205
Tensile strength (MPa) at RT	1200	1310	645	1420	850

TABLE 2.—ALUMINA PROPERTIES

% Composition	Melting point, °C	Density, g/cc	Thermal conductivity, w/m K	Young’s modulus, GPa	Vickers hardness GPa
99.9 Al <sub>2</sub> O <sub>3</sub> , and trace	2054	3.9	22	386	21-24



TABLE 3.—TRIBO-DATA FOR VARIOUS PIN-DISK COMBINATIONS

[Test conditions: Air atmosphere, 4.9 N load, 1 m/s sliding velocity, 30 to 60 minutes test time, 50% relative humidity.]

Specimens		Test temperature	Wear factors (mm <sup>3</sup> /N-m)		Friction coefficient
Pin	Disk	°C	k (pin)	k (disk)	μ
INCX-750	INCX-750	25	3.00x10 <sup>-4</sup> ±0.57	1.85x10 <sup>-4</sup> ±0.92	0.54±0.03
		500	6.70x10 <sup>-5</sup> ±4.7	2.65x10 <sup>-5</sup> ±0.50	0.40±0.05
		800	[1]	[1]	0.36±0.08
INCX-750	MA956	25	1.05x10 <sup>-4</sup> ±0.26	1.83x <sup>-4</sup> ±0.61	0.60±0.04
		500	1.11x10 <sup>-4</sup> ±0.18	8.57x10 <sup>-3</sup> ±4.3	1.02±0.06
		800	[1]	[1]	[1]
INCX-750	MA956-OX	25	6.30x10 <sup>-5</sup> ±1.1	6.5x10 <sup>-4</sup> ±0.14	0.64±0.05
		500	1.01x10 <sup>-4</sup> ±0.35	6.17x <sup>-3</sup> ±0.84	0.87±0.15
		800	5.65x10 <sup>-5</sup> ±5.7	8.8x10 <sup>-4</sup> ±3.1	0.34±0.00
INCX-750	INC909	25	2.03x10 <sup>-3</sup> ±2.6	3.11x10 <sup>-4</sup> ±1.4	0.61±0.01
		500	2.84x10 <sup>-6</sup> ±3.4	[1]	0.36±0.05
		800	[1]	[1]	0.40±0.03
INCX-750	IN713CX	25	1.07x10 <sup>-4</sup> ±0.51	1.62x10 <sup>-3</sup>	0.68±0.02
		500	3.90x10 <sup>-4</sup> ±1.9	[2]	0.64±0.01
		800	6.63x10 <sup>-4</sup> ±1.3	[2]	0.34±0.4
INCX-750	Rene´41	25	2.04x10 <sup>-4</sup> ±3.0	1.32x10 <sup>-4</sup> ±0.45	0.50±0.06
		500	7.29x10 <sup>-6</sup> ±6.7	2.0x10 <sup>-4</sup> ±1.7	0.31±0.07
		800	[2]	[2]	0.27±0.02
MA956	MA956	25	1.20x10 <sup>-3</sup> [5]	1.05x10 <sup>-3</sup> ±0.07	0.68±0.03
		500	1.35x10 <sup>-4</sup> ±0.35	7.30x10 <sup>-3</sup> ±2.0	0.89±0.20
		800	5.70x10 <sup>-4</sup> ±2.3	1.55x10 <sup>-2</sup> ±0.50	0.88±0.07
MA956	MA956-OX	25	8.75x10 <sup>-4</sup> ±0.07	1.25x10 <sup>-3</sup> ±0.07	0.68±0.68
		500	2.80x10 <sup>-4</sup> ±1.3	7.10x10 <sup>-3</sup> ±0.85	0.92±0.14
		800	3.40x10 <sup>-4</sup> ±1.4	2.71x10 <sup>-3</sup> ±2.5	0.40±0.01
Al2O3	MA956	25	9.95x10 <sup>-5</sup> ±0.07	1.12x10 <sup>-3</sup> ±0.26	0.68±0.03
		500	7.70x10 <sup>-5</sup> ±0.42	1.07x10 <sup>-3</sup> ±0.18	0.47±0.01
		800	5.20x10 <sup>-5</sup> [3]	-1.05x10 <sup>-4</sup> ±5.6	0.30±0.01
Al2O3	INCX-750	25	4.15x10 <sup>-5</sup> ±3.6	5.40x10 <sup>-4</sup> ±1.4	0.67±0.06
		500	7.05x10 <sup>-6</sup> ±3.3	1.6x10 <sup>-4</sup> ±0.42	0.39±0.05
		800	1.10x10 <sup>-5</sup> ±0.96	-0.86x10 <sup>-7</sup> ±6.6	0.29±0.04

[1] No wear volumes or wear factors calculated due to severe wear and galling.

[2] Transfer/Build up from pin/disk occurred.

[3] Data points identical-no scatter measured.

[4] Negative values indicate transfer-positive wear.

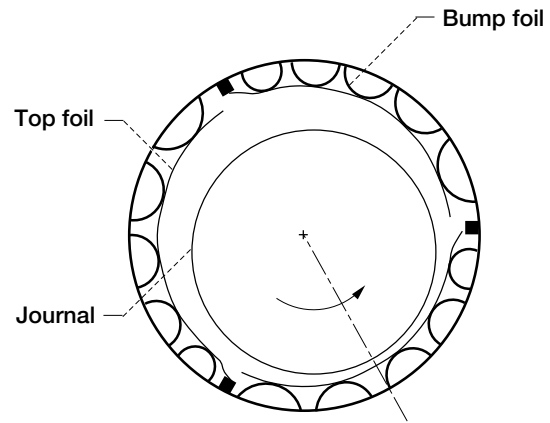

Figure 1.—Bearing cross section.

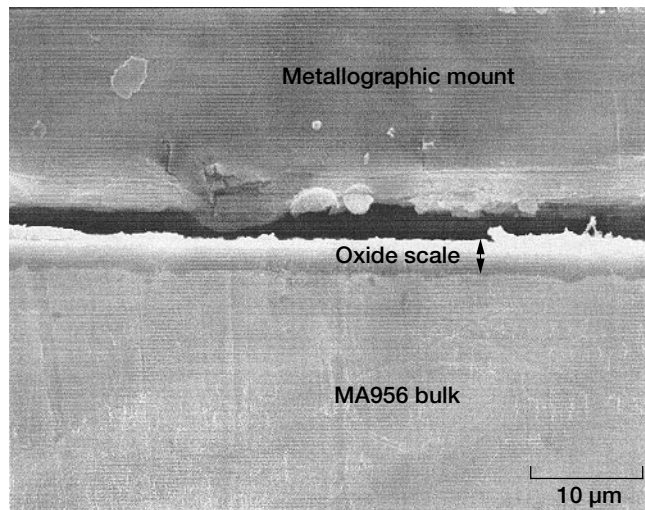

Figure 2.—SEM micrograph cross-section of MA956 after 20 hr heat treatment at 1100 °C in air showing oxide scale.

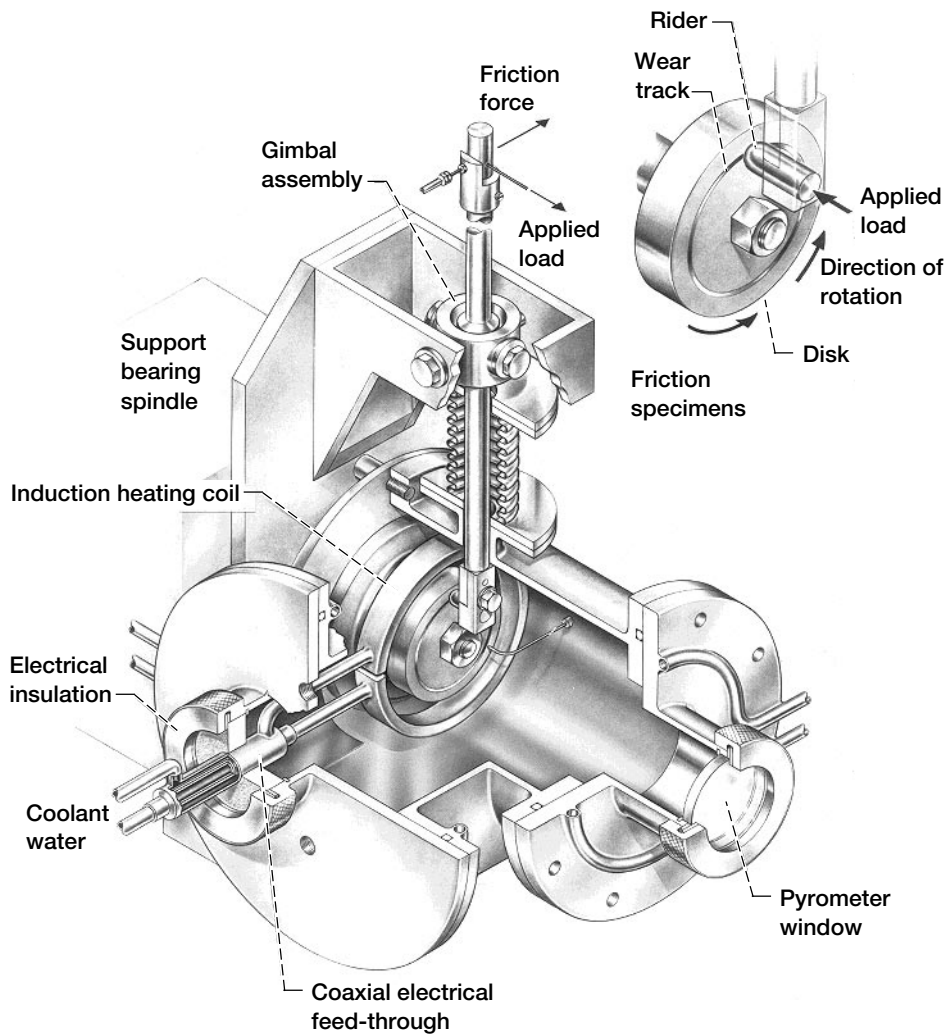

Figure 3.—High temperature pin-on-disk rig.

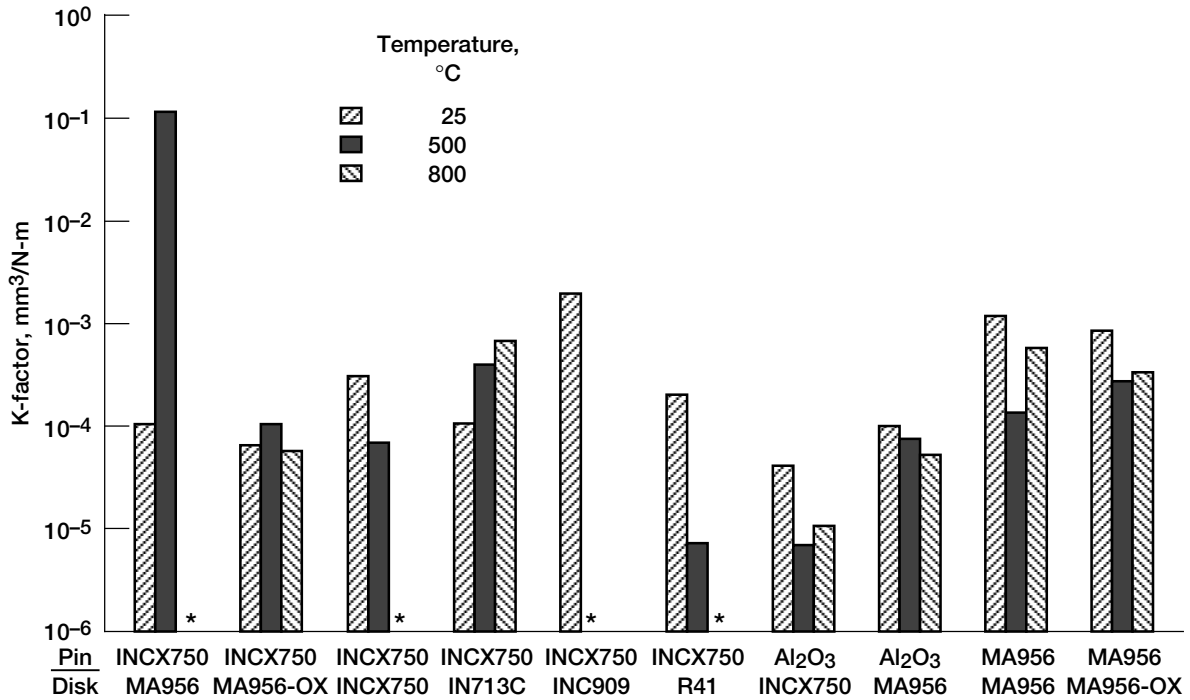

Figure 4.—Pin wear factor data for tests conducted under 4.9 N load, 1 m/s sliding velocity in air. Asterisk (\*) denotes severe galling or test termination - no data available.

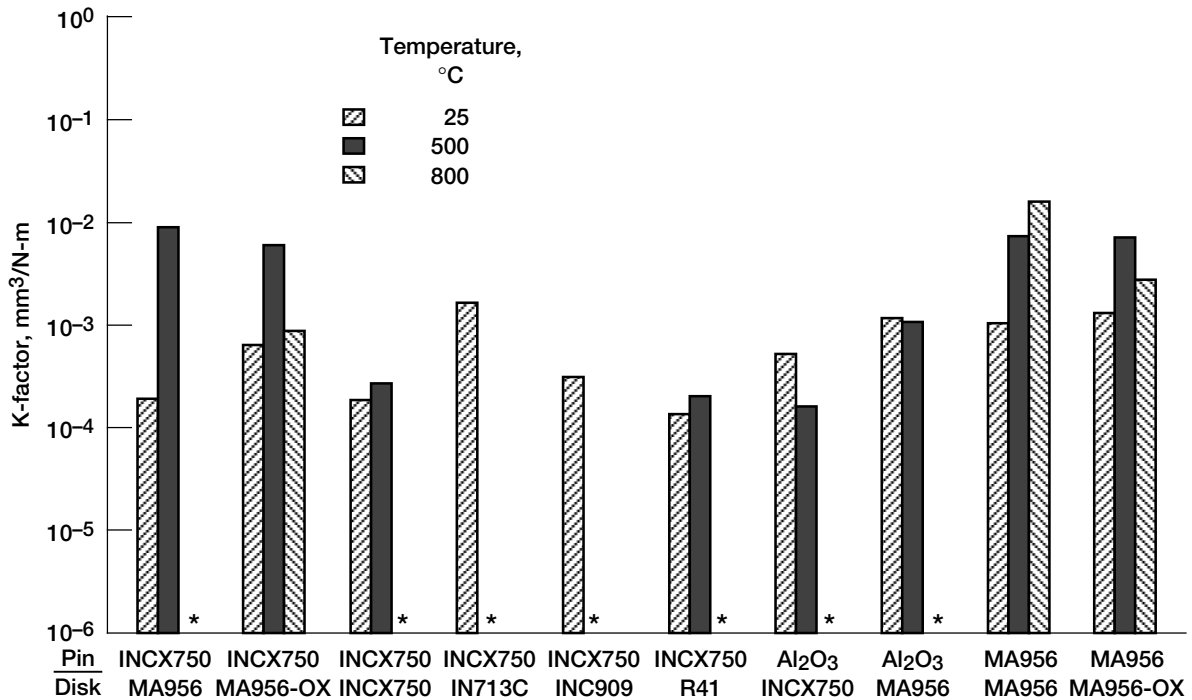

Figure 5.—Disk wear factor for tests conducted under 4.9 N load, 1 m/s sliding velocity in air. Asterisk (\*) denotes severe galling or test termination - no data available.

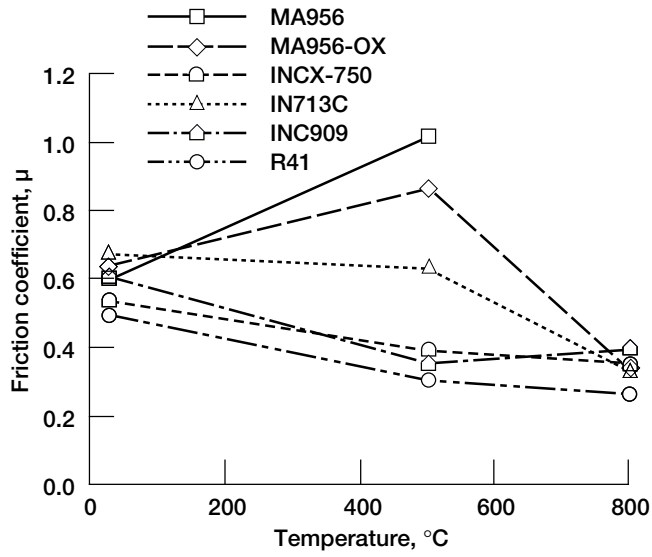

Figure 6.—Friction coefficient vs. temperature for INCX-750 pins sliding on various alloys.

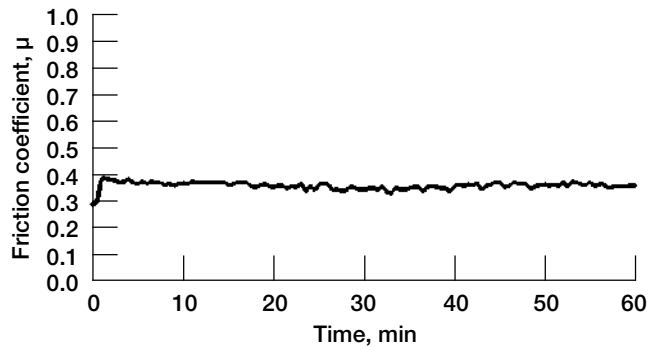

Figure 7.—Typical friction vs. time plot for Al<sub>2</sub>O<sub>3</sub> pin vs. INCX-750 disk, 4.9 N load, 1 m/s sliding velocity in air at 500 °C.

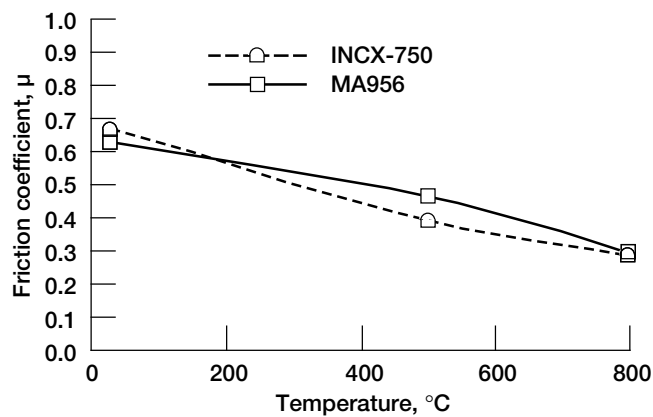

Figure 8.—Friction coefficient vs. temperature for Al<sub>2</sub>O<sub>3</sub> pins sliding on various alloys.

**REPORT DOCUMENTATION PAGE**Form Approved  
OMB No. 0704-0188

Public reporting burden for this collection of information is estimated to average 1 hour per response, including the time for reviewing instructions, searching existing data sources, gathering and maintaining the data needed, and completing and reviewing the collection of information. Send comments regarding this burden estimate or any other aspect of this collection of information, including suggestions for reducing this burden, to Washington Headquarters Services, Directorate for Information Operations and Reports, 1215 Jefferson Davis Highway, Suite 1204, Arlington, VA 22202-4302, and to the Office of Management and Budget, Paperwork Reduction Project (0704-0188), Washington, DC 20503.

<b>1. AGENCY USE ONLY (Leave blank)</b>		<b>2. REPORT DATE</b> July 1996	<b>3. REPORT TYPE AND DATES COVERED</b> Technical Memorandum	
<b>4. TITLE AND SUBTITLE</b> Friction and Wear Characteristics of Candidate Foil Bearing Materials From 25 °C to 800 °C			<b>5. FUNDING NUMBERS</b>  WU-505-63-5A	
<b>6. AUTHOR(S)</b> J.A. Laskowski and C. DellaCorte				
<b>7. PERFORMING ORGANIZATION NAME(S) AND ADDRESS(ES)</b> National Aeronautics and Space Administration Lewis Research Center Cleveland, Ohio 44135-3191			<b>8. PERFORMING ORGANIZATION REPORT NUMBER</b>  E-9958	
<b>9. SPONSORING/MONITORING AGENCY NAME(S) AND ADDRESS(ES)</b> National Aeronautics and Space Administration Washington, D.C. 20546-0001			<b>10. SPONSORING/MONITORING AGENCY REPORT NUMBER</b>  NASA TM-107082 DOE/NASA/50306-11	
<b>11. SUPPLEMENTARY NOTES</b> Prepared for the Annual Meeting sponsored by the Society of Tribologists and Lubrication Engineers, Cincinnati, Ohio, May 19-23, 1996. Under interagency Agreement DE-AI01-91CE-50306. J.A. Laskowski, Parks College, Cahokia, Illinois and C. DellaCorte, NASA Lewis Research Center. Responsible person, C. DellaCorte, organization code 5140, (216) 433-6056.				
<b>12a. DISTRIBUTION/AVAILABILITY STATEMENT</b>  Unclassified - Unlimited Subject Category 23  This publication is available from the NASA Center for AeroSpace Information, (301) 621-0390.			<b>12b. DISTRIBUTION CODE</b>  DOE Category UC-373	
<b>13. ABSTRACT (Maximum 200 words)</b>  The friction and wear behavior of unlubricated metal/metal sliding couples was investigated to screen potential candidates for high temperature foil bearings. The tribo-tests were run in an induction-heated high temperature pin-on-disk tribometer in an air atmosphere at a load of 4.9 N and at a sliding velocity of 1 m/s. The friction and wear properties of several nickel based alloys (Rene' 41, Inconel X-750, Inconel 713C), iron based alloys (MA956 and Inconel 909) and a ceramic (Al <sub>2</sub> O <sub>3</sub> ) were tested at 25 500, and 800 °C. In general, at elevated temperatures the alloys oxidized and formed a tenacious and lubricous oxide surface film or layer. At 800 °C, Inconel X-750 versus Rene' 41 had the lowest friction coefficient (0.27) and at 500 °C, Inconel X-750 versus Inconel 909 the lowest pin wear (2.84x10 <sup>-6</sup> mm <sup>3</sup> /N-m). Gouging and severe wear of the softer material occurred whenever a significant difference in hardness existed between the pin and disk specimens.				
<b>14. SUBJECT TERMS</b> Friction; Wear; Bearings			<b>15. NUMBER OF PAGES</b> 22	
			<b>16. PRICE CODE</b> A03	
<b>17. SECURITY CLASSIFICATION OF REPORT</b> Unclassified	<b>18. SECURITY CLASSIFICATION OF THIS PAGE</b> Unclassified	<b>19. SECURITY CLASSIFICATION OF ABSTRACT</b> Unclassified	<b>20. LIMITATION OF ABSTRACT</b>	