

# Fundamentals of Continuum Mechanics

J. W. Rudnicki<sup>1</sup>

Department of Civil and Environmental Engineering  
and Department of Mechanical Engineering,  
Northwestern University, Evanston, IL

Last update: November 3, 2011  
Last printing: November 3, 2011

<sup>1</sup>©John W. Rudnicki, 2006. Do not distribute without permission.



# Contents

<b>1</b>	<b>Introduction</b>	<b>1</b>
<b>I</b>	<b>Mathematical Preliminaries</b>	<b>3</b>
<b>2</b>	<b>Vectors</b>	<b>5</b>
2.1	Additional Reading . . . . .	10
<b>3</b>	<b>Tensors</b>	<b>11</b>
<b>4</b>	<b>Coordinate Systems</b>	<b>17</b>
4.1	Base Vectors . . . . .	17
4.2	Index Notation . . . . .	18
4.3	Tensor Components . . . . .	21
4.4	Additional Reading . . . . .	21
<b>5</b>	<b>Dyads</b>	<b>23</b>
5.1	Tensor and Scalar Products . . . . .	24
5.2	Identity tensor . . . . .	25
5.3	Additional Reading . . . . .	26
<b>6</b>	<b>Vector (Cross) Product</b>	<b>27</b>
6.1	Properties of the Cross-Product . . . . .	29
6.2	Uses of the Cross Product . . . . .	29
6.2.1	Velocity Due to Rigid Body Rotation . . . . .	30
6.2.2	Moment of a Force $\mathbf{P}$ about $O$ . . . . .	31
6.3	Triple scalar product . . . . .	31
6.4	Triple Vector Product . . . . .	32
6.5	Additional Reading . . . . .	32
<b>7</b>	<b>Determinants</b>	<b>33</b>
7.1	Inverse . . . . .	35
7.2	Product of Two Determinants . . . . .	36
7.3	Additional Reading . . . . .	37

<b>8</b>	<b>Change of Orthonormal Basis</b>	<b>39</b>
8.1	Change of Vector Components . . . . .	41
8.2	Definition of a vector . . . . .	42
8.3	Change of Tensor Components . . . . .	42
8.4	Additional Reading . . . . .	43
<b>9</b>	<b>Principal Values and Principal Directions</b>	<b>45</b>
9.1	Example . . . . .	47
9.2	Additional Reading . . . . .	49
<b>10</b>	<b>Vector and Tensor Calculus</b>	<b>51</b>
10.1	Example: Cylindrical Coordinates . . . . .	55
10.2	Additional Reading . . . . .	55
<b>II</b>	<b>Stress</b>	<b>57</b>
<b>11</b>	<b>Traction and Stress Tensor</b>	<b>59</b>
11.1	Types of Forces . . . . .	59
11.2	Traction on Different Surfaces . . . . .	62
11.3	Traction on an Arbitrary Plane (Cauchy tetrahedron) . . . . .	64
11.4	Symmetry of the stress tensor . . . . .	65
11.5	Additional Reading . . . . .	66
<b>12</b>	<b>Principal Values of Stress</b>	<b>67</b>
12.1	Deviatoric Stress . . . . .	68
12.2	Reading . . . . .	69
<b>13</b>	<b>Stationary Values of Shear Traction</b>	<b>71</b>
13.1	Additional Reading . . . . .	74
<b>14</b>	<b>Mohr's Circle</b>	<b>75</b>
14.1	Example Problem . . . . .	77
14.2	Additional Reading . . . . .	79
<b>III</b>	<b>Motion and Deformation</b>	<b>81</b>
<b>15</b>	<b>Current and Reference Configurations</b>	<b>83</b>
15.1	Additional Reading . . . . .	86
<b>16</b>	<b>Rate of Deformation</b>	<b>89</b>
16.1	Velocity gradients . . . . .	89
16.2	Meaning of $\mathbf{D}$ . . . . .	90
16.3	Meaning of $\mathbf{W}$ . . . . .	92
16.4	Additional Reading . . . . .	93

<b>17 Geometric Measures of Deformation</b>	<b>95</b>
17.1 Deformation Gradient . . . . .	95
17.2 Change in Length of Lines . . . . .	95
17.3 Change in Angles . . . . .	97
17.4 Change in Area . . . . .	98
17.5 Change in Volume . . . . .	99
17.6 Additional Reading . . . . .	100
<b>18 Polar Decomposition</b>	<b>101</b>
<b>19 Strain Tensors</b>	<b>105</b>
19.1 Material Strain Tensors . . . . .	105
19.1.1 Additional Reading . . . . .	107
19.2 Spatial Strain Measures . . . . .	107
19.3 Relations between $\mathbf{D}$ and rates of $\mathbf{E}^G$ and $\mathbf{U}$ . . . . .	109
19.3.1 Relation Between $\dot{\mathbf{E}}^G$ and $\mathbf{D}$ . . . . .	109
19.3.2 Relation Between $\mathbf{D}$ and $\dot{\mathbf{U}}$ . . . . .	111
19.3.3 Additional Reading . . . . .	111
<b>20 Linearized Displacement Gradients</b>	<b>113</b>
20.1 Linearized Geometric Measures . . . . .	115
20.1.1 Stretch in direction $\mathbf{N}$ . . . . .	115
20.1.2 Angle Change . . . . .	116
20.1.3 Volume change . . . . .	116
20.2 Linearized Polar Decomposition . . . . .	117
20.3 Small Strain Compatibility . . . . .	118
20.3.1 Additional Reading . . . . .	121
<b>IV Balance of Mass, Momentum and Energy</b>	<b>123</b>
<b>21 Transformation of Integrals</b>	<b>125</b>
21.1 Additional Reading . . . . .	130
<b>22 Conservation of Mass</b>	<b>131</b>
22.1 Reynolds' Transport Theorem . . . . .	134
22.2 Derivative of an Integral Over a Time-Dependent Region . . . . .	135
22.3 Additional Reading . . . . .	137
<b>23 Conservation of Momentum</b>	<b>139</b>
23.1 Momentum Balance in the Current State . . . . .	139
23.1.1 Linear Momentum . . . . .	139
23.1.2 Angular Momentum . . . . .	140
23.2 Momentum Balance in the Reference State . . . . .	141
23.2.1 Linear Momentum . . . . .	141
23.2.2 Angular Momentum . . . . .	142
23.3 Additional Reading . . . . .	143

---

<b>24 Conservation of Energy</b>	<b>145</b>
24.1 Work Conjugate Stresses . . . . .	147
24.2 Additional Reading . . . . .	149
<b>V Ideal Constitutive Relations</b>	<b>151</b>
<b>25 Fluids</b>	<b>155</b>
25.1 Ideal Frictionless Fluid . . . . .	155
25.2 Isotropic tensors . . . . .	157
25.3 Linearly Viscous Fluid . . . . .	159
25.4 Additional Reading . . . . .	161
<b>26 Elasticity</b>	<b>163</b>
26.1 Nonlinear Elasticity . . . . .	163
26.2 Linearization of Elasticity Equations . . . . .	165
26.3 Linearized Elasticity . . . . .	167
26.3.1 Material Symmetry . . . . .	169
26.3.2 Linear Isotropic Elastic Constitutive Relation . . . . .	171
26.4 Restrictions on Elastic Constants . . . . .	172
26.5 Additional Reading . . . . .	173

# Preface

These notes are based on lectures given in C. E. 417-1, Mechanics of Continua, I at Northwestern University.





# Chapter 1

## Introduction

Continuum mechanics is a mathematical framework for studying the transmission of force through and deformation of materials of all types. The goal is to construct a framework that is free of special assumptions about the type of material, the size of deformations, the geometry of the problem and so forth. Of course, no real materials are actually continuous. We know from physics and chemistry that all materials are formed of discrete atoms and molecules. Even at much larger size scales, materials may be composed of distinct grains, e.g., a sand, or of grains of different constituents, e.g., steel, or deformable particles such as blood. Nevertheless, treating material as continuous is a great advantage since it allows us to use the mathematical tools of continuous functions, such as differentiation. In addition to being convenient, this approach works remarkably well. This is true even at size scales for which the justification of treating the material as a continuum might be debatable. The ultimate justification is that predictions made using continuum mechanics are in accord with observations and measurements.

Until recently, it was possible to solve a relatively small number of problems without the assumptions of small deformations and linear elastic behavior. Now, however, modern computational techniques have made it possible to solve problems involving large deformation and complex material behavior. This possibility has made it important to formulate these problems correctly and to be able to interpret the solutions. Continuum mechanics does this.

The vocabulary of continuum mechanics involves mathematical objects called tensors. These can be thought of as following naturally from vectors. Therefore, we will begin by studying vectors. Although most students are acquainted with vectors in some form or another, we will reintroduce them in a way that leads naturally to tensors.



**Part I**

**Mathematical Preliminaries**



# Chapter 2

## Vectors

Some physical quantities are described by scalars, e.g., density, temperature, kinetic energy. These are pure numbers, although they do have dimensions. It would make no physical sense to add a density, with dimensions of mass divided by length cubed, to kinetic energy, with dimensions of mass times length squared divided by time squared.

Vectors are mathematical objects that are associated with both a magnitude, described by a number, and a direction. An important property of vectors is that they can be used to represent physical entities such as force, momentum and displacement. Consequently, the meaning of the vector is (in a sense we will make precise) independent of how it is represented. For example, if someone punches you in the nose, this is a physical action that could be described by a force vector. The physical action and its result (a sore nose) are, of course, independent of the particular coordinate system we use to represent the force vector. Hence, the meaning of the vector is not tied to any particular coordinate system or description.

A vector  $\mathbf{u}$  can be represented as a directed line segment, as shown in Figure 2.1. The length of the vector is denoted by  $u$  or by  $|\mathbf{u}|$ . Multiplying a vector by a positive scalar  $\alpha$  changes the length or magnitude of the vector but not its orientation. If  $\alpha > 1$ , the vector  $\alpha\mathbf{u}$  is longer than  $\mathbf{u}$ ; if  $\alpha < 1$ ,  $\alpha\mathbf{u}$  is shorter than  $\mathbf{u}$ . If  $\alpha$  is negative, the orientation of the vector is reversed. The addition of two vectors  $\mathbf{u}$  and  $\mathbf{v}$  can be written

$$\mathbf{w} = \mathbf{u} + \mathbf{v} \tag{2.1}$$

Although the same symbol is used as for ordinary addition, the meaning here is different. Vectors add according to the parallelogram law shown in Figure 2.1. It is clear from the construction that vector addition is commutative

$$\mathbf{w} = \mathbf{u} + \mathbf{v} = \mathbf{v} + \mathbf{u} \tag{2.2}$$

Note the importance of distinguishing vectors from scalars; without the boldface denoting vectors, equation (2.1) would be incorrect: the magnitude of  $\mathbf{w}$  is not

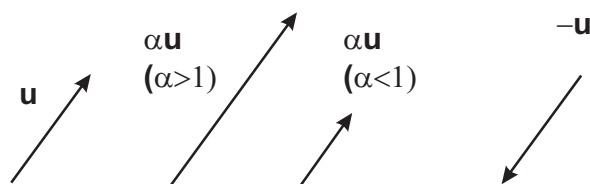

Multiplication of a vector by a scalar.

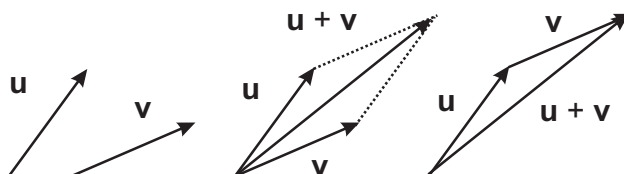

Addition of two vectors.

Figure 2.1: Multiplication of a vector by a scalar (top) and addition of two vectors (bottom).

the sum of the magnitudes of  $\mathbf{u}$  and  $\mathbf{v}$ . Alternatively the “tail” of one vector may be placed at the “head” of the other. The sum is then the vector directed from the free “tail” to the free “head”. Implicit in both these operations is the idea that we are dealing with “free” vectors. In order to add two vectors, they can be moved, keeping the length and orientation, so that both vectors emanate from the same point or are connected head-to-tail.

The parallelogram rule for vector addition turns out to be a crucial property for vectors. Note that it follows from the nature of the physical quantities, e.g., velocity and force, that we represent by vectors. The rule for vector addition is also one way to distinguish vectors from other quantities that have both length and direction. For example, finite rotations about orthogonal axes can be characterized by length and magnitude but cannot be vectors because addition is not commutative (see Malvern, pp. 15-16). Hoffman (*About Vectors*, p. 11) relates the story of the tribe (now extinct) that thought spears were vectors because they had length and magnitude. To kill a deer to the northeast, they would throw two spears, one to the north and one to the east, depending on the resultant to strike the deer. Not surprisingly, there is no trace of this tribe, which only confirms the adage that “a little bit of knowledge can be a dangerous thing.”

The procedure for vector subtraction follows from multiplication by a scalar and addition. To subtract  $\mathbf{v}$  from  $\mathbf{u}$ , first multiply  $\mathbf{v}$  by  $-1$ , then add  $-\mathbf{v}$  to  $\mathbf{u}$ :

$$\mathbf{w} = \mathbf{u} - \mathbf{v} = \mathbf{u} + (-\mathbf{v}) \quad (2.3)$$

There are two ways to multiply vectors: the scalar or dot product and the vector or cross product. The scalar product is given by

$$\mathbf{u} \cdot \mathbf{v} = uv \cos(\theta) \quad (2.4)$$

where  $\theta$  is the angle between  $\mathbf{u}$  and  $\mathbf{v}$ . As indicated by the name, the result of this operation is a scalar. As shown in Figure 2.2, the scalar product is the magnitude of  $\mathbf{v}$  multiplied by the projection  $\mathbf{u}$  onto  $\mathbf{v}$ , or vice versa. If  $\theta = \pi/2$ , the two vectors are *orthogonal*; if  $\theta = \pi$ , the two vectors are opposite in sense, i.e., their arrows point in opposite directions. The result of the vector or cross product is a vector

$$\mathbf{w} = \mathbf{u} \times \mathbf{v} \quad (2.5)$$

The magnitude of the result is  $w = uv \sin(\theta)$ , where  $\theta$  is again the angle between  $\mathbf{u}$  and  $\mathbf{v}$ . As shown in Figure 2.2, the magnitude of the cross product is equal to the area of the parallelogram formed by  $\mathbf{u}$  and  $\mathbf{v}$ . The direction of  $\mathbf{w}$  is perpendicular to the plane formed by  $\mathbf{u}$  and  $\mathbf{v}$  and the sense is given by the *right hand rule*: If the fingers of the right hand are in the direction of  $\mathbf{u}$  and then curled in the direction of  $\mathbf{v}$ , then the thumb of the right hand is in the direction of  $\mathbf{w}$ . The three vectors  $\mathbf{u}$ ,  $\mathbf{v}$  and  $\mathbf{w}$  are said to form a right-handed system.

The triple vector product  $(\mathbf{u} \times \mathbf{v}) \cdot \mathbf{w}$  is equal to the volume of the parallelepiped formed by  $\mathbf{u}$ ,  $\mathbf{v}$  and  $\mathbf{w}$  if they are right-handed and minus the volume

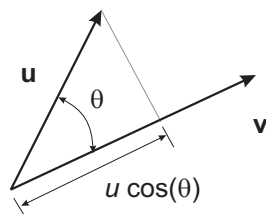

Scalar product of two vectors.

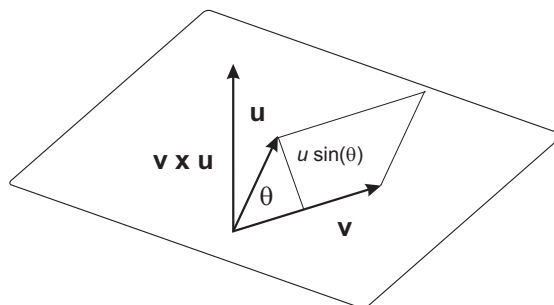

Cross product of two vectors.

Figure 2.2: Scalar and vector products.



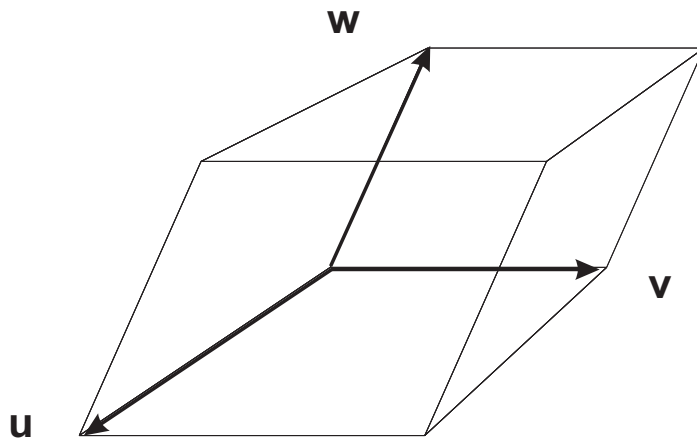

The triple vector product  $\mathbf{u} \times \mathbf{v} \cdot \mathbf{w}$  is the volume of the parallelepiped formed by the vectors if the order of the vectors is right-handed.

Figure 2.3: Triple vector product.

if they are not (Figure 2.3). The parenthesis in this expression can be omitted because it makes no sense if the dot product is taken first (because the result is a scalar and the cross product is an operation between two vectors).

Now consider the triple vector product  $\mathbf{u} \times (\mathbf{v} \times \mathbf{w})$ . The vector  $\mathbf{v} \times \mathbf{w}$  must be perpendicular to the plane containing  $\mathbf{v}$  and  $\mathbf{w}$ . Hence, the vector product of  $\mathbf{v} \times \mathbf{w}$  with another vector  $\mathbf{u}$  must result in a vector that is in the plane of  $\mathbf{v}$  and  $\mathbf{w}$ . Consequently, the result of this operation can be represented as

$$\mathbf{u} \times (\mathbf{v} \times \mathbf{w}) = \alpha \mathbf{v} + \beta \mathbf{w} \tag{2.6}$$

## 2.1 Additional Reading

Chadwick, Chapter 1, Section 1; Malvern, Section 2.1, 2.2, 2.3; Reddy, 2.2.1 - 3.

# Chapter 3

## Tensors

A *tensor* is a linear, homogeneous vector-valued vector function. “Vector-valued vector function” means that a tensor operates on a vector and produces a vector as a result of the operation as depicted schematically in Figure 3.1. Hence, the action of a tensor  $\mathbf{F}$  on a vector  $\mathbf{u}$  results in another vector  $\mathbf{v}$ :

$$\mathbf{v} = \mathbf{F}(\mathbf{u}) \quad (3.1)$$

“Homogeneous” (of degree 1) means that the function  $\mathbf{F}$  has the property

$$\mathbf{F}(\alpha\mathbf{u}) = \alpha\mathbf{F}(\mathbf{u}) = \alpha\mathbf{v} \quad (3.2)$$

where  $\alpha$  is a scalar. (Note: A function  $f(x, y)$  is said to be homogeneous of degree  $n$  if  $f(\alpha x, \alpha y) = \alpha^n f(x, y)$ . A function  $f(x, y)$  is linear if

$$f(x, y) = \alpha x + \beta y + c \quad (3.3)$$

Hence,  $f(x, y) = \sqrt{x^2 + y^2}$  is homogeneous of degree one but not linear. Similarly,  $f(x, y) = a(x + y) + c$  is linear but not homogeneous.) The function  $\mathbf{F}$  is

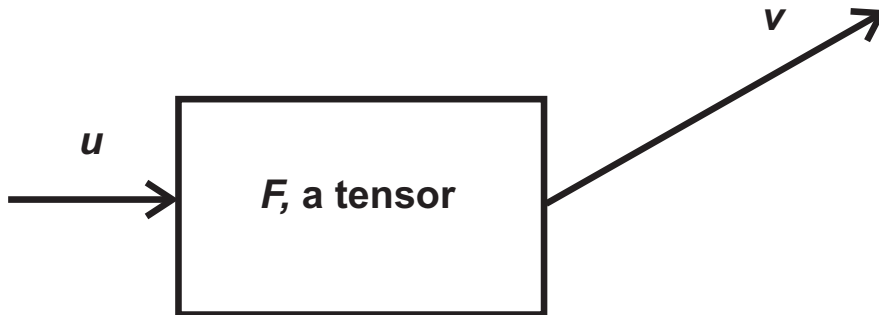

Figure 3.1: Schematic illustration of the effect of a tensor on a vector. The tensor acts on the vector  $\mathbf{u}$  and outputs the vector  $\mathbf{v}$ .

“linear” if

$$\mathbf{F}(\mathbf{u}_1 + \mathbf{u}_2) = \mathbf{F}(\mathbf{u}_1) + \mathbf{F}(\mathbf{u}_2) = \mathbf{v}_1 + \mathbf{v}_2 \quad (3.4)$$

where  $\mathbf{v}_1 = \mathbf{F}(\mathbf{u}_1)$  and  $\mathbf{v}_2 = \mathbf{F}(\mathbf{u}_2)$

The definition of a tensor embodied by the properties (3.1), (3.2), and (3.4) suggests that a tensor can be represented in coordinate-free notation as

$$\mathbf{v} = \mathbf{F} \cdot \mathbf{u} \quad (3.5)$$

The operation denoted by the dot is defined by the properties (3.2), and (3.4). Therefore, if we want to determine if a "black box", a function  $\mathbf{F}$ , is a tensor, we input a vector  $\mathbf{u}$  into the box. If the result of the operation represented by  $\mathbf{F}$  is also a vector, say  $\mathbf{v}$ , then  $\mathbf{F}$  must be a tensor. Since both sides of (3.5) are vectors, we can form the scalar product with another vector, say  $\mathbf{w}$ ,

$$\mathbf{w} \cdot \mathbf{v} = \mathbf{w} \cdot \mathbf{F} \cdot \mathbf{u} \quad (3.6)$$

and the result must be a scalar. Because scalar multiplication of two vectors is commutative, the order of the vectors on the left side can be reversed. On the right side, it would be necessary to write  $(\mathbf{F} \cdot \mathbf{u}) \cdot \mathbf{w}$ . The parentheses indicate that the operation  $\mathbf{F} \cdot \mathbf{u}$  must be done first; indeed, multiplying  $\mathbf{u} \cdot \mathbf{w}$  first produces a scalar and the dot product of a scalar with a vector (or a tensor) is not an operation that is defined.

In contrast to the dot product of two vectors, the dot product of a tensor and a vector is not commutative. Reversing the order defines the *transpose* of the tensor  $\mathbf{F}$  i.e.,

$$\mathbf{F} \cdot \mathbf{u} = \mathbf{u} \cdot \mathbf{F}^T \quad (3.7)$$

Thus, it follows that

$$\mathbf{v} \cdot \mathbf{F} \cdot \mathbf{u} = \mathbf{u} \cdot \mathbf{F}^T \cdot \mathbf{v} \quad (3.8)$$

where parentheses are not needed because the notation clearly indicates that the two vectors are not to be multiplied. If  $\mathbf{F} = \mathbf{F}^T$ , then the tensor  $\mathbf{F}$  is said to be *symmetric*; if  $\mathbf{F} = -\mathbf{F}^T$ , then  $\mathbf{F}$  is *antisymmetric* or *skew-symmetric*. Every tensor can be separated into the sum of a symmetric and a skew-symmetric tensor by adding and subtracting its transpose

$$\mathbf{F} = \frac{1}{2}(\mathbf{F} + \mathbf{F}^T) + \frac{1}{2}(\mathbf{F} - \mathbf{F}^T) \quad (3.9)$$

Generally, the output vector  $\mathbf{v}$  will have a different magnitude and direction from the input vector  $\mathbf{u}$ . In the special case that  $\mathbf{v}$  is the same as  $\mathbf{u}$ , then for obvious reasons, the tensor is called the *identity* tensor and denoted  $\mathbf{I}$ . Hence, the identity tensor is defined by

$$\mathbf{u} = \mathbf{I} \cdot \mathbf{u} \quad (3.10)$$

for all vectors  $\mathbf{u}$ . Is it possible to operate our tensor black box in reverse? In terms of Figure 3.1, if we stick  $\mathbf{v}$  in the right side, will we get  $\mathbf{u}$  out the left?

The answer is “not always” although in many cases it will be possible for the particular tensors we are concerned with. Later we will determine the conditions for which the operation depicted in Figure 3.1 is reversible. If it is, then the operation defines the inverse of  $\mathbf{F}$

$$\mathbf{u} = \mathbf{F}^{-1} \cdot \mathbf{v} \quad (3.11)$$

Substituting for  $\mathbf{v}$  from (3.5) reveals that

$$\mathbf{F}^{-1} \cdot \mathbf{F} = \mathbf{I} \quad (3.12)$$

and that the dot product between two tensors produces another tensor.

If the output vector  $\mathbf{v}$  has the same magnitude as the input vector  $\mathbf{u}$ , but a different direction, then the tensor operation results in a rotation

$$\mathbf{v} = \mathbf{R} \cdot \mathbf{u} \quad (3.13)$$

and the tensor is called *orthogonal* (for reasons we will see later). Because  $\mathbf{u}$  and  $\mathbf{v}$  have the same magnitudes

$$v^2 = \mathbf{v} \cdot \mathbf{v} = \mathbf{u} \cdot \mathbf{u} = u^2$$

Using (3.7) to rewrite the left scalar product and (3.10) to rewrite the right gives

$$\mathbf{u} \cdot \mathbf{R}^T \cdot \mathbf{R} \cdot \mathbf{u} = \mathbf{u} \cdot \mathbf{I} \cdot \mathbf{u} \quad (3.14)$$

where no parentheses are necessary because the notation makes clear what is to be done. Because (3.14) applies for *any* vector  $\mathbf{u}$ , we can conclude that

$$\mathbf{R}^T \cdot \mathbf{R} = \mathbf{I} \quad (3.15)$$

and comparing with (3.12) reveals that the transpose of an orthogonal tensor is equal to its inverse. Physically, the rotation of a vector to another direction can always be reversed so we can expect the inverse to exist.

Is it possible to find an input vector  $\mathbf{u}$  such that the output vector  $\mathbf{v}$  has the same direction, but possibly a different magnitude? Intuitively, we expect that this is only possible for certain input vectors, if any. If the vector  $\mathbf{v}$  is in the same direction as  $\mathbf{u}$ , then  $\mathbf{v} = \lambda \mathbf{u}$ , where  $\lambda$  is a scalar. Substituting in (3.5) yields

$$\mathbf{F} \cdot \mathbf{u} = \lambda \mathbf{u} \quad (3.16)$$

or

$$(\mathbf{F} - \lambda \mathbf{I}) \cdot \mathbf{u} = \mathbf{0} \quad (3.17)$$

If the inverse of  $\mathbf{F} - \lambda \mathbf{I}$  exists then the only possible solution is  $\mathbf{u} = \mathbf{0}$ . Consequently there will be special values of  $\lambda$  and  $\mathbf{u}$  that satisfy this equation only when the inverse does not exist. A value of  $\lambda$  that does so is an *eigenvalue* (*principal value, proper number*) of the tensor  $\mathbf{F}$  and the corresponding direction given by  $\mathbf{u}$  is the eigenvector (principal direction). It is clear from (3.17) that if  $\mathbf{u}$  is a solution, then so is  $\alpha \mathbf{u}$  where  $\alpha$  is any scalar. Hence, only the

direction of the eigenvector is determined. It is customary to acknowledge this by normalizing the eigenvector to unit magnitude,  $\boldsymbol{\mu} = \mathbf{u}/u$ .

Later we will learn how to determine the principal values and directions and their physical significance. But, because all of the tensors we will deal with are real and many of them are symmetric, we can prove that the eigenvalues and eigenvectors must have certain properties without having to determine them explicitly.

First we will prove that a real, symmetric 2nd order tensor has real eigenvalues. Let  $\mathbf{T}$  be a real symmetric 2nd order tensor with eigenvalues  $\lambda_K$ ,  $K = \text{I, II, III}$  and corresponding eigenvectors  $\boldsymbol{\mu}_K$ ,  $K = \text{I, II, III}$ . Then

$$\mathbf{T} \cdot \boldsymbol{\mu}_K = \lambda_K \boldsymbol{\mu}_K, \text{ (no sum on } K) \quad (3.18)$$

Taking complex conjugate of both sides gives

$$\bar{\mathbf{T}} \cdot \bar{\boldsymbol{\mu}}_K = \bar{\lambda}_K \bar{\boldsymbol{\mu}}_K, \text{ (no sum on } K) \quad (3.19)$$

Multiplying (3.18) by  $\bar{\boldsymbol{\mu}}_K$  yields

$$\bar{\boldsymbol{\mu}}_K \cdot \mathbf{T} \cdot \boldsymbol{\mu}_K = \lambda_K \bar{\boldsymbol{\mu}}_K \cdot \boldsymbol{\mu}_K, \text{ (no sum on } K) \quad (3.20)$$

and (3.19) by  $\boldsymbol{\mu}_K$  yields

$$\boldsymbol{\mu}_K \cdot \bar{\mathbf{T}} \cdot \bar{\boldsymbol{\mu}}_K = \bar{\lambda}_K \bar{\boldsymbol{\mu}}_K \cdot \boldsymbol{\mu}_K, \text{ (no sum on } K) \quad (3.21)$$

Because  $\mathbf{T} = \mathbf{T}^T$ , the left hand sides are the same. Therefore, subtracting gives

$$0 = (\lambda_K - \bar{\lambda}_K) \bar{\boldsymbol{\mu}}_K \cdot \boldsymbol{\mu}_K, \text{ (no sum on } K) \quad (3.22)$$

Since  $\bar{\boldsymbol{\mu}}_K \cdot \boldsymbol{\mu}_K \neq 0$ ,  $\lambda_k = \bar{\lambda}_k$  and hence, the eigenvalues are real.

Now prove that the eigenvectors corresponding to distinct eigenvalues are orthogonal. For eigenvalue  $\lambda_I$  and corresponding eigenvector  $\boldsymbol{\mu}_I$

$$\mathbf{T} \cdot \boldsymbol{\mu}_I = \lambda_I \boldsymbol{\mu}_I \quad (3.23)$$

and similarly for  $\lambda_{II}$  and  $\boldsymbol{\mu}_{II}$

$$\mathbf{T} \cdot \boldsymbol{\mu}_{II} = \lambda_{II} \boldsymbol{\mu}_{II} \quad (3.24)$$

Dotting (3.23) with  $\boldsymbol{\mu}_{II}$  and (3.24) with  $\boldsymbol{\mu}_I$  yields

$$\boldsymbol{\mu}_{II} \cdot \mathbf{T} \cdot \boldsymbol{\mu}_I = \lambda_I \boldsymbol{\mu}_I \cdot \boldsymbol{\mu}_{II} \quad (3.25a)$$

$$\boldsymbol{\mu}_I \cdot \mathbf{T} \cdot \boldsymbol{\mu}_{II} = \lambda_{II} \boldsymbol{\mu}_{II} \cdot \boldsymbol{\mu}_I \quad (3.25b)$$

Because  $\mathbf{T} = \mathbf{T}^T$  subtracting yields

$$(\lambda_I - \lambda_{II}) \boldsymbol{\mu}_I \cdot \boldsymbol{\mu}_{II} = 0 \quad (3.26)$$

Because the eigenvalues are assumed to be distinct  $\lambda_I \neq \lambda_{II}$ , and, consequently  $\boldsymbol{\mu}_I \cdot \boldsymbol{\mu}_{II} = 0$ . If  $\lambda_I = \lambda_{II} \neq \lambda_{III}$ , any vectors in the plane perpendicular to  $\boldsymbol{\mu}_{III}$

can serve as eigenvectors. Therefore, it is always possible to find at least one set of orthogonal eigenvectors.

Lastly, we note the tensors we have introduced here are *second order tensors* because they input a vector and output a vector. We can, however, define  $n$ th order tensors  $\mathbf{T}^{(n)}$  by the following recursive relation

$$\mathbf{T}^{(n)} \cdot \mathbf{u} = \mathbf{T}^{(n-1)} \tag{3.27}$$

If  $\mathbf{T}^{(0)}$  is defined as a scalar then (3.27) shows that a vector can be considered as a tensor of order one. Later we will have occasion to deal with 3rd and 4th order tensors.





## Chapter 4

# Coordinate Systems

We have discussed a number of vector and tensor properties without referring at all to any particular coordinate system. Philosophically, this is attractive because it emphasizes the independence of the physical entity from a particular system. This process soon becomes cumbersome, however, and it is convenient to discuss vectors and tensors in terms of their components in a coordinate system. Moreover, when considering a particular problem or implementing the formulation in a computer, it is necessary to adopt a coordinate system.

Given that a coordinate system is necessary, we might take the approach that we should express our results on vectors in a form that is appropriate for any coordinate system. That is, we will make no assumptions that the axes of the system are orthogonal or scaled in the same way and so on. Indeed, this is often useful and can lead to a deeper understanding of vectors. Nevertheless, it requires the introduction of many details that, at least at this stage, will be distracting to our study of mechanics.

For the reasons just-discussed, we will consider almost exclusively rectangular cartesian coordinate systems. We will, however, continue to use and emphasize a coordinate free notation. Fortunately, results that can be expressed in a coordinate free notation, if interpreted properly, can be translated into any arbitrary coordinate system.

### 4.1 Base Vectors

A rectangular, cartesian coordinate system with origin  $O$  is shown in Figure 4.1. The axes are orthogonal and are labelled  $x, y$ , and  $z$ , or  $x_1, x_2$  and  $x_3$ . A convenient way to specify the coordinate system is to introduce vectors that are tangent to the coordinate directions. More generally, a set of vectors is a *basis* for the space if every vector in the space can be expressed as a unique linear combination of the basis vectors. For rectangular cartesian systems, these base vectors can be chosen as unit vectors

$$|\mathbf{e}_1| = \mathbf{e}_1 \cdot \mathbf{e}_1 = 1, \quad |\mathbf{e}_2| = |\mathbf{e}_3| = 1 \quad (4.1)$$

that are orthogonal:

$$\mathbf{e}_1 \cdot \mathbf{e}_2 = 0, \quad \mathbf{e}_1 \cdot \mathbf{e}_3 = 0, \quad \mathbf{e}_2 \cdot \mathbf{e}_3 = 0 \quad (4.2)$$

The six equations, (4.1) and (4.2), and the additional three that result from reversing the order of the dot product in (4.2) can be written more compactly as

$$\mathbf{e}_i \cdot \mathbf{e}_j = \delta_{ij} = \begin{cases} 1, & \text{if } i = j \\ 0 & \text{if } i \neq j \end{cases} \quad (4.3)$$

where the indicies  $(i, j)$  stand for  $(1, 2, 3)$  and  $\delta_{ij}$  is the *Kronecker delta*. Therefore, (4.3) represents nine equations. Note that one  $i$  and one  $j$  appear on each side of the equation and that each index can take on the value 1, 2, or 3. Consequently,  $i$  and  $j$  in (4.3) are *free indicies*.

The projection of the vector  $\mathbf{u}$  on a coordinate direction is given by

$$u_i = \mathbf{e}_i \cdot \mathbf{u} \quad (4.4)$$

where  $i = 1, 2, 3$  and  $u_i$  is the scalar component of  $\mathbf{u}$ . We can now represent the vector  $\mathbf{u}$  in terms of its components and the unit base vectors:

$$\mathbf{u} = u_1 \mathbf{e}_1 + u_2 \mathbf{e}_2 + u_3 \mathbf{e}_3 \quad (4.5)$$

Each term, e.g.,  $u_1 \mathbf{e}_1$  is a vector component of  $\mathbf{u}$ . The left side of the equation is a *coordinate free* representation; that is, it makes no reference to a particular coordinate system that we are using to represent the vector. The right side is the component form; the presence of the base vectors  $\mathbf{e}_1$ ,  $\mathbf{e}_2$  and  $\mathbf{e}_3$  denote explicitly that  $u_1$ ,  $u_2$ , and  $u_3$  are the components with respect to the coordinate system with these particular base vectors. For a different coordinate system, with different base vectors, the right side would be different but would still represent the same vector, indicated by the coordinate free form on the left side.

## 4.2 Index Notation

The equation (4.5) can be expressed more concisely by using the summation sign:

$$\mathbf{u} = \sum_{k=1}^3 u_k \mathbf{e}_k = u_k \mathbf{e}_k \quad (4.6)$$

where “ $k$ ” is called a summation index because it takes on the explicit values 1, 2, and 3. It is also called a dummy index because it is simply a placeholder: changing “ $k$ ” to “ $m$ ” does not alter the meaning of the equation. Note that “ $k$ ” appears twice on RHS but not on LHS. (In contrast, the free index “ $i$ ” on the right side of (4.3) cannot be changed to “ $m$ ” without making the same change

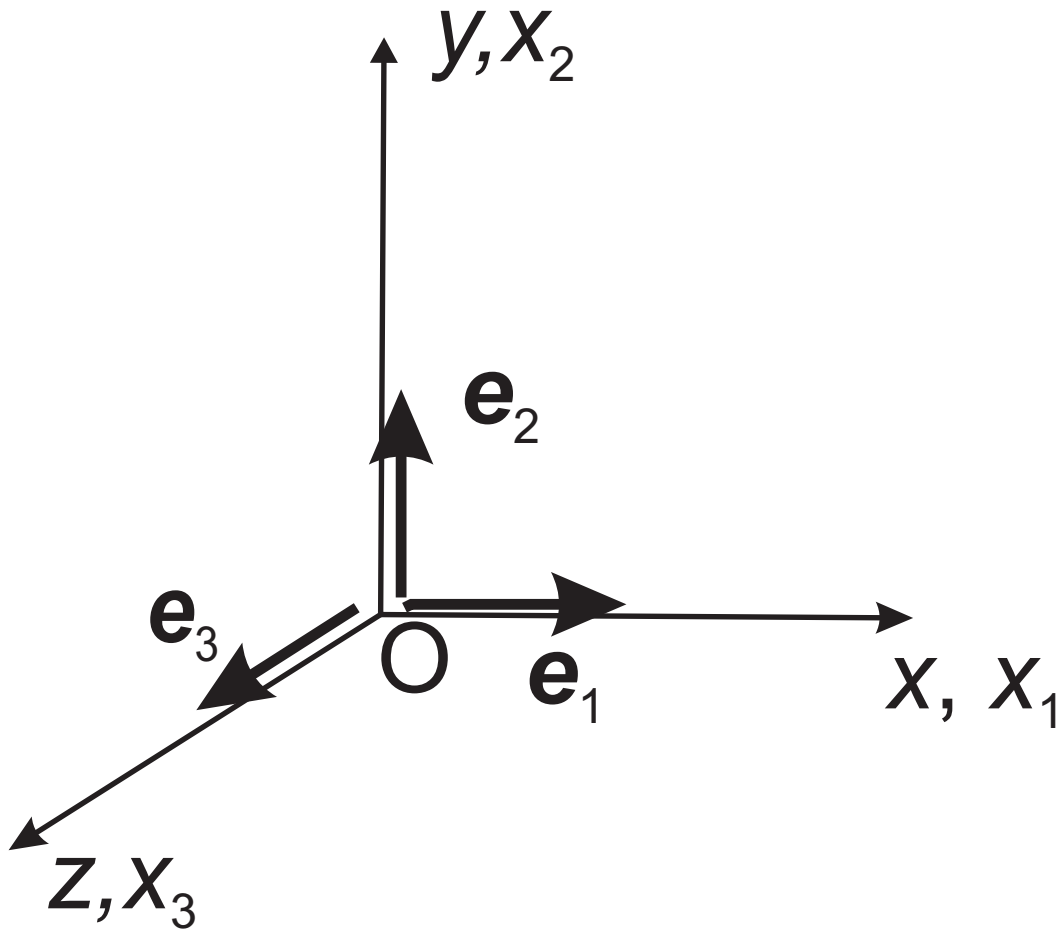

Figure 4.1: Rectangular, cartesian coordinate system specified by unit, orthogonal base vectors.

on the other side of the equation.) Because the form (4.6) occurs so frequently, we will adopt the *summation convention*: The summation symbol is dropped and summation is implied whenever an index is repeated in an additive term (a term separated by a plus or minus sign) on one side of the equation. This is a very compact and powerful notation but it requires adherence to certain rules. Regardless of the physical meaning of the equation, the following rules apply:

- A subscript should never appear more than twice (in an additive term) on one side of an equation.
- If a subscript appears once on one side of an equation it must appear exactly once (in each additive term) on the other side

For example, both of the following two equations are incorrect because the index “ $j$ ” appears once on the right side but not at all on the left:

$$w_i = u_i + v_j \tag{4.7a}$$

$$w_i = u_k v_j s_k t_i \tag{4.7b}$$

The following equation is incorrect because the index “ $k$ ” appears three times in an additive term:

$$w_{ij} = A_{ik} B_{jk} u_k \tag{4.8}$$

In contrast, the equation

$$a = u_k v_k + r_k s_k + p_k q_k \tag{4.9}$$

is correct. Even though “ $k$ ” appears six times on the right side, it only appears twice in each additive term.

We can now use the scalar product, the base vectors and index notation to verify some relations we have obtained by other means. To determine the component of the vector  $\mathbf{u}$  with respect to the  $i$ th coordinate direction we form the scalar product  $\mathbf{e}_i \cdot \mathbf{u}$  and then express  $\mathbf{u}$  in its component form:

$$\mathbf{e}_i \cdot \mathbf{u} = \mathbf{e}_i \cdot (u_j \mathbf{e}_j) \tag{4.10}$$

Note that it would be incorrect to write  $u_i \mathbf{e}_i$  on the right side since the index  $i$  would then appear three times. The scalar product is an operation between vectors and, thus, applies to the two basis vectors. Their scalar product is given by (4.3). Recalling that the repeated  $j$  implies summation and using the property of the Kronecker delta (4.3) yields

$$\mathbf{e}_i \cdot \mathbf{u} = u_j (\mathbf{e}_i \cdot \mathbf{e}_j) \tag{4.11a}$$

$$= u_j \delta_{ij} = \sum_{j=1}^3 \delta_{ij} u_j = \delta_{i1} u_1 + \delta_{i2} u_2 + \delta_{i3} u_3 \tag{4.11b}$$

$$= u_i \tag{4.11c}$$

Thus the inner product of a vector with a basis vector gives the component of the vector in that direction. This operation can be used to convert coordinate-free expressions to their cartesian component form. For example, the sum of two vectors is given by

$$\mathbf{w} = \mathbf{u} + \mathbf{v} \quad (4.12)$$

in the coordinate free notation. Dotted both sides with the base vectors  $\mathbf{e}_i$  yields the component form

$$w_i = u_i + v_i \quad (4.13)$$

As a final example, consider the expression for the scalar product in terms of the components of the vectors:

$$\mathbf{u} \cdot \mathbf{v} = (u_i \mathbf{e}_i) \cdot (v_j \mathbf{e}_j) \quad (4.14a)$$

$$= u_i v_j (\mathbf{e}_i \cdot \mathbf{e}_j) \quad (4.14b)$$

$$= u_i v_j \delta_{ij} = \sum_{i=1}^3 \sum_{j=1}^3 u_i v_j \delta_{ij} = \sum u_j v_j = u_k v_k \quad (4.14c)$$

### 4.3 Tensor Components

The definition of a tensor embodied by the properties (3.1), (3.2), and (3.4) suggests that a tensor can be represented in coordinate-free notation as

$$\mathbf{v} = \mathbf{F} \cdot \mathbf{u} \quad (4.15)$$

The cartesian component representation follows from the procedure for identifying the cartesian components of vectors, i.e.,

$$\begin{aligned} v_k &= \mathbf{e}_k \cdot \mathbf{v} = \mathbf{e}_k \cdot \{\mathbf{F} \cdot u_l \mathbf{e}_l\} \\ &= (\mathbf{e}_k \cdot \mathbf{F} \cdot \mathbf{e}_l) u_l \end{aligned} \quad (4.16)$$

The second line can be represented in the component form

$$v_k = F_{kl} u_l \quad (4.17)$$

or in the matrix form

$$\begin{bmatrix} v_1 \\ v_2 \\ v_3 \end{bmatrix} = \begin{bmatrix} F_{11} & F_{12} & F_{13} \\ F_{21} & F_{22} & F_{23} \\ F_{31} & F_{32} & F_{33} \end{bmatrix} \begin{bmatrix} u_1 \\ u_2 \\ u_3 \end{bmatrix} \quad (4.18)$$

where the

$$F_{kl} = \mathbf{e}_k \cdot \mathbf{F} \cdot \mathbf{e}_l \quad (4.19)$$

are the cartesian components of the tensor  $\mathbf{F}$  (with respect to the base vectors  $\mathbf{e}_l$ ).

### 4.4 Additional Reading

Chadwick, Chapter 1, Section 1; Malvern, Sections 2.1, 2.2, 2.3; Aris, 2. - 2.3. Reddy, 2.2.4 - 5.



# Chapter 5

## Dyads

The definition of a tensor suggests that it can be represented in coordinate-free notation as

$$\mathbf{v} = \mathbf{F} \cdot \mathbf{u} \quad (5.1)$$

The relation (5.1) leads naturally to the representation of tensors as dyads:

$$\mathbf{F} = F_{kl} \mathbf{e}_k \mathbf{e}_l \quad (5.2)$$

Then, the operation (5.1) is given by the rules that have already been established for vectors

$$\mathbf{v} = (F_{kl} \mathbf{e}_k \mathbf{e}_l) \cdot (u_m \mathbf{e}_m) \quad (5.3a)$$

$$= F_{kl} \mathbf{e}_k (\mathbf{e}_l \cdot \mathbf{e}_m) u_m \quad (5.3b)$$

$$= F_{kl} \mathbf{e}_k \delta_{lm} u_m \quad (5.3c)$$

$$= \mathbf{e}_k F_{kl} u_l = \mathbf{e}_k v_k \quad (5.3d)$$

and

$$F_{ij} = \mathbf{e}_i \cdot \mathbf{F} \cdot \mathbf{e}_j \quad (5.4)$$

A *dyad* is two vectors placed next to each other, e.g.  $\mathbf{ab}$ ,  $\mathbf{e}_1 \mathbf{e}_2$ ,  $\mathbf{ij}$ . Dyads are sometimes denoted  $\mathbf{a} \otimes \mathbf{b}$ . The meaning of a dyad is defined operationally by its action on a vector:

$$(\mathbf{ab}) \cdot \mathbf{v} = \mathbf{a}(\mathbf{b} \cdot \mathbf{v}) \quad (5.5)$$

Note that (5.5) implies that multiplication by a dyad is not commutative, e.g.

$$\mathbf{v} \cdot (\mathbf{ab}) = \mathbf{b}(\mathbf{v} \cdot \mathbf{a}) \quad (5.6)$$

The conjugate of a dyad is defined by reversing the order of the vectors that make up the dyad. Thus, the conjugate of a dyad  $\phi = \mathbf{ab}$  is  $\phi_c = \mathbf{ba}$ .

A *dyadic* is a polynomial of dyads, e.g.

$$\phi = \mathbf{a}_1 \mathbf{b}_1 + \mathbf{a}_2 \mathbf{b}_2 + \mathbf{a}_3 \mathbf{b}_3 \quad (5.7a)$$

$$\mathbf{F} = F_{ij} \mathbf{e}_i \mathbf{e}_j \quad (5.7b)$$

The conjugate of a dyadic reverses each pair of vectors.

$$\phi_c = \mathbf{b}_1\mathbf{a}_1 + \mathbf{b}_2\mathbf{a}_2 + \mathbf{b}_3\mathbf{a}_3 \quad (5.8)$$

$$\mathbf{F}_c = F_{ij}\mathbf{e}_j\mathbf{e}_i = F_{qp}\mathbf{e}_p\mathbf{e}_q = \mathbf{F}^T \quad (5.9)$$

Note that  $(\mathbf{F}_c)_{ij} = F_{ji}$ . Hence, the conjugate corresponds to the usual notion of the transpose. Consequently, we will use “transpose” for the conjugate and denote it by  $\mathbf{F}^T$ . Multiplication of a dyadic by a vector is given by

$$\mathbf{v} \cdot \phi = (\mathbf{v} \cdot \mathbf{a}_1)\mathbf{b}_1 + (\mathbf{v} \cdot \mathbf{a}_2)\mathbf{b}_2 + (\mathbf{v} \cdot \mathbf{a}_3)\mathbf{b}_3 \quad (5.10)$$

Multiplication is distributive

$$(\mathbf{a} + \mathbf{b})(\mathbf{c} + \mathbf{d}) = \mathbf{ac} + \mathbf{bc} + \mathbf{ad} + \mathbf{bd} \quad (5.11a)$$

$$\phi = \mathbf{ab} = (a_k\mathbf{e}_k)(b_l\mathbf{e}_l) = a_k b_l \mathbf{e}_k \mathbf{e}_l \quad (5.11b)$$

A dyadic is symmetric if

$$\mathbf{T} = \mathbf{T}_c = \mathbf{T}^T \Rightarrow T_{ij} = T_{ji} \quad (5.12)$$

A dyadic is anti-symmetric if

$$\mathbf{F} = -\mathbf{F}_c = -\mathbf{F}^T \quad (5.13)$$

Hence, the components of an anti-symmetric dyadic satisfy

$$F_{11} = F_{22} = F_{33} = 0, F_{12} = -F_{21}, \text{ etc.} \quad (5.14)$$

or

$$F_{ij} = -F_{ji} \quad (5.15)$$

Any 2nd order tensor can be written as the sum of a symmetric and anti-symmetric part

$$\mathbf{F} = \frac{1}{2}(\mathbf{F} + \mathbf{F}^T) + \frac{1}{2}(\mathbf{F} - \mathbf{F}^T) \quad (5.16)$$

where the first term is symmetric and the second is anti-symmetric.

## 5.1 Tensor and Scalar Products

The tensor product of two tensors  $\mathbf{T}$  and  $\mathbf{U}$  is itself a tensor. The components of the product tensor are defined naturally in terms of operations between the base vectors.

$$\mathbf{T} \cdot \mathbf{U} = (T_{ij}\mathbf{e}_i\mathbf{e}_j) \cdot (U_{kl}\mathbf{e}_k\mathbf{e}_l) \quad (5.17)$$

$$= T_{ij}U_{kl}\mathbf{e}_i(\mathbf{e}_j \cdot \mathbf{e}_k)\mathbf{e}_l \quad (5.18)$$

$$= T_{ik}U_{jl}\mathbf{e}_i\mathbf{e}_l \quad (5.19)$$



The components of the product tensor can be computed in the usual way by matrix multiplication of the components of  $\mathbf{T}$  and  $\mathbf{U}$ .

$$T_{ik}U_{kl} = \begin{bmatrix} T_{11} & T_{12} & T_{13} \\ T_{21} & T_{22} & T_{23} \\ T_{31} & T_{32} & T_{33} \end{bmatrix} \begin{bmatrix} U_{11} & U_{12} & U_{13} \\ U_{21} & U_{22} & U_{23} \\ U_{31} & U_{32} & U_{33} \end{bmatrix} \quad (5.20)$$

Note that, as with matrix multiplication, the tensor product is not commutative. In fact, the rule that the transpose of a matrix product is the product of the transposes of the individual matrices is easily verified by the rules for computing with the components of the dyad.

$$\mathbf{T} \cdot \mathbf{U} = \{\mathbf{U}^T \cdot \mathbf{T}^T\}^T \quad (5.21)$$

There are two scalar products depending on the order in which the dot products between the base vectors are taken.

$$\mathbf{T} \cdot \cdot \mathbf{U} = (T_{ij}\mathbf{e}_i\mathbf{e}_j) \cdot \cdot (U_{kl}\mathbf{e}_k\mathbf{e}_l) \quad (5.22)$$

$$= T_{ij}U_{ke}(\mathbf{e}_i \cdot \mathbf{e}_l)(\mathbf{e}_j \cdot \mathbf{e}_k) \quad (5.23)$$

$$= T_{lk}U_{kl} \quad (5.24)$$

$$\mathbf{T} : \mathbf{U} = (T_{ij}\mathbf{e}_i\mathbf{e}_j) : (U_{kl}\mathbf{e}_k\mathbf{e}_l) \quad (5.25)$$

$$= T_{ij}U_{kl}(\mathbf{e}_i \cdot \mathbf{e}_k)(\mathbf{e}_j \cdot \mathbf{e}_l) \quad (5.26)$$

$$= T_{ij}U_{kl}\delta_{ik}\delta_{jl} = T_{kl}U_{kl} \quad (5.27)$$

The horizontal arrangements of the dots indicates that the dot product is taken between the two closest base vectors (the two inside) and then the two furthest (the two outside). The vertical dots indicate that the first base vectors of each dyad are dotted and the second base vectors are dotted. Actually, only one of these scalar products is needed since the other can be defined using the transpose.

## 5.2 Identity tensor

The identity tensor was defined as that tensor whose product with a vector or tensor gives the identical vector or tensor.

$$\mathbf{I} \cdot \mathbf{v} = \mathbf{v} \quad (5.28)$$

$$\mathbf{T} \cdot \mathbf{I} = \mathbf{T} \quad (5.29)$$

This implies that  $\mathbf{I}$  has the following dyadic representation in terms of orthonormal base vectors.

$$\mathbf{I} = \delta_{mn}\mathbf{e}_m\mathbf{e}_n = \mathbf{e}_1\mathbf{e}_1 + \mathbf{e}_2\mathbf{e}_2 + \mathbf{e}_3\mathbf{e}_3 \quad (5.30)$$

The trace of a tensor  $\mathbf{T}$  is obtained by forming the scalar product of  $\mathbf{T}$  with the identity tensor.

$$\text{tr}\mathbf{T} = \mathbf{T} : \mathbf{I} = \mathbf{T} \cdot \cdot \mathbf{I} \quad (5.31)$$

The cartesian component forms of  $\mathbf{T}$  and  $\mathbf{I}$  can be used to show that the trace is equal to the sum of the three diagonal components.

$$\text{tr}\mathbf{T} = (T_{ij}\mathbf{e}_i\mathbf{e}_j) : (\delta_{mn}\mathbf{e}_m\mathbf{e}_n) \quad (5.32)$$

$$= T_{ij}\delta_{mn}(\mathbf{e}_i \cdot \mathbf{e}_m)(\mathbf{e}_j \cdot \mathbf{e}_n) = \quad (5.33)$$

$$= T_{ij}\delta_{mn}\delta_{im}\delta_{jn} = T_{ij}\delta_{in}\delta_{jn} = T_{nn} \quad (5.34)$$

The trace is a scalar invariant, i.e. the numerical value is independent of the coordinate system used to write down the components.

### 5.3 Additional Reading

Malvern, Chapter 2, Parts 2 and 3, pp. 30-40; Chadwick, Chapter 1, Sections 2 and 3, pp. 16-24. Aris 2.41 - 2.44, 2.81. Reddy, 2.5.1 - 2.

## Chapter 6

# Vector (Cross) Product

We have already discussed the coordinate free form of the vector or cross product of two vectors. Here we will introduce the component form of this product.

For two vectors  $\mathbf{u}$  and  $\mathbf{v}$ , there are 9 ( $3^2$ ) possible products of their components. The scalar product is the sum of three. The remaining 6 can be combined in pairs to form a vector.

$$\mathbf{u} \times \mathbf{v} = (u_i \mathbf{e}_i) \times (v_j \mathbf{e}_j) = u_i v_j (\mathbf{e}_i \times \mathbf{e}_j) \quad (6.1)$$

To interpret (6.1), first, consider the cross-products of the base vectors. The vector

$$\mathbf{e}_3 = \mathbf{e}_1 \times \mathbf{e}_2 \quad (6.2)$$

is perpendicular to the plane containing  $\mathbf{e}_1$  and  $\mathbf{e}_2$  with the sense is given by the right hand rule. Consequently, reversing the order of the two vectors in the product must change the sign.

$$\mathbf{e}_1 \times \mathbf{e}_2 = -\mathbf{e}_2 \times \mathbf{e}_1 \quad (6.3)$$

Similarly,

$$\mathbf{e}_3 \times \mathbf{e}_1 = -\mathbf{e}_1 \times \mathbf{e}_3 = \mathbf{e}_2 \quad (6.4a)$$

$$\mathbf{e}_2 \times \mathbf{e}_3 = -\mathbf{e}_3 \times \mathbf{e}_2 = \mathbf{e}_1 \quad (6.4b)$$

and,

$$\mathbf{e}_1 \times \mathbf{e}_1 = 0 \quad (6.5a)$$

$$\mathbf{e}_2 \times \mathbf{e}_2 = 0 \quad (6.5b)$$

$$\mathbf{e}_3 \times \mathbf{e}_3 = 0 \quad (6.5c)$$

These equations can all be expressed as

$$\mathbf{e}_i \times \mathbf{e}_j = \epsilon_{ijk} \mathbf{e}_k \quad (6.6)$$

where the *permutation symbol* is defined such that

$$\epsilon_{ijk} = \begin{cases} 0 & \text{if any two indicies are equal} \\ +1 & \text{if } (ijk) \text{ is an even permutation of } (123) \text{ i.e. } 123, 312, 231 \\ -1 & \text{if } (ijk) \text{ is an odd permutation of } (123) \text{ i.e. } 213, 321, 132 \end{cases} \quad (6.7)$$

Dotting both sides of (6.6) with  $\mathbf{e}_m$  (and adjusting the indicies) yields

$$\epsilon_{ijk} = \mathbf{e}_i \cdot (\mathbf{e}_j \times \mathbf{e}_k) \quad (6.8)$$

The parenthesis on the right hand side can be dropped because taking the dot product first would make no sense: The cross product is an operation between two vectors and the result of the dot product is a scalar.

The following  $\epsilon \delta$  identity is often useful

$$\epsilon_{ijk}\epsilon_{imn} = \delta_{jm}\delta_{kn} - \delta_{jn}\delta_{km} \quad (6.9)$$

Malvern , p. 25, Problem #18 outlines a proof. The proof begins by noting that each of the four free indicies  $j, k, m, n$  can take on only three values: 1, 2, or 3. As a result it is possible to enumerate the various outcomes of (6.9). Contracting two of the indicies gives

$$\epsilon_{pqi}\epsilon_{pqj} = 2\delta_{ij} \quad (6.10)$$

and all three gives

$$\epsilon_{pqr}\epsilon_{pqr} = 6 \quad (6.11)$$

Now return to the cross product of two vectors. The relation (6.6) can be used to determine the component form of two vectors.

$$\mathbf{w} = \mathbf{u} \times \mathbf{v} \quad (6.12a)$$

$$= (u_i \mathbf{e}_i) \times (v_j \mathbf{e}_j) \quad (6.12b)$$

$$= u_i v_j (\mathbf{e}_i \times \mathbf{e}_j) \quad (6.12c)$$

$$= u_i v_j \epsilon_{ijk} \mathbf{e}_k \quad (6.12d)$$

and can be expressed as the following determinant.

$$\mathbf{w} = \begin{vmatrix} \mathbf{e}_1 & \mathbf{e}_2 & \mathbf{e}_3 \\ u_1 & u_2 & u_3 \\ v_1 & v_2 & v_3 \end{vmatrix} \quad (6.13)$$

The individual components of  $\mathbf{w}$  are

$$w_k = \mathbf{e}_k \cdot \mathbf{w} = u_i v_j \epsilon_{ijk} \quad (6.14)$$

## 6.1 Properties of the Cross-Product

To gain some practice in manipulating index notation, we can use it to confirm previously introduced properties of the cross-product.

First show that reversing the order of the vectors introduces a minus sign:

$$\mathbf{u} \times \mathbf{v} = -\mathbf{v} \times \mathbf{u} \quad (6.15)$$

To begin, express the cross product in index notation:

$$\mathbf{u} \times \mathbf{v} = \epsilon_{ijk} u_i v_j \mathbf{e}_k \quad (6.16)$$

$$= -\epsilon_{jik} u_i v_j \mathbf{e}_k \quad (6.17)$$

$$= -\epsilon_{lmk} v_l u_m \mathbf{e}_k = -\mathbf{v} \times \mathbf{u} \quad (6.18)$$

The second line introduces a minus sign because the order of the indices  $i$  and  $j$  in  $\epsilon_{ijk}$  are reversed. In the third line, the indices are simply relabelled (This can be done because they are all dummy or summation indices) and this is recognized as the component form of  $\mathbf{v} \times \mathbf{u}$ .

Now show that the cross-product is orthogonal to each of the vectors in the product:

$$\mathbf{u} \cdot \mathbf{w} = \mathbf{w} \cdot \mathbf{u} = 0 \quad (6.19)$$

$$\text{where } \mathbf{w} = \mathbf{u} \times \mathbf{v} \quad (6.20)$$

Substituting the expression for  $\mathbf{w}$  in (6.19) and expressing in component form gives.

$$\mathbf{u} \cdot (\mathbf{u} \times \mathbf{v}) = (u_i \mathbf{e}_i) \cdot (\epsilon_{klm} u_k v_l \mathbf{e}_m) \quad (6.21)$$

$$= u_i u_k v_l (\mathbf{e}_i \cdot \mathbf{e}_m) \epsilon_{klm} \quad (6.22)$$

$$= u_i u_k v_l \epsilon_{kli} \quad (6.23)$$

$$= v_l \epsilon_{lik} u_i u_k = -v_l \epsilon_{lki} u_i u_k \quad (6.24)$$

$$= -v_l \epsilon_{lik} u_i u_k = 0 \quad (6.25)$$

Because the scalar product pertains to vectors, the expression can be regrouped as in second line and carrying out the scalar product results in the third line. Interchanging two indices on  $\epsilon_{lik}$  introduces a minus sign and relabelling the indices shows that the expression is equal to its negative and, hence, must be zero.

The last result is an example of a more one: Any expression of the form  $A_{ij} B_{ij}$  is equal to zero if  $A_{ij}$  is symmetric with respect to interchange of the indices, i.e.,  $A_{ji} = A_{ij}$ , and  $B_{ij}$  is anti-symmetric with respect to interchange of the indices, i.e.,  $B_{ji} = -B_{ij}$ .

## 6.2 Uses of the Cross Product

Two uses of the cross product in mechanics are to represent the velocity due to rigid body rotation and the moment of a force about a point.

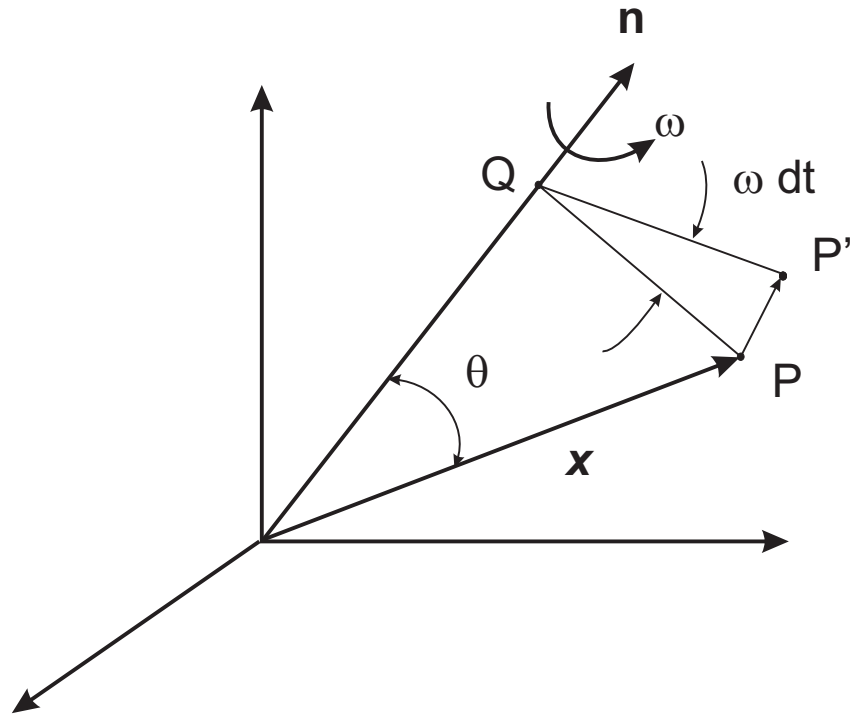

Figure 6.1: Velocity due to rigid body rotation.

### 6.2.1 Velocity Due to Rigid Body Rotation

In a rigid body the distance between any two points is fixed. Consider rotation of a rigid body with angular velocity  $\omega$  about an axis  $\mathbf{n}$ , as shown in Figure 6.1. The angular velocity vector is

$$\boldsymbol{\omega} = \omega \mathbf{n} \quad (6.26)$$

A point  $P$ , in the rigid body, is located by the position vector  $\mathbf{x}$ . The vector  $\mathbf{n} \times \mathbf{x}$  is in direction  $PP'$  and has magnitude  $|\mathbf{x}| \sin \theta$ . But  $|\mathbf{x}| \sin \theta = PQ$  is the perpendicular distance from  $P$  to the axis of rotation. Therefore, in time  $dt$ , the displacement is

$$d\mathbf{u} = \omega \mathbf{n} \times \mathbf{x} dt \quad (6.27)$$

In the limit  $dt \rightarrow 0$ , the velocity is

$$\mathbf{v} = \boldsymbol{\omega} \times \mathbf{x} \quad (6.28)$$

### 6.2.2 Moment of a Force $\mathbf{P}$ about $O$

The moment of a force  $\mathbf{P}$  about point  $O$  is

$$\mathbf{M}_o = \mathbf{x}_o \times \mathbf{P} \quad (6.29)$$

where  $\mathbf{x}_o$  is the vector from  $O$  to the point of application of  $\mathbf{P}$ . For  $k$  particles in equilibrium, the sum of the forces must vanish

$$\sum_k \mathbf{P}^{(k)} = 0 \quad (6.30)$$

and the sum of the moments must vanish

$$\sum_k \mathbf{x}_o^{(k)} \times \mathbf{P}^{(k)} = 0 \quad (6.31)$$

A well know result from statics is that if the sum of the moments about one point vanishes for a system of particles in equilibrium, then the sum of the moments vanishes for any point. Consider another point  $R$  where  $\mathbf{x}_R$  is the vector from the origin to  $R$ . Since (6.31) is satisfied

$$\sum_k \left\{ \left( \mathbf{x}_o^{(k)} - \mathbf{x}_R \right) \times \mathbf{P}^{(k)} + \mathbf{x}_R \times \mathbf{P}^{(k)} \right\} = 0 \quad (6.32)$$

$$\sum_k \left( \mathbf{x}_o^{(k)} - \mathbf{x}_R \right) \times \mathbf{P}^{(k)} + \mathbf{x}_R \times \sum_k \mathbf{P}^{(k)} = 0 \quad (6.33)$$

But the last term vanishes because of (6.29) and hence the sum of the moments about  $R$  must vanish.

### 6.3 Triple scalar product

We have already noted that the *triple scalar product*  $\mathbf{u} \times \mathbf{v} \cdot \mathbf{w}$  gives the volume of the parallelepiped with  $\mathbf{u}$ ,  $\mathbf{v}$  and  $\mathbf{w}$  as (or the negative depending on the ordering of the vectors). The component form is given by

$$\mathbf{u} \times \mathbf{v} \cdot \mathbf{w} = \epsilon_{ijk} u_i v_j w_k \quad (6.34)$$

and the result can be represented by the determinant

$$\mathbf{u} \times \mathbf{v} \cdot \mathbf{w} = \begin{vmatrix} u_1 & u_2 & u_3 \\ v_1 & v_2 & v_3 \\ w_1 & w_2 & w_3 \end{vmatrix} \quad (6.35)$$

Because the triple scalar product vanishes if the vectors  $\mathbf{u}$ ,  $\mathbf{v}$ , and  $\mathbf{w}$  are coplanar, the condition is also expressed by the vanishing of this determinant. Replacing  $\mathbf{u}$  by  $\mathbf{e}_i = \delta_{ip} \mathbf{e}_p$  and similarly for  $\mathbf{v}$ , and  $\mathbf{w}$  gives the triple scalar product

of three orthonormal unit vectors

$$\mathbf{e}_i \cdot (\mathbf{e}_j \times \mathbf{e}_k) = \epsilon_{ijk} = \begin{vmatrix} \delta_{i1} & \delta_{i2} & \delta_{i3} \\ \delta_{j1} & \delta_{j2} & \delta_{j3} \\ \delta_{k1} & \delta_{k2} & \delta_{k3} \end{vmatrix} \quad (6.36)$$

The determinant is skew-symmetric with respect to interchange of  $(i, j, k)$  because interchange of rows implies multiplication by  $(-1)$ . When  $(i, j, k) = (123)$ , the determinant = 1.

## 6.4 Triple Vector Product

The triple vector product is given by

$$\mathbf{u} \times (\mathbf{v} \times \mathbf{w}) \quad (6.37)$$

Because the cross product  $\mathbf{v} \times \mathbf{w}$  is normal to the plane of  $\mathbf{v}$  and  $\mathbf{w}$  and  $\mathbf{u} \times (\mathbf{v} \times \mathbf{w})$  is normal to  $\mathbf{u}$  and to  $(\mathbf{v} \times \mathbf{w})$ , the triple vector product must be in the plane of  $\mathbf{v}$  and  $\mathbf{w}$

$$\mathbf{u} \times (\mathbf{v} \times \mathbf{w}) = \alpha \mathbf{v} + \beta \mathbf{w} \quad (6.38)$$

Expressing (6.38) in component form yields

$$\epsilon_{ijk} u_j \epsilon_{klm} v_l w_m = \alpha v_i + \beta w_i \quad (6.39)$$

Using (6.9) gives

$$\epsilon_{ijk} \epsilon_{lmk} u_j v_l w_m = (\delta_{il} \delta_{jm} - \delta_{im} \delta_{jl}) u_j v_l w_m \quad (6.40)$$

$$= v_i u_j w_j - w_i u_j v_j \quad (6.41)$$

Now, converting back to coordinate free form

$$\mathbf{u} \times (\mathbf{v} \times \mathbf{w}) = \mathbf{v} (\mathbf{u} \cdot \mathbf{w}) - \mathbf{w} (\mathbf{u} \cdot \mathbf{v}) \quad (6.42)$$

Using this result and cycling the order of the vectors shows that

$$\mathbf{u} \times (\mathbf{v} \times \mathbf{w}) + \mathbf{v} \times (\mathbf{w} \times \mathbf{u}) + \mathbf{w} \times (\mathbf{u} \times \mathbf{v}) = 0 \quad (6.43)$$

## 6.5 Additional Reading

Chadwick, Chapter 1, Section 1; Malvern, Sec. 2.3; Aris 2.32-2.35.



# Chapter 7

## Determinants

Recall that the component form of the scalar triple product can be represented with the permutation symbol  $\epsilon_{ijk}$  or as a determinant

$$(\mathbf{u} \times \mathbf{v}) \cdot \mathbf{w} = \mathbf{w} \cdot (\mathbf{u} \times \mathbf{v}) = \mathbf{u} \cdot (\mathbf{v} \times \mathbf{w}) \quad (7.1a)$$

$$= \epsilon_{ijk} u_i v_j w_k = \begin{vmatrix} u_1 & u_2 & u_3 \\ v_1 & v_2 & v_3 \\ w_1 & w_2 & w_3 \end{vmatrix} \quad (7.1b)$$

This correspondence suggests that  $\epsilon_{ijk}$  can be useful in representing determinants more generally. For example, if the components of the vectors  $\mathbf{u}$ ,  $\mathbf{v}$ , and  $\mathbf{w}$  are replaced by  $a_{1i}$ ,  $a_{2i}$ , and  $a_{3i}$ , then (7.1b) becomes an expression for the determinant of the matrix  $A$  with components  $a_{ij}$ .

$$\det(A) = \epsilon_{ijk} a_{1i} a_{2j} a_{3k} = \begin{vmatrix} a_{11} & a_{12} & a_{13} \\ a_{21} & a_{22} & a_{23} \\ a_{31} & a_{32} & a_{33} \end{vmatrix} \quad (7.2)$$

Writing out the summation gives

$$\det(A) = a_{11}(\epsilon_{123} a_{22} a_{33} + \epsilon_{132} a_{23} a_{32}) + \quad (7.3a)$$

$$a_{12}(\epsilon_{213} a_{21} a_{33} + \epsilon_{231} a_{23} a_{31}) +$$

$$a_{13}(\epsilon_{312} a_{21} a_{32} + \epsilon_{321} a_{22} a_{31})$$

$$= a_{11}(a_{22} a_{33} - a_{23} a_{32}) \quad (7.3b)$$

$$- a_{12}(a_{21} a_{33} - a_{23} a_{31})$$

$$+ a_{13}(a_{21} a_{32} - a_{22} a_{31})$$

$$= a_{11} \begin{vmatrix} a_{22} & a_{23} \\ a_{32} & a_{33} \end{vmatrix} - a_{12} \begin{vmatrix} a_{21} & a_{23} \\ a_{31} & a_{33} \end{vmatrix} + \quad (7.3c)$$

$$a_{13} \begin{vmatrix} a_{21} & a_{22} \\ a_{31} & a_{32} \end{vmatrix}$$

where the second equality follows from noting that  $\epsilon_{123} = \epsilon_{231} = \epsilon_{312} = 1$  and  $\epsilon_{132} = \epsilon_{213} = \epsilon_{321} = -1$ . The final equality results from arranging the coefficients of  $a_{11}$ ,  $a_{12}$ , and  $a_{13}$  as  $2 \times 2$  determinants. Thus, the summation represents an expansion of the determinant by the first row. The signed coefficients of  $a_{11}$ ,  $a_{12}$ , and  $a_{13}$  are called the *cofactors* of these terms. Note that each term has one and only one element from each row and column. Also, interchanging two rows changes the sign of the determinant:

$$\epsilon_{ijk}a_{1i}a_{2j}a_{3k} = \epsilon_{ijk}a_{2j}a_{1i}a_{3k} \quad (7.4a)$$

$$= -\epsilon_{jik}a_{2j}a_{1i}a_{3k} \quad (7.4b)$$

$$= -\epsilon_{mnp}a_{2m}a_{1n}a_{3p} \quad (7.4c)$$

Alternatively, we could expand about the first column:

$$|A| = \epsilon_{ijk}a_{i1}a_{j2}a_{k3} \quad (7.5)$$

$$= a_{11}(\epsilon_{123}a_{22}a_{33} + \epsilon_{132}a_{32}a_{23}) \quad (7.6)$$

$$+ a_{21}(\epsilon_{213}a_{12}a_{33} + \epsilon_{231}a_{32}a_{13})$$

$$+ a_{31}(\epsilon_{312}a_{12}a_{23} + \epsilon_{321}a_{22}a_{13})$$

$$= a_{11} \begin{vmatrix} a_{22} & a_{23} \\ a_{32} & a_{33} \end{vmatrix} - a_{21} \begin{vmatrix} a_{12} & a_{13} \\ a_{32} & a_{33} \end{vmatrix} + a_{31} \begin{vmatrix} a_{12} & a_{13} \\ a_{22} & a_{23} \end{vmatrix} \quad (7.7)$$

Consequently, the determinant of a matrix and its transpose are identical:

$$|A| = |A^T| \quad (7.8)$$

The determinant can also be written as

$$|A| = a_{1i}A_{1i} \quad (7.9)$$

where

$$A_{1i} = \epsilon_{ijk}a_{2j}a_{3k} \quad (7.10)$$

is the *cofactor* of  $a_{1i}$ . More generally, we could expand about any row or column

$$|A| = a_{iq}A_{iq} = a_{pj}A_{pj}, \text{ (no sum on } i \text{ and } j) \quad (7.11)$$

(Because we have adopted the convention that a repeated index implies summation, we must explicitly indicate here that  $i$  and  $j$  are not to be summed).

By comparison

$$\frac{1}{3}|A| = a_{iq}A_{iq} = a_{pj}A_{pj} \quad (7.12)$$

In order to develop another expression for the determinant, consider the quantity

$$h_{lmn} = \epsilon_{ijk}a_{li}a_{mj}a_{nk} \quad (7.13)$$

First note that when  $(l, m, n) = (1, 2, 3)$

$$\epsilon_{ijk}a_{1i}a_{2j}a_{3k} = \det A \quad (7.14)$$

Now, show that  $h_{lmn}$  is skew-symmetric with respect to interchange of  $(l, m, n)$

$$h_{lmn} = \epsilon_{ijk} a_{li} a_{mj} a_{nk} \quad (7.15a)$$

$$= \epsilon_{ijk} a_{mj} a_{li} a_{nk} \quad (7.15b)$$

$$= -\epsilon_{jik} a_{mj} a_{li} a_{nk} \quad (7.15c)$$

$$= -\epsilon_{ijk} a_{mi} a_{lj} a_{nk} = -h_{mln} \quad (7.15d)$$

From these two results, we can conclude that

$$\epsilon_{ijk} a_{li} a_{mj} a_{nk} = \epsilon_{lmn} \det(A) \quad (7.16)$$

We can also derive another expression for the co-factor

$$\det(A) = \epsilon_{ijk} a_{1i} a_{2j} a_{3k} \quad (7.17a)$$

$$= a_{1i} \{ \epsilon_{ijk} a_{2j} a_{3k} \} \quad (7.17b)$$

Thus, the cofactor of  $a_{1i}$  is

$$A_{1i} = \epsilon_{ijk} a_{2j} a_{3k} \quad (7.18)$$

To rewrite this in a more general way for arbitrary indicies first multiply by  $\epsilon_{123} = 1$

$$A_{1i} = \epsilon_{123} \epsilon_{ijk} a_{2j} a_{3k} \quad (7.19a)$$

$$= \frac{1}{2} \epsilon_{123} \epsilon_{ijk} a_{2j} a_{3k} + \frac{1}{2} \epsilon_{123} \epsilon_{ijk} a_{2j} a_{3k} \quad (7.19b)$$

$$= \frac{1}{2} \epsilon_{123} \epsilon_{ijk} a_{2j} a_{3k} + \frac{1}{2} (-\epsilon_{132}) (-\epsilon_{ikj}) a_{2j} a_{3k} \quad (7.19c)$$

$$= \frac{1}{2} \epsilon_{123} \epsilon_{ijk} a_{2j} a_{3k} + \frac{1}{2} \epsilon_{132} \epsilon_{ijk} a_{3j} a_{2k} \quad (7.19d)$$

$$= \frac{1}{2} \epsilon_{ijk} \epsilon_{1mn} a_{mj} a_{nk} \quad (7.19e)$$

Because this expression applies for any value of the first index we can write

$$A_{li} = \frac{1}{2} \epsilon_{lmn} \epsilon_{ijk} a_{mj} a_{nk} \quad (7.20)$$

The transpose of this matrix is the *adjugate* of  $A$

$$(\text{Adj } A)_{il} = A_{li} = \frac{1}{2} \epsilon_{lmn} \epsilon_{ijk} a_{mj} a_{nk} \quad (7.21)$$

## 7.1 Inverse

We can use the adjugate to obtain an expression for the inverse of a matrix. Multiply the adjugate (7.21) by  $a_{pi}$

$$a_{pi} (\text{Adj } A)_{il} = \frac{1}{2} \epsilon_{lmn} (\epsilon_{ijk} a_{pi} a_{mj} a_{nk}) \quad (7.22)$$

The term in parentheses on the right hand side can be rewritten using (7.16) to give

$$a_{pi}(\text{Adj } A)_{il} = \frac{1}{2}\epsilon_{lmn}\epsilon_{pmn} \det(A) = \delta_{pl} \det(A) \quad (7.23)$$

Dividing both sides by  $\det(A)$  gives

$$a_{pi} \frac{(\text{Adj } A)_{il}}{\det(A)} = \delta_{pl} \quad (7.24)$$

If the right hand side is arranged as a matrix, it is the identity, i.e., the matrix with 1's on the diagonal and 0's elsewhere. Consequently, the term multiplying  $a_{pi}$  must be an expression for the inverse of this matrix. Therefore, the inverse is given by

$$(a^{-1})_{il} = \frac{(\text{Adj } A)_{il}}{\det(A)} \quad (7.25)$$

Note that if  $\det(A) = 0$ , the inverse will not exist. Recall that when the determinant is interpreted as the triple scalar product of three vectors, it vanishes if the three vectors are coplanar. In other words, the third vector can be expressed in terms of a linear combination of the other two or, equivalently, one row of the matrix is a linear combination of the remaining two.

## 7.2 Product of Two Determinants

The result (7.16) can be used to prove the familiar result on the product of two determinants.

$$\det(A) \det(B) = \det(C) \quad (7.26)$$

where  $c_{kl} = a_{kp}b_{pl}$ .

$$\det(A) \det(B) = \det(A)\epsilon_{mnp}b_{m1}b_{n2}b_{p3} \quad (7.27a)$$

$$= \epsilon_{ijk}(a_{im}b_{m1})(a_{jn}b_{n2})(a_{kp}b_{p3}) \quad (7.27b)$$

Thus the left-hand side is  $\det(C)$ . Because the triple scalar product of three vectors can be represented as a determinant (7.1b), the result on the product of two determinants implies

$$(\mathbf{a} \cdot \mathbf{b} \times \mathbf{c})(\mathbf{d} \cdot \mathbf{e} \times \mathbf{f}) = \begin{vmatrix} \mathbf{a} \cdot \mathbf{d} & \mathbf{a} \cdot \mathbf{e} & \mathbf{a} \cdot \mathbf{f} \\ \mathbf{b} \cdot \mathbf{d} & \mathbf{b} \cdot \mathbf{e} & \mathbf{b} \cdot \mathbf{f} \\ \mathbf{c} \cdot \mathbf{d} & \mathbf{c} \cdot \mathbf{e} & \mathbf{c} \cdot \mathbf{f} \end{vmatrix} \quad (7.28)$$

In (7.1a), let  $\mathbf{u} = \mathbf{e}_i = \mathbf{e}_1\delta_{i1} + \mathbf{e}_2\delta_{i2} + \mathbf{e}_3\delta_{i3}$ ,  $\mathbf{v} = \mathbf{e}_j = \mathbf{e}_1\delta_{j1} + \dots$ , etc. Thus,

$$\epsilon_{ijk} = \mathbf{e}_i \cdot (\mathbf{e}_j \times \mathbf{e}_k) = \begin{vmatrix} \delta_{i1} & \delta_{i2} & \delta_{i3} \\ \delta_{j1} & \delta_{j2} & \delta_{j3} \\ \delta_{k1} & \delta_{k2} & \delta_{k3} \end{vmatrix} \quad (7.29)$$

Using (7.29) and the result on the product of the determinants yields

$$\epsilon_{ijk}\epsilon_{mnp} = \begin{vmatrix} \delta_{i1} & \delta_{i2} & \delta_{i3} \\ \delta_{j1} & \delta_{j2} & \delta_{j3} \\ \delta_{k1} & \delta_{k2} & \delta_{k3} \end{vmatrix} \begin{vmatrix} \delta_{m1} & \delta_{m2} & \delta_{m3} \\ \delta_{n1} & \delta_{n2} & \delta_{n3} \\ \delta_{p1} & \delta_{p2} & \delta_{p3} \end{vmatrix} \quad (7.30a)$$

$$= \begin{vmatrix} \delta_{im} & \delta_{in} & \delta_{ip} \\ \delta_{jm} & \delta_{jn} & \delta_{jp} \\ \delta_{km} & \delta_{kn} & \delta_{kp} \end{vmatrix} \quad (7.30b)$$

Setting  $i = m$  gives the  $\epsilon \delta$  identity (6.9):

$$\epsilon_{ijk}\epsilon_{imn} = \delta_{jm}\delta_{kn} - \delta_{jn}\delta_{km}$$

### 7.3 Additional Reading

Malvern, pp. 40-44; Aris, Sec. A.8.



## Chapter 8

# Change of Orthonormal Basis

Consider the two coordinate systems shown in Figure 8.1: the 123 system with base vectors  $\mathbf{e}_1, \mathbf{e}_2, \mathbf{e}_3$  and the 1'2'3' system with base vectors  $\mathbf{e}'_1, \mathbf{e}'_2, \mathbf{e}'_3$ . In Chapter 3 we noted that an orthogonal tensor is one that rotates a vector without changing its magnitude. Thus we can use an orthogonal tensor to relate the base vectors in the two systems.

The base vectors in the primed and unprimed systems are related by

$$\mathbf{e}'_j = \mathbf{A} \cdot \mathbf{e}_j \quad (8.1)$$

where  $\mathbf{A}$  is an orthogonal tensor. Forming the dot product in (8.1) gives

$$\mathbf{e}_i \cdot \mathbf{e}'_j = \cos(i, j') = \mathbf{e}_i \cdot \mathbf{A} \cdot \mathbf{e}_j = A_{ij} \quad (8.2)$$

where  $\cos(i, j')$  is the cosine of the angle between the  $i$  axis and the  $j'$  axis. Thus, in the component  $A_{ij}$ , the second subscript ( $j$  in this case) is associated with the primed system. Either (8.1) or (8.2) leads to the dyadic representation

$$\mathbf{A} = \mathbf{e}'_k \mathbf{e}_k \quad (8.3)$$

Because both the new system and the old system of base vectors is orthonormal

$$\begin{aligned} \mathbf{e}'_i \cdot \mathbf{e}'_j &= \delta_{ij} = (\mathbf{A} \cdot \mathbf{e}_i) \cdot (\mathbf{A} \cdot \mathbf{e}_j) \\ &= (\mathbf{e}_i \cdot \mathbf{A}^T) \cdot (\mathbf{A} \cdot \mathbf{e}_j) \end{aligned}$$

the product

$$\mathbf{A}^T \cdot \mathbf{A} = \mathbf{I} \quad (8.4)$$

Thus, as also noted earlier, inverse of an orthogonal tensor is equal to its transpose. In index notation, (8.4) is expressed as

$$A_{ik} A_{jk} = A_{ki} A_{kj} = \delta_{ij} \quad (8.5)$$

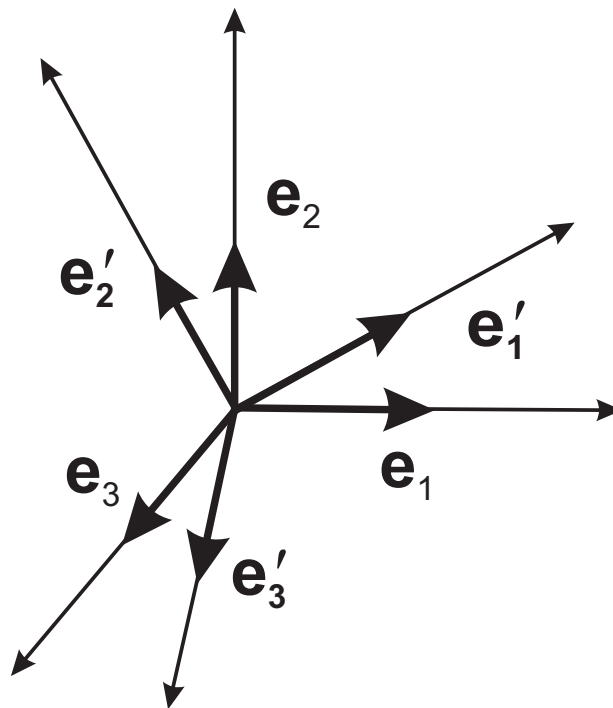

Figure 8.1: Rotation of the base vectors  $e_i$  to a new system  $e'_i$ .



(where the first expression results from noting that the product in (8.4) can be taken in either order).

Consequently, the unprimed base vectors can be given in terms of the primed by

$$\mathbf{e}_m = \mathbf{A}^T \cdot \mathbf{e}'_m \quad (8.6)$$

and

$$\mathbf{e}_m \cdot \mathbf{e}'_n = \cos(m, n') = \mathbf{e}'_n \cdot \mathbf{A}^T \cdot \mathbf{e}'_m = A_{nm}^T = A_{mn} \quad (8.7)$$

which agrees with (8.2). These properties reinforce the choice of the name *orthogonal* for this type of tensor: it rotates one system of orthogonal unit vectors into another system of orthogonal unit vectors.

## 8.1 Change of Vector Components

Now consider a vector  $\mathbf{v}$ . We can express the vector in terms of components in either system

$$\mathbf{v} = v_i \mathbf{e}_i = v'_j \mathbf{e}'_j \quad (8.8)$$

since  $\mathbf{v}$  represents the same physical entity. It is important to note that both the  $v_i$  and the  $v'_j$  represent the *same* vector; they simply furnish different descriptions. Given that the base vectors are related by (8.1) and (8.6), we wish to determine how the  $v_i$  and the  $v'_j$  are related. The component in the primed system is obtained by forming the scalar product of  $\mathbf{v}$  with the base vector in the primed system:

$$v'_k = \mathbf{e}'_k \cdot \mathbf{v} = \mathbf{e}'_k \cdot (v_i \mathbf{e}_i) \quad (8.9a)$$

$$= v_i \mathbf{e}'_k \cdot \mathbf{e}_i \quad (8.9b)$$

$$= v_i A_{ik} \quad (8.9c)$$

The three equations (8.9) can also be represented as a matrix equation

$$\begin{bmatrix} v'_1 \\ v'_2 \\ v'_3 \end{bmatrix} = \begin{bmatrix} v_1 & v_2 & v_3 \end{bmatrix} \begin{bmatrix} A_{11} & A_{12} & A_{13} \\ A_{21} & A_{22} & A_{23} \\ A_{31} & A_{32} & A_{33} \end{bmatrix} \quad (8.10)$$

or, alternatively, as

$$\begin{bmatrix} v'_1 \\ v'_2 \\ v'_3 \end{bmatrix} = \begin{bmatrix} A_{11} & A_{21} & A_{31} \\ A_{12} & A_{22} & A_{32} \\ A_{13} & A_{23} & A_{33} \end{bmatrix} \begin{bmatrix} v_1 \\ v_2 \\ v_3 \end{bmatrix} \quad (8.11)$$

Similarly, the components of  $\mathbf{v}$  in the unprimed system can be expressed in terms of the components in the primed system

$$v_i = \mathbf{e}_i \cdot \mathbf{v} = \mathbf{e}_i \cdot (v'_k \mathbf{e}'_k) \quad (8.12a)$$

$$= (\mathbf{e}_i \cdot \mathbf{e}'_k) v'_k \quad (8.12b)$$

$$= A_{ik} v'_k \quad (8.12c)$$

or in matrix form

$$[v] = A[v'] \tag{8.13}$$

Note that the tensor  $\mathbf{A}$  rotates the unprimed base vectors into the primed base vectors, according to (8.1), it is the components of  $\mathbf{A}^T$  that appear in the matrix equation (8.11) as implied by the index form (8.9c). To interpret this result in another way rewrite (8.9a) as

$$\begin{aligned} v'_k &= \mathbf{e}'_k \cdot \mathbf{v} \\ &= (\mathbf{A} \cdot \mathbf{e}_k) \cdot \mathbf{v} \\ &= (\mathbf{e}_k \cdot \mathbf{A}^T) \cdot \mathbf{v} \\ &= \mathbf{e}_k \cdot (\mathbf{A}^T \cdot \mathbf{v}) \end{aligned}$$

Thus the  $v'_k$  are the components of the vector  $\mathbf{A}^T \cdot \mathbf{v}$  on the *unprimed system*. This relation expresses the equivalence of rotating the coordinate system in one direction relative to a fixed vector and rotating a vector in the opposite direction relative to a fixed coordinate system.

## 8.2 Definition of a vector

Previously, we noted that vectors are directed line segments that add in a certain way. This property of addition reflects that nature of addition for the physical quantities that we represent as vectors, e.g. velocity and force. We now give another definition of a vector. This definition reflects the observation that the quantities represented by vectors are physical entities that cannot depend on the coordinate systems used to represent them. A (cartesian) vector  $\mathbf{v}$  in three dimensions is a quantity with three components  $v_1, v_2, v_3$  in the one rectangular cartesian system 0123, which, under rotation of the coordinates to another cartesian system 1'2'3' (Figure 8.1) become components  $v'_1, v'_2, v'_3$  with

$$v'_i = A_{ji}v_j \tag{8.14}$$

where

$$A_{ji} = \cos(i', j) = \mathbf{e}'_i \cdot \mathbf{e}_j \tag{8.15}$$

This definition can then used to deduce other properties of vectors. For example, we can show that the sum of two vectors is indeed a vector. If  $\mathbf{u}$  and  $\mathbf{v}$  are vectors then  $\mathbf{t} = \mathbf{u} + \mathbf{v}$  is a vector because it transforms like one:

$$t'_i = u'_i + v'_i = A_{ji}u_j + A_{ji}v_j \tag{8.16a}$$

$$= A_{ji}(u_j + v_j) = A_{ji}t_j \tag{8.16b}$$

## 8.3 Change of Tensor Components

Expressions for the components of  $\mathbf{F}$  with respect to a different set of base vectors, say  $\mathbf{e}'_k$ , also follow from the relations for vector components:

$$v_k = F_{kl}u_l \tag{8.17}$$

and

$$v'_k = A_{mk} F_{mn} u_n \quad (8.18a)$$

$$= A_{mk} F_{mn} A_{nl} u'_l \quad (8.18b)$$

$$= F'_{kl} u'_l \quad (8.18c)$$

Because this result applies for *all* vectors  $\mathbf{u}$  and  $\mathbf{v}$

$$F'_{kl} = A_{mk} F_{mn} A_{nl} \quad (8.19)$$

where, as before,

$$A_{mk} = \mathbf{e}_m \cdot \mathbf{e}'_k = \cos(m, k') \quad (8.20)$$

This can be written in matrix form as

$$\begin{bmatrix} F' \\ \end{bmatrix} = \begin{bmatrix} A_{11} & A_{21} & A_{31} \\ A_{12} & A_{22} & A_{32} \\ A_{13} & A_{23} & A_{33} \end{bmatrix} \begin{bmatrix} F_{11} & F_{12} & F_{13} \\ F_{21} & F_{22} & F_{23} \\ F_{31} & F_{32} & F_{33} \end{bmatrix} \begin{bmatrix} A_{11} & A_{12} & A_{13} \\ A_{21} & A_{22} & A_{23} \\ A_{31} & A_{32} & A_{33} \end{bmatrix} \quad (8.21)$$

or

$$[F'] = [A]^T [F] [A] \quad (8.22)$$

Similarly, the inversion is given by

$$F_{ij} = A_{il} A_{jk} F'_{lk} \quad (8.23)$$

or

$$[F] = [A] [F'] [A]^T \quad (8.24)$$

The relations between components of a tensor in different orthogonal coordinate systems can be used as a second definition of a tensor that is analogous to the definition of a vector: In any rectangular coordinate system, a tensor is defined by nine components that transform according to the rule (8.19) when the relation between unit base vectors is (8.20).

As noted in Chapter 3, a symmetric tensor is one for which  $\mathbf{T} = \mathbf{T}^T$ . Because this relation can be expressed in coordinate-free form, we expect that the components are symmetric in any coordinate system. We can show this directly for rectangular cartesian systems using the relation (8.19). If the components of a tensor  $\mathbf{T}$  are symmetric in one rectangular cartesian coordinate system, they are symmetric in any rectangular cartesian system:

$$\mathbf{T} = T_{ij} \mathbf{e}_i \mathbf{e}_j \text{ where } T_{ij} = T_{ji} \quad (8.25)$$

$$T'_{kl} = A_{ik} A_{jl} T_{ij} = A_{ik} A_{jl} T_{ji} \quad (8.26)$$

$$= A_{jl} A_{ik} T_{ji} = A_{il} A_{jk} T_{ij} = T'_{lk} \quad (8.27)$$

## 8.4 Additional Reading

Malvern, Sec. 2.4, Part 1, pp. 25-30; Chadwick, pp. 13 - 16; Aris 2.1.1, A.6. Reddy, 2.2.6.



## Chapter 9

# Principal Values and Principal Directions

As noted in Chapter 3 we discussed that a second order tensor operating on a vector, say,  $\mathbf{u}$ , produces another vector  $\mathbf{v}$ , i.e.

$$\mathbf{T} \cdot \mathbf{u} = \mathbf{v} \quad (9.1)$$

In general, the input vector  $\mathbf{u}$  is not in the same direction as  $\mathbf{v}$ . The output vector  $\mathbf{v}$  will be in the same direction as  $\mathbf{u}$  if  $\mathbf{v} = \lambda\mathbf{u}$ , where  $\lambda$  is a scalar. Substituting in (9.1) yields

$$\mathbf{T} \cdot \mathbf{u} = \lambda\mathbf{u} \quad (9.2)$$

We also noted that if the inverse of  $\mathbf{T} - \lambda\mathbf{I}$  exists then the only solution is  $\mathbf{u} = \mathbf{0}$ . Only special values of  $\lambda$  and  $\mathbf{u}$  will satisfy (9.1). These values have special significance for the tensor. A value of  $\lambda$  that satisfies (9.2) is an *eigenvalue* (*principal value, proper number*) of the tensor  $\mathbf{T}$  and the corresponding vector  $\mathbf{u}$  is an *eigenvector* (*principal direction*). It is clear that if a vector  $\mathbf{u}$  is a solution of (9.2), then so is  $\alpha\mathbf{u}$ , where  $\alpha$  is a scalar. Consequently, only the direction of  $\mathbf{u}$  is determined and, for this reason, it is convenient to make the eigenvectors unit vectors  $\boldsymbol{\mu} = \mathbf{u}/u$ .

In Chapter 3 we showed that for a symmetric second order tensor, the eigenvalues are real and the eigenvectors can be chosen to be orthogonal. If  $\lambda_K$  is an eigenvalue and  $\boldsymbol{\mu}_K$  the corresponding eigenvector, then

$$\mathbf{T} \cdot \boldsymbol{\mu}_K = \lambda_K \boldsymbol{\mu}_K, \text{ (no sum on } K) \quad (9.3)$$

Forming the dot product with  $\boldsymbol{\mu}_K$  yields

$$\boldsymbol{\mu}_K \cdot \mathbf{T} \cdot \boldsymbol{\mu}_K = \lambda_K, \text{ (no sum on } K) \quad (9.4)$$

and forming the dot product with  $\boldsymbol{\mu}_L \neq \boldsymbol{\mu}_K$  yields

$$\boldsymbol{\mu}_L \cdot \mathbf{T} \cdot \boldsymbol{\mu}_K = \lambda_K(\boldsymbol{\mu}_L \cdot \boldsymbol{\mu}_K) = 0, \text{ (no sum on } K) \quad (9.5)$$

Therefore  $\lambda_K$  is the component of  $\mathbf{T}$  in the coordinate direction  $\boldsymbol{\mu}_K$ . Because the eigenvectors are orthonormal, they can be used as unit base vectors and  $\mathbf{T}$  has the dyadic representation

$$\mathbf{T} = \lambda_I \boldsymbol{\mu}_I \boldsymbol{\mu}_I + \lambda_{II} \boldsymbol{\mu}_{II} \boldsymbol{\mu}_{II} + \lambda_{III} \boldsymbol{\mu}_{III} \boldsymbol{\mu}_{III} \quad (9.6)$$

Expressed differently, the matrix of components using a coordinate system aligned with the principal directions is diagonal

$$\mathbf{T} = \begin{bmatrix} \lambda_I & 0 & 0 \\ 0 & \lambda_{II} & 0 \\ 0 & 0 & \lambda_{III} \end{bmatrix} \quad (9.7)$$

The dyadic representation of the tensor that rotates the original basis system into one aligned with the principal directions is

$$\mathbf{A} = \boldsymbol{\mu}_K \mathbf{e}_k \quad (9.8)$$

where the  $k$ 's are still summed even though one is upper case and one is lower. Thus, the matrix form of  $A$  with respect to the  $\mathbf{e}_i$  base vectors has the components of the principal directions as columns:

$$\mathbf{A} = (\boldsymbol{\mu}_K)_i \mathbf{e}_i \mathbf{e}_k$$

where  $(\boldsymbol{\mu}_K)_i$  is the  $i$ th component of the  $K$ th eigenvector (relative to the  $\mathbf{e}_i$  basis). Consequently, the principal values are given by

$$\lambda_K = \boldsymbol{\mu}_K \cdot \mathbf{T} \cdot \boldsymbol{\mu}_K, \quad (\text{no sum on } K) \quad (9.9)$$

Substituting (9.8) into (9.9) gives

$$\begin{aligned} \lambda_K &= (\boldsymbol{\mu}_K)_i \mathbf{e}_i \cdot \mathbf{T} \cdot (\boldsymbol{\mu}_K)_j \mathbf{e}_j, \quad (\text{no sum on } K) \\ &= (\boldsymbol{\mu}_K)_i T_{ij} (\boldsymbol{\mu}_K)_j, \quad (\text{no sum on } K) \end{aligned}$$

where, again, the summation convention applies even though one subscript is upper case and one lower. In other words, using (9.8) as a coordinate transformation yields a diagonal form for the components of  $\mathbf{T}$ .

Writing (9.2) in component form yields

$$T_{ij} u_j = \lambda u_i \quad (9.10)$$

and rearranging yields

$$(T_{ij} - \lambda \delta_{ij}) u_j = 0 \quad (9.11)$$

Because (9.11) represents three linear equations for the three components of  $\mathbf{u}$  and the right-hand side is zero, there is a nontrivial solution to (9.11) if and only if

$$\det |T_{ij} - \lambda \delta_{ij}| = 0 \quad (9.12)$$

We also showed in Chapter 7 that the inverse will not exist if this the determinant vanishes (7.25). If this condition is met and there is a solution, then there are infinitely many solutions for the  $u_i$  corresponding to the indeterminate magnitude of the vector  $\mathbf{u}$ . This indeterminacy is eliminated by the convention of making the eigenvector a unit vector. Expanding (9.12) yields

$$\lambda^3 - I_1\lambda^2 - I_2\lambda - I_3 = 0 \quad (9.13)$$

where the coefficients are

$$I_1 = \text{tr}\mathbf{T} = T_{kk} = T_{11} + T_{22} + T_{33} \quad (9.14a)$$

$$I_2 = \frac{1}{2}(T_{ij}T_{ij} - T_{ii}T_{jj}) = \frac{1}{2}(\mathbf{T} : \mathbf{T} - I_1^2) \quad (9.14b)$$

$$I_3 = \det(\mathbf{T}) = \frac{1}{6}\epsilon_{ijk}\epsilon_{pqr}T_{ip}T_{jq}T_{kr} \quad (9.14c)$$

Because the principal values are independent of coordinate system, so are the coefficients in the characteristic equation used to determine them. These coefficients are scalar invariants of the tensor  $\mathbf{T}$  (generally called the *principal invariants*, since any combination of them is also invariant).

Using the principal axis representation of  $\mathbf{T}$  (9.6) to form the inner product of  $\mathbf{T}$  with itself gives

$$\mathbf{T} \cdot \mathbf{T} = (\lambda_I)^2 \boldsymbol{\mu}_I \boldsymbol{\mu}_I + (\lambda_{II})^2 \boldsymbol{\mu}_{II} \boldsymbol{\mu}_{II} + (\lambda_{III})^2 \boldsymbol{\mu}_{III} \boldsymbol{\mu}_{III} \quad (9.15)$$

and the triple product is

$$\mathbf{T} \cdot \mathbf{T} \cdot \mathbf{T} = (\lambda_I)^3 \boldsymbol{\mu}_I \boldsymbol{\mu}_I + (\lambda_{II})^3 \boldsymbol{\mu}_{II} \boldsymbol{\mu}_{II} + (\lambda_{III})^3 \boldsymbol{\mu}_{III} \boldsymbol{\mu}_{III} \quad (9.16)$$

Because each of the principal values satisfies (9.13) rearranging (9.16) for each of the principal values, this can be written as

$$\mathbf{T} \cdot \mathbf{T} \cdot \mathbf{T} = I_1 \mathbf{T} \cdot \mathbf{T} + I_2 \mathbf{T} + I_3 \mathbf{I} \quad (9.17)$$

This is the *Cayley-Hamilton theorem*. A consequence is that  $\mathbf{T}^N$ , where  $N > 3$  can be written as a sum of  $\mathbf{T} \cdot \mathbf{T}$ ,  $\mathbf{T}$  and  $\mathbf{I}$  with coefficients that are functions of the invariants. A useful expression for the determinant can be obtained by taking the trace of (9.17) and rearranging

$$\det \mathbf{T} = \frac{1}{3} \{ \text{tr}(\mathbf{T} \cdot \mathbf{T} \cdot \mathbf{T}) - I_1 \text{tr}(\mathbf{T} \cdot \mathbf{T}) - I_2 I_1 \} \quad (9.18)$$

Another useful expression results from multiplying (9.16) by  $\mathbf{T}^{-1}$

$$\mathbf{T} \cdot \mathbf{T} = I_1 \mathbf{T} + I_2 \mathbf{I} + I_3 \mathbf{T}^{-1} \quad (9.19)$$

## 9.1 Example

$$T_{ij} = \begin{bmatrix} 7 & 0 & -2 \\ 0 & 5 & 0 \\ -2 & 0 & 4 \end{bmatrix} \quad (9.20)$$

$$\det(\mathbf{T} - \lambda \mathbf{I}) = (5 - \lambda)[(7 - \lambda)(4 - \lambda) - 4] = 0 \quad (9.21)$$

Therefore

$$\lambda^2 - 11\lambda + 24 = 0 \quad (9.22a)$$

$$\lambda = \frac{11 \pm \sqrt{121 - 96}}{2} = \frac{11 \pm 5}{2} = 8, 3 \quad (9.22b)$$

$$\lambda_I = 8, \lambda_{II} = 5, \lambda_{III} = 3 \quad (9.22c)$$

Find eigenvectors

$$(T_{ij} - \lambda_k \delta_{ij})\mu_j^{(k)} = 0 \quad (9.23)$$

For  $\lambda_I = 8$

$$-1\mu_1^I + 0\mu_2^I - 2\mu_3^I = 0 \Rightarrow \mu_1^I = -2\mu_3^I \quad (9.24a)$$

$$0 + (5 - 8)\mu_2^I - 0 = 0 \Rightarrow \mu_2^I = 0 \quad (9.24b)$$

$$-2\mu_1^I + 0 + (4 - 8)\mu_3^I = 0 \Rightarrow \mu_1^I = -2\mu_3^I \quad (9.24c)$$

Make  $\boldsymbol{\mu}^I$  a unit vector

$$(\mu_1^I)^2 + (\mu_2^I)^2 + (\mu_3^I)^2 = 1 \quad (9.25a)$$

$$(4\mu_3^I)^2 + 0 + (\mu_3^I)^2 = 1 \Rightarrow \mu_3^I = \pm \frac{1}{\sqrt{5}} \quad (9.25b)$$

$$\boldsymbol{\mu}^I = \mp \frac{2}{\sqrt{5}}\mathbf{e}_1 + 0\mathbf{e}_2 \pm \frac{1}{\sqrt{5}}\mathbf{e}_3 \quad (9.25c)$$

$\lambda_{II} = 5$

$$(7 - 5)\mu_1^{II} + 0\mu_2^{II} - 2\mu_3^{II} = 0 \Rightarrow \mu_2^{II} = \pm 1 \quad (9.26a)$$

$$-2\mu_1^{II} + 0 + (4 - 5)\mu_3^{II} = 0 \Rightarrow -2\mu_1^{II} - \mu_3^{II} \quad (9.26b)$$

$$\Rightarrow \mu_1^{II} = 0, \mu_3^{II} = 0 \quad (9.26c)$$

$$\boldsymbol{\mu}^{II} = \pm \mathbf{e}_2 \quad (9.26d)$$

$$\boldsymbol{\mu}^{III} = \boldsymbol{\mu}^I \times \boldsymbol{\mu}^{II} \text{ for a right-handed system} \quad (9.27a)$$

$$= (\mp \frac{2}{\sqrt{5}})(\pm 1)(\mathbf{e}_1 \times \mathbf{e}_2) \pm \frac{1}{\sqrt{5}}(\pm 1)(\mathbf{e}_3 \times \mathbf{e}_2) \quad (9.27b)$$

$$= \frac{-1}{\sqrt{5}}\mathbf{e}_1 - \frac{2}{\sqrt{5}}\mathbf{e}_3 \quad (9.27c)$$

$$\mathbf{T} = \lambda_I \boldsymbol{\mu}^I \boldsymbol{\mu}^I + \lambda_{II} \boldsymbol{\mu}^{II} \boldsymbol{\mu}^{II} + \lambda_{III} \boldsymbol{\mu}^{III} \boldsymbol{\mu}^{III} \quad (9.27d)$$

The matrix with the components of the eigenvectors as columns is given by

$$[A] = \begin{bmatrix} 2/\sqrt{5} & 0 & 1/\sqrt{5} \\ 0 & 1 & 0 \\ -1/\sqrt{5} & 0 & 2/\sqrt{5} \end{bmatrix}$$



Matrix multiplication can be used to verify that

$$\begin{aligned} & \begin{bmatrix} 2/\sqrt{5} & 0 & -1/\sqrt{5} \\ 0 & 1 & 0 \\ -1/\sqrt{5} & 0 & -2/\sqrt{5} \end{bmatrix} \begin{bmatrix} 7 & 0 & -2 \\ 0 & 5 & 0 \\ -2 & 0 & 4 \end{bmatrix} \begin{bmatrix} 2/\sqrt{5} & 0 & -1/\sqrt{5} \\ 0 & 1 & 0 \\ -1/\sqrt{5} & 0 & -2/\sqrt{5} \end{bmatrix} \\ = & \begin{bmatrix} 8 & 0 & 0 \\ 0 & 5 & 0 \\ 0 & 0 & 3 \end{bmatrix} \end{aligned}$$

## 9.2 Additional Reading

Malvern, pp. 44- 46; Chadwick, Chap. 1, Sec. 4, pp. 24-25; Aris, 2.5; Reddy, 2.5.5.

*CHAPTER 9. PRINCIPAL VALUES AND PRINCIPAL DIRECTIONS*

---

## Chapter 10

# Vector and Tensor Calculus

Typically, the vectors and tensors used in continuum mechanics will be functions of position (as well as time). Consequently, it is necessary to develop expressions for their changes with position. To introduce this subject, first consider a scalar valued function

$$\phi(\mathbf{x}) = \phi(x_1, x_2, x_3) \quad (10.1)$$

Figure 10.1 is analogous to a topographical map and shows three level surfaces; that is, three surfaces on which the value of  $\phi(\mathbf{x})$  is constant. Now consider the change in  $\phi$  as the position is changed from  $\mathbf{x}$  to  $\mathbf{x} + d\mathbf{x}$ . To do so, write  $d\mathbf{x} = \boldsymbol{\mu} ds$  where  $\boldsymbol{\mu}$  is a unit vector in the direction of  $d\mathbf{x}$  and  $ds$  is the magnitude of  $d\mathbf{x}$ . The change in  $\phi$  is given by

$$\frac{d\phi}{ds} = \lim_{ds \rightarrow 0} \frac{\phi(\mathbf{x} + \boldsymbol{\mu} ds) - \phi(\mathbf{x})}{ds} \quad (10.2)$$

Writing

$$\frac{d\phi}{ds} = \boldsymbol{\mu} \cdot \nabla \phi \quad (10.3)$$

defines the gradient of  $\phi$  as  $\nabla \phi$ . This representation (10.3) is coordinate free. The left side can be expressed in cartesian coordinates as

$$\frac{d\phi}{ds} = \frac{\partial \phi}{\partial x_k} \frac{dx_k}{ds} \quad (10.4a)$$

$$\frac{d\phi}{ds} = \left( \frac{\partial \phi}{\partial x_k} \mathbf{e}_k \right) \cdot \left( \frac{dx_l}{ds} \mathbf{e}_l \right) \quad (10.4b)$$

Noting that the second term in (10.4b) is the cartesian representation of  $\boldsymbol{\mu}$  identifies the gradient of  $\phi$  as

$$\nabla \phi = \mathbf{e}_l \frac{\partial \phi}{\partial x_l} = \mathbf{e}_l \phi_{,l} \quad (10.5)$$

where  $\phi_{,l} \equiv \partial \phi / \partial x_l$ . We can generalize and define a *gradient operator* as

$$\nabla = \mathbf{e}_k \frac{\partial}{\partial x_k} \quad (10.6)$$

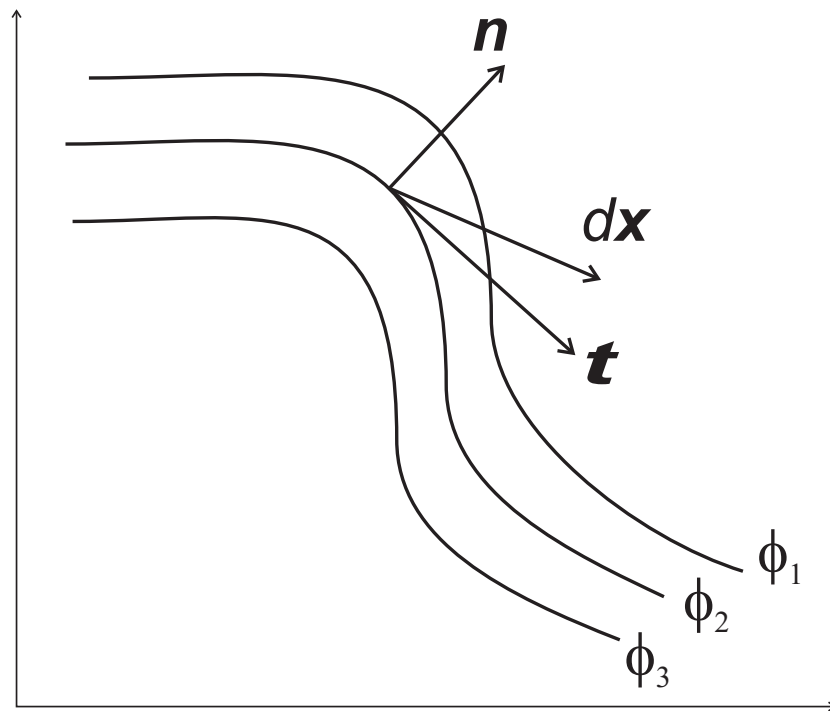

Figure 10.1: Schematic showing three level surfaces of the function  $\phi$ . The normal  $\mathbf{n}$  and tangent  $\mathbf{t}$  are also shown with the infinitesimal change of position vector  $d\mathbf{x}$ .

If  $\boldsymbol{\mu}$  is any vector tangent to the level surface then there is no change in  $\phi$  and

$$\frac{d\phi}{dt} = 0$$

where  $dt$  is an infinitesimal distance in the tangent direction. Hence  $\nabla\phi$  is perpendicular to the level surface and in the direction  $\mathbf{n}$

$$\nabla\phi = \alpha\mathbf{n} \quad (10.7)$$

Noting that

$$\boldsymbol{\mu} = \frac{d\mathbf{x}}{ds} = \mathbf{n} \quad (10.8)$$

yields

$$\frac{d\phi}{dn} = \mathbf{n} \cdot (\nabla\phi) = \mathbf{n} \cdot (\alpha\mathbf{n}) = \alpha \quad (10.9)$$

Therefore,

$$\nabla\phi = \frac{d\phi}{dn}\mathbf{n} \quad (10.10)$$

and  $\nabla\phi$  is in the direction  $\mathbf{n}$  (normal to the surface) and has the magnitude  $d\phi/dn$ .

An expression for the result of applying the gradient operator to a vector  $\mathbf{v}$  follows naturally from the representation of tensors as dyadics. The result  $\nabla\mathbf{v}$  is the tensor

$$\nabla\mathbf{v} = (\mathbf{e}_k \frac{\partial}{\partial x_k})(v_l \mathbf{e}_l) = \frac{\partial v_l}{\partial x_k} \mathbf{e}_k \mathbf{e}_l = \partial_k v_l \mathbf{e}_k \mathbf{e}_l \quad (10.11)$$

The second equality follows because the base vectors have fixed magnitude (unit vectors) and direction. The last equality introduces the notation  $\partial_k(\dots) \equiv \partial(\dots)/\partial x_k$ . Using either this notation or  $(\dots)_{,k}$  is useful for keeping the subscripts in the same order as the dyadic base vectors. The tensor (10.11) has cartesian components in matrix form given by

$$[\nabla\mathbf{v}] = \begin{bmatrix} \partial v_1/\partial x_1 & \partial v_2/\partial x_1 & \partial v_3/\partial x_1 \\ \partial v_1/\partial x_2 & \partial v_2/\partial x_2 & \partial v_3/\partial x_2 \\ \partial v_1/\partial x_3 & \partial v_2/\partial x_3 & \partial v_3/\partial x_3 \end{bmatrix} \quad (10.12)$$

To motivate this representation and demonstrate that the result is, in fact, a tensor, consider the Taylor expansion of vector components

$$v_i(x_j) = v_i(x_j^o) + \frac{\partial v_i}{\partial x_k}(x_j^o)(x_k - x_k^o) + \dots \quad (10.13)$$

or, in vector form,

$$\mathbf{v}(\mathbf{x}) = \mathbf{v}(\mathbf{x}^o) + (\mathbf{x} - \mathbf{x}^o) \cdot \nabla\mathbf{v}(\mathbf{x}^o) + \dots \quad (10.14)$$

(Note that the order of the subscripts in (10.13) dictates the position of  $(\mathbf{x} - \mathbf{x}^o)$  in (10.14).) Because  $\nabla\mathbf{v}$  associates a vector  $\mathbf{v}(\mathbf{x}) - \mathbf{v}(\mathbf{x}^o)$  with a vector  $\mathbf{x} - \mathbf{x}^o$

by means of a relation that is linear and homogeneous, it is a tensor. The transpose of this tensor is

$$(\nabla \mathbf{v})^T = \frac{\partial v_i}{\partial x_j} \mathbf{e}_i \mathbf{e}_j = v_{i,j} \mathbf{e}_i \mathbf{e}_j \quad (10.15)$$

The scalar product of  $\nabla \mathbf{v}$  and  $\mathbf{I}$  yields the divergence of the vector  $\mathbf{v}$

$$\nabla \mathbf{v} : \mathbf{I} = \left( \frac{\partial v_i}{\partial x_j} \mathbf{e}_j \mathbf{e}_i \right) : (\delta_{kl} \mathbf{e}_k \mathbf{e}_l) = \frac{\partial v_k}{\partial x_k} \quad (10.16)$$

This is a scalar that can also be obtained from the vector scalar product of  $\nabla$  and  $\mathbf{v}$

$$\nabla \cdot \mathbf{v} = \frac{\partial v_k}{\partial x_k} \quad (10.17)$$

If the vector  $\mathbf{v}$  is the gradient of a scalar function  $\phi$ , i.e.,  $\mathbf{v} = \nabla \phi$ , then

$$\nabla \cdot \nabla \phi = \left( \mathbf{e}_h \frac{\partial}{\partial x_h} \right) \cdot \left( \mathbf{e}_l \frac{\partial \phi}{\partial x_l} \right) = \delta_{kl} \frac{\partial^2 \phi}{\partial x_k \partial x_l} = \frac{\partial^2 \phi}{\partial x_k \partial x_k} = \nabla^2 \phi$$

gives the Laplacian of  $\phi$ . Forming the cross-product of  $\nabla$  and  $\mathbf{v}$  yields the curl of  $\mathbf{v}$

$$\nabla \times \mathbf{v} = \left( \mathbf{e}_i \frac{\partial}{\partial x_i} \right) \times (v_j \mathbf{e}_j) = \frac{\partial v_j}{\partial x_i} (\mathbf{e}_i \times \mathbf{e}_j) = \frac{\partial v_j}{\partial x_i} \epsilon_{ijk} \mathbf{e}_k \quad (10.18a)$$

$$= \mathbf{e}_i \partial_j v_k \epsilon_{ijk} \quad (10.18b)$$

Similar arguments can be used interpret the gradient of a tensor. A Taylor expansion of the tensor  $\mathbf{T}$  about  $\mathbf{x}_o$  yields

$$T_{ij}(x_k) = T_{ij}(x_k^o) + \frac{\partial T_{ij}}{\partial x_l}(x_k^o)(x_l - x_l^o) + \dots \quad (10.19a)$$

$$\nabla \cdot \mathbf{T} = \mathbf{e}_k \partial_k \cdot (T_{lm} \mathbf{e}_l \mathbf{e}_m) = \delta_{kl} \frac{\partial T_{lm}}{\partial x_k} \mathbf{e}_m = \frac{\partial T_{km}}{\partial x_k} \mathbf{e}_m \quad (10.19b)$$

and identifies

$$\nabla \mathbf{T} = (\mathbf{e}_i \partial_i) (T_{jh} \mathbf{e}_j \mathbf{e}_h) = \frac{\partial T_{jk}}{\partial x_i} \mathbf{e}_i \mathbf{e}_j \mathbf{e}_k$$

as a third order tensor. Forming the scalar and vector products of  $\nabla$  with  $\mathbf{T}$  yield

$$\nabla \cdot \mathbf{T} = \mathbf{e}_k \partial_k \cdot (T_{lm} \mathbf{e}_l \mathbf{e}_m) = \delta_{kl} \frac{\partial T_{lm}}{\partial x_k} \mathbf{e}_m = \frac{\partial T_{km}}{\partial x_k} \mathbf{e}_m \quad (10.20)$$

$$\nabla \times \mathbf{T} = \mathbf{e}_k \partial_k \times (T_{lm} \mathbf{e}_l \mathbf{e}_m) = \frac{\partial T_{lm}}{\partial x_k} \epsilon_{kln} \mathbf{e}_n \mathbf{e}_m \quad (10.21)$$

## 10.1 Example: Cylindrical Coordinates

Thus far, the orientations of base vectors have been fixed. The extension to more general situations is guided by the notation. As a simple example, consider the cylindrical coordinates with unit orthogonal base vectors  $\mathbf{e}_r$ ,  $\mathbf{e}_\theta$  and  $\mathbf{e}_z$  as shown in Figure 10.2. In cylindrical coordinates the gradient operator is given by

$$\nabla = \mathbf{e}_r \frac{\partial}{\partial r} + \mathbf{e}_\theta \frac{1}{r} \frac{\partial}{\partial \theta} + \mathbf{e}_z \frac{\partial}{\partial z} \quad (10.22)$$

The first and third terms are the same form as in rectangular coordinates; the middle term requires  $1/r$  in order to make the dimensions of each term be the reciprocal of length. Note that the unit vectors  $\mathbf{e}_r$  and  $\mathbf{e}_\theta$  are not fixed, but change with  $\theta$ :

$$\mathbf{e}_r = \cos \theta \mathbf{e}_x + \sin \theta \mathbf{e}_y \quad (10.23a)$$

$$\mathbf{e}_\theta = -\sin \theta \mathbf{e}_x + \cos \theta \mathbf{e}_y \quad (10.23b)$$

$$\frac{d\mathbf{e}_r}{d\theta} = -\sin \theta \mathbf{e}_x + \cos \theta \mathbf{e}_y = \mathbf{e}_\theta \quad (10.23c)$$

$$\frac{d\mathbf{e}_\theta}{d\theta} = -\cos \theta \mathbf{e}_x - \sin \theta \mathbf{e}_y = -\mathbf{e}_r \quad (10.23d)$$

Consequently, when applying the gradient operator to a vector in cylindrical coordinates, it is necessary to include the derivatives of the base vectors:

$$\nabla \cdot \mathbf{v} = \left( \mathbf{e}_r \frac{\partial}{\partial r} + \mathbf{e}_\theta \frac{1}{r} \frac{\partial}{\partial \theta} + \mathbf{e}_z \frac{\partial}{\partial z} \right) \cdot (v_r \mathbf{e}_r + v_\theta \mathbf{e}_\theta + v_z \mathbf{e}_z) \quad (10.24a)$$

$$= \frac{\partial v_r}{\partial r} + \mathbf{e}_\theta \frac{1}{r} \frac{\partial}{\partial \theta} \cdot (v_r \mathbf{e}_r + v_\theta \mathbf{e}_\theta) + \frac{\partial v_z}{\partial z} \quad (10.24b)$$

$$= \frac{\partial v_r}{\partial r} + \frac{v_r}{r} + \frac{1}{r} \frac{\partial v_\theta}{\partial \theta} + \frac{\partial v_z}{\partial z} \quad (10.24c)$$

Similar operations can be used to generate the cylindrical coordinate forms for  $\nabla \times \mathbf{v}$ ,  $\nabla^2 \mathbf{v}$ ,  $\nabla \mathbf{v}$ , and operations of the gradient on tensors.

## 10.2 Additional Reading

Malvern, Chapter 2, Section 2.5, pp. 48-62; Chadwick, Chapter 1, Section 10, pp. 38-43; Aris 3.21-3.24; Reddy, 2.4.1 - 5.

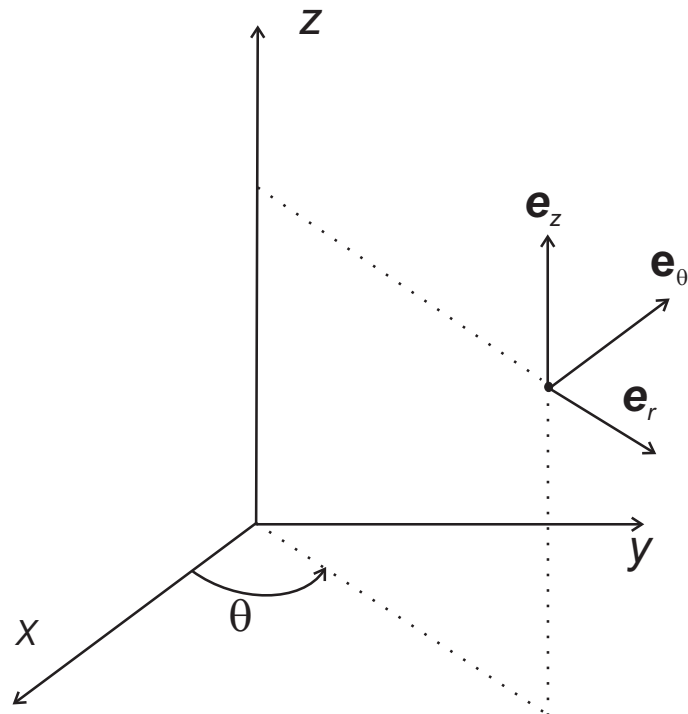

Figure 10.2: Base vectors in cylindrical coordinates depend on the angle  $\theta$ .



**Part II**

**Stress**



# Chapter 11

## Traction and Stress Tensor

### 11.1 Types of Forces

We have already said that continuum mechanics assumes an actual body can be described by associating with it a mathematically continuous body. For example, we define the density at a point  $P$  as

$$\rho^{(P)} = \lim_{\Delta V \rightarrow 0} \frac{\Delta m}{\Delta V} \quad (11.1)$$

where  $\Delta V$  contains the point  $P$  and  $\Delta m$  is the mass contained in  $\Delta V$ . Continuum mechanics assumes that it makes sense or, at least is useful, to perform this limiting process even though we know that matter is discrete on an atomic scale. More precisely,  $\rho$  is the average density in a representative volume around the point  $P$ . What is meant by a representative volume depends on the material being considered. For example, we can model a polycrystalline material with a density that varies strongly from point-to-point in different grains. Alternatively, we might use a uniform density that reflects the density averaged over several grains.

Just as we have considered the mass to be distributed continuously, so also do we consider the forces to be continuously distributed. These may be of two types:

1. *Body forces* have a magnitude proportional to the mass, and act at a distance, e.g. gravity, magnetic forces (Figure 11.1). Body forces are computed per unit mass  $\mathbf{b}$  or per unit volume  $\rho\mathbf{b}$ :

$$\mathbf{b}(\mathbf{x}) = \lim_{\Delta V \rightarrow 0} \frac{\mathbf{f}}{\rho\Delta V} \quad (11.2)$$

The continuum hypothesis asserts that this limit exists, has a unique value, and is independent of the manner in which  $\Delta V \rightarrow 0$ .

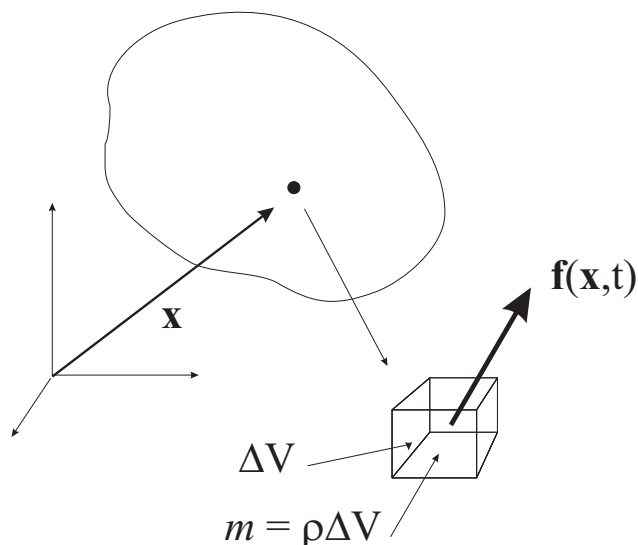

Figure 11.1: Illustration of the force  $\mathbf{f}(\mathbf{x}, t)$  acting on the volume element  $\Delta V$ .

2. Surface forces are computed per unit area and are contact forces. They may be forces that are applied to the exterior surface of the body or they may be forces transmitted from one part of a body to another.

Consider the forces acting on and within a body (Figure 11.2). Slice the body by a surface  $R$  (not necessarily planar) that passes through the point  $Q$  and divides the body into parts 1 and 2. Remove part 1 and replace it by the forces that 1 exerts on 2. The forces that 2 exerts on 1 are equal and opposite. Now consider the forces (exerted by 1 on 2) on a portion of the surface having area  $\Delta S$  and normal  $\mathbf{n}$  (at  $Q$ ). From statics, we know that we can replace the distribution of forces on this surface by a statically equivalent force  $\Delta \mathbf{f}$  and moment  $\Delta \mathbf{m}$  at  $Q$ . Define the *average traction* on  $\Delta S$  as

$$\Delta \mathbf{t}^{(\text{avg})} = \frac{\Delta \mathbf{f}}{\Delta S} \quad (11.3)$$

Now shrink  $C$  keeping point  $Q$  contained in  $C$ . Define traction at a point  $Q$  by

$$\mathbf{t}^{(\mathbf{n})} = \lim_{\Delta S \rightarrow 0} \frac{\Delta \mathbf{f}}{\Delta S} \quad (11.4)$$

This is a vector (sometimes called “stress vector”) and equals the force per unit area (intensity of force) exerted at  $Q$  by the material of 1 (side into which  $\mathbf{n}$  points) on 2. In addition, we will assume that

$$\lim_{\Delta S \rightarrow 0} \frac{\Delta \mathbf{m}}{\Delta S} = 0 \quad (11.5)$$

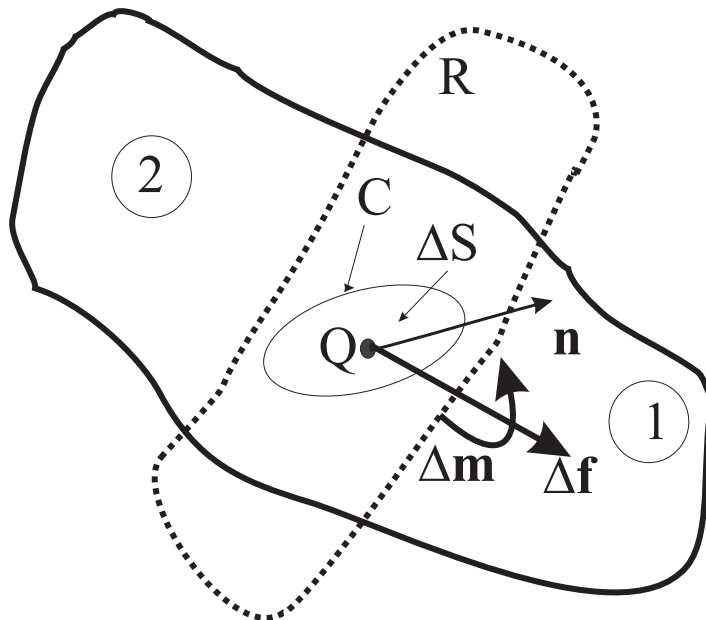

Figure 11.2: The surface  $R$  passes through the point  $Q$  and divides the body into two parts. The curve  $C$  contains  $Q$  and encloses an area  $\Delta S$ . The unit normal to the surface at  $Q$  is  $\mathbf{n}$ . The net force exerted by 1 on 2 across  $\Delta S$  is  $\Delta \mathbf{f}$  and the net moment is  $\Delta \mathbf{m}$ .

This will necessarily be the case if the couple is due to distributed forces. The theory of couple stresses does not make this assumption.

In taking the limit (11.4), we have assumed the following:

1. Body is continuous.
2.  $\Delta \mathbf{f}$  varies continuously.
3. No concentrated force at  $Q$ .
4. Limit is independent of the manner in which  $\Delta S \rightarrow 0$  and the choice of the surface  $\Delta S$  as long as the normal at  $Q$  is unique.

Note that traction is a vector and will have different values for different orientations of the normal  $\mathbf{n}$  (through the same point) and different values at different points of the surface.

## 11.2 Traction on Different Surfaces

The traction at a point depends on the orientation of the normal. More specifically, the traction will be different for different orientations of the normal through the point. To investigate the dependence on the normal, we will use Newton's 2nd law

$$\sum \mathbf{F} = m \frac{d\mathbf{v}}{dt} \quad (11.6)$$

where  $\mathbf{F}$  is the force,  $m$  is the mass, and  $\mathbf{v}$  is the velocity. Now apply this to a slice of material of thickness  $h$  and area  $\Delta S$  (Figure 11.3):

$$\mathbf{t}^{(\mathbf{n})} \Delta S + \mathbf{t}^{(-\mathbf{n})} \Delta S + \rho \mathbf{b} \Delta S h = \rho \Delta S h \frac{d\mathbf{v}}{dt} \quad (11.7)$$

where we have written the mass as  $\rho \Delta S h$ . Dividing through by  $\Delta S$  yields

$$\mathbf{t}^{(\mathbf{n})} + \mathbf{t}^{(-\mathbf{n})} + \rho \mathbf{b} h = \rho h \frac{d\mathbf{v}}{dt} \quad (11.8)$$

Letting  $h \rightarrow 0$  yields

$$\mathbf{t}^{(\mathbf{n})} = -\mathbf{t}^{(-\mathbf{n})} \quad (11.9)$$

Thus, the traction vectors are equal in magnitude and opposite in sign on two sides of a surface. In other words, reversing the direction of the normal to the surface reverses the sign of the traction vector. We can express the traction on planes normal to the coordinate directions  $\mathbf{t}^{(\mathbf{e}_i)}$  in terms of their components

$$\mathbf{t}^{(\mathbf{e}_1)} = T_{11} \mathbf{e}_1 + T_{12} \mathbf{e}_2 + T_{13} \mathbf{e}_3 \quad (11.10a)$$

$$\mathbf{t}^{(\mathbf{e}_2)} = T_{21} \mathbf{e}_1 + T_{22} \mathbf{e}_2 + T_{23} \mathbf{e}_3 \quad (11.10b)$$

$$\mathbf{t}^{(\mathbf{e}_3)} = T_{31} \mathbf{e}_1 + T_{32} \mathbf{e}_2 + T_{33} \mathbf{e}_3 \quad (11.10c)$$

These three equations can be written as

$$\mathbf{t}^{(\mathbf{e}_i)} = T_{ij} \mathbf{e}_j \quad (11.11)$$

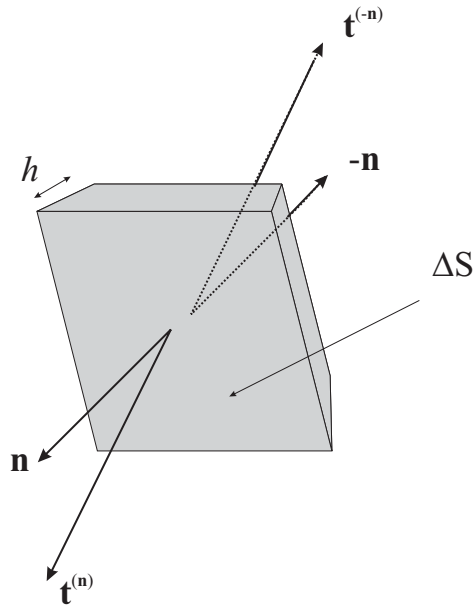

Figure 11.3: Tractions acting on opposite sides of a thin slice of material.

where the first index  $i$  denotes the direction of the normal to the plane on which the force acts and the 2nd index  $j$  denotes the direction of the force component. We can also express the traction as the scalar product of  $\mathbf{e}_i$  with a tensor.

$$\mathbf{t}^{(i)} = \mathbf{e}_i \cdot (T_{mn} \mathbf{e}_m \mathbf{e}_n) \quad (11.12)$$

The term in parentheses is the stress tensor  $\mathbf{T}$  and the  $T_{ij}$  are its cartesian components.  $T_{11}, T_{22}, T_{33}$  are *normal stresses*, and  $T_{12}, T_{21}, T_{32}, T_{23}, T_{31}, T_{13}$  are *shear stresses*. Typically, in engineering, normal stresses are positive if they act in tension. In this case a stress component is positive if it acts in the positive coordinate direction on a face with outward normal in the positive coordinate direction or if it acts in the negative coordinate direction on a face with outward normal in the negative coordinate direction (Note that for a bar in equilibrium the forces acting on the ends of the bar are in opposite directions but these correspond to stress components of the same sign.). Often, in geology or geotechnical engineering, the sign convention is reversed because normal stresses are typically compressive.

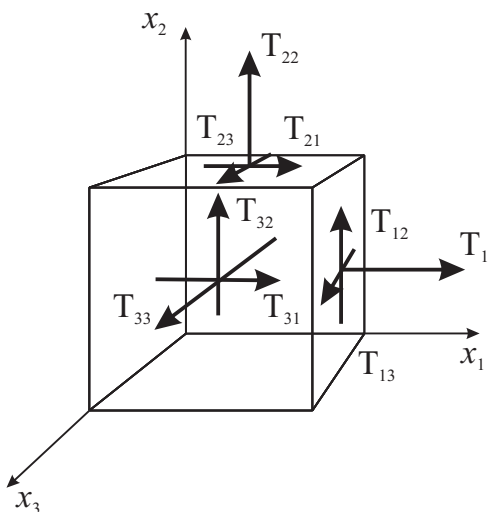

Figure 11.4: Illustrates the labelling of the components of the stress tensor. Remember that the cube shown represents a *point*.

### 11.3 Traction on an Arbitrary Plane (Cauchy tetrahedron)

Equation (11.10) gives the tractions on planes with normals in the coordinate directions but we would like to determine the traction on a plane with a normal in an arbitrary direction. Figure 11.5 shows a tetrahedron with three faces perpendicular to the coordinate axes and the fourth (oblique) face with a normal vector  $\mathbf{n}$ . The oblique face has area  $\Delta S$  and the area of the other faces can be expressed as

$$\Delta S_i = n_i \Delta S \quad (11.13)$$

The volume of the tetrahedron is given by

$$\Delta V = \frac{1}{3} h \Delta S \quad (11.14)$$

where  $h$  is the distance perpendicular to the oblique face through the origin. Applying Newton's 2nd Law to this tetrahedron gives

$$\mathbf{t}^{(\mathbf{n})} \Delta S + (-\mathbf{t}^{(i)} \Delta S_i) + \rho \mathbf{b} \Delta V = \rho \Delta V \frac{d\mathbf{v}}{dt} \quad (11.15)$$

In the second term, we have used (11.9) to express the sum of the forces acting on the planes perpendicular to the negative of the coordinate directions. Divide through by  $\Delta S$  and let  $h \rightarrow 0$ . The result is

$$\mathbf{t}^{(\mathbf{n})} = \mathbf{t}^{(i)} n_i = n_1 \mathbf{t}^{(1)} + n_2 \mathbf{t}^{(2)} + n_3 \mathbf{t}^{(3)} \quad (11.16)$$



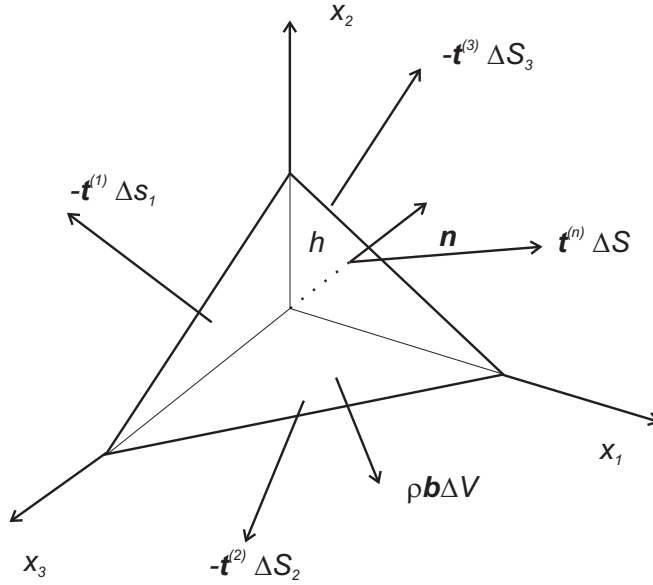

Figure 11.5: Tetrahedron with tractions acting on the faces.

Substituting (11.10) yields

$$\mathbf{t}^{(\mathbf{n})} = n_i T_{ij} \mathbf{e}_j = \mathbf{n} \cdot \mathbf{T} \quad (11.17)$$

This expression associates a vector  $\mathbf{t}^{(\mathbf{n})}$  with every direction in space  $\mathbf{n}$  by means of an expression that is linear and homogeneous and, hence, establishes  $\mathbf{T}$  as a tensor. Since the  $\mathbf{n}$  appears on the right side we will drop it as a superscript on  $\mathbf{t}$  hereafter.

Because  $\mathbf{T}$  is a tensor, its components in a rectangular cartesian system must transform accordingly

$$T'_{ij} = A_{pi} A_{qj} T_{pq} \quad (11.18)$$

where

$$A_{pi} = \mathbf{e}'_i \cdot \mathbf{e}_p \quad (11.19)$$

## 11.4 Symmetry of the stress tensor

We can also show that  $\mathbf{T}$  is a symmetric tensor (later, we will give a more general proof) by enforcing that the sum of the moments is equal to the moment of inertia multiplied by the angular acceleration for a small cuboidal element centered at  $(x_1, x_2, x_3)$  with edges  $\Delta x_1$ ,  $\Delta x_2$  and  $\Delta x_3$  (not shown). For simplicity, consider the element to be subjected only to shear stresses  $T_{12}$  and  $T_{21}$  in the  $x_1 x_2$  plane. The moment of inertia about the center of this element is

$$I = \frac{\rho}{12} \Delta x_1 \Delta x_2 \Delta x_3 (\Delta x_1^2 + \Delta x_2^2) \quad (11.20)$$

Summing the moments yields

$$\begin{aligned}
 & \left[ T_{12}(x_1 + \frac{\Delta x_1}{2}, x_2)\Delta x_2 + T_{12}(x_1 - \frac{\Delta x_1}{2}, x_2)\Delta x_2 \right] \Delta x_2 \Delta x_3 \frac{1}{2} \Delta x_1 \\
 & - \left[ T_{21}(x_1, x_2 + \Delta x_2 \frac{1}{2}) + T_{21}(x_1, x_2 - \frac{1}{2} \Delta x_2) \right] \Delta x_1 \Delta x_3 \frac{1}{2} \Delta x_2 \\
 = & \alpha \frac{\rho}{12} (\Delta x_1 \Delta x_2 \Delta x_3) (\Delta x_1^2 + \Delta x_2^2)
 \end{aligned}
 \tag{11.21}$$

where the  $\Delta x_1/2$  and  $\Delta x_2/2$  in the first two lines are the moment arms. Dividing through by  $\Delta x_1 \Delta x_2 \Delta x_3$  and letting  $\Delta x_1 \Delta x_2 \rightarrow 0$  yields

$$T_{21} = T_{12} \tag{11.22}$$

and, similarly,

$$T_{ij} = T_{ji} \tag{11.23}$$

Later we will give a more general derivation of this result and see that it does not pertain when the stress is defined per unit reference (as distinguished from current) area.

## 11.5 Additional Reading

Malvern, 3.1, 3.2; Chadwick, 3.3; Aris, 5.11 - 5.15; Reddy, 4.1-4.2.

## Chapter 12

# Principal Values of Stress

Because  $\mathbf{T}$  is a symmetric tensor, we showed in Chapter 3 that it has three real principal values with at least one set of orthogonal principal directions. Let the principal values be  $\sigma_1, \sigma_2, \sigma_3$  and the corresponding principal directions be  $\mathbf{n}^{(1)}, \mathbf{n}^{(2)}$  and  $\mathbf{n}^{(3)}$ . These satisfy (9.11), rewritten here in the current notation:

$$(T_{ij} - \sigma_K \delta_{ij})n_j^{(K)} = 0 \quad (12.1)$$

Rearranging this equation shows that the directions  $\mathbf{n}^{(K)}$  are those for planes having only normal tractions. We have already derived this equation, but we will now rederive it by another approach. In doing so, we will show that two of the principal values correspond to the largest and smallest values of the normal stress on the plane with normal  $\mathbf{n}$ . Thus, we want to find stationary values of  $t_n$  with respect to the direction  $\mathbf{n}$ :

$$t_n = \mathbf{n} \cdot \mathbf{T} \cdot \mathbf{n} = n_i T_{ij} n_j \quad (12.2)$$

Note that the  $n_i$  are not independent but are subject to the constraint

$$\mathbf{n} \cdot \mathbf{n} = n_i n_i = 1 \quad (12.3)$$

We can incorporate this constraint by means of the Lagrange multiplier  $\sigma$

$$\frac{\partial}{\partial n_k} \{n_i T_{ij} n_j - \sigma(n_i n_i - 1)\} = 0 \quad (12.4)$$

so that  $\partial(\dots)\partial\sigma = 0$  yields the constraint equation. Carrying out the differentiation in (12.4) yields

$$\frac{\partial n_i}{\partial n_k} T_{ij} n_j + n_i T_{ij} \frac{\partial n_j}{\partial n_k} - 2\sigma n_i \frac{\partial n_i}{\partial n_k} = 0 \quad (12.5)$$

Since  $\partial n_i / \partial n_k = \delta_{ik}$ ,

$$T_{kj} n_j + n_i T_{ik} - 2\sigma n_k = 0 \quad (12.6)$$

or

$$(T_{kj} - \sigma \delta_{kj})n_j = 0 \quad (12.7)$$

which is the same as (12.1). Therefore, the roots of

$$\det |T_{kj} - \sigma \delta_{kj}| = 0 \quad (12.8)$$

are the stationary values of  $t_n$ . Denote these roots by

$$\sigma_1 > \sigma_2 > \sigma_3 \quad (12.9)$$

with corresponding principal directions  $\mathbf{n}^{(1)}$ ,  $\mathbf{n}^{(2)}$ , and  $\mathbf{n}^{(3)}$ .

$$\left\{ \begin{array}{c} \sigma_1 \\ \sigma_3 \end{array} \right\} \text{ is the } \left\{ \begin{array}{c} \text{largest} \\ \text{smallest} \end{array} \right\} \text{ normal stress} \quad (12.10)$$

$\sigma_2$  is a stationary value, i.e. the largest normal stress in the plane defined by  $\mathbf{n}^{(2)}$  and  $\mathbf{n}^{(3)}$  and the smallest normal stress in the plane defined by  $\mathbf{n}^{(1)}$  and  $\mathbf{n}^{(2)}$ . If two of the principal values are equal, say,  $\sigma_1 = \sigma_3$ , then the direction  $\mathbf{n}^{(3)}$  is unique, but any rotation about  $\mathbf{n}^{(3)}$  yields another set of principal axes.

From (9.13) we know that the principal values satisfy

$$\sigma^3 - I_1\sigma^2 - I_2\sigma - I_3 = 0 \quad (12.11)$$

where the coefficients are given by (9.14) and other results from Chapter 9.2 also apply here.

## 12.1 Deviatoric Stress

It is often useful to separate the stress (or, indeed, any tensor) into a part with zero trace, called the *deviatoric* part, and an *isotropic* tensor (An isotropic tensor is one that has the same components in any rectangular cartesian coordinate system. All isotropic tensors of order 2 are a scalar times the Kronecker delta). The deviatoric stress is defined as

$$T'_{ij} = T_{ij} - \frac{1}{3}\delta_{ij}T_{kk} \quad (12.12)$$

or

$$\mathbf{T}' = \mathbf{T} - \frac{1}{3}(\text{tr}\mathbf{T})\mathbf{I} \quad (12.13)$$

By construction, the trace of the deviator, the first invariant, vanishes

$$\text{tr}\mathbf{T}' = 0 \quad (12.14)$$

Unless the equation for the principal values (12.11) is easy to factor, it is generally more convenient to solve numerically. It is, however, possible to obtain a closed form solution in terms of the principal values of the deviatoric stress.

Because the first invariant of the deviatoric stress vanishes (12.14), the equation for the principal values becomes

$$s^3 - J_2 s - J_3 = 0 \quad (12.15)$$

where  $s$  is the principal value and the invariants  $J_2$  and  $J_3$  are given by

$$J_2 = \frac{1}{2} T'_{ij} T'_{ij} \quad (12.16a)$$

$$J_3 = \det(T'_{ij}) = \frac{1}{3} \text{tr}(\mathbf{T}' \cdot \mathbf{T}' \cdot \mathbf{T}') = \frac{1}{3} T'_{ik} T'_{kl} T'_{li} \quad (12.16b)$$

Making the substitution

$$s = \left(\frac{4}{3} J_2\right)^{1/2} \sin \alpha \quad (12.17)$$

in (12.15) and using some trigonometric identities yields

$$\sin 3\alpha = \frac{\sqrt{27} J_3}{2 (J_2)^{3/2}} \quad (12.18)$$

or

$$\alpha = \frac{1}{3} \arcsin \left( \frac{\sqrt{27} J_3}{2 (J_2)^{3/2}} \right) \quad (12.19)$$

This yields one root of (12.15). Two roots are given by  $\alpha \pm 2\pi/3$ .

## 12.2 Reading

Malvern, 3.3; Chadwick, 3.3; Aris, 5.11-5.14.



## Chapter 13

# Stationary Values of Shear Traction

We now want to make a calculation for the shear traction similar to that in the preceding chapter for the normal traction. In particular, we want to determine the largest value of the shear traction and the orientation of the plane on which it occurs. The traction on a plane with a normal  $\mathbf{n}$  can be resolved into a normal component

$$t_n = \mathbf{n} \cdot \mathbf{t} \quad (13.1)$$

where

$$\mathbf{t} = \mathbf{n} \cdot \mathbf{T} \quad (13.2)$$

and shear component  $t_s$

$$\mathbf{t}^{(n)} = (\mathbf{n} \cdot \mathbf{t})\mathbf{n} + t_s\mathbf{s} \quad (13.3)$$

where  $\mathbf{n} \cdot \mathbf{s} = 0$  (Figure 13.1). Rearranging as

$$t_s\mathbf{s} = \mathbf{t}^{(n)} - t_n\mathbf{n} \quad (13.4)$$

and dotting each side with itself, yields the following expression for the magnitude of the shear traction

$$t_s^2 = \mathbf{t}^{(n)} \cdot \mathbf{t}^{(n)} - t_n^2 \quad (13.5)$$

or, in component form in terms of the stress,

$$t_s^2 = (n_p T_{pq})(n_r T_{rq}) - (n_p T_{pq} n_q)^2 \quad (13.6)$$

Just as we did for the normal stress, we want to let  $\mathbf{n}$  vary over all directions and find the largest and smallest values of the shear traction. Thus, we want to find stationary values of the shear traction, subject to the condition

$$\mathbf{n} \cdot \mathbf{n} = n_k n_k = 1 \quad (13.7)$$

Because the sign of the shear traction has no physical significance (unlike the sign of the normal traction which indicates tension or compression), there is no loss of generality in working with the square of the shear traction. To facilitate the calculation, choose the principal directions as coordinate axes:

$$\mathbf{T} = \sum \sigma_K \mathbf{e}_K \mathbf{e}_K = \sigma_I \mathbf{e}_I \mathbf{e}_I + \sigma_{II} \mathbf{e}_{II} \mathbf{e}_{II} + \sigma_{III} \mathbf{e}_{III} \mathbf{e}_{III} \quad (13.8a)$$

$$\mathbf{n} = \sum n_L \mathbf{e}_L \quad (13.8b)$$

(Summation is indicated explicitly here since the subscript "K" appears three times in (13.8a). Then the traction on the plane with normal  $\mathbf{n}$  is

$$\begin{aligned} \mathbf{t}^{(\mathbf{n})} &= \mathbf{n} \cdot \mathbf{T} = \sum n_L \mathbf{e}_L \cdot \sum \sigma_K \mathbf{e}_K \mathbf{e}_K \\ &= \sum n_K \sigma_K \mathbf{e}_K = n_I \sigma_I \mathbf{e}_I + n_{II} \sigma_{II} \mathbf{e}_{II} + n_{III} \sigma_{III} \mathbf{e}_{III} \end{aligned}$$

The normal traction is

$$t_n = \mathbf{n} \cdot \mathbf{T} \cdot \mathbf{n} = \sum_k n_k^2 \sigma_k = n_I^2 \sigma_I + n_{II}^2 \sigma_{II} + n_{III}^2 \sigma_{III}$$

and the shear traction is given by (13.5). Taking the derivative

$$\frac{\partial}{\partial n_L} \{t_s^2 + \lambda (n_K n_K - 1)\} = 0 \quad (13.9)$$

yields

$$n_L \{\sigma_L^2 - 2\sigma_L t_n + \lambda\} = 0 \quad (\text{no sum on } L) \quad (13.10)$$

Writing out the three equations for  $L = I, II, III$  gives

$$n_I \{\sigma_I^2 - 2\sigma_I t_n + \lambda\} = 0 \quad (13.11a)$$

$$n_{II} \{\sigma_{II}^2 - 2\sigma_{II} t_n + \lambda\} = 0 \quad (13.11b)$$

$$n_{III} \{\sigma_{III}^2 - 2\sigma_{III} t_n + \lambda\} = 0 \quad (13.11c)$$

There are three possible cases corresponding to the assumption that one, two, or none of the  $\mathbf{n}_L$  are zero.

Case 1: Suppose, for example, that  $n_{II} = n_{III} = 0$ , then  $n_I = 1$ . Thus, (13.11a) is the only non-trivial equation of (13.11) and reduces to

$$\sigma_I^2 - 2\sigma_I t_n + \lambda = 0 \quad (13.12)$$

But, for  $n_{II} = n_{III} = 0$ ,  $n_I = 1$

$$t_n = \sigma_I \quad (13.13)$$

and, consequently

$$\lambda = \sigma_I^2$$



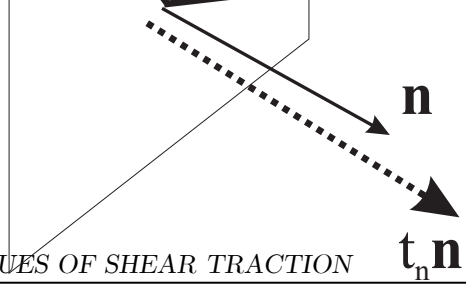

Figure 13.1: Traction on a plane with normal  $\mathbf{n}$  resolved into shear and normal components.

Substituting back into (13.6) yields

$$t_s^2 = 0 \quad (13.14)$$

Since the  $\mathbf{n}_K$  are in the principal directions, this result simply confirms that the shear stress is zero on principal planes.

Case 2: Now suppose  $n_I, n_{II} \neq 0$  and  $n_{III} = 0$ . Equation (13.11c) is automatically satisfied and (13.11a, 13.11b) become

$$\sigma_I^2 - 2\sigma_I(n_I^2\sigma_I + n_{II}^2\sigma_{II}) + \lambda = 0 \quad (13.15a)$$

$$\sigma_{II}^2 - 2\sigma_{II}(n_I^2\sigma_I + n_{II}^2\sigma_{II}) + \lambda = 0 \quad (13.15b)$$

Eliminating  $\lambda$  yields

$$\sigma_I^2 - 2\sigma_I(n_I^2\sigma_I + n_{II}^2\sigma_{II}) = \sigma_{II}^2 - 2\sigma_{II}(n_I^2\sigma_I + n_{II}^2\sigma_{II}) \quad (13.16)$$

and rearranging gives

$$(\sigma_I - \sigma_{II}) \{\sigma_I + \sigma_{II}\} = 2(\sigma_I - \sigma_{II})\mathbf{n} \cdot \mathbf{T} \cdot \mathbf{n} \quad (13.17)$$

Assuming  $\sigma_I \neq \sigma_{II}$  and substituting  $n_{II}^2 = 1 - n_I^2$  yields

$$n_I^2 = \frac{1}{2} \text{ or } n_I = \pm \frac{1}{\sqrt{2}} \quad (13.18)$$

and, consequently,

$$n_{II} = \pm \frac{1}{\sqrt{2}} \quad (13.19)$$

Taking the plus signs and substituting into the expression for  $T_{n_s}^2$  gives

$$t_s^2 = \sum n_k^2 \sigma_k^2 - \left[ \sum (n_k \sigma_k n_k) \right]^2 \quad (13.20a)$$

$$= \frac{1}{2}(\sigma_I^2 + \sigma_{II}^2) - \frac{1}{4}(\sigma_I + \sigma_{II})^2 = \frac{1}{4}(\sigma_I - \sigma_{II})^2 \quad (13.20b)$$

or

$$(t_s)_{\max} = \frac{1}{2} |\sigma_I - \sigma_{II}| \quad (13.21)$$

Case 3: If all  $n_k \neq 0$ , this implies that

$$\sigma_I = \sigma_{II} = \sigma_{III} \quad (13.22)$$

which contradicts the assumption that principal values are distinct and yields  $t_s^2 \equiv 0$  on all planes.

Equation (13.21) gives the maximum traction on planes with normals in the  $I$  and  $II$  plane. The same calculation yields corresponding results for normals in the  $I$  and  $III$  and  $II$  and  $III$  planes. Therefore the absolute maximum value of  $t_s$  occurs on a plane whose normal makes a  $45^\circ$  angle with the principal directions corresponding to the maximum and minimum principal stresses.

## 13.1 Additional Reading

Malvern, 3.3; Chadwick, 3.3; Aris, 5.11-5.14; Reddy, 4.3.3.

## Chapter 14

# Mohr's Circle

Mohr's circle provides a useful graphical illustration of how the traction varies with the orientation of the plane on which it acts. In three dimensions, it is most useful when the principal values of the stress are already known. If the direction of one of the principal stresses is known, it not only provides a useful graphical illustration but also an alternative means of calculating the other two principal stresses and their directions. Here, the  $x_3$  direction is assumed to be a principal direction (Figure 14.1) for the stress tensor and, consequently, it can be written as

$$T = T_{\alpha\beta}\mathbf{e}_\alpha\mathbf{e}_\beta + T_{33}\mathbf{e}_3\mathbf{e}_3 \quad (14.1)$$

where  $\alpha, \beta = 1, 2$ . For the element shown in Figure 14.2, the normal and tangent vectors are given by

$$\mathbf{n} = \cos \alpha \mathbf{e}_1 + \sin \alpha \mathbf{e}_2 \quad (14.2a)$$

$$\mathbf{s} = -\sin \alpha \mathbf{e}_1 + \cos \alpha \mathbf{e}_2 \quad (14.2b)$$

Note that when  $\alpha = 0$ ,  $t_n = T_{11}$  and  $t_s = T_{12}$  and when  $\alpha = 90$ ,  $t_n = T_{22}$  and  $t_s = -T_{12}$ . This means that shear stress components tending to cause a clockwise moment are plotted as negative in Mohr's circle (even though the shear stress components themselves may be positive). This difference in sign results from the difference between the component of the traction, which is a vector, and the component of the stress, which is a tensor. Alternatively, we could have taken the positive  $\mathbf{s}$  direction to be down the plane, in which case the signs on the shear traction would be reversed. This choice governs whether the rotation in the Mohr plane, which plots  $t_s$  vs.  $t_n$ , is in the same or the opposite direction as the rotation in the physical plane. (Malvern describes both conventions.)

The traction vector on the inclined plane is

$$\mathbf{t} = \mathbf{n} \cdot \mathbf{T} \quad (14.3a)$$

$$= \cos \alpha (T_{11}\mathbf{e}_1 + T_{12}\mathbf{e}_2) + \sin \alpha (T_{21}\mathbf{e}_1 + T_{22}\mathbf{e}_2) \quad (14.3b)$$

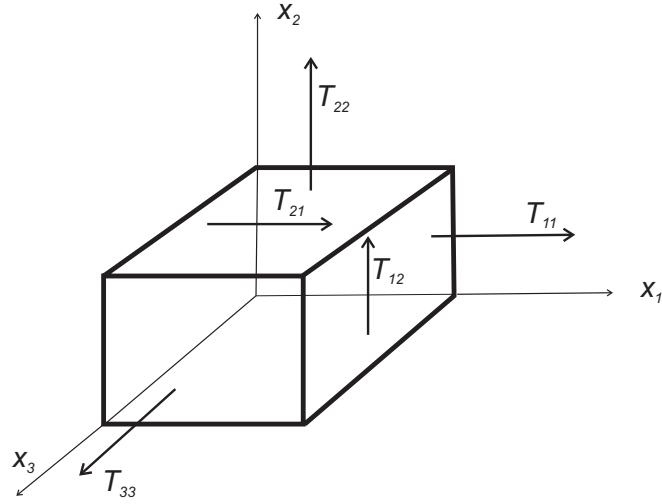

Figure 14.1: Element for analysis with Mohr's circle. The  $x_3$  direction is a principal direction.

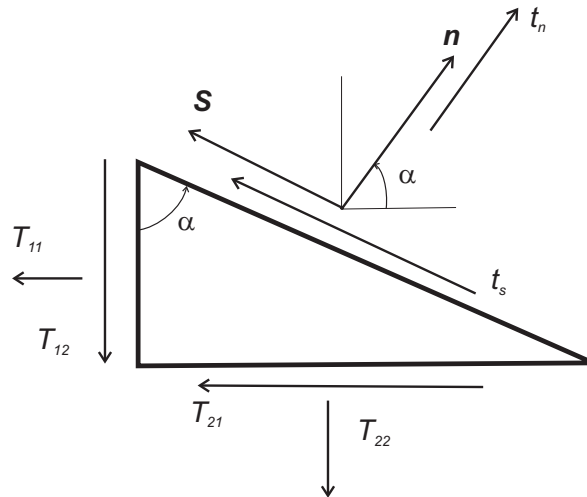

Figure 14.2: Traction on an inclined plane.

The normal and shear components of the traction are

$$t_n = \mathbf{n} \cdot \mathbf{T} \cdot \mathbf{n} \quad (14.4a)$$

$$= T_{11} \cos^2 \alpha + T_{21} \cos \alpha \sin \alpha + T_{12} \sin \alpha \cos \alpha + T_{22} \sin^2 \alpha \quad (14.4b)$$

$$= T_{11} \cos^2 \alpha + T_{22} \sin^2 \alpha + 2T_{21} \cos \alpha \sin \alpha \quad (14.4c)$$

$$t_s = \mathbf{n} \cdot \mathbf{T} \cdot \mathbf{s} \quad (14.4d)$$

$$= -\sin \alpha \cos \alpha T_{11} - \sin^2 \alpha T_{21} + \cos^2 \alpha T_{12} + T_{22} \cos \alpha \sin \alpha \quad (14.4e)$$

$$= (T_{22} - T_{11})(\cos \alpha \sin \alpha) + T_{12}(\cos^2 \alpha - \sin^2 \alpha) \quad (14.4f)$$

By using the double angle formulas:

$$\cos^2 \theta = \frac{1}{2}(1 + \cos 2\theta) \quad (14.5a)$$

$$\sin^2 \theta = \frac{1}{2}(1 - \cos 2\theta) \quad (14.5b)$$

$$\sin 2\theta = 2 \cos \theta \sin \theta \quad (14.5c)$$

the normal and shear components are rewritten as

$$t_n = \frac{1}{2}(T_{11} + T_{22}) - \frac{1}{2}(T_{22} - T_{11}) \cos 2\alpha + T_{12} \sin 2\alpha \quad (14.6a)$$

$$t_s = \frac{1}{2}(T_{22} - T_{11}) \sin 2\alpha + T_{12} \cos 2\alpha \quad (14.6b)$$

Forming

$$\left\{ \left[ t_n - \frac{1}{2}(T_{11} + T_{22}) \right]^2 + t_s^2 \right\} = R^2 \quad (14.7a)$$

gives the equation of a circle in the plane  $t_s$  vs.  $t_n$ . The center of the circle is at  $t_n = \frac{1}{2}(T_{11} + T_{22})$  and the radius is

$$R = \sqrt{\left[ \frac{1}{2}(T_{11} - T_{22}) \right]^2 + (T_{12})^2} \quad (14.8)$$

The points on the circle give the values of  $t_s$  and  $t_n$  as the angle  $\alpha$  varies.

## 14.1 Example Problem

Malvern, p.111 problem 3a:

$$\sigma_x = 55, \sigma_y = 15, \tau_{xy} = 10.$$

$$\text{center} = \frac{1}{2}(\sigma_x + \sigma_y) = 35 \quad (14.9a)$$

$$\text{radius} = \sqrt{\frac{1}{4}(55 - 15)^2 + 10^2} = \sqrt{\frac{40 \times 40}{4} + 100} = 10\sqrt{5} \quad (14.9b)$$

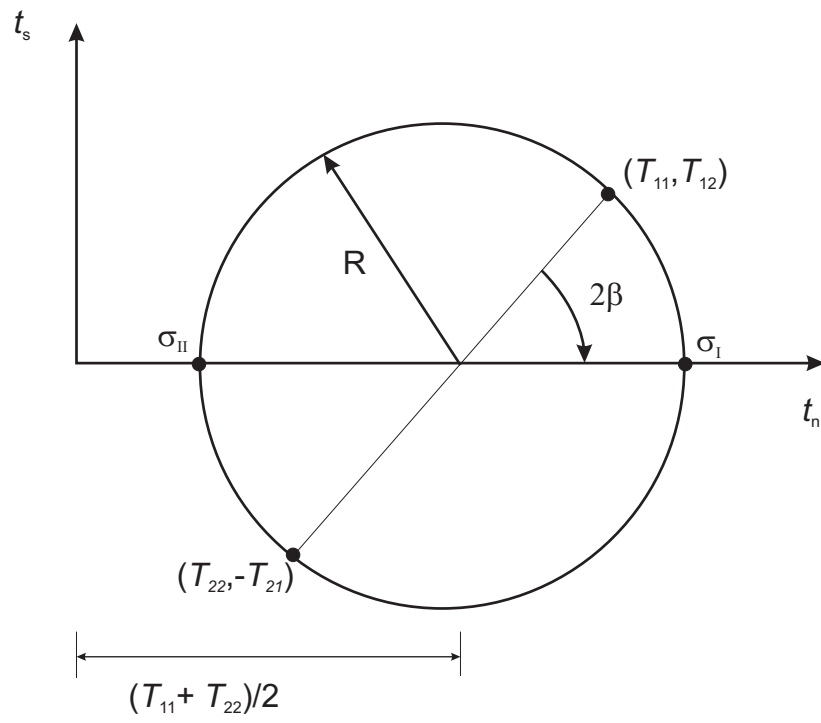

Figure 14.3: Mohr's circle.

$$\sigma_I = 35 + R = 5(7 + 2\sqrt{5}) \quad (14.10a)$$

$$\sigma_{II} = 35 - R = 5(7 - 2\sqrt{5}) \quad (14.10b)$$

$$t_{s\max} = R = 10\sqrt{5} \quad (14.10c)$$

$$\tan 2\beta = \frac{10}{20} = \frac{1}{2} \Rightarrow 2\beta = 26.57 \Rightarrow \beta = 13.28 \quad (14.10d)$$

## 14.2 Additional Reading

Malvern, Sec. 3.4-3.5, pp. 95-112.





## Part III

# Motion and Deformation



## Chapter 15

# Current and Reference Configurations

Figure 15.1 shows two configurations of the body: The *current configuration* at time  $t$  and the *reference configuration* at some time  $t_0 \leq t$ . The reference configuration can be chosen for convenience in analysis. For example, for an elastic body, it is often convenient to choose the reference configuration as the configuration when the loads are reduced to zero. For an elastic-plastic body or a fluid, it is often convenient to choose the reference configuration to coincide with the current configuration.

$P_o(\mathbf{X})$  is the position of a material particle in the reference configuration. The same material particle is located at  $P(\mathbf{x})$  in the current configuration. The *motion* of the material particle is described by

$$\mathbf{x} = \mathbf{f}(\mathbf{X}, t) \quad (15.1)$$

or

$$\mathbf{x} = \mathbf{f}(X_1, X_2, X_3, t) \quad (15.2)$$

and is usually abbreviated

$$\mathbf{x} = \mathbf{x}(\mathbf{X}, t) \quad (15.3)$$

The notation (15.3), although ubiquitous, is a bit imprecise since  $\mathbf{x}$  is used to denote both the function  $\mathbf{f}$  in (15.1) and its value for a particular  $\mathbf{X}$  and  $t$ . In words, these expressions say that “ $\mathbf{x}$  is the position at time  $t$  of the particle that occupied position  $\mathbf{X}$  in the reference configuration at time  $t = t_o$ .” In this description the  $x_i$  are regarded as dependent variables; the  $X_i$  are independent variables. Because each material particle occupies a unique position in the reference configuration, the position  $\mathbf{X}$  can be used as a label for the particle. That is, different values of  $\mathbf{X}$  correspond to different material particles. The position  $\mathbf{x}$  may, however, be occupied by different material particles at different times.

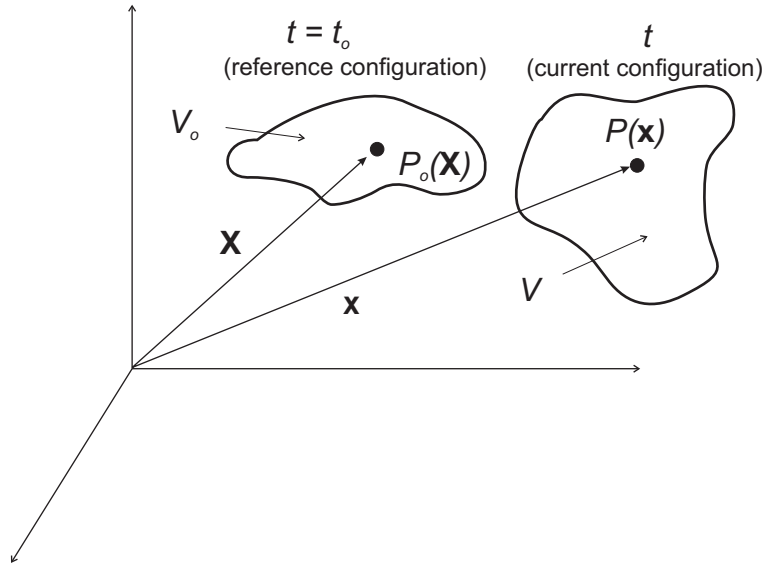

Figure 15.1: Schematic of the reference and current configurations.

In principle, we can invert the motion to write the position in the reference configuration  $\mathbf{X}$  in terms of time and the current location  $\mathbf{x}$ .

$$\mathbf{X} = \mathbf{F}(\mathbf{x}, t) \text{ or } \mathbf{X} = \mathbf{X}(\mathbf{x}, t) \quad (15.4)$$

Now we regard the  $x_i$  as independent variables. Physically, it is plausible that the motion can be inverted because each and every point in the reference configuration corresponds to exactly one point in the current configuration. The mathematical condition insuring that (15.1) can be inverted is

$$J = \left| \frac{\partial \mathbf{x}}{\partial \mathbf{X}} \right| = \left| \frac{\partial x_i}{\partial X_j} \right| > 0 \quad (15.5)$$

Later, we will show that this condition implies that small volume elements in both the reference and current configurations are finite and positive.

When the  $X_i$  are used as independent variables, this is often called the *Lagrangian* description. Because different values of  $\mathbf{X}$  correspond to different positions in the reference configuration and hence different material particles, the Lagrangian description follows a material particle through the motion.

When the  $x_i$  are used as the independent variables, the description is called *Eulerian*. This point-of-view considers a fixed location in space and observes how the material particles move past this location. Because a fixed value of  $\mathbf{x}$  refers to a fixed location, it does not correspond to a fixed material particle; that is, different particles will move past this location as time evolves.

If the motion, (15.1) or (15.3), is known, the velocity can be computed simply as the rate of change of the location with time.

$$\mathbf{V}(\mathbf{X}, t) = \frac{\partial \mathbf{x}}{\partial t} = \frac{\partial \mathbf{f}}{\partial t}(\mathbf{X}, t) \quad (15.6)$$

Because  $\partial/\partial t$  means to take the derivative with respect to time, while holding the other arguments, i.e.  $\mathbf{X}$ , fixed, (15.6) gives an expression for the velocity of the particle that was located at  $\mathbf{X}$  at time  $t_0$ . (Note that this particle is not now, at time  $t$ , located at  $\mathbf{X}$ .) Thus, (15.6) is the Lagrangian description of the velocity. To get the Eulerian description, substitute (15.4) into the argument of  $\mathbf{v}$

$$\mathbf{v} = \frac{\partial \mathbf{f}}{\partial t} [\mathbf{F}(\mathbf{x}, t), t] = \frac{\partial \mathbf{f}}{\partial t}(\mathbf{x}, t) \Big|_{\mathbf{x}=\mathbf{f}(\mathbf{X}, t)} = \mathbf{v}(\mathbf{x}, t) \quad (15.7)$$

Now, consider any scalar property  $\theta$ , e.g. temperature, density. The Eulerian description is

$$\theta = \theta(\mathbf{x}, t) \quad (15.8)$$

and the Lagrangian description is

$$\Theta = \Theta(\mathbf{X}, t) \quad (15.9)$$

The derivative (15.8)

$$\frac{\partial \theta}{\partial t} \Big|_{\mathbf{x} \text{ fixed}} \quad (15.10)$$

gives the rate of change of  $\theta$  at a fixed location in space. This is *not* the rate-of-change of  $\theta$  of any material particle because different particles occupy the location  $\mathbf{x}$  at time  $t$ . The derivative of (15.9)

$$\frac{\partial \Theta}{\partial t} \Big|_{\mathbf{X} \text{ fixed}} \quad (15.11)$$

does give the rate of change of  $\Theta$  for a specific material particle.

Can we compute the rate-of-change of  $\Theta$  for a material particle if we are given only  $\theta(\mathbf{x}, t)$ ? Mathematically, this can be expressed as follows:

$$\frac{\partial \Theta}{\partial t}(\mathbf{X}, t) = \frac{d\theta}{dt} \Big|_{\mathbf{x}=\text{fixed}} \quad (15.12)$$

where these two expressions must be equal if they are evaluated for the same particle at the same time. Because the right hand side is evaluated for fixed  $\mathbf{X}$ , the location of the particle,  $\mathbf{x}$ , changes with time. Therefore, by the chain rule of differentiation

$$\frac{\partial \theta}{\partial t} = \frac{\partial \theta}{\partial t}(\mathbf{x}, t) \Big|_{\mathbf{x} \text{ fixed}} + \frac{\partial \theta}{\partial x_i} \frac{\partial x_i}{\partial t} \quad (15.13)$$

Note that  $\partial x_i / \partial t$  is the component form of the velocity of a particle and  $\partial \theta / \partial x_i$  are the components of the gradient. Thus

$$\frac{d\theta}{dt} = \left. \frac{d\theta}{dt} \right|_{\mathbf{x} \text{ fixed}} = \left. \frac{\partial \theta}{\partial t} \right|_{\mathbf{x} \text{ fixed}} + \mathbf{v}(\mathbf{x}, t) \cdot \nabla_{\mathbf{x}} \theta \quad (15.14)$$

gives the rate-of-change of  $\theta$  following a material particle or the “material derivative.” Because holding  $\mathbf{x}$  fixed in the first term on the right corresponds to the usual meaning of the partial derivative, this notation is usually omitted.

Similarly, the rate of change can also be computed for a vector property  $\boldsymbol{\mu}(\mathbf{x}, t)$ :

$$\frac{d\boldsymbol{\mu}}{dt}(\mathbf{x}, t) = \left( \left. \frac{\partial \boldsymbol{\mu}}{\partial t} \right|_{\mathbf{x} \text{ fixed}} + \mathbf{v} \cdot (\nabla \boldsymbol{\mu}) \right) \quad (15.15)$$

If  $\boldsymbol{\mu} = \mathbf{v}$ , the velocity, then the material derivative gives the acceleration

$$\mathbf{a}(\mathbf{x}, t) = \frac{d\mathbf{v}}{dt}(\mathbf{x}, t) = \frac{\partial \mathbf{v}}{\partial t} + \mathbf{v} \cdot \nabla \mathbf{v} \quad (15.16)$$

The Lagrangian description of the acceleration is

$$\mathbf{A}(\mathbf{X}, t) = \frac{\partial \mathbf{v}(\mathbf{X}, t)}{\partial t} \quad (15.17)$$

The example of flow of an incompressible fluid down a converging channel illustrates the difference between the material derivative  $d/dt$  and  $\partial/\partial t$ . In the first example, Figure 15.2, the flow is steady. Consequently,  $\partial \mathbf{v} / \partial t = 0$  because the velocity does not change at any fixed location. But the acceleration  $d\mathbf{v} / dt \neq 0$  because material particles increase their velocity as they move down the channel. In the second example, Figure 15.3, the fluid is initially at rest. Then the fan is turned on. Consequently, velocity of (different) particles passing a fixed location changes with time,  $\partial \mathbf{v} / \partial t \neq 0$ .

When does  $\partial \theta / \partial t = d\theta / dt$  for a property  $\theta$ ? This will be true if the second term in (15.14) vanishes

$$\mathbf{v} \cdot \nabla \theta = 0 \quad (15.18)$$

There are three possibilities. If  $\mathbf{v} = 0$  so that there is no motion. If  $\nabla \theta = 0$  so that  $\theta$  is spatially uniform. The third is  $\mathbf{v}$  is perpendicular to  $\nabla \theta$ .

## 15.1 Additional Reading

Malvern, Sec. 4.3, pp. 138-145; Chadwick, Sec. 2.1-2.1, pp. 50-57; Aris, 4.11-4.13; Reddy, Sec. 3.2.

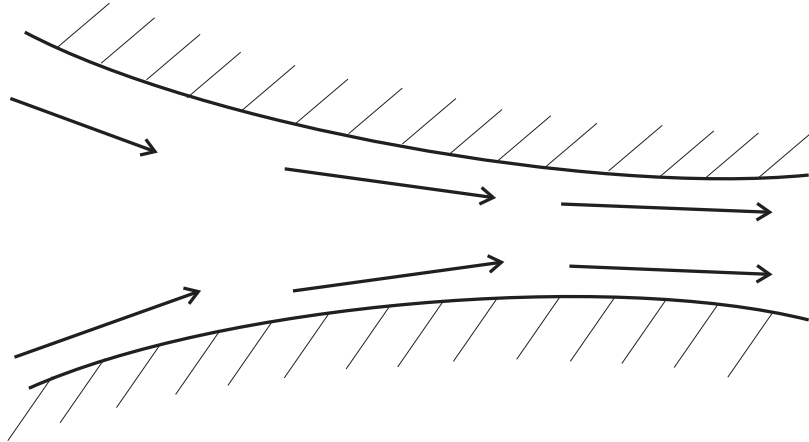

Figure 15.2: Example of steady flow down a converging channel. Because the flow is steady, the velocity does not change at any fixed location,  $\partial \mathbf{v} / \partial t = 0$ . But, because particles increase their velocity as they move down the channel the acceleration is nonzero.

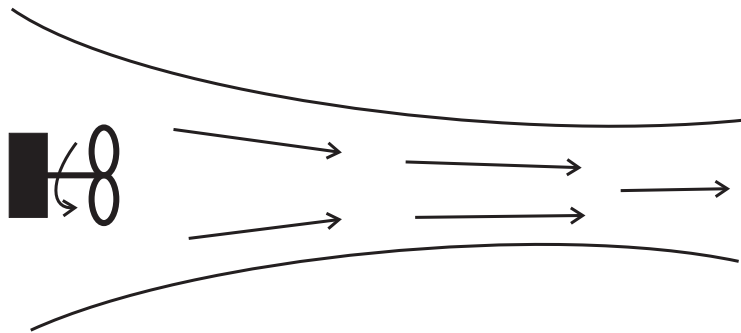

Figure 15.3: In this example, the material is initially at rest and then the fan is turned on. Consequently, the velocity is changing at fixed spatial locations and  $\partial \mathbf{v} / \partial t \neq 0$ .





# Chapter 16

## Rate of Deformation

### 16.1 Velocity gradients

In some cases, the reference configuration is not of interest. We are not interested in the location of particles at some past time, but only the instantaneous velocity field. For example, in the flow of a fluid, a configuration at a past time is generally not useful (or even possible to identify). Consider a velocity field  $\mathbf{v}(\mathbf{x})$  as shown in Figure 16.1. Although the particles were at points  $P$  and  $Q$  in the reference configuration, we are interested only in the instantaneous velocities of these points at their current locations  $p$  and  $q$ . The difference between the velocities of a particle located at  $\mathbf{x}$  and a particle located at  $\mathbf{x} + d\mathbf{x}$  at the current time is

$$d\mathbf{v} = \mathbf{v}(\mathbf{x} + d\mathbf{x}) - \mathbf{v}(\mathbf{x}) \quad (16.1)$$

or, in component form

$$dv_k = v_k(\mathbf{x} + d\mathbf{x}) - v_k(\mathbf{x}) \quad (16.2a)$$

$$= \frac{\partial v_k}{\partial x_l} dx_l \quad (16.2b)$$

The second line in (16.2b) can be rationalized by expanding  $v_k(\mathbf{x} + d\mathbf{x})$  in a Taylor series and retaining only first terms (as we did earlier in defining the gradient operator). We can write this result in coordinate-free form as

$$d\mathbf{v} = \mathbf{L} \cdot d\mathbf{x} = d\mathbf{x} \cdot \mathbf{L}^T \quad (16.3)$$

where

$$\mathbf{L} = \mathbf{v}\nabla = (\nabla\mathbf{v})^T \quad (16.4)$$

and is given in component form by

$$L_{kl} = \frac{\partial v_k}{\partial x_l} = v_{k,l} \quad (16.5)$$

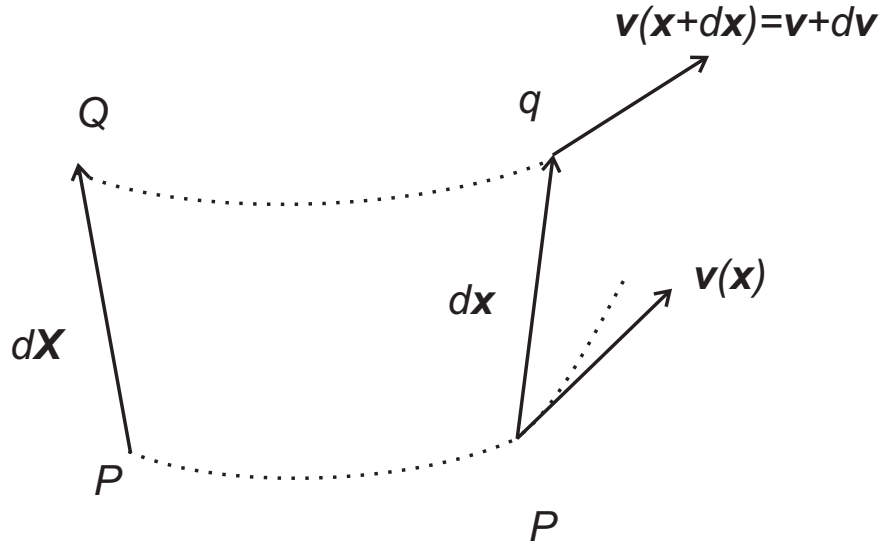

Figure 16.1: Illustration of the velocity difference at points  $p$  and  $q$  in the current configuration that are separated by an infinitesimal distance  $d\mathbf{x}$ .

$\mathbf{L}$  is the (spatial) velocity gradient tensor. The expression after the first equality sign in (16.4) is meant to keep the subscripts in the proper order for the cartesian component form in (16.5) (important because  $\mathbf{L}$  is, in general, not symmetric). This notation is, however, awkward in that the gradient operator acts on the velocity vector to the left. Malvern emphasizes this by putting an arrow to the left above the gradient operator but this is a cumbersome notation. The symmetric part of  $\mathbf{L}$

$$\mathbf{D} = \frac{1}{2}(\mathbf{L} + \mathbf{L}^T) \quad (16.6)$$

is the rate-of-deformation tensor and the anti- or skew symmetric part of  $\mathbf{L}$

$$\mathbf{W} = \frac{1}{2}(\mathbf{L} - \mathbf{L}^T) \quad (16.7)$$

is the spin tensor or vorticity tensor

## 16.2 Meaning of $\mathbf{D}$

The meaning of  $\mathbf{D}$  can be established by considering the rate-of-change of the length of an infinitesimal line segment  $d\mathbf{x}$ . The length squared is given by

$$ds^2 = d\mathbf{x} \cdot d\mathbf{x} \quad (16.8)$$

Differentiating with respect to time gives

$$2ds \frac{d}{dt}(ds) = d\mathbf{v} \cdot d\mathbf{x} + d\mathbf{x} \cdot d\mathbf{v} \quad (16.9)$$

where we have used

$$\frac{d}{dt}(d\mathbf{x}) = d\mathbf{v} \quad (16.10)$$

Using (16.3) gives

$$= d\mathbf{x} \cdot \mathbf{L}^T \cdot d\mathbf{x} + d\mathbf{x} \cdot \mathbf{L} \cdot d\mathbf{x} \quad (16.11a)$$

$$= 2d\mathbf{x} \cdot \mathbf{D} \cdot d\mathbf{x} \quad (16.11b)$$

Dividing through by  $2ds^2$  yields

$$\frac{1}{ds} \frac{d}{dt}(ds) = \frac{d}{dt} \ln(ds) = \mathbf{n} \cdot \mathbf{D} \cdot \mathbf{n} \quad (16.12)$$

Thus,  $\mathbf{n} \cdot \mathbf{D} \cdot \mathbf{n}$  is the fractional rate-of-extension in direction  $\mathbf{n} = d\mathbf{x}/ds$ . Normal components of  $\mathbf{D}$  give the fractional rates-of-extension of line segments in the coordinate directions. Since  $\mathbf{D}$  is a symmetric tensor, it has three real principal values with orthogonal principal directions. The same derivation used for the stress tensor demonstrates that these principal values are stationary values of  $\mathbf{n} \cdot \mathbf{D} \cdot \mathbf{n}$  over all orientations.

To investigate the meaning of the off-diagonal components of  $\mathbf{D}$  consider the rate-of-change of the scalar product between two infinitesimal line segments  $d\mathbf{x}_A$  and  $d\mathbf{x}_B$

$$d\mathbf{x}_A \cdot d\mathbf{x}_B = ds_A ds_B \cos \theta \quad (16.13)$$

where  $ds_A$  and  $ds_B$  are the lengths of  $d\mathbf{x}_A$  and  $d\mathbf{x}_B$ , respectively, and  $\theta$  is the angle between them. Taking the time-derivative of both sides

$$\frac{d}{dt}(d\mathbf{x}_A d\mathbf{x}_B) = \frac{d}{dt}(ds_A ds_B \cos \theta) \quad (16.14)$$

gives

$$d\mathbf{v}_A \cdot d\mathbf{x}_B + d\mathbf{x}_A \cdot d\mathbf{v}_B = \frac{d}{dt}(ds_A) ds_B \cos \theta + ds_A \frac{d}{dt}(ds_B) \cos \theta - ds_A ds_B \sin \theta \dot{\theta} \quad (16.15)$$

Using (16.3) and regrouping yields

$$2 \frac{d\mathbf{x}_A}{ds_A} \cdot \mathbf{D} \cdot \frac{d\mathbf{x}_B}{ds_B} = \left\{ \frac{1}{ds_A} \frac{d}{dt}(ds_A) + \frac{1}{ds_B} \frac{d}{dt}(ds_B) \right\} \cos \theta - \sin \theta \dot{\theta} \quad (16.16)$$

When  $\theta = 90^\circ$ , the line segments are orthogonal and (16.16) reduces to

$$\mathbf{n}_A \cdot \mathbf{D} \cdot \mathbf{n}_B = -\frac{1}{2} \dot{\theta} \quad (16.17)$$

Thus, the off-diagonal components give half the rate-of-decrease of the angle between linear segments aligned with the coordinate directions.

### 16.3 Meaning of $\mathbf{W}$

Since  $\mathbf{W}$  is an anti-(or skew) symmetric tensor,  $\mathbf{W} = -\mathbf{W}^T$ , it has only three distinct components. These components can be associated with a vector  $\mathbf{w}$  by means of the following operation:

$$\mathbf{W} \cdot \mathbf{a} = \mathbf{w} \times \mathbf{a} \quad (16.18)$$

where  $\mathbf{a}$  is an arbitrary vector. The vector  $\mathbf{w}$  is called the dual or polar vector (of a skew symmetric tensor). To determine an expression for the components of  $\mathbf{w}$  write (16.18) in component form:

$$W_{in}a_n = \epsilon_{imn}w_m a_n \quad (16.19)$$

Because this relation must apply for any vector  $\mathbf{a}$

$$W_{ij} = \epsilon_{imj}w_m$$

Multiplying and summing both sides with  $\epsilon_{ipq}$  and using the  $\epsilon - \delta$  identity yields

$$\epsilon_{ijq}W_{ij} = \epsilon_{ijq}\epsilon_{imj}w_m \quad (16.20a)$$

$$= -2w_q \quad (16.20b)$$

or

$$w_q = -\frac{1}{2}\epsilon_{qip}W_{ip} \quad (16.21)$$

The polar vector can be related to the velocity field by substituting the component form of  $\mathbf{W}$  into (16.21)

$$w_i = -\frac{1}{2}\epsilon_{ijk}\frac{1}{2}\left(\frac{\partial v_j}{\partial x_k} - \frac{\partial v_k}{\partial x_j}\right) \quad (16.22a)$$

$$= -\frac{1}{4}\epsilon_{ijk}\partial_k v_j + \frac{1}{4}\epsilon_{ijk}\partial_j v_k \quad (16.22b)$$

$$= \frac{1}{2}\epsilon_{ijk}\partial_j v_k \quad (16.22c)$$

$$\mathbf{w} = \frac{1}{2}(\nabla \times \mathbf{v}) \quad (16.22d)$$

The right side of (16.22d) is called the *vorticity*. If  $\mathbf{w} = 0$ , so does the vorticity and the velocity field is said to be *irrotational*. Because

$$\nabla \times \nabla \phi = 0 \quad (16.23)$$

for any scalar field  $\phi$ , if the velocity field is irrotational, the velocity vector can be represented as the gradient of a scalar field, i.e.,  $\mathbf{v} = \nabla \phi$ .

Now, suppose  $\mathbf{D} \equiv 0$ . Then

$$d\mathbf{v} = \mathbf{W} \cdot d\mathbf{x} \quad (16.24)$$

or, in component form,

$$dv_p = W_{pq}dx_q \quad (16.25a)$$

$$= \epsilon_{iqp}w_i dx_q = \epsilon_{piq}w_i dx_q \quad (16.25b)$$

$$d\mathbf{v} = \mathbf{w} \times d\mathbf{x} \quad (16.25c)$$

Hence, local velocity increment is a rigid spin with angular velocity  $\mathbf{w}$ .

## 16.4 Additional Reading

Malvern, Sec. 4.4, pp. 145-154; Chadwick, Sec. 2.3, pp. 58-67; Aris, 4.41-4.5; Reddy, 3.6.1.



## Chapter 17

# Geometric Measures of Deformation

In the preceding chapter we were concerned only with the instantaneous rate-of-deformation and spin in the current configuration. Now we want to compare the geometry in the current configuration with that in the reference configuration.

### 17.1 Deformation Gradient

As indicated in Figure 17.1, an infinitesimal line segment in the reference configuration  $d\mathbf{X}$  is mapped into an infinitesimal line segment in the current configuration  $d\mathbf{x}$  by

$$dx_k = \frac{\partial x_k}{\partial X_m} dX_m \quad (17.1)$$

where  $\partial x_k / \partial X_m$  are components of the *deformation gradient tensor*:

$$F_{km} = \frac{\partial x_k}{\partial X_m}(\mathbf{X}) \quad (17.2)$$

In coordinate-free notation

$$d\mathbf{x} = \mathbf{F} \cdot d\mathbf{X} = d\mathbf{X} \cdot \mathbf{F}^T \quad (17.3)$$

The tensor  $\mathbf{F}$  contains all information about the geometry of deformation.

### 17.2 Change in Length of Lines

The square of the length of an infinitesimal line segment  $d\mathbf{x}$  in the current configuration is given by its scalar product with itself:

$$(ds)^2 = d\mathbf{x} \cdot d\mathbf{x} = (d\mathbf{X} \cdot \mathbf{F}^T) \cdot (\mathbf{F} \cdot d\mathbf{X}) \quad (17.4a)$$

$$= d\mathbf{X} \cdot (\mathbf{F}^T \cdot \mathbf{F}) \cdot d\mathbf{X} \quad (17.4b)$$

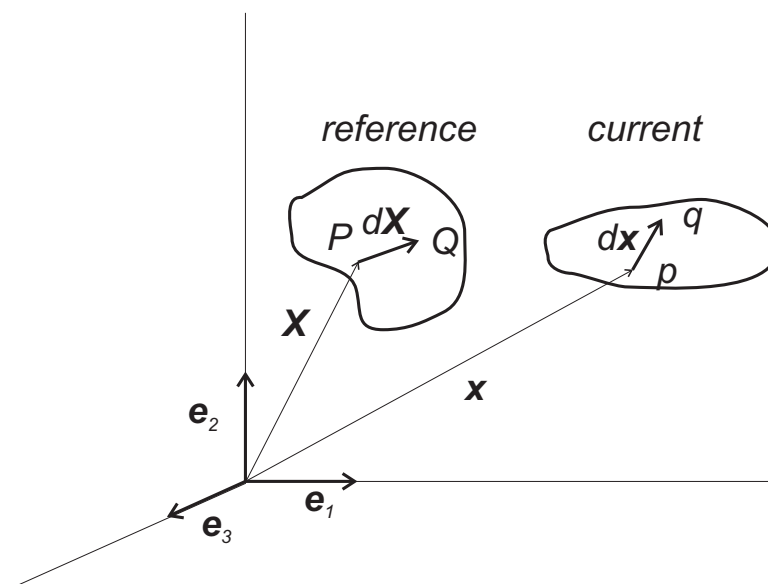

Figure 17.1: Infinitesimal line segments in the reference and current configurations.

$\mathbf{N} = d\mathbf{X}/dS$  is a unit vector in the direction of the infinitesimal line segment  $d\mathbf{X}$  in the reference configuration. Now (17.4b) can be written as

$$\left(\frac{ds}{dS}\right)^2 = \mathbf{N} \cdot (\mathbf{F}^T \cdot \mathbf{F}) \cdot \mathbf{N} \quad (17.5)$$

where

$$dS = (d\mathbf{X} \cdot d\mathbf{X})^{\frac{1}{2}} \quad (17.6)$$

is the length of the line segment in the reference configuration. The ratio

$$\frac{ds}{dS} = \Lambda(\mathbf{N}) \quad (17.7)$$

defines the *stretch ratio*. The tensor

$$\mathbf{C} = \mathbf{F}^T \cdot \mathbf{F} \quad (17.8)$$

is called the *Green deformation tensor* (Malvern) or the *right Cauchy-Green tensor* (Truesdell & Noll). Note that  $\mathbf{C}$  is symmetric:

$$\mathbf{C}^T = (\mathbf{F}^T \cdot \mathbf{F})^T = \mathbf{F}^T \cdot \mathbf{F}^{TT} = \mathbf{F}^T \cdot \mathbf{F} = \mathbf{C} \quad (17.9)$$



Because each line segment in the current configuration must originate from a line segment in the reference configuration, the tensor  $\mathbf{F}$  possesses an inverse:

$$d\mathbf{X} = \mathbf{F}^{-1} \cdot d\mathbf{x} = d\mathbf{x} \cdot \mathbf{F}^{-1T} \quad (17.10)$$

Consequently, it is possible to calculate the reciprocal of the ratio (17.5) in terms of  $\mathbf{F}^{-1}$ :

$$(dS)^2 = d\mathbf{X} \cdot d\mathbf{X} = d\mathbf{x} \cdot (\mathbf{F}^{-1T} \cdot \mathbf{F}^{-1}) \cdot d\mathbf{x} \quad (17.11)$$

or

$$\left(\frac{dS}{ds}\right)^2 = \mathbf{n} \cdot (\mathbf{F}^{-1T} \cdot \mathbf{F}^{-1}) \cdot \mathbf{n} \quad (17.12)$$

where  $\mathbf{n} = d\mathbf{x}/ds$  is a unit vector in the direction of the line segment in the current configuration. The inverse of the tensor

$$\mathbf{B} = \mathbf{F} \cdot \mathbf{F}^T \quad (17.13)$$

is equal to the product in parentheses on the right side of (17.12). The tensor  $\mathbf{B}^{-1} = (\mathbf{F}^{-1T} \cdot \mathbf{F}^{-1})$  (often denoted  $\mathbf{c}$ ) is called the *Cauchy deformation tensor* by Malvern. Its inverse  $\mathbf{B}$  is called the *left Cauchy-Green tensor* by Truesdell and Noll.

The stretch ratio (17.7) can be expressed as

$$\Lambda = \frac{ds}{dS} = \sqrt{\mathbf{N} \cdot \mathbf{C} \cdot \mathbf{N}} \quad (17.14)$$

Because  $\mathbf{C}$  is symmetric and positive definite, it possesses three real positive principal values, which are *squares* of the principal stretch ratios,  $\Lambda_I$ ,  $\Lambda_{II}$ ,  $\Lambda_{III}$ , with corresponding principal directions  $\mathbf{N}_I$ ,  $\mathbf{N}_{II}$ ,  $\mathbf{N}_{III}$ . As shown earlier, the principal stretches include the largest and smallest values of the stretch ratio. Thus,  $\mathbf{C}$  has the principal axes representation

$$\mathbf{C} = \Lambda_I^2 \mathbf{N}_I \mathbf{N}_I + \Lambda_{II}^2 \mathbf{N}_{II} \mathbf{N}_{II} + \Lambda_{III}^2 \mathbf{N}_{III} \mathbf{N}_{III} \quad (17.15)$$

### 17.3 Change in Angles

The angle  $\theta$  between two line segments  $d\mathbf{x}_A$  and  $d\mathbf{x}_B$  in the current configuration is given by

$$\cos \theta = \frac{d\mathbf{x}_A \cdot d\mathbf{x}_B}{|d\mathbf{x}_A| |d\mathbf{x}_B|} \quad (17.16a)$$

$$= \frac{d\mathbf{X}_A \cdot \mathbf{F}^T \cdot \mathbf{F} \cdot d\mathbf{X}_B}{\sqrt{d\mathbf{X}_A \cdot \mathbf{F}^T \cdot \mathbf{F} \cdot d\mathbf{X}_A} \sqrt{d\mathbf{X}_B \cdot (\mathbf{F}^T \cdot \mathbf{F}) \cdot d\mathbf{X}_B}} \quad (17.16b)$$

$$= \frac{\mathbf{N}_A \cdot \mathbf{C} \cdot \mathbf{N}_B}{(\mathbf{N}_A \cdot \mathbf{C} \cdot \mathbf{N}_A)^{\frac{1}{2}} (\mathbf{N}_B \cdot \mathbf{C} \cdot \mathbf{N}_B)^{\frac{1}{2}}} \quad (17.16c)$$

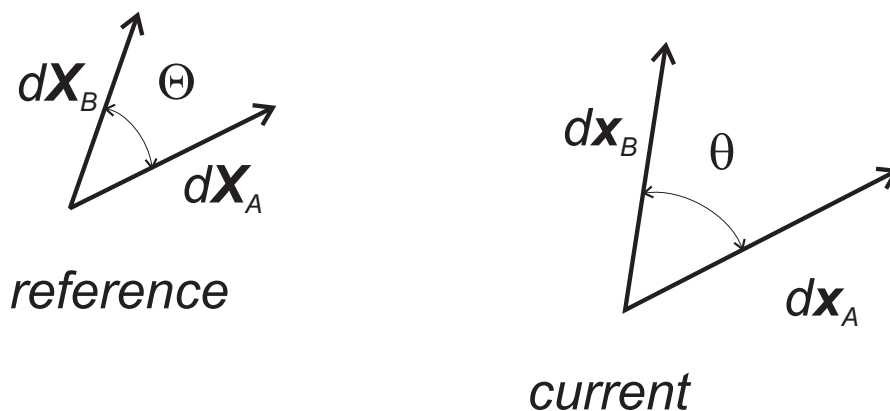

Figure 17.2: Angle  $\Theta$  between two infinitesimal line segments in the reference configuration changes to  $\theta$  in the current configuration.

The terms in the denominator of (17.16c) are the stretch ratios in the directions  $\mathbf{N}_A$  and  $\mathbf{N}_B$ . Define the *shear* as the change in angle between line segments in the directions  $\mathbf{N}_A, \mathbf{N}_B$  in the reference configuration.

$$\gamma(\mathbf{N}_A, \mathbf{N}_B) = \Theta - \theta \quad (17.17)$$

where

$$\cos \Theta = \mathbf{N}_A \cdot \mathbf{N}_B \quad (17.18)$$

Using (17.16c), this gives

$$\cos(\Theta - \gamma) = \frac{\mathbf{N}_A \cdot \mathbf{C} \cdot \mathbf{N}_B}{\sqrt{\mathbf{N}_A \cdot \mathbf{C} \cdot \mathbf{N}_A} \sqrt{\mathbf{N}_B \cdot \mathbf{C} \cdot \mathbf{N}_B}} \quad (17.19)$$

In the special case,  $\Theta = 90^\circ$ ,  $\cos(90^\circ - \gamma) = \sin \gamma$ . Note that if  $\mathbf{N}_A$  and  $\mathbf{N}_B$  are principal directions,  $\gamma = 0$  (because  $\mathbf{N}_A \cdot \mathbf{C} \cdot \mathbf{N}_B = \Lambda^2 \mathbf{N}_B \cdot \mathbf{N}_A = 0$ ). Therefore principal directions in the reference configuration deform into principal directions in the current configuration.

## 17.4 Change in Area

An oriented element of area in the reference configuration is given by

$$\mathbf{N}dA = d\mathbf{X}_A \times d\mathbf{X}_B \quad (17.20a)$$

$$= \mathbf{e}_i \epsilon_{ijk} (dX_A)_j (dX_B)_k \quad (17.20b)$$

and is deformed into

$$\mathbf{n}da = d\mathbf{x}_A \times d\mathbf{x}_B \quad (17.21)$$

in the current configuration. Substituting (17.3) into the component form of (17.21)

$$n_i da = \epsilon_{ijk}(dx_A)_j(dx_B)_k \quad (17.22a)$$

yields

$$n_i da = \epsilon_{ijk} [F_{jr}(dX_A)_r] [F_{ks}(dX_B)_s]$$

Multiplying both sides by  $F_{it}$  then gives

$$n_i F_{it} da = [\epsilon_{ijk} F_{it} F_{jr} F_{ks}] (dX_A)_r (dX_B)_s \quad (17.23)$$

The term in square brackets can be written in terms of the determinant of  $\mathbf{F}$  (7.16). The result is

$$n_i da = \epsilon_{rst} \det(\mathbf{F}) F_{it} (dX_A)_r (dX_B)_s \quad (17.24)$$

Reverting back to coordinate free notation gives

$$\mathbf{n} \cdot \mathbf{F} da = \det(\mathbf{F}) d\mathbf{X}_A \times d\mathbf{X}_B \quad (17.25a)$$

$$= \det(\mathbf{F}) \mathbf{N} dA \quad (17.25b)$$

and then multiplying (from the right) by  $\mathbf{F}^{-1}$  gives *Nanson's formula*

$$\mathbf{n} da = \det(\mathbf{F}) (\mathbf{N} \cdot \mathbf{F}^{-1}) dA \quad (17.26)$$

## 17.5 Change in Volume

An element of volume in the reference configuration is given by the scalar triple product of three line segments  $d\mathbf{X}_A$ ,  $d\mathbf{X}_B$ , and  $d\mathbf{X}_C$

$$dV = d\mathbf{X}_A \cdot (d\mathbf{X}_B \times d\mathbf{X}_C) = \epsilon_{ijk} (dX_A)_i (dX_B)_j (dX_C)_k \quad (17.27)$$

Similarly, an element of volume in the current configuration is

$$dv = d\mathbf{x}_A \cdot (d\mathbf{x}_B \times d\mathbf{x}_C) = \epsilon_{rst} (dx_A)_r (dx_B)_s (dx_C)_t \quad (17.28)$$

Substituting (17.3) gives

$$\begin{aligned} dv &= \epsilon_{rst} F_{ri} (dX_A)_i F_{sj} (dX_B)_j F_{tk} (dX_C)_k \\ &= \epsilon_{rst} F_{ri} F_{sj} F_{tk} (dX_A)_i (dX_B)_j (dX_C)_k \end{aligned}$$

Again using (7.16) gives

$$\begin{aligned} dv &= \det(\mathbf{F}) \epsilon_{ijk} (dX_A)_i (dX_B)_j (dX_C)_k \\ &= \det(\mathbf{F}) d\mathbf{X}_A \cdot (d\mathbf{X}_B \times d\mathbf{X}_C) \end{aligned}$$

Hence,

$$\frac{dv}{dV} = \det(\mathbf{F}) \quad (17.29)$$

or

$$\frac{\rho_o}{\rho} = \det(\mathbf{F}) \quad (17.30)$$

## **17.6 Additional Reading**

Malvern, 4.5, pp. 154-157, pp. 164-170; Chadwick, Chapter 2, Sec. 3; Reddy, 3.3, 3.4.1.

## Chapter 18

# Polar Decomposition

In the discussion of shear and angle change, we noted that a triad in the directions of principal stretches remains orthogonal after deformation. That is, the shear is zero for two lines in the principal directions in the reference configuration. Consequently, we can imagine the deformation to occur in the two steps shown schematically in Figure 18.1: First a pure deformation that stretches line elements in the principal directions to their final length; then a rotation that orients these line elements in the proper directions in the current configuration.

The deformation is given by

$$d\mathbf{x}' = \mathbf{U} \cdot d\mathbf{x} \quad (18.1)$$

Because  $\mathbf{U}$  is the tensor that stretches line elements in the principal directions, it has the same principal directions as  $\mathbf{C}$  and has principal values that are equal to the principal stretch ratios. Hence, the principal axis representation of  $\mathbf{U}$  is

$$\mathbf{U} = \Lambda_I \mathbf{N}_I \mathbf{N}_I + \Lambda_{II} \mathbf{N}_{II} \mathbf{N}_{II} + \Lambda_{III} \mathbf{N}_{III} \mathbf{N}_{III} \quad (18.2)$$

where  $\mathbf{U} = \mathbf{U}^T$ . Note that in general  $\mathbf{U}$  will cause changes in the angles between lines that are not oriented in the principal directions.

Then the principal directions in the reference configuration are rotated into their proper orientation in the current configuration:

$$d\mathbf{x} = \mathbf{R} \cdot d\mathbf{x}' \quad (18.3)$$

If  $\mathbf{R}$  is an orthogonal tensor corresponding to a pure rotation, the lengths of line segments will be preserved. Thus,

$$d\mathbf{x} \cdot d\mathbf{x} = d\mathbf{x}' \cdot d\mathbf{x}' \quad (18.4a)$$

$$= d\mathbf{x}' \cdot \mathbf{R}^T \cdot \mathbf{R} \cdot d\mathbf{x}' \quad (18.4b)$$

Therefore

$$\mathbf{R}^T \cdot \mathbf{R} = \mathbf{I} \quad (18.5)$$

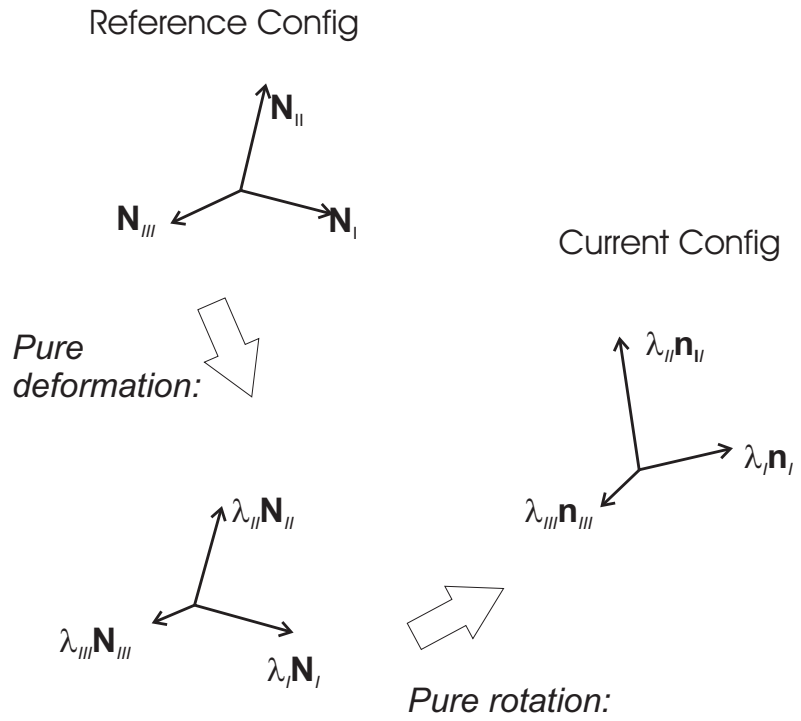

Figure 18.1: Illustration of the polar decomposition of deformation into a pure stretching and a pure rotation.

and  $\mathbf{R}$  is an orthogonal tensor, i.e.,

$$\mathbf{R}^{-1} = \mathbf{R}^T \quad (18.6a)$$

Combining (18.1) and (18.3) yields

$$d\mathbf{x} = \mathbf{F} \cdot d\mathbf{X} = (\mathbf{R} \cdot \mathbf{U}) \cdot d\mathbf{X} \quad (18.7)$$

Thus, the deformation tensor is decomposed into the product of a deformation tensor and a rotation tensor:

$$\mathbf{F} = \mathbf{R} \cdot \mathbf{U} \quad (18.8)$$

Substituting (18.8) into the expression for the Green deformation tensor (17.8) gives

$$\mathbf{C} = \mathbf{F}^T \cdot \mathbf{F} = (\mathbf{R} \cdot \mathbf{U})^T \cdot (\mathbf{R} \cdot \mathbf{U}) \quad (18.9a)$$

$$= \mathbf{U}^T \cdot \mathbf{R}^T \cdot \mathbf{R} \cdot \mathbf{U} = \mathbf{U}^T \cdot \mathbf{U} = \mathbf{U}^2 \quad (18.9b)$$

Formally, we can write  $\mathbf{U} = \sqrt{\mathbf{C}}$ , but this operation can be carried out only in principal axis form. In order to calculate the components of  $\mathbf{U}$  from  $\mathbf{C}$  it is necessary to express  $\mathbf{C}$  in principal axis form, take the square roots of the principal values, then convert back to the coordinate system of interest.

Alternatively, we could have rotated first, then stretched. This leads to

$$d\mathbf{x} = \mathbf{V} \cdot \mathbf{R} \cdot d\mathbf{X} \quad (18.10)$$

where

$$\mathbf{V} = \lambda_I \mathbf{n}_I \mathbf{n}_I + \lambda_{II} \mathbf{n}_{II} \mathbf{n}_{II} + \lambda_{III} \mathbf{n}_{III} \mathbf{n}_{III} \quad (18.11)$$

and

$$\mathbf{n}_K = \mathbf{R} \cdot \mathbf{N}_K \quad (18.12)$$

Thus, the rotation tensor is given by dyad

$$\mathbf{R} = \mathbf{n}_K \mathbf{N}_K \quad (18.13)$$

and  $\mathbf{U}$  and  $\mathbf{V}$  are related by

$$\mathbf{V} = \mathbf{R} \cdot \mathbf{U} \cdot \mathbf{R}^T \quad (18.14)$$

Thus,  $\mathbf{U}$  and  $\mathbf{V}$  have the same principal values but their principal directions are related by the rotation tensor  $\mathbf{R}$ .





# Chapter 19

## Strain Tensors

### 19.1 Material Strain Tensors

A material strain tensor is defined by the following requirements

1. Has the same principal axes as  $\mathbf{U}$ ;
2. Vanishes when the principal stretch ratios are unity;
3. Agrees with the small strain tensor.

The first requirement constrains a material strain tensor to have the form

$$\mathbf{E} = f(\Lambda_I)\mathbf{N}_I\mathbf{N}_I + f(\Lambda_{II})\mathbf{N}_{II}\mathbf{N}_{II} + f(\Lambda_{III})\mathbf{N}_{III}\mathbf{N}_{III} \quad (19.1)$$

where the  $\mathbf{N}_K$  are the principal directions of  $\mathbf{U}$ , the  $\Lambda_K$  are the principal stretch ratios (the square root of the principal values of  $\mathbf{C}$ ) and  $f(\Lambda)$  is a smooth and monotonic, but otherwise arbitrary, function. By construction, a material strain tensor is symmetric,  $\mathbf{E} = \mathbf{E}^T$ . The second requirement restricts the value of  $f(1) = 0$  so that  $\mathbf{E} = 0$  when  $\mathbf{U} = \mathbf{I}$ . The last requires  $f'(1) = 1$  so that  $\mathbf{E}$  agrees with the small strain tensor. To demonstrate this, expand  $f(\Lambda)$  about  $\Lambda = 1$ :

$$f(\Lambda) = f(1) + f'(1)(\Lambda - 1) + \frac{1}{2}f''(1)(\Lambda - 1)^2 \dots \quad (19.2)$$

Thus, the principal values of  $\mathbf{E}$  reduce to change in length per unit (reference) length for principal stretches near unity.

The most common choice for the scale function  $f(\Lambda)$  is

$$f(\Lambda) = \frac{1}{2}(\Lambda^2 - 1) \quad (19.3)$$

Substituting (19.3) into (19.1) and combining terms defines the *Green (Lagrangian)* strain tensor

$$\mathbf{E}^G = \frac{1}{2}(\mathbf{U}^2 - \mathbf{I}) \quad (19.4)$$

This is a convenient choice because  $\mathbf{U}^2$  can be calculated directly from the deformation tensor  $\mathbf{F}$

$$\mathbf{E}^G = \frac{1}{2}(\mathbf{F}^T \cdot \mathbf{F} - \mathbf{I}) \quad (19.5)$$

Determining  $\mathbf{U}$  (or any odd power of  $\mathbf{U}$ ) requires first finding the principal values and directions. For arbitrary stretch ratios, the normal components of the Green-Lagrange strain do not give change in length per unit reference length but, as indicated by (19.3) the current length squared minus the reference length squared divided by the reference length squared.

The component form of (19.5) is

$$E_{ij}^G = \frac{1}{2}(F_{ik}^T F_{kj} - \delta_{ij}) = \frac{1}{2}(F_{ki} F_{kj} - \delta_{ij}) \quad (19.6)$$

or using

$$F_{kl} = \frac{\partial x_k}{\partial X_l} \quad (19.7)$$

gives

$$E_{ij}^G = \frac{1}{2}\left(\frac{\partial x_k}{\partial X_i} \frac{\partial x_k}{\partial X_j} - \delta_{ij}\right) \quad (19.8)$$

$E_{ij}^G$  can be expressed in terms of the displacement components  $u_k$  by noting that  $x_k = X_k + u_k$

$$E_{ij}^G = \frac{1}{2}\left(\frac{\partial u_i}{\partial X_j} + \frac{\partial u_j}{\partial X_i} + \frac{\partial u_k}{\partial X_j} \frac{\partial u_k}{\partial X_i}\right) \quad (19.9)$$

Although the choice (19.3) is the most common choice for the scale function, there are many other possibilities. Perhaps the most obvious extension of small strain is to choose

$$f(\Lambda) = \Lambda - 1 = \frac{\text{change in length}}{\text{reference length}} \quad (19.10)$$

Using (19.1) to convert to tensor form yields

$$\mathbf{E}^{(1)} = \mathbf{U} - \mathbf{I}$$

This is a finite strain measure that was introduced and used by Biot, but has the drawback that it cannot be expressed directly in terms of  $\mathbf{F}$ .

Another possibility corresponds to defining normal strains as change in length per unit *current* length:

$$f(\Lambda) = 1 - \Lambda^{-1} = \frac{\text{change in length}}{\text{current length}} \quad (19.11a)$$

$$\Rightarrow \mathbf{E}^{(-1)} = \mathbf{I} - \mathbf{U}^{-1} \quad (19.11b)$$

Still another possibility is logarithmic strain, often thought to be the most appropriate large strain measure for uniaxial bar tests. This one-dimensional

measure can be extended to a tensor version in a manner similar to other finite strains:

$$f(\Lambda) = \ln \Lambda \quad (19.12)$$

This leads to

$$\mathbf{E}^{(\ln)} = \ln \mathbf{U}$$

Thus  $\mathbf{E}^{(\ln)}$  has the same principal directions as  $\mathbf{U}$  but principal values that are the logarithms of the principal stretches. (Note that for axes that are not aligned with the principal directions, the components of  $\mathbf{E}^{(\ln)}$  are not the logarithms of the components of  $\mathbf{U}$ ). Another expression for  $\mathbf{E}^{(\ln)}$  is obtained by using the series expansion for  $\ln \Lambda$

$$\ln \Lambda = \ln [1 + (\Lambda - 1)] = (\Lambda - 1) - \frac{1}{2}(\Lambda - 1)^2 + \frac{1}{3}(\Lambda - 1)^3 - \dots \quad (19.13)$$

Substituting into (19.1) to form the tensor gives

$$\begin{aligned} \mathbf{E}^{(\ln)} &= \ln \mathbf{U} \\ &= \ln(\Lambda_I)\mathbf{N}_I\mathbf{N}_I + \ln(\Lambda_{II})\mathbf{N}_{II}\mathbf{N}_{II} + \ln(\Lambda_{III})\mathbf{N}_{III}\mathbf{N}_{III} \\ &= \mathbf{U} - \mathbf{I} - \frac{1}{2}(\mathbf{U} - \mathbf{I})^2 + \dots \end{aligned}$$

Seth and Hill noted that all of these strain measures are included as special cases of one based on

$$f(\Lambda) = \frac{1}{m}(\Lambda^m - 1) \quad (19.14)$$

If  $m$  is even, the strain can be written directly in terms of the deformation gradient. The limit  $m \rightarrow 0$  yields the logarithmic strain measure.

### 19.1.1 Additional Reading

Malvern, pp. 158-161; Sec. 4.6, pp. 172-181; Chadwick, Chapter 1, Sec. 8, pp. 33-35; Chapter 2, Sec. 4, pp. 67-74; Reddy, 3.4.2 - 3.

## 19.2 Spatial Strain Measures

We can define a class of spatial strain measures in a manner analogous to the material strain measures. These are not, however, material strain measures in the sense that their rate does not vanish when the rate of deformation  $\mathbf{D}$  vanishes. Spatial strain measures have the following properties:

1. Same principal axes as  $\mathbf{V}$

$$\mathbf{e} = g(\lambda_I)\mathbf{n}_I\mathbf{n}_I + g(\lambda_{II})\mathbf{n}_{II}\mathbf{n}_{II} + g(\lambda_{III})\mathbf{n}_{III}\mathbf{n}_{III} \quad (19.15)$$

where here we use a lower case  $\lambda$  to indicate that we are working in the current configuration.

2. Vanish when all principal stretches are unity.

$$g(1) = 0 \tag{19.16}$$

3. Agree with small strain

$$g'(1) = 1 \tag{19.17}$$

Recall that

$$\mathbf{F} = \mathbf{R} \cdot \mathbf{U} = \mathbf{V} \cdot \mathbf{R} \tag{19.18}$$

and, hence,  $\mathbf{V}$  is related to  $\mathbf{U}$  by

$$\mathbf{V} = \mathbf{R} \cdot \mathbf{U} \cdot \mathbf{R}^T \tag{19.19}$$

The most commonly used spatial strain measure is the *Almansi strain* corresponding to the scale function

$$g(\lambda) = \frac{1}{2}(1 - \lambda^{-2}) \tag{19.20}$$

Converting to tensor form yields

$$\mathbf{E}^* = \frac{1}{2} \left\{ \mathbf{I} - \mathbf{V}^{(-1)T} \cdot \mathbf{V}^{-1} \right\} \tag{19.21}$$

To express  $\mathbf{E}^*$  in terms of the deformation gradient, note that

$$\mathbf{F}^{-1} = (\mathbf{V} \cdot \mathbf{R})^{-1} = \mathbf{R}^{-1} \cdot \mathbf{V}^{-1} = \mathbf{R}^T \cdot \mathbf{V}^{-1} \tag{19.22}$$

and therefore

$$\mathbf{V}^{-1} = \mathbf{R} \cdot \mathbf{F}^{-1} \tag{19.23}$$

Substituting into (19.21) yields

$$\mathbf{E}^* = \frac{1}{2} \left\{ \mathbf{I} - \mathbf{F}^{(-1)T} \cdot \mathbf{F}^{-1} \right\} \tag{19.24}$$

Expressing this in terms of cartesian components gives

$$E_{ij}^* = \frac{1}{2} \left\{ \delta_{ij} - F_{ik}^{-1T} F_{kj}^{-1} \right\} \tag{19.25}$$

$$= \frac{1}{2} \left\{ \delta_{ij} - F_{ki}^{-1} F_{kj}^{-1} \right\} \tag{19.26}$$

The components of  $\mathbf{E}^*$  can be expressed in terms of the displacements components by noting that

$$x_m = X_m + u_m \Rightarrow X_m = x_m - u_m \tag{19.27}$$

where now the displacements are regarded as functions of spatial position  $\mathbf{x}$  (Eulerian description) rather than position in the reference configuration  $\mathbf{X}$ . Hence, the components of  $\mathbf{F}^{-1}$  are

$$F_{mn}^{-1} = \frac{\partial X_m}{\partial x_n} \tag{19.28}$$

or, in terms of the displacements,

$$F_{mn}^{-1} = \delta_{mn} - \frac{\partial u_m}{\partial x_n} \quad (19.29)$$

Substituting into (19.26) yields

$$E_{ij}^* = \frac{1}{2} \left\{ \frac{\partial u_i}{\partial x_j} + \frac{\partial u_j}{\partial x_i} - \frac{\partial u_k}{\partial x_i} \frac{\partial u_k}{\partial x_j} \right\} \quad (19.30)$$

Comparing with the component expression for the Green-Lagrange strain (19.9), note the change in sign of the last term and that derivatives are with respect to position in the current configuration. Neglecting the last, nonlinear terms reduces to the expression for small strain in which the distinction between the current and reference positions is neglected. For comparison, the component form of the material strain based on the scale function  $f(\Lambda) = \frac{1}{2}(1 - \Lambda^{-2})$  is

$$E_{ij}^{(-2)} = \frac{1}{2} \left\{ \frac{\partial u_i}{\partial x_j} + \frac{\partial u_j}{\partial x_i} - \frac{\partial u_i}{\partial x_k} \frac{\partial u_j}{\partial x_k} \right\} \quad (19.31)$$

which differs from the Almansi strain (19.30) only in how the last term is summed. Similarly, the component form of the spatial strain measure based on  $g(\lambda) = \frac{1}{2}(\lambda^{-2} - 1)$  is

$$e_{ij}^{(2)} = \frac{1}{2} \left( \frac{\partial u_i}{\partial X_j} + \frac{\partial u_j}{\partial X_i} + \frac{\partial u_i}{\partial X_k} \frac{\partial u_j}{\partial X_k} \right) \quad (19.32)$$

## 19.3 Relations between $\mathbf{D}$ and rates of $\mathbf{E}^G$ and $\mathbf{U}$

### 19.3.1 Relation Between $\dot{\mathbf{E}}^G$ and $\mathbf{D}$

Because  $\mathbf{D}$  expresses the rate-of-deformation, we should expect that there is a relation between  $\mathbf{D}$  and the rate-of-strain, in particular, the rate of the Green-Lagrange strain. To derive this relation, recall that the definition of the velocity gradient tensor is

$$d\mathbf{v} = \mathbf{L} \cdot d\mathbf{x} \quad (19.33)$$

Differentiating the relation

$$d\mathbf{x} = \mathbf{F} \cdot d\mathbf{X} \quad (19.34)$$

yields another expression for  $d\mathbf{v}$ :

$$d\mathbf{v} = \dot{\mathbf{F}} \cdot d\mathbf{X} \quad (19.35)$$

Substituting from (19.34) for  $d\mathbf{x}$  into (19.33), and comparing the result with (19.35) yields

$$\dot{\mathbf{F}} = \mathbf{L} \cdot \mathbf{F} \quad (19.36)$$

Differentiating the expression for the Green-Lagrange strain

$$\mathbf{E}^G = \frac{1}{2} \{ \mathbf{F}^T \cdot \mathbf{F} - \mathbf{I} \} \quad (19.37)$$

gives

$$\dot{\mathbf{E}}^G = \frac{1}{2} \{ \dot{\mathbf{F}}^T \cdot \mathbf{F} + \mathbf{F}^T \cdot \dot{\mathbf{F}} \} \quad (19.38)$$

Substituting (19.36) gives

$$\dot{\mathbf{E}}^G = \frac{1}{2} \{ (\mathbf{L} \cdot \mathbf{F})^T \cdot \mathbf{F} + \mathbf{F}^T \cdot (\mathbf{L} \cdot \mathbf{F}) \} \quad (19.39)$$

$$= \mathbf{F}^T \cdot \left\{ \frac{1}{2} (\mathbf{L}^T + \mathbf{L}) \right\} \cdot \mathbf{F} \quad (19.40)$$

$$= \mathbf{F}^T \cdot \mathbf{D} \cdot \mathbf{F} \quad (19.41)$$

Thus,  $\dot{\mathbf{E}}^G = 0$  when  $\mathbf{D} = 0$ . This is a property of any material strain tensor (their rate vanishes when  $\mathbf{D} = 0$ ) and, hence, reinforces the interpretation of them as *material* strain measures.

Rates of the spatial strain measures do not vanish when  $\mathbf{D}$  vanishes. For example, consider the rate of the Almansi strain (19.24)

$$\dot{\mathbf{E}}^* = -\frac{1}{2} \left\{ \frac{d}{dt} (\mathbf{F}^{-1T}) \cdot \mathbf{F}^{-1} + \mathbf{F}^{-1T} \cdot \frac{d}{dt} (\mathbf{F}^{-1}) \right\} \quad (19.42)$$

In order to calculate the rate of  $\mathbf{F}^{-1}$ , begin with

$$\mathbf{F}^{-1} \cdot \mathbf{F} = \mathbf{I} \quad (19.43)$$

Differentiating yields

$$\frac{d}{dt} (\mathbf{F}^{-1}) \cdot \mathbf{F} + \mathbf{F}^{-1} \cdot \dot{\mathbf{F}} = 0 \quad (19.44)$$

and then solving for  $d(\mathbf{F}^{-1})/dt$  gives

$$\frac{d}{dt} (\mathbf{F}^{-1}) = -\mathbf{F}^{-1} \cdot \dot{\mathbf{F}} \cdot \mathbf{F}^{-1} \quad (19.45)$$

or, using (19.36),

$$\frac{d}{dt} (\mathbf{F}^{-1}) = -\mathbf{F}^{-1} \cdot \mathbf{L} \quad (19.46)$$

This illustrates the general procedure for determining the derivative of the inverse of a tensor. Since

$$\dot{\mathbf{E}}^* = \frac{1}{2} \{ \mathbf{L}^T \cdot \mathbf{F}^{-1T} \cdot \mathbf{F}^{-1} + \mathbf{F}^{-1T} \cdot \mathbf{F}^{-1} \cdot \mathbf{L} \}$$

Substituting

$$\mathbf{F}^{-1T} \cdot \mathbf{F}^{-1} = \mathbf{I} - 2\mathbf{E}^* \quad (19.48)$$

gives

$$\dot{\mathbf{E}}^* = \mathbf{D} - \mathbf{L}^T \cdot \mathbf{E}^* - \mathbf{E}^* \cdot \mathbf{L} \quad (19.49a)$$

Note that when  $\mathbf{D} = 0$ ,  $\dot{\mathbf{E}}^*$  does not vanish but equals

$$\dot{\mathbf{E}}^* = \mathbf{0} - \mathbf{W}^T \cdot \mathbf{E}^* - \mathbf{E}^* \cdot \mathbf{W} \quad (19.50)$$

Consequently,  $\dot{\mathbf{E}}^*$  depends on the spin and would not be suitable for use in a constitutive relation. This motivates the definition of a special rate that *does* vanish when  $\mathbf{D} = 0$

$$\overset{\nabla}{\mathbf{E}}^* = \dot{\mathbf{E}}^* + \mathbf{W}^T \cdot \mathbf{E}^* + \mathbf{E}^* \cdot \mathbf{W} \quad (19.51a)$$

### 19.3.2 Relation Between $\mathbf{D}$ and $\dot{\mathbf{U}}$

We can also examine the relation between  $\mathbf{D}$  and  $\dot{\mathbf{U}}$ . Using the first of (19.18) in

$$\mathbf{L} = \dot{\mathbf{F}} \cdot \mathbf{F}^{-1} \quad (19.52)$$

gives

$$\mathbf{L} = \dot{\mathbf{F}} \cdot \mathbf{F}^{-1} \quad (19.53a)$$

$$= (\dot{\mathbf{R}} \cdot \mathbf{U} + \mathbf{R} \cdot \dot{\mathbf{U}}) \cdot (\mathbf{R} \cdot \mathbf{U})^{-1} \quad (19.53b)$$

$$= (\dot{\mathbf{R}} \cdot \mathbf{U} + \mathbf{R} \cdot \dot{\mathbf{U}}) \cdot (\mathbf{U}^{-1} \cdot \mathbf{R}^T) \quad (19.53c)$$

$$= \dot{\mathbf{R}} \cdot \mathbf{R}^T + \mathbf{R} \cdot \dot{\mathbf{U}} \cdot \mathbf{U}^{-1} \cdot \mathbf{R}^T \quad (19.53d)$$

The first term  $\dot{\mathbf{R}} \cdot \mathbf{R}^T$  is anti-symmetric. To demonstrate this differentiate

$$\mathbf{R} \cdot \mathbf{R}^T = \mathbf{I} \quad (19.54)$$

to get

$$\dot{\mathbf{R}} \cdot \mathbf{R}^T + \mathbf{R} \cdot \dot{\mathbf{R}}^T = 0 \quad (19.55a)$$

$$\dot{\mathbf{R}} \cdot \mathbf{R}^T = -(\dot{\mathbf{R}} \cdot \mathbf{R}^T)^T \quad (19.55b)$$

Substituting (19.53d) into

$$\mathbf{D} = \frac{1}{2}(\mathbf{L} + \mathbf{L}^T) \quad (19.56)$$

yields

$$\mathbf{D} = \frac{1}{2}\mathbf{R} \cdot \left\{ \dot{\mathbf{U}} \cdot \mathbf{U}^{-1} + \mathbf{U}^{-1T} \cdot \dot{\mathbf{U}}^T \right\} \cdot \mathbf{R}^T \quad (19.57)$$

Similarly, substituting into

$$\mathbf{W} = \frac{1}{2}(\mathbf{L} - \mathbf{L}^T) \quad (19.58)$$

yields

$$\mathbf{W} = \dot{\mathbf{R}} \cdot \mathbf{R}^T + \frac{1}{2}\mathbf{R} \cdot \left\{ \dot{\mathbf{U}} \cdot \mathbf{U}^{-1} - \mathbf{U}^{-1T} \cdot \dot{\mathbf{U}}^T \right\} \cdot \mathbf{R}^T \quad (19.59)$$

### 19.3.3 Additional Reading

Malvern, Sec. 4.5; Reddy, 3.4.2, 3.6.2.





## Chapter 20

# Linearized Displacement Gradients

We now want to specialize the deformation and large strain measures to the case of infinitesimal displacement gradients. As expected, these will reduce to the usual expressions for “small” strain.

The displacement is the difference between the positions in current and reference configurations

$$\mathbf{u} = \mathbf{x} - \mathbf{X} \quad (20.1)$$

or, in component form,

$$u_k = x_k - X_k \quad (20.2)$$

The deformation gradient tensor is then

$$F_{ij} = \frac{\partial x_i}{\partial X_j} = \delta_{ij} + \frac{\partial u_i}{\partial X_j} \quad (20.3)$$

or, in symbolic, coordinate-free form

$$\mathbf{F} = \mathbf{I} + \mathbf{u}\nabla \quad (20.4)$$

where  $\mathbf{u}\nabla = (\nabla\mathbf{u})^T$  is the displacement gradient tensor (Again, although the gradient symbol is placed to right of the vector, the operator acts to the left). We have shown that all the geometric measures of deformation, changes in the length of lines, changes in angles and changes in volume can be expressed in terms of the Green deformation tensor (17.8)

$$\mathbf{C} = \mathbf{U}^2 = (\mathbf{F}^T \cdot \mathbf{F}) \quad (20.5)$$

Expressing  $\mathbf{C}$  in terms of the displacement gradient yields

$$\mathbf{C} = \mathbf{I} + (\nabla\mathbf{u})^T + (\nabla\mathbf{u}) + (\nabla\mathbf{u}) \cdot (\nabla\mathbf{u})^T \quad (20.6)$$

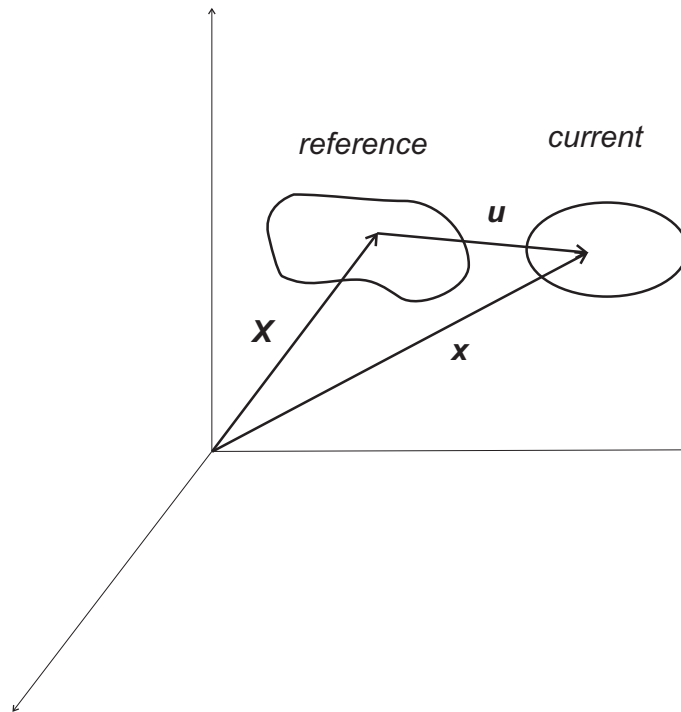

Figure 20.1:

or, in component form,

$$C_{ij} = F_{ki}F_{kj} = \left( \delta_{ki} + \frac{\partial u_k}{\partial X_j} \right) \left( \delta_{kj} + \frac{\partial u_k}{\partial X_i} \right) \quad (20.7a)$$

$$= \delta_{ij} + \left( \frac{\partial u_i}{\partial X_j} + \frac{\partial u_j}{\partial X_i} \right) + \frac{\partial u_k}{\partial X_i} \frac{\partial u_k}{\partial X_j} \quad (20.7b)$$

Assume that the magnitude of the displacement gradient is much less than unity

$$\left| \frac{\partial u_i}{\partial X_j} \right| \ll 1 \quad (20.8)$$

and define infinitesimal (small) strain tensor as

$$\epsilon_{ij} = \frac{1}{2} \left( \frac{\partial u_i}{\partial X_j} + \frac{\partial u_j}{\partial X_i} \right) = \epsilon_{ji} \quad (20.9a)$$

$$\boldsymbol{\epsilon} = \frac{1}{2} \left( \nabla \mathbf{u} + (\nabla \mathbf{u})^T \right) \quad (20.9b)$$

Because of the assumption (20.8), the last terms in (20.6) and (20.7b) can be neglected. Thus,

$$\mathbf{C} = \mathbf{I} + 2\boldsymbol{\epsilon} \quad (20.10)$$

or

$$C_{ij} = \delta_{ij} + 2\epsilon_{ij} \quad (20.11)$$

Now use these to linearize the geometric measures of deformation and express them in terms of the infinitesimal strain tensor.

## 20.1 Linearized Geometric Measures

### 20.1.1 Stretch in direction $\mathbf{N}$

The stretch ratio in direction  $\mathbf{N}$  is given by (GeoMeaDef14). Substituting (20.10) and linearizing yields

$$\Lambda = \{ \mathbf{N} \cdot (\mathbf{I} + 2\boldsymbol{\epsilon}) \cdot \mathbf{N} \}^{\frac{1}{2}} = \sqrt{1 + 2\mathbf{N} \cdot \boldsymbol{\epsilon} \cdot \mathbf{N}} \simeq 1 + \mathbf{N} \cdot \boldsymbol{\epsilon} \cdot \mathbf{N} + \dots \quad (20.12a)$$

Using the linear term in the binomial expansion

$$(1 + x)^n \simeq 1 + nx + \dots \quad (20.13)$$

gives

$$\Lambda \simeq 1 + \mathbf{N} \cdot \boldsymbol{\epsilon} \cdot \mathbf{N} + \dots \quad (20.14)$$

Therefore, the normal components of the infinitesimal strain tensor give the change in length of a line in the  $\mathbf{N}$  direction in the reference configuration:

$$\mathbf{N} \cdot \boldsymbol{\epsilon} \cdot \mathbf{N} = \Lambda - 1 \quad (20.15)$$

For example, if  $\mathbf{N} = \mathbf{e}_1$ , then  $\epsilon_{11}$  is the change in length of a line segment originally in  $X_1$  direction divided by original length.

### 20.1.2 Angle Change

The current angle between lines that were in directions  $\mathbf{N}_A$  and  $\mathbf{N}_B$  in the reference configuration is given by (17.16c)

$$\cos \theta = \frac{\mathbf{N}_A \cdot \mathbf{C} \cdot \mathbf{N}_B}{\Lambda_A \Lambda_B} \quad (20.16a)$$

where

$$\mathbf{N}_A \cdot \mathbf{N}_B = \cos \Theta \quad (20.17a)$$

Writing the current angle in terms of the original angle and the change

$$\gamma = \Theta - \theta \quad (20.18)$$

gives

$$\cos \{\Theta - \gamma\} = \frac{\mathbf{N}_A \cdot \mathbf{C} \cdot \mathbf{N}_B}{\Lambda_A \Lambda_B} \quad (20.19)$$

When  $\mathbf{N}_A$  and  $\mathbf{N}_B$  are orthogonal, i.e.,  $\mathbf{N}_A \cdot \mathbf{N}_B = 0$ , (20.19) reduces to

$$\sin \gamma = \frac{\mathbf{N}_A \cdot \mathbf{C} \cdot \mathbf{N}_B}{\Lambda_A \Lambda_B} \quad (20.20)$$

Approximating  $\sin \gamma$  by  $\gamma$ , substituting (20.10) and (20.12a), and linearizing yields

$$\gamma = \frac{\mathbf{N}_A \cdot \{\mathbf{I} + 2\boldsymbol{\epsilon} + \dots\} \cdot \mathbf{N}_B}{\{1 + \mathbf{N}_A \cdot \boldsymbol{\epsilon} \cdot \mathbf{N}_A + \dots\} \{1 + \mathbf{N}_B \cdot \boldsymbol{\epsilon} \cdot \mathbf{N}_B\}} \simeq 2\mathbf{N}_A \cdot \boldsymbol{\epsilon} \cdot \mathbf{N}_B \quad (20.21)$$

For example, if  $\mathbf{N}_A = \mathbf{e}_1$  and  $\mathbf{N}_B = \mathbf{e}_2$ ,  $\gamma = 2\epsilon_{12}$ . Therefore,  $\epsilon_{12}$  is one-half the change in angle between lines originally in “1” and “2” directions.

### 20.1.3 Volume change

The ratio of volume elements in the current and reference configurations is given by

$$\frac{dv}{dV} = \det(\mathbf{F}) \quad (20.22)$$

Substituting (20.3) and expanding the determinant yields

$$\frac{dv}{dV} = \epsilon_{ijk} \left( \delta_{i1} + \frac{\partial u_i}{\partial X_1} \right) \left( \delta_{j2} + \frac{\partial u_j}{\partial X_2} \right) \left( \delta_{k3} + \frac{\partial u_k}{\partial X_3} \right) \quad (20.23)$$

Carrying out the multiplication but keeping only the linear terms in the displacement gradient components gives

$$\begin{aligned} \frac{dv}{dV} &= \epsilon_{123} + \frac{\partial u_i}{\partial X_1} \epsilon_{ijk} \delta_{j2} \delta_{k3} + \frac{\partial u_j}{\partial X_2} \delta_{i1} \delta_{k3} \epsilon_{ijk} + \frac{\partial u_k}{\partial X_3} \delta_{i1} \delta_{j2} \epsilon_{ijk} + \dots \\ &= 1 + \frac{\partial u_1}{\partial X_1} + \frac{\partial u_2}{\partial X_2} + \frac{\partial u_3}{\partial X_3} \end{aligned} \quad (20.24a)$$

$$= 1 + \epsilon_{11} + \epsilon_{22} + \epsilon_{33} \quad (20.24b)$$

Thus, the change in volume divided by reference volume is the trace of the small strain tensor.

## 20.2 Linearized Polar Decomposition

The polar decomposition is given by (18.8)

$$\mathbf{F} = \mathbf{R} \cdot \mathbf{U} \quad (20.25a)$$

where  $\mathbf{F}$  is given by (20.3) or (20.4). To determine the linearized form of  $\mathbf{U} = \sqrt{\mathbf{C}}$ , begin by expressing  $\mathbf{C}$  in principal axis form

$$\mathbf{C} = (1 + 2\varepsilon_I)\mathbf{N}_I\mathbf{N}_I + (1 + 2\varepsilon_{II})\mathbf{N}_{II}\mathbf{N}_{II} + (1 + 2\varepsilon_{III})\mathbf{N}_{III}\mathbf{N}_{III} \quad (20.26)$$

and obtaining

$$\mathbf{U} = \sqrt{\mathbf{C}} = \sqrt{1 + 2\varepsilon_I}\mathbf{N}_I\mathbf{N}_I + \dots \quad (20.27a)$$

Linearizing then yields

$$\mathbf{U} \simeq \left[ 1 + \left(\frac{1}{2}\right)(2\varepsilon_I) + \dots \right] \mathbf{N}_I\mathbf{N}_I + \dots \quad (20.28a)$$

$$\simeq (1 + \varepsilon_I)\mathbf{N}_I\mathbf{N}_I + \dots \quad (20.28b)$$

Thus,  $\mathbf{U}$  is approximated by

$$\mathbf{U} \simeq \mathbf{I} + \boldsymbol{\varepsilon} \quad (20.29a)$$

$$U_{ij} \simeq \delta_{ij} + \varepsilon_{ij} \quad (20.29b)$$

The linearized form of  $\mathbf{U}^{-1}$  can be also determined easily by first expressing  $\mathbf{U}$  in principal axis form

$$\mathbf{U} = (1 + \varepsilon_I)\mathbf{N}_I\mathbf{N}_I + \dots \quad (20.30a)$$

The inverse is given by

$$\mathbf{U}^{-1} = \frac{1}{1 + \varepsilon_I}\mathbf{N}_I\mathbf{N}_I + \dots \quad (20.31)$$

and using (20.13) gives

$$\mathbf{U}^{-1} \simeq (1 - \varepsilon_I)\mathbf{N}_I\mathbf{N}_I + \dots \quad (20.32)$$

Collecting terms and expressing in coordinate free form gives

$$\mathbf{U}^{-1} \simeq \mathbf{I} - \boldsymbol{\varepsilon} \quad (20.33)$$

It remains to determine the linearized form of the rotation tensor

$$\mathbf{R} = \mathbf{F} \cdot \mathbf{U}^{-1} \quad (20.34)$$

Substituting (20.33) and (20.4) into (20.34) and neglecting second order terms gives

$$\mathbf{R} \simeq (\mathbf{I} + \mathbf{u}\nabla) \cdot (\mathbf{I} - \boldsymbol{\varepsilon}) \quad (20.35a)$$

$$\simeq \mathbf{I} + \mathbf{u}\nabla - \frac{1}{2}(\mathbf{u}\nabla + \nabla\mathbf{u}) \quad (20.35b)$$

$$\simeq \mathbf{I} + \frac{1}{2}((\nabla\mathbf{u})^T - \nabla\mathbf{u}) \quad (20.35c)$$

The final term is the *infinitesimal rotation tensor*  $\mathbf{\Omega}$

$$\mathbf{\Omega} = \frac{1}{2} \left[ (\nabla \mathbf{u})^T - \nabla \mathbf{u} \right] \quad (20.36)$$

or in component form

$$\Omega_{ij} = \frac{1}{2} \left( \frac{\partial u_i}{\partial X_j} - \frac{\partial u_j}{\partial X_i} \right) \quad (20.37)$$

Thus, the multiplicative decomposition (20.25a) reduces to the additive decomposition of the displacement gradient tensor into the symmetric infinitesimal strain tensor and the skew symmetric infinitesimal rotation tensor

$$(\nabla \mathbf{u})^T = \boldsymbol{\varepsilon} + \mathbf{\Omega} \quad (20.38)$$

### 20.3 Small Strain Compatibility

If the displacements  $u_k(X_j, t)$  are known and differentiable, then it is always possible to compute the six strain components

$$\epsilon_{ij} = \frac{1}{2} \left( \frac{\partial u_i}{\partial X_j} + \frac{\partial u_j}{\partial X_i} \right) \quad (20.39)$$

or, writing out each term,

$$\epsilon_{11} = \frac{\partial u_1}{\partial X_1} \quad (20.40a)$$

$$\epsilon_{22} = \frac{\partial u_2}{\partial X_2} \quad (20.40b)$$

$$\epsilon_{33} = \frac{\partial u_3}{\partial X_3} \quad (20.40c)$$

$$2\epsilon_{12} = \frac{\partial u_1}{\partial X_2} + \frac{\partial u_2}{\partial X_1} \quad (20.40d)$$

$$2\epsilon_{13} = \frac{\partial u_3}{\partial X_1} + \frac{\partial u_1}{\partial X_3} \quad (20.40e)$$

$$2\epsilon_{23} = \frac{\partial u_3}{\partial X_2} + \frac{\partial u_2}{\partial X_3} \quad (20.40f)$$

Because there are 6 strain components calculated from three displacements, some relations must exist between the strain components.

A mathematically analogous, but simpler situation occurs when force components  $F_i$  are calculated from a scalar potential  $\phi$ :

$$\mathbf{F} = \nabla \phi \quad (20.41)$$

In general, the force components are independent, but if they satisfy (20.41), then they must also satisfy

$$\nabla \times \mathbf{F} = 0 \quad (20.42)$$

This requires, for example, that

$$\frac{\partial F_1}{\partial X_2} = \frac{\partial F_2}{\partial X_1} \quad (20.43)$$

This condition is obtained from the  $X_3$  component of (20.42) or by substituting the force components from (20.41).

The equations of compatibility can be obtained by differentiating the strain components, writing them in terms of displacements, and interchanging the order of differentiation. For brevity, denote derivatives as

$$\frac{\partial u_1}{\partial X_1} = u_{1,1} \quad (20.44)$$

For example

$$2\epsilon_{12,12} = u_{1,212} + u_{2,112} \quad (20.45a)$$

$$= u_{1,122} + u_{2,211} \quad (20.45b)$$

$$= \epsilon_{11,22} + \epsilon_{22,11} \quad (20.45c)$$

and

$$2[\epsilon_{12,13} + \epsilon_{31,21}] = u_{1,213} + u_{2,113} + u_{3,121} + u_{1,321} \quad (20.46a)$$

$$= 2u_{1,123} + (u_{2,3} + u_{3,2})_{,11} \quad (20.46b)$$

$$= 2[\epsilon_{11,23} + \epsilon_{23,11}] \quad (20.46c)$$

and so on yields 6 conditions (but only 3 are independent) that are necessary for the existence of a single-valued displacement. (see eq. 4.7.5a of Malvern, p.186 or Mase & Mase, p.131; Reddy, pp. 101-102, eqn. 3.8.4-9). These can be summarized concisely as

$$\nabla \times \boldsymbol{\epsilon} \times \nabla = 0 \quad (20.47)$$

Since  $\boldsymbol{\epsilon} = \boldsymbol{\epsilon}^T$  the result is symmetric and there are only six distinct components. Of these only three are independent (see Malvern, sec. 2.5 Exercises 12-14).

Thus, if the strains are written in terms of displacements, the conditions (20.47) are *necessary* for the strains to be compatible. On the other hand, if the strains are known, what conditions are *sufficient* to guarantee that the strain components can be integrated to yield a single-valued displacement field? To visualize the meaning of this physically, imagine cutting the body into small (infinitesimal) blocks. Assign a strain to each block. Generally the body will not fit back together. There will be gaps, overlaps, etc. That is, the displacement field will not be single valued unless the strains assigned to the blocks are *compatible*. It turns out that the conditions (20.47) are also sufficient (at least in simply connected bodies).

Again the situation is mathematically analogous to a simpler one. Consider the increment of work  $dW$  due to the action of the force  $\mathbf{F}$  on the displacement increment  $d\mathbf{u}$

$$dW = \mathbf{F} \cdot d\mathbf{u} \quad (20.48)$$

In general,  $dW$  is *not* a perfect differential. That is, work is a path-dependent quantity and the line integral

$$W = \int_c \mathbf{F} \cdot d\mathbf{u} \quad (20.49)$$

will have different values if calculated on different paths between the same two points. It follows that the integral around a closed path will not be zero. Work will, however, be path-independent if it is equal to the change in energy or, if, in other words, the system is conservative. A condition guaranteeing that this is the case is the same as (20.42)

$$\nabla \times \mathbf{F} = 0 \quad (20.50)$$

If this condition is met, the force can be represented as the gradient of a scalar potential function (20.41). Hence, (20.50) is *necessary* and *sufficient* for the force to be the gradient of a scalar function.

The situation is similar for compatibility but more complicated because the strain is a tensor. Consider the conditions for which the displacement gradient field can be integrated to give a single-valued displacement field

$$\mathbf{u}^P - \mathbf{u}^O = \int_C d\mathbf{u} = \int_C (\mathbf{u}\nabla) \cdot d\mathbf{X} \quad (20.51)$$

where  $\mathbf{u}^P$  is the displacement at point  $P$  and  $\mathbf{u}^O$  is the displacement at  $P_o$  and  $C$  is any path joining  $P$  and  $P_o$ . Using (20.38) and expressing in index notation, this is

$$u_i^P - u_i^O = \int_C (\epsilon_{ij} + \Omega_{ij}) dX_j \quad (20.52)$$

where

$$\epsilon_{ij} = \frac{1}{2} \left( \frac{\partial u_i}{\partial X_j} + \frac{\partial u_j}{\partial X_i} \right) \quad (20.53a)$$

$$\Omega_{ij} = \frac{1}{2} \left( \frac{\partial u_i}{\partial X_j} - \frac{\partial u_j}{\partial X_i} \right) \quad (20.53b)$$

Expressing the second term in terms of the infinitesimal rotation vector  $\Omega_{ij} = \epsilon_{jik} w_k$  yields

$$u_i^P - u_i^O = \int_C (\epsilon_{ij} + \epsilon_{jik} w_k) dX_j \quad (20.54)$$

Analogous to (20.49) and (20.50), a sufficient condition guaranteeing that the integral (20.54) is independent of path is

$$\nabla \times \mathbf{P} = 0 \quad (20.55)$$

where

$$P_{qs} = \epsilon_{qs} + \epsilon_{qst} w_t \quad (20.56)$$



Writing (20.55) in index notation and substituting (20.56) yields

$$\epsilon_{ipq}\epsilon_{qs,p} = w_{i,s} - \delta_{is}w_{p,p}$$

but the second term on the right side vanishes because the divergence of the rotation vector is zero. Operating on both sides with  $\epsilon_{jrs}\partial_r$  yields

$$\epsilon_{jrs}\epsilon_{ipq}\epsilon_{qs,pr} = 0$$

which is the same as (20.47).

### 20.3.1 Additional Reading

Malvern, Sec. 4.1-4.2, pp. 120-137; Sec. 4.7, pp. 183-190; Reddy, 3.8.



## Part IV

# Balance of Mass, Momentum and Energy



## Chapter 21

# Transformation of Integrals

To derive equations expressing the conservation of mass and energy and balance of angular and linear momentum, we will repeatedly use theorems that transform an integral over a surface to one over the interior volume of the material. The primary one, the divergence theorem or Green-Gauss theorem is related to Green's theorem in the plane. Green's theorem in the plane can be expressed as

$$\int_A \int \left( \frac{\partial M}{\partial y} - \frac{\partial N}{\partial x} \right) dx dy = - \int_C (M dx + N dy) \quad (21.1)$$

where the curve  $C$  encloses the area  $A$  and is traversed in a counterclockwise direction. The functions  $M$  and  $N$  depend on  $x$  and  $y$ .

To prove this theorem note that the double integral of the first term on the left can be carried out by first integrating in  $y$  for a vertical strip of width  $dx$ . The limits of integration are given by the curves  $y_1(x)$  and  $y_2(x)$  that make up the top and bottom of  $C$ . Then the integration in  $x$  is carried out by sweeping this strip from left to right. Because  $\partial M/\partial y$  is a perfect differential, the integration in  $y$  is simply

$$\int \int \frac{\partial M}{\partial y} dx dy = \int_a^b dx \int_{y_1(x)}^{y_2(x)} \frac{\partial M}{\partial y}(x, y) dy \quad (21.2a)$$

$$= \int_a^b [M(x, y_2(x)) - M(x, y_1(x))] dx \quad (21.2b)$$

$$= - \int_b^a M(x, y_2(x)) dx - \int_a^b M(x, y_1(x)) dx \quad (21.2c)$$

$$= - \int_C M dx \quad (21.2d)$$

The third line follows by inserting a minus sign and interchanging the limits of integration in the first term. The last line follows by noting that the sum of integrating over the curves  $y_1(x)$  and  $y_2(x)$  in the same direction is an integral around the closed curve  $C$ . Integration of the second term follows in the same

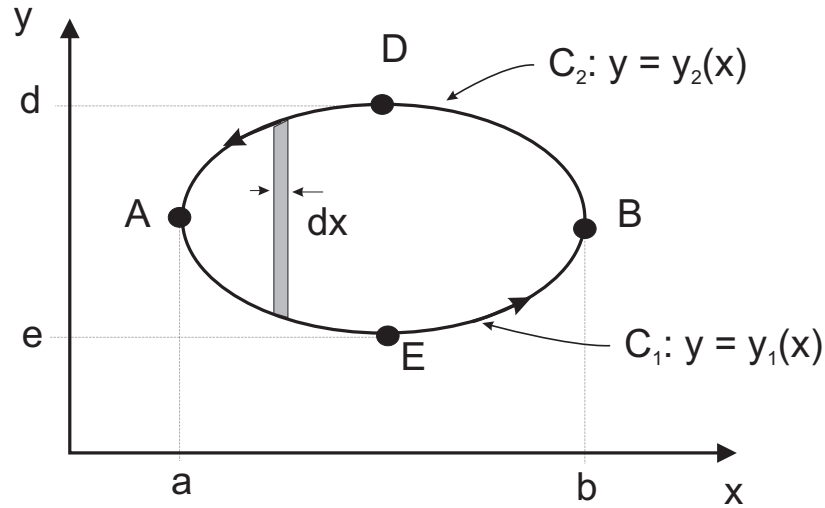

Figure 21.1: Definitions for derivation of Green's Theorem in the plane.

way but by first using a horizontal strip of height  $dy$ . The result is

$$\iint \frac{\partial N}{\partial x} dx dy = \int_C N dy \quad (21.3)$$

and subtracting yields (21.1).

We can rewrite (21.1) in vector form by noting that the normal to the curve is

$$\mathbf{n} = \cos \alpha \mathbf{e}_x + \sin \alpha \mathbf{e}_y = \frac{dy}{ds} \mathbf{e}_x - \frac{dx}{ds} \mathbf{e}_y \quad (21.4)$$

where  $s$  is arclength (Figure 21.2). Defining the vector  $\mathbf{u}$  as

$$\mathbf{u} = -N \mathbf{e}_x + M \mathbf{e}_y \quad (21.5)$$

gives

$$\mathbf{n} \cdot \mathbf{u} = -N \frac{dy}{ds} - M \frac{dx}{ds} \quad (21.6)$$

and

$$\nabla \cdot \mathbf{u} = -\frac{\partial N}{\partial x} + \frac{\partial M}{\partial y} \quad (21.7a)$$

Therefore the theorem (21.1) can be written as:

$$\iint_A \nabla \cdot \mathbf{u} dA = \int_C \mathbf{n} \cdot \mathbf{u} ds \quad (21.8)$$

The curve in Figure 21.1 is a special one because vertical and horizontal lines intersect the curve in no more than two points. Nevertheless the theorem

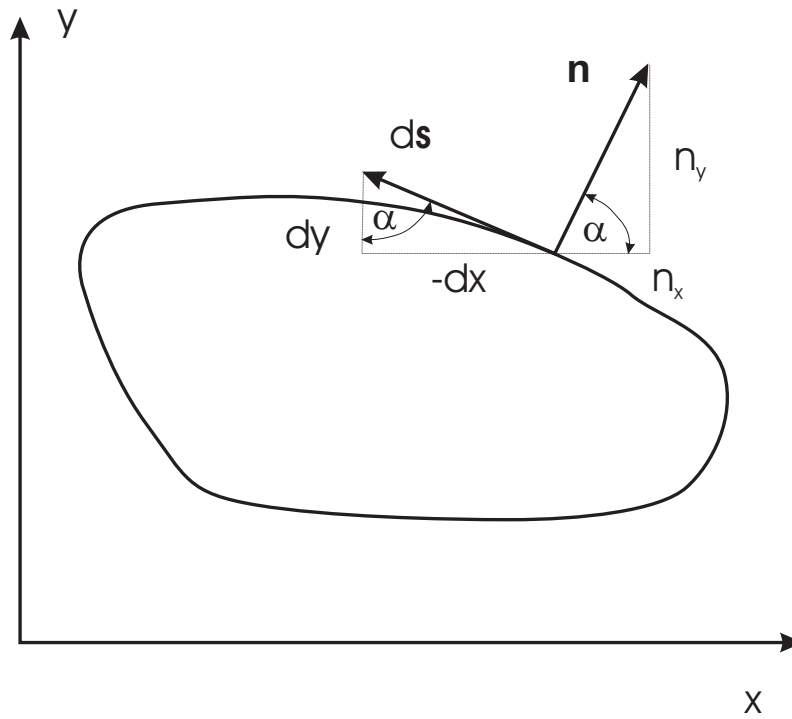

Figure 21.2: Expressing Green's theorem in the plane in terms of the normal and tangent vectors to the curve.

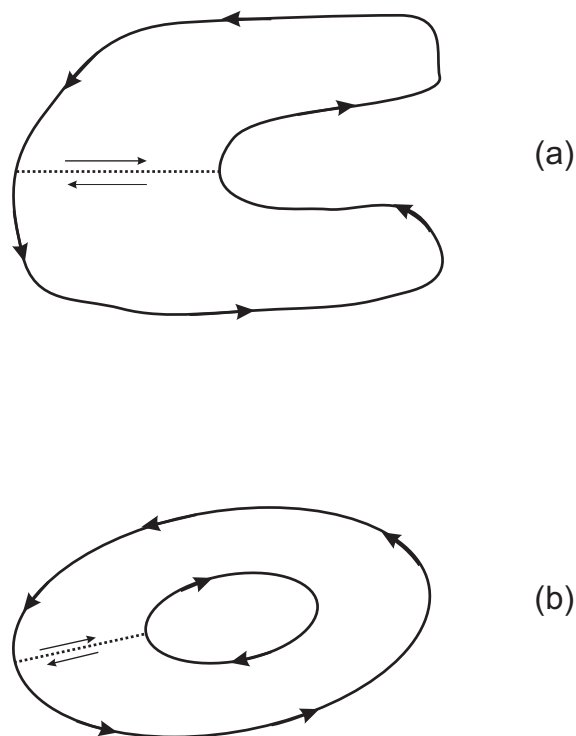

Figure 21.3: Curves for which vertical or horizontal lines intersect the boundaries in more than two points.

applies for more complicated curves such as those shown in Figure 21.3 and the method of proof used above is easily modified for these cases. For the curve in Figure 21.3a, a vertical line can intersect the curve in four points. This difficulty is easily overcome, however, by inserting the dashed line as shown and applying the method to each part of the area separately. The dashed line is traversed in opposite directions for each part and, thus, as long as the integrand is continuous, the contributions cancel.

In Figure 21.3b, the area of integration  $A$  has a hole so that there is an interior and exterior boundary. Again, demonstration of the theorem proceeds in the same way after connecting the interior and exterior boundaries by the dashed line. If the integrand is continuous, the portions of the integral over the dashed line cancel since they are traversed in opposite directions. Note that the resulting contour  $C$  is counterclockwise on the exterior boundary and clockwise on the interior boundary. On both boundaries the normal  $\mathbf{n}$  points out of the area  $A$ . In other words a person walking on the contour in the direction shown would have the area  $A$  to his left and the normal  $\mathbf{n}$  to his right.

In three dimensions, the theorem relates the integral of the divergence over



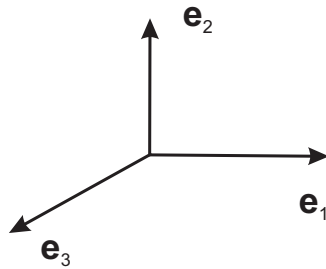
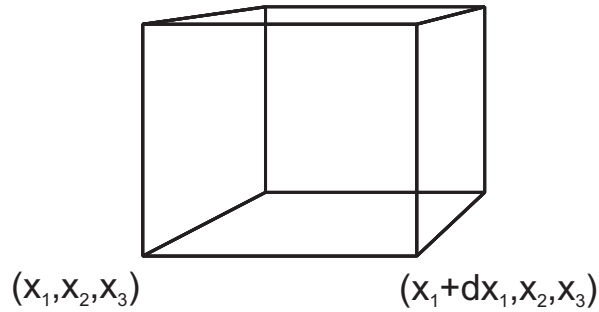

Figure 21.4:

a volume to an integral over the bounding surface with outward normal  $\mathbf{n}$ :

$$\int_V \nabla \cdot \mathbf{u} dV = \int_S \mathbf{n} \cdot \mathbf{u} ds \quad (21.9)$$

This expression can be motivated directly by considering Figure 21.4. The contribution from the two faces  $\mathbf{n} = \mathbf{e}_1$  and  $\mathbf{n} = -\mathbf{e}_1$  is

$$[u_1(x_1 + dx_1, \xi_2, \xi_3) - u_1(x_1, \xi_2, \xi_3)] dx_2 dx_3$$

where the sign difference comes from the oppositely directed normals and  $x_2 < \xi_2 < x_2 + dx_2$ ,  $x_3 < \xi_3 < x_3 + dx_3$ . Expanding yields

$$\frac{\partial u_1}{\partial x_1}(x_1, x_2, x_3) dx_1 dx_2 dx_3$$

Adding contributions from other faces and from other blocks yields (21.9). Contributions from the faces of adjacent blocks cancel because of the oppositely directed normals so that the end result is the integral over the exterior surface.

The following related theorems have the same form:

$$\int_V \nabla f dV = \int_S \mathbf{n} f ds \quad (21.10)$$

$$\int_V \nabla \cdot \mathbf{T} dV = \int_S \mathbf{n} \cdot \mathbf{T} dS \quad (21.11)$$

## 21.1 Additional Reading

Malvern, Sec. 5.1, pp. 197-203; Chadwick, Sec. 1.11, pp. 43-46; Aris, 3.13-3.15; 3.31-3.32.

## Chapter 22

# Conservation of Mass

The total mass in a reference volume  $V$  is

$$m = \int_V \rho_o(\mathbf{X}) dV \quad (22.1)$$

In the current configuration, this same mass occupies the volume  $v$ :

$$m = \int_V \rho_o(\mathbf{X}) dV = \int_v \rho(\mathbf{x}, t) dv \quad (22.2)$$

Because mass can neither be created nor destroyed the rate-of-change of mass must vanish

$$\frac{dm}{dt} = 0 \quad (22.3)$$

Differentiating (22.2) yields

$$\frac{d}{dt} \int_v \rho(\mathbf{x}, t) dv = 0 \quad (22.4)$$

because the integral over the reference volume is independent of time. Because the current volume  $v$  occupied by a fixed amount of mass changes with time, the integration volume in (22.4) depends on time. Although it is possible to include this change in computing the derivative, another approach is to convert the integral to one over the reference volume. Since the current and reference volume elements are related by  $dv = JdV$  where  $J = \det(\mathbf{F})$ , we can rewrite (22.4) as an integral over the reference volume

$$\frac{d}{dt} \int_V \rho[\mathbf{x}(\mathbf{X}, t), t] J dV = 0 \quad (22.5)$$

The integration variable is now position in the reference configuration  $\mathbf{X}$  rather than position in the current configuration  $\mathbf{x}$  and  $J$  is the Jacobian of the change

of variable. The integral is now over a volume that is independent of time and, hence, we can take the derivative inside

$$\int_V \left\{ J \frac{d}{dt} \rho + \rho \dot{J} \right\} dV = 0 \quad (22.6)$$

To compute the derivative of the Jacobian recall that

$$J = \det \mathbf{F} = \epsilon_{ijk} F_{i1} F_{j2} F_{k3} \quad (22.7)$$

Differentiating yields

$$\dot{J} = \epsilon_{ijk} \dot{F}_{i1} F_{j2} F_{k3} + \epsilon_{ijk} F_{i1} \dot{F}_{j2} F_{k3} + \epsilon_{ijk} F_{i1} F_{j2} \dot{F}_{k3} \quad (22.8)$$

But  $\dot{\mathbf{F}} = \mathbf{L} \cdot \mathbf{F}$  or  $\dot{F}_{rt} = L_{rs} F_{st}$ ,

$$\dot{J} = F_{p1} F_{q2} F_{r3} h_{pqr} \quad (22.9)$$

where

$$h_{pqr} = \epsilon_{kqr} L_{kp} + \epsilon_{pkr} L_{kq} + \epsilon_{pqk} L_{kr} \quad (22.10)$$

It is straightforward to verify that  $h_{pqr} = 0$  if any two indicies are the same, that a change in the order of any pair reverses the sign and that  $h_{123} = \text{tr } \mathbf{L} = \text{tr } \mathbf{D}$ . Consequently,  $h_{pqr} = \epsilon_{pqr} \text{tr } \mathbf{D}$  and

$$\dot{J} = J \text{tr } \mathbf{D} \quad (22.11)$$

Substituting into (22.6) yields

$$\int_V \left\{ \frac{d}{dt} \rho + \rho \text{tr } \mathbf{D} \right\} J dV = 0 \quad (22.12)$$

and the integration can be changed back to the current volume

$$\int_v \left\{ \frac{d\rho}{dt} + \rho \text{tr } \mathbf{D} \right\} dv = 0 \quad (22.13)$$

Note that

$$\text{tr } \mathbf{D} = D_{kk} = \frac{\partial v_k}{\partial x_k} = \nabla \cdot \mathbf{v} \quad (22.14a)$$

$$\frac{d\rho}{dt} = \frac{\partial \rho}{\partial t} + \mathbf{v} \cdot \nabla \rho \quad (22.14b)$$

Therefore we rewrite the integrand as

$$\int_v \left\{ \frac{\partial \rho}{\partial t} + \nabla \cdot (\rho \mathbf{v}) \right\} dv = 0 \quad (22.15)$$

and use the divergence theorem on the second term to get

$$\int_v \frac{\partial \rho}{\partial t} dv + \int_a \mathbf{n} \cdot \mathbf{v} \rho da = 0 \quad (22.16)$$

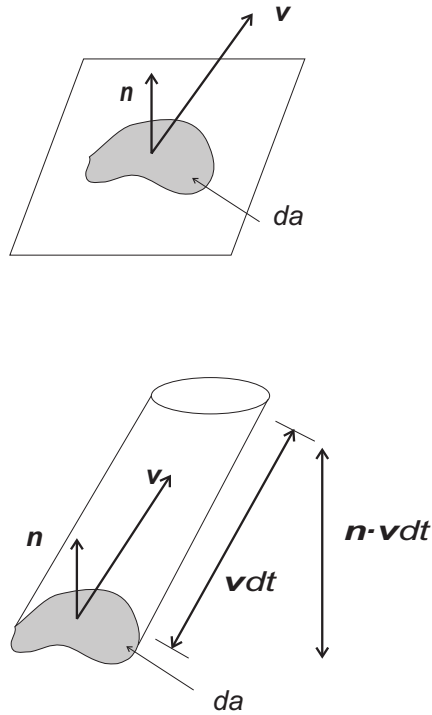

Figure 22.1: Illustration of the flux across a surface  $da$ .

The first term is the rate of change of mass instantaneously inside the spatial volume  $v$ . Because  $\partial/\partial t$  pertains to a fixed spatial position, this derivative can be taken outside the integral; in other words the integration volume is *fixed in space*.

The second term in (22.16) is the rate of change of mass in  $v$  due to flow across the surface of  $v$ , i.e.  $a$ . Since  $\mathbf{n}$  is the outward normal, the integral is positive for flow outward. During a time increment  $dt$  the mass passing through  $da$  sweeps out a cylindrical volume

$$d(\text{vol}) = \mathbf{v} \cdot \mathbf{n} dt da \quad (22.17)$$

where  $\mathbf{v}$  is the material velocity. Therefore the mass outflow is

$$\rho \mathbf{v} \cdot \mathbf{n} dt da \quad (22.18)$$

Since (22.15) applies for all  $v$  containing a fixed amount of mass, the integrand vanishes and

$$\frac{\partial \rho}{\partial t} + \nabla \cdot (\rho \mathbf{v}) = 0 \quad (22.19)$$

is the local form of mass conservation in the current configuration. This equation can be written in several alternative forms

$$\frac{\partial \rho}{\partial t} + \mathbf{v} \cdot \nabla \rho + \rho \nabla \cdot \mathbf{v} = 0 \quad (22.20a)$$

$$\frac{d\rho}{dt} + \rho \nabla \cdot \mathbf{v} = 0 \quad (22.20b)$$

$$\frac{1}{\rho} \frac{d\rho}{dt} = -\nabla \cdot \mathbf{v} \quad (22.20c)$$

The left side of the last equation is the fractional rate of volume decrease.

Also since

$$\dot{J} = \frac{d}{dt}(\det \mathbf{F}) = J \operatorname{tr} \mathbf{D} = J \nabla \cdot \mathbf{v} \quad (22.21)$$

$$\frac{d\rho}{dt} + \frac{\rho}{J} \dot{J} = 0 \quad (22.22)$$

$$\frac{d}{dt}(\rho J) = 0 \quad (22.23)$$

or

$$\rho J = \text{const} = \rho_o \quad (22.24)$$

This is a local expression of (22.2).

For an incompressible material

$$\frac{d\rho}{dt} = 0 \quad (22.25)$$

not

$$\frac{\partial \rho}{\partial t} = 0 \quad (22.26)$$

Note that to say a material is incompressible does not mean that it is rigid (non-deformable). The material can be deformable but in such a way that the volume remains constant. Hence, for an incompressible material

$$\nabla \cdot \mathbf{v} = 0 \quad (22.27)$$

which implies that the velocity vector  $\mathbf{v}$  can be expressed as the curl of a vector  $\Psi$

$$\mathbf{v} = \nabla \times \Psi \quad (22.28)$$

A velocity of this form automatically satisfies (22.27).

## 22.1 Reynolds' Transport Theorem

In examining the other balance laws, we will encounter the derivative of integrals of the form

$$I = \frac{d}{dt} \int_{\mathcal{V}} \rho(\mathbf{x}, t) \mathcal{A}(\mathbf{x}, t) d\mathbf{v} \quad (22.29)$$

where the integral is over a volume in the current configuration containing a fixed amount of mass and  $\mathcal{A}(\mathbf{x}, t)$  is any property that is proportional to the mass, e.g., kinetic energy per unit mass, momentum per unit mass. As before, the complications of differentiating an integral over a time-dependent volume are circumvented by converting to integration over the reference volume

$$I = \frac{d}{dt} \int_{\mathbf{v}} \rho(\mathbf{x}[\mathbf{X}, t], t) \mathcal{A}(\mathbf{x}[\mathbf{X}, t], t) J dv \quad (22.30)$$

Now, the derivative can be taken inside the integral

$$I = \int_{\mathbf{v}} \left\{ J \rho(\mathbf{x}[\mathbf{X}, t], t) \frac{d}{dt} \mathcal{A}(\mathbf{x}[\mathbf{X}, t], t) + \mathcal{A}(\mathbf{x}[\mathbf{X}, t], t) \frac{d}{dt} J \rho(\mathbf{x}[\mathbf{X}, t], t) \right\} dv \quad (22.31)$$

The second term vanishes because of mass conservation (22.23) and the integral can be converted back to the current volume

$$I = \int_{\mathbf{v}} \rho(\mathbf{x}, t) \frac{d}{dt} \mathcal{A}(\mathbf{x}, t) dv \quad (22.32)$$

Equating (22.29) and (22.32) yields

$$\frac{d}{dt} \int_{\mathbf{v}} \rho(\mathbf{x}, t) \mathcal{A}(\mathbf{x}, t) dv = \int_{\mathbf{v}} \rho(\mathbf{x}, t) \frac{d}{dt} \mathcal{A}(\mathbf{x}, t) dv \quad (22.33)$$

Hence, the material derivative can be taken inside the integral to operate only on  $\mathcal{A}(\mathbf{x}, t)$ . This is *Reynolds' Transport Theorem*.

## 22.2 Derivative of an Integral Over a Time-Dependent Region

An alternative approach to dealing with the integral in (22.4) is to recognize that it is changing with time because it encloses a fixed set of material particles and to take this into account in computing the derivative. To compute the derivative of an integral over a time-dependent region, let  $\mathbf{v}(t)$  be the time-dependent volume and  $v_n$  equal  $\mathbf{n} \cdot \mathbf{v}$  be the normal speed of points on the boundary of  $\mathbf{v}$ ,  $s(t)$ . Also let  $Q(\mathbf{x}, t)$  be the spatial description of some quantity defined everywhere in  $\mathbf{v}(t)$ .

We want to compute

$$\frac{d}{dt} \int_{\mathbf{v}(t)} Q(\mathbf{x}, t) dv = \lim_{\Delta t \rightarrow 0} \frac{1}{\Delta t} \left\{ \int_{\mathbf{v}(t+\Delta t)} Q(\mathbf{x}, t + \Delta t) dv - \int_{\mathbf{v}(t)} Q(\mathbf{x}, t) dv \right\} \quad (22.34)$$

We can write the volume at  $t + \Delta t$  as

$$\mathbf{v}(t + \Delta t) = \mathbf{v}(t) + [\mathbf{v}(t + \Delta t) - \mathbf{v}(t)] \quad (22.35)$$

Therefore,

$$\frac{d}{dt} \int_{v(t)} Q(\mathbf{x}, t) dv = \lim_{\Delta t \rightarrow 0} \left\{ \frac{1}{\Delta t} \int_{v(t)} \{Q(\mathbf{x}, t + \Delta t) - Q(\mathbf{x}, t)\} dv \right\} \quad (22.36a)$$

$$+ \lim_{\Delta t \rightarrow 0} \left\{ \frac{1}{\Delta t} \int_{v(t+\Delta t)-v(t)} Q(\mathbf{x}, t + \Delta t) dv \right\} \quad (22.36b)$$

Taking the limit inside the integral (which, now does not depend on  $\Delta t$ ) yields

$$\begin{aligned} \frac{d}{dt} \int_{v(t)} Q(\mathbf{x}, t) dv &= \int_{v(t)} \lim_{\Delta t \rightarrow 0} \left\{ \frac{Q(\mathbf{x}, t + \Delta t) - Q(\mathbf{x}, t)}{\Delta t} \right\} dv \\ &+ \lim_{\Delta t \rightarrow 0} \int_{v(t+\Delta t)-v(t)} Q(\mathbf{x}, t + \Delta t) dv \end{aligned}$$

and then using the definition of the partial derivative gives

$$\begin{aligned} \frac{d}{dt} \int_{v(t)} Q(\mathbf{x}, t) dv &= \int_v \frac{\partial Q}{\partial t}(\mathbf{x}, t) dv + \\ &+ \lim_{\Delta t \rightarrow 0} \int_{v(t+\Delta t)-v(t)} Q(\mathbf{x}, t + \Delta t) dv \end{aligned}$$

To evaluate the second term, consider the motion of a portion of the boundary. The volume swept out in time  $\Delta t$  is

$$dv = v_n \Delta t ds \quad (22.37)$$

Therefore

$$\frac{d}{dt} \int_{v(t)} Q(\mathbf{x}, t) dv = \int_{v(t)} \frac{\partial Q}{\partial t}(\mathbf{x}, t) dv + \int_{s(t)} Q(\mathbf{x}, t) \mathbf{n} \cdot \mathbf{v} ds \quad (22.38)$$

The last term can be transformed using the divergence theorem applied to a control volume instantaneously coinciding with the volume occupied by the material. Thus, the final result is

$$\frac{d}{dt} \int_{v(t)} Q(\mathbf{x}, t) dv = \int_{v(t)} \left\{ \frac{\partial Q}{\partial t}(\mathbf{x}, t) + \nabla \cdot [Q(\mathbf{x}, t) \mathbf{v}] \right\} dv \quad (22.39)$$

Special Cases

1.

$$Q(\mathbf{x}, t) = \rho(\mathbf{x}, t) \quad (22.40)$$

is the density. Then left hand side vanishes because of mass conservation. Hence, the right-hand side must also vanish and, since the equation must apply for any volume  $v$

$$\frac{\partial \rho}{\partial t} + \nabla \cdot (\rho \mathbf{v}) = 0 \quad (22.41)$$

Thus, the mass conservation equation is recovered.



2.

$$Q(\mathbf{x}, t) = 1 \quad (22.42)$$

so

$$\frac{d}{dt} \int_{\mathbf{v}} d\mathbf{v} = \int_{\mathbf{v}(t)} \nabla \cdot \mathbf{v} d\mathbf{v} = \int_{\mathbf{s}(t)} \mathbf{n} \cdot \mathbf{v} ds \quad (22.43)$$

For example, consider a spherical volume with time dependent radius  $R(t)$ :

$$\mathbf{v}(t) = \frac{4}{3}\pi R^3(t) \quad (22.44)$$

Then

$$\dot{\mathbf{v}}(t) = 4\pi R^2 \dot{R}(t)$$

where  $\dot{R}(t)$  is the normal velocity of the boundary and the right and left hand sides correspond to the first and last terms in (22.43)

## 22.3 Additional Reading

Malvern, Sec. 5.2, pp. 205-212; Chadwick, Chapter 3, Sections 1 -2, pp. 87-90;  
Aris, 4.22, 4.3.



# Chapter 23

## Conservation of Momentum

### 23.1 Momentum Balance in the Current State

#### 23.1.1 Linear Momentum

The conservation of linear momentum expresses the application of Newton's Second Law to a continuum:

$$\sum \mathbf{F}_{ext} = \frac{d}{dt}(m\mathbf{v}) \quad (23.1)$$

To apply to a continuum, it is necessary to follow a set of particles. Let  $\mathbf{t}$  be the external surface force, on the current area. Let  $\mathbf{b}$  be the external body force (per unit mass). Then application of (23.1) to a volume  $v$  enclosed by a surface  $a$  gives

$$\int_a \mathbf{t} da + \int_v \rho \mathbf{b} dv = \frac{d}{dt} \int_v \rho \mathbf{v} dv \quad (23.2)$$

Writing the traction can be written in terms of the stress as  $\mathbf{n} \cdot \mathbf{T}$  and using the divergence theorem on the first term yields

$$\int_a \mathbf{n} \cdot \mathbf{T} ds = \int_v \nabla \cdot \mathbf{T} dv \quad (23.3)$$

Alternatively, conservation of linear momentum can be used to define the stress tensor. The stress tensor is the tensor that it is necessary to introduce to convert the surface integral in (23.2) into a volume integral. Reynold's transport theorem gives the following result for the right hand side

$$\int_v \rho \frac{d\mathbf{v}}{dt} dv \quad (23.4)$$

Collecting terms gives

$$\int_v \left\{ \nabla \cdot \mathbf{T} + \rho \mathbf{b} - \rho \frac{d\mathbf{v}}{dt} \right\} dv = 0 \quad (23.5)$$

Since this integral must vanish for *any* material volume, the integrand must vanish.

$$\nabla \cdot \mathbf{T} + \rho \mathbf{b} = \rho \frac{d\mathbf{v}}{dt} \quad (23.6)$$

or, in component form

$$\frac{\partial T_{ij}}{\partial x_i} + \rho b_j = \rho \frac{dv_j}{dt} \quad (23.7)$$

This is the *equation of motion*. If the right hand side is negligible, then (23.7) reduces to the equilibrium equation:

$$\frac{\partial T_{ij}}{\partial x_i} + \rho b_j = 0 \quad (23.8)$$

expressing that the sum of the forces is zero.

### 23.1.2 Angular Momentum

Balance of angular momentum results from the statement that the sum of the moments is equal to the time derivative of the angular momentum

$$\sum \mathbf{M} = \frac{d}{dt} \mathbf{L} \quad (23.9)$$

Applying this to a collection of material particles occupying the current volume  $v$  enclosed by the surface  $a$  yields

$$\int_a (\mathbf{x} \times \mathbf{t}) da + \int_v (\mathbf{x} \times \rho \mathbf{b}) dv = \frac{d}{dt} \int_v (\mathbf{x} \times \rho \mathbf{v}) dv \quad (23.10)$$

or in component form

$$\int_a \epsilon_{ijk} x_j t_k da + \int_v \epsilon_{ijk} x_j \rho b_k dv = \frac{d}{dt} \int_v \rho \epsilon_{ijk} x_j v_k dv \quad (23.11)$$

As before the traction can be expressed in terms of the stress as

$$t_k = n_l T_{lk} \quad (23.12)$$

and the divergence theorem can be used to rewrite the surface integral as a volume integral

$$\int_a \epsilon_{ijk} x_j t_k ds = \int_a \epsilon_{ijk} \frac{\partial}{\partial x_l} \{x_j T_{lk}\} dv \quad (23.13a)$$

$$= \int_a \epsilon_{ijk} \left[ \delta_{jl} T_{lk} + x_j \frac{\partial T_{lk}}{\partial x_l} \right] dv \quad (23.13b)$$

Reynolds' Transport theorem can be used to write the right hand side as

$$\frac{d}{dt} \int_v \rho \epsilon_{ijk} x_j v_k dv = \int_v \rho \epsilon_{ijk} \frac{d}{dt} (x_j v_k) dv \quad (23.14)$$

where

$$\frac{d}{dt}(x_j v_k) = v_j v_k + x_j \frac{dv_k}{dt} \quad (23.15)$$

Using these results in (23.11) yields

$$\int_v \epsilon_{ijk} T_{jk} dv + \int_v \epsilon_{ijk} x_j \left\{ \frac{\partial T_{lk}}{\partial x_l} + \rho b_k - \frac{dv_k}{dt} \right\} dv = 0 \quad (23.16)$$

but the term  $\{ \dots \}$  vanishes because of (23.5). Because the remaining integral must vanish for all volumes  $v$ , the integrand must be zero

$$\epsilon_{ijk} T_{jk} = 0 \quad (23.17)$$

Multiplying by  $\epsilon_{ipq}$ , summing and using the  $\epsilon - \delta$  identity gives

$$T_{pq} = T_{qp} \quad (23.18)$$

or

$$\mathbf{T} = \mathbf{T}^T$$

## 23.2 Momentum Balance in the Reference State

### 23.2.1 Linear Momentum

Previously, we expressed the balance of linear momentum (23.1) in terms of integrals over the body in the current configuration. Sometimes, however, it is more convenient to use the reference configuration. Let  $\mathbf{t}^0$  be the surface force per unit *reference* area,  $\mathbf{b}^0$  be the body force per unit *reference* volume and  $\rho_0$  be the mass density in the reference state. Then application of (23.1) to a volume  $V$  enclosed by a surface  $A$  gives

$$\int_A \mathbf{t}^0 dA + \int_V \rho_0 \mathbf{b}^0 dV = \frac{\partial}{\partial t} \int_V \rho_0 \mathbf{v} dV \quad (23.19)$$

Note that  $\mathbf{t}^0$  and  $\mathbf{b}^0$  express the *current* surface and body forces although they are referred to the *reference* area and volume. Also, the partial derivative, rather than the material derivative, is used on the right hand side because the reference volume is not changing in time. All the quantities in this equation should be considered functions of position in the reference configuration  $\mathbf{X}$ . The nominal traction can be written in terms of the a stress as

$$\mathbf{t}^0 = \mathbf{N} \cdot \mathbf{T}^0 \quad (23.20)$$

where  $\mathbf{N}$  is the unit normal in the reference configuration and the stress  $\mathbf{T}^0$  is the nominal stress (or First Piola-Kirchhoff stress) rather than the Cauchy stress. The divergence theorem can be applied in the reference configuration to write the first term as

$$\int_A \mathbf{N} \cdot \mathbf{t}^0 ds = \int_V \nabla_{\mathbf{X}} \cdot \mathbf{T}^0 dV \quad (23.21)$$

where the subscript  $\mathbf{X}$  emphasizes that the derivatives in the divergence are with respect to position in the reference configuration. Using (23.3) and bringing the derivative inside the integral gives

$$\int_V \left\{ \nabla_{\mathbf{X}} \cdot \mathbf{T}^0 + \rho_0 \mathbf{b}^0 - \rho_0 \frac{\partial \mathbf{v}}{\partial t} \right\} dV = 0 \quad (23.22)$$

Since this integral must vanish for *any* material volume, the integrand must vanish.

$$\nabla_{\mathbf{X}} \cdot \mathbf{T}^0 + \rho_0 \mathbf{b}^0 = \rho_0 \frac{\partial \mathbf{v}}{\partial t} \quad (23.23)$$

or, in component form

$$\frac{\partial T_{ij}^0}{\partial X_i} + \rho_0 b_j^0 = \rho_0 \frac{\partial v_j}{\partial t} \quad (23.24)$$

The connection between the Cauchy stress  $\mathbf{T}$  and the nominal stress  $\mathbf{T}^0$  can be established by noting that both must give the same increment of current force  $d\mathbf{P}$

$$d\mathbf{P} = \mathbf{n} \cdot \mathbf{T} da = \mathbf{N} \cdot \mathbf{T}^0 dA \quad (23.25)$$

Nanson's formula

$$\mathbf{n} da = \det(\mathbf{F})(\mathbf{N} \cdot \mathbf{F}^{-1}) dA \quad (23.26)$$

relates the current and reference area elements. Hence, the nominal stress tensor is related to the Cauchy stress by

$$\mathbf{T}^0 = \det(\mathbf{F}) \mathbf{F}^{-1} \cdot \mathbf{T} \quad (23.27)$$

### 23.2.2 Angular Momentum

The balance of angular momentum can also be expressed in terms of the reference area and volume:

$$\int_A \mathbf{x} \times \mathbf{t}^0 dA + \int_V \mathbf{x} \times \rho_0 \mathbf{b}^0 dV = \frac{\partial}{\partial t} \int_V \mathbf{x} \times \rho_0 \mathbf{v} dV \quad (23.28)$$

or in component form

$$\int_A \epsilon_{ijk} x_j t_k^0 dA + \int_V \epsilon_{ijk} x_j \rho_0 b_k^0 dV = \frac{\partial}{\partial t} \int_V \rho \epsilon_{ijk} x_j v_k dV \quad (23.29)$$

Note that  $\mathbf{x}$  not  $\mathbf{X}$  appears in these expressions because the current moment and angular momentum are the cross product of the current location with the current force and linear momentum even though these are expressed in terms of integrals over the reference area and volume. As before the traction can be expressed in terms of the stress as in (23.20) and the divergence theorem can be used to rewrite the surface integral as a volume integral

$$\int_A \epsilon_{ijk} x_j t_k^0 dA = \int_V \epsilon_{ijk} \frac{\partial}{\partial X_l} \{x_j T_{lk}^0\} dV \quad (23.30a)$$

$$= \int_V \epsilon_{ijk} \left[ \frac{\partial x_j}{\partial X_l} T_{lk}^0 + x_j \frac{\partial T_{lk}^0}{\partial X_l} \right] dV \quad (23.30b)$$

Note that in contrast to the derivation in terms of the current configuration, the derivative in the first term becomes

$$\frac{\partial x_j}{\partial X_l} = F_{jl} \quad (23.31)$$

rather than  $\delta_{jl}$ . Because the integral on the right side is over the reference volume, the derivative can be taken inside without recourse to Reynolds' Transport theorem. When the balance of linear momentum (23.23) is used, the only term remaining is

$$\int_V \epsilon_{ijk} F_{jl} T_{ik}^0 dV = 0 \quad (23.32)$$

Because the integral must vanish for all volumes  $V$ , the integrand must be zero

$$\epsilon_{ijk} F_{jl} T_{ik}^0 = 0 \quad (23.33)$$

which requires that

$$\mathbf{F} \cdot \mathbf{T}^0 = (\mathbf{F} \cdot \mathbf{T}^0)^T \quad (23.34)$$

Because the deformation gradient  $\mathbf{F}$  is not, in general, symmetric, the nominal stress will not be symmetric. But since the nominal and Cauchy stress are related by (24.22) the (23.34) is equivalent to the requirement that the Cauchy stress be symmetric.

### 23.3 Additional Reading

Malvern, Sec. 5.3, pp. 213-217, pp. 220-224; pp. 226-231; Chadwick, Chapter 3, Sec. 4; Aris, 5.11-5.13.





## Chapter 24

# Conservation of Energy

Conservation of energy results from application of the first law of thermodynamics to a continuum. The first law states that the change in total energy of a system is equal to the sum of the work done on the system and the heat added to the system. Thus, in rate form the first law is

$$\frac{d}{dt}(\text{Total Energy}) = P_{in} + Q_{in} \quad (24.1)$$

where  $P_{in}$  is the power input and  $Q_{in}$  is the heat input. Although neither heat nor work is an exact differential (does not integrate to a potential function), their sum is. Consequently, the integral of the energy change around a cycle is zero.

$$\oint dE_{\text{total}} = \oint (P_{\text{input}} + Q_{\text{input}}) dt = 0 \quad (24.2)$$

The total energy is the sum of the kinetic energy

$$\int_{\mathbf{v}} \frac{1}{2} \rho \mathbf{v} \cdot \mathbf{v} dv \quad (24.3)$$

where  $\mathbf{v}$  is the velocity, and the internal energy

$$\int_{\mathbf{v}} \rho u dv \quad (24.4)$$

where  $u$  is the internal energy per unit mass. The heat input is

$$- \int_a \mathbf{q} \cdot \mathbf{n} da + \int_v \rho r dv \quad (24.5)$$

where  $\mathbf{q}$  is the heat flux,  $\mathbf{n}$  is the outward normal, and  $r$  is the source term.

The power input is the work of the forces on the velocities

$$P_{\text{input}} = \int_a \mathbf{t} \cdot \mathbf{v} da + \int_v \rho \mathbf{b} \cdot \mathbf{v} dv \quad (24.6)$$

Expressing the traction in terms of the stress and using the divergence theorem yields the following for the first term

$$\int_a \mathbf{t} \cdot \mathbf{v} da = \int_v \mathbf{n} \cdot \mathbf{T} \cdot \mathbf{v} dv = \int_v \nabla \cdot (\mathbf{T} \cdot \mathbf{v}) dv \quad (24.7)$$

To work out  $\nabla \cdot (\mathbf{T} \cdot \mathbf{v})$  it is more convenient to use index notation

$$\nabla \cdot (\mathbf{T} \cdot \mathbf{v}) = \mathbf{e}_k \frac{\partial}{\partial x_k} \cdot (T_{ij} v_j \mathbf{e}_i) = \frac{\partial}{\partial x_i} (T_{ij} v_j) \quad (24.8a)$$

$$= \frac{\partial T_{ij}}{\partial x_i} v_j + T_{ij} \frac{\partial v_j}{\partial x_i} \quad (24.8b)$$

$$= (\nabla \cdot \mathbf{T}) \cdot \mathbf{v} + \mathbf{T} \cdot \mathbf{L} \quad (24.8c)$$

where

$$\mathbf{T} \cdot \mathbf{L} = \mathbf{T} \cdot \mathbf{D} \quad (24.9)$$

since

$$\mathbf{T} = \mathbf{T}^T \quad (24.10)$$

The first term in (24.8c) can be rewritten using the equation of motion (23.7)

$$\nabla \cdot \mathbf{T} = -\rho \mathbf{b} + \rho \frac{d\mathbf{v}}{dt} \quad (24.11)$$

Substituting back into (24.6) yields

$$P_{\text{input}} = \int_v \rho \frac{1}{2} \frac{d}{dt} (\mathbf{v} \cdot \mathbf{v}) dv + \int_v \mathbf{T} \cdot \mathbf{L} dv \quad (24.12)$$

Using Reynold's transport theorem

$$\frac{d}{dt} \int_v \frac{1}{2} \rho \mathbf{v} \cdot \mathbf{v} dv = \int_v \frac{1}{2} \rho \frac{d}{dt} (\mathbf{v} \cdot \mathbf{v}) dv \quad (24.13)$$

and substituting back into (24.1) yields

$$\frac{d}{dt} (K.E.) + \frac{d}{dt} \int \rho u dv = \frac{d}{dt} (K.E.) + \int_v \mathbf{T} \cdot \mathbf{L} dv - \int_a \mathbf{q} \cdot \mathbf{n} da + \int_v \rho r dv \quad (24.14a)$$

Cancelling the common term on both sides and using Reynold's transport theorem on the internal energy term gives

$$\int_v \left\{ \rho \frac{du}{dt} - \mathbf{T} \cdot \mathbf{L} + \nabla \cdot \mathbf{q} - \rho r \right\} dv = 0 \quad (24.15)$$

Since this applies for all  $v$

$$\rho \dot{u} = \mathbf{T} \cdot \mathbf{L} - \nabla \cdot \mathbf{q} + \rho r \quad (24.16)$$

This equation says that the internal energy of a continuum can be changed by the work of deformation,  $\mathbf{T} \cdot \cdot \mathbf{L}$ , the flow of heat,  $-\nabla \cdot \mathbf{q}$ , or internal heating,  $\rho r$ .

Similar to the derivations of the momentum balance equations, the energy equation can be expressed in terms of quantities per unit area and volume of the reference configuration. The result is

$$\rho_o \frac{\partial u}{\partial t} = \mathbf{T}^0 \cdot \cdot \dot{\mathbf{F}} - \nabla_x \cdot \mathbf{Q} + \rho_o R \quad (24.17)$$

where  $\mathbf{Q}$  is the heat flux per unit reference area

$$\mathbf{Q} = J\mathbf{F}^{-1} \cdot \mathbf{q} \quad (24.18)$$

and  $\rho_o R$  is the rate of internal heating per unit reference volume.

## 24.1 Work Conjugate Stresses

The first term on the right side of (24.17) is the rate of stress working per unit reference volume (or, equivalently, per unit mass)

$$\dot{W}_0 = \mathbf{T}^0 \cdot \cdot \dot{\mathbf{F}} \quad (24.19)$$

Since the first term on the right side of (24.16) is the rate of stress working per unit current volume, it is related to (24.19) by

$$\dot{W}_0 = J\mathbf{T} \cdot \cdot \mathbf{L} = J\mathbf{T} : \mathbf{D} \quad (24.20)$$

where the second equality makes use of the symmetry of  $\mathbf{T}$ . The relation between the Cauchy stress and the nominal stress can be obtained by equating the two expressions (24.19) and (24.20)

$$\mathbf{T}^0 \cdot \cdot \dot{\mathbf{F}} = J\mathbf{T} \cdot \cdot \mathbf{L} \quad (24.21)$$

Substituting  $\dot{\mathbf{F}} = \mathbf{L} \cdot \mathbf{F}$  in the left side gives

$$\mathbf{T}^0 \cdot \cdot (\mathbf{L} \cdot \mathbf{F}) = J\mathbf{T} \cdot \cdot \mathbf{L} \quad (24.22)$$

The identity

$$\mathbf{A} \cdot \cdot \mathbf{B} \cdot \mathbf{C} = \mathbf{A} \cdot \mathbf{B} \cdot \cdot \mathbf{C} = \mathbf{C} \cdot \mathbf{A} \cdot \cdot \mathbf{B} = \mathbf{B} \cdot \mathbf{C} \cdot \cdot \mathbf{A} \quad (24.23)$$

for any tensors  $\mathbf{A}$ ,  $\mathbf{B}$  and  $\mathbf{C}$  can be used to rearrange (24.22) as

$$(\mathbf{F} \cdot \mathbf{T}^0 - J\mathbf{T}) \cdot \cdot \mathbf{L} = 0 \quad (24.24)$$

Since this must apply for any velocity gradient tensor  $\mathbf{L}$ , the coefficient must vanish and, therefore, the nominal stress is given by the same relation derived from Nanson's formula for the current and reference areas:

$$\mathbf{T}^0 = J\mathbf{F}^{-1} \cdot \mathbf{T} \quad (24.25)$$

In both (24.19) and (24.20)  $\dot{W}_0$  is the product of a stress tensor and a deformation rate measure. The stress measure is said to be *work conjugate* to the rate of deformation measure. Note that the stress measure work conjugate to  $\mathbf{L}$  or  $\mathbf{D}$  is *not* the Cauchy stress but the Kirchhoff stress, which is the product

$$\boldsymbol{\tau} = J\mathbf{T} \quad (24.26)$$

This distinction, although small if volume changes are small, can be important in numerical formulations. Even though  $\mathbf{T}$  and  $\mathbf{D}$  are both symmetric, the stiffness matrix is guaranteed to be symmetric only if the formulation is expressed in terms of the work-conjugate stress measure  $\boldsymbol{\tau}$ .

More generally, the relation for the rate of stress working per unit reference volume can be used to define symmetric stress tensors  $\mathbf{S}$  that are work conjugate to the rate of any material strain tensor  $\dot{\mathbf{E}}$  (Since the rate of a material strain tensor is symmetric, there is no point in retaining any anti-symmetric part to the conjugate stress tensor since it does not contribute to  $\dot{W}_0$ .) Thus, writing

$$\dot{W}_0 = \mathbf{S} : \dot{\mathbf{E}} \quad (24.27)$$

and equating to (24.19) or (24.20) defines  $\mathbf{S}$  for a particular rate of material strain  $\dot{\mathbf{E}}$ . For example, determine the stress measure that is work-conjugate to the rate of Green-Lagrange strain  $\dot{\mathbf{E}}^G$

$$\dot{W}_0 = J\mathbf{T} : \mathbf{D} = \mathbf{S}^{PK2} : \dot{\mathbf{E}}^G \quad (24.28)$$

Using the relation between the rate of Green-Lagrange strain and the rate of deformation

$$\dot{\mathbf{E}}^G = \mathbf{F}^T \cdot \mathbf{D} \cdot \mathbf{F} \quad (24.29)$$

and (24.23) yields

$$(J\mathbf{T} - \mathbf{F} \cdot \mathbf{S}^{PK2} \cdot \mathbf{F}^T) : \mathbf{D} = 0 \quad (24.30)$$

Since this must apply for any  $\mathbf{D}$ , the work-conjugate stress is given by

$$\mathbf{S}^{PK2} = \mathbf{F}^{-1} \cdot J\mathbf{T} \cdot (\mathbf{F}^T)^{-1} \quad (24.31)$$

and it is clearly symmetric. This stress measure is called the 2nd Piola-Kirchhoff stress.

The 2nd Piola-Kirchhoff stress has the advantages that it is symmetric and that it is work-conjugate to the rate of the Green-Lagrange strain. It does, however, have the disadvantage that its interpretation in terms of a force element is less straightforward than either the Cauchy stress  $\mathbf{T}$  or the nominal stress  $\mathbf{T}^0$ . The force increment is related to the traction vector determined from  $\mathbf{S}^{PK2}$  by

$$\mathbf{N}dA \cdot \mathbf{S}^{PK2} = \mathbf{F}^{-1} \cdot d\mathbf{P}$$

Thus, the traction derived from  $\mathbf{S}^{PK2}$  is related to the force per reference area but altered by  $\mathbf{F}^{-1}$ . The components of this traction do have a direct interpretation in terms of force components expressed in terms of base vectors that convect (are deformed with the material).

## **24.2 Additional Reading**

Malvern, Sec. 5.4, pp. 226-231; Chadwick, Chapter 3, Sec. 5; Aris, 6.3.



## **Part V**

# **Ideal Constitutive Relations**





---

Thus far, we have analyzed stress, strain, rate-of-deformation and the laws expressing conservation of mass, momentum and energy. We have not, however, included a discussion of the behavior of different materials. Generally, this behavior is complex, but we endeavor to include it in terms of idealized relationships between stress and strain or rate-of-deformation. Ultimately, such relationships derive from experiments, but they generally apply only for a limited range of states, i.e. temperature, loading rate, time-scale, etc. Crudely, materials can be divided into solids (which can sustain shear stress at rest) and fluids (which cannot) but many materials combine aspects of both. In the following subsections, we will consider only the simplest relations.



# Chapter 25

## Fluids

### 25.1 Ideal Frictionless Fluid

Observations indicate that a fluid at rest or in uniform motion cannot support shear stress. Consequently, the stress must have the form

$$T_{ij} = -p\delta_{ij} \quad (25.1)$$

where  $p$  is a pressure, but is not necessarily equal to the thermodynamic pressure. Since  $p$  is an unknown, another equation is needed to determine it. Often this is an equation of state or “kinetic equation of state,” of the form

$$F(p, \rho, \theta) = 0 \quad (25.2)$$

where  $\rho$  is the mass density and  $\theta$  is the temperature. A simple example of such an equation is the perfect gas law

$$p = \rho R\theta \quad (25.3)$$

where  $R$  is the universal gas constant. Alternatively, the internal energy (per unit mass or reference volume) can be prescribed as a function of the density and the temperature:

$$u = u(\theta, \rho) \quad (25.4)$$

In this form, it is typically called the “caloric equation of state”.

If temperature does not play a role, the flow is said to be “barotropic” and the pressure is related to the density by an equation of the form

$$f(p, \rho) = 0 \quad (25.5)$$

An equation of state (25.2) reduces to this form for either isothermal ( $\theta = \text{const.}$ ) or isentropic (reversible, adiabatic) conditions. For example, for isentropic flow of a perfect gas

$$\frac{p}{\rho^\gamma} = \text{const.} \quad (25.6)$$

In this equation

$$\gamma = \frac{c_p}{c_v} = 1 + \frac{R}{c_v} \quad (25.7)$$

where  $c_p$  and  $c_v$  are the specific heat at constant pressure and constant volume, respectively. For dry air,  $\gamma = 1.4$ .

Recall that conservation of energy is expressed by the equation (24.16)

$$\rho \dot{u} = \mathbf{T} \cdot \mathbf{D} - \nabla \cdot \mathbf{q} + \rho r$$

where  $r$  is a heat source per unit mass and  $\mathbf{q}$  is the flux of heat (out of the body) (and  $\mathbf{D}$  replaces  $\mathbf{L}$  in (24.16) because  $\mathbf{T}$  is symmetric). Substituting (25.1) and using conservation of mass (22.20c) gives

$$\rho \dot{u} = p \frac{1}{\rho} \frac{d\rho}{dt} - \nabla \cdot \mathbf{q} + \rho r \quad (25.8)$$

If the internal energy per unit mass (25.4) is regarded as a function of  $1/\rho$ , the specific volume (rather than the density), and the temperature  $\theta$ , then the material derivative of  $u$  on left side of (25.8) can be written as

$$\dot{u} = \frac{\partial u}{\partial(1/\rho)} \frac{d(1/\rho)}{dt} + c_v \frac{d\theta}{dt} \quad (25.9)$$

where  $c_v = \partial u / \partial \theta$  is the specific heat at constant volume. Substituting (25.9) into (25.8) and rearranging gives

$$\rho c_v \frac{d\theta}{dt} = \frac{1}{\rho} \frac{d\rho}{dt} \left( p + \frac{\partial u}{\partial(1/\rho)} \right) + \rho r - \nabla \cdot \mathbf{q} \quad (25.10)$$

At constant temperature, all but the first term on the right vanishes and (25.10) requires that

$$p = - \frac{\partial u}{\partial(1/\rho)}$$

This equation provides a constitutive relation for the pressure in terms of the dependence of the energy on the specific volume. According to the terminology used earlier the pressure and specific volume are work-conjugate variables.

If the material is incompressible so that  $d\rho/dt = 0$ , then the mechanical response uncouples from the thermal response governed by

$$\rho c_v \frac{d\theta}{dt} = \rho r - \nabla \cdot \mathbf{q} \quad (25.11)$$

The rate of heating per unit mass  $r$  is regarded as prescribed but a constitutive equation is needed to relate the heat flux  $\mathbf{q}$  to the temperature. (Considerations based on the Second Law of Thermodynamics, not discussed here, indicate that these are the proper variables to relate). Typically, this relation is taken to be Fourier's Law, which states that the heat flux is proportional to the negative gradient of temperature

$$\mathbf{q} = -\boldsymbol{\kappa} \cdot \nabla \theta \text{ or } q_i = -\boldsymbol{\kappa}_{ij} \partial \theta / \partial x_j \quad (25.12)$$

The thermal conductivity tensor  $\varkappa$  depends on the material. Again, Second Law considerations require that it be symmetric  $\varkappa = \varkappa^T$ . If  $\varkappa$  does not depend on position, then the material is said to be *homogeneous* (with respect to heat conduction). If the material has no directional properties and heat conduction is the same in all directions, then the material is *isotropic*. In this case,  $\varkappa$  is an isotropic tensor of the form

$$\varkappa = k\mathbf{I} \quad (25.13)$$

Substituting into (25.12) and then (25.11) gives

$$\rho c_v \frac{d\theta}{dt} = \rho r + k\nabla^2\theta \quad (25.14)$$

If the material is rigid or if the velocity is small enough so that  $d\theta/dt \approx \partial\theta/\partial t$ , then (25.14) reduces to the usual form of the heat equation

$$\frac{\partial\theta}{\partial t} = r/c_v + \alpha\nabla^2\theta \quad (25.15)$$

where  $\alpha = k/\rho c_v$  is the thermal diffusivity (with dimensions of length<sup>2</sup> per time).

## 25.2 Isotropic tensors

Isotropic tensors have same components in all rectangular cartesian coordinate systems (see Aris, sec.2.7, pp. 30-34). All scalars (tensors of order zero) are isotropic. No vectors (except the null vector) are isotropic. For second order tensors, the components in different rectangular coordinate systems are related by

$$T'_{ij} = A_{ki}A_{lj}T_{kl} \quad (25.16)$$

where the  $T'_{ij}$  are components with respect to orthonormal base vectors  $\mathbf{e}'_i$ , the  $T_{kl}$  are components with respect to orthonormal base vectors  $\mathbf{e}_k$  and  $A_{ki} = \mathbf{e}'_i \cdot \mathbf{e}_k$ . For an isotropic second order tensor  $T'_{ij} = T_{ij}$  and, hence,

$$T_{ij} = A_{ki}A_{lj}T_{kl} \quad (25.17)$$

for all  $A_{ki}$ . It is straightforward to verify that any tensor of the form

$$T_{ij} = \alpha\delta_{ij} \quad (25.18)$$

satisfies this relation. Substituting (25.18) into (25.16) gives

$$T'_{ij} = \alpha A_{ki}A_{kj} = \alpha\delta_{ij}$$

This demonstrates that the identity tensor multiplied by a scalar is an isotropic tensor but does not answer the question of whether all isotropic tensors of second order must have this form. To do this, we again use (25.17). If

this equation must be satisfied for all  $A_{ki}$  then it must certainly be satisfied for particular choices of the  $A_{ki}$ . Judicious choice of the  $A_{ki}$  demonstrates that all isotropic second order tensors must have the form (25.18).

First, consider the transformation for which  $A_{13} = A_{21} = A_{32} = 1$  are the only nonzero  $A_{ki}$ . This corresponds to a rotation of  $120^\circ$  about a line making equal angles with the coordinate axis (Figure ??) or, alternatively, the two successive rotations: first,  $90^\circ$  about the  $x_2$  axis, then  $90^\circ$  about the new  $x_3$  axis. Substituting into (25.17) gives

$$T_{11} = A_{i1}A_{j1}T_{ij} = T_{22} \quad (25.19a)$$

$$T_{22} = A_{i2}A_{j2}T_{ij} = T_{33} \quad (25.19b)$$

Thus, the three diagonal components of  $T_{ij}$  must be identical  $T_{11} = T_{22} = T_{33} = \alpha$ . Similarly, for the off-diagonal components,

$$T_{12} = A_{i1}A_{j2}T_{ij} = A_{31}A_{32}T_{31} = T_{31} \quad (25.20)$$

Thus, the off-diagonal components must also be identical

$$T_{12} = T_{21} = T_{31} = T_{13} = T_{23} = T_{32} = \beta$$

Now consider the transformation corresponding to a rotation of  $90^\circ$  about the  $x_3$  axis so that  $A_{12} = -1 = -A_{21} = -A_{33}$  are the only nonzero  $A_{ki}$ . Applying (25.17) to  $T_{12}$  gives

$$T_{12} = A_{21}A_{12}T_{12} = -T_{12}$$

Therefore  $\beta = 0$  and

$$T_{ij} = \alpha\delta_{ij} \quad (25.22)$$

is the only isotropic tensor of order two. A similar analysis can be used to show that the only isotropic tensor of 3rd order is  $\alpha\epsilon_{ijk}$ .

Tensor products of isotropic tensors are also isotropic. Therefore, 4th order tensors with components proportional to  $\delta_{ij}\delta_{kl}$  are also isotropic. In fact, all isotropic tensors of even order are sums and products of  $\delta_{ij}$ . The number of possible terms for a tensor of order  $N$  is given by the combinatorial formula

$$\frac{N!}{2^{(N/2)}(N/2)!} \quad (25.23)$$

where  $N!$  is the total number of order combinations,  $(N/2)!$  is the number of ordered ways in which the pairs can be arranged, e.g.,  $\delta_{ij}\delta_{kl} = \delta_{kl}\delta_{ij}$ , and  $2^{(N/2)}$  accounts for the switching of indicies of each pair, e.g.,  $\delta_{ij} = \delta_{ji}$ . Applying this formula for  $N = 4$  yields 3 possible combinations. Thus, the only isotropic tensor of 4th order has the form:

$$V_{ijkl} = a\delta_{ij}\delta_{kl} + b\delta_{ik}\delta_{jl} + c\delta_{il}\delta_{jk} \quad (25.24)$$

(See Malvern p.47, #17(c)). Fourth order tensors appearing in constitutive relations often have (or are assumed to have) the additional symmetry,  $V_{ijkl} = V_{klij}$ . Redefining  $b$  as  $b + c$  and  $c$  as  $b - c$  in (25.24) gives

$$V_{ijkl} = a\delta_{ij}\delta_{kl} + b(\delta_{ik}\delta_{jl} + \delta_{il}\delta_{jk}) + c(\delta_{ik}\delta_{jl} - \delta_{il}\delta_{jk}) \quad (25.25)$$

Therefore, for  $V_{ijkl} = V_{klij}$ ,  $c = 0$ , and only two parameters are needed to define the tensor.

### 25.3 Linearly Viscous Fluid

In a simple idealization of a fluid, the stress is taken to be the sum of hydrostatic term and a function of the rate-of-deformation.

$$\mathbf{T} = -p\mathbf{I} + f(\mathbf{D}) \quad (25.26)$$

where the function  $f$  vanishes when  $\mathbf{D} = 0$ . (Here the Cauchy stress is used but it would be more appropriate to use the Kirchhoff stress since this is work-conjugate to  $\mathbf{D}$ . However, volume changes are often negligible for viscous fluids and, consequently, the difference is small). Such a fluid is sometimes called *Stokesian* (although Stokes actually considered only a linear relation). If the stress depends linearly on the rate-of-deformation,

$$T_{ij} = -p\delta_{ij} + V_{ijkl}D_{kl} \quad (25.27)$$

the fluid is “Newtonian.” In this case the factors  $V_{ijkl}$  may depend on temperature but not on stress or deformation-rate. Because

$$T_{ij} = T_{ji} \quad (25.28)$$

and

$$D_{kl} = D_{lk} \quad (25.29)$$

we can assume without loss of generality that

$$V_{ijkl} = V_{jikl} = V_{ijlk} \quad (25.30)$$

If  $V_{ijkl}$  do not depend on *position*, then the material is said to be *homogeneous*.

Because there are 6 distinct components of  $T_{ij}$  and  $D_{ij}$ , there are a total of  $36 = 6 \times 6$  possible distinct components of  $V_{ijkl}$ . However, as noted above, the  $V_{ijkl}$  are often assumed to have the additional symmetry  $V_{ijkl} = V_{klij}$ , which reduces the number of possible distinct components to 27.

If the material response is completely independent of the orientation of axes, the material is said to be *isotropic*. In this case,  $\mathbf{V}$  is an isotropic tensor and, as discussed above, has form (25.25) with  $c = 0$  in because the coefficient term is anti-symmetric with respect to interchange of  $(ij)$  and  $(kl)$ . Substituting into (25.27) yields

$$T_{ij} = -p\delta_{ij} + \lambda\delta_{ij}D_{kk} + 2\mu D_{ij} \quad (25.31)$$

where  $\lambda$  and  $\mu$  are the only two parameters reflecting material response. These parameters appear separately in the mean and deviatoric parts of (25.31)

$$T'_{ij} = 2\mu D'_{ij} \quad (25.32a)$$

$$T_{kk} = 3\kappa D_{kk} - 3p \quad (25.32b)$$

where  $\mu$  is the viscosity and  $\kappa = \lambda + 2\mu/3$  is the bulk viscosity. If the material is incompressible,  $\kappa \rightarrow \infty$ , or if the flow is isochoric (involves no volume change),  $D_{kk} = 0$ , and (25.31) reduces to

$$T_{ij} = 2\mu D_{ij} - p\delta_{ij} \quad (25.33)$$

Substituting (25.31) into the equation of motion (23.7)

$$\frac{\partial T_{ij}}{\partial x_i} + \rho b_j = \rho \frac{dv_j}{dt} \quad (25.34)$$

gives

$$\mu \frac{\partial}{\partial x_i} \left\{ \frac{\partial v_i}{\partial x_j} + \frac{\partial v_j}{\partial x_i} \right\} - \frac{\partial p}{\partial x_j} + \rho b_j = \rho \frac{dv_j}{dt} \quad (25.35a)$$

$$\mu \frac{\partial}{\partial x_j} \left( \frac{\partial v_i}{\partial x_i} \right) + \mu \nabla^2 v_j - \frac{\partial p}{\partial x_j} + \rho b_j = \rho \frac{dv_j}{dt} \quad (25.35b)$$

For incompressible flow  $\partial v_i/\partial x_i = 0$ , and (25.35b) reduces to

$$\mu \nabla^2 v_j - \frac{\partial p}{\partial x_j} + \rho b_j = \rho \frac{dv_j}{dt} \quad (25.36)$$

The viscosity  $\mu$  can be determined by a simple experiment. Consider a layer of fluid of height  $h$  between two parallel plates with lateral dimensions much greater than  $h$  (In actuality, this experiment is conducted in a rotary apparatus). The upper plate ( $x_2 = h$ ) is moved to the right (positive  $x_1$  direction) with velocity  $V$ . Consequently, the conditions on the fluid velocity at the boundaries are

$$v_1(x_2 = h) = v \quad (25.37a)$$

$$v_1(x_2 = 0) = 0 \quad (25.37b)$$

After a transient that occurs immediately after the plate begins moving the velocity in the fluid depends on position but not on time, i.e., the flow is steady and is linear through the layer:

$$v_1 = \frac{x_2}{h} V \quad (25.38)$$

The only nonzero component of  $D_{ij}$  is

$$D_{12} = \frac{1}{2} \left( \frac{\partial v_1}{\partial x_2} + \frac{\partial v_2}{\partial x_1} \right) = \frac{V}{2h} = \frac{1}{2} \dot{\gamma} \quad (25.39a)$$



and the shear stress  $\tau_{12}$  is the force applied to the plate divided by its contact area with the fluid. If a plot of  $\tau_{12}$  against  $\dot{\gamma}$  is linear, then the fluid is Newtonian and viscosity is  $\mu$ . The viscosity is typically measured in the SI units of Poise which is equal to 1 dyne-sec/cm<sup>2</sup>. In Poise, representative viscosities for water, air and SAE 30 oil are  $10^{-2}$ ,  $1.8 \times 10^{-4}$  and 0.67.

## 25.4 Additional Reading

Malvern, Sec. 6.1, pp. 273-278; Sec. 7.1, pp. 423-434; Chadwick, Chp. 4, Sec. 7, pp. 149-154.



# Chapter 26

## Elasticity

### 26.1 Nonlinear Elasticity

The simple fluid constitutive relations we have considered depend only on the rate-of-deformation (rather than the strain) and, hence, the issue of the appropriate large strain measure does not arise. The response of solids does, in general, depend on the strain. Fortunately, for many applications, the magnitude of the strain is small, and this makes it possible to consider a linearized problem that introduces considerable simplification. Although this is often a very good approximation, it should be noted that it is an approximation that is strictly valid for infinitesimal displacement gradients and needs to be reevaluated whenever this is not the case.

A minimal definition of an elastic material is one for which the stress depends only on the deformation gradient (rather than, say, the deformation history, or various internal variables)

$$\mathbf{T} = \mathbf{g}(\mathbf{F}) \quad (26.1)$$

This formulation is typically referred to as *Cauchy elasticity*. Other features often associated with elasticity are the existence of a strain energy function, a one-to-one relation between stress and strain measures, that deformation does not result in any energy loss, or that the body recovers its initial shape upon unloading.

Since the relation (26.1) reflects material behavior we expect it to be independent of rigid body rotations. This is called the *principle of frame indifference* or *material objectivity*. A consequence is that the relation (26.1) should depend only on the deformation  $\mathbf{U}$  and not the rotation  $\mathbf{R}$  in the polar decomposition  $\mathbf{F} = \mathbf{R} \cdot \mathbf{U}$ . If we consider a pure deformation  $\mathbf{U}$ , then (26.1) becomes

$$\mathbf{T} = T_{KL} \mathbf{N}_K \mathbf{N}_L = \mathbf{g}(\mathbf{U}) \quad (26.2)$$

where  $T_{KL}$  are components of the Cauchy stress with respect to the principal axes of  $\mathbf{U}$  in the reference state. For an isotropic material only the diagonal components of  $T_{KL}$  would be non-zero; in other words the principal axes of the

stress and deformation would coincide. Application of a rotation  $\mathbf{R}$  does not cause any stretching or additional stress so that

$$\mathbf{T} = T_{KL} \mathbf{n}_K \mathbf{n}_L \quad (26.3)$$

In other words, the axes in the material have rotated from the  $\mathbf{N}_K$  to the  $\mathbf{n}_K$  but the stress components are the same. Since  $\mathbf{n}_K = \mathbf{R} \cdot \mathbf{N}_K = \mathbf{N}_K \cdot \mathbf{R}^T$ , (26.3) becomes

$$\mathbf{T} = \mathbf{R} \cdot (T_{KL} \mathbf{N}_K \mathbf{N}_L) \cdot \mathbf{R}^T \quad (26.4a)$$

$$\mathbf{T} = \mathbf{R} \cdot \mathbf{g}(\mathbf{U}) \cdot \mathbf{R} \quad (26.4b)$$

where the second line uses (26.1). The result can be rewritten

$$\mathbf{R}^T \cdot \mathbf{T} \cdot \mathbf{R} = \mathbf{g}(\mathbf{U}) \quad (26.5)$$

The quantity on the left side is sometimes referred to as the rotationally invariant Cauchy stress  $\hat{\mathbf{T}}$ . Independence of the constitutive relation to rigid body rotations requires that  $\hat{\mathbf{T}}$  be a function of the deformation  $\mathbf{U}$ .

Because  $\mathbf{U}$  and  $\mathbf{R}$  are not easily computed, it is more convenient to rewrite (26.5) in a different form by defining

$$\mathbf{g}(\mathbf{U}) = \mathbf{U} \cdot \mathbf{h}(\mathbf{U}^2) \cdot \mathbf{U} \quad (26.6)$$

Substituting (26.6) into (26.5), multiplying from the right by  $\mathbf{R}$  and from the left by  $\mathbf{R}^T$  and noting that  $\mathbf{F}^T \cdot \mathbf{F} = \mathbf{U}^2$  gives

$$\mathbf{T} = \mathbf{F} \cdot \mathbf{h}(\mathbf{F}^T \cdot \mathbf{F}) \cdot \mathbf{F}^T \quad (26.7)$$

Because the second Piola-Kirchhoff stress is related by to Cauchy stress by

$$\mathbf{S} = J \mathbf{F}^{-1} \cdot \mathbf{T} \cdot \mathbf{F} \quad (26.8)$$

substituting from (26.7) yields

$$\mathbf{S} = J \mathbf{h}(\mathbf{F}^T \cdot \mathbf{F}) \quad (26.9)$$

Writing in terms of the Green-Lagrange strain

$$\mathbf{E} = \frac{1}{2} (\mathbf{F}^T \cdot \mathbf{F} - \mathbf{I}) \quad (26.10)$$

gives

$$\mathbf{S} = \mathbf{k}(\mathbf{E}) \quad (26.11)$$

Hence, a material relation having the form (26.11) is guaranteed to be independent of rigid body rotations. More generally, any relation of this form where  $\mathbf{E}$  is a material strain tensor and  $\mathbf{S}$  is its work-conjugate stress tensor will possess this property.

## 26.2 Linearization of Elasticity Equations

The equation of motion in reference configuration is given by (23.24)

$$\frac{\partial T_{ij}^\circ}{\partial X_i} + \rho^\circ b_j^\circ = \rho^\circ \frac{\partial^2 u_j}{\partial t^2} \quad (26.12)$$

where

$$\mathbf{T}^\circ = J\mathbf{F}^{-1} \cdot \mathbf{T} \quad (26.13)$$

is the nominal stress (24.22),  $b_j^\circ$  is the body force per unit reference mass and all quantities are to be thought of as functions of functions of position in the reference configuration  $\mathbf{X}$  and time. On the boundary of the body, the nominal stress is related to the nominal traction by

$$N_i T_{ij}^\circ = t_j^\circ \quad (26.14)$$

The stress-strain relation has the form (26.11) where  $\mathbf{S}$  is the 2nd Piola-Kirchhoff stress (26.8) and  $\mathbf{E}$  is the Green's strain (26.10). Alternatively, if a strain energy function  $W$  exists and is symmetrized in  $E_{ij}$  and  $E_{ji}$ , the stress-strain relation can be expressed as

$$S_{ij} = \frac{\partial W}{\partial E_{ij}} \quad (26.15)$$

Now, we expand the stress-strain relation in a Taylor series:

$$S_{ij} = (S_{ij})_{\mathbf{E}=0} + C_{ijkl} E_{kl} + B_{ijklmn} E_{kl} E_{mn} + \dots \quad (26.16)$$

Since deformation is measured from the reference state

$$(S_{ij})_{\mathbf{E}=0} = \bar{T}_{ij} \quad (26.17)$$

where  $\bar{T}_{ij}$  is the Cauchy stress in the reference state. The Green-Lagrange strain is given in terms of the displacement gradients as

$$E_{ij} = \frac{1}{2} \left( \frac{\partial u_i}{\partial X_j} + \frac{\partial u_j}{\partial X_i} + \frac{\partial u_k}{\partial X_i} \frac{\partial u_k}{\partial X_j} \right) \quad (26.18)$$

Substituting into (26.16) and retaining only terms that are linear in displacement gradients gives

$$S_{ij} = \bar{T}_{ij} + C_{ijkl} \epsilon_{kl} + 0 \left[ \left| \frac{\partial u_i}{\partial X_j} \right|^2 \right] \quad (26.19)$$

where

$$\epsilon_{kl} = \frac{1}{2} \left( \frac{\partial u_k}{\partial X_l} + \frac{\partial u_l}{\partial X_k} \right) \quad (26.20)$$

is the infinitesimal strain tensor.

Because the nominal stress  $\mathbf{T}^\circ$  appears in the equations of motion, we wish to convert (26.19). The nominal stress is related to the 2nd Piola-Kirchhoff stress by

$$\mathbf{T}^\circ = \mathbf{S} \cdot \mathbf{F}^T \quad (26.21a)$$

or in index form

$$T_{ij}^o = S_{ik} F_{kj}^T = S_{ik} F_{jk} = S_{ik} F_{jk} \quad (26.22)$$

Expressing the deformation gradient in terms of the displacement gradient

$$F_{jk} = \frac{\partial x_j}{\partial X_k} = \delta_{jk} + \frac{\partial u_j}{\partial X_k} = \delta_{jk} + u_{j,k} \quad (26.23)$$

and substituting into (26.22) gives

$$T_{ij}^o = S_{ij} + S_{ik} u_{j,k} \quad (26.24a)$$

and using (26.19) gives the constitutive relation in the form

$$T_{ij}^o = \bar{T}_{ij} + C_{ijkl} \epsilon_{kl} + \bar{T}_{ij} u_{j,k} + \dots \quad (26.25)$$

to first order in the displacement gradients.

We assume that the reference state itself is an equilibrium state and, thus, satisfies:

$$\frac{\partial \bar{T}_{ij}}{\partial X_i} + \rho^o \bar{b}_j^o = 0 \quad (26.26)$$

where  $\rho^o \bar{b}_j^o$  is the body force (in reference state) per unit unit mass and that the surface traction in reference state  $\bar{t}_j^o$  is

$$N_i \bar{T}_{ij} = \bar{t}_j^o \quad (26.27)$$

Substituting (26.25) into (26.12) and (26.14) gives

$$\frac{\partial}{\partial X_i} \left\{ \bar{T}_{ij} + C_{ijkl} \epsilon_{kl} + \bar{T}_{ik} \frac{\partial u_j}{\partial X_k} \right\} + \rho^o b_j^o = \rho^o \frac{\partial^2 u_j}{\partial t^2} \quad (26.28a)$$

$$N_i \left\{ \bar{T}_{ij} + C_{ijkl} \epsilon_{kl} + \bar{T}_{ik} \frac{\partial u_j}{\partial X_k} \right\} = t_j^o \quad (26.28b)$$

Subtracting (26.26) and (26.27) yields

$$\frac{\partial}{\partial X_i} \left\{ C_{ijkl} \epsilon_{kl} + \bar{T}_{ik} \frac{\partial u_j}{\partial X_k} \right\} + \rho_o (b_j^o - \bar{b}_j^o) = \rho^o \frac{\partial^2 u_j}{\partial t^2} \quad (26.29)$$

and

$$N_i \{ C_{ijkl} \epsilon_{kl} \} = t_j^o - \bar{t}_j^o - N_i \bar{T}_{ik} \frac{\partial u_j}{\partial X_k} \quad (26.30)$$

where

$$\frac{\partial u_j}{\partial X_k} = \frac{1}{2} \left( \frac{\partial u_j}{\partial X_k} + \frac{\partial u_k}{\partial X_j} \right) + \frac{1}{2} \left( \frac{\partial u_j}{\partial X_k} - \frac{\partial u_k}{\partial X_j} \right) \quad (26.31a)$$

$$= \epsilon_{jk} + w_{jk} \quad (26.31b)$$

$\epsilon_{jk} w_{jk}$  is the infinitesimal strain and  $w_{jk}$  infinitesimal rotation from the reference state.

When can the terms involving  $\bar{T}_{ik}$  be dropped so that the usual linear elasticity equations result? To recover classical elasticity the terms involving the displacement gradient in (26.29) and (26.30) must be negligible. One requirement is that the initial stress  $\bar{T}$  be much less than any members of  $C_{ijkl}$  or, expressed more simply, that

$$\bar{T} \ll E_{\text{tan}} \quad (26.32a)$$

where  $\bar{T}$  is a magnitude of  $\bar{T}_{ik}$ ,  $E_{\text{tan}}$  is a typical tangent modulus. For materials in the linear range  $E_{\text{tan}} \simeq E$ , Young's modulus, which is generally much larger than any pre-stress. However, for large pre-stress the terms involving  $\bar{T}$  may be important even if strains are infinitesimal. One example is the interior of the Earth where hydrostatic stress is very large even though strains due to propagation of waves are small. Alternatively, if the response is linearized about a stress state where the tangent modulus is the same order as the stress, then these terms may be important even though strains are small.

Because the displacement gradients are multiplied by the initial stress in (26.29) and (26.30), it is not sufficient only that the strains be small but also that the rotation be small in some sense. A condition expressing this is

$$\bar{T}w \ll E_{\text{tan}}\epsilon \quad (26.33)$$

where  $\epsilon$  and  $w$  are magnitudes of the strain and rotation, respectively. An example where this condition is not met is the buckling of a column. If  $\kappa$  is the curvature, strains are of the order

$$\epsilon \sim \kappa h \quad (26.34)$$

where  $h$  is the thickness of the column. The rotations are of the order

$$w \sim \kappa l \quad (26.35a)$$

where  $l$  is the length of the column. Since buckling typically occurs when  $l \gg h$ , rotations will be much larger than strains. A manifestation of this result is that buckling is one of the very few examples in elementary strength of materials where equilibrium is written for a deformed (slightly buckled) state of the body. As a final comment, note that actually it is the derivatives of the displacement gradients that enter the equilibrium equation and these may have magnitudes that are larger than those of the strains and rotations.

## 26.3 Linearized Elasticity

Here we specialize immediately to small (infinitesimal) displacement gradients and no pre-stress. This is the conventional formulation of *linear elasticity*. In this case, the stress  $\sigma_{ij}$  is related to the small (infinitesimal) strain tensor by

$$\sigma_{ij} = C_{ijkl}\epsilon_{kl} \quad (26.36)$$

where  $C_{ijkl}$  is an array of constants. In general,  $C_{ijkl}$  may have  $3^4 = 81$  components but because the stress is symmetric

$$\sigma_{ij} = \sigma_{ji} \quad (26.37)$$

and so is the strain

$$\varepsilon_{kl} = \varepsilon_{lk} \quad (26.38)$$

the number is reduced to  $6 \times 6 = 36$  constants. If, in addition, a strain-energy function exists, then  $C_{ijkl}$  satisfies the additional symmetry

$$C_{ijkl} = C_{klij} \quad (26.39)$$

To motivate the existence of a strain-energy function, recall the energy equation (24.16)

$$\rho \frac{du}{dt} = T_{ij} D_{ij} + \nabla \cdot \mathbf{q} + \rho \mathbf{r} \quad (26.40)$$

In the limits of either isothermal (constant temperature) or adiabatic (no heat transfer) deformation, the last two terms are absent and (26.40) reduces to

$$dW = \sigma_{ij} d\varepsilon_{ij} \quad (26.41)$$

where  $dW = \rho du$  is the change in strain energy and we have identified  $\sigma_{ij} = T_{ij}$  and  $d\varepsilon_{ij} = D_{ij} dt$ . It follows from (26.41) that

$$\sigma_{ij} = \frac{\partial W}{\partial \varepsilon_{ij}} \quad (26.42)$$

Comparing (26.36) and (26.42) gives

$$C_{ijkl} = \frac{\partial^2 W}{\partial \varepsilon_{ij} \partial \varepsilon_{kl}} \quad (26.43)$$

which implies (26.39) and

$$W = \frac{1}{2} \varepsilon_{ij} C_{ijkl} \varepsilon_{kl} \quad (26.44)$$

Because of the symmetries, (26.37) and (26.38), (26.36) relates 6 distinct components of stress to 6 distinct components of strain. Consequently, for an anisotropic material, it is often more convenient to treat  $\sigma_{ij}$  and  $\varepsilon_{ij}$  as 6 component vectors that are related by a  $6 \times 6$  matrix

$$\sigma_i = C_{ij} \varepsilon_j \quad (26.45)$$

or

$$\begin{bmatrix} \sigma_{11} \\ \sigma_{22} \\ \sigma_{33} \\ \sigma_{23} \\ \sigma_{31} \\ \sigma_{12} \end{bmatrix} = \begin{bmatrix} C_{11} & C_{12} & C_{13} & C_{14} & C_{15} & C_{16} \\ C_{21} & C_{22} & C_{23} & C_{24} & C_{25} & C_{26} \\ C_{31} & C_{32} & C_{33} & C_{34} & C_{35} & C_{36} \\ C_{41} & C_{42} & C_{43} & C_{44} & C_{45} & C_{46} \\ C_{51} & C_{52} & C_{53} & C_{54} & C_{55} & C_{56} \\ C_{61} & C_{62} & C_{63} & C_{64} & C_{65} & C_{66} \end{bmatrix} \begin{bmatrix} \varepsilon_{11} \\ \varepsilon_{22} \\ \varepsilon_{33} \\ 2\varepsilon_{23} \\ 2\varepsilon_{31} \\ 2\varepsilon_{12} \end{bmatrix} \quad (26.46)$$



where  $C_{11} = C_{1111}$ ,  $C_{12} = C_{1122}$ ,  $C_{13} = C_{1133}$ ,  $C_{14} = (C_{1123} + C_{1132})/2$ ,  $C_{15} = (C_{1131} + C_{1113})/2$ ,  $C_{16} = (C_{1112} + C_{1121})/2$  and so on. If a strain energy function exists, the symmetry (26.39) implies that  $C_{ij} = C_{ji}$  and this results in the reduction from 36 to 21 constants for an anisotropic linear elastic material.

### 26.3.1 Material Symmetry

The number of distinct components of  $C_{ijkl}$  can be reduced further if the material possesses any symmetries. One approach proceeds along the lines of the discussion of isotropic tensors (25.2). Because  $C_{ijkl}$  is a (4th order) tensor its components in a coordinate system with unit orthogonal base vector  $\mathbf{e}_i$  must be related to the components  $C'_{ijkl}$  in a system of base vectors  $\mathbf{e}'_i$  by

$$C'_{ijpq} = A_{ik}A_{jl}A_{pm}A_{qn}C_{klmn} \quad (26.47)$$

where  $A_{ik} = \mathbf{e}'_k \cdot \mathbf{e}_i$ . If the material possesses a symmetry such that tests of the material in two coordinate systems cannot distinguish between them, then, for those two coordinate systems,  $C'_{ijkl} = C_{ijkl}$  and hence

$$C_{ijpq} = A_{ik}A_{jl}A_{pm}A_{qn}C_{klmn} \quad (26.48)$$

Suppose, for example, the  $x_1x_2$  plane is a plane of symmetry. Then a coordinate change that reverses the  $x_3$  axis will not affect the behavior. For such a change  $A_{11} = A_{22} = -A_{33} = 1$  are the only nonzero  $A_{ij}$ . Thus

$$C_{1223} = A_{11}A_{22}A_{22}A_{33}C_{1223} = -C_{1223}$$

Hence  $C_{1223} = 0$ . Similar calculations show that any  $C_{klmn}$  having an odd number of 3's as indicies are zero.

Alternatively, consider the matrix formulation. For changes of coordinate system that are indistinguishable to the material

$$\sigma'_i = C_{ij}\epsilon'_j = C_{ij}\epsilon_j = \sigma_i \quad (26.49a)$$

Again, consider the but  $x_1x_2$  plane a plane of symmetry. Then  $\sigma'_1 = \sigma_1$  and it follows that

$$\begin{aligned} \sigma_1 &= C_{11}\epsilon_1 + C_{12}\epsilon_2 + C_{13}\epsilon_3 + C_{14}\epsilon_4 + C_{15}\epsilon_5 + C_{16}\epsilon_6 \\ &= C'_{11}\epsilon'_1 + C'_{12}\epsilon'_2 + C'_{13}\epsilon'_3 + C'_{14}\epsilon'_4 + C'_{15}\epsilon'_5 + C'_{16}\epsilon'_6 \\ &= \sigma_1 \end{aligned} \quad (26.50)$$

But the shear stresses  $2\epsilon_{32} = \epsilon_4$  and  $2\epsilon_{31} = \epsilon_5$  reverse sign under this transformation; that is

$$\epsilon'_4 = -\epsilon_4 \quad (26.51a)$$

$$\epsilon'_5 = -\epsilon_5 \quad (26.51b)$$

Therefore,

$$C_{14} = -C'_{14} = -C_{14} = 0 \quad (26.52a)$$

$$C_{15} = -C'_{15} = -C_{15} = 0 \quad (26.52b)$$

The remaining nonzero  $C_{ij}$  are

$$C_{ij} = \begin{bmatrix} C_{11} & C_{12} & C_{13} & 0 & 0 & C_{16} \\ C_{21} & C_{22} & C_{23} & 0 & 0 & C_{26} \\ C_{31} & C_{32} & C_{33} & 0 & 0 & C_{36} \\ 0 & 0 & 0 & C_{44} & C_{45} & 0 \\ 0 & 0 & 0 & C_{54} & C_{55} & 0 \\ C_{61} & C_{62} & C_{63} & 0 & 0 & C_{66} \end{bmatrix} \quad (26.53)$$

A single plane of symmetry is called *monoclinic*.

*Orthotropic* is symmetry with respect to 3 orthogonal planes. The 9 nonzero  $C_{ij}$  are

$$C_{ij} = \begin{bmatrix} C_{11} & C_{12} & C_{13} & 0 & 0 & 0 \\ C_{21} & C_{22} & C_{23} & 0 & 0 & 0 \\ C_{31} & C_{32} & C_{33} & 0 & 0 & 0 \\ 0 & 0 & 0 & C_{44} & 0 & 0 \\ 0 & 0 & 0 & 0 & C_{55} & 0 \\ 0 & 0 & 0 & 0 & 0 & C_{66} \end{bmatrix} \quad (26.54)$$

Note that the axial and shear stresses are completely uncoupled.

*Hexagonal symmetry* is symmetry with respect to  $60^\circ$  rotations. It turns out that this symmetry implies symmetry with respect to any rotation in the plane, which is the same as transverse isotropy. This leaves 5 nonzero  $C_{ij}$ .

$$C_{ij} = \begin{bmatrix} C_{11} & C_{12} & C_{13} & 0 & 0 & 0 \\ C_{21} & C_{11} & C_{13} & 0 & 0 & 0 \\ C_{31} & C_{31} & C_{33} & 0 & 0 & 0 \\ 0 & 0 & 0 & C_{44} & 0 & 0 \\ 0 & 0 & 0 & 0 & C_{44} & 0 \\ 0 & 0 & 0 & 0 & 0 & \frac{1}{2}(C_{11} - C_{12}) \end{bmatrix} \quad (26.55)$$

*Cubic symmetry* has 3 elastic constants. The material has three orthogonal planes of symmetry and is symmetric to rotations about the normals to these plans.

$$C_{ij} = \begin{bmatrix} C_{11} & C_{12} & C_{12} & 0 & 0 & 0 \\ C_{21} & C_{11} & C_{12} & 0 & 0 & 0 \\ C_{21} & C_{21} & C_{11} & 0 & 0 & 0 \\ 0 & 0 & 0 & C_{44} & 0 & 0 \\ 0 & 0 & 0 & 0 & C_{44} & 0 \\ 0 & 0 & 0 & 0 & 0 & C_{44} \end{bmatrix} \quad (26.56)$$

For isotropy, the response of the material is completely independent of direction. This imposes the following additional relation on (26.56)

$$C_{44} = \frac{1}{2}(C_{11} - C_{12}) \quad (26.57)$$

Therefore, a linear elastic isotropic material is described by two elastic constants  $\lambda$  and  $\mu$ .

$$C_{ij} = \begin{bmatrix} (\lambda + 2\mu) & \lambda & \lambda & 0 & 0 & 0 \\ \lambda & (\lambda + 2\mu) & \lambda & 0 & 0 & 0 \\ \lambda & \lambda & (\lambda + 2\mu) & 0 & 0 & 0 \\ 0 & 0 & 0 & \mu & 0 & 0 \\ 0 & 0 & 0 & 0 & \mu & 0 \\ 0 & 0 & 0 & 0 & 0 & \mu \end{bmatrix} \quad (26.58)$$

and the stress strain relation is given by

$$\sigma_{ij} = \lambda(\varepsilon_{11} + \varepsilon_{22} + \varepsilon_{33})\delta_{ij} + 2\mu\varepsilon_{ij} \quad (26.59)$$

### 26.3.2 Linear Isotropic Elastic Constitutive Relation

$$\sigma_{ij} = \lambda\varepsilon_{kk}\delta_{ij} + 2\mu\varepsilon_{ij} \quad (26.60)$$

where  $\lambda$  and  $\mu$  are Lamé constants. If  $\lambda$  and  $\mu$  are not functions of position, then the material is *homogeneous*. To invert (26.60) to obtain the strains in terms of the stresses, first take the trace of (26.60)

$$\sigma_{kk} = \varepsilon_{kk}(3\lambda + 2\mu) = -3p \quad (26.61a)$$

$$p = -K\varepsilon \quad (26.61b)$$

where

$$K = \lambda + \frac{2}{3}\mu \quad (26.62)$$

is the bulk modulus. Recall that for small displacement gradients  $\varepsilon_{kk}$  is approximately equal to the volume strain, that is, the change in volume per unit reference volume. Hence  $K$  relates the pressure to the volume strain. For an incompressible material  $K \rightarrow \infty$ ; i.e., the volume strain is zero, regardless of the pressure. Solving (26.61a) for  $\varepsilon_{kk}$  and substituting back into (26.60) yields

$$2\mu\varepsilon_{ij} = \sigma_{ij} - \sigma_{kk}\delta_{ij}\frac{\lambda}{(3\lambda + 2\mu)} \quad (26.63a)$$

Now consider a uniaxial stress: only  $\sigma_{11} = \sigma$  is nonzero.

$$\varepsilon_{11} = \sigma\frac{(\lambda + \mu)}{\mu(3\lambda + 2\mu)} \quad (26.64a)$$

where

$$\frac{(\lambda + \mu)}{\mu(3\lambda + 2\mu)} = \frac{1}{E} \quad (26.65)$$

and  $E$  is Young's modulus. The strain in the lateral direction

$$\varepsilon_{22} = -\frac{\lambda}{2\mu(3\lambda + 2\mu)}\sigma = -\frac{\mu(3\lambda + 2\mu)}{(\lambda + \mu)}\frac{\lambda}{2\mu(3\lambda + 2\mu)}\varepsilon_{11} \quad (26.66)$$

Substituting (26.64a) yields

$$\epsilon_{22} = -\nu\epsilon_{11}$$

where

$$\nu = \frac{\lambda}{2(\lambda + \mu)} \quad (26.67)$$

is Poisson's ratio. Equation (26.63a) can be rewritten in terms  $E$  and  $\nu$  as

$$\epsilon_{ij} = \frac{(1 + \nu)}{E} T_{ij} - \frac{\nu}{E} T_{kk} \delta_{ij} \quad (26.68a)$$

$$(26.68b)$$

Some additional useful relations among the elastic constants are the following:

$$2\mu = \frac{E}{1 + \nu} \quad (26.69a)$$

$$\lambda = 2\mu \frac{\nu}{1 - 2\nu} \quad (26.69b)$$

## 26.4 Restrictions on Elastic Constants

The existence of a strain energy function places certain restrictions on the values of the elastic constants. These restrictions arise from the requirement that the strain energy function be positive.

$$W(\epsilon) > 0 \quad (26.70)$$

if

$$\epsilon \neq 0 \quad (26.71)$$

and

$$W(0) = 0 \quad (26.72)$$

An increment of the strain energy is equal to the work of the stresses  $\sigma_{ij}$  on the strain increment  $d\epsilon_{ij}$

$$dW = T_{ij} d\epsilon_{ij} \quad (26.73a)$$

and consequently the stress components are given by

$$\sigma_{ij} = \frac{\partial W}{\partial \epsilon_{ij}} = C_{ijkl} \epsilon_{kl}$$

(assuming  $W$  is written symmetrically in terms of  $\epsilon_{ij}$ ) and the modulus tensor is given by

$$C_{ijkl} = \frac{\partial^2 W}{\partial \epsilon_{ij} \partial \epsilon_{kl}} \quad (26.74)$$

Because the second derivatives of  $W$  can be taken in either order, the modulus tensor must satisfy the symmetry  $C_{ijkl} = C_{klij}$  and the strain energy function is given by

$$W = \frac{1}{2} C_{ijkl} \epsilon_{ij} \epsilon_{kl}$$

The condition (26.70) requires that  $C_{ijkl}$  be positive definite.

For an isotropic material

$$W = \frac{1}{2} \left\{ \lambda (\epsilon_{kk})^2 + 2\mu \epsilon_{ij} \epsilon_{ij} \right\} \quad (26.75a)$$

Because  $\epsilon_{ij}$  and  $\epsilon_{kk}$  are not independent, we cannot conclude from (26.70) that the coefficients  $\lambda$  and  $\mu$  are positive. Consequently, we rewrite (26.75a) in terms of deviatoric strain

$$\epsilon_{ij} = \epsilon'_{ij} + \frac{1}{3} \delta_{ij} \epsilon_{kk} \quad (26.76a)$$

to get

$$W = \frac{1}{2} \left\{ \left( \lambda + \frac{2}{3} \mu \right) \epsilon_{kk}^2 + 2\mu \epsilon'_{ij} \epsilon'_{ij} \right\}$$

Because each of  $\epsilon_{kk}$  and  $\epsilon'_{ij}$  can be specified independently, (26.70) requires that the bulk modulus

$$K = \left( \lambda + \frac{2}{3} \mu \right) > 0 \quad (26.77)$$

and that the shear modulus

$$\mu > 0 \quad (26.78)$$

These conditions translate to the following in terms of  $E$  and  $\nu$

$$E > 0 \quad (26.79a)$$

$$-1 < \nu < \frac{1}{2} \quad (26.79b)$$

but the practical limits on  $\nu$  are

$$0 < \nu < 0.49 \quad (26.80)$$

## 26.5 Additional Reading

Malvern, Sec. 6.2.