

Fusion graphs: merging properties and watersheds

J. Cousty, G. Bertrand, M. Couprie and L. Najman

*IGM, Unité Mixte de Recherche CNRS-UMLV-ESIEE UMR 8049
Laboratoire A2SI, Groupe ESIEE
Cité Descartes, BP99, 93162 Noisy-le-Grand Cedex France*

Abstract

Region merging methods consist of improving an initial segmentation by merging some pairs of neighboring regions. In this paper, we consider a segmentation as a set of connected regions, separated by a frontier. If the frontier set cannot be reduced without merging some regions then we call it a cleft, or binary watershed. In a general graph framework, merging two regions is not straightforward. We define four classes of graphs for which we prove, thanks to the notion of cleft, that some of the difficulties for defining merging procedures are avoided. Our main result is that one of these classes is the class of graphs in which any cleft is thin. None of the usual adjacency relations on \mathbb{Z}^2 and \mathbb{Z}^3 allows a satisfying definition of merging. We introduce the perfect fusion grid on \mathbb{Z}^n , a regular graph in which merging two neighboring regions can always be performed by removing from the frontier set all the points adjacent to both regions.

Key words: Graph theory, region merging, watershed, cleft, fusion graphs, adjacency relations, connectedness, image segmentation, image processing

Introduction

In the important and difficult task of segmenting an image, connectivity often plays an essential role: in many cases, a segmentation can be viewed as a set of connected regions, separated by a background which constitutes the frontiers between regions. A popular approach to image segmentation, called region merging [17,16], consists of progressively merging pairs of regions until a certain criterion is satisfied. The criterion which is used to identify the next pair of regions which will merge, as well as the stopping criterion are specific to each particular method.

Email addresses: j.cousty@esiee.fr (J. Cousty), g.bertrand@esiee.fr (G. Bertrand), m.couprie@esiee.fr (M. Couprie), l.najman@esiee.fr (L. Najman).

Article published in JMIV 30(1) 87-104, 2008

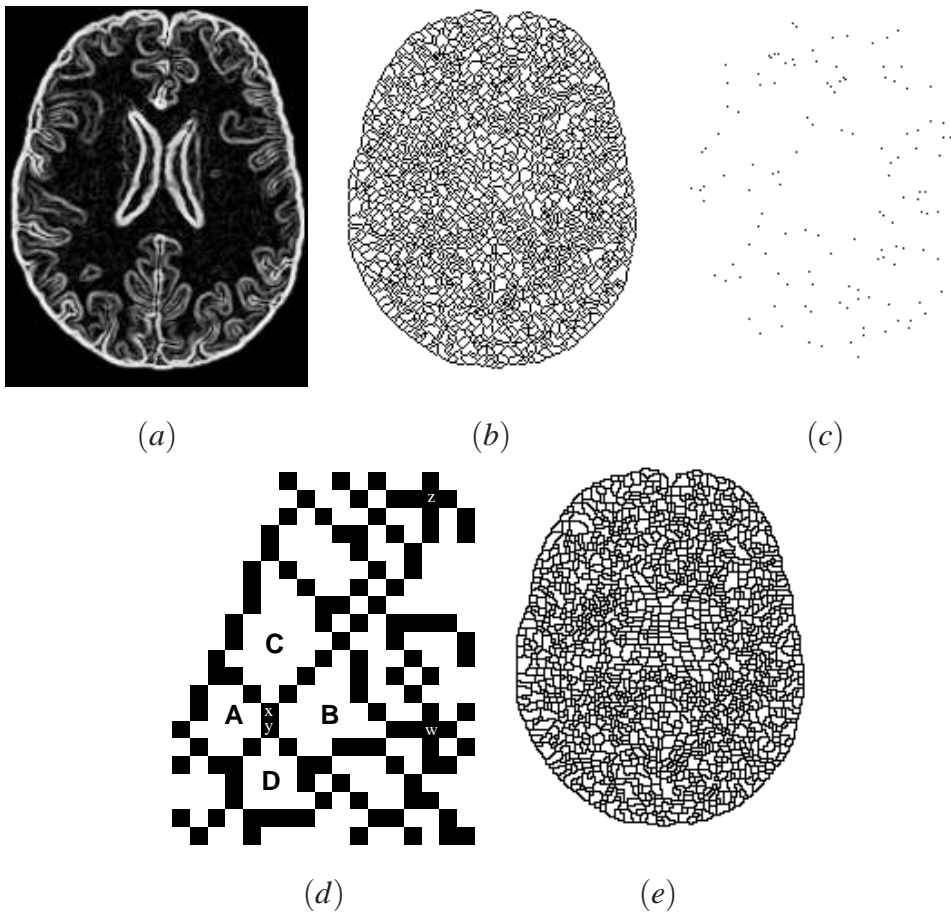

Fig. 1. (a): Original image (cross-section of a brain, after applying a gradient operator). (b): Watershed of (a) with the 4-adjacency (in black). (c): Inner points for the previous image (in black). (d): A zoom on a part of (b). The points z and w are inner points. (e): Watershed of (a) with the 8-adjacency (in black). There are no inner points.

Given a grayscale image, how is it possible to obtain an initial set of regions for a region merging process? The watershed transform [6,14] is a powerful tool for solving this problem. Let us consider a 2D grayscale image as a topographical relief, where the dark pixels correspond to basins and valleys, whereas bright pixels correspond to hills and crests. Suppose that we are interested in segmenting “dark” regions. Intuitively, the watersheds of the image are constituted by the crests which separate the basins corresponding to regional minima (see Fig. 1a,b). Due to noise and texture, real-world images often have a huge number of regional minima, hence the “mosaic” aspect of Fig. 1b. In [7,4,8,15], the authors developed a framework based on graph theory, in which some important properties of grayscale watersheds are proved, and efficient algorithms to compute them are proposed. In the case of a graph (*e.g.*, an adjacency graph defined on a subset of \mathbb{Z}^2), a watershed may be thought of as a “separating set” of vertices which cannot be reduced without merging some connected components of its complementary set. In this context, we

will use the term of *cleft*¹ for talking about such a separating set.

A first question arises when dealing with clefts on a graph. Given a subset E of \mathbb{Z}^2 and the graph (E, Γ_1) which corresponds to the usual 4-adjacency relation, we observe that a cleft may contain some “inner points”, *i.e.*, points which are not adjacent to any point outside the cleft (see Fig. 1c,d). We can say that a cleft on Γ_1 is not necessarily thin. On the other hand, such inner points do not seem to appear in any cleft on Γ_2 , which corresponds to the 8-adjacency. Are the clefts on Γ_2 always thin? We will prove that it is indeed true. More interestingly, we provide in this paper a framework to study the property of thinness of clefts in any kind of graph, and we identify the class of graphs in which any cleft is necessarily thin. This result is one of the main theorems of the article (Th. 32).

Let us now turn back to the region merging problem. What happens if we want to merge a couple of neighboring regions A and B , and if each pixel adjacent to these two regions is also adjacent to a third one, which is not wanted in the merging? Fig. 1d illustrates such a situation, where x is adjacent to regions A, B, C and y to A, B, D . This problem has been identified in particular by T. Pavlidis (see [16], section 5.6: “When three regions meet”), and has been dealt with in some practical ways, but until now a systematic study of properties related to merging in graphs has not been done. A major contribution of this article is the definition and the study of four classes of graphs, with respect to the possibility of “getting stuck” in a merging process (Sec. 3, Sec. 4). In particular, we say that a graph is a *fusion graph* if any region A in this graph can always be merged with another region B , while preserving all other regions. The most striking outcome of this study is that the class of fusion graphs is precisely the class of graphs in which any cleft is thin (Th. 32). We also provide some local characterizations for two of these four classes of graphs, and prove that the two other ones cannot be locally characterized (Sec. 5).

Using this framework, we analyze the status of the graphs which are the most widely used for image analysis, namely the graphs corresponding to the 4- and the 8-adjacency in \mathbb{Z}^2 and to the 6- and the 26-adjacency in \mathbb{Z}^3 (Sec. 6). In one of the classes of graphs introduced in Sec. 4, that we call the class of *perfect fusion graphs*, any pair of neighboring regions A, B can always be merged, while preserving all other regions, by removing all the pixels which are adjacent to both A and B . We show that none of these classical graphs is a perfect fusion graph. In Sec. 7, we introduce a graph on \mathbb{Z}^n (for any n) that we call the perfect fusion grid, which is indeed a perfect fusion graph, and which is “between” the direct adjacency graph (which generalizes the 4-adjacency to \mathbb{Z}^n) and the indirect adjacency graph (which generalizes the 8-adjacency).

¹ Notice that, in previous publications [4,9,11], we used the term of (binary) watershed as a synonym of cleft.

A part of these results has been presented, without the proofs, in a conference article [9].

1 Basic notions

Let E be a set, we write $X \subseteq E$ if X is a subset of E , we write $X \subset E$ if X is a proper subset of E , *i.e.*, if X is a subset of E and $X \neq E$. We denote by \bar{X} the complementary set of X in E , *i.e.*, $\bar{X} = E \setminus X$.

Let E be a finite set, we denote by $|E|$ the number of elements of E . We denote by 2^E the set composed of all the subsets of E .

We define a graph as a pair (E, Γ) where E is a finite set and Γ is a binary relation on E (*i.e.*, $\Gamma \subseteq E \times E$), which is reflexive (for all x in E , $(x, x) \in \Gamma$) and symmetric (for all x, y in E , $(y, x) \in \Gamma$ whenever $(x, y) \in \Gamma$). Each element of E is called a *vertex* or a *point*. We will also denote by Γ the map from E to 2^E such that, for all $x \in E$, $\Gamma(x) = \{y \in E \mid (x, y) \in \Gamma\}$. If $y \in \Gamma(x)$, we say that y is *adjacent to* x . We define also the relation $\Gamma^* = \Gamma \setminus \{(x, x) \mid x \in E\}$, and the map Γ^* such that for all $x \in E$, $\Gamma^*(x) = \Gamma(x) \setminus \{x\}$. Let $X \subseteq E$, we define $\Gamma(X) = \cup_{x \in X} \Gamma(x)$, and $\Gamma^*(X) = \Gamma(X) \setminus X$. If $y \in \Gamma(X)$, we say that y is *adjacent to* X . If $X, Y \subseteq E$ and $\Gamma(X) \cap Y \neq \emptyset$, we say that Y is *adjacent to* X (or that X is adjacent to Y , since Γ is symmetric). Let $G = (E, \Gamma)$ be a graph and let $X \subseteq E$, we define the *subgraph of G induced by X* as the graph $G_X = (X, \Gamma \cap [X \times X])$. In this case, we also say that G_X is a *subgraph of G* . Let $G = (E, \Gamma)$ and $G' = (E', \Gamma')$ be two graphs, we say that G and G' are *isomorphic* if there exists a bijection f from E to E' such that, for all $x, y \in E$, y belongs to $\Gamma(x)$ if and only if $f(y)$ belongs to $\Gamma'(f(x))$.

Let (E, Γ) be a graph, let $X \subseteq E$, a *path in X* is a sequence $\pi = \langle x_0, \dots, x_l \rangle$ such that $x_i \in X$, $i \in [0, l]$, and $x_i \in \Gamma(x_{i-1})$, $i \in [1, \dots, l]$. We also say that π is a *path from x_0 to x_l in X* . Let $x, y \in X$. We say that x and y are *linked for X* if there exists a path from x to y in X . We say that X is *connected* if any x and y in X are linked for X .

Let $Y \subseteq X$. We say that Y is a *connected component of X* , or simply a *component of X* , if Y is non-empty, connected and if Y is maximal for this property, *i.e.*, if $Z = Y$ whenever $Y \subseteq Z \subseteq X$ and Z connected.

We denote by $\mathcal{C}(X)$ the set of all the connected components of X . Let $S \subseteq E$, we denote by $\mathcal{C}(X|S)$ the subset of $\mathcal{C}(X)$ composed of the components of X which are adjacent to S .

Notice that the empty set is connected, and that if X is non-empty, then the empty set is not a connected component of X . Notice also that, if Y is a connected component of a set X , then Y is not adjacent to $X \setminus Y$.

Let us consider a subset X of E . We can easily see that, if X is connected, then any two non-empty subsets A, B of X such that $A \cup B = X$ must be adjacent to each other. On the other hand, if X is not connected, then we have two points x and y in X which are not linked for X . Considering the set A of all the points z in X such that x and z are linked for X and considering the set $B = X \setminus A$, we see that X can be partitioned into two non-empty subsets which are not adjacent to each other. These observations lead to the following property which characterizes connected sets (without the need of considering paths).

Property 1 ([18]). *Let (E, Γ) be a graph, let $X \subseteq E$. The set X is connected if and only if, for any two distinct non-empty subsets A, B of X such that $A \cup B = X$, the subset A is adjacent to B .*

From Prop. 1 we can immediately deduce the following corollary.

Corollary 2. *Let (E, Γ) be a graph, let X be a non-empty subset of E . If E is connected and if $X \neq E$, then $\Gamma^*(X) \neq \emptyset$.*

In this paper, we study in particular some thinness properties of clefts in graphs. The notions of thinness and interior are closely related.

Definition 3. *Let (E, Γ) be a graph. Let $X \subseteq E$, the interior of X is the set $\text{int}(X) = \{x \in X \mid \Gamma(x) \subseteq X\}$. We say that the set X is thin if $\text{int}(X) = \emptyset$.*

Property 4. *Let (E, Γ) be a graph, let $X \subseteq E$ such that $\text{int}(X) \neq \emptyset$, let A be a non-empty subset of $\text{int}(X)$. We have: $C(\overline{X \setminus A}) = C(\overline{X}) \cup C(A)$. Furthermore, if A is connected, then A is a connected component of $X \setminus A$; more precisely we have $C(\overline{X \setminus A}) = C(\overline{X}) \cup \{A\}$.*

The proof of Prop. 4 is elementary and thus omitted. To conclude this section, we recall the definition of line graphs. This class of graphs allows to make a strong link between the framework developed in this paper and the approaches of watershed and region merging based on edges rather than vertices, *i.e.*, when regions are separated by a set of edges.

Let (E, Γ) be a graph. The *line graph* of (E, Γ) is the graph (E', Γ') such that $E' = \Gamma^*$ and (u, v) belongs to Γ' whenever $u \in \Gamma^*$, $v \in \Gamma^*$, and u, v share a vertex of E .

We say that a graph (E', Γ') is a *line graph* if there exists a graph (E, Γ) such that (E', Γ') is isomorphic to the line graph of (E, Γ) .

In Fig. 2, we show a graph and its line graph. All graphs are not line graphs, in other words, there exist some graphs which are not the line graphs of any graph. The following theorem allows to characterize line graphs.

Theorem 5 ([2]). *A graph G is a line graph if and only if none of the graphs of Fig. 3 is a subgraph of G .*

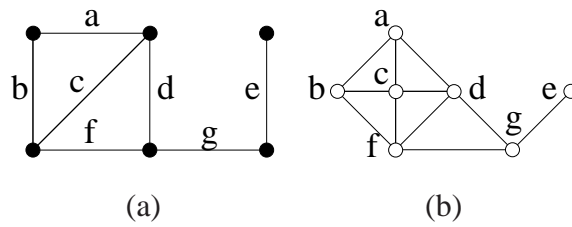

Fig. 2. A graph (a) and its line graph (b).

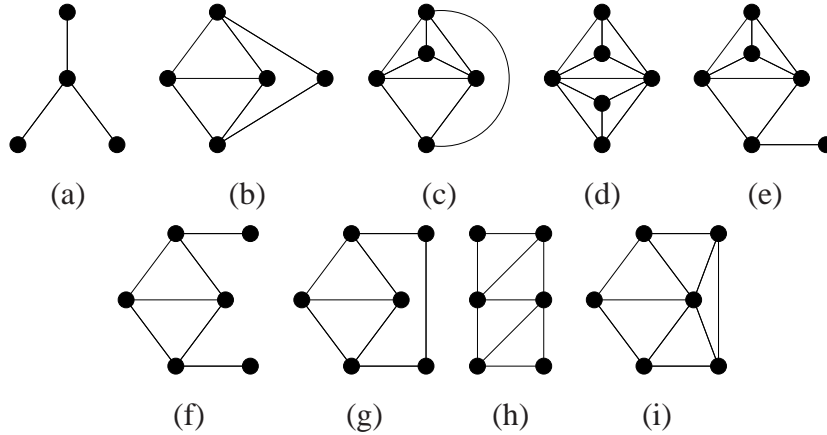

Fig. 3. Graphs for a characterization of line graphs (Th. 5).

As an illustration, we can check that the line graph depicted in Fig. 2b does not contain any graph of Fig. 3 as a subgraph. For example, the subgraph induced by the set $\{d, e, f, g\}$ of the graph shown in Fig. 2b is not the same as the graph of Fig. 3a since it contains one more edge.

2 Clefs

Informally, in a graph, a cleft may be thought of as a “separating set” of vertices which cannot be reduced without merging some components of its complementary set (see for example, the set of black vertices in Fig. 4d). We first give formal definitions of these concepts (see [4,7]) and related ones, then we derive some properties which will be used in the sequel.

Important remark. *From now, when speaking about a graph (E, Γ) , we will assume for simplicity that E is non-empty and connected.*

Notice that, nevertheless, the subsequent definitions and properties may be easily extended to non-connected graphs.

Definition 6 ([4]). *Let (E, Γ) be a graph. Let $X \subseteq E$, and let $p \in X$.*

We say that p is a border point (for X) if p is adjacent to \bar{X} .

We say that p is an inner point (for X) if p is not a border point for X , i.e.,

if $p \in \text{int}(X)$.

We say that p is W-simple (for X) if p is adjacent to exactly one connected component of \overline{X} .

We say that p is separating (for X) if p is adjacent to at least two connected components of \overline{X} .

We say that p is a multiple point (for X) if p is adjacent to at least three connected components of \overline{X} .

In this definition and the following ones, the prefix ‘‘W-’’ stands for watershed. In Fig. 4a, x is both a border point and a W-simple point for the set X constituted by the black vertices, and y is an inner point. In Fig. 5b, z is a border point and a separating point, and w is a border point, a separating point and a multiple point.

Definition 7. Let (E, Γ) be a graph. Let $X \subseteq E$, and let $S \subseteq X$.

We say that S is W-simple (for X) if there exists $A \in \mathcal{C}(\overline{X})$ such that $A \cup S$ is connected and $\mathcal{C}(\overline{X}|S) = \{A\}$.

Obviously, a point p is W-simple if and only if the set $\{p\}$ is W-simple. Notice that, in the above definition, S is not necessarily connected. The following property may be proved easily.

Property 8. Let (E, Γ) be a graph. Let $X \subseteq E$, and let $S \subseteq X$.

The set S is W-simple (for X) if and only if there exists $A \in \mathcal{C}(\overline{X})$ such that $\mathcal{C}(\overline{X} \cup S) = [\mathcal{C}(\overline{X}) \setminus \{A\}] \cup \{A \cup S\}$.

We are now ready to define the notion of cleft which is central to this section.

Definition 9 ([4]). Let $G = (E, \Gamma)$ be a graph. Let $X \subseteq E$, let $Y \subseteq X$.

We say that Y is a W-thinning of X , written $X \searrow^W Y$, if

i) $Y = X$ or if

ii) there exists a set $Z \subseteq X$ which is a W-thinning of X and a point $p \in Z$ which is W-simple for Z , such that $Y = Z \setminus \{p\}$.

A set $Y \subseteq X$ is a cleft (in G) if $Y \searrow^W Z$ implies $Z = Y$.

A subset Y of X is a cleft of X if Y is a W-thinning of X and if Y is a cleft.

A cleft Y is non-trivial if $Y \neq \emptyset$ and $Y \neq E$.

It can be seen that we can obtain a W-thinning of X by iteratively removing W-simple points from X , and that Y is a cleft of X if Y is a W-thinning of X which contains no W-simple point. Fig. 4 shows a set X and some W-thinnings of X , the last one being a cleft of X . Notice that different clefts may exist for a same set X . It can be also seen that a cleft X is non-trivial if and only if $|\mathcal{C}(\overline{X})| \geq 2$.

The following definition and theorem are borrowed from [4] and will play an important role in some subsequent proofs.

Definition 10 ([4]). Let (E, Γ) be a graph. Let X, Y be subsets of E . We say that

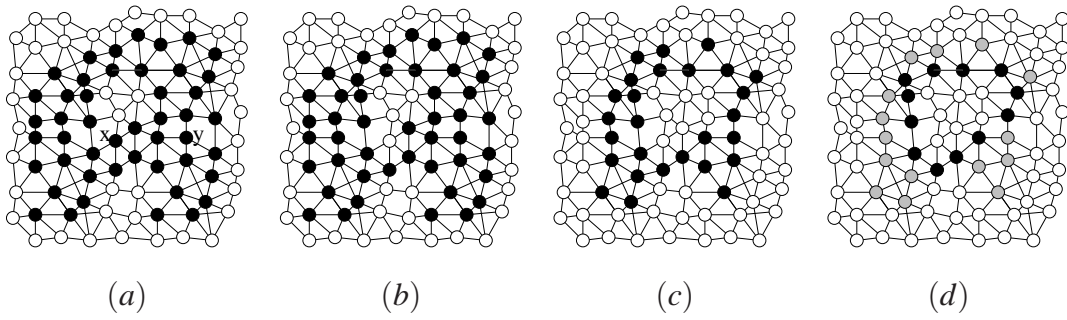

Fig. 4. Illustration of W-thinning and cleft. (a): A graph (E, Γ) and a subset X (black points) of E . The point x is a border point which is W-simple, and y is an inner point. (b): The set $Y = X \setminus \{x\}$ (black points) is a W-thinning of X . (c): The set Z (black points) is a W-thinning of both X and Y . The sets Y and Z are not clefts: some W-simple points exist in both sets. (d): A cleft of X (black points), which is also a cleft of Y and of Z . The set of gray points will be used to illustrate the notion of annexation (Def. 15).

Y is an extension of X if $X \subseteq Y$ and if each connected component of Y contains exactly one connected component of X .

Theorem 11 ([4]). *Let X and Y be subsets of E . The subset Y is a W-thinning of X if and only if \overline{Y} is an extension of \overline{X} .*

We can see that if a subset S of X is W-simple for X , then $\overline{X \setminus S}$ is an extension of \overline{X} . From this observation and Th. 11, we immediately deduce the following property.

Corollary 12. *Let $X \subseteq E$ and $S \subseteq X$. If the subset S is W-simple for X , then $X \setminus S$ is a W-thinning of X .*

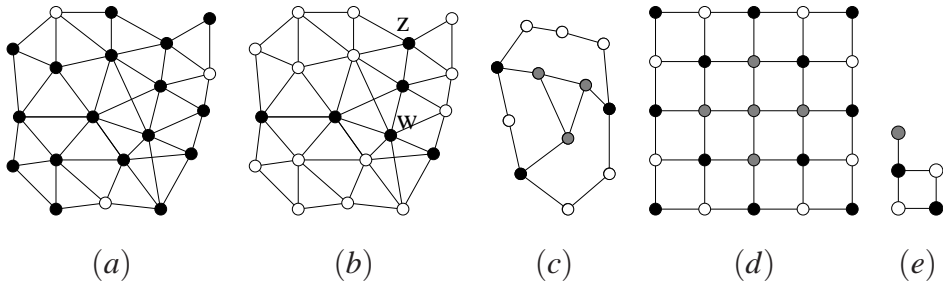

Fig. 5. Illustration of thin and non-thin clefts. (a): A graph (E, Γ) and a subset X (black points) of E . (b): A subset Y (black points) of E which is a thin cleft; it is a cleft of the set X shown in (a). The border points z and w are both separating for Y , only w is a multiple point. (c, d, e): The subset X represented by black and gray points is a cleft which is not thin: $\text{int}(X)$ is depicted by the gray points.

A cleft is a set which contains no W-simple point, but some of the examples given below show that such a set is not always thin (in the sense of Def. 3). Fig. 4d and Fig. 5b are two examples of clefts which are thin: in both cases, the set of black points has no W-simple point and no inner point. The sets of points which are either black or gray, in Fig. 5c, d, e are three examples of non-thin clefts. Let us study what happens if we remove from a non-thin cleft X , a connected component of $\text{int}(X)$.

Property 13. *Let (E, Γ) be a graph, let $X \subseteq E$ be a cleft. Let A be a connected component of $\text{int}(X)$. Then, $X \setminus A$ is a cleft.*

Proof: The cases where $|\mathcal{C}(\overline{X})| < 2$ or $\text{int}(X) = \emptyset$ are trivial: if $|\mathcal{C}(\overline{X})| = 0$ then $E = X = \text{int}(X) = A$ and $X \setminus A = \emptyset$; if $|\mathcal{C}(\overline{X})| = 1$ then it may be seen that X must be empty since E is connected, thus $X \setminus A = \emptyset$; and if $\text{int}(X) = \emptyset$ then $A = \emptyset$, thus $X \setminus A = X$. Suppose from now that $|\mathcal{C}(\overline{X})| \geq 2$ and $\text{int}(X) \neq \emptyset$. From Prop. 4, $A \in \mathcal{C}(\overline{X \setminus A})$. Let x be a point of $X \setminus A$, we have to prove that x cannot be W-simple for $X \setminus A$. If $x \notin \Gamma^*(A)$, we can easily see that the point x cannot be W-simple for $X \setminus A$, otherwise it would also be W-simple for X . Suppose now that $x \in \Gamma^*(A)$. The point x cannot belong to $\text{int}(X)$ otherwise A would not be a connected component of $\text{int}(X)$. Thus x must be adjacent to a component B of $\mathcal{C}(\overline{X})$, which is also a component of $\mathcal{C}(\overline{X \setminus A})$ (Prop. 4): hence, x is adjacent to both A and B , with $A \neq B$, and is not W-simple for $X \setminus A$. \square

The following corollary follows straightforwardly.

Corollary 14. *Let (E, Γ) be a graph, let $X \subseteq E$. The set $X \setminus \text{int}(X)$ is a cleft.*

Let (E, Γ) be a graph. Let $X \subset E$, let $A \in \mathcal{C}(\overline{X})$. Let us consider the family \mathcal{W}'_A of all the sets which are W-simple for X and adjacent to A . It may be easily seen that the family \mathcal{W}'_A is closed by union, *i.e.*, that $S \cup T$ belongs to \mathcal{W}'_A whenever $S \in \mathcal{W}'_A$ and $T \in \mathcal{W}'_A$. From this observation, we deduce that there exists a unique element of \mathcal{W}'_A which is maximal for the inclusion, and this element is the union of all the elements of the family.

Definition 15. *Let (E, Γ) be a graph. Let $X \subset E$, let $A \in \mathcal{C}(\overline{X})$. We define the annexation of A in X , denoted by $\text{ann}(A, X)$, as the union of all the sets which are W-simple for X and adjacent to A . When no confusion may occur, we write $\text{ann}(A) = \text{ann}(A, X)$.*

In Fig. 4c, let A be the (white) component of \overline{Z} which “surrounds” the (black) set Z . The set $\text{ann}(A, Z)$ is depicted in light gray in Fig. 4d.

We have seen that, for any S which is W-simple for X and adjacent to A , the set $\overline{X} \cup S$ is an extension of \overline{X} . In particular, the set $\overline{X} \cup \text{ann}(A)$ is an extension of \overline{X} .

The following properties illustrate the notion of annexation, which will serve us to prove some of the main results of this paper.

Property 16. *Let (E, Γ) be a graph, let $X \subset E$ such that $|\mathcal{C}(\overline{X})| \geq 2$. For any $A \in \mathcal{C}(\overline{X})$, there exists $B \in [\mathcal{C}(\overline{X}) \setminus \{A\}]$ such that $\Gamma^*(A \cup \text{ann}(A)) \cap \Gamma^*(B) \neq \emptyset$.*

The proof can be found in the appendix. We leave the proof of the following property to the interested reader.

Property 17. Let (E, Γ) be a graph, let $X \subset E$, let $A \in \mathcal{C}(\overline{X})$. The set $A \cup \text{ann}(A, X)$ is equal to the connected component of $\text{int}(X \cup A)$ which contains A .

3 Merging

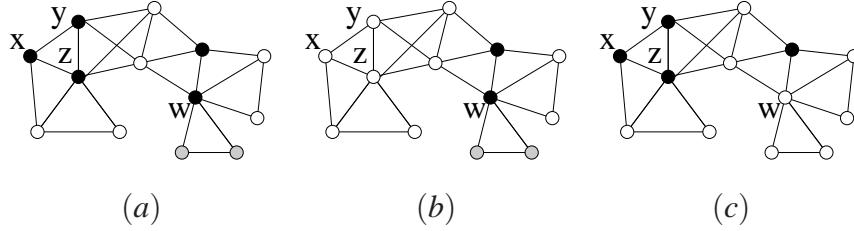

Fig. 6. Illustration of merging. (a): A graph (E, Γ) and a subset X of E (black points). (b): The black points represent $X \setminus S$ with $S = \{x, y, z\}$. (c): The black points represent $X \setminus S'$ with $S' = \{w\}$.

Consider the graph (E, Γ) depicted in Fig. 6a, where a subset X of E (black vertices) separates its complementary set \overline{X} into four connected components. If we replace the set X by, for instance, the set $X \setminus S$ where $S = \{x, y, z\}$, we obtain a set which separates its complementary set into three components, see Fig. 6b: we can also say that we “merged two components of \overline{X} through S ”. This operation may be seen as an “elementary merging” in the sense that only two components of \overline{X} were merged. On the opposite, replacing the set X by the set $X \setminus S'$ where $S' = \{w\}$, see Fig. 6c, would merge three components of \overline{X} . We also see that the component of \overline{X} which is below w (in light gray) cannot be merged by an “elementary merging” since any attempt to merge it must involve the point w , and thus also the three components of \overline{X} adjacent to this point. In this section, we introduce definitions and basic properties related to such merging operations in graphs.

Definition 18. Let (E, Γ) be a graph and $X \subset E$. Let $p \in X$, let $S \subseteq X$. We say that p is F-simple (for X) if p is adjacent to exactly two distinct connected components of \overline{X} .

We say that S is F-simple (for X) if S is adjacent to exactly two distinct components $A, B \in \mathcal{C}(\overline{X})$ such that $A \cup B \cup S$ is connected.

In this definition, the prefix “F-” stands for fusion. Observe that the point p is F-simple if and only if the set $\{p\}$ is F-simple. For example, in Fig. 6a, the point z is F-simple while x, y, w are not. Also, the sets $\{z\}$, $\{x, y\}$, $\{x, z\}$, $\{y, z\}$, $\{x, y, z\}$ are F-simple, but the sets $\{x\}$, $\{y\}$ and $\{w\}$ are not.

Notice also that the set S is not necessarily connected. Furthermore, any connected component T of S must be adjacent to either A or B , or both, and cannot be adjacent to any other element of $\mathcal{C}(\overline{X})$. Thus we have the following property.

Property 19. Let (E, Γ) be a graph, let $X \subset E$, let $S \subseteq X$ such that S is F -simple for X , and let $T \subseteq S$. If $T \in \mathcal{C}(S)$, then T is either W -simple or F -simple for X .

Definition 20. Let (E, Γ) be a graph and $X \subset E$. Let A and $B \in \mathcal{C}(\overline{X})$, with $A \neq B$. We say that A and B can be merged (for X) if there exists $S \subseteq X$ such that S is F -simple for X and such that A and B are precisely the two connected components of \overline{X} which are adjacent to S . In this case, we also say that A and B can be merged through S (for X).

We say that A can be merged (for X) if there exists $B \in \mathcal{C}(\overline{X})$ such that A and B can be merged for X .

For example, in Fig. 6a, the component of \overline{X} in light gray cannot be merged, but each of the three white components can be merged for X .

Property 21. Let (E, Γ) be a graph, let $X \subset E$, let $A, B \in \mathcal{C}(\overline{X})$, $A \neq B$, and let $S \subseteq X$. The components A and B can be merged through S if and only if $A \cup B \cup S$ is a connected component of $\overline{X \setminus S}$. More precisely, A and B can be merged through S if and only if $\mathcal{C}(\overline{X \setminus S}) = [\mathcal{C}(\overline{X}) \setminus \{A, B\}] \cup \{A \cup B \cup S\}$.

Property 22. Let (E, Γ) be a graph, let $X \subset E$, let $A, B \in \mathcal{C}(\overline{X})$ with $A \neq B$. The components A and B can be merged for X if and only if there exists $S \subseteq X$ such that S is connected and adjacent to only A and B .

The proof of Prop. 21 can be found in the appendix, and the proof of Prop. 22 is elementary. The following property will be useful for establishing one of the main results of this article, namely Th. 32.

Property 23. Let (E, Γ) be a graph, let $X \subset E$, and let $A \in \mathcal{C}(\overline{X})$. The three following statements are equivalent:

- i) A can be merged for X ;
- ii) $[A \cup \text{ann}(A, X)]$ can be merged for $[X \setminus \text{ann}(A, X)]$;
- iii) there exists an extension \overline{Y} of \overline{X} and there exists a vertex $x \in \Gamma^*(A')$ which is F -simple, where A' is the connected component of \overline{Y} which contains A .

Proof:

- $[i \Rightarrow ii]$ From i), we know that there exists $B \in \mathcal{C}(\overline{X})$ and $S \subseteq X$ such that S is F -simple for X and adjacent to both A and B . Let $A' = A \cup \text{ann}(A, X)$, and let $Y = X \setminus \text{ann}(A, X)$. From Def. 15 and the observation which follows this definition, \overline{Y} is an extension of \overline{X} and $\mathcal{C}(\overline{Y}) = [\mathcal{C}(\overline{X}) \setminus \{A\}] \cup \{A'\}$. Let $S' = S \cap \overline{A'}$, thus $S' \subseteq Y$. We have: $A' \cup S' \cup B = A \cup S \cup B \cup A'$. We know that A' is connected, that $A \cup S \cup B$ is connected and that $A \subseteq A'$, thus $A \cup S \cup B \cup A'$ is connected, hence so is $A' \cup S' \cup B$. This implies that S' is adjacent to both A' and B . Since the only components of \overline{X} adjacent to S are A and B and since $S' \subseteq S$, we deduce that the only components of \overline{Y} adjacent to S' are precisely A' and B , thus S' is F -simple for Y , hence ii).

- $[ii \Rightarrow iii]$ Let $A' = A \cup \text{ann}(A, X)$, let $Y = X \setminus \text{ann}(A, X)$. We have seen that \overline{Y} is

an extension of \bar{X} and that A' is the element of $\mathcal{C}(\bar{Y})$ which contains A . From ii), we know that there exists $B \in \mathcal{C}(\bar{Y})$ and $S \subseteq Y$ such that S is F-simple for Y and adjacent to both A' and B . There must exist some points in S which are adjacent to A' , let x be any such point. The point x cannot be W-simple for Y , otherwise the set $\text{ann}(A, X) \cup \{x\}$ would be W-simple for X and adjacent to A , a contradiction with the definition of $\text{ann}(A, X)$. Furthermore, since S is F-simple it cannot contain any multiple point, thus x is F-simple for Y .

• [iii \Rightarrow i] Suppose that x is a point of $\Gamma^*(A')$ which is F-simple. Then, x is adjacent to A' and to B' , with $B' \in \mathcal{C}(\bar{Y})$, $B' \neq A'$, and $A' \cup B' \cup \{x\}$ is connected. Let B be the component of $\mathcal{C}(\bar{X})$ such that $B \subseteq B'$. Let us consider $S = [A' \setminus A] \cup [B' \setminus B] \cup \{x\}$. It can be easily seen that $S \subseteq X$ and that S is adjacent to both A and B . Since \bar{Y} is an extension of \bar{X} we know that A' (resp. B') cannot be adjacent to any other connected component of \bar{X} than A (resp. B). Also, x cannot be adjacent to any other connected component of \bar{X} than A and B , otherwise it could not be F-simple for Y . Furthermore, we have $A \cup B \cup S = A' \cup B' \cup \{x\}$, thus $A \cup B \cup S$ is connected. Thus, since S is adjacent to solely A and B , S is F-simple for X , and A can be merged for X . \square

From Def. 9 and Th. 11, any extension of a cleft X is equal to X . Thus, the following corollary is an immediate consequence of Prop. 23.

Corollary 24. *Let (E, Γ) be a graph, let $X \subset E$ be a cleft and let $A \in \mathcal{C}(\bar{X})$. The subset A can be merged for X if and only if there exists a vertex $x \in \Gamma^*(A)$ which is F-simple for X .*

4 Fusion graphs

Region merging [16,17] is a popular approach to image segmentation. Starting with an initial partition of the image pixels into connected regions, which can in some cases be separated by some boundary pixels, the basic idea consists of progressively merging pairs of regions until a certain criterion is satisfied. The criterion which is used to identify the next pair of regions which will merge, as well as the stopping criterion are specific to each particular method. Certain methods do not use graph vertices in order to separate regions, nevertheless even these methods fall in the scope of this study through the use of line graphs (see Sec. 1).

The preceding section and the present one constitute a theoretical basis for the study of such methods. The problems encountered by certain region merging methods (see [16], section 5.6: “When three regions meet”) can be avoided by using exclusively the notion of merging introduced in the previous section. In the sequel, we investigate several classes of graphs with respect to the possibility of “getting stuck” in a merging process. The most striking result of this section is a theorem

which states the equivalence between one of these classes and the class of graphs in which any cleft is thin.

We begin with the definition of four classes of graphs.

Definition 25. *We say that a graph (E, Γ) is a weak fusion graph if for any $X \subset E$ such that $|\mathcal{C}(\overline{X})| \geq 2$, there exist $A, B \in \mathcal{C}(\overline{X})$ which can be merged.*

Definition 26. *We say that a graph (E, Γ) is a fusion graph if for any $X \subset E$ such that $|\mathcal{C}(\overline{X})| \geq 2$, each $A \in \mathcal{C}(\overline{X})$ can be merged for X .*

Let $X \subset E$, and let $A, B \in \mathcal{C}(\overline{X})$. We set $\Gamma^*(A, B) = \Gamma^*(A) \cap \Gamma^*(B)$. We say that A and B are neighbors if $A \neq B$ and $\Gamma^*(A, B) \neq \emptyset$.

Definition 27. *We say that the graph (E, Γ) is a strong fusion graph if, for any $X \subset E$, any A and $B \in \mathcal{C}(\overline{X})$ which are neighbors can be merged.*

Definition 28. *We say that the graph (E, Γ) is a perfect fusion graph if, for any $X \subset E$, any A and $B \in \mathcal{C}(\overline{X})$ which are neighbors can be merged through $\Gamma^*(A, B)$.*

Basic examples and counter-examples of weak fusion, fusion, strong fusion and perfect fusion graphs are given in Fig. 7.

These classes are linked by inclusion relations. The following property clarifies these links, and also position our four classes of graphs with respect to general graphs and line graphs. We denote by \mathcal{G} (resp. \mathcal{G}_L , \mathcal{G}_P , \mathcal{G}_S , \mathcal{G}_F , and \mathcal{G}_W) the set of all graphs (resp. line graphs, perfect fusion graphs, strong fusion graphs, fusion graphs, and weak fusion graphs).

Property 29. *Any line graph is a perfect fusion graph,
any perfect fusion graph is a strong fusion graph,
any strong fusion graph is a fusion graph,
any fusion graph is a weak fusion graph.
More precisely, we have the following strict inclusion relations:
 $\mathcal{G}_L \subset \mathcal{G}_P \subset \mathcal{G}_S \subset \mathcal{G}_F \subset \mathcal{G}_W \subset \mathcal{G}$.*

Proof: We prove in the appendix (Lem. 59) that any strong fusion graph is a fusion graph. The other inclusions may be proved easily; let us prove that these inclusions are strict. It may be checked from the definitions that the graphs (g), (w), (f) and (s) in Fig. 7 are indeed counter-examples for the corresponding class equalities. It may also be checked that the graph (p) is a perfect fusion graph, while it is not a line graph, a consequence of Th. 5. \square

The following property is a consequence of Def. 26, Cor. 24 and Prop. 23.

Property 30. *The graph $G = (E, \Gamma)$ is a fusion graph if and only if, for any non-trivial cleft X in G and for any $A \in \mathcal{C}(\overline{X})$, there exists $x \in \Gamma^*(A)$ which is F -simple.*

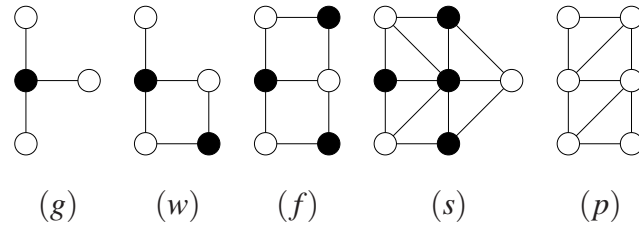

Fig. 7. Examples and counter-examples for different classes of graphs. (g) : A graph which is not a weak fusion graph, (w) : a weak fusion graph which is not a fusion graph, (f) : a fusion graph which is not a strong fusion graph, (s) : a strong fusion graph which is not a perfect fusion graph, and (p) : a perfect fusion graph which is not a line graph. In the graphs (g, w, f, s) , the black vertices constitute a set X which serves to prove that the graph does not belong to the pre-cited class.

Proof: Let (E, Γ) be a fusion graph, let X be a non-trivial cleft (thus $|\mathcal{C}(\overline{X})| \geq 2$), and let $A \in \mathcal{C}(\overline{X})$. Since (E, Γ) is a fusion graph, we know that A can be merged for X , thus by Cor. 24, there exists $x \in \Gamma^*(A)$ which is F-simple.

Suppose now that for any non-trivial cleft $X \subset E$ and for any $A' \in \mathcal{C}(\overline{X})$, there exists $x \in \Gamma^*(A')$ which is F-simple. Let $Y \subset E$ such that $|\mathcal{C}(\overline{Y})| \geq 2$, let $A \in \mathcal{C}(\overline{Y})$. Let X be a cleft of Y , and let $A' \in \mathcal{C}(\overline{X})$ such that $A \subseteq A'$. By hypothesis, there exists $x \in \Gamma^*(A')$ which is F-simple for A' . Furthermore, by Th. 11 we know that X is an extension of Y , thus by Prop. 23, A can be merged for Y . \square

From Prop. 30, we deduce Prop. 31 which will be used in the proof of Th. 41.

Property 31. *Let $G = (E, \Gamma)$ be a graph. If G is not a fusion graph, then there exist $X \subset E$ and $x \in X$ such that x is a multiple point for X .*

Proof: If G is not a fusion graph, then by Prop. 30, there exists $Y \subset E$ such that $|\mathcal{C}(\overline{Y})| \geq 2$, there exists a cleft X of Y , there exists $A \in \mathcal{C}(\overline{X})$ such that any $x \in \Gamma^*(A)$ is not F-simple. For any such x , since $x \in \Gamma^*(A)$, x is not an inner point; and since X is a cleft, x is not W-simple; thus x must be a multiple point. Furthermore, since $|\mathcal{C}(\overline{Y})| \geq 2$ and thus $|\mathcal{C}(\overline{X})| \geq 2$, we have $A \neq E$, and since E is connected, from Cor. 2 there must exist a point x in $\Gamma^*(A)$. \square

Notice that the converse of Prop. 31 is false, as shown by the case of Fig. 7f which is a fusion graph, in which a given subset (black dots) has one multiple point.

Now, we present the main theorem of this section, which establishes that the class of graphs for which any cleft is thin is precisely the class of fusion graphs. As an immediate consequence of this theorem and Prop. 29, we see that all clefts in fusion graphs, strong fusion graphs, perfect fusion graphs and line graphs are thin.

Theorem 32. *A graph G is a fusion graph if and only if any non-trivial cleft in G is thin.*

Proof: Let (E, Γ) be a fusion graph, let $Y \subset E$ be a non-trivial cleft. Suppose that $\text{int}(Y) \neq \emptyset$, and let $A \in \mathcal{C}(\text{int}(Y))$. Let $Y' = Y \setminus A$. By Prop. 13, Y' is a cleft. Since (E, Γ) is a fusion graph, from Prop. 30 we deduce that there exists a vertex $x \in \Gamma^*(A)$ which is F-simple for Y' , *i.e.*, x is adjacent to exactly two connected components of $\overline{Y'}$. Since $\mathcal{C}(\overline{Y'}) = \mathcal{C}(\overline{Y}) \cup \{A\}$ (Prop. 4), this means that x is only adjacent to one connected component of \overline{Y} , *i.e.*, x is W-simple for Y , a contradiction with the fact that Y is a cleft. Thus, Y is thin.

Suppose now that (E, Γ) is not a fusion graph, by Prop. 30 there exists a non-trivial cleft $Y \subset E$, and there exists $A \in \mathcal{C}(\overline{Y})$ such that any $x \in \Gamma^*(A)$ cannot be F-simple. Furthermore, since Y is a cleft we know that any x in $\Gamma^*(A)$ cannot be W-simple for Y , thus any point x in $\Gamma^*(A)$ is a multiple point. Consider now the set $Y' = Y \cup A$, and let y be a point of Y' . Only three cases are possible: 1) if $y \in A$, then we can see that y is an inner point for Y' , thus y is not W-simple for Y' ; 2) if $y \in \Gamma^*(A)$, then as seen before, y is a multiple point for Y , thus y is adjacent to at least two connected components of Y' consequently y is not W-simple for Y' ; 3) if $y \notin \Gamma(A)$, then y is not W-simple for Y' , otherwise Y could not be a cleft. Thus, Y' is a cleft. Furthermore, $A \subseteq \text{int}(Y')$ and $A \neq \emptyset$, thus Y' is not thin. \square

Let us look at some examples to illustrate this property. The graphs of Fig. 5c and Fig. 5d are not fusion graphs, in fact they are not even weak fusion graphs; we see that they may indeed contain a non-thin cleft. On the other hand, Fig. 5e is an example of a weak fusion graph which is not a fusion graph (see also Fig. 7w) with a cleft which is not thin.

We conclude this section with two nice properties of perfect fusion graphs (Prop. 33 and Prop. 34), which can be useful to design hierarchical segmentation methods based on watersheds, and on region merging and splitting operations. Prop. 33 follows straightforwardly from the definitions of cleft and perfect fusion graph.

Property 33. *Let $G = (E, \Gamma)$ be a perfect fusion graph. Let $X \subset E$ be a cleft and $A, B \in \mathcal{C}(\overline{X})$ such that A and B are neighbors. Then, $X \setminus \Gamma^*(A, B)$ is a cleft.*

Consider now the example of Fig. 8a, where a cleft X (black points) in the graph G separates \overline{X} into two components. Consider now the set Y (gray points) which is a cleft in the subgraph of G induced by one of these components. We can see that the union of the clefts, $X \cup Y$, is not a cleft, since the point x is W-simple for $X \cup Y$. Property Prop. 34 shows that this problem cannot occur in any perfect fusion graph.

Property 34. *Let $G = (E, \Gamma)$ be a graph. If G is a perfect fusion graph, then for any cleft $X \subset E$ in G and for any cleft $Y \subset A$ in G_A , where $A \in \mathcal{C}(\overline{X})$ and G_A is the subgraph of G induced by A , the set $X \cup Y$ is a cleft in G .*

The proof may be found in the appendix. It uses Th. 32 and a local characterization of perfect fusion graphs which will be established in the next section. Fig. 8b illustrates the property with a perfect fusion graph (the set X is depicted in black and

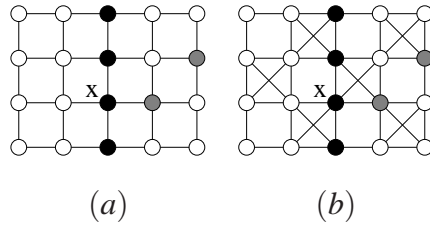

Fig. 8. Illustrations for Prop. 34. (a): The graph is not a perfect fusion graph (see Sec. 6, Prop. 45), and the union of the clefts is not a cleft. (b): The graph is a perfect fusion graph (see Sec. 7, Prop. 55), the property holds.

the set Y in gray).

5 Local characterizations

The definitions of weak fusion, fusion, strong fusion and perfect fusion graphs are based on conditions that must be verified for all the subsets of the vertex set. This means, if we want to check whether a graph is, for instance, a perfect fusion graph, then using the straightforward method based on the definition will cost an exponential time with respect to the number of vertices.

On the other hand, we know that certain classes of graphs have local characterizations. For example, line graphs may be recognized thanks to Th. 5, a condition which can be checked independently in a limited neighborhood of each vertex. Do such characterizations exist for the four classes of fusion graphs? We prove in this section that weak fusion graphs and fusion graphs cannot be characterized locally, and we give local conditions for characterizing strong fusion and perfect fusion graphs.

Let (E, Γ) be a graph, let $x \in E$ and $k \in \mathbb{N}$, we denote by $\Gamma^k(x)$ the k^{th} order neighborhood of x , that is, $\Gamma^k(x) = \Gamma(\Gamma^{k-1}(x))$, with $\Gamma^0(x) = \{x\}$.

Property 35. *There is no local characterization of weak fusion graphs. More precisely, let k be an arbitrary positive integer. There is no property \mathcal{P} on graphs such that an arbitrary graph $G = (E, \Gamma)$ is a weak fusion graph if and only if, for all $x \in E$, $\mathcal{P}[G(x, k)]$ is true, $G(x, k)$ being the subgraph of G induced by $\Gamma^k(x)$.*

Proof: It can be seen that the graphs of Fig. 9a are weak fusion graphs, while those of Fig. 9b are not. In addition, for any integer k , the same “ k -local configurations” may be found in both families, for a sufficiently large graph. \square

Property 36. *There is no local characterization of fusion graphs. More precisely, let k be an arbitrary positive integer. There is no property \mathcal{P} on graphs such that an arbitrary graph $G = (E, \Gamma)$ is a fusion graph if and only if, for all $x \in E$, $\mathcal{P}[G(x, k)]$ is true, $G(x, k)$ being the subgraph of G induced by $\Gamma^k(x)$.*

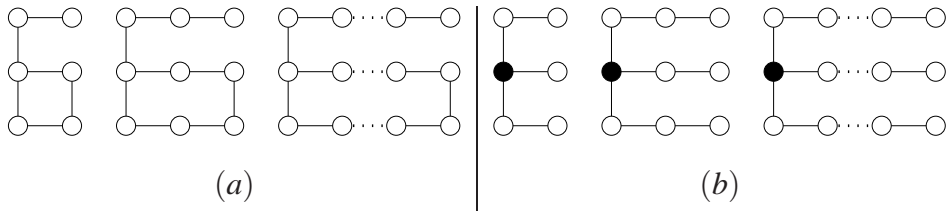

Fig. 9. Graphs for the proof of Prop. 35. In each graph of (b), the black vertices denote a set X such that the condition for a weak fusion graph is not true.

Proof: It can be seen that the graphs of Fig. 10a are fusion graphs, while those of Fig. 10b are not. In addition, for any integer k , the same “ k -local configurations” may be found in both families, for a sufficiently large graph. \square

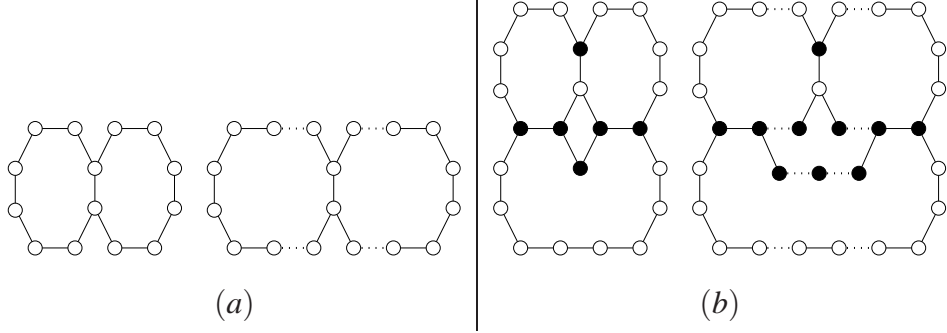

Fig. 10. Graphs for the proof of Prop. 36. In each graph of (b), the black vertices denote a set X such that the condition for a fusion graph is not true.

We are now going to prove that strong fusion graphs can be characterized locally. A few preliminary properties will help us to organize the proof. The following one states that in a strong fusion graph, if two neighboring components A and B can be merged, then they can be merged through a set S which is “close” to A and B , furthermore (next property), this set S can be reduced to one or two points.

Property 37. *Let $G = (E, \Gamma)$ be a graph. The graph G is a strong fusion graph if and only if for any $X \subseteq E$, for any A and $B \in \mathcal{C}(\overline{X})$ such that A, B are neighbors, there exists $S \subseteq [\Gamma^*(A) \cup \Gamma^*(B)]$ such that A and B can be merged through S .*

Proof: Suppose that G is a strong fusion graph. Let $X \subseteq E$, let A and $B \in \mathcal{C}(\overline{X})$ such that A, B are neighbors. Let $X' = X \setminus \text{int}(X)$. Thus, each point of X' is adjacent to (at least) one component of $\mathcal{C}(\overline{X}')$. Obviously, A, B are also components of $\mathcal{C}(\overline{X}')$, and $\Gamma^*(A) \cap \Gamma^*(B) \neq \emptyset$. Since (E, Γ) is a strong fusion graph, there exists a subset S of X' such that A, B can be merged through S , that is, S is F-simple for X' and adjacent to A and B . Since $\text{int}(X') = \emptyset$ and $S \subseteq X'$, we have $\text{int}(S) = \emptyset$. Thus, it can be easily seen that $S \subseteq \Gamma^*(A) \cup \Gamma^*(B)$. Since $X' \subseteq X$ and $\mathcal{C}(\overline{X}) \subseteq \mathcal{C}(\overline{X}')$ (a consequence of Prop. 4), it follows straightforwardly that S is also F-simple for X . This proves the forward implication, the converse is immediate. \square

Property 38. *The graph $G = (E, \Gamma)$ is a strong fusion graph if and only if, for any $X \subseteq E$, for any A and $B \in \mathcal{C}(\overline{X})$ such that A, B are neighbors, there exists a $a \in \Gamma^*(A)$*

and $b \in \Gamma^*(B)$ such that A and B can be merged through $\{a, b\}$.

Proof: Suppose that G is a strong fusion graph, let $X \subseteq E$, let A and $B \in \mathcal{C}(\overline{X})$ such that A, B are neighbors. By Prop. 37, there exists $S \subseteq [\Gamma^*(A) \cup \Gamma^*(B)]$ such that A and B can be merged through S . Without loss of generality (by Prop. 22), we may assume that S is connected. If S contains a point $x \in \Gamma^*(A) \cap \Gamma^*(B)$, then the forward implication is proved with $a = b = x$. Otherwise, S may be partitioned into two disjoint sets $A' = S \cap \Gamma^*(A)$ and $B' = S \cap \Gamma^*(B)$. Since S is connected, by Prop. 1 the sets A' and B' must be adjacent, thus there exists $a \in A'$ and $b \in B'$ which are adjacent, and since S is F-simple it can be easily seen that $\{a, b\}$ is also F-simple. This proves the forward implication, the converse is immediate. \square

Notice that in the two previous properties, the merging set S (or $\{a, b\}$) must belong to the union of $\Gamma^*(A)$ and $\Gamma^*(B)$, not to the intersection; more informally it means that A and B cannot necessarily be merged through a subset of their common boundary. To show that it is not necessary that S be included in $\Gamma^*(A) \cap \Gamma^*(B)$ for having a strong fusion graph, it suffices to consider the graph G depicted in Fig. 11. It may be checked that G is indeed a strong fusion graph. Consider the set X of black vertices, $A = \{x\}$ and $B = \{y\}$ (which are neighbors) can only be merged through $S = \{a, b\}$ which is included in $\Gamma^*(A) \cup \Gamma^*(B)$ but not in $\Gamma^*(A) \cap \Gamma^*(B)$.

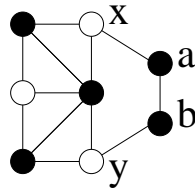

Fig. 11. Illustration of Prop. 37 and Prop. 38.

More generally, if two components A, B of \overline{X} can only be merged through a two-element set $S = \{a, b\}$, it can be seen that necessarily both a and b are W-simple. This means in particular that a configuration like Fig. 11 cannot occur if X is a cleft. From this remark, we can derive a simpler characterization of strong fusion graphs, in which we consider only the subsets X of E which are clefts.

Property 39. *The graph (E, Γ) is a strong fusion graph if and only if, for any $X \subseteq E$ which is a cleft, for any A and $B \in \mathcal{C}(\overline{X})$ such that A, B are neighbors, there exists $x \in [\Gamma^*(A) \cap \Gamma^*(B)]$ which is F-simple for X .*

We are now ready to prove the local characterization theorem for strong fusion graphs.

Let x and y be two points, we say that x and y are 2-adjacent if $y \notin \Gamma(x)$ and $\Gamma^*(x) \cap \Gamma^*(y) \neq \emptyset$.

Theorem 40. *Let $G = (E, \Gamma)$ be a graph. The graph G is a strong fusion graph if and only if, for any two points $x, y \in E$ which are 2-adjacent, there exists $a \in \Gamma^*(x)$*

and $b \in \Gamma^*(y)$ such that $b \in \Gamma(a)$ and $\Gamma(\{a, b\}) \subseteq [\Gamma(x) \cup \Gamma(y)]$.

Proof: Suppose that G is a strong fusion graph. Let $x, y \in E$ which are 2-adjacent, and consider the set $X = \Gamma^*(x) \cup \Gamma^*(y)$. We observe that the sets $A = \{x\}$ and $B = \{y\}$ are two elements of $\mathcal{C}(\bar{X})$. By Prop. 38, there exists $a \in \Gamma^*(x)$ and $b \in \Gamma^*(y)$, $b \in \Gamma(a)$, such that A and B can be merged through $\{a, b\}$ for X . Thus a and b must be mutually adjacent, and $\{a, b\}$ cannot be adjacent to a component of \bar{X} which is neither $\{x\}$ nor $\{y\}$, hence $\Gamma(\{a, b\}) \subseteq [\Gamma(x) \cup \Gamma(y)]$. Thus the forward implication is proved, and the converse is straightforward. \square

We give below seven necessary and sufficient conditions for perfect fusion graphs. Remind that in perfect fusion graphs, any two components A, B of $\mathcal{C}(\bar{X})$ which are neighbors can be merged through $\Gamma^*(A) \cap \Gamma^*(B)$. Thus, perfect fusion graphs constitute an ideal framework for region merging methods. In the sequel, we will use the symbol G^\blacktriangle to denote the graph of Fig. 3a.

Theorem 41. *Let (E, Γ) be a graph.*

The eight following statements are equivalent:

- i) (E, Γ) is a perfect fusion graph;*
- ii) for any $x \in E$, any $X \subseteq \Gamma(x)$ contains at most two connected components;*
- iii) for any non-trivial cleft Y in E , each point x in Y is F-simple;*
- iv) for any connected subset A of E , the subgraph of (E, Γ) induced by A is a fusion graph;*
- v) for any subset X of E , there is no multiple point for X ;*
- vi) the graph G^\blacktriangle is not a subgraph of G ;*
- vii) any vertices x, y, z which are mutually non-adjacent are such that $\Gamma(x) \cap \Gamma(y) \cap \Gamma(z) = \emptyset$;*
- viii) for any $x, y \in E$ which are 2-adjacent, for any $z \in \Gamma^*(x) \cap \Gamma^*(y)$, we have $\Gamma(z) \subseteq [\Gamma(x) \cup \Gamma(y)]$.*

Proof: We will show that $[not\ ii] \Rightarrow [not\ iii] \Rightarrow [not\ iv] \Rightarrow [not\ v] \Rightarrow [not\ vi] \Rightarrow [not\ vii] \Rightarrow [not\ viii] \Rightarrow [not\ i] \Rightarrow [not\ ii]$, hence the equivalence of the eight statements.

- $[not\ ii \Rightarrow not\ iii]$ Suppose that there exists $x \in E$ and there exists $X \subseteq \Gamma(x)$ which contains three distinct connected components A, B, C . Let $Y = E \setminus (A \cup B \cup C)$, and let Z be a cleft of Y . Necessarily, $x \in \bar{X}$ and thus $x \in Y$. Furthermore, since x is adjacent to three distinct components of \bar{Y} , we know that $x \in Z$ and that x is also adjacent to three distinct components of \bar{Z} , and thus is not F-simple for Z .

- $[not\ iii \Rightarrow not\ iv]$ Suppose that there exist a non-trivial cleft Y and a point $x \in Y$ which is not F-simple for Y . Since Y is a cleft, we know that x is not either a W-simple point. If x is an inner point, by Th. 32 we deduce that (E, Γ) cannot be a fusion graph, and thus condition *iv* does not hold for $A = E$. Otherwise, x is a multiple point for Y . Then, consider the set $A = [\Gamma(x) \setminus Y] \cup \{x\}$. Let (A, Γ_A) be the subgraph of (E, Γ) induced by A , and let $X = \{x\}$. The set A is connected, and since x is a multiple point for Y , $A \setminus X$ must contain at least three connected components

for (A, Γ_A) , furthermore these components cannot be merged for X since x is the only point separating them. Thus (A, Γ_A) is not a fusion graph.

- [not $iv \Rightarrow not\ v$] Suppose that there exists a connected subset A of E such that the restriction (A, Γ') of (E, Γ) to A is not a fusion graph. By Prop. 31, there exists $X \subset A$ and $x \in X$ such that x is a multiple point for X in (A, Γ') . Obviously, x is also a multiple point for $[E \setminus A] \cup X$ in (E, Γ) .

- [not $v \Rightarrow not\ vi$] Suppose that there exists a subset X of E and a point $x \in X$ which is a multiple point, *i.e.*, x is adjacent to three distinct connected components A, B, C of \bar{X} . Let $w \in \Gamma(x) \cap A$, $y \in \Gamma(x) \cap B$, and $z \in \Gamma(x) \cap C$. Since A, B, C are distinct connected components of \bar{X} , w, y, z are mutually non-adjacent, thus the subgraph induced by $\{x, y, z, w\}$ is G^\blacktriangle .

- [not $vi \Rightarrow not\ vii$] Suppose that the subgraph of G induced by some points $\{x, y, z, w\}$ is G^\blacktriangle , the central point being x . We have $x \in \Gamma(w) \cap \Gamma(y) \cap \Gamma(z)$, and w, y, z are mutually non-adjacent.

- [not $vii \Rightarrow not\ viii$] Let w, y, z be three mutually non-adjacent points of E such that $\Gamma(w) \cap \Gamma(y) \cap \Gamma(z) \neq \emptyset$, and let $x \in \Gamma(w) \cap \Gamma(y) \cap \Gamma(z)$. We have y and z which are 2-adjacent, $x \in \Gamma^*(y) \cap \Gamma^*(z)$, but $\Gamma(x)$ contains w which is not in $\Gamma(y) \cup \Gamma(z)$ by hypothesis.

- [not $viii \Rightarrow not\ i$] Let $y, z \in E$ be two points which are 2-adjacent, and let $x \in \Gamma^*(y) \cap \Gamma^*(z)$ such that there exists $w \in \Gamma(x)$, $w \notin \Gamma(y) \cup \Gamma(z)$. Let $X = E \setminus \{y, z, w\}$. Let $A = \{y\}$, $B = \{z\}$, and $C = \{w\}$. From our hypothesis, we know that A, B and C belong to $\mathcal{C}(\bar{X})$. Let $S = \Gamma^*(A, B) = \Gamma^*(A) \cap \Gamma^*(B)$, clearly $x \in S$. Since x is also adjacent to C , A and B (which are neighbors) cannot be merged through S , and the graph is not a perfect fusion graph.

- [not $i \Rightarrow not\ ii$] We will prove in fact that $ii \Rightarrow i$. Suppose that ii holds, and let $X \subset E$, let $A, B \in \mathcal{C}(\bar{X})$ such that $\Gamma^*(A, B) \neq \emptyset$. For any x in $\Gamma^*(A, B)$, from the hypothesis (ii) we deduce that x is only adjacent to A and B . Furthermore $A \cup B \cup \Gamma^*(A, B)$ is obviously connected, thus $\Gamma^*(A, B)$ is F-simple for X , and A and B can be merged through $\Gamma^*(A, B)$. \square

Notice that condition $viii$ bears a resemblance with the local characterization of strong fusion graphs (Th. 40).

Remind that any line graph is a perfect fusion graph (Prop. 29). We can see that, thanks to Th. 41 (condition vi), perfect fusion graphs can be characterized in a way similar to Th. 5 which characterizes line graphs, but with a much simpler condition.

A consequence of Th. 41 is that all the graphs of Fig. 3 except graph G^\blacktriangle are perfect fusion graphs, since none of these graphs contains G^\blacktriangle as a subgraph. The reader can also check anyone of the previous eight conditions on these graphs, as an illustration of Th. 41.

Corollary 42. *Let $G = (E, \Gamma)$ be a graph, let X be any connected subset of E . If G is a perfect fusion graph, then the subgraph of G induced by X is also a perfect fusion graph.*

6 Usual grids

The aim of this section and the following one is to answer the question: which are the grids that may be used in order to perform “safe” merging operations on digital images? In this section, we consider the different grids commonly used in 2-dimensional and 3-dimensional image processing. Our major result is that none of these grids is a perfect fusion graph and several are not even fusion graphs. One of the consequences is that the most natural merging operation, which consists in merging two regions through their common neighborhood, is not a “safe” operation in these grids.

We start with some basic definitions which allow to structure the pixels of an image. In this section and the following one, we will assume that n is a strictly positive integer.

Definition 43. *Let E be a set and let E^n be the Cartesian product of n copies of E . An element x of E^n may be seen as a map from $\{1, \dots, n\}$ to E , for each $i \in \{1, \dots, n\}$, x_i is the i -th coordinate of x .*

Let \mathbb{Z} be the set of integers. We consider the families of sets H_0^1, H_1^1 such that $H_0^1 = \{\{a\} \mid a \in \mathbb{Z}\}$, $H_1^1 = \{\{a, a+1\} \mid a \in \mathbb{Z}\}$. A subset S of \mathbb{Z}^n which is the Cartesian product of exactly $m \leq n$ elements of H_1^1 and $(n-m)$ elements of H_0^1 is called a m -cube.

In order to recover a graph structure for digital images, adjacency relations are defined on \mathbb{Z}^n . The following definition allows to retrieve the most frequently used adjacency relations.

Definition 44. *Let $m \leq n$, we say that x and y in \mathbb{Z}^n are m -adjacent if there exists a m -cube that contains both x and y . We define Γ_m^n as the binary relation on \mathbb{Z}^n such that for any pair x, y in E , $(x, y) \in \Gamma_m^n$ if and only if x and y are m -adjacent.*

In order to deal with graphs that can be arbitrary large we define a *grid* as a pair (E, Γ) where E is an infinite set and Γ is a binary relation on E . Let $X \subseteq E$, we define the restriction of (E, Γ) to X as the pair (X, Γ_X) where $\Gamma_X = \Gamma \cap (X \times X)$. If X is a finite set (X, Γ_X) is a graph. In the sequel, to simplify the notations, we will write Γ as a shortcut for Γ_X .

6.1 2-dimensional usual grids

Let w, h be two integers strictly greater than 1, called respectively *width* and *height*, we set $E = \{x \in \mathbb{Z}^2 \mid 0 \leq x_1 < w \text{ and } 0 \leq x_2 < h\}$. In this section we study the connected graph (E, Γ_1^2) (resp. (E, Γ_2^2)) which is the restriction of $(\mathbb{Z}^2, \Gamma_1^2)$ (resp.

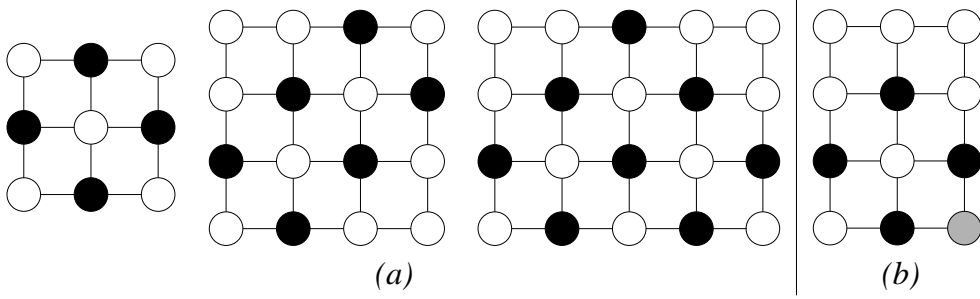

Fig. 12. (a): Counter-examples for the weak fusion property of (E, Γ_1^2) ; The black points represent a set X ; (b): counter-example for the fusion property of (E, Γ_1^2) when $\{w, h\} = \{3, 4\}$; the component of \bar{X} in gray cannot be merged.

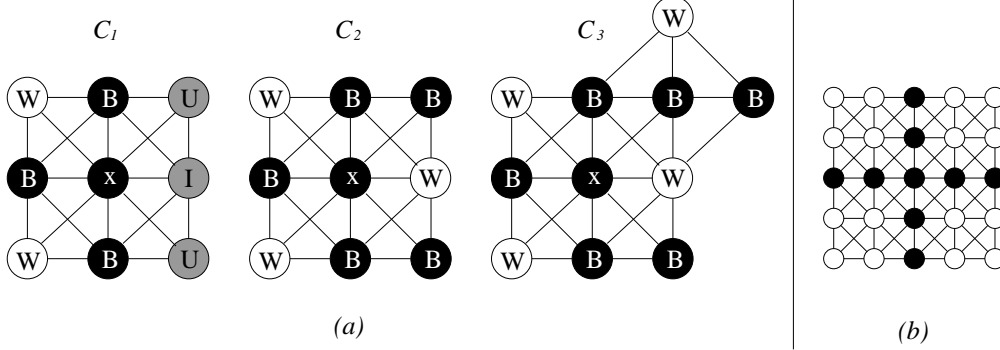

Fig. 13. (a): Local configurations which are used for proving Lem. 47; configurations C_1 and C_2 are the local configurations of multiple points in (E, Γ_2^2) ; (b): counter-example for the strong fusion property of (E, Γ_2^2) .

$(\mathbb{Z}^2, \Gamma_2^2)$ to E . Notice that Γ_1^2 (resp. Γ_2^2) corresponds to the 4 (resp. 8)-adjacency relation commonly used in the literature.

Property 45. *Let $w > 2$ and $h > 2$. If $\{w, h\} \neq \{3, 4\}$, (E, Γ_1^2) is not a weak fusion graph. If $\{w, h\} = \{3, 4\}$ then (E, Γ_1^2) is a weak fusion graph but not a fusion graph.*

Proof: If $\{w, h\} \neq \{3, 4\}$, let us consider the following set:

- (1): if both w and h are odd, $X = \{(i, j) \mid i + j \text{ is odd}\}$;
- (2): if only w is odd, $X = \{(i, j) \mid i + j \text{ is odd}\} \setminus \{(0, h-1), (w-1, h-1)\}$;
- (3): if only h is odd, $X = \{(i, j) \mid i + j \text{ is odd}\} \setminus \{(w-1, 0), (w-1, h-1)\}$;
- (4) if both w and h are even, $X = \{(i, j) \mid i + j \text{ is odd}\} \setminus \{(0, h-1), (w-1, 0)\}$.

Fig. 12a shows the set X for image domains of size 3×3 , 4×4 and 5×4 .

It may be easily checked that any connected component of \bar{X} cannot be merged for X .

Let $\{w, h\} = \{3, 4\}$. Then (E, Γ_1^2) is a weak fusion graph (exhaustive check). The graph of Fig. 12b shows a set X such that there exists connected components of \bar{X} which cannot be merged, hence (E, Γ_1^2) is not a fusion graph. \square

Let $X \subseteq E$, we say that $x \in X$ matches C_1 (resp. C_2) if the neighborhood of x cor-

responds to the configuration C_1 (resp. C_2) depicted in Fig. 13a or to one of its $\pi/2$ rotations. In Fig. 13, points labelled B are in X , points labelled W are in \bar{X} , at least one of the points labelled U is in \bar{X} and the point I is either in X or in \bar{X} .

Lemma 46. *Let $X \subseteq E$ be a cleft on (E, Γ_2^2) . Then any x in X which is multiple matches either C_1 or C_2 .*

Proof: Exhaustive check. \square

Lemma 47. *Let $X \subset E$ be a non-trivial cleft on (E, Γ_2^2) . Then any $A \in \mathcal{C}(\bar{X})$ can be merged.*

Proof: Suppose that A cannot be merged, then any $x \in X \cap \Gamma_2^2(A)$ is multiple. Since (E, Γ_2^2) is connected and $\mathcal{C}(\bar{X}) > 2$, such an x exists. Thus by Lem. 46, x matches either C_1 or C_2 . Suppose that x matches C_1 . If the two points labelled W in C_1 belong to the same connected component of \bar{X} then the point at the west of x is W-simple, a contradiction with the fact that X is a cleft. Thus necessarily these two points belong to distinct components of \bar{X} , and the point at the west of x is F-simple. If A contains one of the these two points, labelled W in C_1 , then A is adjacent to an F-simple point and thus can be merged. Otherwise A contains one of the points labelled U . In this case the same arguments can be used to prove that A can be merged, thus x does not match C_1 .

Suppose that x matches C_2 . For the same reasons, A is the connected component that contains the point at the east of x . As A cannot be merged, necessarily the point which is at the north of x is multiple. Then the only possible configuration is C_3 , which is depicted in Fig. 13a. In configuration C_3 , it can be verified that the point at the north-east of x is necessarily F-simple. Thus A can be merged, a contradiction. \square

Property 48. *Let $h > 2$ and $w > 2$, the graph (E, Γ_2^2) is a fusion graph but is not a strong fusion graph.*

Proof: The fact that (E, Γ_2^2) is a fusion graph is a direct corollary of Lem. 47 and Th. 32. Let us consider the set X , composed by the black points in Fig. 13b. It can be seen that this type of “global cross configuration” can be extended whatever the size of E (with $h > 2$ and $w > 2$). In these cross configurations, the connected components which are diagonally neighbor to each other cannot be merged. Thus the graph (E, Γ_2^2) is not a fusion graph. \square

6.2 3-dimensional usual grids

Let w , h and d be three integers strictly greater than 1, called respectively *width*, *height* and *depth*, we set $E = \{x \in \mathbb{Z}^3 \mid 0 \leq x_1 < w, 0 \leq x_2 < h \text{ and } 0 \leq x_3 < d\}$. In the sequel we will consider that $w > 1, h > 1$ and $d > 1$. In this section we study

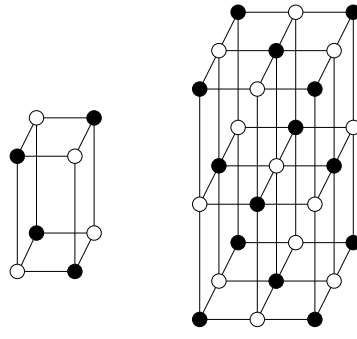

Fig. 14. Counter-examples for the weak fusion property of (E, Γ_1^3) . The black points represent a set X .

the graph (E, Γ_1^3) (resp. (E, Γ_3^3)) which is the restriction of $(\mathbb{Z}^3, \Gamma_1^3)$ (resp. $(\mathbb{Z}^3, \Gamma_3^3)$) to E . Notice that Γ_1^3 (resp. Γ_3^3) corresponds to the 6 (resp. 26)-adjacency relation commonly used in the literature.

Property 49. *The graph (E, Γ_1^3) is not a weak fusion graph.*

Proof: Let us consider the set X such that $X = \{x \in E \mid \text{the number of odd coordinates of } x \text{ is equal to } 0 \text{ or } 2\}$ (this set corresponds to a “3-dimensional chessboard”). Samples of such a set are shown in Fig. 14. It may be easily seen that any element of \bar{X} is a connected component that cannot be merged without involving at least two other connected components. Hence the graph is not a weak fusion graph. \square

Property 50. *If $w \geq 5, h \geq 5, d \geq 5$, the graph (E, Γ_3^3) is not a fusion graph.*

Proof: Let us consider the set \bar{X} of white points depicted in Fig. 15a. Whatever the size of E and supposing that all points of E outside the figure are in X , it may be seen that the central point x is such that $\{x\}$ is a connected component of \bar{X} . Any point 3-adjacent to x (the set of gray points) is adjacent to at least three distinct connected components of \bar{X} . Thus any attempt to merge $\{x\}$ will involve three connected components of \bar{X} , hence $\{x\}$ cannot be merged, (E, Γ_3^3) is not a fusion graph. \square

Remark 51. *It is known in digital topology [13], that in the 2-dimensional case, a skeleton (i.e., a set without any simple point) does not contain any 3×3 square whenever Γ_2^2 (resp. Γ_1^2) is used for the background (resp. object) [1]. We may wonder if this property can be extended to the 3-dimensional case. From the characterization of simple points based on connectivity numbers [5], it can be seen that any simple point, when Γ_3^3 (resp. Γ_1^3) is used for the background (resp. object), is W -simple when using the graph (E, Γ_3^3) . From this we see that any cleft, in this context, is a skeleton (but the converse is not true). From Prop. 50 and Th. 32, we deduce that there exists some clefts in (E, Γ_3^3) which are not thin (see an example Fig. 15b). Such a cleft, which is also a skeleton, contains (at least) one $3 \times 3 \times 3$ cube.*

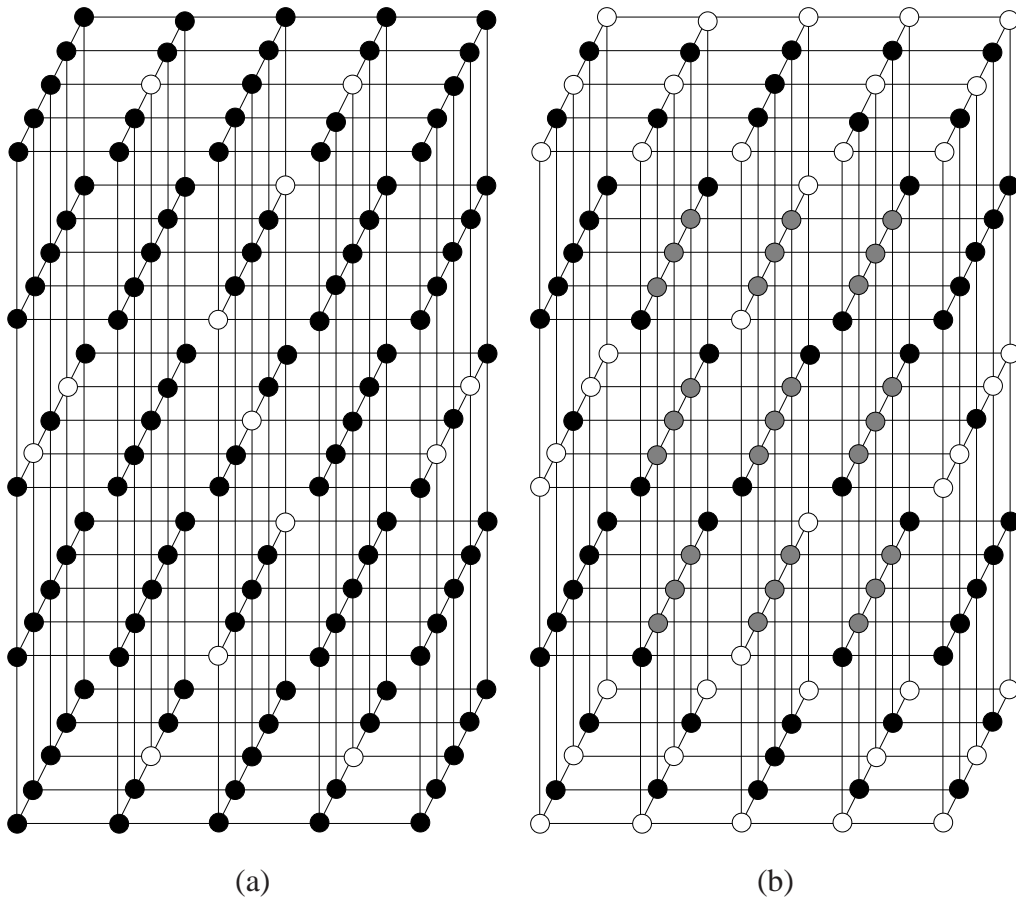

Fig. 15. (a): Counter-example (set of black points) for the fusion property of (E, Γ_3^3) . (b): Black and gray points represent a set X which is a non-thin cleft, and also a skeleton which includes a $3 \times 3 \times 3$ cube (gray points).

7 Perfect fusion grid

We introduce a grid for structuring n -dimensional digital images and prove that it is a perfect fusion graph, whatever the dimension n . It does thus constitute a structure on which neighboring regions, in an n -dimensional digital image, can be merged through their common neighborhood.

Fig. 17b gives an intuitive idea of this grid. Fig. 16a shows a cleft of Fig. 1a obtained on this grid. It can be easily seen that the problems pointed out in the introduction do not exist in this case. The cleft does not contain any inner point. Any pair of neighboring regions can be merged by simply removing from the cleft the points which are adjacent to both regions (see Fig. 16b,c). Furthermore, the resulting set is still a cleft.

It may be seen that this grid is “between” the usual grids. We will prove in a forthcoming paper that this grid is indeed the unique such graph.

Let C^n be the set of all n -cubes of \mathbb{Z}^n , we define the map B from C^n to \mathbb{Z}^n , such that for any $c \in C^n$, $B(c)_i = \min\{x_i \mid x \in c\}$, where $B(c)_i$ is the i -th coordinate of $B(c)$.

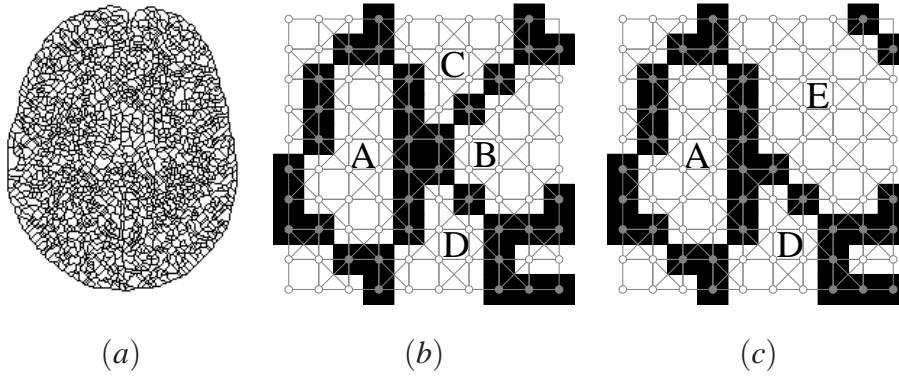

Fig. 16. (a): A cleft of Fig. 1 obtained on the perfect fusion grid; (b): a crop of (a) where the region A, B, C and D corresponds to the region shown in Fig. 1d; in gray, the corresponding perfect fusion grid is superimposed; (c): same as (d) after having merged B and C to form a new region, called E.

It may be seen that c is equal to the Cartesian product: $\{B(c)_1, B(c)_1 + 1\} \times \dots \times \{B(c)_n, B(c)_n + 1\}$. Thus clearly B is a bijection.

We set $\mathbb{B} = \{0, 1\}$. We set $\bar{0} = 1$ and $\bar{1} = 0$. A *binary word of length n* is an element of \mathbb{B}^n . If u is in \mathbb{B}^n , we define *the complement of u* as the binary word \bar{u} such that for any $i \in \{1, \dots, n\}$, $(\bar{u})_i = (\overline{u_i})$.

Before defining perfect fusion grids, we first recall the definition of cliques, and a property due to Berge which uses maximal cliques to characterize some line graphs. This property will be used in the proof of Prop. 55.

Let E be a set, let Γ be a binary relation on E and let $X \subseteq E$. We say that X is a *clique (for (E, Γ))* if $X \times X \subseteq \Gamma$. In other words, X is a clique if any two vertices of X are adjacent. We say that X is a *maximal clique* if, for any clique X' , $X \subseteq X'$ implies $X' = X$.

Property 52 (Prop. 7 in [3], chapter 17). *Let $G = (E, \Gamma)$ be a graph. If for any $x \in E$, x is in at most two distinct maximal cliques, then G is a line graph.*

Definition 53. *Let f be the map from C^n to \mathbb{B}^n such that for any $c \in C^n$, $f(c)_i$ is equal to $B(c)_i \bmod 2$, that is the remainder in the integer division of $B(c)_i$ by 2.*

Let u be an element of \mathbb{B}^n , we set $C_u^n = \{c \in C^n \mid f(c) = u\}$ and $C_{u/\bar{u}}^n = C_u^n \cup C_{\bar{u}}^n$.

We define the binary relation $\Gamma_{u/\bar{u}}^n \subseteq \mathbb{Z}^n \times \mathbb{Z}^n$ as the set of pairs $(x, y) \in \mathbb{Z}^n \times \mathbb{Z}^n$ such that there exists $c \in C_{u/\bar{u}}^n$ that contains both x and y .

We define \mathcal{P}^n , the family of perfect fusion grids over \mathbb{Z}^n , as the set $\mathcal{P}^n = \{(\mathbb{Z}^n, \Gamma_{u/\bar{u}}^n) \mid u \in \mathbb{B}^n\}$.

Fig. 17 illustrates the above definitions for the two-dimensional case. Fig. 18 shows a cleft on a 3-dimensional perfect fusion grid. To clarify the figure, we use the following convention: any two points belonging to a same cube marked by a gray

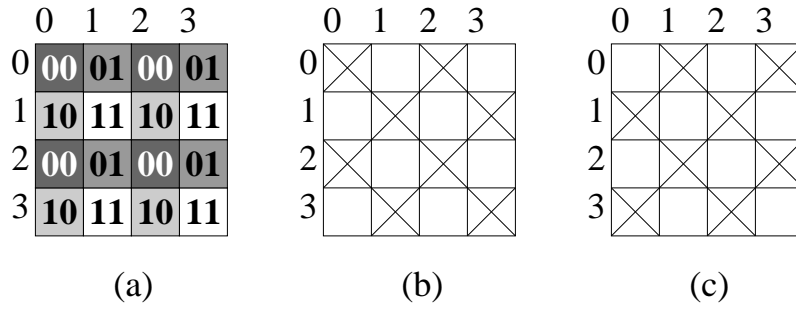

Fig. 17. Illustration of the two perfect fusion grids over \mathbb{Z}^2 (restricted to subsets of \mathbb{Z}^2).
(a): The map f ; (b): $(\mathbb{Z}^2, \Gamma_{11/00}^2)$; (c): $(\mathbb{Z}^2, \Gamma_{10/01}^2)$.

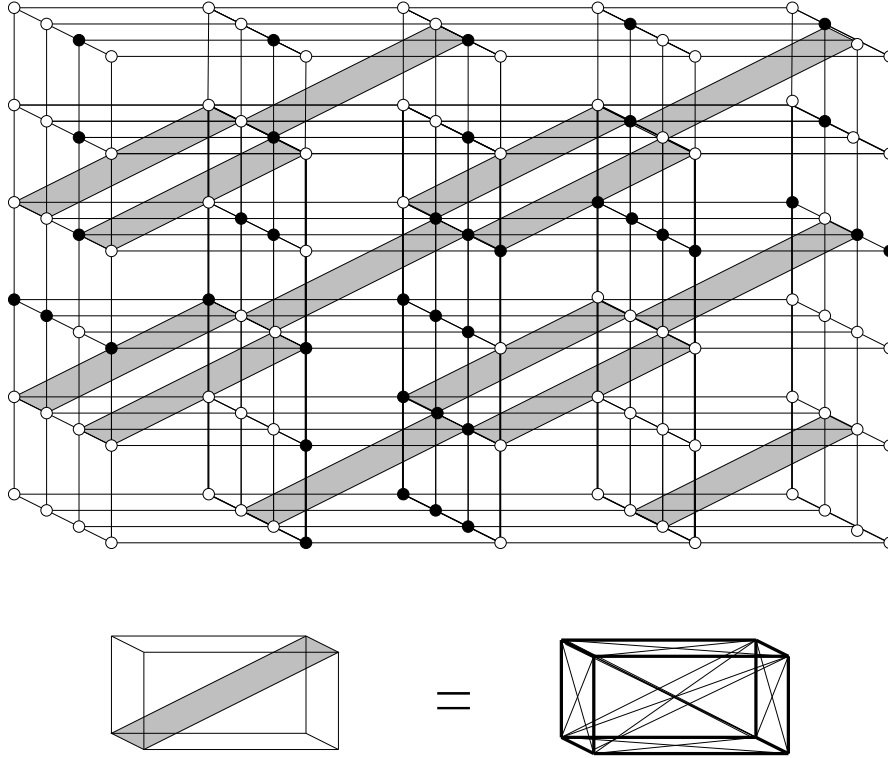

Fig. 18. A 3-dimensional perfect fusion grid. Black points constitute a set which is a cleft. stripe are adjacent to each other.

In the sequel, to simplify the notations, we will write c_i as a shortcut for $B(c)_i$.

Lemma 54. Let $u \in \mathbb{B}^n$ and let $x \in \mathbb{Z}^n$.

- i) There exists a unique c in C_u^n such that $x \in c$.
- ii) The point x is in exactly two maximal cliques of $(\mathbb{Z}^n, \Gamma_{u/\bar{u}}^n)$.

Proof: It may be easily seen that any element c of C^n which contains x is such that for any $i \in \{1, \dots, n\}$, $c_i = x_i - 1$ or $c_i = x_i$, hence i).

We deduce from i) that there are exactly two distinct elements c and c' of $C_{u/\bar{u}}^n$ such that $c \in C_u^n$, $c' \in C_{\bar{u}}^n$ and such that x is in both c and c' . Thus any element adjacent

to x is either in c or in c' . From the very definition of $\Gamma_{u/\bar{u}}^n$, any pair of elements of c (resp. c') is in $\Gamma_{u/\bar{u}}^n$. Thus c and c' are cliques of $(\mathbb{Z}^n, \Gamma_{u/\bar{u}}^n)$, which both contain x . Since any pair (y, y') with $y \in c \setminus c'$, $y' \in c' \setminus c$ is not in $\Gamma_{u/\bar{u}}^n$, we conclude that x is in exactly two maximal cliques. \square

Property 55. *Let $u \in \mathbb{B}^n$ and let X be a finite subset of \mathbb{Z}^n such that $(X, \Gamma_{u/\bar{u}}^n)$ is connected. Then $(X, \Gamma_{u/\bar{u}}^n)$ is a perfect fusion graph. Furthermore it is a line graph.*

Proof: From Lem. 54, any x in X is in at most two maximal cliques. Thus, as a consequence of Prop. 52, $(X, \Gamma_{u/\bar{u}}^n)$ is a line graph and from Prop. 29 it is a perfect fusion graph. \square

The following property shows that the perfect fusion grid is “between” the usual adjacency relations on \mathbb{Z}^n .

Property 56. *Let $u \in \mathbb{B}^n$. We have: $\Gamma_1^n \subseteq \Gamma_{u/\bar{u}}^n \subseteq \Gamma_n^n$.*

Proof: From Lem. 54, we know that for any $x \in \mathbb{Z}^n$ there exist exactly two maximal cliques $c \in C_u^n$ and $c' \in C_{\bar{u}}^n$ that contain x . Necessarily there exists k such that $B(c) = x - k$ with $k \in \mathbb{B}^n$ and $B(c') = x - \bar{k}$. A point x' is in $\Gamma_1^n(x)$ if there exists a unique $j \in \{1, \dots, n\}$ such that $x'_j = x_j + 1$ or $x'_j = x_j - 1$ and for any $i \in [\{1, \dots, n\} \setminus \{j\}]$, $x'_i = x_i$. Suppose that $x'_j = x_j - 1$. The case where $x'_j = x_j + 1$ is symmetric to this one and the following arguments hold for both cases. For any $i \in [\{1, \dots, n\} \setminus \{j\}]$, either $k_i = 0$ or $k_i = 1$. If $k_i = 0$, then $x'_i = x_i = c_i = c'_i + 1$. If $k_i = 1$, then $x'_i = x_i = c'_i = c_i + 1$. On the other hand, if $k_j = 1$ then $x'_j = x_j - 1 = c_j$, hence $x' \in c$. Otherwise, if $k_j = 0$ then $x'_j = x_j - 1 = c'_j$, hence $x' \in c'$. Whatever the case, $(x, x') \in \Gamma_{u/\bar{u}}^n$, hence $\Gamma_1^n \subseteq \Gamma_{u/\bar{u}}^n$. The proof of the second inclusion follows straightforwardly from the definition of $\Gamma_{u/\bar{u}}^n$. \square

Property 57. *The family \mathcal{P}^n contains 2^{n-1} distinct perfect fusion grids.*

Proof: From the very definition of perfect fusion grids, we have $\Gamma_{u/\bar{u}}^n = \Gamma_{\bar{u}/u}^n$. Furthermore, if $\{u, \bar{u}\} \neq \{v, \bar{v}\}$ then $\Gamma_{u/\bar{u}}^n \neq \Gamma_{v/\bar{v}}^n$. Since the cardinality of \mathbb{B}^n is equal to 2^n , the cardinality of \mathcal{P}^n is equal to $2^n/2 = 2^{n-1}$. \square

Let $X \subseteq \mathbb{Z}^n$ and let $t \in \mathbb{B}^n$. We define $X + t = \{x + t \mid x \in X\}$, we say that $X + t$ is a *binary translation of X* . Let m be a positive integer such that $m \leq n$. Remark that if X is an m -cube then $X + t$ is also an m -cube.

The following property states that any two n -dimensional perfect fusion grids are equivalent up to a binary translation.

Property 58. *Let u and v in \mathbb{B}^n . Let $t \in \mathbb{B}^n$ such that for any $i \in \{1, \dots, n\}$, if $u_i = \bar{v}_i$ then $t_i = 1$, otherwise $t_i = 0$. Then for any $(x, y) \in \mathbb{Z}^n \times \mathbb{Z}^n$, $(x, y) \in \Gamma_{u/\bar{u}}^n$ if and only if $(x + t, y + t) \in \Gamma_{v/\bar{v}}^n$.*

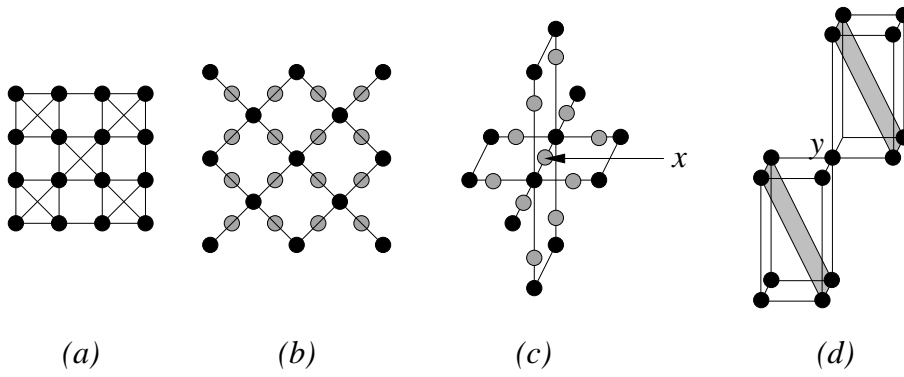

Fig. 19. Illustrations of the relation between line graphs of 1-connected graph and perfect-fusion grids. (a): a restriction of the 2-dimensional perfect fusion grid; (b): a graph (black points and edges) whose line graph is (a); the gray points indicate corresponding vertices of the line graph (a) of (b); (c): black points and edges depict a local configuration of the 3-dimensional 1-connected grid; the gray points indicate corresponding vertices of the line graph of (c) in which any gray point is adjacent to x ; (d): a local configuration of the perfect fusion grid, any black point is adjacent to y .

Proof: It can easily be seen that for any $c \in C^n$, $f(c) = u$ (resp. $f(c) = \bar{u}$) if and only if $f(c+t) = v$ (resp. $f(c+t) = \bar{v}$). The result follows from this observation and from the definition of the perfect fusion grids. \square

Let u in \mathbb{B}^2 . Let X be a finite subset of \mathbb{Z}^2 . It can be seen that $(E, \Gamma_{u/\bar{u}}^2)$ is the line graph of a graph (E', Γ_1^2) , with $E' \subset \mathbb{Z}^2$. For example, Fig. 19a shows a 2-dimensional perfect fusion grid, its associated graph (E', Γ_1^2) is depicted in Fig. 19b. Remark that a similar statement is not true in dimension 3. Local configurations of $(\mathbb{Z}^3, \Gamma_1^3)$ and of its line graph are depicted in Fig. 19c. A local configuration of $(\mathbb{Z}^3, \Gamma_{u/\bar{u}}^3)$ is depicted in Fig. 19d. It can be checked that the point x in Fig. 19c has exactly 10 neighbors whereas the point y in Fig. 19d has 14 neighbors. Thus those two configurations cannot be isomorphic.

Conclusion

This article sets up a theoretical framework for the study of merging properties in graphs. Using this framework, we obtained a necessary and sufficient condition for the thinness of clefts, we defined four classes of graphs in relation to these merging properties and gave local characterizations of these classes whenever possible. We also analyzed the status of the graphs which are the most widely used for image analysis, and proposed a family of graphs on \mathbb{Z}^n which constitute an ideal support for region merging.

In the articles [11,12], we extend this study to the case of weighted graphs (*i.e.*, graphs with values associated to vertices), which constitute a model for grayscale images. The notion of topological watershed [4,7] extends the notion of cleft to weighted graphs, and possess interesting properties which are not guaranteed by most popular watershed algorithms [15]. The major outcomes of [11,12] are:

- i) a proof that any topological watershed on any perfect fusion graph is thin;
- ii) a new, simple and linear-time algorithm to compute topological watersheds on perfect fusion graphs.

In a forthcoming article [10], we investigate the case of graphs with values associated to edges. Contrarily to previous works, we define the watersheds following the intuitive idea of flowing drops of water. We establish the consistency of these watersheds, and prove their optimality in terms of minimum spanning forests. We introduce a new local transformation on maps which equivalently define these watersheds, and derive two linear-time algorithms. To our best knowledge, similar properties are not verified in other frameworks and the two proposed algorithms are the most efficient existing ones.

References

- [1] J.C. Alexander and A.I. Thaler. The boundary count of digital pictures. *J. Assoc. Comput. Mach.*, 18:105–112, 1971.
- [2] L.W. Beineke. On derived graphs and digraphs. In H. Sachs, H.J. Voss, and H. Walther, editors, *Beiträge zur graphen theorie*, pages 17–23. Teubner, 1968.
- [3] C. Berge. *Graphes et hypergraphes*. Dunod, 1970.
- [4] G. Bertrand. On topological watersheds. *Journal of Mathematical Imaging and Vision*, 22(2-3):217–230, May 2005. Special issue on Mathematical Morphology.
- [5] G. Bertrand and G. Malandain. A new characterization of threedimensional simple points. *Pattern Recognition Letters*, 15(2):169–175, 1994.
- [6] S. Beucher and Ch. Lantuéjoul. Use of watersheds in contour detection. In *procs. Int Workshop on Image Processing Real-Time Edge and Motion Detection/Estimation*, 1979.
- [7] M. Couprie and G. Bertrand. Topological grayscale watershed transform. In *SPIE Vision Geometry V Proceedings*, volume 3168, pages 136–146, 1997.
- [8] M. Couprie, L. Najman, and G. Bertrand. Quasi-linear algorithms for the topological watershed. *Journal of Mathematical Imaging and Vision*, 22(2-3):231–249, May 2005. Special issue on Mathematical Morphology.
- [9] J. Cousty, G. Bertrand, M. Couprie, and L. Najman. Fusion graphs, region merging and watersheds. In A. Kuba, K. Palágyi, and L.G. Nyúl, editors, *Discrete geometry for*

computer imagery, volume 4245 of *Lecture Notes in Computer Science*, pages 343–354. Springer, 2006.

- [10] J. Cousty, G. Bertrand, L. Najman, and M. Couprie. Watersheds, minimum spanning forests, and the drop of water principle. Technical Report IGM2007-01, Université de Marne-la-Vallée, 2007. Submitted.
- [11] J. Cousty, M. Couprie, L. Najman, and G. Bertrand. Grayscale watersheds on perfect fusion graphs. In *Combinatorial Image Analysis*, volume 4040 of *Lecture Notes in Computer Science*, pages 60–73. Springer, 2006.
- [12] J. Cousty, M. Couprie, L. Najman, and G. Bertrand. Weighted fusion graphs: merging properties and watersheds. Technical Report IGM2007-09, Université de Marne-la-Vallée, 2007. Submitted.
- [13] T. Y. Kong and A. Rosenfeld. Digital topology: introduction and survey. *Computer Vision, Graphics and Image Processing*, 48:357–393, 1989.
- [14] F. Meyer and S. Beucher. Morphological segmentation. *Journal of Visual Communication and Image Representation*, 1(1):21–46, 1990.
- [15] L. Najman, M. Couprie, and G. Bertrand. Watersheds, mosaics and the emergence paradigm. *Discrete Applied Mathematics*, 147(2-3):301–324, April 2005. Special issue on DGCI.
- [16] T. Pavlidis. *Structural Pattern Recognition*, volume 1 of *Springer Series in Electrophysics*, chapter 4–5, pages 90–123. Springer-Verlag, 1977. segmentation techniques.
- [17] A. Rosenfeld and A.C. Kak. *Digital picture processing*, volume 2, chapter 10. Academic Press, 1982. Section 10.4.2.d (region merging).
- [18] W.T. Tutte. *Graph theory*. Cambridge University Press, 1984.

Appendix

Proof of Prop. 16: Since $|\mathcal{C}(\overline{X})| \geq 2$ we have $A \cup \text{ann}(A) \neq E$, and since E is connected, from Cor. 2 there must exist a point x in $\Gamma^*(A \cup \text{ann}(A))$. Furthermore, x must be adjacent to at least one component B of \overline{X} distinct from A , otherwise $\text{ann}(A) \cup \{x\}$ would be W -simple for \overline{X} , a contradiction with the definition of $\text{ann}(A)$; and x cannot belong to B , otherwise $\text{ann}(A)$ would not be W -simple for \overline{X} , also a contradiction with the definition of $\text{ann}(A)$. \square

Proof of Prop. 21:

Suppose that $A \cup B \cup S \in \mathcal{C}(\overline{X \setminus S})$. Let $C \in \mathcal{C}(\overline{X} | S)$, then $A \cup B \cup S \cup C$ is connected and $A \cup B \cup S \subseteq A \cup B \cup S \cup C \subseteq \overline{X \setminus S}$. Since $\overline{X} \neq \emptyset$, as a connected component of \overline{X} the set C cannot be empty, and since $A \cup B \cup S \in \mathcal{C}(\overline{X \setminus S})$, we must have either $C = A$ or $C = B$.

Suppose now that S is F-simple for X and adjacent to A and B . Thus, $A \cup B \cup S$ is connected, it remains to prove that it is maximal. Let $Z \subset E$ such that $A \cup B \cup S \subseteq Z \subseteq \overline{X \setminus S}$, and Z connected. Let $Y = Z \setminus [A \cup B \cup S]$. Since $Z \subseteq \overline{X \setminus S}$, we have $Y \subseteq \overline{X}$. Since A (resp. B) belongs to $\mathcal{C}(\overline{X})$, Y cannot be adjacent to A (resp. to B), and since $\mathcal{C}(\overline{X}|S) = \{A, B\}$, Y cannot be adjacent to S . Since Z is connected, by Prop. 1 we deduce that Y must be empty, thus $Z = A \cup B \cup S$, and $A \cup B \cup S$ is a component of $\overline{X \setminus S}$. The other components of $\overline{X \setminus S}$ are clearly the components of \overline{X} which differ from A and B . \square

Lemma 59. *Any strong fusion graph is a fusion graph.*

Proof: Let $G = (E, \Gamma)$ be a strong fusion graph, let $X \subset E$ such that $|\mathcal{C}(\overline{X})| \geq 2$, and let $A \in \mathcal{C}(\overline{X})$. By Prop. 16, there exists $B \in \mathcal{C}(\overline{X})$, $B \neq A$, such that $A \cup \text{ann}(A)$ and B are neighbors. Since G is a strong fusion graph, there exists $S \subseteq [X \setminus \text{ann}(A)]$ such that $A \cup \text{ann}(A)$ and B can be merged through S for $X \setminus \text{ann}(A)$. Consider $S' = S \cup \text{ann}(A)$, it can easily be seen that S' is adjacent to exactly two components of \overline{X} , namely A and B , thus A can be merged for X . \square

Lemma 60. *Let (E, Γ) be a graph. Let $X \subset E$, let $A \in \mathcal{C}(\overline{X})$, and let $Y \subseteq A$. Then, we have $\mathcal{C}(\overline{X \cup Y}) = [\mathcal{C}(\overline{X}) \setminus \{A\}] \cup \mathcal{C}(A \setminus Y)$.*

The proof is elementary. This lemma is useful in the following proof.

Proof of Prop. 34: We have to prove that any x in $X \cup Y$ cannot be W-simple. If $Y = \emptyset$ then $X \cup Y = X$ which is a cleft. Suppose from now that $Y \neq \emptyset$.

Let $x \in Y$. Since $Y \subset A$ and $Y \neq \emptyset$ and Y is a cleft, there exists $B, C \in \mathcal{C}(\overline{A \setminus Y})$ which are adjacent to x and by Lem. 60, B and C also belong to $\mathcal{C}(\overline{X \cup Y})$, thus x is not W-simple for $X \cup Y$.

Let $x \in X$. Since X is a cleft for E and G is a perfect fusion graph, by Th. 32, X is thin and thus x is adjacent to exactly two elements B, C of $\mathcal{C}(\overline{X})$. If $B \neq A$ and $C \neq A$ then from Lem. 60 we deduce that x is also F-simple for $X \cup Y$, suppose now that $B = A$ (the case $C = A$ is identical). If $\Gamma^*(x) \cap Y = \emptyset$ then x is adjacent to C and to a component of $A \setminus Y$, it is thus not W-simple for $X \cup Y$. Suppose now that there exists $y \in \Gamma^*(x) \cap Y$. Since Y is a cleft for A there exists two points a, b in $\Gamma^*(y)$ which belong to distinct components of $A \setminus Y$ (thus, a and b are not adjacent). Furthermore, $y \in \Gamma(x) \cap \Gamma(a) \cap \Gamma(b)$ and since G is a perfect fusion graph and by the converse of Th. 41(viii), x must be adjacent to either a or b . Hence, x is not W-simple. \square