

Research Article

Fuzzy Logic-Based Systems for the Diagnosis of Chronic Kidney Disease

Murugesan G. ¹, **Tousief Irshad Ahmed** ², **Jyoti Bhola** ³, **Mohammad Shabaz** ⁴,
Jimmy Singla ⁵, **Manik Rakhra** ⁵, **Sujeet More** ⁶, and **Issah Abubakari Samori** ⁷

¹Department of Computer Science and Engineering, St. Joseph's College of Engineering, Chennai 600119, India

²Department of Clinical Biochemistry, Sher-i-Kashmir Institute of Medical Sciences, Soura, Srinagar, J&K, India

³Electronics & Communication Engineering Department, National Institute of Technology, Hamirpur, India

⁴Model Institute of Engineering and Technology, Jammu, J&K, India

⁵Department of Computer Science and Engineering, Lovely Professional University, Phagwara, Punjab 14411, India

⁶Department of Information Technology, Trinity College of Engineering and Research, Pune, India

⁷School of Engineering Sciences, University of Ghana, Ghana

Correspondence should be addressed to Tousief Irshad Ahmed; khagankhan@gmail.com
and Issah Abubakari Samori; iasamori@st.ug.edu.gh

Received 1 February 2022; Revised 2 March 2022; Accepted 8 March 2022; Published 22 March 2022

Academic Editor: B. D. Parameshachari

Copyright © 2022 Murugesan G. et al. This is an open access article distributed under the Creative Commons Attribution License, which permits unrestricted use, distribution, and reproduction in any medium, provided the original work is properly cited.

Kidney failure occurs whenever the kidney stops to operate properly and would be unable to cleanse or refine the bloodstream as it should. Chronic kidney disease (CKD) is a potentially fatal consequence. If this condition is diagnosed early, its progression can be delayed. There are various factors that increase the likelihood of developing kidney failure. As a consequence, in order to detect this potentially fatal condition early on, these risk factors must be checked on a regular basis before the individual's health deteriorates. Furthermore, it lowers the cost of therapy. The chronic kidney or renal disease will be recognized in this work utilizing fuzzy and adaptive neural fuzzy inference systems. The fundamental purpose of this initiative is to enhance the precision of medical diagnostics used to diagnose illnesses. Nephron functioning, glucose levels, systolic and diastolic blood pressure, maturity level, weight and height, and smoking are all elements to consider while developing a fuzzy and adaptable neural fuzzy inference system. The output variable describes a specific patient's stage of chronic renal disease based on input factors such as stage 1, stage 2, stage 3, stage 4, and stage 5. The outcome will show the present stage of a patient's kidney. As a result, these methods can assist specialists in determining the stage of chronic renal disease. MATLAB software is used to create the fuzzy and neural fuzzy inference systems.

1. Introduction

Health informatics is a relatively recent field that includes the collection, storage, retrieval, and analysis of health data. Health informatics is a relatively recent field that includes the collection, storage, retrieval, and analysis of health data. Also allows communication and the most efficient utilization of healthcare resources data, and understanding. The code of ethic employs the techniques and technologies of the goal of information sciences to solve issues [1, 2]. Renal or kidney disease occurs as a result of nephron dysfunction in the kidney. It essentially happens whenever the kidney quits func-

tioning, such as maintaining the pH, hydration, and sodium levels in the bloodstream. The kidney is indeed the biological immune blood purifier, and it excretes waste in the form of urine. Because of this life-threatening condition, the kidney loses all functioning over time. This condition can also cause harm to the kidney's neighbouring organs. Chronic renal disease will progressively worsen over time. There are 5 phases of chronic kidney disease. In the first three stages, there are no specific symptoms by the virtue of which this disease will be detected easily at these three stages. But this disease must be detected at the initial or early stages. In the fourth stage of this disease, the functionality of

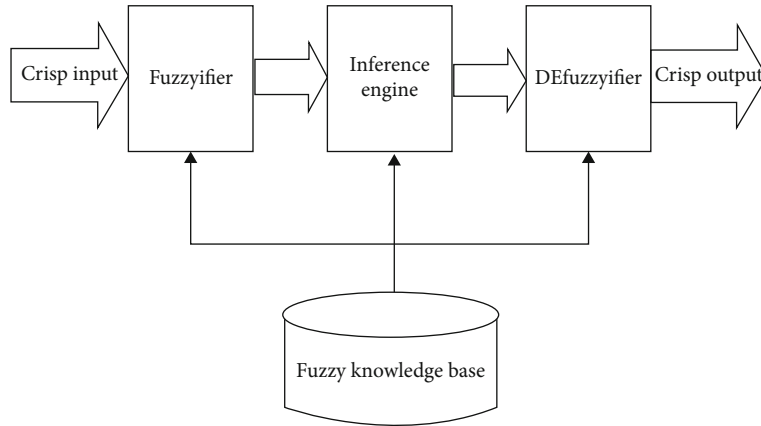

FIGURE 1: Architecture of the fuzzy inference system.

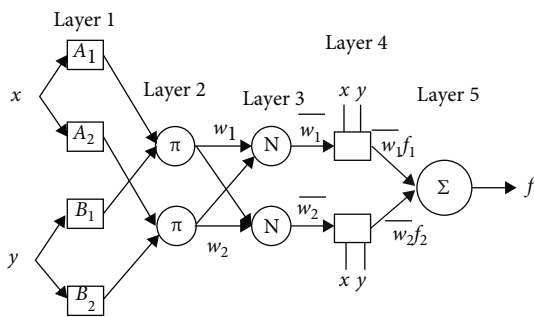

FIGURE 2: Structure of five-layer ANFIS.

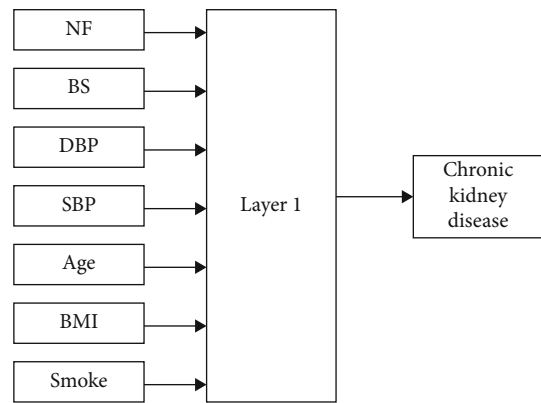

FIGURE 4: Development of a fuzzy expert system.

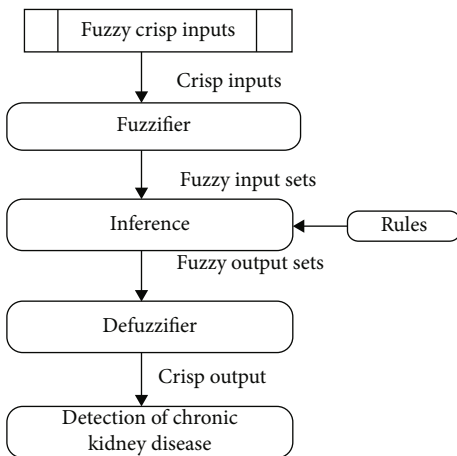

FIGURE 3: Methodology of fuzzy inference expert system.

the kidney is very low and the required treatment of this is needed to improve the condition of the kidney. At the end or fifth stage, the kidney is no longer able to do its tasks properly. It fails to remove the extra water and waste products from the body. This stage is basically known as kidney failure, and there is no cure for this rather than kidney transplant or dialysis. Because chronic kidney disease is asymptomatic, it is difficult to identify until it has progressed, resulting in fewer options for preventing disease. To prevent the disease or to control the progress of kidney failure, one

should detect and treat chronic kidney disease in the initial stages. The identification of these diseases at introductory stage and also the identification of causes and risk factors will mitigate the production of this disease and keep under control the difficult condition or complications of health of a particular patient suffering from the chronic kidney disease. The health situation of CKD sufferers is pending to get diagnosed which is aggravating than others. Thus, in introductory stages, the chunk of the patients begins their medical care at that time. The transplantation of excretory organs of the human body as well as the dialysis has to be done under the supervision of experts that will minimize mortality rates. The finest technique to reduce the risk of renal disorder is to have the regular appointments for check-ups with doctor who helps to restrain diabetes and the blood pressure of the body. These daily consultations with physician can decrease the complications of this disease that a patient faces. To achieve the maximum accuracy, the doctor has to keep all the records of patient chronic kidney disease with no missing values in it. The prevalence of patients with kidney disorders has increased in recent years, owing to an increase in population and an unhealthy lifestyle [3, 4]. It is difficult for a person to recuperate from any renal condition [5, 6]. The extraction of features from an obtained picture may also be used to identify renal illness and condition. References [7, 8] examined the kidney features by using

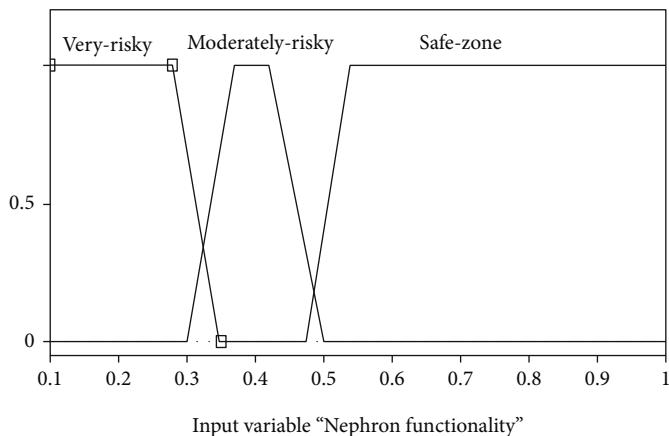

FIGURE 5: Membership function for nephron functionality.

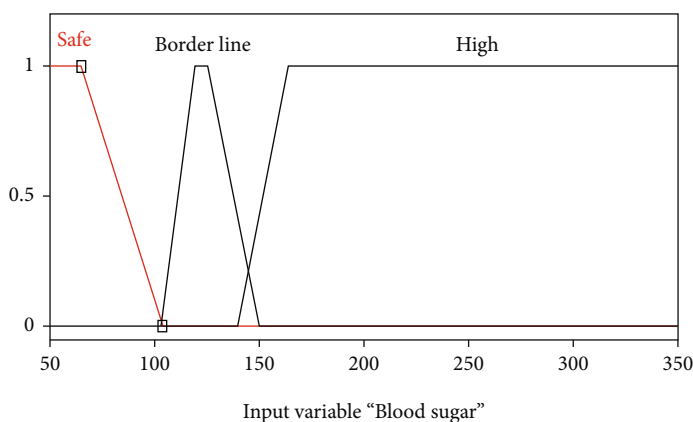

FIGURE 6: Membership function for blood sugar.

a computer-aided diagnosis (CAD) system for the identification of kidney diseases at initial disease. References [9–12] predicted the disease which can be done by utilizing machine learning (ML) approaches. Deep learning, which is central to AI learning, is a computer engineering subject related to the development of algorithms that form the basis for computer learning [13, 14]. Work of [15, 16] compares the performances of various machine learning algorithms, whereas [17, 18] proposed a technique for detecting sickness in the early stages employing MATLAB by running the algorithm utilizing small quantity of learning algorithm and also added knowledge to it. References [19–21] used data mining techniques for the identification of chronic disorder.

Machine learning relies heavily on fully convolution learning methods and systems. The word “network typically” refers to computer-based systems that simulate brain processes for machine learning [22, 23]. Early intervention of the condition allows the doctor to provide the necessary precautions to lessen the chance [24]. In the suggested strategy, the rankings are assigned to all of the risk variables that have a significant impact on the kidneys [25, 26]. Knowledge-based systems, often known as synthetic intelligent beings (AI), are computers that can make decisions like a human expert. Systems are software algorithms that employ knowledge to solve complex problems [27, 28].

Annually, renal illness is a global health concern in the United States and throughout the world. According to the Taiwan Society of Nephrology, there have also been over one lakh individuals with renal disease in the Chinese state of Taiwan, and this number is growing with each day. Furthermore, according to statistics from the United States Renal Data System (USRDS), Taiwan has the highest rate of final kidney morbidity and mortality worldwide [29, 30]. The proper diet plan should also follow to decrease the probability of kidney failure [31]. Renal failure is difficult to diagnose until it has progressed due to its asymptomatic nature, resulting in fewer options for primary prevention [32, 33]. To prevent the disease or to control the progress of kidney failure, one should detect and treat chronic kidney disorder in the recent stages [34]. This issue may be addressed by creating a model reference adaptive intelligent system [35] and an adjustable nervous system feed-forward neural. Fuzzy logic (FL) can make decisions similar to the way as humans do. Fuzzy logic preserve as numerous properties of the classical logic system [36]. Essentially, the skilled service’s fundamental principle is that information from specialists in a certain illness will be transmitted to the computer system [37, 38]. Expert systems are used to diagnose a wide range of illnesses, as well as in other domains [39, 40]. A computerized system’s accumulated information can be used by the

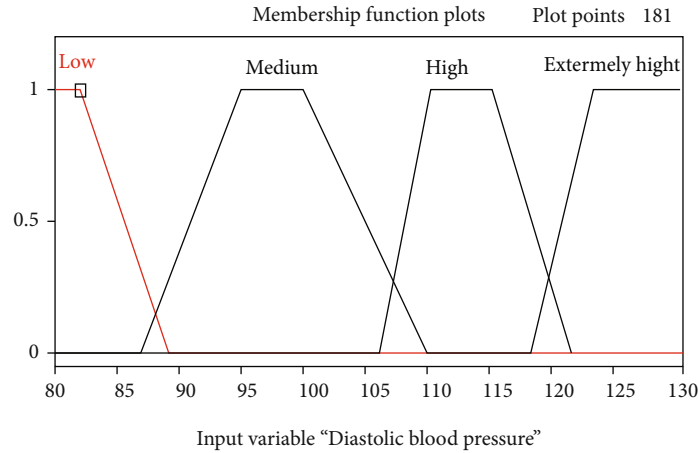

FIGURE 7: Membership function for diastolic blood pressure.

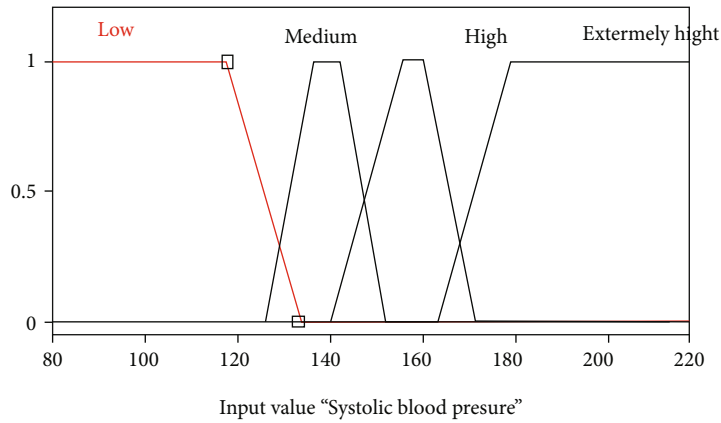

FIGURE 8: Membership function for systolic blood pressure.

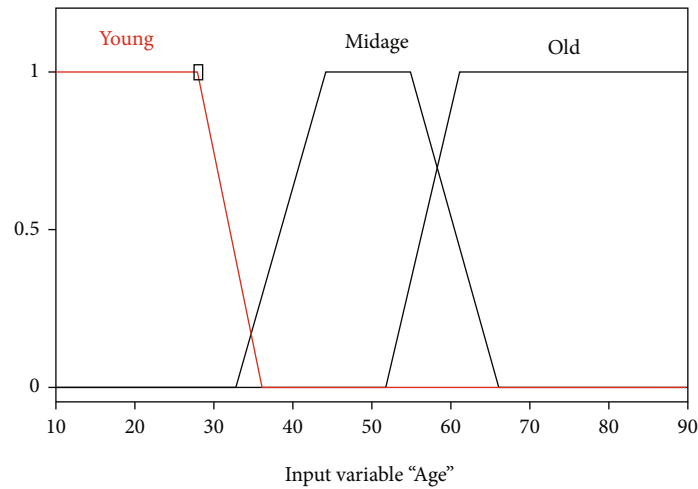

FIGURE 9: Membership function for age.

user for a specific job. Following that, the computer will arrive at a conclusion by doing several assessments. The expert system is computer software designed from intelligent

machines that is best suited for real-time domains or applications [41, 42]. This domain is developed to identify real-world applications in more than 70 percent of cases [43].

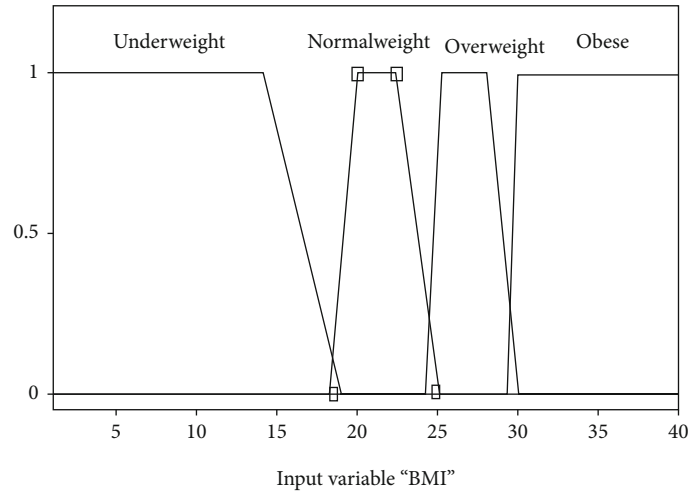

FIGURE 10: Membership function for BMI.

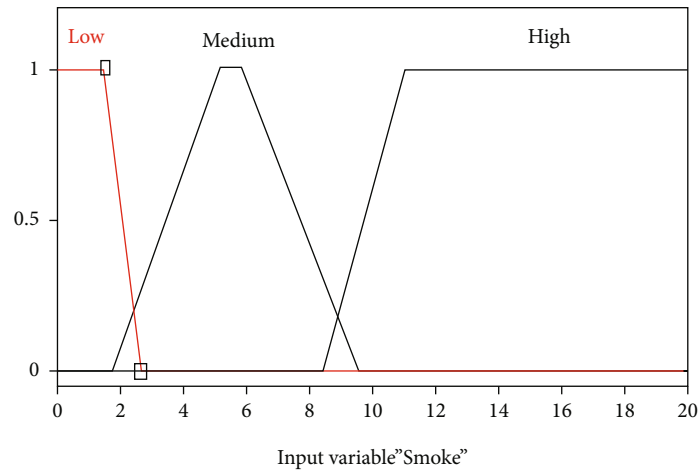

FIGURE 11: Membership function for smoke.

1.1. *Fuzzy Expert System.* The fuzzy logic diagnostic system consists of a set of rules and an activation function. It was likewise skewed toward mathematical computations. It is a development tool that takes numerical output and turns them to fuzzification. This approach is applicable to issues with indeterminate and partial information, as well as when it is hard to ascertain this relevant data in reliable findings. The framework of the fuzzy logic system is demonstrated in Figure 1. There are three phases of fuzzy intelligent systems:

- (i) Fuzzification
- (ii) Implication process
- (iii) Defuzzification

In the fuzzification process, nonfuzzy data are fed into an intelligent system, which transforms or converts them into fuzzy sets or fuzzy values. The expert system, as a fuzzy logic system, will map the instructions based on the pro-

vided input and, after triggering the appropriate rule, will create the output in fuzzy value. The output of the inference method is changed from imprecise to discrete values during defuzzification.

- (i) Crisp sets: the fresh or the traditional data is well defined as the accumulation or set of elements $x \in X$ that can be predictable, for instance, to describe the set if groups are greater than 5. The interpretation of participation function for this instance is provided by

$$X = \{x \mid x > 5\}, \tag{1}$$

where X is the set of positive integers.

- (ii) Fuzzy sets: if X is the collection of instances implied by x , then a fuzzy collection Y in X is the collection of ordered pair and is characterized by

TABLE 1: Input variables of the proposed fuzzy inference system.

Sr. no.	Input parameters	Ranges	Semantic sign
1	Nephron functionality	LT < 0.35	Very risky
		B/W 0.3-0.5	Moderately risky
2	Blood sugar	GT > 0.47	Safe zone
		LT < 104	Safe
		B/W 104-150	Borderline
3	Diastolic blood pressure	GT > 140	High
		LT < 89	Low
		B/W 87-111	Medium
		B/W 106-121	High
4	Systolic blood pressure	GT > 118	Extremely high
		LT < 134	Low
		B/W 127-153	Medium
		B/W 142-172	High
		GT > 162	Extremely high
5	Age	LT < 36	Young
		B/W 33-66	Middle-aged
		GT > 52	Old
6	BMI	LT < 19	Underweight
		B/W 18.5-24.9	Normal weight
		B/W 24.6-30	Overweight
		GT > 29.5	Obese
7	Smoke	LT < 2.64	Low
		B/W 1.8-9.5	Medium
		GT > 8.5	High

LT = less than; GT = greater than; B/W = between.

$$Y = \{(x, \mu_Y(x))/x \in X\}, \quad (2)$$

where $\mu_Y(x)$ is the membership function of x in Y .

1.2. Adaptive Neuro-Fuzzy Inference System. The fuzzy rule-based system is ideal for clinical uses; however, after a while, the model predictive control is no longer suited for sophisticated and computational tasks. This occurs because similarity measure and principles of the inference engine might get quite fatigued at times. The need for a binary classifier in an optimization algorithm is then revealed. As a response, the machine learning algorithm is used to answer this requirement by supplying an active learning, and the computation diminishes for the interpretation engine's deficiencies.

As a result, the fusion system was created to tackle issues that could not be solved with the fuzzy reasoning method. An ANFIS is a pattern of two soft computing methodologies: neural networks and fuzzy reasoning systems. The characteristics of ML learning and a fuzzy inference system are combined to create a hybrid system. The ANFIS includes five layers, as illustrated in Figure 2, and is suited for a variety of information disciplines including data categorization, decision-making, data processing, and

pattern recognition. It is also utilized in the healthcare process to heal illness in humans with improved outcomes than neural networks, fuzzy inference systems, and fuzzy expert systems.

The five layers of adaptive neuro-fuzzy inference system are explained below.

1.2.1. Layer 1: Fuzzification Layer. In layer 1, all input variables are fuzzified. The membership functions are provided inputs in the form of crisp values. In other words, all nodes in this layer are members of the membership function.

1.2.2. Layer 2: Rule Layer. The rule layer is the second layer of ANFIS. This layer is denoted by the algebraic product symbol ". This layer determines the strength of the rule that will be fired in response to the system's inputs.

1.2.3. Layer 3: Normalization Layer. Each node in this tier is a fixed node. This layer is denoted by the designation "N." This layer is known as the normalization layer because it describes the normalization occupation to the strength of firing the rule in layer 2. In other words, this layer calculates the weights which are normalized in nature.

1.2.4. Layer 4: Defuzzification Layer. Layer 4, also known as the defuzzification layer, contains numerous linear functions for each input signal. Each node of this layer is an adaptive node.

1.2.5. Layer 5: Summation Layer. Summation layer is the last layer of ANFIS, represented by the label " Σ ." The main task of this layer is to sum up all the signals from the previous layer and after that computes the overall or final output.

2. Related Work

Pujari and Hajare [7] presented the examination of various stages of chronic kidney disease. This inspection has been done by using the ultrasonography pictures of the kidney region. The image processing techniques have been used to identify the fibrosis condition of tissues of the kidney of the patient. The constructed framework will take the record of these conditions, and according to noted conditions, the final outcome or decision will be the stages of the chronic kidney disease. Wibawa et al. [10] used the different classifier methods of machine learning for the feature selection. To enhance these features and for feature choices, the ensemble learning has been used. The classifiers are merged together to increase the efficiency and accuracy. The combination of k -nearest neighbour classifier with CFS and AdaBoost gave the best accuracy rate and precision rate as compared to rest of the combinations of classifiers. Dulhare [11] developed a method to detect the stage of chronic kidney disease by using naïve Bayes. The principles collected in this manner correlate to the stage of chronic renal illness. The glomerular filtration rate (GFR) was measured in order to determine the accurate and appropriate phase of kidney impairment in the patient. The OneR method was employed with naïve Bayes. Avci and Extraction examined the classification techniques used in data analysis for the identification of renal

IF... symptom 1 AND symptom 2... THEN.....output. Example of rule no. 1 stored in inference engine:
If nephron functionality is reasonably dangerous,
And blood sugar is severe,
And blood pressure diastolic is severe,
And blood pressure is severe,
And age is average age,
And BMI is malnourished,
And smoking is moderate,
THEN the patient’s renal situation is very affecting.
 Example of rule no. 81 stored in inference engine:
IF nephron functionality is extremely uncertain,
And blood sugar is severe,
And blood pressure diastolic is exceptionally severe,
And blood pressure is exceptionally severe,
And age is older,
And BMI is overweight,
And smoke is severe,
THEN patient’s kidney is exceedingly ill.

ALGORITHM 1

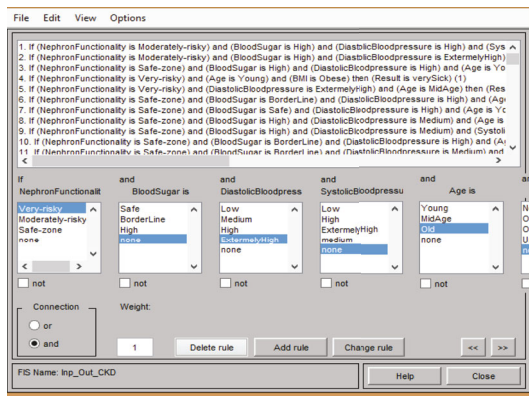

FIGURE 12: I/O rules for the proposed expert system.

disease in order to inhibit the patient role from continuing to the next stage of chronic kidney disease. The naive Bayes, K-star, support vector machine (SVM), and J48 classifiers were compared. These classifications’ performance was compared using several characteristics such as reliability, specificity, responsiveness, and *F*-measure. The information was gathered using WEKA application, and the decision tree approach was shown to be the best classification technique among all of them, with 99 percent efficiency. Kunwar et al. [19] employed a two-classification approach for predicting chronic renal disease. These two classification techniques are naive Bayes and multilayer perceptron (ANN). The outcomes between both techniques were examined to see which method produced the significantly better results. The findings have been integrated in the popular open source utility. According the RapidMiner tool’s outcomes, the naive Bayes delivered more accurate and better health outcomes than the artificial neural network. Bondor et al. [25] proposed a method for ranking the risk variables for chronic renal disease. The TOPSIS approach was used to analyze diabetic patients’ data, which was then contrasted to those other causes of chronic kidney disease. All of the

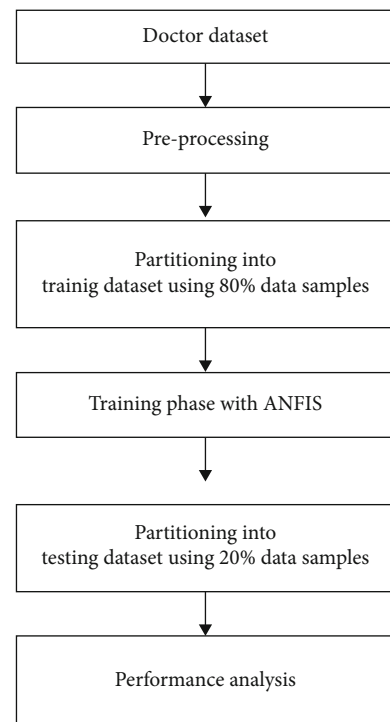

FIGURE 13: Methodology of adaptive neuro-fuzzy system.

factors for chronic kidney disease were ordered in sequence after assessment. This improved method produced more accurate and reliable findings when ranking the various risks of chronic renal disease. Shen et al. [29] created a small-budget technique for dialysis patient role. This approach is used to assess the risk of cardiac illness in chronic renal disease patients (CKD). This was accomplished through the use of a patient’s ECG characteristics and rate variability. For texture analysis, it employs a decision-based neural network architecture. The total exactness of the improved procedure

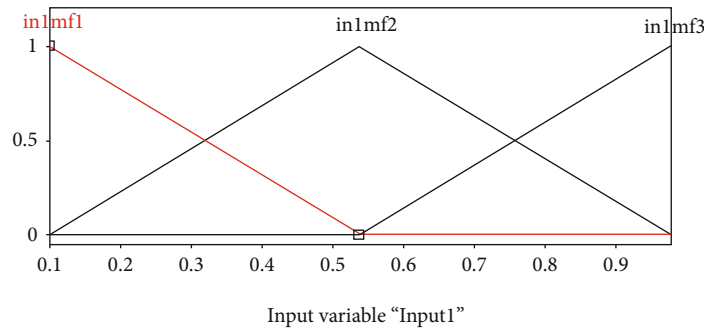

FIGURE 14: Membership function for input 1, i.e., nephron functionality.

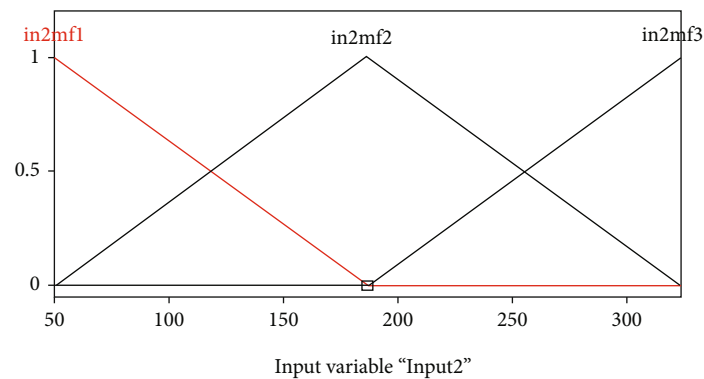

FIGURE 15: Membership function for input 2, i.e., blood sugar.

for cardiac illness on chronic kidney failure is 70.77%. Roventă and Roșu [41] created a health expert approach that can identify 27 distinct renal disorders from 9 various kinds. The diagnosis of kidney illness is prepared by taking the symptoms detected in a clinical exam and comparing them to the results of a laboratory experiment. The system was designed with Prolog 5.2 software and assists the physician in much more precisely diagnosing the ailment.

Khade et al. [44] summarises the several researches carried out by various scientists in the topic of predicting the occurrence of CKD utilizing AI approaches. Furthermore, all of the works have been divided into three categories, and it is undertaken to examine the finest suggestions in each of those areas. Al-Kasasbeh et al. [45] demonstrate significant lipid peroxidation and antioxidant activities. The study forecasts the development of issues, and doctors can outline screening and management by integrating physiology with antioxidant and detoxification therapy.

3. Material and Method

The fuzzy medical intelligent system for the discovery of chronic kidney disease is intended by utilizing the procedure given in Figure 3. There is a very important practical use of this system for the society. This system can be used in hospitals for the diagnosis of chronic kidney diseases. It can act as supporting tool for doctors. Using this fuzzy intelligent system, 80 experiments were run to assess chronic kidney dysfunction. Every patient was also evaluated and given

a result by the group of physicians. Following that, the results' expert opinion was compared to the results acquired from the fuzzy inference system. By connecting the two findings, 75 out of 80 experiments were appropriately categorized, resulting in 5 anomalies in the system's output.

The dataset for the diagnosis of chronic kidney disease is taken with the help of doctors from various hospitals. All the membership functions and rules are generated with the help of experts from the hospitals.

Step 1. Collect risk factors for chronic kidney or renal disease and utilize them as crisp values as input variables for the system.

Step 2. The fuzzifier converts these input variables to fuzzy values from their crisp values.

Step 3. The fuzzy input set will be sent to the inference system, which will store the information in knowledge base. The inference will map the rules according to the given input to conclude the output.

Step 4. The fuzzy output set will be converted into again the crisp output set by the defuzzifier.

Step 5. The crisp value of output will help in the detection of chronic kidney or renal disease.

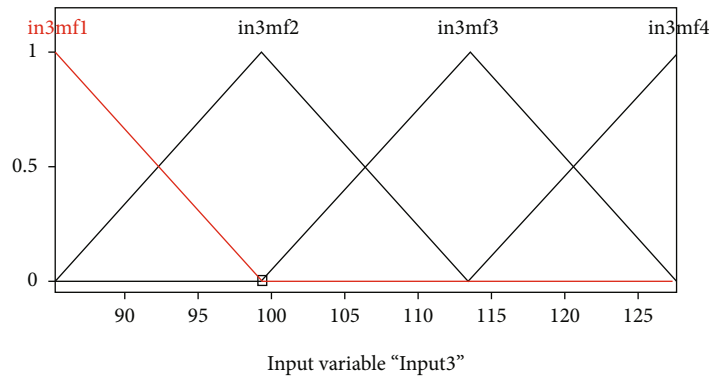

FIGURE 16: Membership function for input 3, i.e., diastolic blood pressure.

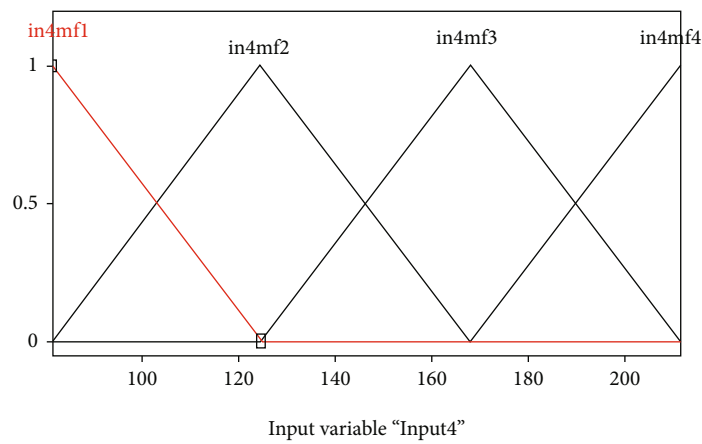

FIGURE 17: Membership function for input 4, i.e., systolic blood pressure.

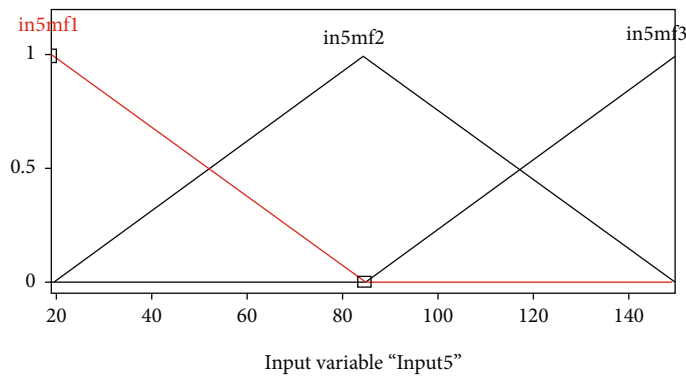

FIGURE 18: Membership function for input 5, i.e., age.

The input factors for this medical diagnostic method are nephron functioning, diastolic blood pressure, blood sugar, age, weight and height (BMI), and smoking. The output variable for the same is stages of chronic kidney disease. The expert system has one layer. This layer detects the stage of chronic kidney disease on the seven input variables as shown in Figure 4.

The seven (7) input features have been used for the development of fuzzy inference or expert system. The different varieties are studied for all the input variable quantity as explained below.

Nephron functionality (NF): the fraction of activated nephrons in the kidney is referred to as nephron functioning. If the result is larger than 0.47, the glomerular

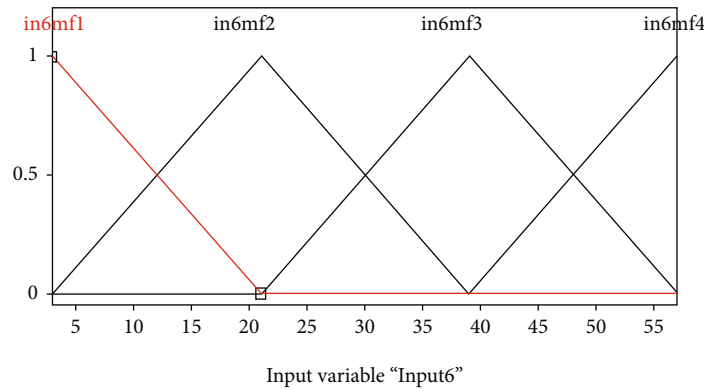

FIGURE 19: Membership function for input 6, i.e., body mass index (BMI).

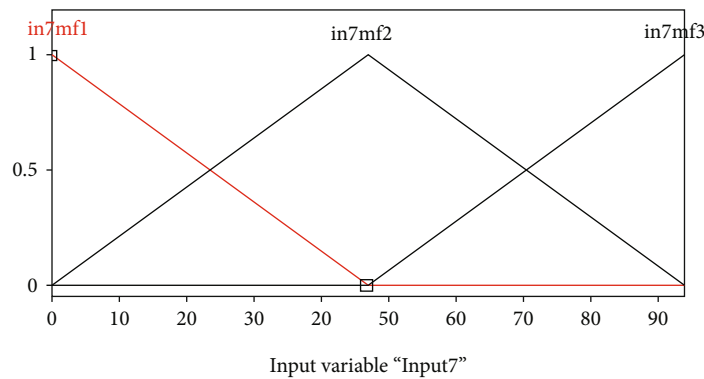

FIGURE 20: Membership function for input 7, i.e., smoke.

```

1. If (input1 is in1mf1) and (input2 is in2mf1) and (input3 is in3mf1) and (input4 is in4mf1) and (input5 is in5mf1) and (input6 is in6mf1) and (input7 is in7mf1)
2. If (input1 is in1mf1) and (input2 is in2mf1) and (input3 is in3mf1) and (input4 is in4mf1) and (input5 is in5mf1) and (input6 is in6mf1) and (input7 is in7mf2)
3. If (input1 is in1mf1) and (input2 is in2mf1) and (input3 is in3mf1) and (input4 is in4mf1) and (input5 is in5mf1) and (input6 is in6mf1) and (input7 is in7mf3)
4. If (input1 is in1mf1) and (input2 is in2mf1) and (input3 is in3mf1) and (input4 is in4mf1) and (input5 is in5mf1) and (input6 is in6mf2) and (input7 is in7mf1)
5. If (input1 is in1mf1) and (input2 is in2mf1) and (input3 is in3mf1) and (input4 is in4mf1) and (input5 is in5mf1) and (input6 is in6mf2) and (input7 is in7mf2)
6. If (input1 is in1mf1) and (input2 is in2mf1) and (input3 is in3mf1) and (input4 is in4mf1) and (input5 is in5mf1) and (input6 is in6mf2) and (input7 is in7mf3)
7. If (input1 is in1mf1) and (input2 is in2mf1) and (input3 is in3mf1) and (input4 is in4mf1) and (input5 is in5mf1) and (input6 is in6mf2) and (input7 is in7mf1)
8. If (input1 is in1mf1) and (input2 is in2mf1) and (input3 is in3mf1) and (input4 is in4mf1) and (input5 is in5mf1) and (input6 is in6mf2) and (input7 is in7mf2)
9. If (input1 is in1mf1) and (input2 is in2mf1) and (input3 is in3mf1) and (input4 is in4mf1) and (input5 is in5mf1) and (input6 is in6mf2) and (input7 is in7mf3)
10. If (input1 is in1mf1) and (input2 is in2mf1) and (input3 is in3mf1) and (input4 is in4mf1) and (input5 is in5mf1) and (input6 is in6mf4) and (input7 is in7mf1)
11. If (input1 is in1mf1) and (input2 is in2mf1) and (input3 is in3mf1) and (input4 is in4mf1) and (input5 is in5mf1) and (input6 is in6mf4) and (input7 is in7mf2)
12. If (input1 is in1mf1) and (input2 is in2mf1) and (input3 is in3mf1) and (input4 is in4mf1) and (input5 is in5mf1) and (input6 is in6mf4) and (input7 is in7mf3)
13. If (input1 is in1mf1) and (input2 is in2mf1) and (input3 is in3mf1) and (input4 is in4mf1) and (input5 is in5mf2) and (input6 is in6mf1) and (input7 is in7mf1)
14. If (input1 is in1mf1) and (input2 is in2mf1) and (input3 is in3mf1) and (input4 is in4mf1) and (input5 is in5mf2) and (input6 is in6mf1) and (input7 is in7mf2)
15. If (input1 is in1mf1) and (input2 is in2mf1) and (input3 is in3mf1) and (input4 is in4mf1) and (input5 is in5mf2) and (input6 is in6mf1) and (input7 is in7mf3)
    
```

FIGURE 21: Rules generated by ANFIS.

functioning is in the buffer environment. Nevertheless, if the level is about 0.3 as well as 0.5, the feature is somewhat dangerous, and it is extremely unsafe if it is less than 0.35. The membership function of nephron functionality is demonstrated in Figure 5.

Blood sugar (BS): the quantity of glucose levels is referred to as sugar levels. It is made up of 3 fuzzy groups. If the concentration in the glucose is less than 104, it is acceptable; if it is between 104 and 150, it is intermediate; and if it is higher than 140, the presence of glucose in the blood is excessive. The classifier of glucose levels is depicted in Figure 6.

Diastolic blood pressure: the role of diastolic blood pressure is to fill the heart to pump blood among muscle convulsions. It is made up of four fuzzy sets. Blood pressure is

lower if the variation is little below 89. If the variety is between 87 and 110, it is considered moderate, and if it is among 106 and 121, it is rated severe. However, if the fury is greater than 118, the blood pressure is unusually very severe. Figure 7 depicts the systole blood pressure membership degree.

Systolic blood pressure (SBP): the systolic blood pressure is produced as the contraction of the heart. It is unusually the maximum capillary pressure during intraventricular shrinking in the heart. Systolic pressure is the moment when ventricular contraction happens. If the systolic pressure variety is lower than 134, it is considered lower; if the range is around 127 and 153, it is considered moderate; if it is between 142 and 172, it is rated severe; and if it is greater than 162, it is considered especially very severe. Figure 8 depicts the systolic and diastolic blood level classifier.

Age: age has a nasty effect on the participants' kidney. It has three parameters. If the patient is now under the age of 36, he or she is regarded juvenile; if the patient is between the ages of 33 and 66, the patient is called middle-aged; and if the patient is above the age of 52, the patient is deemed elderly. Figure 9 depicts the age degree of membership.

BMI: the body mass index (BMI) is computed by dividing a person's weight by their height. It consists of four parameters. The BMI is slightly malnourished if it is less

TABLE 2: CKD confusion matrix.

Extremely sick	Very sick	Sick	Very concerning	Concerning	Healthy	Class names
13	00	00	01	00	00	Extremely sick
00	14	00	00	00	00	Very sick
00	00	10	00	00	01	Sick
00	00	01	15	00	00	Very concerning
00	02	00	00	08	00	Concerning
00	00	00	00	00	15	Healthy

TABLE 3: Reduced dimensionality matrix.

Yes	No	Class name
37	02	Yes
03	38	No

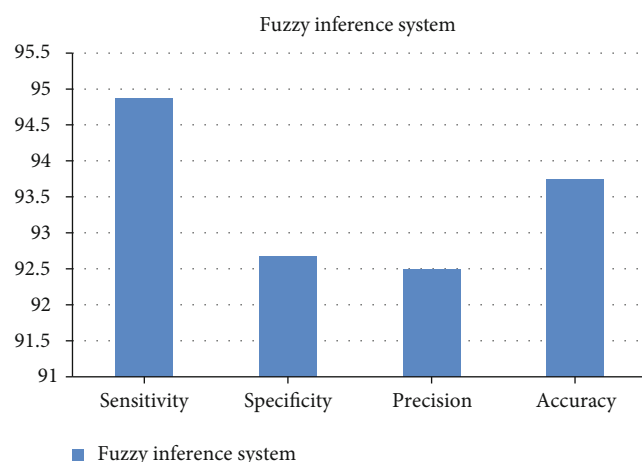

FIGURE 22: Graphical representation of calculated parameters for fuzzy expert system.

than 19, average weight if it is among 18.5 and 24.9, weighty if it is among 24.6 and 30, and unhealthy if it is 29.5 or above. Figure 10 displays the BMI classifier.

Smoke: smoking also has an effect on the kidney. It has three fuzzy set theories. It is minimal if indeed the spread is much less than 2.64, moderate if the spread is around 1.8 and 9.5, and severe if the spread is greater than 9.5. Smoke’s classifier is seen in Figure 11.

The values for these input variables used in the proposed medical expert system can be represented in tabular form as revealed in Table 1.

3.1. Knowledge Base for Fuzzy Inference System. The set of rules is used to link the model parameters to the consequent categorization. The level of expertise is where these fuzzy rules are created. The rules contained in the inference engine carry out their jobs in an IF-THEN fashion. The Mamdani inference rule-based model is applied in this approach, and the principles are written as follows.

The input-output rules are crucial in the fuzzy inference system. The effectiveness or throughput of a designed meth-

odology is immediately related to the amount of input/and output rules created and accumulated in the professional method’s concentration of knowledge. Figure 12 depicts the knowledge base infrastructure in which the rules are kept.

The suggested model has seven variables, resulting in 5184 rules, yet it is challenging to manage such a large number of rules. As a result, 83 rules are employed in this study. While each of these principles has a likelihood of occurrence, there are no omissions. The attributes are designed in such a manner whereby pattern commonality is eliminated, as well as the reliance of one parameter on another, so that the inference process is not affected. The regulations are also amended to identify inconsistencies, although the study yielded favourable results. The above-mentioned seven input variables are combined, and the result is established using the benchmark rules.

$$\begin{aligned}
 \text{IRT} &= \text{Nephron Functionality}(3) \times \text{Blood Sugar}(3) \\
 &\times \text{Diastolic Blood Pressure}(4) \times \text{Systolic Blood Pressure}(4) \\
 &\times \text{Age}(3) \times \text{BMI}(4) \times \text{Smoke}(3) = 5,184 \text{ inference rules,} \\
 &\tag{3}
 \end{aligned}$$

where IRT is the inference rules’ total.

MATLAB is used for the defuzzification process, it calculates the output by using centroid method in which the centre of gravity of an image is evaluated, and this outcome is prompted at that time at which the linguistic variable of all the inputs has been breakdown. It also enumerated the surface areas of the outcome in the form of an image. The outcome of a rectangle according to the centroid method is the middle of the rectangle’s base. Similarly, for the areas in the form of triangles, the position considered as output is at the third part of the triangle’s base and it is corresponding to the angle inaugurated by base and the triangle’s hypotenuse. Subsequently, the value of the output by using centroid method has been determined. To acquire the value of variable, the sum of surface product is divided by the centroid multiplied by the total surface.

Figure 13 shows the methodology that will be used in the development of neuro-fuzzy intelligent system for the diagnosis of chronic kidney disease.

The various steps involved in the development of adaptive neuro-fuzzy inference system are as follows.

TABLE 4: Performance of developed medical diagnostic system.

Sr. no.	Disease	Model	Membership function	Sensitivity (%)	Specificity (%)	Precision (%)	Accuracy (%)
1	Chronic kidney disease	Adaptive neuro-fuzzy inference system	Triangular	94	98	97.1	96

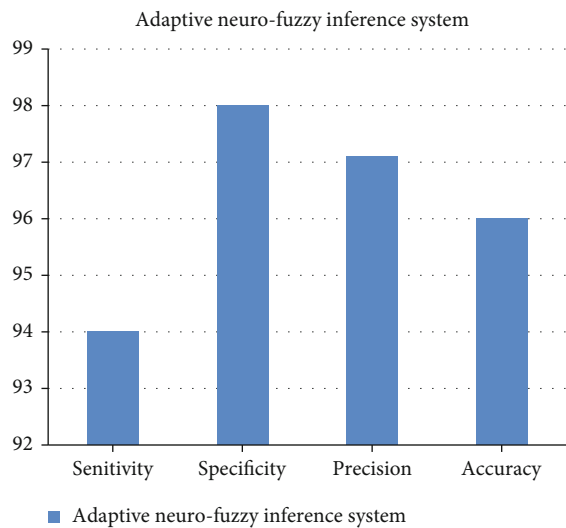

FIGURE 23: Graphical representation of calculated parameters for adaptive neuro-fuzzy expert system.

Step 1. Collect the dataset of various patients of chronic kidney disease from the expertise or specialist doctor of nephrology.

Step 2. After acquiring the dataset, preprocessing of the dataset will be done such as normalization of dataset.

Step 3. Now, do the partitioning process. In this, divide the dataset into the training set. Let us take 80% of data samples from the dataset for the training phase of medical intelligent system.

Step 4. By using the training data, train the medical diagnostic system during the training phase for the detection of chronic kidney or renal disease.

Step 5. Similarly, the rest of the data samples of dataset of chronic kidney or renal disease will be used as testing data, i.e., 20% of the dataset will be used to test the medical diagnostic system during the testing phase.

Step 6. At this step, calculate the effectiveness of a newly designed healthcare sophisticated clinical diagnosis for progressive kidney illness by using various parameters like sensitivity, specificity, and accuracy.

3.2. *Membership Functions of Input Variables Used in Adaptive Neuro-Fuzzy Inference System.* For each input parameter, the triangle membership function is used. In inputs 1, 2, 5, and 7, each of which contains three triangle membership functions. Consequently, inputs 3, 4, and 6

each have four triangular membership functions. For example, it has been separated into three categories for input variable nephron functioning. These three categories are extremely dangerous, somewhat risky, and protected. These categories were constructed dynamically from the learning data collection. Each group will be transformed into membership functions for input 1, which is nephron functionality. Consequently, for each input parameter, there are fundamental features depending on the ranges received from the information set of labeled training trials during the training stage dynamically.

Figures 14–20 depict the membership function parameters for input 1, input 2, input 3, input 4, input 5, input 6, and input 7, in that order. When the adaptive neuro-fuzzy inference system (ANFIS) is employed, it generates all of the principles and similarity measure of the dependent and independent variables. These policies and association functions are not explicitly established; they are developed dynamically during the ANFIS learning stage by using the classification model.

3.3. *Knowledge Base (IF-THEN Rule Formulation).* The creation of principles in an adaptive neuro-fuzzy inference system is accomplished by considering all feasible membership function combinations for each input variable. The established ANFIS has 5184 rules for diagnosing chronic renal disease. Figure 21 illustrates some of the principles.

Estimated no.of regulations = association function of first input * association function of second input * association function of third input * association function of fourth input * association function of fifth input * association function of sixth input * association function of seventh input.

Therefore, total number of rules = 3 * 3 * 4 * 4 * 3 * 4 * 3 = 5184.

4. Results and Discussion

Using a built fuzzy intelligent system, 80 experiments were run to assess chronic kidney dysfunction. Every patient was also evaluated and given a result by the group of physicians. Following that, the results’ expert opinion was compared to the results acquired from the fuzzy inference system. By connecting the two findings, 75 out of 80 experiments were appropriately categorized, resulting in 5 anomalies in the system’s output.

The confusion matrix is provided in Table 2. 80 instances of various patients are carried out. The first column contains 15 examples of healthy individuals, all of whom are classed as belonging to the right class, i.e., the normal category. In column 2, the information of 10 patient’s

role at the worrisome threshold is evaluated; however, as a consequence, eight of the ten cases are classed as troubling, while the remaining two are labeled as unwell. Correspondingly, in column 3, 16 instances of extremely serious worry are carried out, and 15 among those 16 patients are accurately identified, while one is characterized as unwell. In the fourth column, one of the eleven patients with a diagnosis is categorized wrongly, while the other ten are accurate. Similarly, the fifth column indicates that the 14 diagnosed patients' role of class extremely sick is recognized correctly. Finally, the sixth column reveals that there are 14 examples of a critically ill patient, but one of them is obese and overweight.

$$\text{Confidence indicator} = \left(\frac{\text{Success number}}{\text{Total number of tests}} * 100 \right). \quad (4)$$

Here, total number of tests = 80 and number of successes = 75.

By analyzing the reliability indicator using the aforementioned approach, it was established that 93.75 percent of the fuzzy inference system's findings are correctly classified. As a consequence of monitoring the confidence indicator, the developed fuzzy expert system may be used in conjunction with doctors to aid in the diagnosis of chronic renal failure.

The results reveal that the fuzzy reasoning algorithm incorrectly classified chronic renal failure at a rate of 06.25 percent. The first three categories, which are deemed normal, concerning, and very concerning, are now considered "no." As a result, the rest of the groups classified as unwell, extremely ill, or seriously ill are understood as affirmative. As a consequence, the data distribution is reduced to a 2×2 matrix, as shown in Table 3.

The created expert medical system's efficiency is calculated by taking into account numerous factors such as correctness, specificity, sensitivity, and responsiveness.

In case of chronic kidney disease, from Table 3, TN (true negative) is 38, FP (false positive) is 03, FN (false negative) is 02, and TP (true positive) is 37.

$$\text{Sensitivity} = \frac{(TP)}{(TP + FN)} = \frac{37}{37 + 02} = 94.87\%, \quad (5)$$

$$\text{Specificity} = \frac{(TN)}{(TN + FP)} = \frac{38}{38 + 03} = 92.68\%, \quad (6)$$

$$\text{Precision} = \frac{(TP)}{(TP + FP)} = \frac{37}{37 + 03} = 92.5\%, \quad (7)$$

$$\begin{aligned} \text{Classification Accuracy} &= \frac{(TP + TN)}{(TP + FP + TN + FN)} \\ &= \frac{37 + 38}{37 + 03 + 38 + 02} = 93.75\%. \end{aligned} \quad (8)$$

Figure 22 depicts these estimated parameters in the form of a graph.

Following the assessment of the adaptable neuro-fuzzy intelligence system's result, experienced specialists analyze the performance of the adaptive neuro-fuzzy intelligent system for diagnosing chronic renal diseases with the goal parameters. Following that, it is discovered that the outcome delivered by ANFIS for the analysis of renal disease is very comparable to the conclusion that was made by medical experts or specialists relating to the given input or clinical signs of an individual experiencing the horrible disease referred to as chronic kidney disease. Table 4 reflects the effectiveness of a medical diagnostic system employing ANFIS algorithms. And estimated parameters are represented in a graph in Figure 23.

5. Conclusion and Future Scope

These clinical imaging systems for severe kidney illness or renal disease make use of a fuzzy and adaptive neural fuzzy intelligent system. These techniques can assist both professionals and novices in detecting various phases of chronic renal disease. This recommended technique can be utilized as a tool to assist physicians in keeping their patients healthy. The performance of medical diagnostic systems is estimated by considering a number of factors such as sensitivity, specificity, and accuracy. The computation results in the conclusion that the fuzzy inference system is more effective than the legacy infrastructure. The simulation tool is used to carry out this investigation. The suggested approach can be utilized in hospitals to diagnose a patient's stage of chronic kidney disease or renal disease. This sort of decision-making method is extremely advantageous for emerging economies, as the fatality rate from these serious diseases is quickly growing. It is suggested here that adaptable neural fuzzy algorithms produce superior outcomes than fuzzy intelligent machines.

Clinical investigations and researchers will find prospective and more dangerous variables that affect an individual's glomerular filtration rate in the future, as well as additional metrics for identifying the stage of kidney failure so that a patient's valuable life can be saved from these types of dangerous diseases by detecting them in their early or beginning stages.

Data Availability

The data will be made available on request from the corresponding author.

Conflicts of Interest

The authors declare that there is no conflict of interest regarding the publication of this paper.

References

- [1] S. O. Mezan, S. M. Al Absi, A. H. Jabbar, M. S. Roslan, and M. A. Agam, "Synthesis and characterization of enhanced silica nanoparticle (SiO₂) prepared from rice husk ash immobilized of 3-(chloropropyl) triethoxysilane," *Materials Today: Proceedings*, vol. 42, pp. 2464–2468, 2021.

- [2] M. N. Kumar, V. Jagota, and M. Shabaz, "Retrospection of the optimization model for designing the power train of a formula student race car," *Scientific Programming*, vol. 2021, 9 pages, 2021.
- [3] S. Varughese and G. Abraham, "Chronic kidney disease in India a clarion call for change," *Clinical Journal of the American Society of Nephrology*, vol. 13, no. 5, pp. 802–804, 2018.
- [4] Y. Kubota, Y. Mitsukura, M. Fukumi, N. Akarnatsu, and M. Yasutomo, "Automatic extraction of a kidney region by using the q-learning," *In the Proceedings of International Symposium on Intelligent Signal Processing and Communication Systems, 2004*, pp. 536–540, ISPACS 2004, 2004.
- [5] K. Bommana Raja and M. Madheswaran, "Determination of kidney area independent unconstrained features for automated diagnosis and classification," *In the Proceedings of International Conference on Intelligent and Advanced Systems*, pp. 724–729, ICIAS 2007, 2007.
- [6] F. Iqbal, A. S. Pallewatte, and J. P. Wansapura, "Texture analysis of ultrasound images of chronic kidney disease," *In the Proceedings of International Conference on Advances in ICT for Emerging Regions, ICTer 2017- Proceedings*, vol. 2018, pp. 299–303, Janua, 2018.
- [7] R. M. Pujari and M. V. D. Hajare, *Analysis of ultrasound images for identification of chronic kidney*, In the Proceedings of First International Conference on Networks and Soft Computing, 2014.
- [8] M. Ahmad, V. Tundjungsari, D. Widiyanti, P. Amalia, and U. A. Rachmawati, *Diagnostic decision support system of chronic kidney disease using support vector machine*, In the Proceedings of Second International Conference on Informatics and Computing (ICIC), 2017.
- [9] A. Charleonnann, T. Fufaung, T. Niyomwong, W. Chokchueypattanakit, S. Suwannawach, and N. Ninchawee, "Predictive analytics for chronic kidney disease using machine learning techniques," *In the Proceedings of Management and Innovation Technology International Conference (MITicon)*, pp. MIT-80–MIT-83, IEEE, 2016.
- [10] M. S. Wibawa, I. M. D. Maysanjaya, and I. M. A. W. Putra, "Boosted classifier and features selection for enhancing chronic kidney disease diagnose," *In the Proceedings of 5th International Conference on Cyber and IT Service Management, CITSM 2017*, IEEE, 2017.
- [11] U. N. Dulhare, "Extraction of action rules for chronic kidney disease using naïve Bayes classifier," in *2016 IEEE International Conference on Computational Intelligence and Computing Research (ICCIC)*, pp. 0–4, Chennai, India, 2016.
- [12] A. Sridharan, S. Kasoji, E. Chang, and P. A. Dayton, "Contrast-enhanced ultrasound (CEUS) in patients with chronic kidney disease (CKD)," in *2017 IEEE International Ultrasonics Symposium (IUS)*, pp. 2–5, Washington, DC, USA, 2017.
- [13] J. Bholra and S. Soni, "Information theory-based defense mechanism against DDOS attacks for WSAN," in *Advances in VLSI, Communication, and Signal Processing*, pp. 667–678, Springer, Singapore, 2021.
- [14] Z. Yan, Y. Yu, and M. Shabaz, "Optimization research on deep learning and temporal segmentation algorithm of video shot in basketball games," *Computational Intelligence and Neuroscience*, vol. 2021, 10 pages, 2021.
- [15] E. Avci and A. D. Extraction, "Performance comparison of some classifiers on chronic kidney disease data," in *2018 6th International Symposium on Digital Forensic and Security (ISDFS, Antalya, Turkey, 2018*.
- [16] T. Adam and U. Hashim, "Designing an artificial neural network model for the prediction of kidney problems symptom through patient's metal behavior for pre-clinical medical diagnostic," in *2012 International Conference on Biomedical Engineering (ICoBE)*, pp. 27–28, Penang, Malaysia, 2012.
- [17] L. Ningshan, "Application of radial basis function neural network to estimate glomerular filtration rate in Chinese patients with chronic kidney disease," in *In the Proceedings of International Conference on Computer Application and System Modeling (ICCASM 2010)*, no. Iccasm, pp. 332–335, Taiyuan, 2010.
- [18] B. Ravindra, N. Sriraam, and M. Geetha, "Chronic kidney disease detection using back propagation neural network classifier," in *In the Proceedings of International Conference on Communication, Computing and Internet of Things (IC3IoT)*, Chennai, India, 2018.
- [19] V. Kunwar, K. Chandel, A. S. Sabitha, and A. Bansal, "Chronic kidney disease analysis using data mining classification," *Cloud System and Big Data Engineering (Confluence)*, In the Proceedings of 6th International Conference, pp. 300–305, IEEE, 2016.
- [20] E. Yudaningtyas, D. H. Santjojo, W. Djuriatno, I. Siradjuddin, and M. R. Hidayatullah, "Identification of pulse frequency spectrum of chronic kidney disease patients measured at TCM points using FFT processing," in *In the Proceedings of 15th International Conference on Quality in Research (QiR) : International Symposium on Electrical and Computer Engineering*, pp. 169–172, Nusa Dua, Bali, Indonesia, 2017.
- [21] C. J. Lin, C. Y. Chen, P. C. Wu et al., "Intelligent system to predict intradialytic hypotension in chronic hemodialysis," *Journal of the Formosan Medical Association*, vol. 117, no. 10, pp. 888–893, 2018.
- [22] B. Wang, X. Yao, Y. Jiang, C. Sun, and M. Shabaz, "Design of a real-time monitoring system for smoke and dust in thermal power plants based on improved genetic algorithm," *Journal of Healthcare Engineering*, vol. 2021, 2021.
- [23] A. H. Jabbar, S. O. Mezan, S. M. Al Absi, and M. A. Agam, "Assessment of anticholinesterase effect of polyvinylpyrrolidone/silver nanocomposite biosynthesized by Pandanus atroparpus extract," *Materials Today: Proceedings*, vol. 42, pp. 2578–2583, 2021.
- [24] C. Paper and N. Dey, "Hybrid modified cuckoo search-neural network in chronic kidney disease classification hybrid modified cuckoo search-neural network in chronic kidney disease classification," in *2017 14th International Conference on Engineering of Modern Electric Systems (EMES)*, pp. 164–167, Oradea, Romania, 2017.
- [25] C. I. Bondor, I. M. Kacso, A. R. Lenghel, and A. Muresan, "Hierarchy of risk factors for chronic kidney disease in patients with type 2 diabetes mellitus," in *In the Proceedings of IEEE 8th International Conference on Intelligent Computer Communication and Processing*, pp. 103–106, Cluj-Napoca, Romania, 2012.
- [26] A. Salekin and J. Stankovic, "Detection of chronic kidney disease and selecting important predictive attributes," in *In the Proceedings of IEEE International Conference on Healthcare Informatics, ICHI 2016*, pp. 262–270, Chicago, IL, USA, 2016.
- [27] A. Kumar, V. Jagota, R. Q. Shawl et al., "Wire EDM process parameter optimization for D2 steel," *Materials Today: Proceedings*, vol. 37, pp. 2478–2482, 2021.

- [28] J. Bhola, S. Soni, and J. Kakarla, "A scalable and energy-efficient MAC protocol for sensor and actor networks," *International Journal of Communication Systems*, vol. 32, no. 13, article e4057, 2019.
- [29] B. Rachana, T. Priyanka, K. N. Sahana, T. R. Supritha, B. D. Parameshachari, and R. Sunitha, "Detection of polycystic ovarian syndrome using follicle recognition technique," *Global Transitions Proceedings*, vol. 2, no. 2, pp. 304–308, 2021.
- [30] R. B. Fricks, A. Bobbio, P. Orientale, and K. S. Trivedi, "Reliability models of chronic kidney disease," in *2016 Annual Reliability and Maintainability Symposium (RAMS)*, Tucson, AZ, USA, 2016.
- [31] M. P. N. M. Wickramasinghe, D. M. Perera, and K. A. D. C. P. Kahandawaarachchi, "Dietary prediction for patients with chronic kidney disease (CKD) by considering blood potassium level using machine learning algorithms," in *2017 IEEE Life Sciences Conference (LSC)*, pp. 300–303, 2017.
- [32] A. Batra, U. Batra, and V. Singh, "A review to predictive methodology to diagnose chronic kidney disease," in *2016 3rd International Conference on Computing for Sustainable Global Development (INDIACom)*, New Delhi, India, 2016.
- [33] A. Sobrinho, L. Dias Da Silva, M. E. Pinheiro, P. Cunha, A. Perkusich, and L. Medeiros, "Formal specification of a tool to aid the early diagnosis of the chronic kidney disease," in *In the Proceedings of IEEE Chilean Conference on Electrical, Electronics Engineering, Information and Communication Technologies, Proceedings of IEEE Chilecon 2015*, pp. 173–178, Santiago, Chile, 2016.
- [34] Q. Zhang and D. Rothenbacher, "Prevalence of chronic kidney disease in population-based studies : systematic review," *BMC Public Health*, vol. 8, no. 1, pp. 1–13, 2008.
- [35] P. Subramani and P. BD, *Prediction of muscular paralysis disease based on hybrid feature extraction with machine learning technique for COVID-19 and post-COVID-19 patients*, Personal and ubiquitous computing, 2021.
- [36] V. Novák, "Which logic is the real fuzzy logic?," *Fuzzy Sets and Systems*, vol. 157, no. 5, pp. 635–641, 2006.
- [37] S. Das and P. K. Ghosh, "Hypertension diagnosis : a comparative study using fuzzy expert system and neuro fuzzy system," in *In the Proceedings of International Conference on Fuzzy Systems*, no. 2005, pp. 1–7, Hyderabad, India, 2013.
- [38] I. Fernando, F. Henskens, and M. Cohen, "A domain specific expert system model for diagnostic consultation in psychiatry," in *In the Proceedings of 12th ACIS International Conference on Software Engineering, Artificial Intelligence Networking and Parallel Distributed Computing, SNPDC 2011*, pp. 3–6, Sydney, NSW, Australia, 2011.
- [39] S. Sivathasan, F. Cecelja, and W. Balachandran, "ECG diagnosis using neural network and fuzzy expert system," in *In the Proceedings of 17th IEEE Instrumentation and Measurement Technology Conference [Cat. No. 00CH37066]*, vol. 2, pp. 988–992, 2000.
- [40] I. B. De Medeiros, M. A. Soares Machado, W. J. Damasceno, A. M. Caldeira, R. C. Dos Santos, and J. B. da Silva Filho, "A fuzzy inference system to support medical diagnosis in real time," *Procedia Computer Science*, vol. 122, pp. 167–173, 2017.
- [41] E. Roventă and G. Roşu, "The diagnosis of some kidney diseases in a small Prolog Expert System," in *In the Proceedings of 3rd International Workshop on Soft Computing Applications, SOFA 2009*, , pp. 219–224, 2009.
- [42] S. More and J. Singla, "A generalized deep learning framework for automatic rheumatoid arthritis severity grading," *Journal of Intelligent Fuzzy Systems*, vol. 41, no. 6, pp. 7603–7614, 2021.
- [43] S. More and J. Singla, "Discrete-MultiResUNet: segmentation and feature extraction model for knee MR images," *Journal of Intelligent Fuzzy Systems*, vol. 41, no. 2, pp. 3771–3781, 2021.
- [44] A. A. Khade, A. V. Vidhate, and D. Vidhate, "A comparative analysis of applied AI techniques for an early prediction of chronic kidney disease," in *2021 2nd International Conference on Smart Electronics and Communication (ICOSEC)*, pp. 1386–1392, 2021.
- [45] R. T. Al-Kasasbeh, N. A. Korenevskiy, S. S. Petrovich, C. M. Sergeevna, A. A. Amanzholovna, and M. Y. Ilyash, "Biotechnical system and fuzzy logic models for prediction and prevention of post-traumatic inflammatory complications in patients with blunt renal trauma," *International Journal of Biomedical Engineering and Technology*, vol. 37, no. 4, p. 395, 2021.