



AIAA 96-0777

**Generation of Comprehensive Longitudinal
Aerodynamic data using Dynamic wind
tunnel simulation**

M.S.Rajamurthy
National Aerospace Laboratories
Bangalore, INDIA

**34th Aerospace Sciences
Meeting & Exhibit
January 15-18, 1996 / Reno, NV**

GENERATION OF COMPREHENSIVE LONGITUDINAL AERODYNAMIC DATA USING DYNAMIC WIND TUNNEL SIMULATION

M S.Rajamurthy*

National Aerospace laboratories,
P.O.Box 1779, Bangalore 560 017
INDIA

Abstract

This paper presents a novel method of generating comprehensive Longitudinal aerodynamic data of aircraft using dynamic wind tunnel simulation. The method combines measurement of motion and force responses of aircraft model to control inputs in dynamic wind tunnel simulation. The data generated includes trim **Lift** characteristics, Longitudinal stability derivatives and neutral point. In addition, large amplitude **Lift** and pitching moment responses characterising the unsteady aerodynamic behaviour can **also** be generated.

The method is demonstrated using a generic delta wing aircraft model with one degree of freedom in pitch flown in a low speed dynamic wind tunnel. The model pitch attitude and Lift responses to elevon inputs are measured and used **to** deduce longitudinal aerodynamic data. Comparison of these results with static test **data** and Datcom estimates show good agreement.

Nomenclature

\bar{c}	mean aerodynamic chord, m
h_c	Location of c.g., fraction of \bar{c}
h_n	Location of neutral point, fraction of \bar{c}
I_y	Moment of inertia about pitch axis, Kg·m ²
L	Lift force, N
M	Pitching moment, N-m
q	Body axis pitch rate, deg/sec or rad/sec
\bar{q}	Free stream dynamic pressure, N/m ²
S	Wing reference area, m ²
SM	Static margin, ($h_n - h_c$)
V	Free stream velocity, m/sec
α	Angle of attack, deg or rad

* Scientist, Flight Mechanics & Control Division

Copyright © 19% by M.S.Rajamurthy.
Published by American Institute of Aeronautics
and **Astronautics**, Inc. with permission

δ	Control surface deflection, deg or rad
θ	Pitch attitude, deg or rad
C_L	Lift coefficient, $C_L = L/\bar{q}S$
$C_{L\alpha}$	Lift curve slope, per rad
C_m	Pitching moment coefficient, $C_m = M/\bar{q}S\bar{c}$
$C_{m\alpha}$	Static stability derivative, per rad
$(C_{m_q} + C_{m\dot{\alpha}})$	Pitch Damping derivative, per rad
$C_{m\delta_e}$	Pitch Control derivative, per rad

Abbreviations

ADC	Analog to Digital Conversion
c.g.	Center of gravity
DOF	Degrees of freedom
R/C	Radio controlled

1. Introduction

Study of stability and control characteristics of aircraft is **part** of its design process and includes static **trim**, static stability, dynamic stability and responses. This requires static aerodynamic forces and moments as well as dynamic stability derivative data. While static aerodynamic data is used to determine trim and static stability, dynamic stability derivatives are used **to** study dynamic stability and response characteristics.

During preliminary design, both static aerodynamic and dynamic stability derivative data are estimated using analytical expressions and empirical methods **based** on experimental database'. Once the configuration is frozen, aerodynamic force and moment data is generated from static wind tunnel tests. Dynamic Stability derivatives are obtained from force and moment data on models subjected **to** free or forced oscillations in a wind tunnel using derivative rigs².

Dynamic wind tunnel simulation is an alternative technique for determining stability derivatives³⁻⁸. This technique relies on conducting flight test like experiments in a wind tunnel using dynamically scaled models. The models have rotary and/or translational DOF and are equipped with servo controlled surfaces to excite the model just as in real flight. Miniature incidence, angular rate and acceleration sensors pick up the dynamic response of the model. The model motion responses to specific control inputs are generated and from these measured responses stability derivatives are estimated using parameter estimation techniques.

The measurement of aerodynamic forces on a model in the dynamic wind tunnel simulation for estimating stability derivatives has not been reported in the literature. The combined measurement of aerodynamic force and motion responses significantly enhances the capability of dynamic wind tunnel simulation and comprehensive aerodynamic data can be generated. This paper presents such a dynamic wind tunnel simulation and demonstrates it using a generic delta wing aircraft model with pitch DOF.

2. Novel dynamic wind tunnel simulation

At the Flight Mechanics & Control division of National Aerospace Laboratories, India, dynamic wind tunnel simulation with only rotary DOF has been used to estimate important dynamic stability and damping derivatives^{7,8}. The advantage of having only rotary DOF is the simplicity of the model mount in the form of gimbals and the absence of any cable or heave travel mechanisms. However, with rotary DOF, only moment derivatives can be estimated.

The scope of dynamic wind tunnel simulation with rotary DOF can be enhanced by measuring aerodynamic forces in addition to motion variables. In case of a model with one DOF in pitch, measurement of Lift enables the estimation of Lift derivatives. In dynamic wind tunnel simulation the model is always trimmed at a reference angle of attack. Thus Trimmed Lift data can be obtained directly. Since Lift curve slope C_{L_α} can be estimated at each of the trimmed angle of attack along with static stability C_{m_α} , neutral point can be deduced from a single test.

As the Lift is measured directly large amplitude responses at high angles of attack can be easily generated. While Lift time histories are measured directly pitching moment can be

computed from pitch attitude responses. Conventionally, these responses are generated in large amplitude rigs^{9,11} where the complete model is forced by a drive mechanism to undergo large amplitude excursions in the wind tunnel and the aerodynamic forces and moments acting on the model are measured.

The large amplitude responses generated using dynamic wind tunnel simulation are more realistic for the following reasons:

- i. The model is initially trimmed at a reference angle of attack.
- ii. For a tailless configuration like a delta wing pitch control surface forms an appreciable part of the wing and its deflection influences the wing load distribution.
- iii. The response is generated by moving the control surface.
- iv. As the model is excited aerodynamically using the control surface, aerodynamic lag associated with it is taken care of in the dynamic simulation.

Thus, in a single experimental set-up, comprehensive Longitudinal aerodynamic data in the form of trimmed Lift characteristics, dynamic stability derivatives, neutral point, and large amplitude Lift and pitching moment responses can be generated.

3. Model & Instrumentation

The model chosen for demonstrating the method is a generic delta wing aircraft configuration adopted from a delta wing-body configuration for which extensive static test data is available¹². The wing is a delta planform of aspect ratio 2.31 and a leading edge sweep of 60 deg. Both leading & trailing edges are bevelled. Fuselage is a cylindrical body with Ogive nose. The model has elevons for pitch control. Figure 1 shows the geometrical details of the model. The elevons have a travel of 30 deg. and are driven by a high torque miniature WC servo. The model is fabricated using plywood and Balsa sheet to make it light weight and its pitch inertia representative of the dynamic scaling of a combat aircraft. The reference dimensions and pitch inertia of the model are given in table.1.

A single axis gimbal fixed to the model allows a pitch travel of 0-60 deg. or ±30 deg.

Precision ball bearings are used to minimise gimbals friction. The model is balanced to locate its c.g. at the center of the gimbals axes which is chosen at $0.25\bar{c}$. The model with gimbals is fixed to the vertical strut located at the center of the tunnel test section. Figure 2 shows the model in the wind tunnel.

A precision continuous type conductive plastic potentiometer mounted to the gimbals measures pitch attitude. Lift is measured using a load cell fixed to the vertical support strut (fig. 2). The load cell measures the total force acting along the strut and is designed to minimise the effect of side loads on the measurement. Its output is amplified using a bridge amplifier. During wind OFF and wind ON it measures the model weight and the difference between Lift and model weight respectively. The elevon deflection is measured by the feedback potentiometer in the WC servo. The model input/outputs are acquired on a Personal computer using a 12 bit ADC card at a sampling rate of 80 per second. The Elevon commands are generated on the Personal computer and fed to R/C servo. The sensors are precisely calibrated prior to wind tunnel tests. Pitch rate and pitch acceleration are derived from pitch attitude using numerical differentiation and filtering. The adequacy of pitch attitude measurement was ascertained by measuring pitch rate and pitch acceleration using rate gyro and accelerometer respectively and comparing the same with that derived by numerical differentiation.

4. Dynamic Wind tunnel simulation Tests

Tests are conducted in the Low speed dynamic wind tunnel of Flight Mechanics & Control Division, National aerospace Laboratories. This is an open circuit induced draught type tunnel with 1.2m X 1.2m test section and a variable speed capability of 20-45 m/sec. The present tests are conducted at a dynamic pressure of 245 N/m² corresponding to a tunnel speed of 21.5 m/sec. The test Reynolds number is 0.42×10^6 based on F . The model is trimmed at several angles-of-attack up to 40 deg. In the range 0 to 20 deg., at each trim angle-of-attack model response to an elevon doublet input is acquired. Typical data length is of 12.5 second duration corresponding to 1000 samples. To generate large amplitude responses, the model is trimmed at a reference angle of attack and excited by a step elevon input. This is repeated by varying the amplitude of the elevon step.

Lift is deduced from the load cell output by subtracting wind off tare and C_L is computed by normalising it. The pitching moment

coefficient is computed using the relation

$$C_m = \frac{I_y}{\bar{q} \cdot S \cdot \bar{c}} \cdot \ddot{\theta} \quad (1)$$

5. Analysis and discussion of results

The wind tunnel model with pitch DOF is modelled as a linear time-invariant system whose input is δ_e , θ and q are the states, and \dot{q} , q , θ and C_L are the measurements. In these experiments θ is same as α .

The state space equations are given by

$$\begin{bmatrix} \dot{q} \\ \dot{\theta} \end{bmatrix} = \begin{bmatrix} (M_q + M_{\dot{\alpha}}) & M_{\alpha} \\ 1 & 0 \end{bmatrix} \begin{bmatrix} q \\ \theta \end{bmatrix} + \begin{bmatrix} M_{\delta_e} \\ 0 \end{bmatrix} \delta_e \quad (2)$$

$$\begin{bmatrix} \dot{q} \\ q \\ \theta \\ C_L \end{bmatrix} = \begin{bmatrix} (M_q + M_{\dot{\alpha}}) & M_{\alpha} \\ 1 & 0 \\ 0 & 1 \\ C_{L_q} \cdot \bar{c}/2V & C_{L_{\alpha}} \end{bmatrix} \begin{bmatrix} q \\ \theta \end{bmatrix} + \begin{bmatrix} M_{\delta_e} \\ 0 \\ 0 \\ C_{L_{\delta_e}} \end{bmatrix} \delta_e \quad (3)$$

$$\text{where } M_{\alpha} = \frac{C_{m_{\alpha}} \cdot \bar{q} \cdot S \cdot \bar{c}}{I_y}$$

$$(M_q + M_{\dot{\alpha}}) = \frac{(C_{m_q} + C_{m_{\dot{\alpha}}}) \cdot \bar{q} \cdot S \cdot \bar{c}}{I_y \cdot 2V}$$

$$M_{\delta_e} = \frac{C_{m_{\delta_e}} \cdot \bar{q} \cdot S \cdot \bar{c}}{I_y} \quad (4)$$

Figure 3 shows the plot of trimmed Lift coefficient obtained from experiments as a function of angle of attack. Superimposed on this is the Lift coefficient data for the wing-body¹². Due to Elevon deflection for trim, trimmed Lift is less than the Wing-body Lift. The angle of attack for maximum Lift is a round the same as that for the wing-body. Figure 4 shows a typical response of the model to an elevon doublet input. Pitch rate and pitch acceleration shown are derived from pitch attitude measurement by numerical differentiation and filtering.

The parameters of the state space model are estimated using Maximum-Likelihood Estimation (MLE) procedure¹³. The nondimensional derivatives are obtained from the model parameters using equation 4. The estimated derivatives are given in table 2. The Static derivatives $C_{L_{\alpha}}$ and $C_{m_{\alpha}}$ are compared with static data¹². As Pitch

damping $(C_{m_q} + C_{m_{\dot{\alpha}}})$ and Pitch control effectiveness $C_{m_{\delta_e}}$ data was not available for comparison **the** same were estimated using Datcom¹. Figure 5 shows these

comparisons. Dynamic wind tunnel simulation results **are** in close agreement with static data and Datcom estimates except for Pitch control effectiveness. **The** discrepancy in $C_{m_{\delta_e}}$ is due to the inaccuracy in the elevon deflection measurement.

From $C_{L_{\alpha}}$ and $C_{m_{\alpha}}$ static margin and neutral point are computed using the relation

$$SM = (h_n - h_c) = -C_{m_{\alpha}} / C_{L_{\alpha}};$$

$$\therefore h_n = h_c - C_{m_{\alpha}} / C_{L_{\alpha}} \quad (4)$$

The neutral point location obtained using the above equation is shown in figure 6 **as** a function of angle of attack. **The** neutral point **data** from reference 12 is also plotted for comparison. It is seen that the comparison is **good**.

Figure 7 shows the model response to a large amplitude elevon step input. The effect of deflecting the elevon **can** be clearly seen in the beginning of the response where the Lift first decreases due to negative elevon deflection before building up with increase in angle of attack.

Figure 8 shows the variation of C_L with angle of attack during an **step** elevon response. The trim C_L is also shown in the figure. It can be seen that the dynamic Lift attainable is much more than the static **Lift**. **The** effect of increasing elevon magnitude on **the** Lift response is also shown in the figure. The labels 1 and 1.4 indicates the input amplitude with respect to the first input which is taken **as one**. While **the** responses are essentially same in the low angle of attack region, they differ at large **angles** of attack. **This** is attributed to flow separation, leading edge vortex breakdown, aerodynamic lags and hysteresis. These responses show **the** dynamic Lift effects and the **Lift** attainable during high angle of attack maneuvers **beyond** stall.

Figure 9 shows the variation of C_m with angle of attack due **to** an elevon **step** input. It can **be** seen from **the** figure that **the** pitching moment is zero at the beginning and at the end **as** the model moves

from one trim condition to the other while the angle of attack changes from one trim to the other.

These large amplitude lift and pitching moment responses are useful in aerodynamic modelling at high angles of attack.

6. Conclusions

A novel **method** of generating comprehensive longitudinal aerodynamic data of aircraft configuration using dynamic wind tunnel simulation **has** been presented and demonstrated.

The aerodynamic **data** generated include

- i. Trimmed Lift characteristics
- ii. Location of neutral point and its variation with angle of attack
- iii. Static and dynamic stability derivatives
- iv. Dynamic **Lift** and pitching moment response at high angle of attack.

The advantage of this method is the simplicity of model instrumentation and wind tunnel testing. It promises to be **a** cost effective experimental technique of generating comprehensive aerodynamic data for stability and control studies.

7. Acknowledgements

The contributions of Mr. Basappa in wind tunnel testing and data processing; Mr **B.K.K** Bhagwan in model fabrication; and Mr. S.R. Rajan in instrumentation are gratefully acknowledged.

8. References

1. Anon.: *USAF Stability & Control Datcom*. Air Force Flight Dynamics Lab., Wright Patterson Air force Base, Aug. 1968.
2. Orlik-Rückemann, K J.: *Review of techniques for determination of dynamic stability parameters in wind tunnels*. AGARD LS-114, 1981.
3. Bennett, R. M., et.al. Wind tunnel technique for determining stability derivatives from cable-mounted models. *Journal of Aircraft*, vol. 15, no. 5, May 1978, pp. 304 - 309.
4. Rohlf, D.: *Control characteristics of DO 28 TNT model using dynamic simulation in wind tunnels*. DFVLR IB 154-80/25. Dec. 1980.

5. Wilhelm, K.; Gmelin, B.: *Dynamic wind tunnel testing for active control research*. AGARDograph AG-262, Dec. 1984.
6. Heydari, F.: *On the estimation of stability and control characteristics of a generalised forward swept wing aircraft*. Ph.D. thesis, Aerodynamics dept., Cranfield Institute of Technology, UK. May 1986.
7. Balakrishna, S.; Niranjana, T.: Wind tunnel dynamic flying study of the pitching moment derivatives of **SDM** model in active control. AIAA Paper 87-2626, 1987.
8. Balakrishna, S.; Niranjana, T.; Rajamurthy, **M.S.**; Srinathkumar, S.; Rajan, S.R.; Singh, S.K.: *Estimation of aerodynamic derivatives using Dynamic wind tunnel simulation technique*. Proceedings of the NAL-DLR Symposium on *System Identification*. **NAL SP 9324**, Dec. 1993. (also DLR Mitt. 93-14, 1993).
9. Jarrah, M. A.: Low speed wind tunnel investigation of flow about Delta wings, oscillating in pitch to very high angle of attack. AIAA Paper 89-0295, 1989.
10. Hanff, E. S.; Kapoor, K.; Anstey, C. R.: Large amplitude High rate roll Oscillation system for the measurement of Non-linear loads. A I M Paper 90-1426, June 1990.
11. Torlund, P. -A.: Wind tunnel force measurements and visualisation on a 60 deg. Delta wing in oscillation, stepwise motion and gusts. Paper no. 10, AGARD conference on *Manoeuvring Aerodynamics*, **AGARD CP497**, May 1991.
12. Vishwanath, P. R.; Patil, S. R.; Aerodynamic characteristics of Delta Wing-body combinations at high angles of attack, paper 1959, The Aeronautical Journal, Vol. 28, **May** 1994.
13. Jategaonkar, R V. ; Plaetschke, E. : *Maximum Likelihood parameter estimation from flight test data for general non-linear systems*. DFVLR-FB 83-14, 1983.

Table 1. Reference parameters of the model

Mean aerodynamic chord	0.289 m
Wing reference area	0.1084 m ²
Pitch Inertia of the model	0.03754 Kg-m ²

Table 2 Estimated Longitudinal Derivatives

Trim angle of attack deg.	Trim elevon deg.	C_{L_α} rad ⁻¹	C_{m_α} rad ⁻¹	$C_{m_q} + C_{m_{\dot{\alpha}}}$ rad ⁻¹	$C_{m_{\delta_e}}$ rad ⁻¹
5.3	6.14	2.42	-0.181	-1.27	-0.284
6.7	5.54	2.31	-0.142	-1.52	-0.317
11.0	4.00	2.18	-0.116	-1.72	-0.413
14.6	3.10	2.25	-0.141	-1.89	-0.410
18.4	1.96	1.91	-0.171	-1.82	-0.351

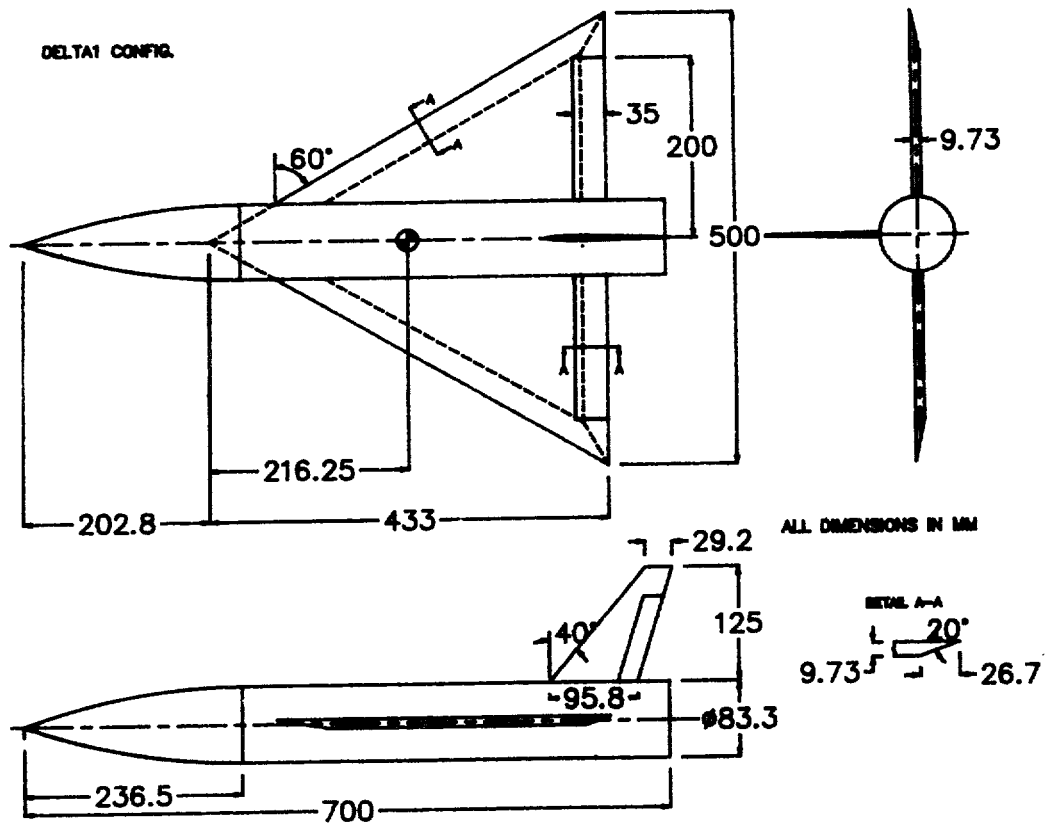

Figure 1. Geometric details of the model

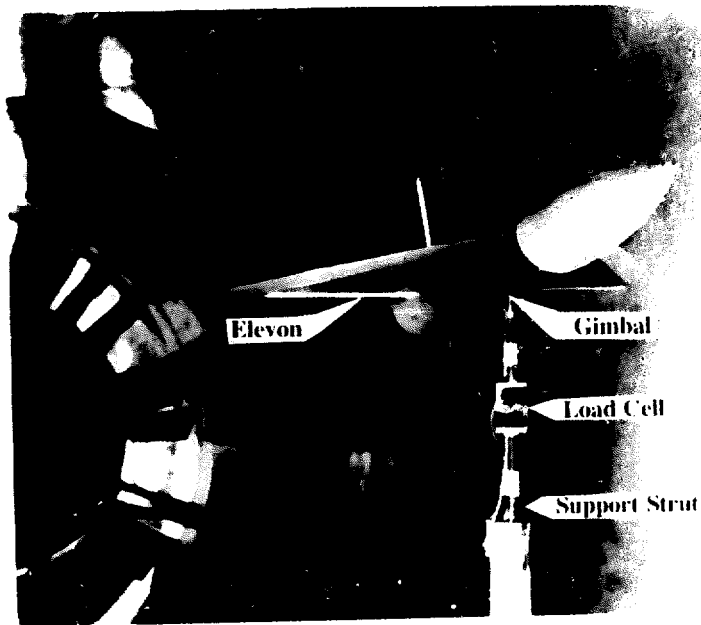

Figure 2. Delta wing model in the wind tunnel

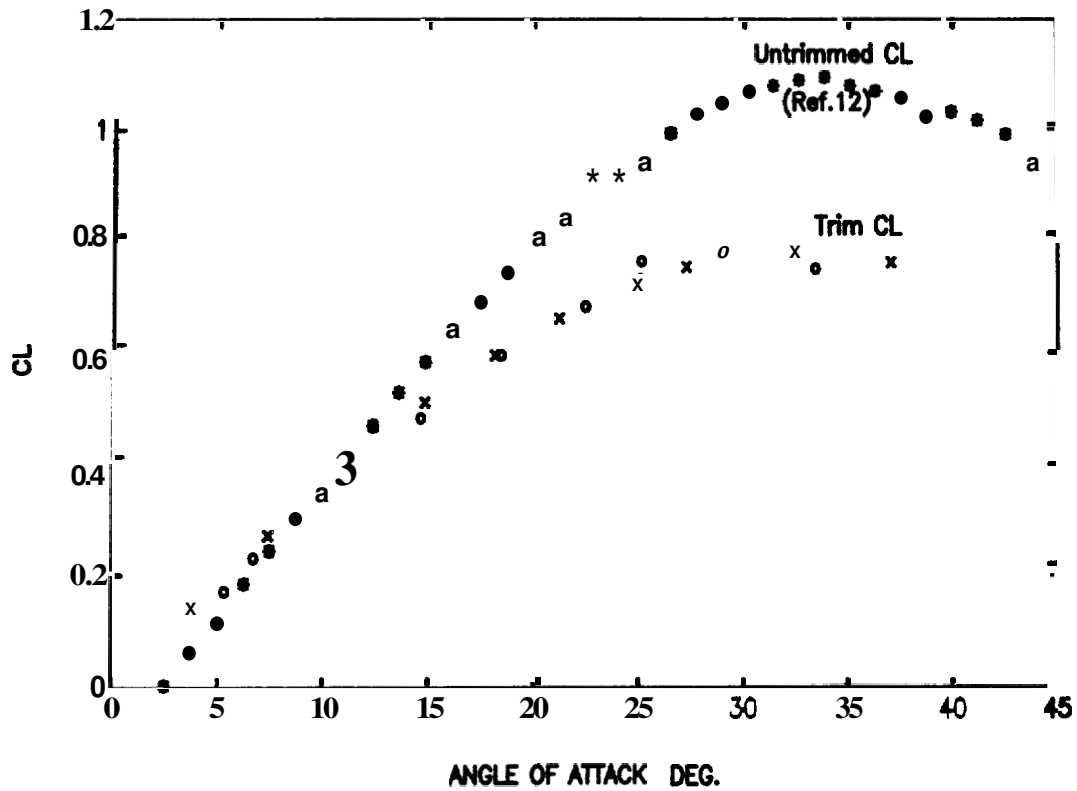

Figure 3. Trimmed Lift characteristics

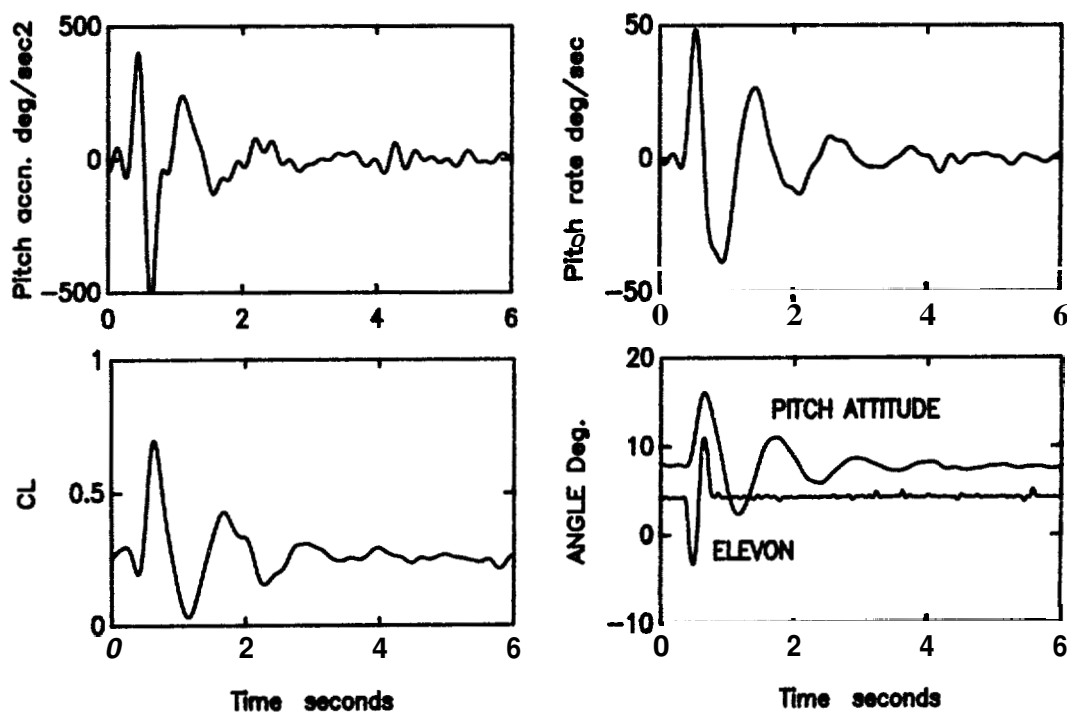

Figure 4. Response of aircraft model to an elevon doublet

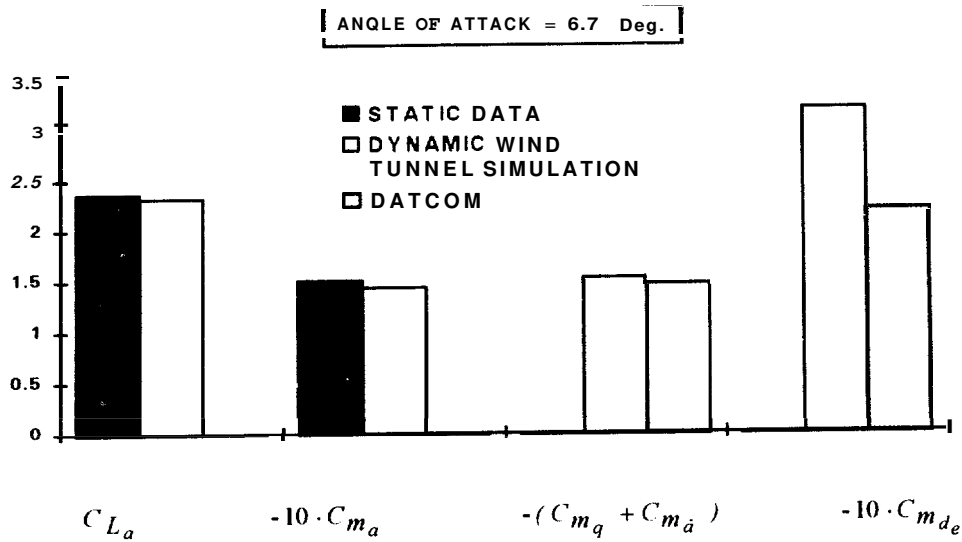

Figure 5. Comparison of estimated derivatives with static test data and Datcom estimates

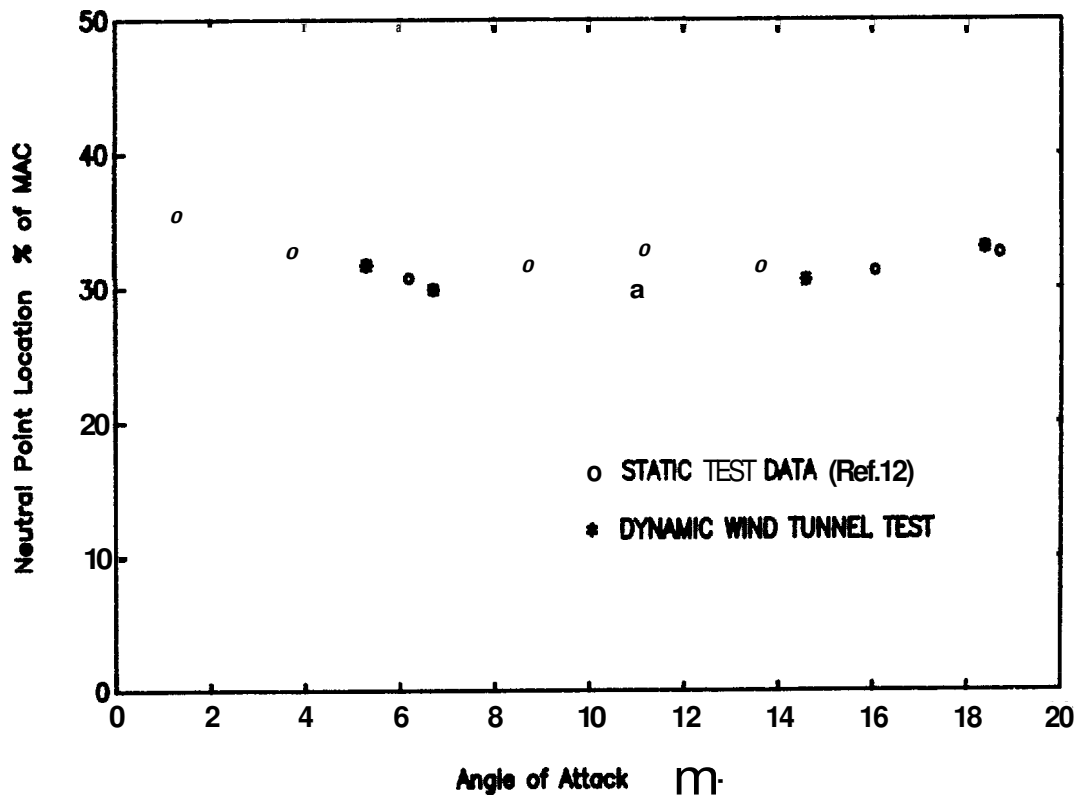

Figure 6. Variation of neutral point with angle of attack

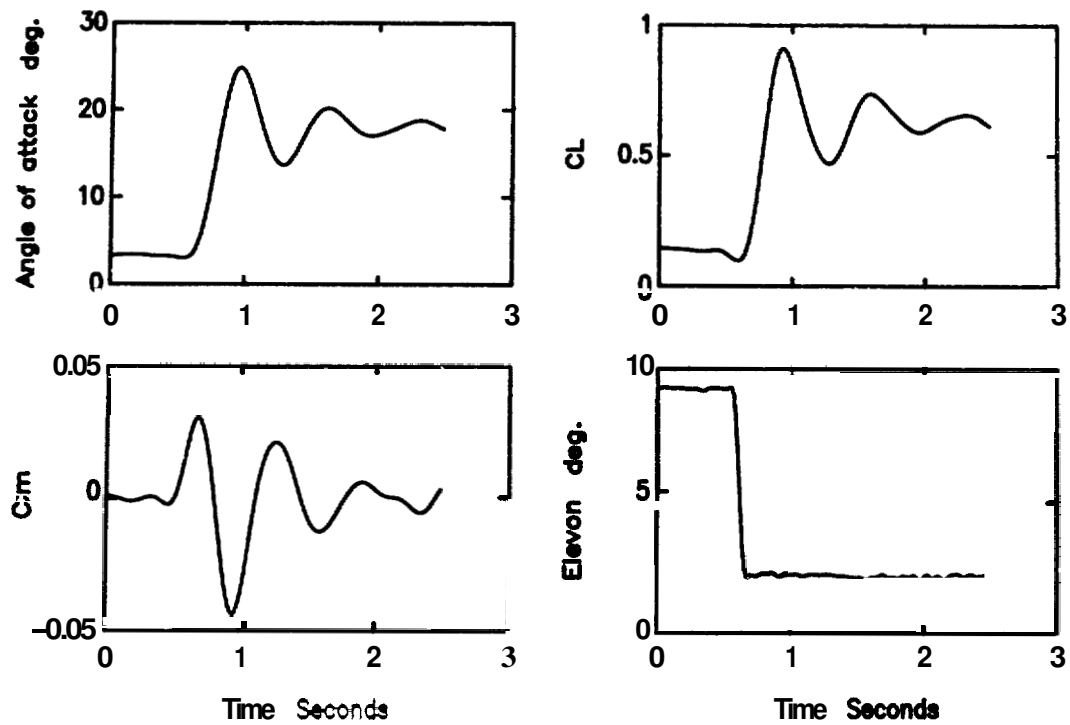

Figure 7. Large amplitude response of the model to a step Elevon input

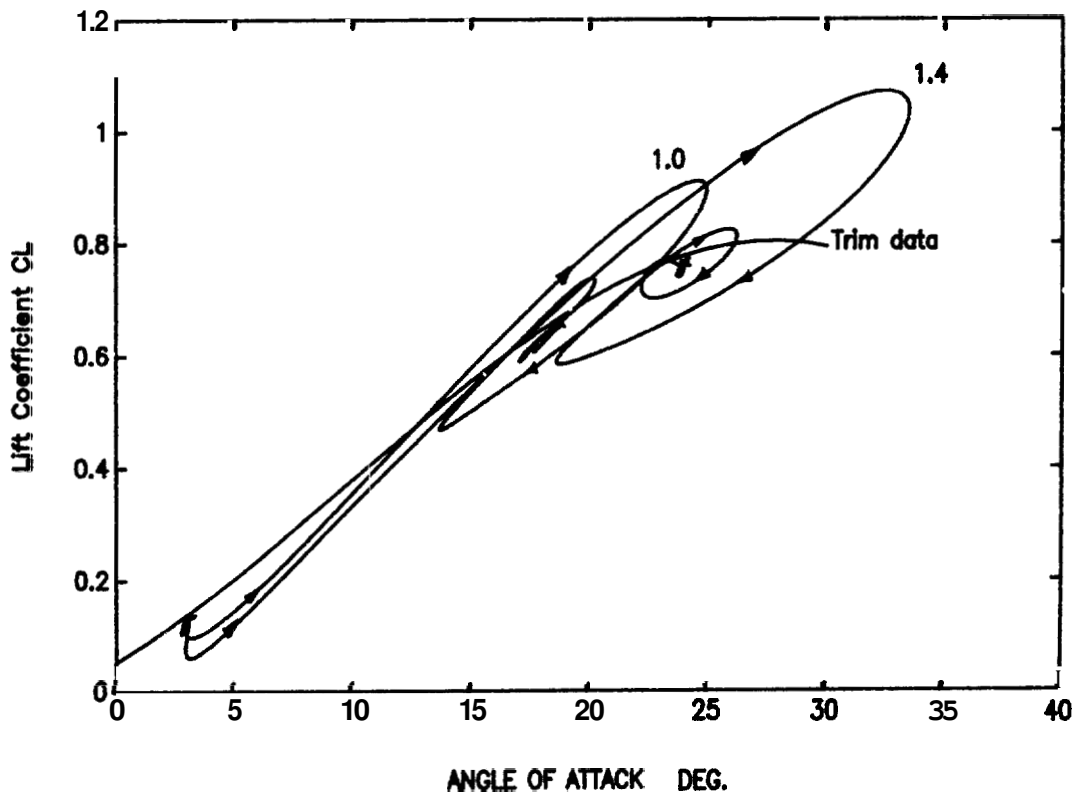

Figure 8. Large amplitude Lift responses

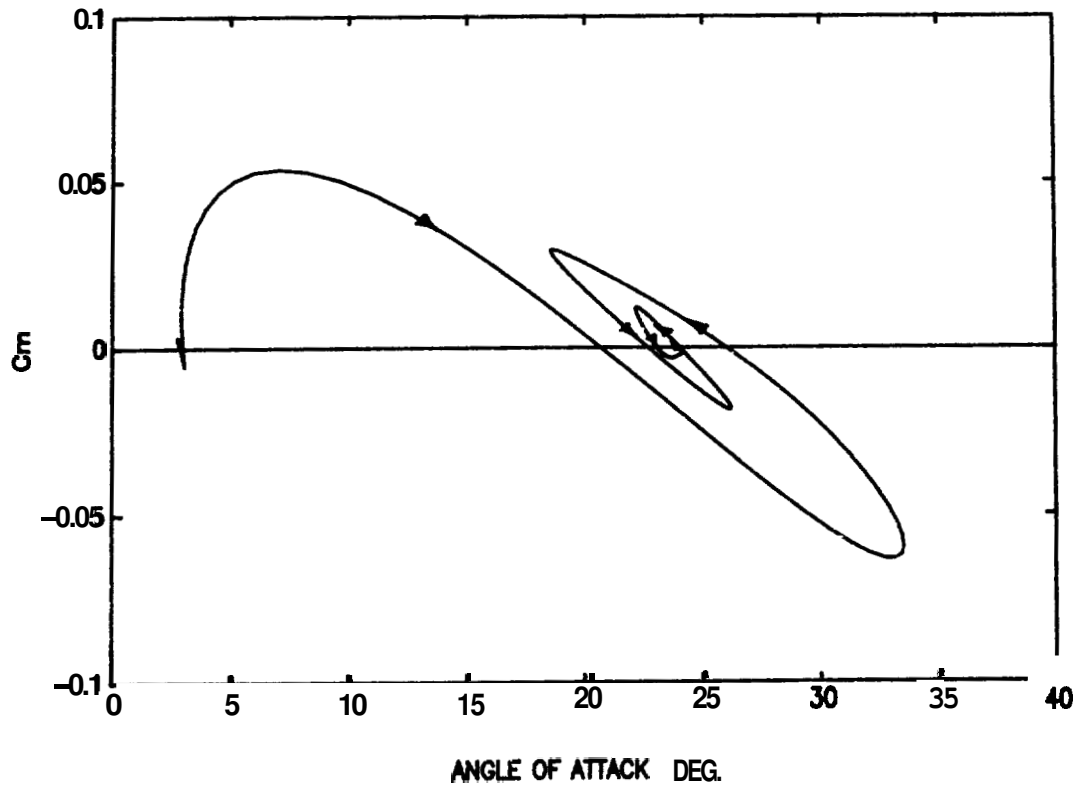

Figure 9. Large Amplitude pitching moment response



AIAA 96-0777

**Generation of Comprehensive Longitudinal
Aerodynamic data using Dynamic wind
tunnel simulation**

M.S.Rajamurthy
National Aerospace Laboratories
Bangalore, INDIA

**34th Aerospace Sciences
Meeting & Exhibit
January 15-18, 1996 / Reno, NV**