

AD-A106 056

NAVAL RESEARCH LAB WASHINGTON DC F/G 5/2
GENERATION OF ELECTROSTATIC CHARGE IN FUEL HANDLING SYSTEMS: A --ETC(U)
SEP 81 J T LEONARD
NRL-8484

UNCLASSIFIED

NL

1 of 1
AD A
106056

END
DATE
FILMED
11-81
DTIC

LEVEL

(2)

NRL Report 8484

AD A106056

Generation of Electrostatic Charge in Fuel Handling Systems: A Literature Survey

J. T. LEONARD

*Combustion and Fuels Branch
Chemistry Division*

September 24, 1981

DTIC FILE COPY

DTIC
ELECTE
OCT 23 1981
S D
A



NAVAL RESEARCH LABORATORY
Washington, D.C.

Approved for public release; distribution unlimited.

81 10 23

REPORT DOCUMENTATION PAGE		READ INSTRUCTIONS BEFORE COMPLETING FORM
1. REPORT NUMBER NRL Report 8484	2. GOVT ACCESSION NO. AD-A106056	3. RECIPIENT'S CATALOG NUMBER
4. TITLE (and Subtitle) GENERATION OF ELECTROSTATIC CHARGE IN FUEL HANDLING SYSTEMS: A LITERATURE SURVEY.	5. TYPE OF REPORT & PERIOD COVERED Final Report 1978	
7. AUTHOR(s) J. T. Leonard	6. PERFORMING ORG. REPORT NUMBER	
9. PERFORMING ORGANIZATION NAME AND ADDRESS Naval Research Laboratory Washington, DC 20375	8. CONTRACT OR GRANT NUMBER(s)	
11. CONTROLLING OFFICE NAME AND ADDRESS Naval Sea Systems Command Code OSD23 Washington, DC 20362	10. PROGRAM ELEMENT, PROJECT, TASK AREA & WORK UNIT NUMBERS 60-1291-0-0	
14. MONITORING AGENCY NAME & ADDRESS (if different from Controlling Office)	12. REPORT DATE 27 Sep 1981	13. NUMBER OF PAGES 54 55
	15. SECURITY CLASS. (of this report) UNCLASSIFIED	
	15a. DECLASSIFICATION/DOWNGRADING SCHEDULE	
16. DISTRIBUTION STATEMENT (of this Report) Approved for public release; distribution unlimited.		
17. DISTRIBUTION STATEMENT (of the abstract entered in Block 20, if different from Report)		
18. SUPPLEMENTARY NOTES		
19. KEY WORDS (Continue on reverse side if necessary and identify by block number) Electrostatic charging Static electricity GRP pipe		
20. ABSTRACT (Continue on reverse side if necessary and identify by block number) A review is presented on the status of research on the generation and dissipation of electrostatic charge by hydrocarbon liquids and fuels, with emphasis on the period 1973-1980. Both metallic and nonmetallic fuel handling systems are covered, including the special problems encountered in aircraft fuel tanks filled with polyurethane foam. The review stresses recent advances and presents opportunities for future research in some neglected, but nonetheless fundamental areas affecting the charge generation process.		

2511

CONTENTS

INTRODUCTION	1
CHARGE GENERATION IN METALLIC FUEL HANDLING SYSTEMS	1
GENERATION OF CHARGE IN NONMETALLIC SYSTEMS	16
SOLUTIONS	22
ANNOTATED BIBLIOGRAPHY	23

SEARCHED
SERIALIZED
INDEXED
FILED

By _____

APR 1 1964

A

GENERATION OF ELECTROSTATIC CHARGE IN FUEL HANDLING SYSTEMS: A LITERATURE SURVEY

INTRODUCTION

A number of survey articles on electrostatic charge generation in fuel handling systems have appeared [1-5] since Klinkenberg and Van der Minne published their monograph on the subject [6]. The most recent and comprehensive literature survey was completed in 1973 by Bachman and Munday [7]; this survey, which included nonmetallic systems, contained an annotated bibliography with 71 references. No attempt was made in the present survey to include all of the references from the earlier works. Instead, the present survey concentrates on the period 1973-1980. The few references prior to 1973 that are mentioned are those that the author feels were either overlooked or are required for the development of the current survey.

Since considerable research has been done on electrostatic charge generation by hydrocarbon fuels in metallic systems [8-13], this survey will begin with a discussion of how charge is generated in a typical fuel handling system in which fuel flows through a pipe, pump, filter/separator and finally into a receiving tank (tank truck, refueler or aircraft). With the exception of the rubber fueling hose and the media used in the filter/separator elements, which may be paper, fiberglass, or Teflon-coated screen, all of the components of this system are metal.

In the second part of this review, the special conditions imposed on the static charge generation and dissipation processes by the use of nonconductors in place of metal in the pipe or in the receiving tank are considered.

CHARGE GENERATION IN METALLIC FUEL HANDLING SYSTEMS

Whenever a hydrocarbon liquid, such as jet fuel, flows with respect to another surface, a charge is generated in the liquid [3]. Although the exact nature of the charging mechanism is not completely understood, it is generally held that the charge is due to ionic impurities present in the hydrocarbon in parts-per-million or parts-per-billion quantities. When the fuel is at rest, the impurities are adsorbed at the interface between the fuel and the walls of the container, with one part of the ionic material showing a rather strong attachment for either the fuel or the solid surface. This type of attachment is illustrated in Fig. 1a which shows fuel in contact with the wall of a metal pipe. In this example, the negative portion of the ionic material is depicted as being more strongly attracted to the solid surface, but since the numbers of positive and negative charges are equal, there is no net charge on the fuel. However, when the fuel begins to flow (Fig. 1b), the positive charges are swept along by the fuel while the negative charges leak to ground. Thus, the fuel acquires a net positive charge as it moves through the system. In a similar manner, the fuel would receive a negative charge if the positive portion of the ionic material were preferentially adsorbed at the solid surface.

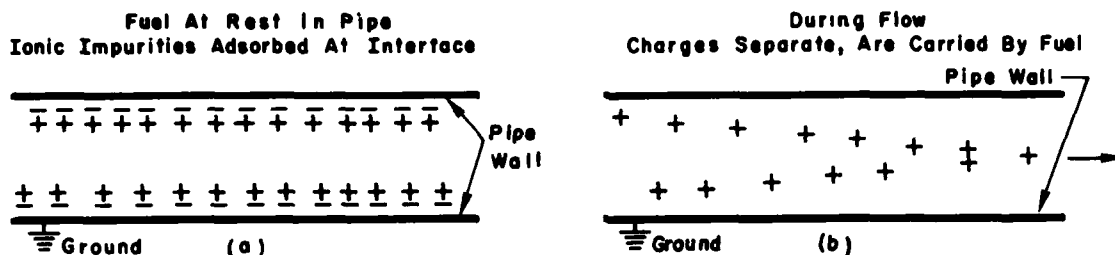

Fig. 1 - (a) Fuel at rest in a pipe showing adsorption of ionic impurities at pipe wall
 (b) Separation of charge as fuel flows through pipe.

A number of authors have proposed equations for calculating the streaming current developed by the flow of hydrocarbon liquids in metal pipes. Most of these studies were completed prior to 1973 and were reviewed by Bachman [7] and also by Gibson [14] and hence are not repeated here. References to two Russian works appear to have escaped attention previously, namely Zhukov [15], who studied streaming currents in petroleum ether, and Obukh et al. [16], who employed Koszman and Gavis' equation to calculate the streaming current in jet fuel during tanker loading. The conclusion from these references is that the process by which the streaming current is calculated is rather complex and involves a combination of the parameters that determine the distribution of charge in the liquid (e.g. the dimensions of the double layer, ionic mobility, and the conductivity of the liquid) and the flow pattern of the liquid (e.g. viscosity, flow velocity and the pipe diameter and length). For a given liquid in a particular system, most of these parameters can be expressed as a constant. Gibson and Lloyd, for example, found that the streaming current for toluene in pipes of diameter 1.6 to 10.9 cm and length of 29 m could be estimated from the following equation [17]:

$$i_{\infty} = AV^{2.4}d^{1.6}$$

where

i_{∞} = Streaming current for infinite pipe length,

A = Constant,

V = Linear flow velocity (cm s^{-1}),

and

d = Diameter of pipe (cm).

The introduction of a filter/separator into the fuel handling system, as is done in tank truck loading and aircraft fueling, presents a somewhat more complicated picture than flow through a pipe, primarily because filters greatly increase the level of charge on the fuel. A typical aircraft fueling operation is illustrated in Fig. 2, together with an indication of the level of charge on the fuel as it passes through each piece of equipment [2]. Since charge separation is a surface effect and since filter/separators provide a tremendous amount of surface area upon which charge separation can take place in a comparatively short period of time, the level of charge on the fuel emerging from the filter/separator may be increased by a factor of 100 or more as compared with flow through the hydrant line. A more detailed illustration of the charge separation process in a typical two-stage filter/separator is presented in Fig. 3. The first stage, the filter-coalescer, removes dirt and coalesces water. The coalescer may charge the fuel positively, as shown in the figure, or negatively. The second stage, the water separator, allows the fuel to pass but causes the coalesced water to settle out. The coalescer may increase the charge on the fuel if it develops the same sign of charge as the separator, or decrease it if it produces charges of the opposite sign.

When the charged fuel arrives at the receiving tank, either of two possibilities will occur: (a) the charge will relax harmlessly to the walls of the tank or, (b) if the conductivity of the fuel is sufficiently low, the charge may accumulate giving rise to high potentials on the fuel surface. If somewhere on the

Fig. 2 — Generation of electrostatic charge during aircraft fueling [2]

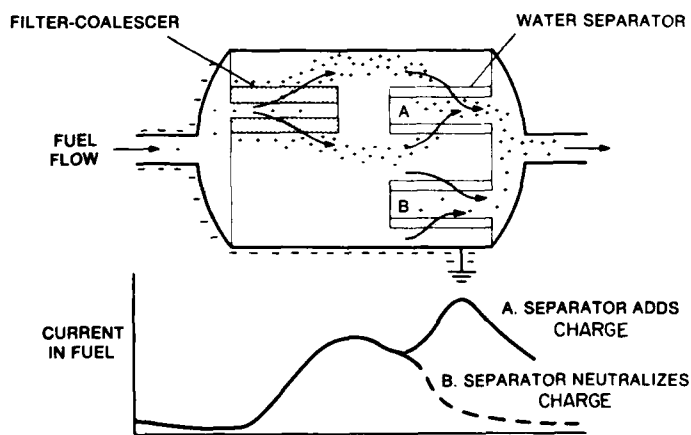
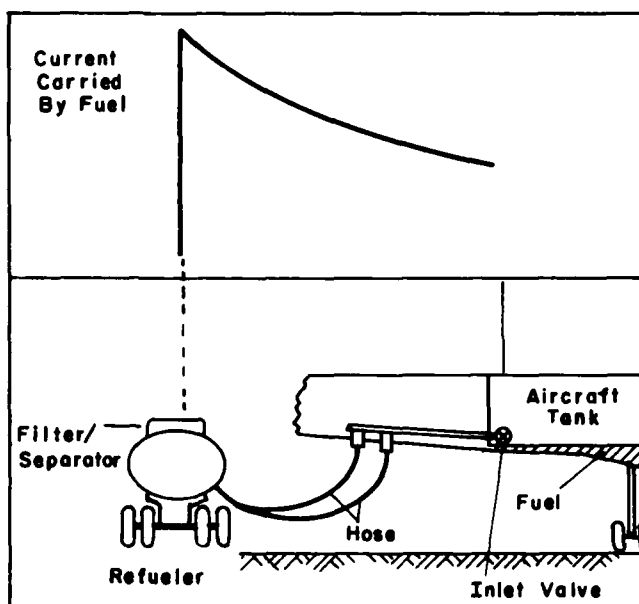

Fig. 3 — Charge separation in a filter/separator [2]

fuel surface the local potential exceeds the breakdown value for the vapor space, a discharge will occur as depicted in Fig. 4. Whether or not the vapor will ignite depends on the composition of the vapor and the nature of the discharge.

The composition of the fuel/air mixture in the vapor space is dependent upon the temperature, the fuel type and the physical state (vapor or mist). As suggested in Fig. 5, not all fuel/air mixtures can be ignited. Instead, there is a definite concentration range over which mixtures of each hydrocarbon in air will burn. This is called the flammable range. For a material such as n-octane, a hydrocarbon found in some jet fuels, the flammable range extends from 0.92 to 6.5 percent of n-octane in air. If the upper limit of this range is exceeded, the mixture becomes too rich in hydrocarbon to be ignited. Likewise, if the fuel vapor concentration falls below the lower limit, insufficient hydrocarbon is present in vapor space to sustain combustion.

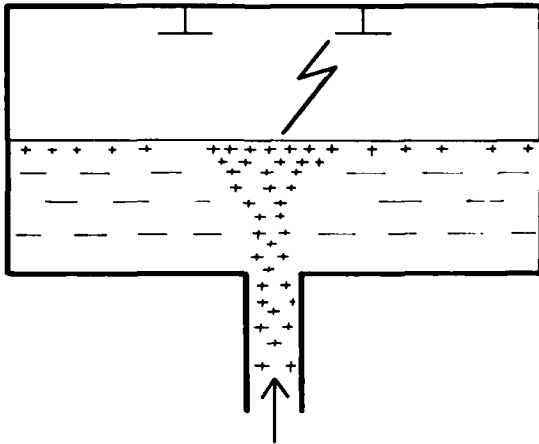

Fig. 4 — Discharge from fuel surface to tank

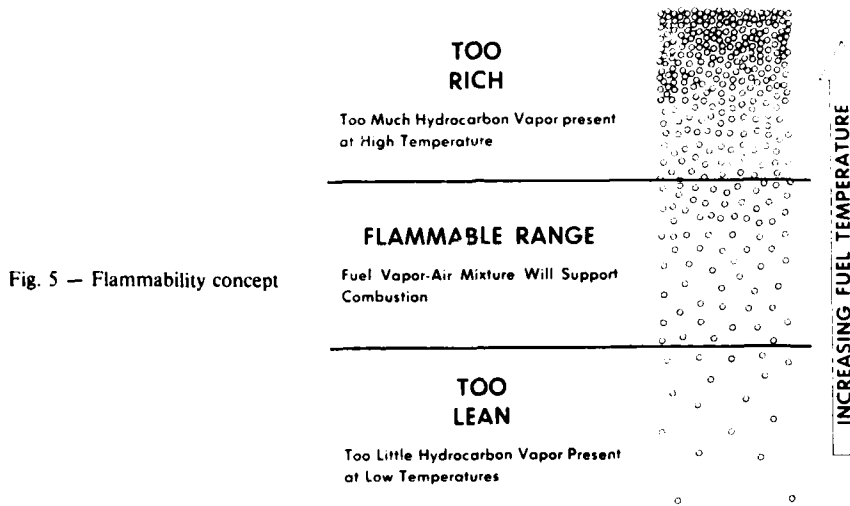

Fig. 5 — Flammability concept

Since the amount of hydrocarbon present in the air is proportional to the temperature, the flammable range can also be expressed in terms of temperature limits. Figure 6 presents the temperature-flammability limits for several common fuels. Aviation gasoline (Avgas), for example, is seen to be in the flammable range from -40 to -6.7°C . Above -6.7°C , equilibrium mixtures of Avgas in air are too vapor-rich to be ignited. For jet fuel, JP-4, the flammable range extends from -37 to approximately 24°C . Above 24°C , JP-4 passes into the vapor-rich region. For kerosene, the lower flammability limit corresponds to about 38°C , for JP-5 and for Diesel Fuel Marine (DFM) it is 60°C .

The temperature-flammability limit concept applies only to situations in which the liquid fuel is in equilibrium with its vapor. Consequently these limits should be used only to estimate the composition of a fuel/air mixture in a quiescent tank. At best, they can serve only as a rough guideline in describing the situation that exists during tank filling or aircraft refueling. In practice, these conditions may vary widely from ideality, especially during the initial stages of filling an empty tank. With kerosene, for example, "flammable" fuel/air mixtures can be produced during fueling at temperatures far below the lower flammability limit for that fuel (Fig. 7) [18]. In this case, however, the flammable mixtures consist of a foam or mist generated by the splashing action of the fuel or by the fuel inlet valve if it is not submerged. It is interesting to note that in three explosions that occurred during the fueling of a commercial jet aircraft, kerosene was ignited at temperatures far below its flash point; as much as 30.5°C below the flash point in one case.

Fig. 6 — Approximate temperature flammability limits for common fuels. This is the fuel temperature range at sea level within which the vapor in equilibrium with the fuel will form a flammable mixture with air.

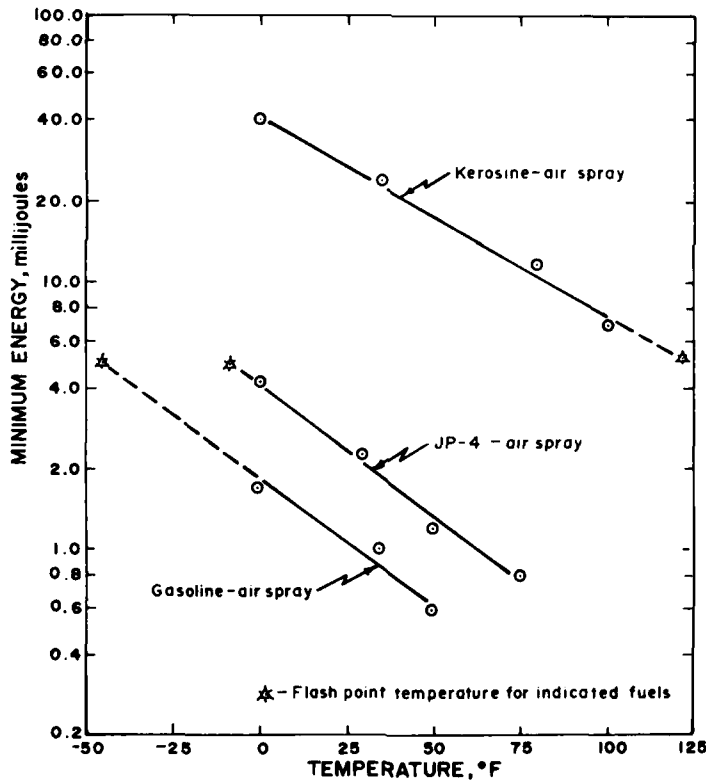
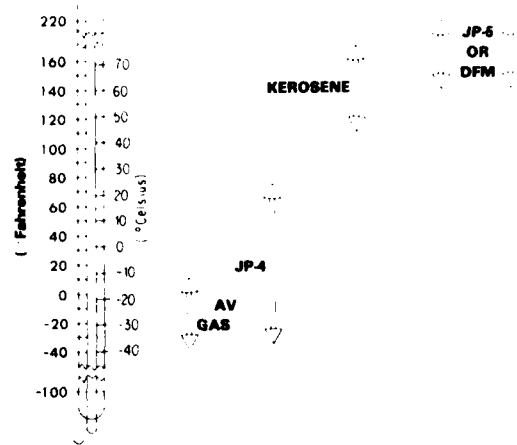

Fig. 7 — Minimum spark ignition energies for fuel/air spray mixtures [18]

In addition to the presence of a flammable vapor, the second requirement for ignition is a discharge of sufficient energy and duration. The minimum amount of energy required for a spark discharge to ignite an optimum hydrocarbon fuel/air mixture under ideal conditions is 0.26 millijoules (mJ) [19]. By optimum fuel/air mixture is meant the most easily ignited mixture of fuel in air and ideal conditions refer to glass-flanged metal electrodes at a gap of 0.5 cm (0.2 in.). As conditions

depart from ideality, the energy requirements increase. Thus, changing the fuel/air mixture, the electrode geometry or the gap distance will increase the amount of energy required for ignition. Also, substitution of a high resistivity material, such as a hydrocarbon fuel surface, for one electrode increases the energy requirements for ignition. As an example, the amount of energy required for a discharge from a fuel surface to ignite a propane/air mixture was reported to be 4.7 mJ, eighteen times the energy required to ignite the same mixture with a spark discharge between two metal electrodes [20]. Although 4.7 mJ may not be the absolute minimum ignition energy for a discharge from a fuel surface, it is apparent that the minimum must be in the range of 0.26 to 4.7 mJ. If so, then the minimum ignition energy for a discharge from a fuel surface is not quite as high as previously supposed.

The amount of charge on a fuel when it arrives at the receiving tank (and hence its propensity for producing an incendiary discharge) depends upon:

- (a) the amount of charge generated in the filter/separator, which varies with the filter media and the nature of the impurities or additives in the fuel,
- (b) the flow rate,
- (c) the residence time of the fuel in the system downstream of the filter, and
- (d) the electrical conductivity of the fuel, which determines the rate at which the charge relaxes.

The relaxation time for a fuel can be calculated from the following equation.

$$Q_t = Q_0 e^{-tk/\epsilon\epsilon_0}$$

where Q_0 = initial charge ($\mu\text{C}/\text{m}^3$)

Q_t = charge after time, t ($\mu\text{C}/\text{m}^3$)

t = elapsed time (seconds)

k = rest fuel conductivity (Siemens/m)

ϵ = relative dielectric constant, a dimensionless quantity which varies only slightly for hydrocarbon fuels and has a value of about 2

ϵ_0 = the absolute dielectric constant of a vacuum (8.854×10^{-12} ampere seconds/volt meter).

Since charge relaxation is an exponential process, it is customary to define relaxation time, r , as the time required for the original charge to decay to 36.8% of its original value. When

$$\frac{Q_t}{Q_0} = 0.368, \quad \frac{\epsilon\epsilon_0}{rk} = 1$$

and r is related to k by the following relationship:

$$r = \frac{\epsilon\epsilon_0}{k} = \frac{17.7 \times 10^{-12}}{k},$$

$$r \sim \frac{18 \times 10^{-12}}{k}.$$

The conductivity of fuels is often described in terms of conductivity units, CU, or, in the International System, picosiemens/meter. These units are related as follows:

$$\begin{aligned} 1 \text{ CU} &= 1 \text{ picosiemens/meter (pS/m)} \\ &= 10^{-12} \text{ Siemens/meter} \\ &= 10^{-12} \text{ mhos/meter.} \end{aligned}$$

According to the above equation, the relaxation time for fuels would be expected to vary with rest conductivity as follows:

<u>Conductivity,</u> pS/m	<u>Relaxation Time,</u> s
0.01	1800
0.1	180
1.0	18
10.0	1.8
100.0	0.18

A survey of the electrical conductivity of turbine fuels (Fig. 8) showed that 38% of the Jet A samples had conductivities of less than 1 pS/m [21]. These results indicate that relaxation times in excess of 18 s would be required to reduce the charge on almost half of the turbine fuels to 36.8% of their original value. Since the residence time of the fuel in the hoses downstream of the second filter/separator in a typical aircraft fueling operation (Fig. 2) is at most only a few seconds, the above data would suggest that for lower conductivity fuels most of the charge generated at the filter arrives at the aircraft tank undiminished. Fortunately, this is not always the case. Bustin et al. [22] have shown that if the conductivity of the fuel is less than 1 pS/m the charge relaxes faster than predicted by the above (ohmic) equation. A comparison of the relaxation behavior for a 0.01 pS/m fuel using both the ohmic and Bustin's hyperbolic theories of charge relaxation is shown in Fig. 9. The experimental data points for the low conductivity fuel follow the hyperbolic theory and show that in 30 s, over 70% of the charge on the fuel has relaxed as compared with less than 5% predicted by the ohmic theory. For the 1.0 pS/m fuel, the experimental data follow the ohmic theory. Bustin's theory and a wealth of experience have shown that 30 s relaxation time is sufficient to remove most of the charge on a fuel regardless of its conductivity. The American Petroleum Institute recommends at least 30 s relaxation time downstream of filter/separators [23].

The effect of impurities and additives on both fuel conductivity and electrostatic charging tendency is an important aspect of the problem which is still not completely understood. Leonard and Bogardus [24,25] have investigated the effects of 46 polar and ionic compounds and 24 fuel additives on both the conductivity and charging tendency of jet fuel. Of all the materials tested, only one, water, was found to be a true pro-static agent, i.e., a material that greatly increases the charging tendency of the fuel without a corresponding increase in conductivity. Moreover, it was not water per se, but rather its interaction with the additives or the naturally occurring impurities in the fuel which was responsible for its pro-static effect. Since fuels vary widely in the nature of the additives and impurities they contain, they likewise vary widely in their response to water. Other materials, e.g., petroleum sulfonates, an antioxidant and a corrosion inhibitor were found to exhibit pro-static characteristics, but were not as effective as water. Lewis and Strawson [11] found that polysulfones, amines and sulfonates at concentrations as low as 1 ppm can increase the charging tendency of fuel several hundredfold without a corresponding increase in conductivity. Russian workers have also reported that additives increase the charging tendency of jet fuels [26] but that drying fuels increased the charging tendency in tube charging studies [27]. Exposure to daylight was reported to decrease the charging tendency but increase the conductivity of jet fuels [28].

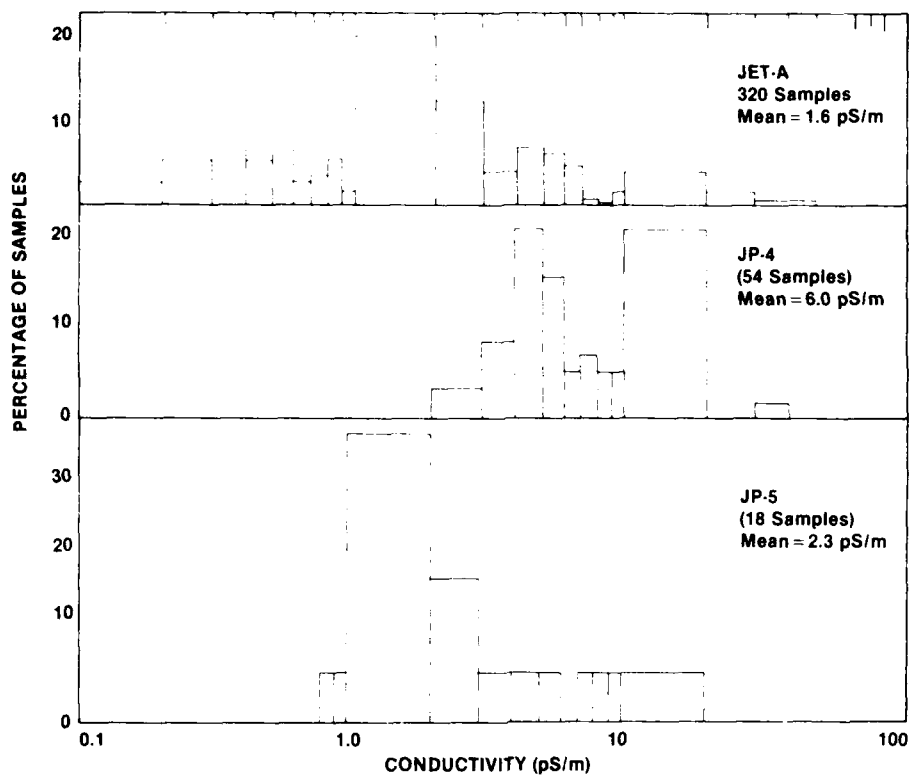

Fig. 8 — Distribution in conductivity for Jet A and A-1, JP-4 and JP-5—combined data from Phases I and II, 1973 Survey [21]

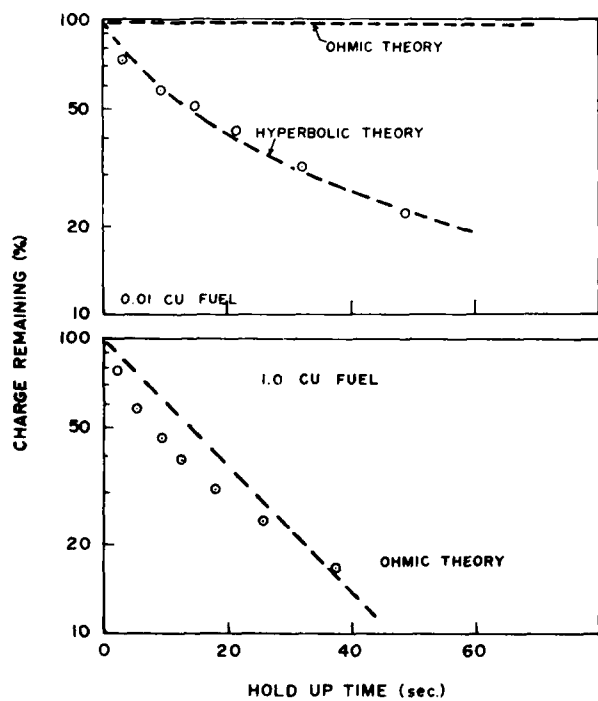

Fig. 9 — Comparison of hyperbolic and ohmic theories in predicting charge relaxation for fuels with conductivities of 0.01 and 1.0 CU [22]

What then constitutes a hazardous conductivity range for a fuel? The answer is that it depends on the system and, more particularly, on the residence time of the fuel in the system downstream of the filter/separator. Measurements of the field strengths developed inside of a simulated aircraft fuel tank while being filled with kerosene and JP-4 fuel are shown in Fig. 10. The data indicate that the field strength passes through a maximum when the fuel conductivity is between 1 to 2 pS/m [1]. Other tests involving a mock up of a Vickers Vanguard wing tank show maximum field strengths when the fuel conductivity is in the range of 4 to 8 pS/m (Fig. 11), with a considerable variation in the field strength levels occurring in adjacent compartments [1]. If fuel monitors are present, the magnitude of the field strength will be greatly increased (Fig. 12). The conclusion, therefore, is that in assessing the hazard, one must take into consideration the entire fuel handling system in addition to the conductivity of the fuel. In general, if the conductivity is greater than 50 pS/m, the fuel is considered safe from the standpoint of electrostatic hazards [29]. However, as we shall see later, if the receiving tank contains polyurethane foam, which can act as a secondary charge generating surface, higher conductivity levels may be required. (The foam is used in certain military aircraft as an explosion suppressant.)

As stated above, discharges can occur in fuel tanks if the local potential caused by the charged fuel exceeds the breakdown value for the vapor space. Actually, two modes of discharge are possible as illustrated in Fig. 13: one involving a discharge from the fuel surface which may be a low energy corona, a pre-breakdown streamer or a spark discharge to some grounded projection [30,31]; and the other, a high energy spark discharge from some unbonded charge collector in the tank. The latter is far more dangerous since the entire amount of charge stored in the unbonded collector is released in a single discharge. By contrast, discharges from a fuel surface involve only a limited area due to the low conductivity on the fuel [30]. Tests have shown that when an unbonded charge collector is introduced into a simulated aircraft fuel tank, incendiary spark discharges can take place under conditions which failed to produce an ignition in the absence of the charge collector [2]. Unbonded charge collectors (e.g. butterfly clamps, i.e., ungrounded metal clamps with rubber sleeves which are used to support and separate tubing) have been found in aircraft fuel tanks, and floating metal cans and other objects have been found in tank trucks and refuelers. All of these charge collectors are potential ignition sources. Bachman reports that even charged foam inside a tank truck can bouy up a charge collector causing discharges to occur even when the fuel being loaded has a low charge [10].

If the tank is nearly empty, the inlet device can also serve as the grounded electrode for discharges. Spark discharges to the inlet device during the early stages of filling have been reported as being particularly difficult to suppress [2]. However, once the inlet device is covered by the fuel, localized internal discharges in the vicinity of the inlet are of no consequence since they take place under the fuel surface.

The type of discharge that occurs from the fuel surface depends on the configuration of the electrodes and the field strength [30]. Since in the case in question, one of the electrodes is some grounded part of the tank, the configuration of this electrode can vary from a sharp point, as illustrated in Fig. 13, to a flat plate as represented by the wall or top of the tank. The other electrode, the fuel surface, may also vary from a flat surface to an unspecified radius of curvature if a foam happens to be present. In the extreme case where both electrodes (the fuel surface and the roof of the tank) resemble parallel plates, the electric field between them is homogeneous and a spark discharge will occur if the field strength is high enough. Most of the time, however, one or both of the electrodes will have a small radius of curvature resulting in an inhomogeneous electric field and corona-type discharges.

There is considerable disagreement in the literature as to just what constitutes a hazardous surface voltage. Estimates run from 1 to 45 kV [32-38] (see Table 1) depending on the configuration of the grounded electrode and the polarity of the fuel. Recent work by Krämer and Asano [36] has helped to resolve this controversy. These authors studied discharges from a low conductivity kerosene ($k = 0.5$ pS/m) in a cylindrical tank (diameter = 1.6 m). The kerosene was charged either by passing through a microfilter or by charge injection using a needle injector connected to a high voltage supply. The sign

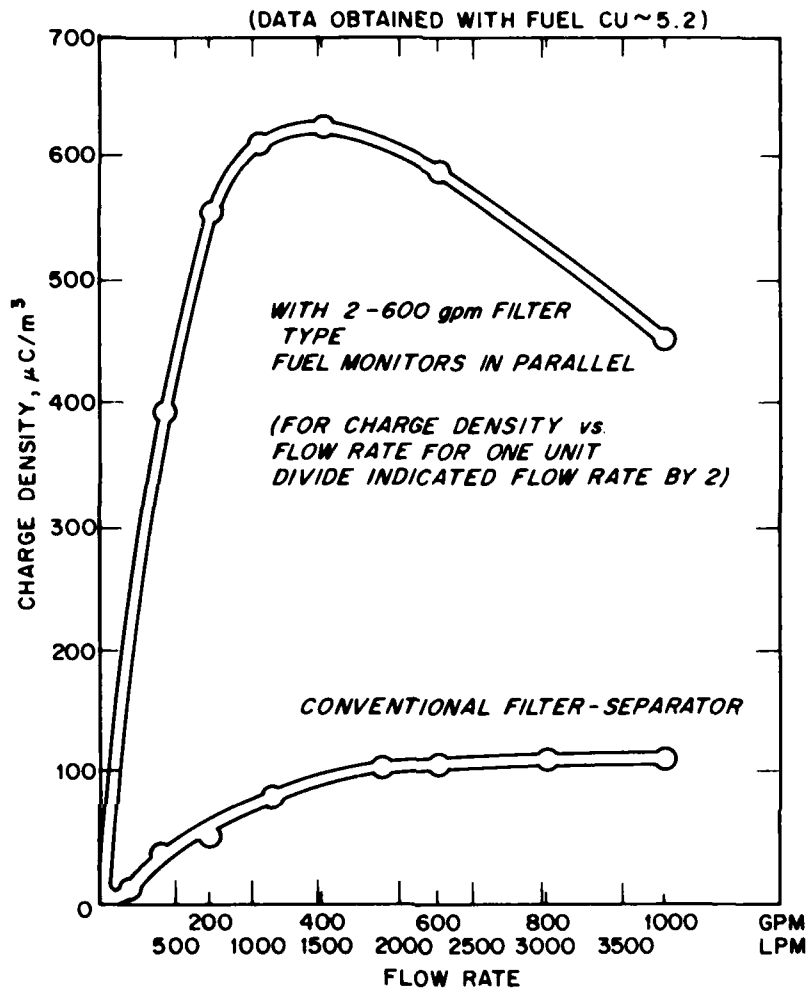

Fig. 12 — Effect of fuel monitor on charging tendency [2]

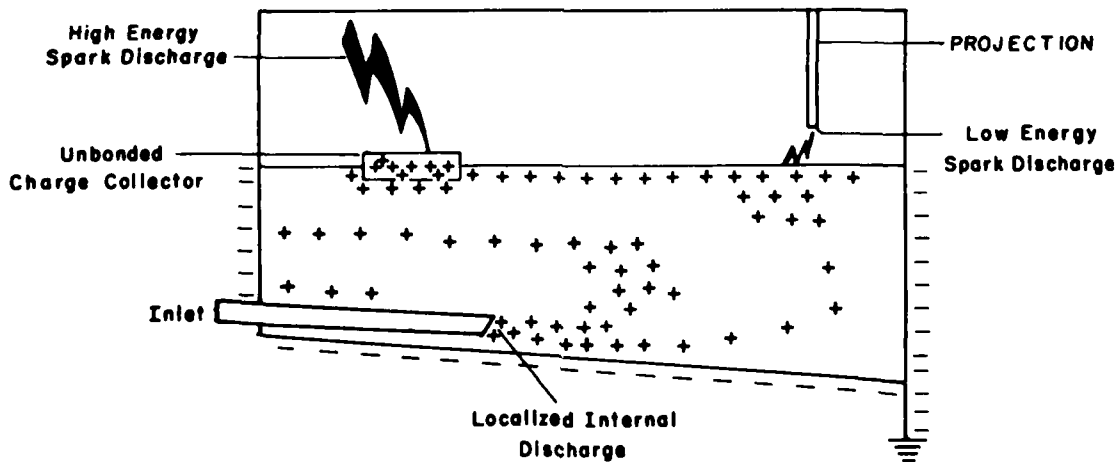

Fig. 13 — Sources of static discharge in a tank [2]

Table 1 — Comments on Maximum Surface Voltage for Hydrocarbon Fuels

Reference	Author(s)	Maximum Surface Voltage	Comment
[32]	R.E. Hertzog	1 kV	A surface potential of 1 kV is considered the upper limit for safe loading.
[33]	E.C. Summer	1.5 kV	Static potentials of less than 1.5 kV are not likely to cause ignition because of the quenching effect of the electrodes.
[34]	W.L. Bulkley and I. Ginsberg	20 kV	Surface voltages must exceed 20 kV to initiate sparking.
[35]	H. Strawson and A.R. Lyle	45 kV	Surface potential of 45 kV required to produce electrical discharges that will ignite a flammable vapor/air mixture.
[36]	H. Krämer and K. Asano	40 kV	A surface potential of 40 kV should be regarded as hazardous. Ignition occurred at 58 kV for spherical electrodes and 62 kV for ellipsoidal electrodes.
[37]	H. Krämer, K. Asano and G. Schön	40 kV	The voltage above which incendiary discharges take place is 40 kV.
[38]	A.W. Bright and I.G. Haig	25 kV 35 kV	Must be regarded as hazardous for negatively charged fuel. Must be regarded as hazardous for negatively charged fuel.

of the charge on the fuel was negative. (Negatively charged fuel is more hazardous.) A variety of spherical (diameter = 10 to 40 mm) and ellipsoidal (major diameter = 30 to 50 mm) grounded electrodes were used to attract the discharges at gaps of 15 to 100 mm. The electrodes were attached to a brass pipe through which a flammable gas (5% propane in air which corresponds to the minimum ignition energy) entered the tank. A Perspex cylinder surrounded the electrode and served to contain the flammable mixture. Ignitions were obtained when the charge transferred in the sparks reached approximately $0.1 \mu\text{C}$. To achieve this level, it was necessary to charge the fuel surface to 58 kV for spherical electrodes and 62 kV for ellipsoidal electrodes. Based on these results, the authors advocated a maximum safe surface potential of 40 kV.

The data for the spherical electrodes, as depicted in Fig. 14, clearly show the flat minimum at 58 kV for incendive sparks. The lower curve on the figure corresponds to the potential at which sparks

Fig. 14 — Regimes of incendive and non-incendive sparks to spherical electrodes in propane/air of 5.0% propane by volume [36].

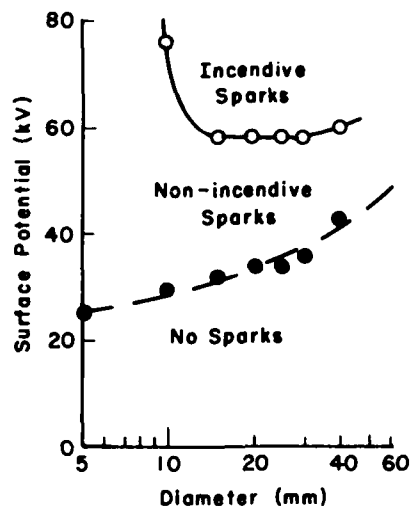

could just be detected at the smallest possible gap. This curve may also explain why some authors prefer a lower value for the maximum safe surface potential; apparently they feel that any spark is dangerous and therefore must be prevented.

Based on these studies, Krämer et al. [37] derived the following equations for predicting the maximum potential ζ_{0max} in a fuel tank during loading:

For top loading: $\zeta_{0max} = 4.8 Q/L$,

and

For bottom loading: $\zeta_{0max} = 7.2 Q/L$,

where

Q = The accumulated charge in the tank, μC ,

and

L = The diagonal of the midheight cross-sectional area.

The safe limit for filling velocity for top loading of tanks is:

$$Vd = 0.25 k_r^{1/2} L^{1/2},$$

where

V = filling velocity, m/s ,

d = diameter of filling pipe (m),

L = diagonal of midheight cross-sectional area of tank (m),

and

k_r = rest conductivity of fuel ($\rho S/m$)

For bottom filling, the value should be reduced by 18%.

Bruinzeel expresses the hazard in terms of the field strength required to produce an incendiary discharge; for a simulated aircraft fuel tank, the value is 500 kV/m [29]. Russian workers refer to the charge density on the fuel surface required to produce a spark discharge having the minimum ignition energy; values run from 5.5 to 10.6 $\mu\text{C}/\text{m}^3$, depending upon the fuel [39]. Attempts to calculate field strengths in tanks have been somewhat successful [36,37,40,41], particularly for idealized tanks. Krämer and Asano [36], for example, found excellent agreement between their calculated and measured field strengths in a cylindrical tank, Fig. 15. Their calculations of the potential distribution in a test tank (Fig. 16) led to the following expression for calculating the maximum surface potential in a tank in the absence of an electrode:

$$\phi_{surf} = 5.31 \rho$$

ϕ_{surf} = Maximum Surface Potential, kV

ρ = Inlet Charge Density

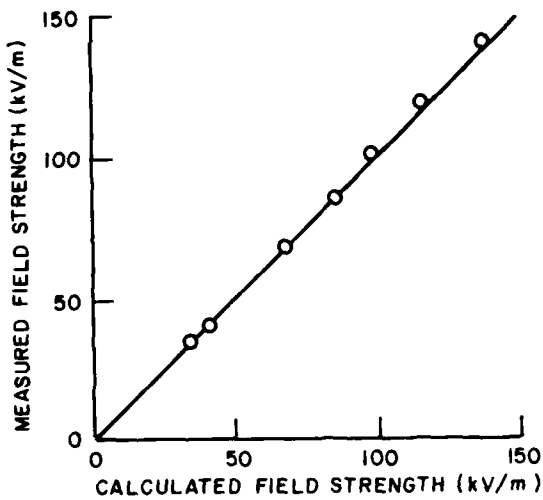
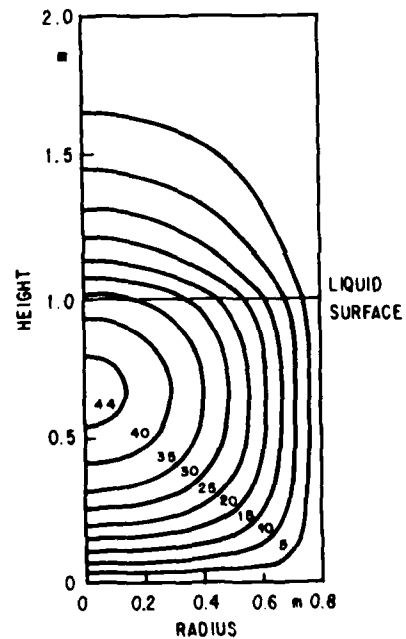

Fig. 15 — Field strength measured at the center of tank roof in comparison with the calculated value based on charge density of liquid [36]

Fig. 16 — Potential distribution in test tank (the equipotentials are given in kV, if the charge density in the liquid is 7.08 $\mu\text{C}/\text{m}^3$) [36]



How frequently does electrostatic charging of fuel get us in trouble? According to one survey [42] covering the period 1960 to 1969, there were 116 reported fires or explosions during tank trunk or refueler loading that were attributed to static electricity generated by the fuel. That's nearly one accident per month. Fortunately, the accident record during aircraft fueling has been somewhat better. As shown in Fig. 17, there were 12 incidents involving aviation gasoline during the period 1958 to 1963 [43]. During the period 1956 to 1963, there were eight incidents in Canada while refueling fighter-type aircraft with JP-4 fuel. Since then, the Canadians have been using a static dissipator additive in their jet fuel and have had no further incidents. There were three incidents involving commercial jet aircraft being refueled with kerosene-type fuels: one occurred in London in 1966 and the other two incidents happened in the United States in 1970.

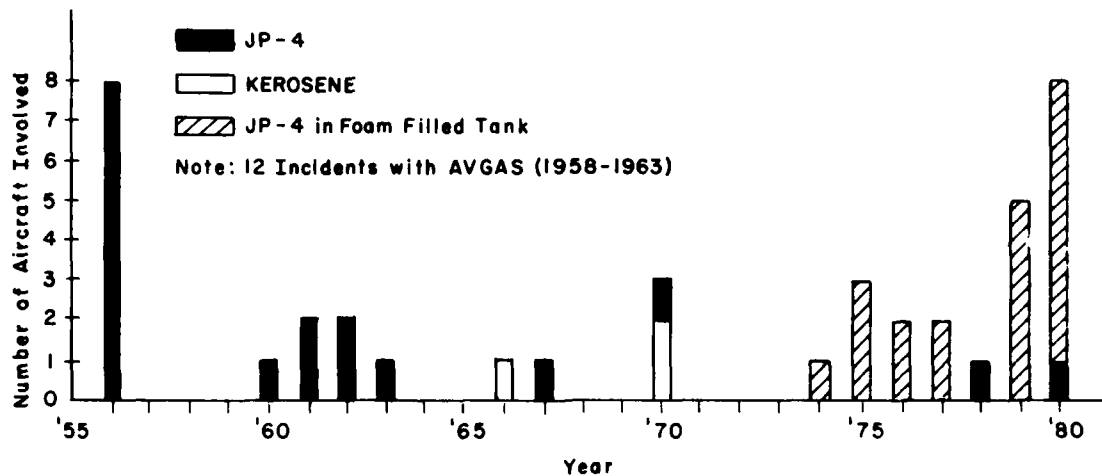

Fig. 17 — Aircraft accidents attributed to static electricity

During the late 1970's, the U.S. Air Force experienced 15 fires or explosions while fueling aircraft, the majority of which were equipped with polyurethane foam-filled tanks. (The foam acts like a three-dimensional flame arrestor to suppress ignition of the fuel vapors by incendiary projectiles.) Two of the incidents occurred during the initial fueling of new aircraft at the manufacturer's plant. In aircraft so equipped, the foam prevents propagation of the fire and so damage is minimal. However, since jet fuels are known to generate static electricity when passing through porous materials such as paper and fiberglass filter media, the possibility that the foam could have contributed to these accidents by serving as a static charge generating surface for the fuel was examined [44,45]. The study confirmed that:

- the foam is indeed a secondary charge generating surface for the fuel,
- the newly developed polyether foam generates about six times more charge than the polyester foams, and
- the conductivity of the fuel would have to be increased to at least 100 pS/m in order to protect aircraft fuel systems.

More recent work by Dukek et al. of Exxon [46] and Radgowski et al. of Fairchild [47,48] in large scale systems has confirmed the high electrostatic activity of the polyether foam as compared with the polyester foam. Also, additives were found to affect the charging tendencies of fuels on foam [49]. The results of the Exxon study indicate that in order to eliminate sparking in tanks filled with polyether foam, it is necessary to employ a multiple orifice fuel inlet device in addition to increasing the conductivity of the fuel to 50 pS/m or above. With the polyester foam, either the modified fuel inlet device or the increased fuel conductivity is sufficient to suppress discharges.

GENERATION OF CHARGE IN NONMETALLIC SYSTEMS

The introduction of a nonconductor, such as plastic or glass tubing, piping or tanks, into a fuel handling system, can significantly increase the electrostatic hazard. The implications for both the charge generation and charge separation processes will be considered for the following nonmetallic systems:

- 1) Plastic Tubing
- 2) Fiberglass Reinforced Plastic (FRP) or Glass Reinforced Plastic (GRP) Pipe
- 3) FRP or GRP Tanks

The manner in which charge separation occurs during the flow of a hydrocarbon liquid through a metal pipe is depicted in Fig. 1. If, on the other hand, the pipe is made of a nonconductor such as teflon, polyethylene or glass, then the charge cannot flow readily to ground. The relaxation of charge in such systems is dependent upon the resistivity on the inside surface of the pipe wall [14]. If the resistivity of the pipe (R_p) is very high, e.g., $R_p > 10^{14} \Omega \text{ cm}$, then the voltage on the inside of the pipe can build up to the point where breakdown can occur. Pinhole failures in teflon tubing have been attributed to electrostatic charging of JP-4 fuel flowing through the tubing [50,51]; the potential at which breakdown occurred was estimated at 50 kV. Other authors have reported discharges from teflon [52,53,54], glass [55], and Perspex tubing [56] when hydrocarbon liquids passed through. Even carbon dioxide has been shown to produce high voltages on bakelite and polyethylene fire extinguisher horns when the extinguishers were discharged [57-63].

Heidelberg [64] and Gibson and Lloyd [65,66] have demonstrated that discharges from nonconductors can ignite flammable vapors and gases. Leonard [60-62] has shown that sparks from a Bakelite horn of a CO_2 fire extinguisher can ignite vapors of n-heptane.

If an insulated charge collector, such as a hose clamp or a metal fitting, is attached to the plastic pipe, the ignition hazard is greatly magnified. This is because when a discharge occurs from a metal object, the entire capacitance of the object is discharged, whereas discharges from nonconductors involve only a limited area on the surface. As a consequence, discharges from metal objects are far more energetic than discharges from nonconductors.

Gibson [14] has found that charge generation in plastic tubes is considerably different from metal. For high resistivity liquids (10^{10} to $10^{12} \Omega \text{ m}$), the magnitude of the streaming current in polyethylene pipe decreases with time; for low resistivity liquids ($10^8 \Omega \text{ m}$) the streaming current is virtually constant as is the case in metal tubes for liquids of all resistivities (Fig. 18). The difference in behavior is attributed to the fact that with high resistivity liquids, the component of the charge that separates at the pipe surface cannot migrate quickly along the pipe and hence its presence impedes the progress of further charge separation. With low resistivity liquids the layer of conducting liquid adjacent to the pipe wall provides a leakage path to ground.

The measurements of charge density on the outside wall of polyethylene pipe support this hypothesis (Fig. 19). With high resistivity liquids, there is virtually no decay of charge after the flow has stopped whereas with low resistivity liquids, charge decay begins immediately after flow ceases indicating that the wetted inner surface provides a path to ground for the charge.

Fig. 18 — Current generated by liquid flow in polyethylene pipe. *P*, liquid resistivity: $10^{10} \Omega \text{ m}$; *Q*, liquid resistivity: $10^8 \Omega \text{ m}$ [14].

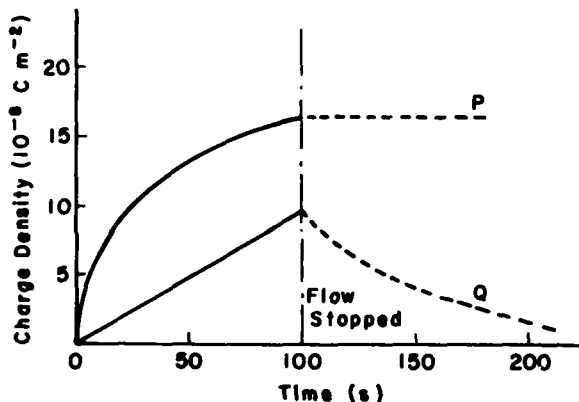
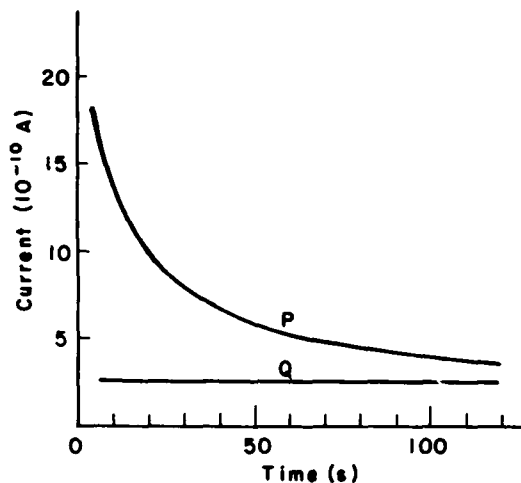

Fig. 19 — Charge density developed on polyethylene pipe by liquid flow. *P*, liquid resistivity: $10^{10} \Omega \text{ m}$; *Q*, liquid resistivity: $10^8 \Omega \text{ m}$ [14].

In 1973 Bachman and Munday [7] investigated the feasibility of employing FRP pipe in Air Force fueling systems. The specific questions addressed in this study were:

1. Does FRP pipe generate a significantly higher charge than metallic systems of a given pipe length and fuel velocity?
2. Does the charge generated in FRP pipe relax or dissipate at substantially the same rate as in metallic systems of equivalent size?
3. Is the bonding and/or grounding now prescribed for metallic systems of any value in systems fabricated of FRP pipe?
4. Are the velocity restrictions and the prescribed tank filling techniques, now mandatory on metallic systems, still required on FRP systems?

5. Are there any special techniques necessary for the safe transfer of aviation fuels from FRP systems to metallic systems (aircraft, trucks and storage) or from metallic systems to FRP systems?
6. In a typical metallic aviation fuel system (bulk storage to receiving aircraft), which components are the major contributors to the static electricity hazard problem? Does this list change when major portions of the system are converted to FRP material?
7. Is there presently available, or potentially available with a modest development program, a device or technique for minimizing the present hazard from static charge? If available, would this device or technique allow lifting the present restrictions on flow rate or at least raise the maximum flow allowed?

The program involved both a literature search and a test program in which FRP and metal pipes were compared. The literature search covered the period 1963-73 and included 71 abstracts of references dealing with electrostatic hazards in fuel handling systems. The literature indicated that there would be little difference in charge generation characteristics between FRP and metal pipe but that charge relaxation might be slower in the FRP pipe if its resistivity were sufficiently high. During that period, only one reference was found to charging in FRP pipe [67]. That study indicated some improvement in charge relaxation for kerosene in steel pipe as compared with FRP. Also, low intensity sparks were obtained when a grounding device was brought near the FRP pipe when the fuel was flowing.

The test program conducted by Bachman et al. involved a side-by-side comparison of nominal 6-inch diameter Bondstrand 2000 FRP and carbon steel pipes. Bondstrand was chosen because it had the highest volume resistivity (1.1 to $8.8 \times 10^{14} \Omega\text{cm}$) of the commercially available plastic pipes meeting the Air Force specification. The pipes were used in two test lengths: 24 and 72 m (80 and 240 ft). Jet A fuel having a conductivity range of 0.2 to 5.5 pS/m was used at flow rates from 1.135 to 5.677 m^3/min (3.1 to 15.6 ft/s). Filter/separators and/or Bendix GO-NOGO gages were used to charge the fuel for charge relaxation experiments.

It was found that charge generation in the steel pipes was low ($2.5 \mu\text{C}/\text{m}^3$ maximum) and even lower in the FRP pipe (0 to $0.5 \mu\text{C}/\text{m}^3$). For reference, charge densities below $30 \mu\text{C}/\text{m}^3$ are generally considered to be safe from the standpoint of ignition hazards except with very low conductivity fuels (0.4 pS/m) where the charge density would have to be less than $20 \mu\text{C}/\text{m}^3$ [11]. The rate of charge relaxation in the FRP pipe depended on the polarity of the fuel; with negatively charged fuel, it was 8% faster in the FRP pipe than in steel and 30% slower for positively charged fuel.

The fact that positively charged fuel relaxes more slowly in FRP pipe was seen to be a problem in systems employing a filter/separator. The data indicate that it would not be advisable to use FRP in place of steel if less than 30 s relaxation time is available between the filter/separator and the point of delivery. A relaxation time of 130 s was recommended for AF Hydrant systems employing FRP. Voltages of up to 55 kV were measured on the FRP pipe and sparks up to 1.27 cm (1/2 in.) long could be obtained from ungrounded metal components on the FRP pipe. These effects were not considered to be of concern in underground installations and methods of eliminating them above ground, such as proper bonding and grounding and use of conductive paints, were recommended. The filter/separator elements and fuel monitors were confirmed to be the components which generate most of electrostatic charge in fuel systems employing FRP, just as in all-metal systems.

The A.O. Smith Static Charge Reducer (SCR) was evaluated as a device for minimizing static charge in fuel handling systems. The SCR was found to be more efficient with positively rather than with negatively charged fuel, but plating out of deposits on the liner reduced its efficiency.

No further research on charging of fuels in FRP pipe was found in the literature for the period 1973-80. Tinson [68] studied charge generation when loading free-standing and road vehicle GRP tanks with kerosene and with gas oil. He found that potentials of up to 11 kV developed on insulated metal connections to the tanks and that sparks could be drawn from all metal connections with potentials above 1 kV. However, no discharges were detected from the surface of the tanks. He concluded that if provisions are made for proper bonding, there should be no difference in the electrostatic hazard during the loading of GRP tanks as compared with similar tanks made from conducting materials. However, Gibson [69] takes exception to this conclusion. He has found that discharges from polyethylene film can ignite flammable fuel/air mixtures and presumably, discharges from GRP and other tanks made of high resistivity material would also be incendiary, making GRP tanks more hazardous than tanks made of a conducting material.

The Royal Navy now has two classes of ships in which both the hulls and the fuel tanks are constructed of GRP [70]: HMS WILTON, a minehunter and HMS BRECON, a minehunter counter measures vessel (MCMV). With the advent of these ships, there has been considerable interest in charging of diesel fuel in GRP tanks [70-72]. Bolton [71] measured the field strengths in two 0.178 m³ (47 gal.) tanks, one made of GRP and the other of aluminum alloy, when the tanks were being loaded with diesel reference fuel ($k = 20$ to 30 pS/m) at flow velocities up to 8 m/s. The field strengths obtained in the GRP tanks were 3 to 4 times greater than in the aluminum tank, but the maximum value obtained (8 kV/m in the GRP tank) was still considered to be low. It was concluded from these tests that no electrostatic hazard is likely to occur during the fueling of the HMS WILTON, but this should be proved by actual tests on board.

In 1974 a full-scale ship refueling facility was built at Northam, England by the Applied Electrostatics Group, University of Southampton, in conjunction with the Admiralty Oil Laboratory, now the National Gas Turbine Establishment, Cobham [70,73,74]. The purpose of the facility, which is shown in Fig. 20; was to permit studies of electrostatic phenomena in GRP and metal tanks over a wide range of pumping speeds and fuel conditions, and to develop instruments to reduce static hazards during fueling.

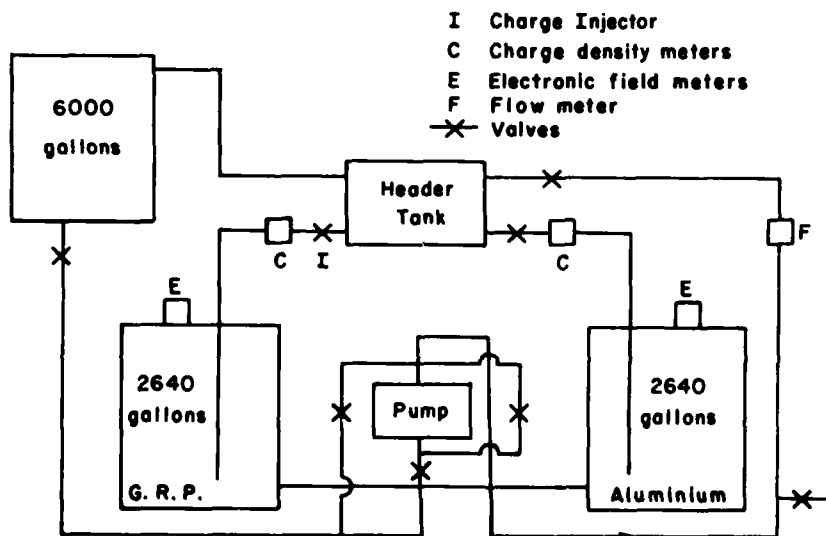

Fig. 20 - General arrangement of Northam Full Scale Refueling Facility [74]

The rig consists of two 10 m^3 (2640 gal.) tanks, one of GRP and the other of aluminum, with provisions for measuring the charge density on the fuel entering the tank and the field strength in the ullage space. A novel charge injection device was developed to control both the sign and the magnitude of the charge entering the tank [74-77]. Diesel fuel having a conductivity range of 10 to 30 pS/m was used as the test fuel.

Typical results obtained with this rig are shown in Fig. 21. Although the fuel had a relaxation time of 2 s based on its conductivity, the test results show that it took about 4800 s for the charge to relax in the GRP tank. For the the same fuel in a metal tank, the charge decayed completely in a matter of seconds. The increase in the field after the tank was filled was attributed to charge migration to the tank wall. A small, grounded, metal plate of area 1000 cm^2 was found to be very effective in discharging diesel fuel in the conductivity range of 10 to 30 pS/m in GRP tanks. The performance of this plate with low conductivity fuel has not been demonstrated. Based on tank filling experiments, it was established that the maximum permissible inlet charge density was about $125 \mu\text{C}/\text{m}^3$; if the inlet charge density exceeded this value, the voltage on the fuel surface reached 25 kV, at which point incendiary discharges could occur in the ullage space with negatively charged fuel. If the fuel was charged positively, the hazardous surface voltage was found to be 35 kV. Below 20 kV, the electric field caused the fuel to bridge the gap between the fuel surface and the grounded projection and no discharges took place.

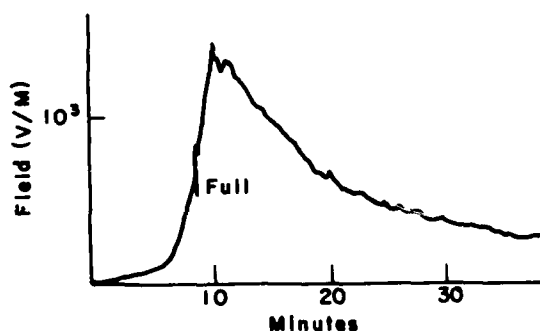

Fig. 21 — Field strength in a GRP tank during filling [74]

On two occasions when filling the GRP tank at $1.135 \text{ m}^3/\text{min}$ (300 gal./min) and with an inlet charge density of $100 \mu\text{C}/\text{m}^3$, very high energy discharges (10–50 J) were noted. These discharges were associated with the storage of charge at the base of the tank.

The effect of using a nonconducting, polyvinyl chloride (PVC) pipe for filling a GRP tank with diesel fuel is shown in Fig. 22. Two field meters were used to measure charge decay; one at the center of the tank (F_2) and the other near the fill-pipe (F_1). The results show that the field near the fill-pipe remained at a steady value ($\sim 8 \text{ kV}/\text{m}$) due to charge retention on the fill-pipe while the field at the center of the tank decreased to an immeasurably small value in about 7 s. According to Hughes, the use of a PVC pipe to fill a GRP tank with diesel fuel represents the worst combination of materials from the standpoint of electrostatic charging and charge retention [70]. On a number of occasions, extremely energetic sparks were recorded and located as tracking on the PVC pipe below the fuel surface when this combination was used. Had the discharges taken place above the fuel surface, and more particularly, in the foam layer, then the probability of ignition would have been greatly enhanced.

In-line devices have been developed by the Applied Electrostatics Group for monitoring charge levels and also for injecting or neutralizing electrostatic charge in fuel systems [76,77]. The monitoring device is essentially a relaxation chamber, electrically isolated from the surrounding pipework. By measuring the electrical current from the relaxation chamber, the charge density in the fuel can be determined.

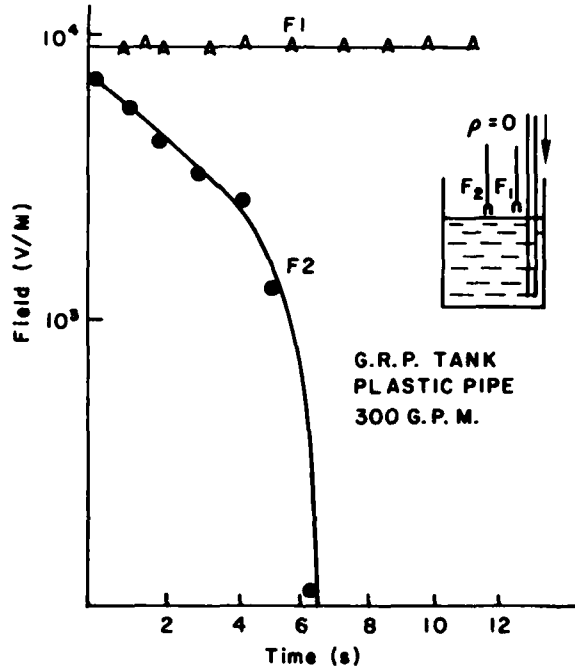

Fig. 22 — Field strength at two locations in a GRP tank when filling through a PVC pipe [74]

The charge injector employs two electrodes of different geometries connected to a high voltage source to produce a nonlinear field in the flowing fuel. Either pointed electrodes or flat metal plates (1 mm thick) can be used opposite an earthed plane to inject either positive or negative charges into the fuel.

By combining the charge monitoring and charge injector concepts, an in-line electrostatic discharger was developed (Fig. 23). Typically, the discharger is capable of reducing an incoming charge density of $150 \mu\text{C}/\text{m}^3$ on a diesel fuel flowing at $0.56 \text{ m}^3/\text{min}$ (150 gal./min) to $\pm 30 \mu\text{C}/\text{m}^3$ or less. The electrostatic discharger has been installed on both the HMS WILTON and the HMS BRECON to collect information on charge density during refueling. A prototype has been ordered by USAF for aircraft fueling trials using JP-4.

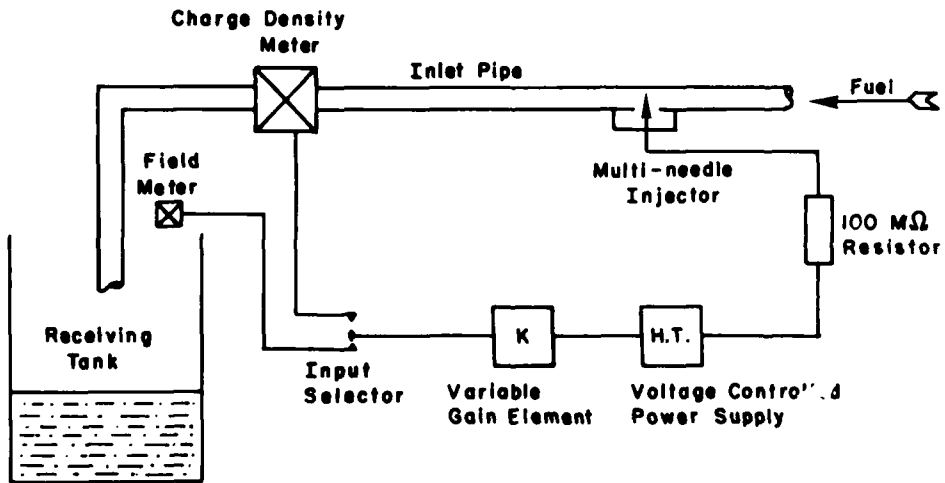

Fig. 23 — In-line electrostatic discharger

SOLUTIONS

The following solutions have been proposed to reduce or eliminate the electrostatic hazard during aircraft fueling or tank truck loading [3]:

- (a) Inerting the vapor space of the tank with nitrogen or other inert gases.
- (b) Installation of charge reduction devices.
- (c) Removal of the final filter/separator.
- (d) Reduction of flow rates.
- (e) Use of a static dissipator additive.

The FAA has investigated both cryogenic nitrogen and on-board nitrogen generation systems for inerting aircraft fuel tanks and a prototype system has been successfully flight-tested [78]. In addition, many commercial tankers use flue gas to inert tanks as a precaution against electrostatic charge generated by tank washing equipment. However, for many applications, such as tank truck loading and storage tank filling, cryogenic nitrogen poses a serious logistics problem and nitrogen generation equipment is too expensive.

In addition to the active, in-line discharging system discussed above [76,77] two types of passive, charge relaxation devices have been employed: a 30-s relaxation chamber, i.e., a baffled tank to hold the fuel for 30 s before delivery to a receiving tank, and the Static Charge Reducer (SCR). Relaxation tanks are used at some truck fill stands and are contemplated for Navy refuelers. The SCR, which was developed by A.O. Smith Corp. [79], consists of a 1-m (3-ft) long section of pipe with a plastic liner through which a number of pointed electrodes protrude. The electrical field generated by the flowing fuel produces corona discharges at the pointed electrodes which neutralize the charge in the fuel. Although the SCR has been found to be effective as a relaxation chamber (after a brief turn-on period) [9,80], if impurities from the fuel plate out on the liner, the SCR is rendered ineffective. The device is no longer manufactured.

Removal of the final filter/separator is an unacceptable solution since filtration is required to maintain the high standards of fuel quality required for jet fuels.

Reduction of the flow rate will decrease the amount of static charge generated by the fuel and also, in the case of top loading of tanks, minimize the hazards of splash filling. The American Petroleum Institute recommends: that during tank truck filling, if the downspout does not reach the bottom of the tank, the liquid velocity in the pipe be limited to about 1 m/s (3 ft/s) until the outlet is submerged. After the outlet is covered, the flow velocity may be increased to 4.5 to 6 m/s (15 to 20 ft/s) [23].

The most widely used approach is the static dissipator additive, primarily because of its low cost and high efficiency. Only 1 ppm or less is all that is required to increase the conductivity of a given fuel to 50 pS/m or above which is considered the safe range from the standpoint of electrostatic hazards [29]. Even with a fuel conductivity of 40 pS/m, the surface voltage in a receiving tank was found not to exceed 1 kV [81]. Most of the aviation turbine fuel used outside of the United States contains a static dissipator additive (Shell ASA-3).

Mainly as a result of its experience with polyurethane foam, the U.S. Air Force has changed the specifications for both JP-4 and JP-8 jet fuels to provide for an electrical conductivity additive to increase the conductivity of the fuel to within the range of 200 to 600 pS/m at the point of injection

[82,83]. Two additives, Shell ASA-3 and duPont Stadis 450, were found to be acceptable with JP-4 and JP-8 fuels. Both of the additives have been service tested at eight Air Force bases and recommendations were made with regard to additive injection points [84]. Only negligible effects were reported on fuel tank quantity gauges on F-15, F-16, A-7 and KC-135 aircraft with fuel conductivity up to the maximum use limit of 700 pS/m. As indicated previously, the higher conductivity levels are required to provide protection in tanks containing polyurethane foam [44-46,85-87]. So far, the specifications for JP-5 fuel [82] and for DFM [88] do not include use of an antistatic additive. Although the specification for the commercial jet fuels Jet A or Jet A-1 [89] does permit an antistatic additive, the additive is not in wide-spread use in these fuels as yet.

Based on limited fuel conductivity data obtained for kerosene derived from tar sands ($k = 0.271$ pS/m) and for JP-5 fuel derived from coal ($k = 0.288$ to 8.49 pS/m) and from shale ($k = 6.6$ pS/m), it would appear that fuels derived from alternate sources will probably require an antistatic additive to the same extent as their petroleum-based counterparts [90,91].

There is some recent evidence of interest in antistatic additives in the USSR [92,93] in compounds which increase the charging tendency of jet fuels [94-96] and in methods of measuring charging tendency [97]. One must assume that the Russians have had their share of electrostatic ignitions during fuel handling although references to specific incidents were not found in the literature. With the more widespread use of these additives, the incidence of fires and explosions attributable to static electricity in fuel handling should be greatly reduced.

ANNOTATED BIBLIOGRAPHY

1. E.F. Winter, "The Electrostatic Problem in Aircraft Fueling," *J. Roy. Aeronaut. Soc.* **66**, 429-46, (1962).

A review of basic electrostatic phenomena involved in handling hydrocarbon fuels is given. The generation of electrostatic charge is discussed as fuel passes through aircraft fueling equipment and the effects of filter type, fuel conductivity and flow rate are described. Field strength measurements were made in both simulated and actual aircraft wing tanks: valves in excess of 1400 kV/m were obtained with fuels having conductivities in the range of 1-2 picomho/m. Both corona and spark discharges were observed during fueling. Increasing the fuel conductivity to 50 picomho/m with Shell Anti-static additive ASA-3 was found to completely eliminate the static hazard in aircraft fueling.

2. K.C. Bachman and W.G. Dukek, "Static Electricity in Fueling Superjets," *Esso Research and Engineering Co.*, Linden, N.J., January, 1972.

A test program on static electrification of jet fuels carried out by Esso Research and Engineering Company has provided a high degree of assurance that high-speed fueling of superjet aircraft can be carried out safely. The program was conducted in a full-scale fueling rig which included the key section of an aircraft wing tank. A unique method was developed for measuring the energy in the spark discharges which occurred in the tank. The test results revealed that manifolding the tank inlet to distribute charged fuel is highly effective for minimizing the static hazard. With only normal aircraft components in the tank, no discharges could be produced under conditions simulating a manifold inlet. Under comparable conditions, discharges displaying energies of less than 0.06 millijoules, well below the minimum ignition energy of 0.26 millijoules for hydrocarbons in air at sea level, were detected when the tank was fueled through a single inlet if an unbounded charge collector were present in the tank; the maximum spark energy appeared to occur with fuel of about 3 picosiemens/meter rest conductivity. No incendiary sparks were detected with the unbonded charge collector present under conditions which represented filling through a manifold. (Author's Abstract.)

J. T. LEONARD

3. J.T. Leonard, "Principles of Electrostatics in Aircraft Fuel Systems," in *Lightning and Static Electricity Conference Papers*, Air Force Avionics Laboratory TR-72-325, Air Force Systems Command, Wright-Patterson Air Force Base, Ohio, 1972, p. 415-448.

A survey on the generation and dissipation of electrostatic charge during aircraft refueling. The types of discharges that can take place inside of aircraft fuel tanks during refueling are described and methods of eliminating them are discussed.

4. "Generation and Dissipation of Electrostatic Charge During Aircraft Refueling-A Selected Literature Survey," CRC Report No. 466, Coordinating Research Council, New York, NY, May 1974.

This survey was prepared by the Literature Survey Panel of the Electrical Discharges Liaison Group of the Coordinating Research Council, Inc. at the request of the Federal Aviation Administration.

The first section discusses the generation and dissipation of electrostatic charge in aircraft fuel systems and summarizes the results of the more pertinent research in this area. In the succeeding sections, brief abstracts are presented of research on the following topics:

- a) Charge generation during tank truck and fueller loading;
- b) Charge generation by hydrant carts and fuelers; and
- c) Discharges in simulated and actual aircraft fuel tanks.

The survey concludes with a review of accident experience in aircraft due to electrostatic discharges and a discussion of possible solutions to the problem.

5. W.G. Dukek, K.H. Strauss and J.T. Leonard, "Charge Generation by U.S. Commercial Aircraft Fuels and Filter-Separators," *1975 Conference on Lightning and Static Electricity Proceedings*, Session II, The Royal Aeronautical Society, London, 1975.

In 1970, two low-order static ignitions occurred at Minneapolis-St. Paul Airport during the fueling of identical aircraft belonging to different airlines. The accidents were attributed to an exceptionally electrostatically active filter medium which was subsequently withdrawn from service.

As a result of these incidents, a multifaceted program was carried out to:

- 1) Determine the electrostatic charging tendency and electrical conductivity of current jet fuels
- 2) Measure the electrostatic charging tendencies of various types of filter-separator elements
- 3) Measure the charge densities of fuels as delivered to the aircraft by hydrant carts and refuelers of six different airports in the United States

The conclusions from these studies are as follows:

- 1) The relative charging tendency of Teflon-coated screen separators is significantly lower than that of paper separators. When a large variety of fuels are considered, the charge output of screens is 13-52% as high as the output of paper separators.
- 2) Coalescers do not appear to have a significant effect on the charge output of two-stage filter-separators because the volume of the case permits little of the coalescer charge to reach the second stage separator.

- 3) Fuels display a wide variation in charging characteristics and can appear to overwhelm the charging tendency of filters unless a large number of different fuels are tested to separate filter from fuel effects.
 - 4) Among the 230 commercial jet fuels field tested in airport filtration equipment only one appeared to exceed the criteria established for a "high charging" fuel.
 - 5) A survey of 319 fuel samples from 10 commercial airports showed that the percentage of samples below 5 pS/m in rest conductivity has not changed substantially since 1962.
 - 6) The charging tendency of 230 fuels evaluated in the field and of 319 fuel samples measured in a laboratory test showed no relationship to their rest conductivity.
 - 7) When the laboratory charging tendency is corrected for filter media and system relaxation effects, the resulting calculated charge densities exhibit a distribution that closely matched the actual measurements made in airport equipment. The combined use of such a laboratory charging test and a conductivity test on fuels therefore provides an improved tool for predicting the charge output of fuels from commercial filtration equipment.
 - 8) Surface voltages generated by charged fuels in receiving tanks were proportional to input charge level but a reduction in flow did not produce an equivalent reduction in surface voltage.
6. A. Klinkenberg and J.L. van der Minne, "Electrostatics in the Petroleum Industry," Elsevier, Amsterdam, 1958.

An excellent monograph on electrostatic charge generation during fuel handling operations including a review of research conducted by Royal Dutch/Shell which led to the development of an antistatic additive for use in hydrocarbon fuels.

7. K.C. Bachman and J.C. Munday, "Evaluation of the Hazard of Static Electricity in Nonmetallic POL Systems—Static Effects in Handling Jet Fuel in Fiberglass Reinforced Plastic Pipe," Air Force Weapons Laboratory, Kirkland AFB, N. Mex. Report No. AFWL-TR-72-90, June 1973.

There is an increasing interest in fiberglass reinforced plastic (FRP) pipe for minimizing contamination in ground handling of aviation fuels. This report presents the results of a literature search and experimental study conducted to determine if static electricity hazards would be increased by substituting FRP for metal pipe in such systems. Experiments were conducted in 6 inch diameter, matched volume, carbon steel and FRP (Bondstrand 2000) pipes at four fuel conductivities between 0.2 and 5.5 CU and at flow rates between 200 and 1500 GPM at controlled temperatures. Charge generation in the pipes was low ($2.5 \mu\text{C}/\text{m}^3$ maximum with 0.9 CU fuel at 1200 GPM in steel); generation in FRP was generally less than in steel. Relaxation in FRP pipe depended on fuel polarity; on the average, relaxation was 8 percent faster, with negatively-charged fuel and 30 percent slower with positively-charged fuel than in steel. The slower relaxation should not prevent the use of FRP in Air Force hydrant systems handling JP-4 where a minimum of 2 minutes residence time is available downstream of filter-separators. Voltages up to 55 kv were measured on the FRP pipe and sparks up to 1/2 inch long could be discharged from ungrounded metal components on the FRP pipe. These effects should be of no concern in underground installations; methods for eliminating them in above-ground installations are recommended. An evaluation of the A.O. Smith Static Charge Reducer (SCR) showed that it was more efficient with

positively-than negatively-charged fuel and that deposit-buildup could reduce its efficiency. Available data suggest that static electricity hazards might exist downstream of an SCR although the average charge level is below $30 \mu\text{C}/\text{m}^3$. An annotated bibliography covering 71 recent, relevant literature articles is included. (Author's Abstract.)

8. J.T. Leonard and H.W. Carhart, "Static Electricity Measurements During Refueler Loading," NRL Report 7203, January 5, 1971.

Measurements have been made of the potentials developed on a fuel surface when loading refuelers at 300 and 500 gpm through 2-1/2-, 3-, and 4-in. hoses. The objectives in this study were to examine the effect of hose diameter and length on the level of charge on fuel entering a refueler and to provide an assessment of the electrostatic hazard that exists at a fill stand employing both a 30-second relaxation chamber and a bottom-loading capability. JP-5 fuel was used having a range of conductivities of 1.8 to 4.6×10^{-14} mhos/cm at 78°F. The results showed that at 500 gpm the maximum surface potential with the 2-1/2 in. hose was 32 kV whereas the values for the 3- and 4-in. hoses were in the range of 2 to 12 kV. The 2-1/2-in. hose was the only one tested at 300 gpm, but since the maximum surface voltages obtained were 1.3 kV or less, it was concluded that the values for the other hoses would be below the limit of detection with the equipment available. (Author's Abstract.)

9. J.T. Leonard and H.W. Carhart, "Reduction of Electrostatic Charge in Jet Fuels during Refueler Loading" NRL Report 7415; June 20, 1972.

A 30-second relaxation chamber and a static charge reducer (SCR) were evaluated for their effectiveness in dissipating the electrostatic charge during refueler loading of JP-5 fuel at flow rate of 300 to 540 gpm. The electrical conductivity of the JP-5 fuel was in the range of 0.1 to 10 C.U. at 78°F (1 C.U. = 1×10^{-14} mhos/cm). A JP-4 fuel with a conductivity of 7.8 C.U. was also tested to a limited extent. The experimental setup consisted of a 600-gpm filter/separator equipped with fuel monitors, a 30-second relaxation chamber and a static charge reducer located in parallel down-stream of the filter/separator, a 13-ft refueling hose (2-1/2-in. or 3-in. diameter), and either a 7050- or a 8200-gallon refueler. The charge density in the fuel was measured immediately downstream of the filter/separator, at the outlet of the relaxation device, and at the dry break or loading connection to the refueler. The results showed that both relaxation devices were capable of reducing the charge density in the fuel to below $30 \mu\text{C}/\text{m}^3$, which is considered to be the threshold for incendiary sparking. Differences in performance of the two relaxation devices were confined mainly to the low-conductivity fuel, where a greater reduction in charge density was achieved using the SCR than with the relaxation chamber. (Author's Abstract.)

10. K.C. Bachman, "Variables Which Influence Spark Production Due to Static Electricity in Tank Truck Loading," Proceedings of the 1975 Conference on Lightning and Static Electricity, Session II, The Royal Aeronautical Society, London 1975.

The data obtained in this program show that there are significant differences in spark generation particularly during splash loading which are related to inlet type, charge level in the fuel and the presence or absence of "charge collectors" (i.e., unbonded conductive objects) in the tank. Specifically, it was found that there is little if any hazard when distillates are splash loaded under normal conditions, that is without filters in the loading line and with no "charge collectors" present in the tank. A significant breakthrough was made, however, by showing that splash filling can generate a charged foam inside the truck, which in combination with a "charge collector," can cause discharge even when the fuel being loaded has a very low charge. Spark discharges are produced more easily when splash filling through a cone deflector, and a 45° inlet, since a cone provides a more intimate mixture of fuel and air and can produce more charged foam with a foam-prone fuel. Charged foam can buoy up and charge a lightweight "charge collector" to provide a spark source. This appears to be the key to why splash loading is hazardous. Accidents in the field tend to parallel the experimental observations. This suggests that most accidents may be due to the presence of "charge collectors."

Truck loading accidents due to static charging have been a long-standing concern to the petroleum industry. An analysis by Exxon Research and Engineering showed that at least 129 static-related truck loading accidents occurred from 1960 through 1973: 116 in the U.S., 13 in Canada or Europe. (Author's Abstract.)

11. A. Lewis and H. Strawson, "Static Electrification with Liquid Aviation Fuels: Its Occurrence and Suppression," 1975 Conference on Lightning and Static Electricity Proceedings, The Royal Astronautical Society, London, 1975, Session II, p. 1.

Inlet charge densities of $30 \mu\text{C}/\text{m}^3$ for top loading and $20 \mu\text{C}/\text{m}^3$ for bottom loading of tank trucks can produce incendive spark discharges with low conductivity ($0.4 \text{ pS}/\text{m}$) fuels. Such charge levels can easily be attained in pipe flow. With higher conductivity fuels, calculated charge densities appear to be too low to produce incendive discharges in the absence of a filter.

Certain compounds (polysulfones, amines and sulfonates) at concentrations as low as 1 ppm can increase the charging tendency of a fuel several hundredfold without a corresponding increase in conductivity. It is possible that the Montreal truck filling accidents could have been associated with some form of contamination which aggravated the generation of charges to a hazardous extent. Increasing the conductivity of a fuel to $50 \text{ pS}/\text{m}$ through the use of a static dissipator additive (Shell ASA-3) will prevent incendive discharges during aircraft fueling and tank truck loading.

Even when the fuel is treated with a static dissipator additive it is still necessary to bond electrically the fueling vehicle and the aircraft to equalize the static potential on each vehicle. The flow of electrically charged fuel during aircraft fueling represents the flow of electrical current in the microamp range between the two vehicles. If the fuel is highly charged and the hose material highly resistive, the outside of the hose can acquire a high potential. Tests have shown that under extreme conditions, including low temperatures, a conducting patch such as ice or a metal clip attached to the hose could give a spark of incendive energy to a nearby earthed object. The possibility of such sparking is avoided if the hose wire contains a buried loading wire, but where such wires provide a continuous low resistance path between the aircraft and the fueler, another hazard can exist. Earth faults on ground power supplies have been known to produce such heavy currents in these wires that the hose has been burnt through and the fuel ignited. The problem can be eliminated by providing a layer of conductive rubber in the outer layers of the hose make-up. The U.K. specification for this type of hose has a resistance requirement of 10^4 to $10^7 \Omega$.

12. W.G. Dukek, R.S. Lunt and D.A. Young "Evaluation of the Hazards of Static Electricity in POL Systems," Air Force Civil Engineering Center Report AFCEC-TR-76-1, January 1975.

Tests were conducted at air bases and in a full-scale rig to evaluate the hazards of static electricity in POL systems. Field testing at two air bases revealed a low level of charge in JP-4 fuel delivered to aircraft through DOD filter-separators. The low levels result from the high conductivity of JP-4 due to the presence of approved DOD corrosion inhibitor and the design of filter-separators which provide considerable residence time for charge relaxation. Single stage filter separator units were shown to generate less charge than older two-stage units. Teflon screens charged at about half the level of paper separators. Aluminum hydrant systems were found to have a lower charging tendency than carbon steel systems.

Tests in a full-scale rig showed that the surface voltage generated in tank truck filling is determined by the inlet charge regardless of the use of a Static Charge Reducer. Spark discharges were observed at very low surface voltage levels if charge collectors were present. Tests with JP-4 in FRP pipe showed that charge relaxation rates are the same as in steel pipe, a result contrary to tests with non-additive fuel. Tests in epoxy coated drums indicated that surface voltage relaxes at a rate equal to or greater than bare metal. (Author's Abstract.)

13. W.G. Dukek and K.C. Bachman, "Statische Elektrizität bei der Schnellbetankung von Flugzeugen," Erdöl und Kohle-Erdgas - Petrochemie 25, 146 (1972).

Static electricity in high speed fueling of aircraft: a full-scale fueling facility was built at the Esso Research center in 1969 to investigate static generation in commercial filters and static discharge in a simulated wing tank of a superjet. The unique feature of this facility is the ability to study the ignitability of spark discharges under well-controlled conditions in both an aircraft and a tank truck environment. Current operating practices in loading trucks and fueling aircraft may be affected by research results. (Author's Abstract.)

14. N. Gibson, "Static in Fluids," Static Electrification, 1971, The Institute of Physics, London, 1971, p. 71.

This introductory paper reviews recent work on the electrification of fluids and discusses the topics of current interest.

Recent data on the electrification of liquids flowing in metal pipes are considered and it is concluded that the order of magnitude of the streaming current generated during the turbulent flow of high resistivity liquids can be calculated from a knowledge of certain readily determined parameters. The effect of contaminants, pipe diameter and flow velocity on electrification is also discussed. Liquid flow in nonconducting (plastic) pipes is discussed and shown to be of theoretical and practical significance.

Charging by spray electrification and the release of liquids from high pressure systems is considered with particular reference to the possibility of incendive discharges from droplet clouds.

A charge "neutralizer" that reduces the charge density on liquids to a safe level without the use of ionic additives is described. (Author's Abstract.)

15. A.N. Zhukov, "Streaming Current Studies in Nonpolar Liquids," Vestnik Leningradskogo Universiteta, No. 10, 121 (1968)

The results of an investigation of electric charge generation in hydrocarbon liquids (petrol ether with very small quantities of sodium dibutyl-naphthalinsulfate) flowing through the tubes are presented. The experimental data lead to the conclusion that the mechanism of this phenomenon consists of two processes: that of removing the external part of a double layer charge and the process of electrofiltration caused by the electrification of the tube itself. (Author's Abstract.)

16. A.A. Obukh, B.K. Maksimov, M.A. Zubov, "Electrification of TS-1 Fuel as it is Pumped into the Tanker," Tekhnika Vysokikh Napryazheniy, 143 (1972)

The authors have modified Koszman and Gavis' equation for calculating the streaming current in pipe flow to include a more precise determination of the diffusion film thickness and consideration of pipeline roughness. Streaming currents calculated by the refined formula are about 6 times greater than the experimental values obtained by pumping TS-1 (wide cut) jet fuel through a steel pipeline 100 mm in diameter.

17. N. Gibson and F.C. Lloyd, "Electrification of Toluene in Pipeline Flow" in "Static Electrification," The Institute of Physics and The Physical Society, London 1967, p. 89.

The electrification of toluene flowing in stainless-steel pipelines at velocities in the range 1-10 m sec⁻¹ has been measured in a large-scale pipeline system (2275 l. capacity, pipelines 1.62, 2.88, 5.39, 8.35 and 10.90 cm diameter and 29 m long). The experimental data, which show the dependence of electric

current on such parameters as flow velocity, pipe diameter and pipe length, are used to test the validity of the Koszman and Gavis and Gibbins and Hignett equations relating these parameters.

It is shown that these equations will require further development before they can be used to predict accurately electrification in large-scale systems. Empirical equations of the form $i_{\infty} = Kf(V,d)$ have been developed from the data, and an 82.5% fit can be obtained between calculated and experimental values of i_{∞} once the value of K and the form of the function have been established for a given liquid/pipeline system.

18. I. Liebman, I. Spolan, J. M. Kuchta, and M. G. Zabetakis, "Ignition of Tank Atmospheres during Fuel Loading Operations," Final Report No. 3914, U. S. Bureau of Mines, Pittsburgh, Pa., 1964.

An investigation was made to determine the formation, persistence, and ignition energy requirements of flammable zones which occur in the vapor space of fuel tanks during fuel loading. These flammability studies were made using JP-4, gasoline, and kerosine fuels which were loaded into a 2.4-cu-ft cylindrical tank or a 22.5-cu-ft simulated aircraft wing tank. The extent and duration of flammable zones was found to be dependent on fuel vapor pressure, temperature, flow rate, fuel inlet, and tank dimensions.

19. B. Lewis and G. von Elbe, "Combustion, Flames and Explosions of Gases," 2nd ed., Academic Press, New York, 1961, p. 323.

This basic reference book covers the following areas: chemistry and kinetics of the reactions between gaseous fuels and oxidants, flame propagation, state of the burned gas and problems in technical combustion processes including industrial heating and internal combustion engines.

20. A.R. Lyle and H. Strawson, "Estimation of Electrostatic Hazards in Tank-Filling Operation," in "Static Electrification, 1971" Institute of Physics, London, 1971, p. 234.

To provide information on safe filling rates for road and rail tank cars, measurements have been made of the charge density in fuel during the 'initial' stages in top filling of a compartment of a road vehicle tank and of the energy contained in consequent electric discharges.

The energies of the sparks were estimated using a photomultiplier. The spark energy was found to be dependent on the charge density of the incoming fuel, the fuel flow rate and the distance of the drop tube outlet from the bottom of the tank. Negligible charge was generated by splashing of the fuel. (Author's Abstract.)

21. "A Survey of Electrical Conductivity and Charging Tendency Characteristics of Aircraft Turbine Fuels," CRC Report 478, Coordinating Research Council, New York, N.Y., April 1975.

A survey was made of the electrical characteristics of jet fuels at ten airports and three military bases in the United States. A total of 410 samples representing 338 commercial Jet A and A-1, 54 JP-4 and 18 JP-5 fuels were taken covering the winter and summer of 1973. The conductivity of commercial fuels covered the range 0.09 to 40.5 picosiemens/meter (pS/m) with 80% below 10 pS/m and 30% below 1 pS/m. Compared with earlier surveys, no substantial change in conductivity was observed for commercial fuels. There is a trend toward higher conductivity in military fuels.

Charging tendency of commercial fuels measured in a laboratory test covered a wide range (34 to 5940 microcoulombs/cubic meter ($\mu\text{C}/\text{m}^3$)) but when the test results were adjusted for filter media and relaxation effects it was found that the survey data were comparable to field data. There was no relationship between conductivity and charging tendency but the usefulness of both tests in combination to predict field performance was illustrated.

The average water content of samples ran higher in the summer than in the winter. Increasing the dissolved water content had an unpredictable effect on conductivity but increased the charging tendency of 90% of the samples.

22. W.M. Bustin, I. Koszman and I.T. Tobbye, "New Theory For Static Relaxation in High Resistivity Fuel," *Hydrocarbon Process.* **43**, 209 (1964).

The physical assumptions on which the ohmic theory is based are invalid for very high resistivity fuels. A new theory based on a realistic physical model has been developed. This theory predicts much faster relaxation than the extrapolated ohmic theory.

Experimental studies, first in the laboratory and then in full scale tank truck loading equipment, have confirmed the new theory. An average of 60 percent charge removal occurred in 30 seconds in an 8 inch pipeline. This is substantially better than the few percent predicted by the ohmic theory. Initial relaxation is very quick, but there is a tapering off of the rate with time making additional relaxation time of less value.

The full scale tests showed that filter current generation is less with high resistivity fuel. However, on the contrary side, the electrostatic field produced in the tank truck by a given current is greater. The net result is that sparking conditions are more closely approached. Unfortunately, the conditions which produce sparks in fuel tanks and the incendiary nature of these sparks have not been adequately studied. Consequently, experimental data now available does not establish how much relaxation is needed to prevent an ignition.

Accident experience to date supports 30 seconds. For the past few years, fuels of resistivity greater than 10^{14} ohm-cm have been occurring in some locations where 30 seconds relaxation is in use and no accidents have resulted.

Considering all the evidence, it appears that provision of at least 30 seconds relaxation is still beneficial. Any further work on this problem should center on the phenomenon of sparking itself. (Author's Abstract.)

23. "Recommended Practice for Protection Against Ignitions Arising Out of Static, Lightning and Stray Currents," American Petroleum Institute, Washington, D.C., Third Edition, 1974.

Recommended practices are presented to prevent static ignitions during the loading of tank trucks, tank cars, drums, cans, aircraft, tankships, barges, and storage tanks with petroleum products. Also, precautions against hazards of lightning and stray currents in the petroleum industry are given.

The conductivity of new GRP tanks used for above ground storage of petroleum products may be 100 times as great as the product being handled. Upon exposure to the weather, it is expected that the conductivity will increase further.

In tests involving pumping of fuel into GRP tanks, potentials as high as 11 kV were measured on metallic fittings on the tank and visible sparks, believed to be incendiary, were observed. Even ungrounded objects not actually connected to the tank could be charged by induction if they were in close proximity to the tank. Hence it is necessary to bond and ground all metallic objects attached to or in proximity of GRP tanks.

24. J.T. Leonard and H.F. Bogardus, "Pro-Static Agents in Jet Fuels," NRL Report 8021, August 16, 1976.

The effects of a wide variety of polar compounds and fuel additives on both the electrical conductivity and electrostatic charging tendency of both silica gel treated *n*-heptane and Jet A fuels have been examined. Conductivity was determined by ASTM D3114 and charging tendency by measuring the current developed as the hydrocarbon liquid passed through an electrically isolated filter holder containing a paper, fiberglass or teflon screen filter.

Of all the compounds and additives tested, water came closest to fulfilling the definition of an ideal pro-static agent, viz, a compound that greatly increases the charging tendency of a fuel without increasing its conductivity. After saturation with water, the charge density of clay-treated Jet A fuel increased by a factor of 23 and that of an untreated Jet A by a factor of 7. The conductivities of both fuels remained essentially the same. Since water did not increase the charging tendency or conductivity of silica gel-treated *n*-heptane it was concluded that it is not water per se, but rather its interaction with some constituent in the jet fuel that is responsible for its pro-static effect.

25. J.T. Leonard, "Pro-Static Agents in Jet Fuels," in Third International Congress on Static Electricity," Societe de Chemie Industrielle, Paris 1977, p. 18.a.

The effects of a wide variety of polar compounds and fuel additives on both the electrical conductivity and electrostatic charging tendency of both silica gel treated *n*-heptane and Jet A fuels have been examined. Conductivity was determined by ASTM D3114 and charging tendency by measuring the current developed as the hydrocarbon liquid passed through an electrically isolated filter holder containing a paper, fiberglass or teflon screen filter.

Of all the compounds and additives tested, water came closest to fulfilling the definition of an ideal pro-static agent, viz, a compound that greatly increases the charging tendency of a fuel without increasing its conductivity. After saturation with water, the charge density of clay-treated Jet A fuel increased by a factor of 23 and that of an untreated Jet A by a factor of 7. The conductivities of both fuels remained essentially the same. Since water did not increase the charging tendency or conductivity of silica gel-treated *n*-heptane it was concluded that it is not water per se, but rather its interaction with some constituent in the jet fuel that is responsible for its pro-static effect. (Author's Abstract.)

26. A.A. Gureev, V.M. Tugolukov, O.A. Burmistrov, and E.M. Bushueva, "Effect of Additives of Different Functionality on the Electrification of Liquid Hydrocarbon Fuels," Khim. Tekhnol. Topl. Masel. 18(6), 47-8 (1973).

The effects of various additives (Fuel System Icing Inhibitor, Corrosion Inhibitor, Antioxidant, Dispersant, Metal Deactivator, Antiwear Additive and Antistatic Additive) on both the electrical conductivity and electrostatic charging tendency of jet fuels T1, TS-2 and T-7 were determined. The charging tendency was measured by determining the voltage build up on an insulated fuel reservoir when the fuel was stirred with a fluoroplastic disc. All of the additives tested with the exception of two icing inhibitors and one corrosion inhibitor increased the charging tendency of the fuel, some more than two fold. Fuels containing different additives may have the same electrical conductivity but different charging tendencies. The conductivities of the untreated fuels were in the range of 1.6 to 10 pS/m.

27. V.I. Primenko and O.E. Poboiskii, "Effect of Dissolved Water on the Static Charging of Jet Fuels," Khim. Tekhnol. Topl. Masel. No. 1, 25-6 (1976).

The charging tendencies of jet fuels T-1, T-7 and TS-1 were measured in a stainless steel tube (diam. = 1 mm; length = 2 m) as received, after drying in a desiccator and after equilibrating with ambient humidity. Drying was found to decrease the electrical conductivity, to increase the charging tendency

of three out of the four fuels tested and to change the sign of the charging current from plus to minus. The effects of moisture on the charging tendency of fuels in tubes is not as pronounced as in filter charging.

28. S.T. Usatenko, V.I. Morozov, and O.V. Sovchuk, "Effect of Diffuse Daylight on Electrical Conductivity and Static Charging of Hydrocarbon Fuels," *Khim. Tekhnol. Topl. Masel.* No. 8, 35 (1976).

Exposure to daylight effects the charging tendency of jet fuels, e.g., commercial kerosine T-1 fuel gives nearly a twofold reduction in charging potential, with the biggest changes occurring during the first 10 minutes of exposure. Similarly, the electrical conductivity was found to increase on exposure to daylight.

29. C. Bruinzeel, "Electric Discharges During Simulated Aircraft Fueling," *J. Inst. Petrol.* **49**, 473 (1963).

Large-scale tests have shown that when highly refined aviation fuels are pumped through microfilters and hoses into aircraft wing tanks, potential gradients may develop inside which easily exceed the spontaneous breakdown value.

Electrical discharges near the air-fuel interface in the vicinity of tank inlet systems were often observed throughout a simulated fueling operation. The occurrence and nature of these types of discharge have now been more closely observed in a mock-up of a fueling installation and receiving tank. Results indicate that the most critical periods appear to be the first stage of the fueling operation and the stage in which the tanks are nearly full.

The energy content of the discharge was found to vary from below 0.2 millijoules (the minimum required for ignition) up to several tens of millijoules. Their duration varied from a few microseconds down to a fraction of a microsecond. The incendiary nature of these sparks was demonstrated in certain tests. Photographic techniques were used for recording and studying charging conditions inside a tank and the discharge mechanism.

The sparking phenomena have further been investigated as a function of increasing fuel conductivity. It was observed that sparking in the first stage of a filling operation was the more difficult phenomenon to suppress. The results indicate that with present-day fuel handling facilities and under severe fueling conditions a fuel conductivity of at least 50 picomho/m is required to prevent all sparking hazards.

In practice, a dangerous condition will result from the existence of an inflammable vapour/air mixture at the same time and place as the occurrence of a spark of sufficient energy to ignite this mixture. It has to be remembered that in the course of millions of fueling operations of *civil* aircraft no explosions have yet occurred due to the discharge of static electricity generated during the fueling operation. However, in view of the results of the tests described here, this does not justify complacency, though it perhaps puts the situation into perspective. The present work indicates that under certain conditions dangerous discharges could arise, and thus confirm the need to investigate means of controlling the generation of static electricity during the fueling of aircraft.

30. J.T. Leonard and H.W. Carhart, "Electrical Discharges From A Fuel Surface," in "Static Electrification." Institute of Physics and the Physical Society, London, May, 1967, p. 100.

The nature of the electrical discharges taking place between a charged hydrocarbon-fuel surface and earthed probes of various configurations has been studied in a laboratory-scale apparatus. Fuel was circulated through a pump, filter and tank arrangement to produce electrical breakdown in the vapour space of the tank at gaps as large as 15 cm. Measurements were made of the total charge transferred

and the duration of individual discharges as a function of gap width and earthed-probe geometry. True spark discharges occurred only at small gaps (up to 2.5 cm) with both pointed and small spherical electrodes. At larger gaps these electrodes gave corona discharges. However, with larger spherical electrodes and larger gaps, a phenomenon was observed which has not been described in fuel studies. Discharge now occurred by means of pre-breakdown streamers which never made the transition to filamentary sparks. The duration of individual discharges under these conditions was as much as seven times longer than for filamentary sparks for the same total charge. Hence the transfer of energy per unit time was much less. Photographic records showed that even at a 15 cm gap the streamers were highly luminous for only about 2 cm below the electrode before breaking up into a highly branched structure which faded out well above the surface of the fuel. The frequency of pre-breakdown streamers was found to vary with the charging tendency of the fuel, which, in turn, was related to the nature of the filter, the pumping rate and the conductivity of the fuel. As many as 100 streamers occurred per minute under optimum conditions. This mechanism of dissipation of field strength in a fuel system by repeated pre-breakdown streamer discharges prevents the build-up of sufficient potential to allow filamentary sparks to occur. Because of the smaller concentration of energy in both space and time released by the pre-breakdown streamers, they are considerably less incendiary than spark discharges. (Author's Abstract.)

31. I.G. Haig and A.W. Bright, "Experimental Techniques for the Study of Surface Discharges from Hydrocarbon Fuels," in Third International Congress on Static Electricity, Societe de Chemie Industrielle, Paris, 1978, p. 29a.

A special apparatus was built for studying the incendivity of discharges from a fuel surface to a grounded electrode. Using a charge injector (brass needles in the fuel stream connected to a high voltage source), it was possible to charge the fuel up to $500 \mu\text{C}/\text{m}^3$, which corresponded to a surface voltage above 40 kV, while controlling the sign of charge. A propane/air mixture in the electrode chamber above the fuel surface was used to determine the incendivity of the discharges.

With negatively charged fuel, two types of discharges were observed: pre-breakdown streamers, which consisted of a bright channel extending about 1/4 the distance of the gap before breaking down into highly branched structure, and a spark discharge which resembled the pre-breakdown streamer but was much brighter. Discharges were always accompanied by Taylor cones, i.e., small conical distortions of the surface of the liquid due to the electric field.

With positively charged fuel, only corona discharges were obtained even at surface voltages up to 35 kV.

Ignitions were obtained with negatively charged fuel at gaps above 1 cm but since pre-breakdown streamers and spark discharges could not be observed independently, it was not possible to determine if both are capable of producing ignition. At a given gap length, less than half of the discharges had energies in excess of the minimum ignition energy of 0.26 mJ. No ignitions were obtained with the positively charged fuel.

At gaps of less than 1 cm, discharges did not take place due to liquid bridging.

32. R.E. Hertzog, "Fuel Conductivity and Truck Loading Safety," Preprint No. 08-67 of Paper presented at the American Petroleum Institute's Division of Refining Meeting, Los Angeles, Calif., May 15, 1967.

In the absence of filters, the electrostatic charge which accumulates in tank truck compartments during loading of #2 fuel depends on flow rate, length of drop tube, and the product conductivity. Data are presented showing that current industry precautions may be inadequate when loading low conductivity fuels into trucks which have previously held gasoline. Injection of a conductivity improving additive

into the fuel was found to reduce the potential hazard substantially. From a technical standpoint, the additive may be injected into the fuel at any point in the product distribution system between the refinery and the truck loading rack. From the standpoints of reliability and simplicity, such injection should be done prior to shipment of the product from the refinery. Data are presented showing that normal terminal storage conditions cause little change in the conductivity of doped fuels. However, the conductivity changes which occur while the product is in transit through the distribution system depends on the mode of transportation used. (Author's Abstract.)

A surface potential of 1000 volts is considered the upper limit for safe loading since formation of an incendiary spark should be impossible at this level.

33. E.C. Summer "Preventing Electrostatic Ignitions," Paper presented at the API Central Committee on Safety and Fire Protection Meeting, Tulsa, Okla., April 20, 1967.

A review of the factors governing the generation and dissipation of electrostatic charge in fuel handling operations. The effects of spraying, splashing, filtration, flow velocity, gaging, probes, insulated conductive objects, etc. are discussed as are the requirements for bonding and grounding. Recommendations are presented to minimize static charge generation during the filling of storage tanks, tank cars, tankers, barges and small containers.

34. W.L. Bulkley and I. Ginsberg, "How to Load Distillates Safely," *Hydrocarbon Process.* 47 121 (1968).

Most tank truck loading accidents are caused by internal sparking during loading of intermediate vapor pressure fuels, such as JP-4, or switch loading of low vapor pressure distillate fuels. Surface voltage on the oil must exceed 20 kv to initiate sparking to internal members found in tank trucks; higher voltages are necessary for the sparks to be incendiary. In an enclosure of the size and configuration of a tank truck compartment, surface voltages of this magnitude require a charge density in the oil of about 30 microcoulombs per cubic meter at the most critical depth of liquid.

Modern, highly refined distillates have long relaxation times and the filters now commonly used are prolific charge generators, so the necessary conditions for internal sparking are more readily attained now than in previous years.

35. H. Strawson and A.R. Lyle, "Safe Charge Densities for Road and Rail Tank Car Filling," in *Static Electrification 1975*, The Institute of Physics and the Physical Society, London 1975, p. 276.

Studies have been made to determine the conditions under which incendiary sparking could occur during filling of road and rail tank cars. Direct observations of the sparks were made using an image intensifier while a photomultiplier, previously calibrated on liquid/metal sparks in the Laboratory, was used to estimate whether or not the sparks were incendiary.

A mathematical model employing computer calculations of potential is shown to agree reasonably well with the experimental results. By combining the model with the results, maximum safe inlet charge densities are obtained as a function of tank dimensions, filling rate and electrical conductivity. A method by which the values for inlet charge density may be used to determine recommendations for safe filling rates is also described. (Author's Abstract.)

36. H. Krämer and K. Asano, "Incendivity of Sparks From Surfaces of Electrostatically Charged Liquids," *J. Electrostat.* 6, 361 (1979).

Hydrocarbon liquids prone to electrostatic charging may accumulate a considerable charge in the liquid of a tank being filled eventually leading to a spark in the possibly flammable atmosphere of the tank.

As an important step in the assessment of the hazard, this paper studies the discharges between an earthed metal electrode and the surface of a charged liquid in particular with respect to the incendivity of the occurring sparks in a propane/air atmosphere which may be taken as representative of the tank atmosphere containing hydrocarbon vapour.

Using a variety of spherical electrodes with diameters ranging from 10 mm to 40 mm as well as ellipsoidal electrodes of 50/25 mm and 30/15 mm dia., ignition could be obtained when the charge transfer in the sparks was raised to approximately the same level of the order of $0.1 \mu C$. To achieve this it was necessary to charge the liquid surface to a potential of 58 kV for spherical and 62 kV for ellipsoidal electrodes. Based on these results and making some allowance for a safety margin it is advocated that a surface potential exceeding ca. 40 kV should be regarded as potentially hazardous in tank filling operations. (Author's Abstract.)

37. H. Krämer, K. Asano, G. Schön, "Criteria for Safe Filling of Tank Vehicles - Theoretical and Experimental Studies to Assess the Electrostatic Hazard in Third International Congress on Static Electricity," Societe De Chemie Industrielle, Paris, 1977, p. 31a.

Based on computational and experimental results, the following equations were derived for predicting the maximum safe potential in a fuel tank $\zeta_{o \max}$ during loading:

$$\text{For top loading: } \zeta_{o \max} = 4.8 Q/L$$

$$\text{For bottom loading: } \zeta_{o \max} = 7.2 Q/L$$

where Q = The accumulated charge in the tank, μC

L = The diagonal of the midheight cross-sectional area

The onset potential for the first occurrence of sparking was found to increase with the radius of the probe to which the sparks were taking place. If the radius of the probe is less than 5-7 mm, the discharges will not ignite a flammable fuel/air mixture. The critical surface voltage, i.e. the voltage above which incendiary discharges can take place was found to be 40 kV.

Fuels with conductivities below $0.8 \mu S/m$ do not produce sufficient charge when flowing through pipes to constitute a hazard.

Where filtration is used, a residence time downstream of the filter/separator in excess of 100 s may be needed for safe operation.

The safe limit for filling velocity for top loading of tanks is:

$$Vd = 0.25 k_r L^{1/2}$$

where V = filling velocity, m/s

d = diameter of filling pipe (m)

L = diagonal of midheight cross-sectional area of tank (m)

k_r = rest conductivity of fuel ($\mu S/m$)

For bottom filling, the value should be reduced by 18%.

38. A.W. Bright and I.G. Haig, "Safety Criteria Applicable to Loading of Large Plastic Fuel Tanks," IAS '77 Annual, 1065 (1977).

In metal tanks, the decay of charge on a fuel surface is governed by the electrical conductivity of the fuel. However, in plastic tanks, charge decay depends on the conductivity of the plastic. Electric fields

can persist in the ullage space of plastic tanks for periods of 1 hour after filling even though the relaxation time of the fuel is only about 1 second.

The paper describes tests in an experimental rig in which diesel fuel was loaded into aluminum and glass reinforced plastic tanks (2,500 Imp. gal.) through 2"-6" diam. pipes. Good correlation was found between the inlet charge density, ρ , and the voltage on the fuel surface, V_s .

The following preliminary conclusions were drawn with reference to loading plastic tanks with hydrocarbon fuels:

1. A surface potential of about 25 kV for negatively charged fuel and about 35 kV for positively charged fuel must be regarded as hazardous.
 2. In general ρ is proportional to V_s and a maximum safe value will apply to a given tank. For the 2400 gallon tanks a maximum safe value of ρ for negative fuel is about $150 \mu C/m^3$.
 3. As it is almost impossible to predict ρ , the use of charge density meters at the inlet to the tank is recommended.
39. V.V. Zakharchenko and V.S. Zhuravlev, "Electrostatic Discharges from the Surface of Hydrocarbon Fuels," *Khim, Tekhnol, Topl. Masel*, (4), 50-2 (1975)

Discharges from fuel surfaces to a grounded electrode were studied by placing an electrode connected to a high voltage supply beneath the surface of the fuel. The charge density on the fuel surface required to produce a spark discharge with the minimum ignition energy was found to be in the range of 5.5 to $10.6 \mu C/m^3$, depending on the fuel. Values are given for gasoline, jet fuel, benzene, xylene, toluene and cyclohexane.

40. J.A. Carruthers and K.J. Wigley, "The Estimation of Electrostatic Potentials, Fields, and Energies in a Rectangular Metal Tank Containing Charged Fuel," *J. Inst. Petrol.* **48** 180 (1962).

There is a fundamental need of methods for the estimation of electrostatic quantities occurring inside a fuel tank, from measurements made at particular points in the tank, e.g. the tank roof.

The complete calculation of the potential and field patterns inside a rectangular metal tank partially filled with charged fuel is presented in the form of a double infinite Fourier series. It would be possible to sum this series to a high degree of accuracy using a digital computer, but for practical applications single term approximations for fields, potentials, and energies have also been derived which are simple and convenient to use. Detailed comparison is drawn between field estimates calculated using this approximate expression and field values measured in a simulated aircraft fuel tank compartment during fueling experiments. Agreement is found to be satisfactory for most practical purposes.

The calculations have been extended to include the important effects of surface charge on the electric fields in the vapour space of a tank. Fields produced by charged mists have also been considered and compared in magnitude with fields produced by charge distributed in liquid fuel. (Author's Abstract.)

41. B.K. Maksimov, A.A. Obukh, A.A. Navatskiy, V.A. Mokryshev "An Electrical Field in the Reservoir of a Fuel Tank as it is Filled with Electrified Fuel," *Tekhnika Vysokikh Napryazheniy* 138 (1972)

The authors used Carruthers and Wigley's equation to calculate the electric field in a TZ-16 fuel tank. The calculated values are 2 to 2.5 times the experimental values.

42. K.C. Bachman and A.H. Popkin, "Tank Truck Incidents Attributed to Static Electricity, 1960-1969," Report No.: RL-72M-69, Esso Research and Engineering Co., Linden, N.J., Sept. 30, 1969.

This report is based on tank truck accidents as reported to the American Petroleum Institute or found in oil company reports. During the ten-year period covered, there were 116 fires/explosions while loading tank trucks or refuelers that were attributed to static electricity generated by the fuel. Two factors, switch loading and splash filling, were involved in the majority of incidents. Recommendations to prevent static incidents include: avoid splash filling, extend the fill pipe as close as possible to the bottom of the tank, reduce the flow velocity to 3 ft/sec until the inlet is submerged after which the velocity may be increased to 15 ft/sec, a minimum hold-up time of 30 sec is recommended and when bottom loading, use low velocity or splash deflectors. If splash filling and switch loading cannot be controlled, then inerting, gas-freeing or the use of antistatic additives should be considered.

43. K.C. Bachman, W.G. Dukek and A.H. Popkin, "Aircraft Incidents Attributed to Static Electricity, 1959-1969," Report No.: RL-45M-69, Esso Research and Engineering Co., Linden, N.J., July 21, 1969.

A total of 33 aircraft incidents attributed to static electricity generated by the fuel were reported during the period 1959-1969. Fuel type was identified in 28 incidents. Of these aviation gasoline was involved in 12 incidents, JP-4 fuel in 15 and kerosene in one.

44. J.T. Leonard and W.A. Affens, "Electrostatic Charging of JP-4 Fuel on Polyurethane Foams," NRL Report 8204, Naval Research Laboratory, Washington, D.C. March 1978.

The electrostatic charge generating characteristics of JP-4 fuel were determined on both polyester- and polyether-type polyurethane foams. Eleven samples of JP-4 fuel, covering a range in electrical conductivity of 0.65 to 10.27 picosiemens/m (pS/m) were tested. The conductivity of one sample was increased incrementally to 200 pS/m by use of a static dissipator additive (ASA-3). The charging tendency of the fuels was determined by measuring the filter current developed by the passage of 50 ml of fuel through a cylindrical section of foam held in an electrically isolated filter holder. The charging tendencies of all fuel samples were also determined using a reference paper filter. It was found that JP-4 fuels can become charged electrostatically by flowing through polyurethane foam. However, the magnitude of the charge cannot be predicted from the electrical conductivity of the fuel nor on the basis of its charging tendency on the reference paper filter. The charging tendencies on the polyether foams were about six times greater than on the polyester foams.

45. J.T. Leonard and W.A. Affens "Charging of Jet Fuel on Polyurethane Foams," in *Electrostatics 1979*, Conference Series No. 48, The Institute of Physics, London 1979, p. 55.

Jet fuels were charged electrostatically by flowing through polyurethane foam. Of the two types of foam tested, the polyether-type polyurethane foam was found to be the more active, producing about six times more charge than the polyester-type. However, the magnitude of the charge could not be predicted from the conductivity of the fuel nor on the basis of its tendency to charge on a standard paper filter. (Author's Abstract.)

46. W.G. Dukek, J.M. Ferraro and W.F. Taylor, "Static Electricity Hazards in Aircraft Fuel Systems," AFAPL-TR-78-56, Air Force Systems Command, Wright Patterson Air Force Base, Ohio, August 1978.

Static discharges that occurred during fueling in small-scale test rigs which simulated aircraft fuel tanks containing open-pore polyurethane foam were used to develop design criteria with respect to foam type, inlet configuration, and JP-4 conductivity. Blue polyether foam is more electrostatically active than red

polyester foam; sparks can be eliminated only with a multiple orifice inlet and a minimum fuel conductivity level of 50 pS/m, achieved by adding anti-static additive. With red polyester foam, either the multiple orifice inlet or minimum conductivity fuel suppresses static discharges. Spark energies from blue foam or from high velocity single orifice inlets appear to be 10-100 times greater than from red foam or from multiple orifice inlets. Variables such as flow rate, inlet type and exit velocity, metal charge collectors, fuel conductivity, foam dielectric properties, and other non-metallic fuel components were studied. For example, a rubber bladder cell is not significantly different from an empty tank in terms of static discharges. An aluminum mesh substitute for open-pore foam proved to be effective in minimizing static buildup but produced unacceptable metal fragments which acted as charge collectors.

47. E. Radgowski and D. Dantuono, "Final Report for Investigation of Electrostatic Discharge in A-10 Fuel Tanks During Refueling," Fairchild Republic Co. Report GT 160R0164, 27 March 1978.

Study of electrostatic charging of JP-4 in A-10 fuel tanks filled with both polyester and polyether-type polyurethane foams. The effects of fuel inlet configuration, fuel cell bladder material and anti-static additive on charging were determined. It was found that the high levels of charge during fueling could be eliminated by use of piccolo-type fuel inlet. Of the two types of foam tested, the polyether type produced higher levels of charge.

48. E. Radgowski and R. Albrecht, "Investigation of Electrostatic Discharge in Aircraft Fuel Tanks During Refueling," Presented at the AIAA Aircraft Systems and Technology Conference, Los Angeles, CA, 21-23 Aug. 1978

High levels of electrostatic charge on JP-4 fuel during aircraft refueling, due to both the flow of fuel and the charge buildup generated by fuel contacting the explosion suppression foam installed in some aircraft fuel tanks, were eliminated in the test installation using a multihole-design fuel inlet resembling a piccolo. This is an adaptation of a manifold inlet design investigated by various agencies as a means of reducing electrostatic charge. The "piccolo" inlet was selected as the result of a test program conducted to evaluate several fuel inlet configurations in conjunction with two generic types of polyurethane foam: polyester, presently used in aircraft fuel tanks; and polyether, proposed as a replacement for the polyester foam. Of the two types of foam tested, the polyether foam indicated a greater potential for producing static discharges than the polyester foam. (Author's Abstract.)

49. P.W. Kirklin, "Factors Affecting Electrostatic Hazards," Air Force Aero Propulsion Laboratory Report AFAPL-TR-78-79, December 1978

Conductivity additives ASA-3 and Stadis 450 have been found to significantly reduce static electricity in JP-4 containing approved additives when fuel conductivity is at least 100 CU at use temperatures. In the absence of conductivity additives, some additives caused increased charge accumulation which may have contributed to previous static ignited aircraft fires. Tests were performed in a Mobil Research small-scale electrification unit modified to simulate USAF fueling velocities and aircraft fuel tank configurations. (Author's Abstract.)

50. T.E. Farrand, "Investigation of Pinhole Failures in Teflon Hose Assemblies," Aeroquip Corp. Jackson Mich., Test Report No. 4063, 1 November 1959.

Pinhole failures were found to occur in Teflon hose assemblies used in fuel systems on GE, Westinghouse and Pratt and Whitney jet engines. The failures, which were attributed to electrostatic charging of JP-4 fuel, never occurred in assemblies less than 18 inches in length and never closer than 2 inches from the end fittings. Addition of carbon black to increase the conductivity of the tube extended the life of the tube by a factor of 4 to 5 times.

51. J.C. Abbey and T.E. Upham, "An Investigation of Electrostatically Induced Failures in Teflon Hose," presented at the SAE Committee Meeting, Detroit April 17, 1961.

Potentials sufficient to produce pinhole failures in Teflon tube can be generated by circulating JP-4 fuel containing trace amounts of asphaltic impurities through the hose. All types of Teflon tube examined were subject to pinhole failures. Potential at which breakdown occurred was estimated to be 50 kV. Increasing the conductivity of the fuel decreased the tendency of the hose to fail.

52. J.A. Carruthers and K.J. Marsh, "Charge Relaxation in Hydrocarbon Liquids Flowing Through Conducting and Non-Conducting Pipes," J. Inst. Petrol, **44**, 169 (1963).

A theory has been developed to predict the relaxation of electric charge from fluids flowing in pipes which may be conducting or non-conducting. Its results are expressed as a "relaxation function" depending on two dimensionless electrical parameters determined by the electrical conductivities of fuel and pipe and the flow conditions. The results have been tested over a considerable range of fueling conditions. Laboratory experiments on iso-octane flowing through copper and PTFE tubes agree well with predictions of charge relaxation. Full-scale experiments with an aircraft fueler and aviation kerosene are described, using bonded and unbonded hoses. It is confirmed that breaking the bonding wire of a fueling hose does not materially reduce the rate of relaxation of charge from the fuel, and the question of using integral bonding wires is therefore discussed. (Author's Abstract.)

53. M.R. Shafer, D.W. Baker, and K.R. Benson, "Final Report on Teflon Aircraft Hose Investigation," Nat. Bur. Stds. Report 8304, March 4, 1964.

Electrostatic charging of naphtha in Teflon hose (diam. = 0.20 to 1.85 inches) was studied. The conductivity of the naphtha was increased from 1 to 200 picomho/m by the addition of asphaltenes or ASA-3. Paper and glass fiber filters were found to produce about 10 times more charge in the fuel than steel filters. Charge relaxation occurs equally well in pipe or tubing made of metal as in insulating materials like Teflon. In conductive materials, charges relax harmlessly to ground. In insulating materials, the charges released to the walls cause voltages to build up until some form of electrical breakdown (corona or spark) occurs. Water, especially dispersed water, increases the charging tendency of the fuel but decreases its electrical conductivity.

54. M.R. Shafer, D.W. Baker, and K.R. Benson, "Electric Currents and Potentials Resulting from the Flow of Charged Liquid Hydrocarbons Through Short Pipes," J. Res. Natl. Bur. Std.-C, **69C**, 307 (1965).

The electrical currents and potentials produced in pipes of intermediate and very high resistivities, by the flow of a charged liquid hydrocarbon have been investigated. The maximum pipe currents to the ground were in the range 1 to 6 microamperes. Depending upon the electrical resistance of the pipes, these currents produced potentials ranging from essentially zero to values in excess of 30,000 volts which were sufficiently severe to cause electrical breakdown and arcs within some of the pipes under investigation. It is concluded that hazardous pipe potentials, resulting from static electricity, can be eliminated in practical applications if the electrical resistance from each and any portion of the interior surface of the pipe to the ground does not exceed about 10^7 ohms. (Author's Abstract.)

For pipe grounded on each end:

$$V_{\max} = 0.1 R_t I_p$$

V = max voltage on pipe wall

R_t = Pipe Resistance end to end. $R_t \ll R_{\text{liquid}}$

I_p = pipe current

If the pipe is grounded along its length instead of just at the ends, then V_{\max} will be lower.

When the rate of charge generation is sufficiently high in pipes constructed from nonconductive materials, electrical discharges and arcs will occur. These discharges will originate on the inner surface of the pipe. They may be contained entirely within the pipe or may cause puncture or other failure of the pipe wall depending on the wall thickness, material of construction and the ground locations involved.

55. J.A. Cross, A. Cetronio, and I.G. Haig, "Electrostatic Hazards from Pumping Insulating Liquids in Glass Pipes," Third International Congress on Static Electricity, Societe De Chimie Industrielle, Paris, 1977, p. 28 a.

Pumping xylene in glass systems can be extremely hazardous; even short lengths of tube can lead to very high charge densities. Although the charge in the liquid decayed very rapidly once pumping ceased, high potentials could build up on the glassware and flanges. Voltages of up to 18 kV were measured, and sparks well above the minimum ignition energy of xylene could be obtained. Earthing of metal flanges is to be recommended since this does not enhance charging and prevented the buildup of dangerous voltages on flanges. However, significant potentials could still be built up on the glass.

56. W.L. Green, "Electrostatics and Hydraulic Oils," *J. Electrostat.* **1**, 95 (1975).

All refined hydrocarbon oils become highly charged when flowing relative to surfaces at velocities greater than 1 to 7 m/s. A particularly dangerous situation results where flow occurs through a filter and into a plastic pipe of perspex or teflon. The highly charged fluid may discharge through the plastic pipe producing a hole through which a spray mist can develop causing a fire hazard. Voltages as high as 50 kV have been observed on Teflon hose downstream of a filter.

57. J.T. Leonard and R.C. Clark, "Generation of Static Electricity by Carbon Dioxide in Inerting and Fire Extinguishing Systems," in *Static Electrification 1975*, The Institute of Physics and the Physical Society, London, 1975, p. 301.

An investigation has been conducted into the possible electrostatic hazard resulting from the discharge of carbon dioxide (CO₂) by the hatch-snuffing (inerting) system used on board gasoline tankers. The tests were prompted by a fatal explosion in which the ignition source was an electrostatic spark produced by discharging a portable CO₂ fire extinguisher into a fuel tank truck. Measurements were made of the field strength developed in a full-scale model of a tanker hatch when a 22.7kg (50 lb) CO₂ cylinder was discharged via the hatch-snuffing system nozzles. A camera employing high-speed film and, in some runs, and instrumented probe were used to detect discharges. The field strength in the centre of the hatch reached a maximum value of 50–100kV m⁻¹ about 20–40 s after the CO₂ began to enter the hatch and then fell to zero near the end of the run (120 s). No evidence of electrostatic discharges was found on the photographs or on the oscilloscope traces from the probe circuit. Ship-board tests confirmed the conclusions reached in the model tests.

Companion experiments were also conducted using a portable, 6.8 kg CO₂ fire extinguisher since the ability of this device to produce incendiary electrostatic discharges has been established. Field strengths of the order of 1300 kV m⁻¹ were observed when this extinguisher was discharged into a simulated hatch area. Photographs and oscilloscope traces confirmed the presence of electrical discharges. The difference in the electrostatic charge generation characteristics of the CO₂ hatch-snuffing system versus the fire extinguisher was attributed to the plastic horn on the extinguisher. (The hatch-snuffing system employs a total of eight metal orifices and no horn or similar funnelling device.) When the plastic horn was removed and the fire extinguisher discharged through the remaining metal orifice, the field strength was reduced by a factor of 100, clearly demonstrating the charging characteristics of the plastic horn (Author's Abstract.)

58. J.T. Leonard and R.C. Clark, "Electrostatic Hazards Produced by Carbon Dioxide in Inerting and Fire-Extinguishing Systems," Naval Research Laboratory Report 7920, August 28, 1975.

In tests of the possible electrostatic hazard resulting from the discharge of CO₂ by the hatch-snuffing (inerting) system of gasoline tankers, measurements were made of the field strength developed in a full-scale model of a tanker hatch when a 22.7-kg CO₂ cylinder was discharged via the nozzles of the hatch-snuffing system. A camera employing high-speed film and, in some runs, an instrumented probe were used to detect discharges. The field strength in the center of the hatch reached a maximum value of 50 to 170 kV/m about 40 to 60 s after the CO₂ began to enter the hatch and then fell to zero near the end of the run (120 s). No evidence of electrostatic discharges was found on the photographs or on the oscilloscope traces from the probe circuit. Shipboard tests confirmed the conclusions reached in the model tests.

Companion experiments were also conducted using a 6.8-kg CO₂ fire extinguisher, since this device was involved in a fatal accident. Field strengths of the order of 1300 kV/m were observed when this extinguisher was discharged into a simulated hatch area. Photographs and oscilloscope traces confirmed the presence of electrical discharges. The characteristics of the electrostatic charge generated by the CO₂ hatch-snuffing system differed from the characteristics of the charge generated by the fire extinguisher due to a plastic horn on the extinguisher. The hatch-snuffing system employs eight metal orifices but no horn or similar funneling device. When the plastic horn was removed and the fire extinguisher was discharged through the remaining metal orifice, the field strength was reduced by a factor of 100, clearly demonstrating the charging characteristics of the plastic horn. (Author's Abstract.)

59. J.T. Leonard and R.C. Clark, "Reduction of Static Charge Generation by Carbon Dioxide Fire Extinguishers," Navy Patent Case No. 60,632, 9 March 1976.

This disclosure is directed to a method and apparatus for reducing an electrostatic hazard produced during the use of carbon dioxide, CO₂, fire extinguishers equipped with a plastic horn or nozzle so that the inner end of the sleeve is in contact with the metal orifice connected to the discharge line of the fire extinguisher. Further, the metal sleeve insert is of less length than that of the nozzle so that the outer end of the nozzle overlaps or extends beyond the end of the metal sleeve. A new discharge nozzle may be made as a separate element which includes a metal sleeve or liner surrounded with a glass cloth reinforced resin sheath bonded thereto.

60. J.T. Leonard and R.C. Clark, "Fire Extinguishers Can Cause Fires," FLIGHT COMMENT — The Flight Safety Digest of the Canadian Armed Forces, Edition 3, 1976, p. 16.

Sufficient static electricity is generated on the horn of a CO₂ fire extinguisher by the discharge of CO₂ snow to ignite a flammable fuel/air mixture. A simple experiment is described in which a spark discharge from the horn of a CO₂ extinguisher to a grounded electrode is used to ignite fuel vapors in a plexiglass box.

61. J.T. Leonard and R.C. Clark "Fire Extinguishers CAN Cause Fires," MECH — The Naval Aviation Maintenance Safety Review, Summer, 1976, p. 13.

Sufficient static electricity is generated on the horn of a CO₂ fire extinguisher by the discharge of CO₂ snow to ignite a flammable fuel/air mixture. A simple experiment is described in which a spark discharge from the horn of a CO₂ extinguisher to a grounded electrode is used to ignite fuel vapors in a plexiglass box.

62. J.T. Leonard and R.C. Clark, "Ignition of Flammable Vapors by CO₂ Fire Extinguishers," J. Fire and Flam. 8 131 (1977).

An apparatus is described for demonstrating the incendiary nature of discharges from the horn of a portable CO₂ fire extinguisher. The center section of the horn was enclosed in a plexiglass box containing a flammable fuel/air mixture and a grounded probe placed at a distance of 1 cm from the horn.

When the fire extinguisher was discharged, sparks jumping between the horn and the grounded probe ignited the fuel vapors in the box. The purpose of the demonstration was to prove that CO_2 fire extinguishers should never be used to inert tanks containing fuel vapors. (Author's Abstract.)

63. G.J. Butterworth, "Electrostatic Ignition Hazards Associated with the Preventative Release of Fire Extinguishing Fluids," in *Electrostatics 1979*, Conference Series No. 48, The Institute of Physics, London, 1979, p. 161.

Studies have been made of the electrification during release of halogenated hydrocarbons and carbon dioxide from fixed fire extinguishing/inerting systems. A means of greatly reducing the strong charging observed with conventional CO_2 systems is described. Possible mechanisms for electrostatic ignition are identified and the corresponding incendivity criteria examined in relation to electrostatic conditions expected in practice. (Author's Abstract.)

64. E. Heidelberg, "Hazards of the Ignition of Explosive Mixtures by Electrostatic Charging of Plastic Containers," *Brandverhütung-Brandbekämpfung* 2, 19-25 (1969).

Three types of electrostatic discharges are identified:

- (1) Spark discharges — sufficient charge may be induced on an isolated conductor in the presence of a charged plastic container to produce a spark discharge when the conductor comes in contact with another conductor which may or may not be grounded. This type of discharge is particularly dangerous since the entire capacitance of the conductor will be discharged in the spark.
- (2) Brush discharges — are formed in very inhomogeneous fields between charged nonconductors and grounded or ungrounded conductors. Brush discharges are barely visible in daylight but produce an audible hissing sound. The surface charge density on a nonconductor required to exceed the breakdown value for air (30 KV/cm) is 2.7×10^{-9} C/cm². The energy of a brush discharge from a charged nonconductor to a grounded sphere is a function of the radius of the sphere.
- (3) Surface streamer discharges (Lichtenberg discharge) — these high-energy type of discharges occur when a brush discharge is initiated by the approach of a conductor to thin, highly charged, nonconducting layers residing on some conducting material. A maximum charge density of 4×10^{-8} C/cm² is required to produce a streamer discharge. Charge densities of this order may not be produced by rubbing but could be produced inside of plastic-lined metal tanks by tank washing equipment.

All three types of discharges are capable of igniting flammable H_2 /air and hydrocarbon/air mixtures; in general, dust/air mixtures cannot be ignited by brush discharges.

65. N. Gibson and F.C. Lloyd, "Incendivity of discharges from electrostatically charged plastics," *Brit. J. Appl. Phys.* 16, 1619 (1965).

Electrostatic charge densities of 1.1-2.3 nC/cm² can be generated over areas of polyethylene (polythene) sheet by rubbing. The nature and magnitude of electric discharges from the polyethylene sheet to an earthed electrode are a function of the relative humidity of the atmosphere and of the size of the electrode. The discharges change from corona to spark type if the radius of a hemispherical electrode is increased from 1 to 10 mm; with the latter-sized electrode the sparks can contain up to 0.23 μ C of charge. Such sparks, which have an equivalent electrical energy of 0.67 – 0.92 mj, can ignite flammable mixtures of coal gas, methane, acetone, methanol, toluene, cyclohexane and dioxane with air. For a fixed electrode system the incendivity of a spark is directly related to the electric charge in it. (Author's Abstract.)

The maximum theoretical charge density, i.e., the density that will produce a field strength of 30 kV/cm, is 2.7 nC/cm². This maximum can only be achieved by the mechanism of rubbing if the area is sufficiently small, i.e., 1-2 cm². For larger areas, the limiting charge density is 1.2-2.3 nC/cm².

The polarity of the charge generated by rubbing polyethylene sheet with mohair was negative. The charge did not migrate to the opposite side of the sheet. The maximum potential of the charged polyethylene surface corresponded to an equivalent electrical potential of 75 kV since sparks were released when the grounded electrode was about 2.0-2.5 cm from the plastic.

The relation, $E = 1/2 CV^2$, cannot be used directly to compute the energy of discharges from an insulator since, due to high surface and volume resistances, only a fraction of the charge on the surface is transferred in the discharge. The character of a discharge from a plastic surface may be described in terms of the charge transferred in the discharge and its distribution with respect to time.

Factors that influence the amount of charge transferred from an insulator are:

- (a) charge density at surface
- (b) surface resistance of the plastic
- (c) type of earthed electrode (1.0 mm gave most charge transfer)
- (d) area of plastic (300 cm² max area to participate in discharge)
- (e) humidity (max charge transferred below 40 of RH).

66. N. Gibson, "Evaluation of Electrostatic Hazards Associated With Non-Conducting Materials," Presented at the Conference on Electrostatic Hazards in the Storage and Handling of Powders and Liquids, Chicago, Ill., October 16-17, 1979.

Non-conducting materials can be charged in a variety of ways, e.g., by rubbing or, in the case of pipes, by the passage of powders or liquids through them. Discharge will occur from the non-conductor when the charge density on the surface is of the order of 10⁻⁵ C/m².

Three types of discharge can occur from non-conductors: (1) Corona, if the surfaces have small radii of curvature (2) Brush Discharge, consisting of a core of high energy density followed by a highly branched structure and (3) Propagating Brush Discharge if the non-conductor is in a sheet form with large opposing charges on its two surfaces.

Considerably more energy is required to produce an ignition from a discharge from a non-conductor as compared with a discharge between two metal electrodes. Incendive discharges can be obtained from small areas (10-50 cm²) of polyethylene sheet.

For inherent safety, ideally all non-metallic materials should be made electrically conducting by the incorporation of appropriate additives. Other precautions include limiting the exposed area of non-conducting plastics (to 20 cm² in a 0.2 mJ atmosphere) and making sure that the plastic does not insulate any conductor from earth that could become charged. Insulated electrical conductors constitute the most dangerous risk from static electricity.

A potential of 100 volts is considered to be the minimum potential at which an incendive discharge can occur (except in the case of explosives). Since the maximum charging current developed in industrial processes is 10⁻⁴ A, a resistance to ground of 10⁶ Ω will preclude dangerous charge accumulations. For *practical reasons* (electric mains shock, lightning etc.) resistances of 10-100 Ω have been specified for electrostatic earthing systems.

Finally although non-metallic materials can, directly, or indirectly be the cause of electrostatic discharges, there need be few restrictions on the use of plastics provided that the traditional precautions such as bonding and grounding are employed.

67. C. W. Young, "Accumulation and Elimination of Static Electricity in Plastic and Metal Piping," Test conducted by CLA-VAL Corporation, Newport Beach, Calif., Jan. 20-Feb. 11, 1969.

Static electricity measurements were conducted with fiberglass reinforced plastic and metal pipe and data were obtained with the static charge reducer. Tests were carried out using 220 feet of 8-inch diameter fiberglass reinforced plastic pipe (Amercoat Corporation Bondstrand Series 2000 pipe) in a U-shaped run, 20 feet wide and 100 feet long, together with a Static Charge Reducer furnished by the A.O. Smith Corporation. Results were as follows:

Pearl white kerosene was charged to $235 \mu\text{C}/\text{M}^3$ by flowing it at 1200 gpm through a filter separator. Immediate passage through the SCR reduced the charge to 22; further passage through the 220 feet FRP pipe reduced the charge to 5.

In another test the kerosene, charged to $250 \mu\text{C}/\text{M}^3$ in the filter separator, was passed through the 220 feet of FRP pipe, which reduced the charge to 30. Further passage through the SCR reduced the charge to 16. In a comparable test with carbon steel pipe, the charge on the fuel was reduced from 252 to $2 \mu\text{C}/\text{m}^3$.

It was concluded that static chargers were reduced when fuel is pumped through plastic pipe at linear velocities of 6-8 ft/s. Low intensity sparks were produced at the surface of the plastic pipe when a grounding device was brought near the pipe surface (during pumping operations). This phenomena is not considered a problem since plastic pipe is to be used underground.

68. R. Tinson, "The Electrostatic Hazard During Loading of Petroleum Products into Glass-Reinforced Plastic Tanks," J. Inst. Petrol. 53: 303 (1967).

Two tanks made of glass-reinforced plastic, one standing free on the ground and the other mounted on a road vehicle, have been loaded with aviation kerosine and with gas oil at filling speeds of up to 480 IG/minute. The fuel was filtered through either a basket strainer or a microfilter situated immediately upstream of the loading arm. Both tanks had metallic fittings and connections which were insulated from earth by the tank material.

At filling speeds of 450 to 480 IG/minute, the charging current in the fuel was as high as $1.8 \mu\text{amp}$ when the strainer was used, and up to $22 \mu\text{amp}$ when the microfilter was used. Gas oil became more highly charged than kerosine during microfiltration.

During fueling, potentials of up to 11 kV built up on insulated metal connections to the tanks. When fuel was filtered through the strainer, potentials in excess of 1 kV built up only on connections which were well insulated from earth, but when the fuel was microfiltered, the potentials of connections were prevented from rising above 1 kV only by earthing them individually. With an earthed probe, sparks could be drawn from all metal connections with potentials above about 1 kV. No discharges were detected from the surface of the tanks.

It is concluded that if, in the design of tanks made from glass-reinforced plastic or other materials of very high resistivity, provision is made for proper electrical bonding, the electrostatic hazards during the loading of petroleum products should not be different from those in similar tanks made from conducting materials. (Author's Abstract.)

69. N. Gibson, "The Electrostatic Hazard During Loading of Petroleum Products into Glass-Reinforced Plastic Tanks," *J. Inst. Petrol.* **54**, 9 (1968).

In Tinson's paper [*J. Inst. Petrol.* **53**: 303 (1967)], the resistance of the liquid through the GRP tank was assumed to be about 10^9 ohm. Very high resistivity materials, e.g., polyethylene, polypropylene, polyvinyl chloride, etc., have surface and volume resistivities of the order of 10^{14} – 10^{17} ohm cm and 10^{12} – 10^{17} ohm cm respectively. The rate of charge leakage from liquids in containers made from such materials could be much less than that from liquid in a GRP container. Furthermore, charge density levels up to or near the theoretical upper limit (about 2.7×10^{-9} coulombs cm^{-2}) can be generated and retained on the surface of these high resistivity materials. Gibson and Lloyd (*Brit J. Appl. Phys.*, 1965, **16**, 1619) have shown that discharges from electrostatically charged polyethylene surfaces can ignite flammable vapor-air mixtures. Moreover, incidents are known in which polyethylene pipes, electrostatically charged by the flow of liquid through them, have released electric sparks from their outer surfaces to the earthed metal collars supporting them. These incidents have occurred in both laboratories and plants under conditions in which the electrostatic charging rates were no greater than the maximum value of 22 microamp quoted in the paper.

The paper by Tinson provides valuable information on the electrostatic hazard associated with GRP tanks. However, there is considerable evidence that the earthing of metal components on tanks made from all very high resistivity materials will not make them identical, in terms of electrostatic hazard, with tanks made from conducting materials.

70. J.F. Hughes, "Electrostatic Charges On Board Ships," *Trans. I. Mar. E.* **92** 2 (1980).

The fundamental processes of electrostatic charge separation can result in a number of unexpected phenomena, often creating potentially hazardous situations. With the increasing use of new materials for many different applications, it is not surprising to find that electrical charging and discharging processes have adopted new and unpredictable behaviour. In marine applications, this is especially relevant to glass reinforced plastic (GRP) for hull and fuel tank fabrication, and all the ignition precautions needed with the bulk handling and transport of incandive materials. It is the unpredictability of electrostatics coupled with the fact that so little energy (≈ 0.2 mJ) can have such disastrous results, which makes it important. (Author's Abstract.)

With the advent of Glass Reinforced Plastic (GRP) ships in the Royal Navy (HMS BRECON, a minehunting vessel and HMS WILTON, a mine-countermeasure-vessel) concern has been expressed over hazards resulting from: 1) charged fuel in tanks, 2) charged personnel, 3) lightning and 4) fuel/oil leaks in the engine room.

Tests in 2500 gal GRP tanks have shown that during refueling, electrostatic charges in the fuel tend to migrate to the tank walls constituting the dielectric of a capacitor. Unlike metal tanks, charge decay rates appear to be independent of fuel conductivity and depend primarily on the bulk and surface conductivity of the tank. Charge decay takes minutes in a GRP tank as opposed to seconds as in a metal tank. A grounded metal plate (1000 cm^2) was found to be very effective in discharging fuels having a conductivity greater than 10 pS/m . No tests were conducted with low conductivity fuel.

A maximum potential of 4 kV was considered necessary to minimize the hazards of spark discharges from personnel in areas where ignitable vapors or explosives might be encountered. As long as the RH is above 60%, charges will not accumulate on the human body. Below 60% RH, there is no way to guarantee that potentials on personnel will not exceed 4 kV.

There is insufficient experience at present to indicate whether lightning strikes will be more hazardous to GRP ships. However, screening of the lightning rod and mechanical stresses resulting from bending of the conductor are envisioned as problems.

Punctures in fuel or oil lines under pressure are considered to be a problem, especially if the atomization of the fuel occurs in the vicinity of an insulated metal component which could become charged electrostatically by the mist.

The article concludes with a discussion of tanker explosions. Two possible ignition sources which might occur during tank washing operations were cited: 1) corona discharges from water drops adhering to metal proturbances in the tank and 2) high energy spark discharges from water slugs falling through the charged mist in the tank.

71. P. Bolton, "Electrostatic Charge Build-up with Diesel Fuels in GRP Tanks," Admiralty Oil Laboratory, Cobham, Report No. 69, August 1972.

Electrostatic charges are more likely to build-up in the handling of fuel in vessels constructed from glass reinforced plastic (GRP) than in ships of conventional metal alloys. To investigate these, the build-up and decay of electrostatic charges were measured during pumping fuel using a 47 gallon GRP tank in the laboratory at normal ambient temperatures. The maximum charges at pumping rates of up to 8 m/sec were greater than those with a similar aluminum alloy tank but did not appear to be excessive. The vapor build-up in the ullage space was well below the lower explosive limit for the fuel.

It is recommended that the electrostatic charges formed in pumping diesel fuel aboard HMS WILTON, the first GRP minehunter, should be measured to check these findings under actual ship conditions. (Author's Abstract.)

72. R. Bolton, "Fuel Trials on HMS WILTON," AOL Cobham, Report 703-667-2955, July, 1972.

73. A.W. Bright, "Electrostatic Hazards in Liquids and Powders," J. Electrostatics 4 131 (1977/1978).

A discussion of research conducted at the U. of Southampton on electrostatic charging of hydrocarbon liquids (diesel fuel) and powders (chocolate, milk and sugar).

A large scale facility was constructed for measuring charge generation by diesel fuel when loaded into aluminum and glass reinforced plastic (GRP) tanks. For diesel fuels in the conductivity range of 20-300 pS/m, the charge density was found to be roughly constant over flow rates of 0.3 to 15 m/s in 15 cm pipes. For GRP tanks, a hazardous voltage on the fuel surface could occur if the inlet charge density exceeded $250 \mu\text{C}/\text{m}^3$. With large plastic tanks the decay of charge can be rather slow, even when a conductive fill pipe is used.

The hazards of transferring insulating powders into silos are also discussed. Potentially hazardous discharges can occur from the powder column to the silo wall when the field at the surface of the powder column reaches $3 \times 10^6 \text{ V/m}$.

Active and passive discharger systems are discussed for both hydrocarbon liquid and powder handling systems.

74. J.F. Hughes, "Electrostatic Hazards Associated With Fueling of Ships and Aircraft," presented at the Conference on Electrostatic Hazards in the Storage and Handling of Powders and Liquids, Chicago, Ill., 1979.

Review of basic processes and ignition criteria. Hazards arising from fueling of tanks constructed in insulating material. Investigations of problems relating to large mine counter measure vessels constructed in GRP. Discovery of serious potential hazards in large (2,699 gal) tanks. Discussion of intrinsically safe potential density meters for on-line use. Measurement problems. Description of the design and use of active and passive discharge systems for fueling systems. A review of the possible application of the methods described to fueling of ships, aircraft and on-line use in petro-chemical plant. (Author's abstract.)

When charged fuel is loaded into a GRP tank, the charge tends to migrate to the walls where it is stored, the walls constituting the dielectric of a capacitor. Charge decay rates appear to be relatively independent of fuel conductivity and depend primarily on the bulk and surface conductivity of the tank.

Incendive discharges occurred when the potential on the fuel surface exceeded 25 kV. Below 20 kV, conical protuberances (Taylor cones) pulled up the fuel surface by the electric field thereby bridging the gap and preventing discharges. A value of $125 \mu\text{C}/\text{m}^3$ was found to be the maximum permissible inlet charge density to prevent incendiary discharges in the tank.

On two occasions, when filling the GRP tank at 300 gpm, very high energy discharges were noted ($10 \sim 50 \text{ J}$). These were apparently associated with the storage of charge in the base of the tank.

A fuel discharging system employing a high voltage liquid diode to inject charge into the fuel has been developed for the mine counter measures vessel HMS BRECON. The system will eliminate the type of discharge that occurred in the GRP tank.

An alternative method for reducing static charge in GRP tanks is the use of an earthing plate. Experiments showed that a stainless steel plate in the bottom of a 2500 gal. GRP tank neutralized the electric field when filling at 250 gpm with an inlet charge density of $185 \mu\text{C}/\text{m}^3$ on a diesel fuel having a conductivity of 23 pS/m. There is some evidence that the plate would be effective with fuels down to 1 pS/m.

75. A.W. Bright, G.G. Bloodworth, J.G. Smith, and M.A. Yuratich, "The Development of Electronic Field Meters for Use in Automatic Systems for Control of Electrostatic Charge in Fuel Tanks," Proceedings of the 1975 Conference on Lightning and Static Electricity; The Royal Aeronautical Society, London, 1975.

Electronic field meters were developed for use in automatic systems for control of electrostatic charge in fuel tanks.

The first prototypes were calibrated in a uniform field whose value was accurately determined by measuring voltage across a known gap. The behavior of the instruments was compared with that of a Davenport rotary field meter.

With a low sensitivity head (1 cm dia. probe), operation in high electric fields ($\sim 500 \text{ kV}/\text{m}$) was satisfactory. In this case, some discharges occurred in the test cell but the calibration was not affected. With a 3 cm head, sensitivity was 10 times greater and fields as low as $1 \text{ kV}/\text{m}$ could be detected. Drift rate in an applied field was $< 1/2\%$ per hour. Preliminary experiments with digital read-out using rapidly fluctuating fields and charging polarity indicated that the instrument could be used in a control system without difficulty.

J. T. LEONARD

Initial work has been done on small fuel tanks which indicates that the electronic field meter is compatible with diesel and other fuel atmospheres. It has been calibrated in a uniform field geometry and also behaves satisfactorily when mounted in the top wall of a fuel tank.

The meter is currently being tested in a full scale facility employing 2500 gallon tanks, one of aluminum construction and the other of glass reinforced plastic.

The obvious application is to mount the field meter in the roof of the tank, measuring the electric field in the ullage space. The output from the instrument can be used either to sound an alarm as the critical breakdown voltage is approached or shut off the pumps.

The alternative is to use an active system in which the instrument is used to control charge injections in order to produce zero charge density (and field) in the tank. Preliminary experiments have been carried out at Southampton on charge injections which suggest that injecting voltages < 10 kV will be satisfactory.

Whichever system is used, the electronic field meter is likely to find a number of applications in the petroleum industry wherever it is necessary to measure electric fields in flammable atmospheres.

76. N.J. Denbow and A.W. Bright, "The Design and Performance of Novel On-Line Electrostatic Charge Density Monitors, Injectors and Neutralisers for Use in Fuel Systems," presented at the Conference on Electrostatic Hazards in the Storage and Handling of Powders and Liquids, Chicago, Ill., 1979.

The theoretical derivation of the performance of a relaxation type charge density monitor is discussed. The practical devices of this type produced are described, and the performance on diesel fuel related to the theory. Problems of apparent variations in conductivity of the fuel lead to a system of charge density measurement independent of fuel conductivity. The use of an electrostatic charge injector in a feedback loop with a charge density monitor acting as a null detector is shown to produce a practical system for charge elimination from fuel flowing down pipelines, which has been tested on a full scale flow rig. (Authors's Abstract.)

77. N. Denbow and the late A.W. Bright, "The Design and Performance of Novel On-Line Electrostatic Charge-Density Monitors, Injectors and Neutralisers for Use in Fuel Systems," *Electrostatics* 1979, The Institute of Physics, London, J. Lowell, Editor, 1979, p. 171.

The theoretical derivation of the performance of a relaxation-type charge-density monitor is discussed. Practical devices of this type produced are described and the performance on diesel fuel related to the theory. Problems of apparent variations in conductivity of the fuel lead to a system of charge-density measurements independent of fuel conductivity. The use of an electrostatic charge injector in a feedback loop with a charge-density monitor acting as a null detector is shown to produce a practical system for charge elimination from fuel flowing down pipelines. The system has been tested on a full-scale flow rig. (Author's abstract.)

78. T. Horeff, "DC-9 Liquid Nitrogen Fuel Tank Inerting System," presented at the FAA Public Hearing, Washington D.C. June 13, 1979.

The FAA has successfully flight-tested a liquid nitrogen fuel tank inerting system aboard a DC-9 aircraft. The system replaces oxygen in the fuel tank vapor spaces and vent lines with nitrogen so that the oxygen concentration remains below 9% under all flight and ground conditions. The total system weight, including 270 lbs of nitrogen, is 643 lbs. Approximately 2000 flight hours were accumulated with the inerting system in operation.

79. I. Ginsburgh, "The Static Charge Reducer," *J. Colloid and Interface Sci.*, **32** 424 (1970).

The electric charges generated by friction in flowing hydrocarbon liquids can create hazardous sparks in partially filled vessels. This paper describes a device which can neutralize much of this charge by injecting charge of the opposite sign and mixing it with the original charge. Discharges from oil surfaces and a criterion for a safe charge density in oil are also discussed. (Author's Abstract.)

80. J.C. King, "Effectiveness of the Static Charge Reducer in Attenuating Static Charges During Hydrocarbon Fuel Handling Operations" Civil Engineering Laboratory, Port Hueneme, CA., Report No. TN-1378, February 1975.

Discharge of static electrical charges during fuel-handling operations poses a high hazard of fire and explosion. The Navy has relied on relaxation tanks to attenuate static charges before the fuel enters a receiving tank. However, within the past few years the Static Charge Reducer (SCR) has been marketed for this purpose. CEL has tested the SCR's performance and compared it with that of relaxation tanks in reducing static charges associated with the handling of JP-4 and JP-5 fuel. It was found that the performance of the SCR and relaxation tanks was essentially the same in reducing static charges of up to $-340 \mu\text{C}/\text{m}^3$, except during turn-on of the SCR, when a potentially hazardous condition might exist. Because of this potential hazard, it is recommended that the SCR not be used without a relaxation tank backup until it has been determined that use of the SCR alone is free from hazard during turn-on. If the SCR is found to be safe under turn-on conditions, considerable savings could be realized through using it with large fuel systems, but not with systems smaller than 500-gpm because of the expense of monitoring equipment. (Author's Abstract.)

81. J.H. Warren, R.F. Lange and D.L. Rhyndard, "Conductivity Additives are Best," *Hydrocarbon Processing*, December, 11 (1974).

A full-scale test program was conducted to determine the causes and means of minimizing static charge generation during the pumping of middle distillate fuel. The effects of flow rate, drop tube height and diameter, filtration and fuel conductivity were determined. The Static Charge Reducer (SCR) was also evaluated. It was found that increasing the fuel conductivity to 40 pS/m was sufficient to keep the maximum surface voltage on the fuel below the target level of 1 kV. Although the SCR did reduce surface voltages, values in excess of 1 kV were obtained with the SCR, even when the device was installed in the drop tube.

82. Military Specification, Turbine Fuel, Aviation Grades JP-4 and JP-5, MIL-T-5624L, 18 May 1979.

83. Military Specification, Turbine Fuel Kerosene Type, Grade JP-8 MIL-T-83133A, 18 May 1979.

84. C.R. Martel and F.P. Morse, "Service Test of Two Fuel Conductivity Additives," Air Force Wright Aeronautical Laboratories Technical Report AFWAL-TR-80-2051, January 1980.

A service test of two fuel conductivity (anti-static) additives was conducted from April 1977 to May 1979 at eight Air Forces bases. Since bases have continued to use the additive, a portion of the data reported herein extends to January 1980. The two candidate fuel additives were Shell Chemical Company's ASA-3 and E. I. duPont de Nemours and Company's Stadis 450. The additives were injected into the JP-4 aviation turbine fuel at either the refinery or terminal supporting the base. The conductivity of the JP-4 delivered to the service test base was to be maintained between 200 and 600 pS/m. The minimum and maximum fuel conductivity limits for servicing to aircraft was 100 to 700 pS/m. The effects of the additives on the air base fuel systems, filter separator elements, and on aircraft were monitored. (Author's Abstract)

85. J.K. Johnson, "The Effect of Stadis 450 and ASA-3 on Sparking in Foam-Filled Tanks," Shell Research Ltd., Thornton Research Center, Final Report, September 1977.

The fuel tanks in some military aircraft are filled with reticulated foam, to prevent explosive propagation of flame. The foam has apparently contributed to fires that have occurred during tank filling. We have been asked to assess the effect of the antistatic additives Stadis 450 and ASA-3 on this hazard.

In an experimental foam-filled tank, similar to an aircraft tank, charge generation and sparking have been examined during the few seconds after start of tank filling. A fuel of low electrostatic activity (conductivity 0.8 pS/m) caused incendive sparks between a simulated coupling and a pipe. A more active fuel (conductivity 6 pS/m) caused incendive sparks between the charged foam and the pipe. When no pipe was near the inlet, a fuel of low activity caused incendive sparking between the foam and the inlet nozzle. The incendivity of all three types of spark was confirmed by ignition of propane/air mixtures.

The progressive addition of Stadis 450 to any of these fuels increased the charging as the conductivity rose to 40 pS/m. Above that concentration, the hazard declined and was negligible at 150 pS/m for any mode of sparking. The addition of ASA-3 to these fuels reduced the hazard and at 150 pS/m it was again negligible. (Author's Abstract).

86. C.P. Henry "Electrostatic Charging in Coalescers and Reticulated Foam," E.I. duPont Co, Petroleum Laboratory Report No. PLMR 20-78, May 1978.

Electrostatic charging in coalescers and reticulated foam was investigated using an Exxon Ministatic Tester (MST). Overall results showed that electrostatic charging effects from Stadis 450 and Additive A conductivity improvers were equivalent although often different under specific test conditions.

A pharmaceutical coalescer gave very high electrostatic charging at 0°F for fuel containing either additive, but charging in three Department of Defense (DOD) coalescers was much lower and equivalent overall for the two conductivity improvers. Equivalent results were obtained at 0°F and 75°F when the conductivity improvers were added to six USAF JP-4 fuels containing normal concentrations of other additives.

Charging in red polyester/polyurethane reticulated foam with the two conductivity improvers was variable and dependent on the specific coadditives present, but comparable overall. Fuels containing mixtures of the two conductivity improvers gave less charging.

Fuels containing DCI-4A did not give significant electrostatic charging when tested in three DOD coalescers at 25°F. (Author's Abstract).

87. B. Vos, "Electrostatic Charging in Foam-Filled Tanks," Paper presented at a symposium on "Static Electricity Hazards during Aircraft Fueling," Dayton, Ohio 29-30th September, 1977.

The fuel tanks in some military aircraft are filled with reticulated foam in order to prevent the explosive propagation of a flame but the foam has apparently contributed to fires that have occurred during the filling of such tanks. Experimental work was carried out at the Shell Research Laboratory, Thornton, England, to study the charge generation and sparking that occurred a few seconds after starting to fill a vessel designed to simulate an aircraft tank. Results showed that kerosine with a low electrostatic activity caused incendive sparks between an insulated coupling and a pipe. A more active fuel caused incendive sparks between the charged foam and the pipe. When no pipe was near the inlet, a fuel of low activity caused incendive sparking between the foam and the inlet nozzle. The incendive activity of all three types of spark was confirmed by ignition of propane/air mixtures.

Each type of electrostatic hazard was reduced by using the antistatic additive ASA-3. For sparking between foam and inlet nozzle the hazard became negligible at a conductivity of 30 pS/m, but to prevent the most severe mode of sparking (coupling to pipe) a fuel conductivity of 100 pS/m was required. (Author's Abstract.)

88. Military Specification, Fuel Oil, Diesel Marine, MIL-F-16884G, Amendment 1, 22 March 1978.
89. "Standard Specification for Aviation Turbine Fuels," American Society for Testing and Materials, ANSI/ASTM D 1655-80.
90. J.T. Leonard, "Electrostatic Properties of JP-5 Jet Fuel from Alternate Sources," NRL Memorandum Report 3294, May 1976.

The electrostatic properties of JP-5 fuel from alternate sources were determined. Two properties — electrical conductivity and electrostatic charging tendency — were measured on seven samples.

Five coal-derived fuels and one sample derived from tar sands exhibited properties similar to jet fuels derived from petroleum and hence should not develop unusual ignition hazards in field handling. A JP-5 produced from shale had higher values of conductivity and charging tendency than petroleum-derived fuels, but the combination of the two properties indicates that no abnormal electrostatic hazards should be encountered.

91. W.A. Affens, J.M. Hall, E. Beal, R.N. Hazlett and J.T. Leonard, "Relation Between Fuel Properties and Chemical Composition. III — Physical Properties of U.S. Navy Shale II Fuels," in ACS Symposium Series, Oil Shale, Tar Sands and Related Materials, American Chemical Society, Washington, D.C., in publication.

Physical properties (specific gravity, electrical conductivity, freezing point and pour point) and flammability and ignition properties (flash point, autoignition temperature and electrostatic charging tendency) of thirty-six samples of various fuels (JP-5, JP-8 and Diesel Fuel Marine) derived from shale were determined. The properties of the shale-derived fuels were found to be similar to their petroleum-derived counterparts. The differences observed could be minimized by modest changes in refining steps. It was concluded that shale oil can be considered a promising alternative source for the production of Navy distillate fuels.

92. Ya.M. Paushkin et al., "Anti-static Additives for Petroleum Products Based on Chelate-forming Compounds." *Khimiya Tekhnol., Topl. Masel*, **14**, (12), 22-24, 1969.

Anti-static additives, soluble in petroleum products, were synthesized by mixing chromium salts with chelate-forming compounds (salicylic acid, β -diketone ferrocene and manganese-cyclopentadienyltricarbonyl) and higher carboxylic acids (oleic and stearic), and also by mixing phenol salts with benzoic and higher carboxylic acids. It was shown that the salts based on chelate-forming compounds and oleic acid increase the electrical conductivity of petroleum products $10^3 - 10^4$ times, which eliminates the accumulation of electrostatic charges.

93. M. Mandl, "Additives for Protection Against Static Electricity and Their Use in the Petroleum Industry," *Nafta (Zagreb)*, **27** (9), 501-7 (1978).

In this review the causes of generating static electricity charges by fuel manipulation and reasons for additive application because of hazard elimination are described. Also the characteristics and possibilities of different additive application, their storage stability, testing methods, secondary additives' effects

and their application range in oil refinery products and petrochemicals are discussed. The explanation of necessity of conductivity improver additive addition in jet fuel is given. (Author's Abstract.)

94. A.U. Salimov, M.T. Balabekov, D.G. Mambetov, and M.M. Akbarov, "Increase in the Artificial Electrifiability of Liquid Hydrocarbon Fuels," *Izv. Akad. Nauk Uzb. SSR. Ser. Tekh. Nauk*, 15 (4) 13-15 (1971).
95. E.S. Denisov and A.N. Solov'ev, "Dependence of Static Charging and Some Electrophysical Properties of Aviation Fuels on Their Composition," *Zh., Khim.* 1976, Abstr. No. 22P224.
96. O.E. Poboiskii and V.I. Primenko, "Effect of Resin Compounds on the Static Charging of Aviation Kerosines," *Vopr. Khim. Khim. Tekhnol.*, 41, 101-3 (1975).
97. A.A. Gureev, V.M. Tugolukov, I.N. Mardukhaev, S.A. Bobrovskii, and A.K. Denel, "Testing Liquid Hydrocarbon Products, e.g., Aviation Fuels, for Their Tendency of Static Electricity Charge Formation," *Otkrytiya, Izobret., Prom. Obraztsy, Tovarnye Znaki*, 49 (22), 167 (1972). USSR Patent No: 345437, Assignee: Gubkin I.M., Institute of the Petrochemical and Gas Industry, Moscow.

DATE
ILME