

Genetic Polymorphism of the Third Component of Human Complement (C'3)

CHESTER A. ALPER and RICHARD P. PROPP
with the technical assistance of LILLIAN WATSON

From the Blood Grouping Laboratory and the Departments of Medicine, Children's Hospital Medical Center and Peter Bent Brigham Hospital, and the Departments of Medicine and Pediatrics, Harvard Medical School, Boston, Massachusetts 02115

ABSTRACT Polymorphism of human C'3 has been defined by prolonged agarose electrophoresis of fresh serum. At least four, and probably five, alleles have been identified by the electrophoretic mobilities of gene products. Inheritance of three alleles, F₁ F, and S, is consistent with the autosomal codominant type. The inheritance of S₁ is probably codominant and that of F_{0.8} is not known. Of the 15 phenotypes predicted by these alleles, eight have been observed.

The allotypes appear to differ in net surface charge at pH 8.6, but show no obvious differences in complement activity, in molecular size, or in binding of Ca⁺⁺. The concentrations of the two gene products in serum from all known heterozygotes are approximately equal.

The S gene is most common in the three major races of man. The F gene is relatively common in Caucasians, less common in American Negroes, and relatively uncommon in Orientals.

INTRODUCTION

Genetically controlled polymorphism has been well-documented for many human plasma proteins, including haptoglobin, transferrin, beta lipoprotein, the immunoglobulins, alpha₁ antitrypsin, alpha₁ acid glycoprotein, and Gc globulin. In general, the means for the recognition of allotypes fall into two groups: (a) the demonstration of a net electrical charge (and sometimes also size) difference by electrophoresis; and (b) differences in serological reactivity with antisera of animal or

human origin. In a few cases, allotypy may be presumed in plasma proteins that are electrophoretically and antigenically indistinguishable from the usual, but which lack biological activity.

Of the complement components, C'3 is unique in that it is normally present in substantial concentration in serum and is clearly visible as a protein band in zone electrophoresis. If the electrophoresis buffer contains calcium in appropriate concentration, C'3 migrates considerably more slowly than transferrin and usually more slowly than beta lipoprotein so that it stands out in stark contrast to the immunoglobulin background (1, 2).

Recently, Wieme and Demeulenaere (3) and we (4) independently reported the occurrence in rare sera of variant C'3 which was slower in mobility on agar or agarose electrophoresis than the usual C'3. The former authors also showed that relatives of such individuals may carry similar variant C'3. Since our initial report, we have found three unrelated individuals with C'3 variants more rapid in mobility than usual. The present report is concerned with the results of studies of the variants of C'3 in these families and the relationship of the variants to "normal" C'3.

METHODS

Agarose electrophoresis. This technique was carried out according to the method of Laurell (5) on an apparatus of his design, using barbital buffer, ionic strength 0.05, pH 8.6, with 0.0018 M calcium lactate. Separation was performed on a glass plate approximately 20 × 11 × 0.2 cm in a 1 mm thick film of 1% agarose gel in electrophoresis buffer. With water cooling and an electrical potential of about 20 v/cm, prealbumin migrates about 5.5

Received for publication 25 April 1968.

cm from the origin in a routine run of 45 min. In certain experiments, 0.00125 M disodium ethylenediaminetetraacetate (EDTA) was substituted for the calcium lactate of the usual electrophoresis buffer. Although in initial experiments we used the Laurell technique unmodified, we later prolonged the electrophoresis time to more than 2 hr, so that transferrin had migrated almost to the edge of the plate and all proteins of more rapid mobility were in the electrode wicks or beyond. To standardize such separations, human red cell hemolysate was placed in the end sample slots and electrophoresis was continued until hemoglobin A reached just the edge of the plate. For other experiments, the electrophoresis apparatus was modified so that samples could be separated along the length of the plate rather than across its width, permitting an even longer experiment of 6 hr at 22 v/cm and a migration of approximately 11 cm for common C'3.

Serum samples. Approximately 1500 sera were examined by routine agarose electrophoresis. The majority were submitted to our laboratory for general evaluation of the serum proteins and were from patients with a wide variety of diseases, but with a particularly strong representation of hematologic disorders. Approximately 200 of the samples were from healthy individuals. The sera had been aged for variable and unknown lengths of time, but unconverted C'3 was visible in about 80% of them. In the remaining 20%, the C'3 was converted to β_{1A} -globulin or was obscured by beta lipoprotein or an M-component. Of approximately 1200 sera in which discrete C'3 could be observed, it was double in three. The variant sera were from patients with chronic idiopathic thrombocytopenic purpura, aplastic anemia, and trauma sustained in an automobile accident, and from a healthy person. The last variant was not found on routine (45 min) agarose electrophoresis, but by prolonged (2 hr) agarose electrophoresis. No variants were found in the sera of other patients with similar diagnoses, and, as will be seen, relatives of the propositi with the same variants were in excellent health.

Serum samples were freshly obtained from all subjects studied further and from their relatives, and were either analyzed immediately or promptly frozen at -80°C until used. Variant patterns were unchanged in samples from the same individuals, freshly obtained up to 1 yr after the initial samples.

The family of the proposita with the slow variant C'3 (Ing) had emigrated from the northern part of England around the turn of the century. Many members still reside in the United Kingdom. Of the families with fast variants, the Lap family is of French and French-Canadian origin and is believed to have come to France from Sweden, whereas the Con family are recent immigrants from Ireland. The Chi family originated in southern China.

Antigen-antibody crossed electrophoresis. The method as described by Laurell (6) and Laurell and Lundh (7) was used with antisera prepared in rabbits to human C'3 purified in this laboratory. In some instances, the initial electrophoretic separation was prolonged, as described above. To secure reference bands for the peaks obtained

during the second electrophoresis into antibody-containing agarose, the gel from the first separation immediately adjacent to that removed for the second run was fixed and stained with amido black, and placed in the same position on the stained antibody-containing plate as the original strip for that run.

Starch-gel electrophoresis. Horizontal and vertical starch-gel electrophoresis were performed according to Smithies (8) with the discontinuous buffers of Poulik (9). Separation was carried out in a cold room at 4°C at a potential of 20 v/cm for 6–7 hr for horizontal electrophoresis, and at 5 v/cm for 18–25 hr for vertical electrophoresis.

Preparation of purified C'3. "Normal" C'3 was purified¹ by the method of Nilsson and Müller-Eberhard (10). The same procedure was used to prepare C'3 from the serum of two individuals from the Lap family with fast variant C'3. Some preparations were labeled with ^{125}I by the iodine monochloride technique (11) as described previously (12). C'3 was partially purified from the serum of several members of the Ing family with slow variant C'3 and from several other selected sera by euglobulin precipitation with phosphate buffer, ionic strength 0.02, pH 5.4, for dialysis and 0.03 M phosphate buffer, pH 8, with added NaCl for redissolution as described by Müller-Eberhard, Nilsson, and Aronsson (13). Such preparations contained about 60% C'3 and since the major contaminating protein was electrophoretically diffuse IgG, were useful for analysis by electrophoresis.

Determination of C'3 concentration. C'3 concentration in fresh serum or serum stored promptly at -80°C was determined by an electroimmunochemical technique (14) and by nephelometry (15) with monospecific rabbit antisera to purified "normal" C'3. The details by which absolute concentrations in reference sera were established are given elsewhere (12).

Antigenic analysis of "normal" and variant C'3. Sera containing various types of C'3 were analyzed in the Ouchterlony technique (16) with antisera to "normal" C'3 from 10 rabbits and four goats² and with two rabbit antisera prepared against purified C'3 from serum containing a fast variant from a member of the Lap family. The latter preparation contained equal amounts of variant and "normal" C'3. In a minor modification of immunoelectrophoresis (17), sera were separated in agarose electrophoresis, troughs were cut parallel to the axis of migration, and these were filled with antiserum to C'3. Diffusion of reactants was allowed to proceed overnight at room temperature.

Preparative ultracentrifugation. Samples of fresh serum from selected individuals with variant C'3 were subjected to preparative ultracentrifugation as described by Kunkel (18) in a gradient of 10–40% sucrose. To provide sedimentation markers, the concentrations of IgG,

¹ Many of the preparations of "normal" C'3 and ^{125}I -labeled "normal" C'3 were made in collaboration with Dr. Fred S. Rosen.

² We thank Dr. John H. Robbins for preparing the goat antisera.

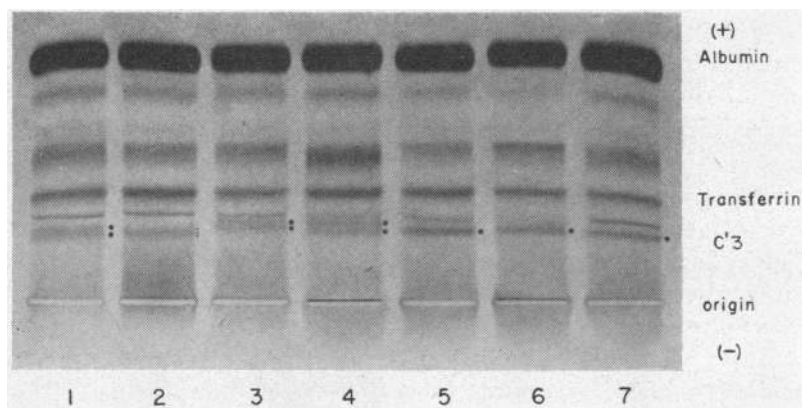

FIGURE 1 Appearance of sera with variant C'3 on routine agarose electrophoresis. From left to right, the sera are from the (1) Ing family proposita (II-3) with slow variant C'3; (2) her paternal aunt (I-3) with a pattern showing cathodal broadening and blurring; (3) a member of the Lap family (II-4) with fast variant C'3 and a "narrow" double pattern; (4) a member of the Lap family (II-5) with a "wide" double pattern; and (5-7) three individuals with "normal" C'3. The positions of the anode, the cathode, transferrin, and C'3 are marked. The beta lipoprotein is the uneven band of variable mobility between transferrin and C'3.

albumin, and alpha₂ macroglobulin were determined in each of the fractions by Laurell's electroimmunochemical technique or by nephelometry with appropriate antisera. The concentration of C'3 in each fraction was similarly determined.

Hemolytic complement activity. Hemolytic complement was measured as CH₅₀ U/ml by a micromodification (19) of Mayer's method (20).

Immune adherence. Immune adherence titers were determined by using hemolysin-sensitized sheep red cells and human red cells (21). Reactions were read by counting 100 single red cells and clusters of adherent sheep and human red cells by phase microscopy. The titer was taken as the reciprocal of the maximal dilution yielding at least 1% clusters.

Typing of red cell and serum protein factors. The red cells of the propositi with variant C'3 and of their family members were tested for the presence or absence of the following antigens: A, A₁, B, H; Rh 1, 2, 3, 4, 5, and 8; P₁; K 1, 3, and 4; Le^a, Le^b; M, N, S, s; Vw, M^e, Lu^a, Fy^a, Jk^a, and Wr^a. The sera of these individuals were also tested for haptoglobin and transferrin types and for Gm 1, 2, 3, and 5, and for Inv 1. The results of these typings were compatible with the relationships of family members as given. Linkage studies will be reported elsewhere.

RESULTS

Identification of fast and slow variants and initial family studies

The appearance of sera with "normal" C'3 and those with variant C'3 on routine agarose electro-

phoresis is shown in Fig. 1. The first sample on the left in this figure is from the proposita of the Ing family with slow variant C'3. It can be seen that the slow variant C'3 and the "normal" C'3 in this serum are of about equal concentration and that the "normal" C'3 has about the same mobility as "normal" C'3 in the three patterns at the extreme right of the figure. Pattern 2 is of serum from the paternal aunt of the slow variant proposita and shows a single but broad C'3 band with cathodal blurring. A similar C'3 pattern was found in the serum of that individual's daughter, but in no other serum that we have examined. The C'3 in the serum of all other Ing family members was "normal" in appearance.

Patterns 3 and 4 in Fig. 1 show the two types of patterns seen in both the Lap and Con family members with fast variant C'3. The patterns differ in that the distance between fast and "normal" C'3 is slightly greater in the 4th than in the 3rd pattern. This difference, though subtle, was reproducible when such sera were alternated in routine agarose electrophoresis and was found unchanged in serum freshly obtained 6 months later. Patterns of both types were found in both affected families and, in one instance, an individual with the "narrow" pattern (Fig. 1, pattern 3) had a child with the "wide" (Fig. 1, pattern 4) pattern. The

reverse was also found. When serum showing the "wide" pattern from one family was mixed in equal volume with a serum showing the "wide" pattern from the other family and the mixture was subjected to agarose electrophoresis, the resulting pattern was identical to that of either serum alone. The same was true of "narrow" patterned sera from the two families. These results indicate that the variants in the two families (Lap and Con) were electrophoretically very similar if not identical. Fast variant C'3 was found in six members of the Lap family and 11 of the Con family. The pedigrees of the Lap and Con families were consistent with autosomal codominant inheritance of the fast variant. In all cases "normal" and variant C'3 were present in approximately equal concentrations.

Evidence that the variant bands are C'3

(a) *Reaction with anti-C'3.* On antigen-antibody crossed electrophoresis with monospecific rabbit anti-C'3 antisera, bimodal peaks were seen in the patterns of fresh serum from the propositi of the Ing family (slow variant) and the Lap and Con families (fast variant). The sera from the Ing family showing broadening and cathodal blurring on routine agarose electrophoresis gave patterns that were broader than "normal" C'3 and there was a strong suggestion that these patterns were also bimodal. In agarose immunoelectrophoresis, the C'3 arcs were double with variant-containing sera, the extra arc being cathodal in the case of the serum from the Ing family proposita, and anodal in the case of serum from affected individuals from either the Con or Lap family.

(b) *Addition of ^{125}I -labeled "normal" C'3.* Since it was possible that C'3 was complexed with another protein in whole serum and the variants were a reflection of polymorphism in this hypothetical "carrier" protein, experiments were carried out with the addition of labeled "normal" C'3 to various sera. When labeled "normal" C'3 was added to sera containing slow and fast variants and the mixtures were separated in agarose electrophoresis and subjected to radioautography, the label was found in a single band overlapping "normal" C'3 in all instances, so that its mobility was uninfluenced by the carrier serum.

(c) *The effect of Ca^{++} on the electrophoretic mobility of variant C'3.* When sera were examined in agarose electrophoresis with buffers containing EDTA instead of calcium lactate, the relative positions of variant and "normal" C'3 remained unchanged, although both migrated much more rapidly. Thus, there was no obvious difference in calcium binding between "normal" and variant C'3.

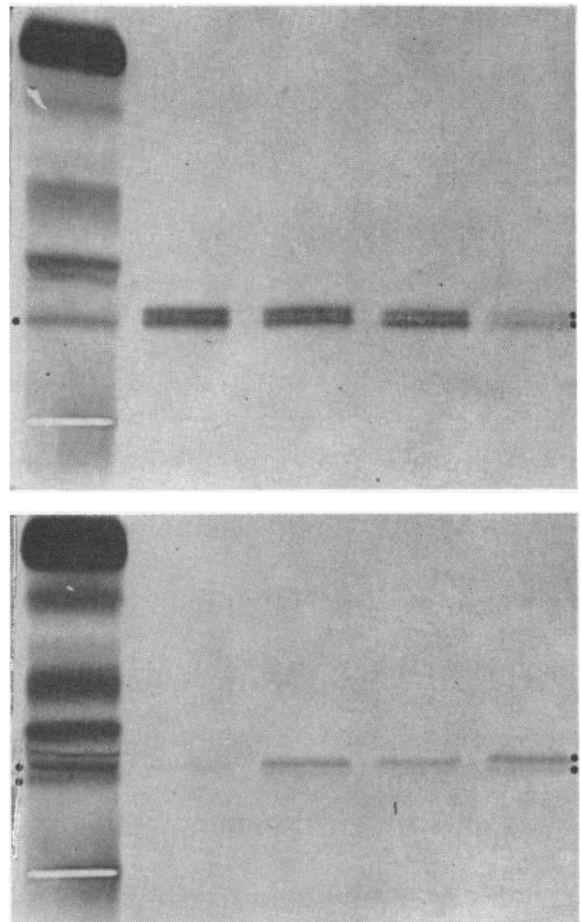

FIGURE 2 Routine agarose electrophoresis of fractions obtained during elution with 14.5 m Ω phosphate buffer at pH 7.9 of C'3 from hydroxyl apatite columns in the final steps of purification from "narrow" fast variant-containing serum (Fig. 1, pattern 3). The top portion of the figure shows normal fresh serum at the left and fractions in order of elution to the right. The bottom portion shows "wide" fast variant-containing serum (Fig. 1, pattern 4) and fractions in the same order. It will be noted that while the variant and "normal" C'3 bands are approximately equal in the fractions from the "narrow" patterned serum, they are different in the fractions from the "wide" patterned serum.

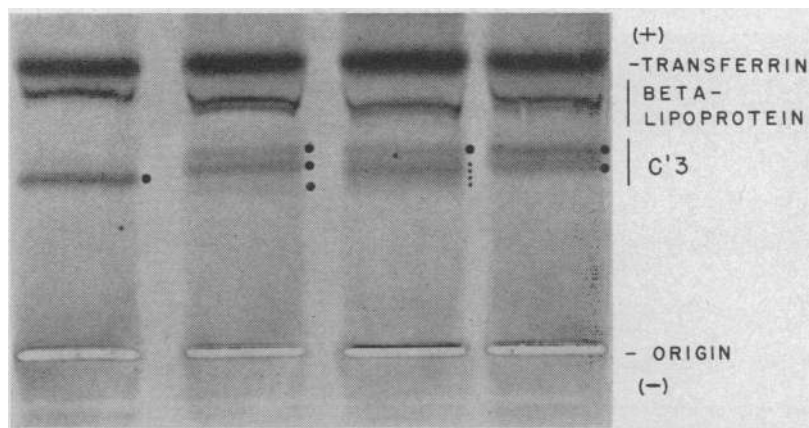

FIGURE 3 Routine agarose electrophoresis of serum mixtures. The patterns represent, from left to right, serum with "normal" C'3, a 1:1 mixture of sera with "narrow" very fast variant (F₁F) and double very slow variant (FS₁), a 1:1 mixture of sera with "wide" very fast variant (F₁S) and double very slow variant (FS₁), and, at the extreme right, a serum with "narrow" very fast variant (F₁F).

(d) *Purification of C'3 from serum containing fast variant C'3.* C'3 was purified from serum containing "narrow" fast variant C'3 by the technique of Nilsson and Müller-Eberhard (10). Samples were taken at various points during purification and were examined by agarose electrophoresis. The variant and "normal" C'3 bands were found in equal concentration throughout the purification.

However, when the C'3 from a serum containing "wide" fast variant C'3 was purified and examined in the same way, it was found that the first fractions from the final elution in hydroxyl apatite chromatography were relatively enriched in the fast variant, whereas the later fractions showed the two bands to be more equal. These patterns are shown in Fig. 2. The "wideness" and "narrow-

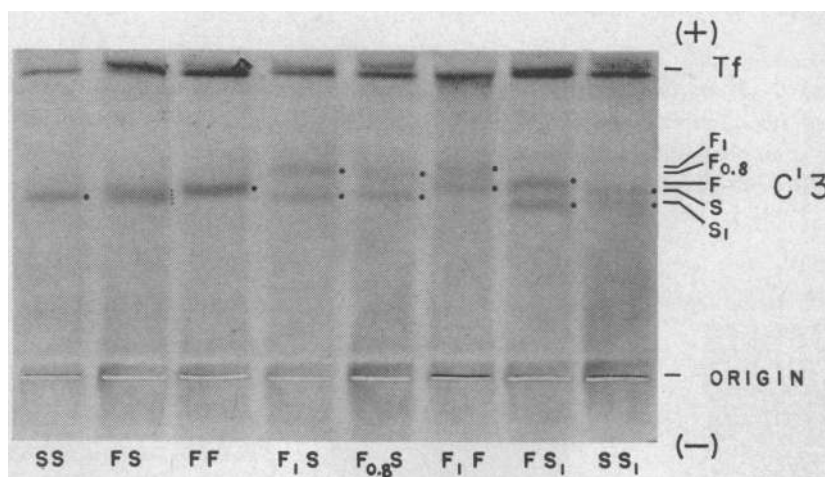

FIGURE 4 Prolonged agarose electrophoresis showing the eight known phenotypes of human C'3. It will be noted that while the three common phenotypes (SS, FS, and FF) are distinguishable, the FS pattern is broad but not clearly double. The SS₁ pattern which was broad and blurred on routine agarose electrophoresis is clearly double in this prolonged separation. The F₁ and S₁ bands are of similar mobility in the sera which contain them and the "wideness" and "narrowness" is seen to be determined by the presence of one or the other of the common F and S allotypes.

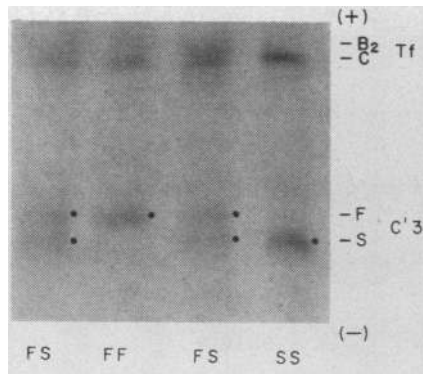

FIGURE 5 Prolonged agarose electrophoresis on the modified apparatus showing the patterns given by FF, FS, and SS C'3. The two sera with the FS pattern are from a single individual who is also heterozygous for transferrin (B₂C).

ness" of the patterns was preserved throughout purification.

(e) *Addition of ¹²⁵I-labeled variant-containing C'3.* Some of each of the two preparations of variant-containing C'3 described above were labeled with ¹²⁵I and added to various "normal" and variant sera. After agarose electrophoresis and radioautography, it was seen that the position of both bands of radioactivity was unaffected by the type of carrier serum.

Evidence for genetic polymorphism in "normal" C'3

We have assumed up to this point that "normal" C'3 is homogeneous in the serum of all individuals who show a single band on routine agarose electrophoresis. Three findings now argue against

this assumption: (a) the existence of "wide" and "narrow" double C'3 patterns in both families with fast variant C'3; (b) the occurrence of broadened, blurred C'3 bands in the sera of relatives of the individual with slow variant C'3 rather than the clear-cut double pattern of the proposita; and (c) the difference in elution characteristics from hydroxylapatite of "normal" C'3 from individuals with "wide" and "narrow" fast variant patterns. The most reasonable explanation for these phenomena is that there are two allotypes of common C'3 of close, but not identical electrophoretic mobilities. If we call the faster of these common variants F and the slower one S, and we assign the designations F₁ and S₁ to the rare very fast and very slow variants, and we assume autosomal codominant inheritance for the common alleles as well as the rarer ones we can make certain predictions. In accordance with these assumptions, individuals with very fast wide double C'3 would be of the phenotype F₁S, whereas those with the narrow pattern would be F₁F. Similarly, the proposita of the Ing family with a clear-cut double pattern with the very slow variant would be FS₁, whereas her relatives with the broad, blurred patterns would be SS₁. The assumptions clearly demand that the rare variant bands be of identical electrophoretic mobility in all affected family members, and that there be demonstrably different mobilities in the C'3 with common mobility in family members with different variant patterns. Finally, it must be possible to type serum from people with common C'3 into three predicted phenotypes: FF, FS, and SS.

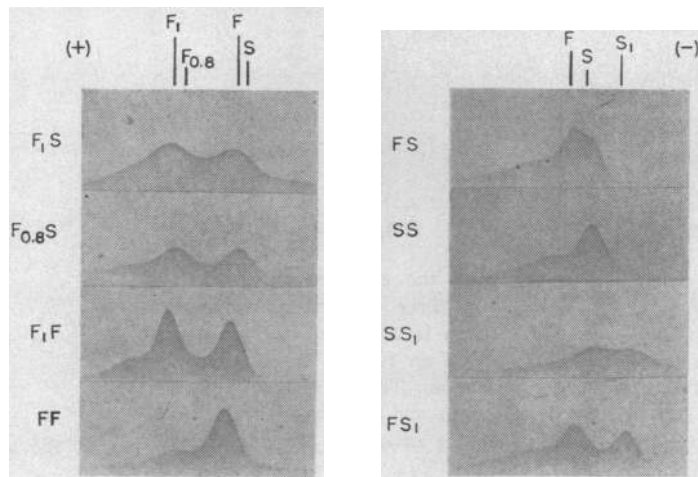

FIGURE 6 Antigen-antibody crossed electrophoresis patterns of the eight known phenotypes of C'3. The initial separations were performed in prolonged runs on the modified apparatus. The positions of the peaks are indicated at the top of the figure and the types are shown at the left of each pattern. It will be noted that most patterns show an additional small peak or shoulder more anodal than the major single or double C'3 peaks.

Artificial mixtures of sera

From the foregoing, it was predicted that a mixture of "narrow" very fast variant-containing serum (F_1F) and double very slow variant-containing serum (FS_1) would yield a pattern on agarose electrophoresis in which three bands would be visible with reinforcement of the middle (F) band. Such proved to be the case, as seen in Fig. 3. Furthermore, a mixture of "wide" very fast variant-containing serum (F_1S) and double slow variant-containing serum (FS_1) would be expected to have an appearance approaching that of the "narrow" very fast variant-containing serum, plus a mimicking of the broadened, blurred patterns seen in the Ing family. Again, this was borne out (Fig. 3).

Prolonged agarose electrophoresis

When sera were subjected to prolonged agarose electrophoresis, it was possible to confirm the presence of the common allotypes. Fig. 4 shows the appearance of the eight phenotypes of $C'3$ encountered so far. The 4th pattern from the right in the upper half of the figure was found in a random sample of Oriental individuals and the propositus was a member of the Chi family. As can be seen, the very fast variant $C'3$ in his serum is slightly slower in mobility than that of the Lap

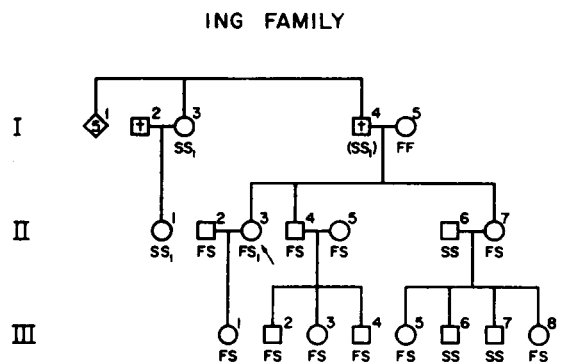

FIGURE 7 The genealogy of the Ing family with very slow variant $C'3$ (S_1). The Roman numerals at the left of the pedigree refer to generations, the Arabic numerals at the upper right of each circle (female) or square (male) are designations of individuals within a generation, and the letters below them are $C'3$ types. The $C'3$ types in parentheses are presumed types of deceased persons. Where no $C'3$ type is given, the individual has not been tested. A diamond with an Arabic numeral within it indicates the number of untested siblings.

LAP FAMILY

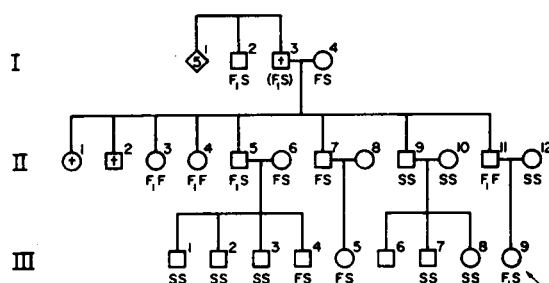
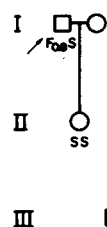

FIGURE 8 The Lap family with very fast variant $C'3$ (F_1). For explanations of the symbols, see Fig. 7.

CHI FAMILY



CON FAMILY

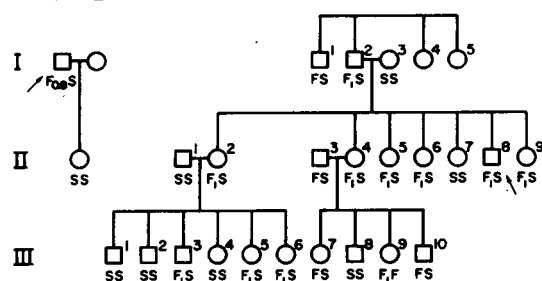

FIGURE 9 The Con family with very fast variant $C'3$ (F_1) and the Chi family with a different very fast variant ($F_{0.8}$). For explanations of the symbols, see Fig. 7.

and Con families and has been called $F_{0.8}$. The patterns of the common three phenotypes in prolonged agarose electrophoresis on the modified apparatus are shown in Fig. 5. The final evidence that all of these bands are $C'3$ is shown in Fig. 6 in the series of antigen-antibody crossed electrophoresis patterns representing all the phenotypes thus far found.

It will be noted that the leading peak in the bimodal patterns and the single main peak of FF and SS $C'3$ show an anodal shoulder. Thus, there is additional minor $C'3$ -related material in the fresh serum of all $C'3$ types. The protein bands corresponding to these minor peaks are faintly visible in some of the agarose electrophoresis patterns shown in Figs. 4 and 5.

Family studies

Figures 7-9 give the pedigrees and $C'3$ types of the Ing, Lap, Con, and Chi families. It will be seen that the inheritance of three of the five alleles

TABLE I
C'3 Types in Random Unrelated Individuals

Race	Total No.	Phenotypes				Gene frequencies*	
		SS	FS	FF	F _{0.8} S	S	F
Caucasian	94	51	38	5	0	0.75 (0.69-0.81)‡	0.25 (0.19-0.31)‡
Negro§	29	23	6	0	0	0.90 (0.79-0.96)‡	0.10 (0.04-0.21)‡
Oriental	29	28	0	0	1	0.98 (0.91-1.00)‡	0 (0-0.05)‡
C'3 concentration¶ mg/100 ml	157.4 ± 3.7	153.0 ± 3.9	129.0 ± 8.8				

* The interval estimates of gene frequency are calculated for 95% confidence.

‡ The frequencies of genes F and S differed significantly among the races: Caucasian vs. Negro, $P = 0.015$ (χ^2 test); Negro vs. Oriental, $P = 0.027$ (two-tailed Fisher's exact test).

§ Of the Negroes, 28 were Americans and 1 was African.

|| The Oriental subjects consisted of 26 Chinese, 2 Koreans, and 1 Japanese.

¶ Mean C'3 concentrations of all sera of the same phenotype are given ± SE of the mean.

(F₁, F, and S) is consistent with the autosomal codominant pattern, in that there is male to male transmission and some males are heterozygotes. Owing to the paucity of Chi family members and the fact that the daughter of the propositus was of the common SS type, it was not possible to establish the inheritance of the F_{0.8} allele.

Incidence of common alleles of C'3

To obtain a rough estimate of the incidence of the common C'3 genes, randomly obtained fresh sera from Caucasians, Orientals, and Negroes were examined. The results are presented in Table I. The data suggest that there is a difference in gene frequencies among the major races, with the F gene most common in Caucasians and least common in Orientals. In addition, there is a suggestion that the F allotype occurs in lower concentration than the S allotype in random populations.

Complement activity in the various C'3 allotypes

Selected samples of sera containing different phenotypes of C'3 were analyzed for C'3 concentration, hemolytic complement activity, and immune adherence activity. The results of these studies are given in Table II. No abnormalities were found in these activities in any of the sera tested.

Size of the C'3 allotypes

The euglobulin fraction of sera containing F₁F, F₁S, and FS₁ C'3 examined in starch-gel electrophoresis showed that the C'3 bands occupied relative positions similar to those in agarose elec-

TABLE II
Complement Activity and C'3 Concentration in Sera Containing Different Types of C'3

Subject*	C'3 type	C'3 concentration		IA titer‡
		mg/100 ml	U/ml	
Con II-8	F ₁ S	165	39	8000
Lap II-5	F ₁ S	162	33	8000
Chi I-1	F _{0.8} S	138	39	8000
Lap II-4	F ₁ F	172	43	4000
Lap II-3	F ₁ F	155	39	8000
Ing II-3	FS ₁	161	38	8000
Ing II-1	SS ₁	130	37	4000
R.N. 17	FF	157	39	4000
R.N. 40	FF	119	33	4000
Con II-3	FS	125	42	4000
Ing III-5	FS	158	43	8000
R.N. 78	SS	147	39	8000
Con II-7	SS	151	30	4000

* Subjects are either family members (see Figs. 7 to 9) or random normal individuals (R.N.) assigned numbers in order of sampling.

‡ The IA (immune adherence) titer is the reciprocal of the dilution yielding at least 1% adherent red cell clusters on phase microscopy.

trophoresis, suggesting that the differences among the variants lay solely in net surface charge and not size. When whole sera of these types were examined in sucrose density gradient ultracentrifugation, C'3 formed a single peak with an approximate sedimentation constant of 9.5S, as is true of common C'3 (13), indicating that the variants are the same size as common C'3.

Antigenic analysis

No spurs were detected in Ouchterlony analysis between C'3 of different phenotypes with many different antisera prepared against "common" C'3 or against F₁F C'3. There was a similar reaction of complete identity between the different allotypes of C'3 in sera representing the six known heterozygous phenotypes when these were examined in prolonged agarose immunoelectrophoresis.

DISCUSSION

The fact that the common polymorphism of C'3 has not been recognized earlier is undoubtedly related to the large size of this serum protein and the resulting small charge to mass ratio. It is only with a technique that permits rapid electrophoretic separation and a minimum of diffusion that the common phenotypes are distinguishable.

In a brief publication, Ropartz and coworkers (22) described a polymorphism in C'3 in which some human sera but not others inhibited the agglutination of C'3-coated red cells by selected human sera. No data concerning family studies were presented and the relationship to the electrophoretic polymorphism is unknown.

The very slow electrophoretic variant described by Wieme and coworkers (3, 23) in two families may be the same as S₁ or an even slower allotype. The fact that the sera from individuals with the variant in each of three generations showed unequivocal double patterns in agar electrophoresis suggests that the variant was slower than S₁ or, less likely, that the variant had the mobility of S₁ and all spouses of carriers of the variant gene in the 1st two generations, and in the generation preceding the 1st, carried and transmitted F genes.

Wieme (24) had earlier described what were probably variants of C'3 in three sera. Two of the additional bands were more rapid than normal and one was slower. His evidence that these unusual bands were C'3 variants rested on the fact

that they were labile on storage. No studies of the reaction with anti-C'3 antibody or of the relative concentrations of the variant and common C'3 in any given sera were presented. The variants were sought, but not found in relatives of affected individuals. Nevertheless, it may be that these bands represented genetically variant C'3, and the inability to find these variants in family members may have resulted from polymorphism in the common C'3 and insufficient electrophoretic separation.

The nomenclature we have used is based on the relative mobilities of variants with respect to the S allotype, and we have arbitrarily designated the distance between S and our fastest variant and S and our slowest variant as 1.0. Since the variant in the serum of the Chi family propositus migrates about 80% of the distance from S to F₁, it has been designated F_{0.8}. The reason for using these three forms of C'3 as reference points rather than some other serum protein such as transferrin is that, in our system, small changes in Ca⁺⁺ concentration produce rather large changes in absolute (but not relative) mobilities of C'3 in all its known forms.

The structural basis for the differences in net surface charge of the C'3 variants is unknown. Preliminary work on the appearance of conversion products of FS₁ C'3 (3) and F₁S C'3 indicates that these four allotypes convert at about the same rate and that both C'3_i and beta_{1A}-globulin are double. This is evidence that the structural features that distinguish F₁ and S₁ from common C'3 are present in the inactive portion of the molecule and not in the biologically active small polypeptides (25-27) split from native C'3. Attempts to define further the structural bases for C'3 polymorphism are in progress.

The presence of minor C'3-related protein of more rapid mobility than the main protein in serum of all phenotypes is strongly reminiscent of what is found with alpha₁ antitrypsin (28) in antigen-antibody crossed electrophoresis. In the case of the latter protein, the additional minor material is slower than the main protein. One cannot exclude the possibility that the minor C'3 bands represent heretofore unrecognized conversion products. This possibility is made less likely by the fact that they were detectable in EDTA plasma separated promptly from whole blood, and immediately subjected to electrophoresis in agarose

containing EDTA with EDTA in the electrode buffers. Our finding of only single minor anodic bands or peaks in all sera, including those from heterozygotes, is almost certainly the result of obscuration of the minor bands or peaks associated with the slower gene product by the faster main gene product present in high concentration. It is interesting that the distance from the main protein to the minor anodal material is approximately the same for S, F, and F₁ C'3.

It will be noted in Fig. 6 that the more anodal main C'3 peak in all sera from heterozygotes, with the possible exception of F_{0.8}S, is slightly higher than the slower peak in the same serum. This phenomenon has also been observed with alpha₁ anti-trypsin (28) and is consistent with the faster of the two gene products being slightly higher owing to its mobility.

Although the number of sera from random populations examined thus far is small, several observations are possible. Our data suggest that the F gene is most common in Caucasians, less common in American Negroes, and relatively rare in Orientals. The F₁, S₁, and F_{0.8} genes are probably rare in all populations.

It may be that the serum concentration of the F allotype is lower than that of the S allotype since the mean concentration of C'3 is lowest in FF individuals, highest in SS individuals, and intermediate in FS heterozygotes. The number of FF individuals are too small to permit a definite judgment. If the differences in concentrations are significant, they may reflect either differential rates of synthesis or catabolism for the two allotypes.

ADDENDUM

Since the submission of this manuscript, we have found two additional allotypes of C'3: F_{0.5} and S_{0.5}. Detailed studies of these variants will be published elsewhere.

ACKNOWLEDGMENTS

We are grateful to Doctors Mark Cooley, Gerald Bloom, and George Hewett for providing us with blood samples from their patients. We are indebted to the members of the Ing, Lap, Con, and Chi families for their whole-hearted cooperation. We are particularly indebted to Dr. Peter Behan for his generous help in arranging for the collection of samples in England and their transportation to Boston. Doctors F. S. Mooney and G. Birchall kindly obtained and shipped these samples. Mrs. Eileen Gordon, formerly of our laboratory, first detected the fast variant

C'3 in the serum of the proposita of the Lap family. We thank Doctors Louis Diamond, Park Gerald, Irving Umansky, and Fred Rosen for many useful discussions, and Dr. Jane Desforges for help in obtaining blood samples for some of the gene frequency studies. Dr. Olli Miettinen performed the calculations of gene frequencies and their statistical analysis.

This work was supported in part by a grant from the U. S. Public Health Service (HD 02723). Dr. Richard P. Propp is the recipient of a special fellowship from the U. S. Public Health Service (1 F3 AM-37,274).

REFERENCES

1. Laurell, C. B., S. Laurell, and N. Skoog. 1956. Buffer composition in paper electrophoresis. Considerations on its influence, with special reference to the interaction between small ions and proteins. *Clin. Chem.* 2: 99.
2. Laurell, C.-B., and B. Lundh. 1962. An electrophoretic method for estimation of some β -globulins. *Scand. J. Clin. Lab. Invest.* 14: 490.
3. Wieme, R. J., and L. Demeulenaere. 1967. Genetically determined electrophoretic variant of the human complement component C'3. *Nature.* 214: 1042.
4. Alper, C. A., and R. P. Propp. 1967. An electrophoretic variant of C'3. *Clin. Res.* 15: 291. (Abstr.)
5. Laurell, C.-B., and J.-E. Niléhn. 1966. A new type of inherited serum albumin anomaly. *J. Clin. Invest.* 45: 1935.
6. Laurell, C.-B. 1965. Antigen-antibody crossed electrophoresis. *Anal. Biochem.* 10: 358.
7. Laurell, C.-B., and B. Lundh. Electrophoretic studies of the conversion products of serum β_{1c} -globulin. *Immunology.* 12: 313.
8. Smithies, O. 1959. An improved procedure for starch-gel electrophoresis: further variations in the serum proteins of normal individuals. *Biochem. J.* 71: 585.
9. Poulik, M. D. 1957. Starch gel electrophoresis in a discontinuous system of buffers. *Nature.* 180: 1477.
10. Nilsson, U. R., and H. J. Müller-Eberhard. 1965. Isolation of β_{1F} -globulin from human serum and its characterization as the fifth component of complement. *J. Exptl. Med.* 122: 277.
11. McFarlane, A. S. 1958. Efficient trace-labelling of protein with iodine. *Nature.* 182: 53.
12. Alper, C. A., and F. S. Rosen. 1967. Studies of the in vivo behavior of human C'3 in normal subjects and patients. *J. Clin. Invest.* 46: 2021.
13. Müller-Eberhard, H. J., U. Nilsson, and T. Aronson. 1960. Isolation and characterization of two β_1 -glycoproteins of human serum. *J. Exptl. Med.* 111: 201.
14. Laurell, C.-B. 1966. Quantitative estimation of proteins by electrophoresis in agarose gel containing antibody. *Anal. Biochem.* 15: 45.
15. Boyden, A., E. Bolton, and D. Gemeroy. 1947. Precipitin testing with special reference to the photoelectric measurement of turbidity. *J. Immunol.* 57: 211.

16. Ouchterlony, Ö. 1953. Antigen-antibody reactions in gels. IV. Types of reactions in coordinated system of diffusion. *Acta Pathol. Microbiol. Scand.* 32: 231.
17. Grabar, P., and C. A. Williams, Jr. 1955. Méthode immuno-électrophorétique d'analyse de mélanges de substances antigéniques. *Biochim. Biophys. Acta.* 17: 67.
18. Kunkel, H. G. 1960. Macroglobulins and high molecular weight antibodies. In *The Plasma Proteins*. F. W. Putnam, editor. Academic Press Inc., New York, 1: 279.
19. Klemperer, M. R., H. C. Woodworth, F. S. Rosen, and K. F. Austen, 1966. Hereditary deficiency of the second component of complement (C'2) in man. *J. Clin. Invest.* 45: 880.
20. Kabat, E. A., and M. M. Mayer. 1961. Complement and complement fixation. In *Experimental Immunochimistry*. Charles C Thomas, Springfield. 2nd edition. 133.
21. Nishioka, K. 1963. Measurements of complement by agglutination of human erythrocytes reacting in immune-adherence. *J. Immunol.* 90: 86.
22. Ropartz, C., L. Rivat, P.-Y. Rousseau, P. Debeaux, and M. Steinbuch. 1965. Un nouveau polymorphisme sérique humain défini par l'utilisation de globules rouges tannés et revêtus de bêta-1C. *Proc. Intern. Soc. Blood Transf.* 10: 383.
23. Wieme, R. J., L. Demeulenaere, and J. Segers. 1967. Familial occurrence of electrophoretic C'3 variants in man. In *Protides of the Biological Fluids*. Proceedings of the Fifteenth Colloquium. H. Peeters, editor. Elsevier Publishing Co., Amsterdam. 499.
24. Wieme, R. J. 1965. Agar Gel Electrophoresis. Elsevier Publishing Co., Amsterdam. 238.
25. Dias da Silva, W., J. W. Eisele, and I. H. Lepow. 1967. Complement as a mediator of inflammation. III. Purification of the activity with anaphylotoxin properties generated by interaction of the first four components of complement and its identification as a cleavage product of C'3. *J. Exptl. Med.* 126: 1027.
26. Müller-Eberhard, H. J., M. J. Polley, and M. A. Calcott. 1967. Formation and functional significance of a molecular complex derived from the second and the fourth component of complement. *J. Exptl. Med.* 125: 359.
27. Ward, P. A. 1967. A plasmin-split fragment of C'3 as a new chemotactic factor. *J. Exptl. Med.* 126: 189.
28. Axelsson, U., and C.-B. Laurell. 1965. Hereditary variants of serum α_1 -antitrypsin. *Am. J. Human Genet.* 17: 466.