

# Genetically Determined Heterogeneity of the C1 Esterase Inhibitor in Patients with Hereditary Angioneurotic Edema

FRED S. ROSEN, CHESTER A. ALPER, JACK PENSKY, MARTIN R. KLEMPERER, and VIRGINIA H. DONALDSON

*From the Department of Pediatrics and the Blood Grouping Laboratory, Harvard Medical School, Boston, Massachusetts 02115; the Institute of Pathology, Case Western Reserve University School of Medicine, Cleveland, Ohio 44106; and the Departments of Medicine and Pediatrics, University of Cincinnati College of Medicine, Cincinnati, Ohio 45220*

**ABSTRACT** Normal human serum contains  $18 \pm 5$  mg/100 ml of C1 esterase inhibitor (alpha-2 neuraminoglycoprotein) as estimated by immunochemical means. Of 118 patients with hereditary angioneurotic edema, the sera of 80, from 42 kindred, contained a mean concentration of 3.15 mg/100 ml or 17.5% of normal. The mean serum concentration in 35 patients in 7 other kindred was 20 mg/100 ml or 111% of normal, and 3 patients in another kindred contained over 80 mg/100 ml or greater than 400% of normal. The nonfunctional inhibitors in patients' sera of these eight kindred were identical with normal C1 esterase inhibitor by Ouchterlony analysis, but they were different from normal and from each other with respect to their electrophoretic mobility, their capacity to bind C1 esterase, and their ability to inhibit esterolysis of *N*-acetyl-tyrosine-ethyl-ester.

## INTRODUCTION

The serum of patients with hereditary angioneurotic edema lacks normal inhibitory activity directed against an esterase derived from the first component of complement (1). This inhibitory activity is the property of a normal alpha-2 globulin of human serum (2), which is identical with the alpha-2 neuraminoglycoprotein (3). Specific antiserum has been prepared against this pro-

A portion of this work was presented at the Annual Meeting of the American Society for Clinical Investigation, Atlantic City, N. J.: 1970. *J. Clin. Invest.* 49: 2a. (Abstr.)

Some of this work was done during the tenure of an Established Investigatorship of the American Heart Association held by Dr. Donaldson. Dr. Rosen is a recipient of Career Development Award AM-19,650 of the U. S. Public Health Service.

Received for publication 8 March 1971 and in revised form 3 May 1971.

tein, enabling immunochemical estimation of its content in normal and pathological sera (4).

Although the tendency to sustain attacks of angioneurotic edema is inherited as an autosomal dominant trait, the serum of most affected persons contains much less than the anticipated 50% of the normal serum concentration of C1 esterase inhibitor measurable as antigen. The sera of a minority of patients, however, contain normal or elevated concentrations of C1 esterase inhibitor. The present studies concern the quantitation and characterization of C1 esterase inhibitor antigen in the sera of patients from 50 kindred affected with hereditary angioneurotic edema.

## METHODS

**Patients.** 118 patients from 50 kindred with hereditary angioneurotic edema were studied. The diagnosis of the defect was based on the clinical history, serum titers of C4 and C2, and the inability of affected sera to inhibit the hydrolysis of *N*-acetyl-L-tyrosine ethyl ester by  $\text{C}\bar{1}$ . The extant first-degree relatives of all propo-  
siti were studied.

**Sera.** Serum was separated from freshly clotted blood by centrifugation and stored at  $-80^{\circ}\text{C}$ . Some serum samples were shipped in dry ice and then stored at  $-80^{\circ}\text{C}$  until used. Some serum portions were treated exhaustively with neuraminidase (type V; Sigma Chemical Co., St. Louis, Mo.) as previously described (5). Purified C1 esterase inhibitor was incubated at  $37^{\circ}\text{C}$  for 1 hr with neuraminidase at pH 6.0. The reaction was stopped by addition of 0.2 M ice-cold Tris-HCl buffer, pH 8.6.

**Purification of proteins.**  $\text{C}\bar{1}$  was purified according to the method of Haines and Lepow (6) from fresh normal human serum. There was no detectable contaminating protein as assessed by electrophoresis in agarose (7).

C1 esterase inhibitor was purified from fresh normal human serum by an elaboration of methods previously published (2). Solid ammonium sulfate was added to serum to 40% saturation (24.2 g/100 ml), and the mixture was kept at  $0^{\circ}\text{C}$  overnight. After removal of precipitated pro-

tein by centrifugation, the supernatant solution was dialyzed exhaustively against water at 4°C and again centrifuged to remove a small amount of precipitate. The clear 40% ammonium sulfate supernatant was separated on a column of Dowex 2-X10, 200-400 mesh (lot 35045-29; Bio Rad Labs, Richmond, Calif.), equilibrated with 0.06 M Tris-HCl buffer, pH 7.3. Elution of crude inhibitor from Dowex-2 columns was performed by stepwise increases in NaCl concentration. Fractions containing inhibitor were pooled and concentrated 10- to 20-fold of the original sample volume in a bed of dry polyethylene glycol (Carbowax 20M; Union Carbide Chemicals & Plastics Corp., New York). Concentrated inhibitor was dialyzed against 0.02 M glycine-NaOH buffer, pH 9.0, and chromatographed on a column of DEAE-cellulose (type 20, high capacity, 1.17 mEq/g, from Schleicher & Schuell Inc., Keene, N. H.) equilibrated with the same buffer. Protein was eluted from the column by a linear concentration gradient to 0.3 M NaCl dissolved in equilibration buffer. Inhibitor activity emerged as part of the first protein peak at approximately 0.16 M NaCl. The most active fractions from the center of the peak were pooled, reconstituted, and rechromatographed under the same conditions. The purest fractions were again pooled, concentrated by pressure dialysis, and dialyzed against phosphate-buffered NaCl-KCl (Dulbecco A buffer, Oxoid, from Consolidated Laboratories, Inc., Chicago Heights, Ill.)

**Radioiodination.** Purified C1s was labeled with <sup>125</sup>I according to the method of McFarlane (8).

**Preparation of antisera.** Goats were injected intradermally with purified C1 esterase inhibitor or alpha-2 neuraminoglycoprotein (3) emulsified in complete Freund's adjuvant at biweekly intervals. Antisera were harvested 2 wk after the last immunization. The antisera thus obtained were monospecific (Fig. 1).

**Quantitation of C1 esterase inhibitor.** The serum concentration of inhibitor protein was estimated by electroimmunodiffusion (9) (Fig. 1). Functional inhibitor activity was measured as previously described (1). The absolute

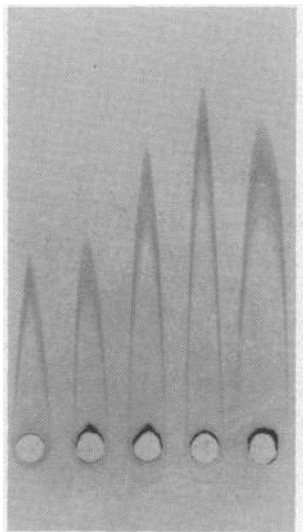

FIGURE 1 Electroimmunodiffusion of two normal sera (on the left) and three sera (on the right) with elevated concentrations of C1 esterase inhibitor into agarose-containing goat antiserum to C1 esterase inhibitor.

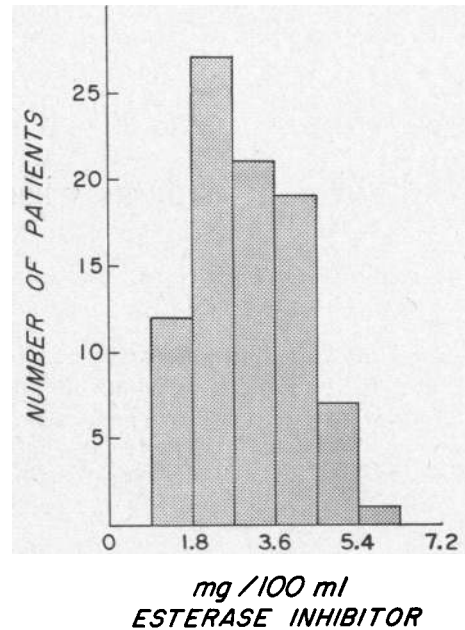

FIGURE 2 The incidence of C1 esterase inhibitor concentration in sera of 80 patients deficient in antigenic C1 esterase inhibitor.

concentration of inhibitor protein was determined by using a highly purified preparation of alpha-2 neuraminoglycoprotein as a standard. The normal serum concentration was estimated to be  $18 \pm 5$  mg/100 ml.

**Immunofixation.** Immunofixation after agarose gel electrophoresis was performed as previously described (10). Radioautography of immunofixed plates was carried out by exposing them after washing, drying, and staining to Kodak No-screen X-ray film.

## RESULTS

The serum concentration of C1 esterase inhibitor determined by immunochemical means in 80 patients in 42 kindred with hereditary angioneurotic edema varied between 0.9 and 5.6 mg/100 ml (normal mean = 18 mg/100 ml). The mean of the results in these 80 patients' sera was 3.15 mg/100 ml or 17.5% of normal. The modal concentration, however, was between 1.8 and 2.7 mg/100 ml or 10 and 15% of normal. These results are shown in Fig. 2.

The mean serum concentration of C1 esterase inhibitor determined by immunochemical means in 35 patients in 7 other kindred was 20 mg/100 ml or 111% of the normal mean with a range of 10.8-31.5 mg/100 ml; the mode was between 18 and 20 mg/100 ml or 100 and 110% of normal. In one kindred, the sera of all three affected individuals contained greater than 80 mg/100 ml or 400% of the normal concentration (family Da, Fig. 3).

Hereafter, the three groups of patients will be designated low, normal, or high antigen concentration groups.

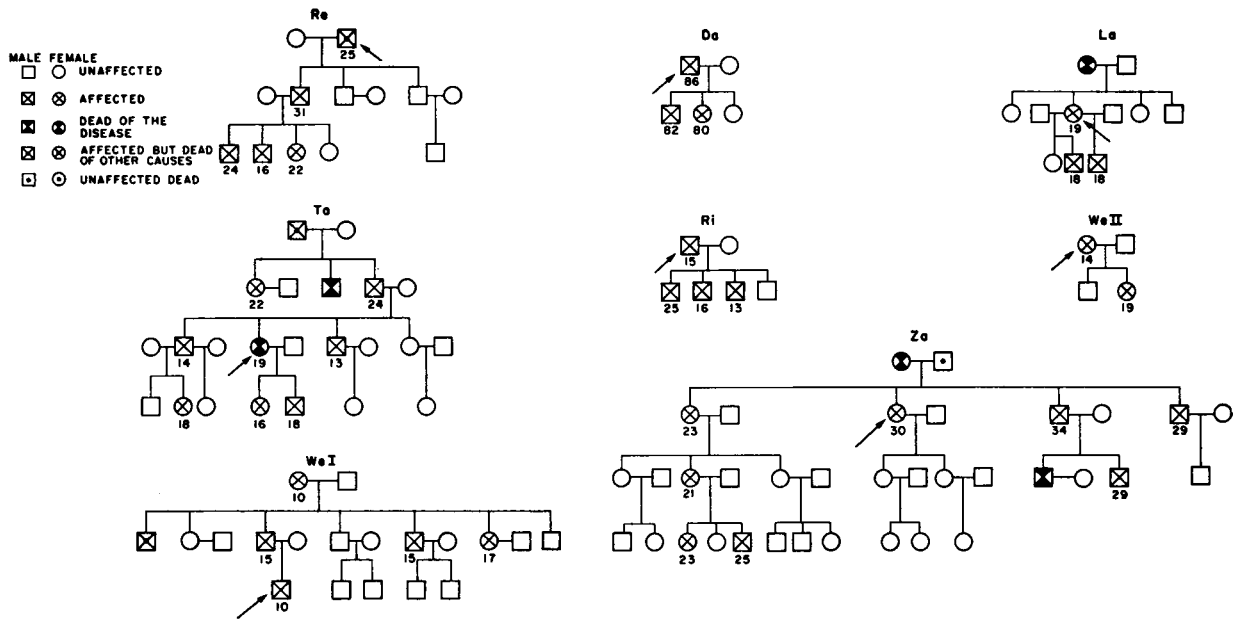

FIGURE 3 Pedigrees of 38 patients whose sera contain normal or elevated concentrations of C1 esterase inhibitor. The subscripts denote the concentration of C1 esterase inhibitor in milligrams/100 milliliters.

The genealogies of the eight kindred in the normal and high antigen concentration groups are shown in Fig. 3. It can be seen in Fig. 3 that the disease is transmitted as an autosomal dominant trait in these groups, as had been previously established in the low antigen concentration group.

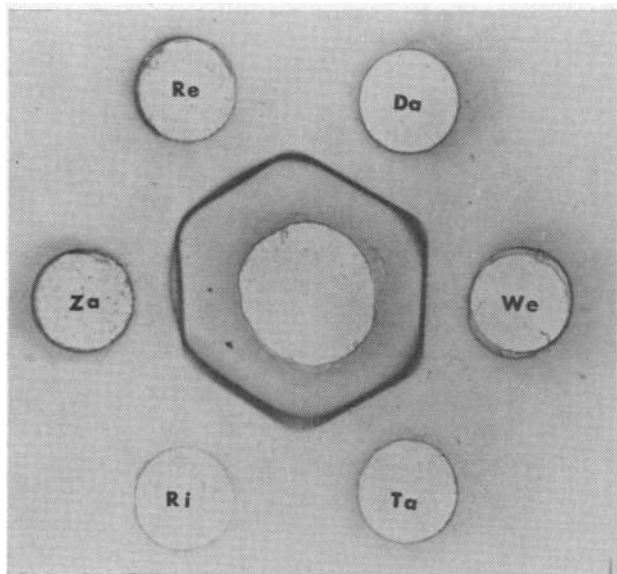

FIGURE 4 Double diffusion in agar of goat antiserum to C1 esterase inhibitor (center well) and sera containing nonfunctional C1 esterase inhibitor. The letters designate the kindred shown in Fig. 3.

When the sera of affected members of the kindred with normal or high antigens were tested by double diffusion with goat antiserum to normal inhibitor, a line of complete fusion was consistently obtained with normal serum and other nonfunctional proteins in patients' sera (Fig. 4).

Immunofixation of the C1 esterase inhibitor in the serum of individuals with low antigen concentration revealed normal electrophoretic mobility in each instance, as exemplified in Fig. 5 by "St." By the same technique, sera of affected individuals in family WeI contained C1 esterase inhibitor of normal mobility, whereas affected

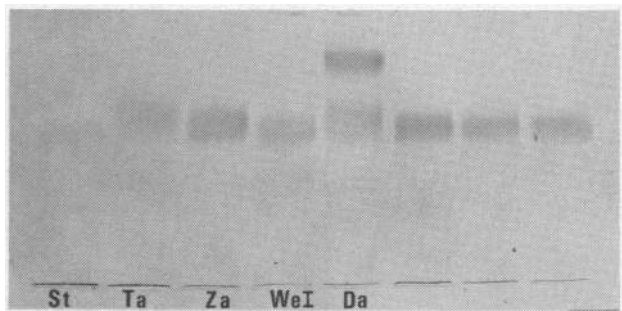

FIGURE 5 Immunofixation of C1 esterase inhibitor. The letters designate the kindred shown in Fig. 3, except for "St" which is a serum containing 5% of normal C1 esterase inhibitor. The undesignated bands on the right are normal serum, normal serum to which an excess of CIs had been added, and normal serum to which an antigen-antibody aggregate had been added. There is no difference among them.

TABLE I  
Effect of Neuraminidase on Purified C1 Esterase Inhibitor Activity\*

Neuraminidase	C1 esterase inhibitor
$\mu/ml$	$\mu/ml$
0	23.6
50	25.6
100	24.6
200	24.6

\* C1 esterase inhibitor (24 U/ml) incubated for 1 hr at 37°C in 0.1 M acetate buffer, pH 6.0. Reaction stopped by addition of 0.2 M ice-cold Tris-HCl buffer, pH 8.6. Under these conditions, 37  $\mu g/ml$  of neuraminidase would completely liberate the neuraminic acid from C1 esterase inhibitor. *N*-Acetylneuraminic acid was determined by the method of Warren (11).

individuals in families Ri, WeII, Re, Za, and La had C1 esterase inhibitor of more rapid mobility than the normal, and the C1 esterase inhibitor in family Ta had a

markedly increased mobility. The C1 esterase inhibitor in the affected sera of kindred Da with high antigen concentration exhibited two bands of precipitation, the more cathodal of which had the same mobility as that of families Ri, Re, Za, WeII, and La, the more anodal band had alpha-1 mobility (Fig. 5).

An attempt was made to ascertain whether or not the observed differences in mobility of the nonfunctional proteins were due to differences in the neuraminic acid content or in their amino acid composition. After treatment of serum samples or purified C1 esterase inhibitor with neuraminidase, followed by electrophoresis and immunofixation, the net electrical charge of the C1 esterase inhibitor was so reduced that the protein in both normal and patients' sera failed to migrate significantly. Normal C1 esterase inhibitor does not lose its functional capacity under these conditions despite the alteration in electrophoretic mobility (Table I).

The gel filtration patterns on Sephadex G200 of C1 esterase inhibitor from normal sera and patients' sera were compared. As shown in Fig. 6, the C1 esterase in-

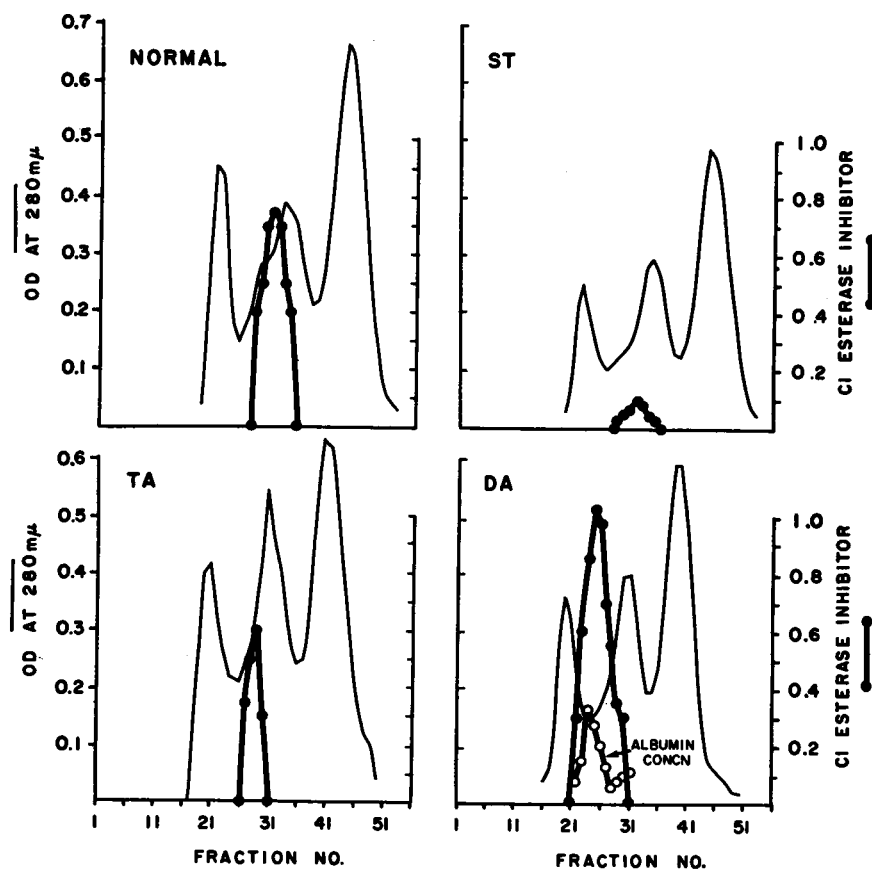

FIGURE 6 Elution pattern from gel filtration on Sephadex G200 of normal serum and sera of patients in the low antigen concentration group (St), normal antigen concentration group (Ta), and high antigen concentration group (Da).

hibitor in normal serum and in patients of the low and normal antigen concentration groups emerged in the same positions just before the second peak. However, in the serum samples from patients in the high antigen concentration group, the C1 esterase inhibitor emerged in a bimodal peak, the larger portion of which was in the trough between the first and second peaks. Immunofixation revealed that the more anodal band was eluted earlier than the cathodal band. Since these results suggested possible complex formation, the eluted fractions were also tested for their content of human serum albumin. In addition to the presence of albumin in its usual position in the third peak, albumin was also found in fractions which contained the anodal band (cf. Da in Fig. 6). When sera of the patients in the Da kindred were examined by immunoelectrophoresis with antisera to human albumin and C1 esterase inhibitor, it was evident that there was an additional albumin band of lower concentration which fused with the major albumin band. The former coincided in mobility with the anodal band of precipitation with anti-C1 esterase inhibitor. When sera from this kindred with high antigen concentration were treated with 6 M urea or 4 M guanidine and subjected to immunofixation, only the cathodal band was observed. It thus appeared that the anodal band was a noncovalently linked complex of C1 esterase inhibitor and albumin.

The nonfunctional C1 esterase inhibitors were assessed for their ability to bind C1s labeled with  $^{125}\text{I}$  and for their inhibitory capacity in the reaction between C1s and its substrate, *N*-acetyl-tyrosine-ethyl-ester.

Equal volumes of labeled C1s (60 U/ml) and undiluted serum were mixed at 37° C for 5 min, and portions of the mixture were subjected to electrophoresis and subsequent immunofixation with anti-C1 esterase inhibitor.

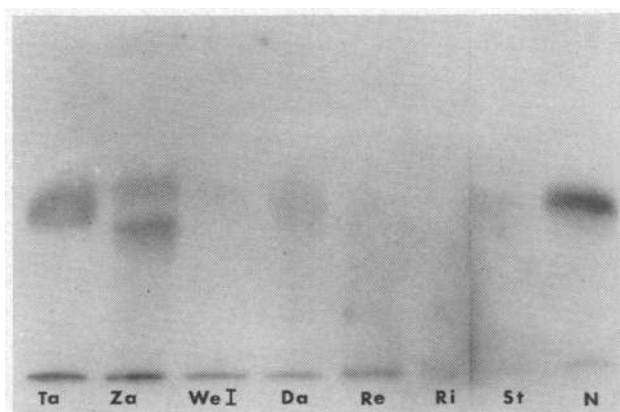

FIGURE 7 Radioimmunoassay of C1 esterase inhibitor, previously interacted with  $^{125}\text{I}$ -labeled C1s. Designations refer to kindred shown in Fig. 3, except for normal serum (N) and serum of a patient containing 5% of normal C1 esterase inhibitor concentration (St).

TABLE II  
*Disparate Effects of Abnormal C1s Inhibitor: Inactivation of Hemolytic C4 in Presence of Measurable Inhibition of Esterolysis by C1s*

Serum	C1s inhibitor		C4 depletion
	mg/100 ml	U/ml	U/ml
K. Re	22	6.0	2560
A. Re	24	7.5	2560
J. Re	31	5.0	2560
S. Re	16	6.9	2560
A. Ri	15	0.8	2560
Th. Ri	25	6.8	2540
Ti. Ri	16	5.6	2240
R. Ri	13	3.5	2560
Normal	18 ± 5	6.0 ± 2	0

Sera from the affected members in two kindred with hereditary angioneurotic edema contained normal concentrations of C1s inhibitor antigen, readily measurable and usually normal capacity to block hydrolysis of *N*-acetyl-L-tyrosine-ethyl-ester by preparations of C1s in a standard assay but were markedly depleted of C4 measured in a hemolytic assay. Normal sera and sera of unaffected members of each kindred were not depleted of C4.

The dried plate was exposed to No-screen X-ray film to obtain a radioautograph. While the nonfunctional C1 esterase inhibitor of the Ta and Za kindred bound labeled C1s firmly, only weak binding was observed with WeI and Re sera, and no binding was observed with Ri sera. Only the cathodal band in sera of the Da kindred bound the labeled C1s and then only weakly. Binding of C1s by the sera of the low antigen concentration group was roughly proportional to the C1 esterase inhibitor concentration (Fig. 7).

The sera of affected individuals in the Da, WeI and II, La, and Ta kindred had no detectable inhibition of C1s as measured by their capacity to inhibit its esterolytic property. However, sera of affected members of two unrelated kindred (Ri and Re) had substantial inhibitory activity in the esterolytic assay (Table II). Despite the capacity of these sera to inhibit esterolysis by C1s, titers of hemolytic C4 in these same sera were markedly depleted. The serum of these patients also inactivated C4 in normal serum depleted of C1 by heating at 56° C for 30 min. The patient's serum therefore inactivated exogenous C4 in the presence of measurable inhibition of esterolysis by C1s.

## DISCUSSION

Individuals with hereditary angioneurotic edema have an inborn biosynthetic defect of a serum alpha-2 glycoprotein, commonly designated the C1 esterase inhibi-

tor. The pathophysiologic consequences of this defect have been discussed extensively elsewhere (12). It has been known for some time that the sera of patients with this disease lack functional C1 esterase inhibitor activity (1), and that this may be associated either with a lack of the C1 esterase inhibitor protein or the presence of a nonfunctional protein which is immunologically identical with the normal (4).

The present studies define the genetic heterogeneity of this defect. Of eight kindred with nonfunctional inhibitor protein, no two were identical with respect to (a) ability to bind C $\bar{1}$ s, (b) electrophoretic mobility, and (c) ability to block esterolytic activity of C $\bar{1}$ s. Even though two of the nonfunctional inhibitors did block the esterolytic activity of C $\bar{1}$ s, none protected the C4 in the patient's serum from inactivation as a consequence of activation of C $\bar{1}$ s.

The sera of affected individuals in one kindred contained over 4 times the normal concentration of C1 esterase inhibitor protein with two different electrophoretic mobilities. The apparent double electrophoretic abnormality of C1 esterase inhibitor protein has been partially explained by binding of some of the inhibitor protein molecules to albumin. Laurell, Lindegren, Malmias, and Martenson have found a similar abnormality in one Swedish patient with 3 times the normal concentration of inhibitor protein (13).

Sera of patients in seven other kindred contained normal concentrations of C1 esterase inhibitor by immunochemical estimation. In six of the seven kindred, an abnormal electrophoretic mobility of the C1 esterase inhibitor was demonstrable by immunofixation. It could not be ascertained whether or not the electrophoretic differences were due to alterations in the primary amino acid content of the protein or in the carbohydrate moieties of the inhibitor, or to a combination of the two. The fact that all lost their net charge after exhaustive treatment with neuraminidase does not exclude any one of these possible alterations.

All of the C1 esterase inhibitor in sera from affected members in these seven kindred had abnormal electrophoretic mobility. Thus, the genetic defect in hereditary angioneurotic edema appears to be unique among genetically determined abnormalities of serum proteins. In some instances, the dominant inheritance of the disease results in the appearance of a defective, nonfunctional inhibitor and undetectable amounts of normal inhibitor protein instead of the anticipated 50% of normal protein. Reasons for the genetic dominance of an abnormal gene over the normal gene in these heterozygous affected individuals are obscure. Serum from patients with low concentrations of antigen contained inhibitor protein of normal electrophoretic mobility in each instance. Among this large group of patients with low concentrations of

inhibitor protein, all those tested bind to C $\bar{1}$ s and inhibit esterolysis by C $\bar{1}$ s and in proportion to their concentration. While one might predict the occurrence of an abnormal protein in the low antigen concentration group, none has yet been found. From 50 normal sera examined for evidence of genetic polymorphism as manifested by altered electrophoretic mobility, none could be identified.

The sera from two kindred containing abnormal inhibitor protein capable of impairing esterolytic function of C $\bar{1}$ s but not its capacity to inactivate C4 raise the possibility that the active site of the C $\bar{1}$ s molecule required for interaction with C4 differs from that required for esterolysis. Alternatively, the binding affinity of C $\bar{1}$ s for C4 may be significantly greater than that for the tyrosine ester substrate and hence less readily blocked by a faulty inhibitor molecule. Such serum could inactivate exogenous C4, providing ample evidence for its C4-inactivating capacity. These findings lead to the conclusion that the only single certain assay for detecting a defect in the C1 esterase inhibitor is one which measures the consumption of C4 either in the fluid phase of serum or in blocking of formation of EAC1,4 sites on EAC1 (14-16).

Several observations support the view that hereditary angioneurotic edema results from defective biosynthesis of the C1 esterase inhibitor. In some instances, defective inhibitor function, despite the presence of normal amounts of protein containing appropriate antigenic determinants, indicates synthesis of an abnormal protein as the primary abnormality. In unpublished studies,<sup>1</sup> the rate of disappearance of radioactively labeled, purified normal serum inhibitor from the blood of patients deficient in functional and antigenic C1 esterase inhibitor, was identical with that in normal individuals once equilibrium with extravascular compartments was established. Since some error may have been introduced by partially denatured protein used in these experiments, this evidence must be accepted with caution. Further unpublished studies with a fluorescent antibody technique revealed that normal liver cells of normal persons contain inhibitor antigen.<sup>1</sup> On the other hand, liver cells from patients deficient in functional and antigenic C1 esterase inhibitor showed no detectable fluorescence although the number of hepatic cells fluorescent with antibody to C4 were normal.

#### ACKNOWLEDGMENTS

We are grateful to Miss Lillian Watson, Miss Marybeth Greive, and Miss Bronwyn Jones for their technical assistance.

This work was supported by U. S. Public Health Service grants AI-05877, AM-13855, AI-06349, and HE-11933, a grant from the American Heart Association and its North-

<sup>1</sup> Rosen, F. S., C. A. Alper, J. Pensky, M. R. Klemperer, and V. H. Donaldson. Unpublished observations.

west Ohio Branch, and from the Ohio Valley Chapter of the Arthritis Foundation.

#### REFERENCES

1. Donaldson, V. H., and R. R. Evans. 1963. A biochemical abnormality in hereditary angioneurotic edema: absence of serum inhibitor of C'1-esterase. *Amer. J. Med.* **35**: 37.
2. Pensky, J., L. R. Levy, and I. H. Lepow. 1961. Partial purification of a serum inhibitor of C'1-esterase. *J. Biol. Chem.* **236**: 1674.
3. Pensky, J., and H. G. Schwick. 1969. Human serum inhibitor of C'1 esterase: identity with  $\alpha_2$ -neuraminoglycoprotein. *Science (Washington)*. **163**: 698.
4. Rosen, F. S., P. Charache, J. Pensky, and V. Donaldson. 1965. Hereditary angioneurotic edema: two genetic variants. *Science (Washington)*. **148**: 957.
5. Johnson, A. M., K. Schmid, and C. A. Alper. 1969. Inheritance of human alpha-1 acid glycoprotein (orosomucoid) variants. *J. Clin. Invest.* **48**: 2293.
6. Haines, A. L., and I. H. Lepow. 1964. Studies on human C'1-esterase. I. Purification and enzymatic properties. *J. Immunol.* **92**: 456.
7. Klempere, M. R., V. H. Donaldson, and F. S. Rosen. 1967. The vasopermeability response in man to purified C'1-esterase. *J. Clin. Invest.* **46**: 1079. (Abstr.)
8. McFarlane, A. S. 1958. Efficient trace-labelling of proteins with iodine. *Nature (London)*. **182**: 53.
9. Laurell, C.-B. 1966. Quantitative estimation of proteins by electrophoresis in agarose gel containing antibodies. *Anal. Biochem.* **15**: 45.
10. Alper, C. A., and A. M. Johnson. 1969. Immunofixation electrophoresis: a technique for the study of protein polymorphism. *Vox Sang.* **17**: 445.
11. Warren, L. 1959. The thiobarbituric acid assay of sialic acids. *J. Biol. Chem.* **234**: 1971.
12. Donaldson, V. H. 1970. Blood coagulation and related plasma enzymes in inflammation. *Ser. Haematol.* **3**: 39.
13. Laurell, A.-B., J. Lindegren, I. Malmros, and H. Martensson. 1969. Enzymatic and immunochemical estimation of C1 esterase inhibitor in sera from patients with hereditary angioneurotic edema. *Scand. J. Clin. Lab. Invest.* **24**: 221.
14. Donaldson, V. H., and F. S. Rosen. 1964. Action of complement in hereditary angioneurotic edema: the role of C'1-esterase. *J. Clin. Invest.* **43**: 2204.
15. Ruddy, S., and K. F. Austen. 1967. A stoichiometric assay for the fourth component of complement in whole human serum using EAC'1a<sup>sp</sup> and functionally pure human second component. *J. Immunol.* **99**: 1162.
16. Gigli, I., S. Ruddy, and K. F. Austen. 1968. The stoichiometric measurement of the serum inhibitor of the first component of complement by the inhibition of immune hemolysis. *J. Immunol.* **100**: 1154.