

TA7  
W34c  
no. DRP-93-3  
ept. 2 c. 4

Corps  
rs

*Walden*

# DREDGING RESEARCH PROGRAM

CONTRACT REPORT DRP-93-3

## GEOTECHNICAL FACTORS IN THE DREDGEABILITY OF SEDIMENTS

### Report 2

## GEOTECHNICAL SITE INVESTIGATION STRATEGY FOR DREDGING PROJECTS

by

S. Joseph Spigolon

SJS Corporation  
Coos Bay, Oregon 97420

**US-CE-C** Property of the  
United States Government



Report 2 of a Series

October 1993

Approved For Public Release; Distribution Is Unlimited

**Research Library**  
**USACE ERDC**  
**Vicksburg, MS**

Prepared for DEPARTMENT OF THE ARMY  
U. S. Army Corps of Engineers  
Washington, DC 20314-1000

Monitored by Geotechnical Laboratory  
U. S. Army Engineer Waterways Experiment Station  
3909 Halls Ferry Road, Vicksburg, Mississippi 39180-6199

Under Work Unit 32471

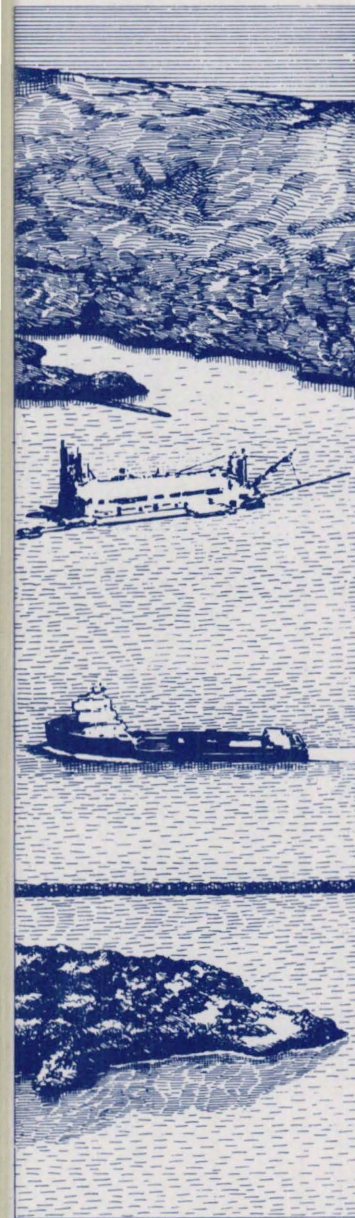



The Dredging Research Program (DRP) is a seven-year program of the U.S. Army Corps of Engineers. DRP research is managed in these five technical areas:

- Area 1 - Analysis of Dredged Material Placed in Open Water
- Area 2 - Material Properties Related to Navigation and Dredging
- Area 3 - Dredge Plant Equipment and Systems Processes
- Area 4 - Vessel Positioning, Survey Controls, and Dredge Monitoring Systems
- Area 5 - Management of Dredging Projects

The contents of this report are not to be used for advertising, publication, or promotional purposes. Citation of trade names does not constitute an official endorsement or approval of the use of such commercial products.



PRINTED ON RECYCLED PAPER

USACEWES



3 5925 00333 8727



US Army Corps  
of Engineers  
Waterways Experiment  
Station

# Dredging Research Program Report Summary



## *Geotechnical Factors in the Dredgeability of Sediments; Report 2, Geotechnical Site Investigation Strategy for Dredging Projects (CR DRP-93-3)*

**ISSUE:** A key ingredient for cost-effectively conducting dredging operations is to successfully plan and execute pre-dredging geotechnical site investigations to produce a subbottom profile. The information must give a complete and accurate estimate of the location and character of the material to be dredged. Results of the site investigations must be communicated to and understood by all persons involved in the design, cost estimation, and construction of the project.

**RESEARCH:** The primary objectives of the Dredging Research Program (DRP) work unit entitled "Descriptors for Bottom Sediments to be Dredged" are as follows:

- Identify appropriate geotechnical engineering parameters, develop standard dredged material descriptors based on the parameters, and correlate the parameters with dredging equipment performance.
- Identify techniques suitable for measurement of appropriate geotechnical parameters.

To accomplish the second objective, available literature was reviewed and data were compiled.

**SUMMARY:** The factors that most affect a site investigation strategy, including the uniqueness of each dredging project, are identified and discussed. Guidance on sequencing an investigation includes a flowchart (decision-making diagram). The flowchart identifies those points at which information should be evaluated and the investigation terminated if the available information is considered sufficient.

**AVAILABILITY OF REPORT:** The report is available through the Interlibrary Loan Service from the U.S. Army Engineer Waterways Experiment Station (WES) Library, telephone number (601) 634-2355. National Technical Information Service (NTIS) report numbers may be requested from WES Librarians.

To purchase a copy of the report, call NTIS at (703) 487-4780.

**About the Author:** Dr. S. Joseph Spigolon is an engineering consultant, SIS Corporation, Coos Bay, OR.

**Points of Contact:** Dr. Jack Fowler, Geotechnical Laboratory, WES, Principal Investigator for this work unit; Dr. Don C. Banks, Technical Area Manager, WES.

For further information about the DRP, contact Mr. E. Clark McNair, Jr., Manager, DRP, at (601) 634-2070.





29562580

Dredging Research Program

Contract Report DRP-93-3

October 1993

US-CE-C Property of the  
United States Government

TA7  
W34c

no. DRP-93

rept. 2

c. 4

# Geotechnical Factors in the Dredgeability of Sediments

## Report 2

## Geotechnical Site Investigation Strategy for Dredging Projects

by S. Joseph Spigolon  
SJS Corporation  
Coos Bay, Oregon 97420

Report 2 of a series

Approved for public release; distribution is unlimited

Prepared for U.S. Army Corps of Engineers  
Washington, DC 20314-1000

Monitored by Geotechnical Laboratory  
U.S. Army Engineer Waterways Experiment Station  
3909 Halls Ferry Road, Vicksburg, Mississippi 39180-6199

Under Work Unit 32471

**Research Library**  
**USACE ERDC**  
**Vicksburg, MS**



**US Army Corps  
of Engineers**  
Waterways Experiment  
Station

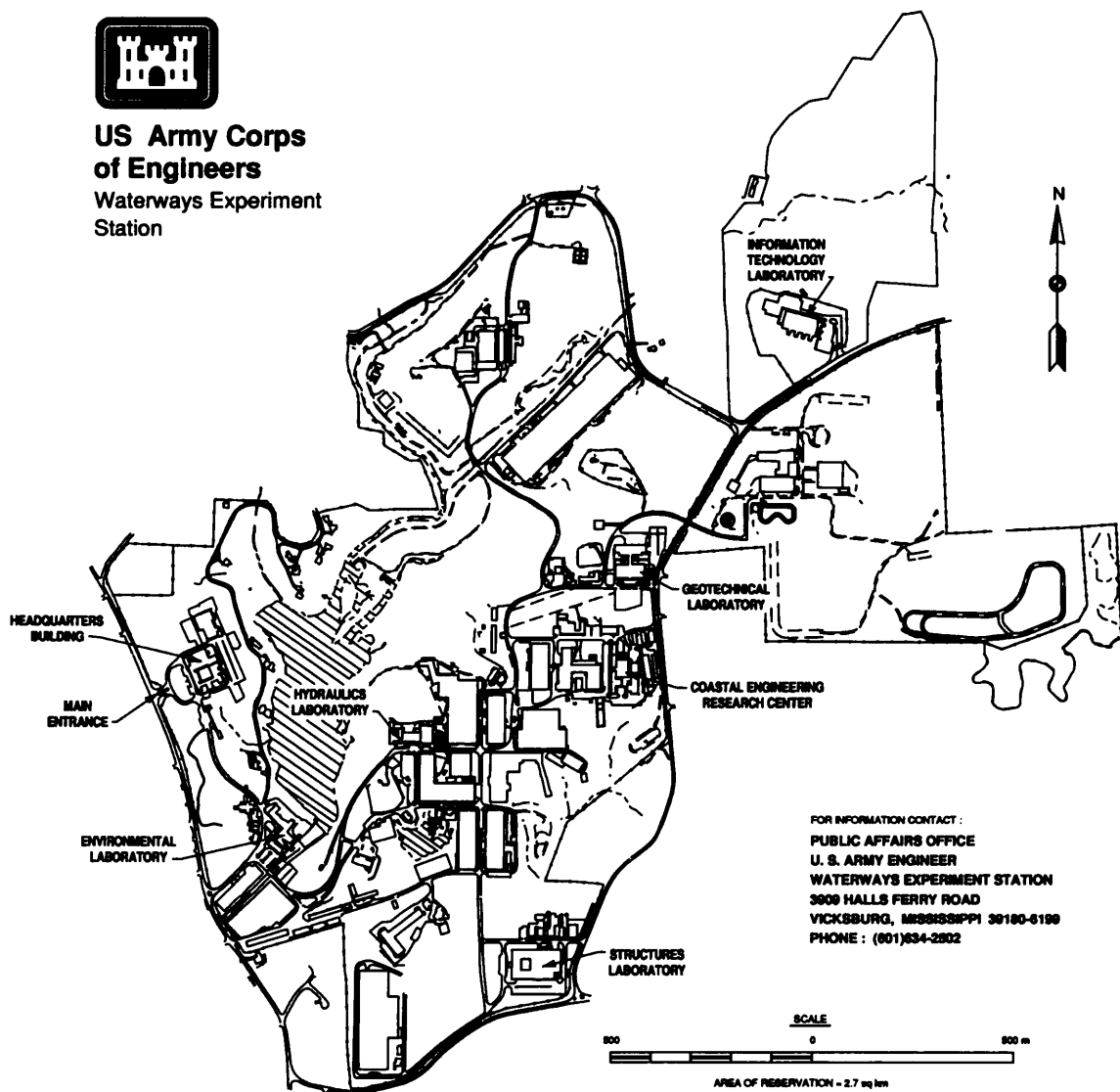

### Waterways Experiment Station Cataloging-in-Publication Data

Spigolon, S. J.

Geotechnical factors in the dredgeability of sediments. Report 2, Geotechnical site investigation strategy for dredging projects / by S. Joseph Spigolon ; prepared for U.S. Army Corps of Engineers ; monitored by Geotechnical Laboratory, U.S. Army Engineer Waterways Experiment Station.

160 p. : ill. ; 28 cm. — (Contract report ; DRP-93-3 rept. 2)

Includes bibliographical references.

1. Dredging spoil — Environmental aspects. 2. Dredging — Environmental aspects — Quality control. 3. Environmental monitoring — Cost effectiveness. 4. Marine geotechnique. I. United States. Army. Corps of Engineers. II. U.S. Army Engineer Waterways Experiment Station. III. Dredging Research Program. IV. Title. V. Title: Geotechnical site investigation strategy for dredging projects. VI. Series: Contract report (U.S. Army Engineer Waterways Experiment Station) ; DRP-93-3 rept. 2. TA7 W34c no.DRP-93-3 rept.2



## PREFACE

This report was prepared under Contract No. DACW3989M4430, dated 17 August 1989, for the US Army Engineer Waterways Experiment Station (WES) under Dredging Research Program (DRP) Technical Area 2, Work Unit No. 32471, "Descriptors for Bottom Sediments to be Dredged." The DRP is sponsored by Headquarters, US Army Corps of Engineers (HQUSACE). Mr. Jesse A. Pfeiffer, Jr., was Directorate of Research and Development Coordinator. Technical Monitors for the DRP were Messrs. Robert H. Campbell, John Lockhart, Jr., Barry Holliday, David P. Mathis, M. K. Miles, and Gerald E. Greener. HQUSACE Technical Advisors were Messrs. James Crews and Thomas M. Verna.

This report was written by Dr. S. Joseph Spigolon, SJS Corporation, Coos Bay, Oregon, under the supervision of Dr. Jack Fowler, Principal Investigator, Soil Mechanics Branch (SMB), Soil and Rock Mechanics Division (S&RMD), GL, and Messrs. G. B. Mitchell and M. Myers, Former Chief and Chief, SMB, GL; Dr. Don C. Banks, Chief, S&RMD, GL; and Dr. W. F. Marcuson III, Chief, GL. Dr. Banks was also the Manager for Technical Area 2, "Material Properties Related to Navigation and Dredging," of the DRP. Dr. Lyndell Z. Hales and Mr. E. Clark McNair, Jr., Coastal Engineering Research Center (CERC), WES, were Assistant Manager and Manager, respectively, of the DRP. Mr. Charles C. Calhoun and Dr. James R. Houston were Assistant Director and Director, respectively, of CERC, which oversees the DRP.

At the time of publication of this report, Director of WES was Dr. Robert W. Whalin. Commander was COL Bruce K. Howard, EN.

For further information on this report or on the Dredging Research Program, please contact Mr. E. Clark McNair, Program Manager, at (601) 634-2070.

CONTENTS

	<u>Page</u>
PREFACE.....	1
SUMMARY.....	5
PART I: INTRODUCTION.....	7
Background.....	8
Objective and Scope of the Study.....	8
Factors Affecting a Site Investigation Strategy.....	9
Organization of the Remainder of the Report.....	10
PART II: SOIL PROPERTIES AFFECTING DREDGING OPERATIONS.....	13
Dredging Processes.....	13
Dredgeability Properties of Soil Sediments.....	14
Geotechnical Soil Material Properties.....	21
Geotechnical Soil Mass Properties.....	27
Geotechnical Soil Behavior Properties.....	30
PART III: PROCEDURE FOR A GEOTECHNICAL SITE INVESTIGATION.....	42
Procedure for a Geotechnical Site Investigation.....	42
Sources of Prior (Pre-existing) Information.....	45
Geophysical Methods.....	47
PART IV: METHODS FOR SAMPLING UNDERWATER SOILS.....	52
Methods for Underwater Soil Sampling.....	52
Methods for Accessing Sampling and Testing Depth.....	59
Working Platforms for Underwater Sampling and Testing.....	67
PART V: TEST METHODS FOR SOIL MATERIAL PROPERTIES.....	70
PART VI: TEST METHODS FOR SOIL MASS AND SHEAR STRENGTH PROPERTIES...	86
Soil Mass Properties Tests.....	86
Soil Shear Strength Tests.....	91
Direct Tests of Shear Strength.....	92
Indirect Shear Strength Tests.....	96
Tests for the Rheologic Behavior of Soil Slurries.....	112
PART VII: FACTORS AFFECTING A SITE INVESTIGATION STRATEGY.....	114
Factor of Variability of Natural Soil Deposits.....	114
Factor of the Sampling and Testing Program.....	124
Factor of the Value of Additional Information.....	132
PART VIII: IMPLEMENTING A SITE INVESTIGATION STRATEGY.....	135
Risk Factors.....	136
Sufficiency of a Dredgeability Site Investigation.....	137
Suggestions for Implementing a Site Investigation Plan.....	138
Discussion of Soil Exploration, Sampling, and Testing Methods..	139
PART IX: SUMMARY AND RECOMMENDATIONS.....	144
Summary of the Report.....	144
Recommendations for Further Work.....	145
REFERENCES.....	147



LIST OF FIGURES

<u>Figure No.</u>		<u>Page</u>
1	Typical grain-size distribution curves.....	23
2	Casagrande plasticity chart for cohesive soils.....	25
3	Example of graphical solution for relative density.....	29
4	Weight-volume relationships.....	31
5	Schematic diagram of direct shear box.....	33
6	Relationship of shear strength and normal force.....	34
7	Schematic diagram of triaxial compression apparatus.....	35
8	Correlation of strength properties for granular soils...	36
9	Effect of relative density on friction angle for sands..	37
10	Interrelationship of properties of clay soils.....	39
11	Rheologic behavior of a silt-clay slurry.....	40
12	Relationship between yield stress and slurry density....	41
13	Geotechnical site investigation strategy.....	44
14	Geophysical acoustic sounding.....	50
15	Schematic of thin-wall tube sampler.....	54
16	Split barrel sampler used in the Standard Penetration Test.....	56
17	Gravity projectile sampler.....	57
18	Various designs of surface soil samplers.....	60
19	Wash boring system.....	62
20	Rotary drilling system.....	64
21	Continuous flight auger drilling system.....	65
23	Field vane shear test.....	93
24	Unconfined compressive strength estimated from SPT N-values.....	100
25	Cone penetrometer tip and sleeve.....	102
26	Estimation of soil description from CPT data.....	104
27	Estimation of angle of friction using CPT data.....	105
28	Correlation of CPT and SPT data.....	106
29	Simple light sounding rod.....	108
30	Frequency histogram of soil property test data.....	116
31	Concepts of regression analysis.....	122
32	Variation of strength with depth in a marine clay.....	123
33	Value of additional information.....	133

LIST OF TABLES

<u>Table No.</u>		<u>Page</u>
1	Dredging Mechanisms.....	15
2	Characteristics of Dredging Equipment.....	17
3	Typical Weight-Volume Properties of Soils.....	32
4	Characteristics of Basic Sediment Types.....	48
5	Thick-Wall, Split Tube Samplers.....	56
6	Geotechnical Soil Material Properties Tests.....	72
7	Correlation of Atterberg Limits and Per Cent Clay.....	77
8	Angularity of Coarse-Grained Particles.....	78
9	Shape of Coarse-Grained Particles.....	79
10	Highly Organic Soils.....	80
11	Reaction of Sediments with Hydrochloric Acid (HCl).....	80
12	Grain Size Identification.....	82
13	Dry Strength of Cohesive Soils Using Visual-Manual Methods.....	83
14	Dilatancy of Cohesive Soils Using Visual-Manual Methods.	83
15	Toughness of Cohesive Soils Using Visual-Manual Methods.	84
16	Field Identification of Cohesive Soils.....	84
17	Field Estimated Consistency of Cohesive Soils.....	85
18	Strength of Shale and Cemented Soils.....	85
19	Consistency of Cohesive Soils.....	95
20	Corrections to Standard Penetration Test N-values.....	98
21	Compactness of Granular Soils Based on SPT.....	99
22	Thick Wall, Split Tube Penetration Test Devices.....	100
23	Definitions of Basic Statistical Terms.....	117
24	Coefficient of Variation for Geotechnical Soil Tests....	120



## Summary

A geotechnical site investigation is made in the following order: (1) a search is made of all prior information, including geologic and other publications, and project records; (2) an areal survey is made to determine the overall variability in the soil profile, using geophysical acoustic soundings and/or remote imaging; (3) after a preliminary soil profile is established, test borings (or test pits) are made at selected locations, usually on a uniform spacing; the spacing of borings in any zone of the dredging prism should be varied to correspond with the variability of the soil profile in that zone so that a consistent standard error of estimate is maintained; (4) in situ compactness/consistency tests and in situ density tests are made; representative samples are taken for laboratory analyses of soil material properties; visual-manual tests are made in the field for use in a preliminary re-evaluation of the previously assumed soil profile; (5) the representative samples are delivered to the laboratory for testing; and (6) the process is repeated with additional borings, sampling, and testing as needed until sufficiency is reached.

As a minimum, the geotechnical soil properties needed to define each soil encountered include: (a) the in situ compactness of granular soils and the consistency of cohesive soils; (b) the in situ density and water content; (c) the grain-size distribution of coarse grains; (d) the Atterberg limits of the fine grains; (e) the specific gravity of the grains; (f) the shape and hardness of coarse grains; and (g) the organic and carbonate contents of the soil. Not all of these properties are significant for all types of dredging plant or in all phases of the dredging operation. All site investigations must be made before analysis of project needs can be made, i.e., selection of equipment and scheduling. Therefore, the entire group of soil characteristics must be tested in advance, during the site investigation, to permit consideration of all feasible groupings of dredging plant during project evaluation, planning, and bidding.

The significant factors in forming a strategy, or plan, for a dredging site investigation are: (a) the amount of valid prior geotechnical information available about the proposed project, (b) the variability of the soil properties in the dredging prism, (c) the relative cost of the feasible methods of exploration and testing available for use, and (d) the value of the

geotechnical information in reducing risk costs. All of these factors must be considered in determining the sufficiency of a geotechnical site exploration program. Sufficiency occurs when the cost of making the site investigation equals the expected savings in total project cost due to the added information, both in bid price and expected cost of claims.

There are several methods for providing a sampling platform, for obtaining samples, and for making in situ tests. The cost of obtaining information at any single test site includes the cost of moving to the site, setting up the drilling and sampling platform, the daily cycle of movement of personnel and supplies, the fixed cost of equipment, the rate of progress of sampling and testing possible with a given system, and the cost for transporting and testing laboratory samples. All these factors must be considered when evaluating relative costs for obtaining the same information with different combinations of drilling, sampling, and testing devices. The combination of devices and tests that will provide the same, necessary information, with equivalent precision, at minimum cost, and that will provide for easiest reentry of the site for additional drilling, sampling, and testing is the methodology to use for that project.

A major objective of a site investigation is to provide sufficient geotechnical information to the contractor to reduce his feeling of risk, and to improve his confidence in knowledge about project soils, thereby enabling him to reduce his bid price and also to reduce the potential cost of claims due to changed conditions. The economic scope of a site investigation can theoretically be established on the basis of sufficiency, i.e., the cost of obtaining information versus the value of the information in reducing project costs. However, this relationship cannot be quantified at this time because of the lack of sufficient data. As a practical way of proceeding, in spite of this lack, it is suggested that the scope of all future dredging site investigations be established jointly by all persons involved in the dredging process, i.e., representatives of both the operations and the geotechnical groups of the sponsoring Corps of Engineers Division and District, of prospective dredging contractors, and of any prospective consultants that might be used by either group. In this manner, the individual experiences, interests, biases, and aversion to risk of all involved can be brought to bear on the subject.

# GEOTECHNICAL FACTORS IN THE DREDGEABILITY OF SEDIMENTS

## GEOTECHNICAL SITE INVESTIGATION STRATEGY FOR DREDGING PROJECTS: LITERATURE REVIEW

### PART I: INTRODUCTION

1. The objective of a geotechnical site investigation for a dredging project is to obtain the most complete and accurate estimate of the location and character of the materials to be dredged that is possible within the limits of available time and money and of practicality. This information must then be communicated, in a readily understood manner, to all persons involved in the design, cost estimation, and construction of the project. A site investigation for dredging consists of studies of all available existing information augmented, when necessary, by geophysical and geotechnical subbottom investigations, including the sampling and testing of soils and rock. The data are summarized in an estimated geotechnical subbottom profile. The validity of the estimated profile is dependent on the type and amount of site investigation made and on the knowledge and skill of the interpreter(s) of the data.

2. Bids submitted on a project are affected by the monetary risks the contractors are willing to take after considering their uncertainty about the character and location of the materials to be dredged. The greater the risk from incomplete information, the greater that part of the bid price that considers the risk. If unforeseen adverse site conditions are encountered, the contractor may file a claim for changed conditions. Therefore, the amount to be spent on a site investigation by the owner is directly related to the amount that the bid price and the total cost involved in processing claims for changed conditions can be reduced by the availability of a more comprehensive geotechnical site description.

3. The persons and groups involved in site investigations for dredging operations include geotechnical engineers, geologists, environmental engineers, biologists, estimators, dredging contractors, and commercial testing laboratories. These groups have diverse technical backgrounds. Each group has its own internal soil and rock investigation, description, and classification methodology. Site investigation objectives and strategies within and among these groups differ and often do not convey specific

dredging-related information. Testing methods among the various groups vary. Because of the large sums that will continue to be spent on dredging, there is a need for understanding, by all of the participants in a dredging project, of the rationale for a site investigation strategy and of the conventional geotechnical methods for site investigation, sampling, testing, and analysis of data.

### Background

4. The U.S. Army Corps of Engineers has implemented a Dredging Research Program (DRP) in the operational aspects of dredging. The research effort is being administered and executed by the U.S. Army Engineer Waterways Experiment Station (WES), Vicksburg, Mississippi. The justification and a detailed description of the DRP are given in a Development Report by Calhoun et al. (1986). Work Unit 32471 of the DRP Materials problem area is titled: "Descriptors for Bottom Sediments to be Dredged." In a DRP program review document, dated 9 May 1989, the objective of the descriptor work unit was given as:

"Identify the appropriate geotechnical engineering parameters and develop standard dredged material descriptors based on these parameters and correlate these parameters with dredge equipment performance. Identify techniques suitable for the measurement of these geotechnical parameters."

5. The first part of the objective, dealing with engineering parameters and descriptors, has been the subject of recent studies. They have resulted in two published papers (Spigolon and Fowler 1988, 1989) and two formal WES reports (Dunlap 1989; Spigolon 1992). The subject of this literature review report is the second part of the work unit objective, i.e., the identification of techniques suitable for the measurement of the appropriate geotechnical engineering parameters.

### Objective and Scope of the Study

6. The objective of this study was to survey and describe the methods of underwater geotechnical site investigation directly applicable to dredging projects, and to define the factors that must be considered in planning a site

investigation, so that a rational subbottom investigation strategy may be formulated. This research report is intended to offer guidance for planning and executing a site investigation and for interpreting the resulting data as it applies to dredging operations. It is not a laboratory manual of soil testing methods nor an instruction manual on drilling or field soil testing. Those aspects of the topic are beyond the scope of this report.

7. This research study was limited to site investigations to be made entirely in soil sediments. A similar work unit study concerned solely with rock is being conducted concurrently by another research group at WES. The resources utilized in the study included (a) a survey of the applicable geotechnical and dredging-related literature and (b) personal discussions with Corps of Engineers geotechnical and dredging operations personnel, dredging contractors, and dredging consultants. Although all of the topics discussed in this document have been discussed in detail elsewhere, the intent has been to compile a summary of the methods of special interest and value to the dredging community--geotechnical engineers, dredging operations personnel, and dredging contractors--in one document.

#### Factors Affecting A Site Investigation Strategy

8. The factors that must be considered in the establishment of the type and magnitude of a geotechnical site investigation for a dredging project include:

- a. Significant Soil Properties: the geotechnical soil properties that must be established, for each soil deposit in the dredging prism, to indicate, or infer, dredgeability;
- b. Test Methods and Equipment: the known, or assumed, capabilities and usefulness of the various appropriate types of geophysical and geotechnical sampling and testing methods and equipment that are available;
- c. Site Variability: the known, or assumed, variation in the stratification of the sediments and in their significant dredgeability properties, including both nonrandom trends and random fluctuations about the trends;
- d. Magnitude of the Sampling and Testing Program: the effect of the size and type of the sampling and testing program on the estimates of the locations of soil deposits and their geotechnical characteristics;



- e. Value of Information: the risks involved in having incomplete information and the savings in total project cost to be expected for each added expenditure of site investigation money, i.e., the cost versus the value of additional information;
- f. Investigation Costs: the costs, both relative and actual, in time and money for the performance of the various available geophysical and geotechnical samples and tests; and
- g. Investigation Flexibility: whether the plan of the subsurface investigation program is fixed in advance or can be modified as information develops.

Factors a through e are discussed below. A detailed investigation of factor f, time and money costs of testing, is beyond the scope of this study; costs are variable and changeable, but unquestionably must be considered. Factor g affects the scope of the plan. Flexibility may not be possible because of an organization's legal, administrative, or budgetary constraints. If the investigation is flexible, then presumably only the amount of investigation actually needed will be done. If it is fixed, then it may result in too much or too little work.

#### Organization of the Remainder of the Report

9. The issues that must be considered in the establishment of the type and magnitude of a geotechnical site investigation for a dredging project, factors a through e, in paragraph 8 above, are discussed in the remainder of this report.

#### Soil Properties Affecting Dredging Operations

10. Part II deals with the "Soil Properties" factor of paragraph 8 a above. It establishes the geotechnical engineering properties that must be determined for each soil deposit in the dredging prism. Dredging equipment and processes are reviewed. The behavior mechanisms of the various types of dredging plant are summarized. The soil dredgeability properties, related to dredging plant processes, and their corresponding geotechnical soil properties are identified. Definitions and discussions of the features and applicability of the geotechnical soil properties are presented.

### Procedure for a Geotechnical Site Investigation

11. Part III presents a general procedure for making a geotechnical subbottom investigation for a dredging project. It also explores preliminary, indirect methods for obtaining subsurface information about a site. Discussed are: (a) sources for obtaining prior (existing) information and (b) methods for making geophysical subbottom surveys.

### Methods for Sampling Soils Under Water

12. Part IV considers part of the factor of "Test Methods and Equipment" of paragraph 8 b above. It discusses methods and equipment that may be used for the sampling of soils at an individual exploration site under water. Included are: (a) methods for obtaining soil samples underwater, (b) methods used for excavating (reaching, accessing) to the sampling (and testing) depth, and (c) the various kinds of sampling and testing platforms used for over-water sites.

### Test Methods for Soil Material Properties

13. Part V also considers part of the factor of "Test Methods and Equipment" of paragraph 8 b above. It contains a review of the geotechnical test methods, both standard and alternative, and equipment that are appropriate for the determination of the soil material properties of Part II. Their purposes, advantages, and limitations are discussed.

### Test Methods for Soil Mass and Shear Strength Properties

14. Part VI concludes the consideration of the factor of "Test Methods and Equipment" of paragraph 8 b above. It contains a discussion of the geotechnical field (in-situ) and laboratory test methods, both standard and alternative, and equipment that are appropriate for determination of the soil mass and shear strength properties of Part II at an individual exploration site. Their purposes, advantages, and limitations are discussed.

### Factors Affecting a Site Investigation Strategy

15. In Part VII, an examination is made of the factors c, d, and e of paragraph 8 that must be considered in establishing an overall strategy, or plan, for a site investigation for a dredging site, including the number and location of exploration sites. The effect of the variability of soil properties associated with various types of geologic environments and the sampling and testing plan on the scope of a site investigation are considered. Sufficiency of a site investigation is discussed. The value of additional

soils information in reducing risk due to incomplete information versus the cost of obtaining the information is discussed.

#### Implementing a Site Investigation Strategy

16. Part VIII contains discussion and commentary on practical methods for planning and executing a dredging-related site investigation and suggestions for possible improvement in the methods. The establishment of the scope of a site investigation and its sufficiency are examined in light of the factors presented in Part VII. Factors to be considered in the selection of sampling and testing methods, in various feasible combinations, are given.

#### Summary and Recommendations

17. The report is concluded with a summary. Recommendations are offered for continued work on this topic.

## PART II: SOIL PROPERTIES AFFECTING DREDGING OPERATIONS

18. Subbottom investigations for dredging projects are normally made under the direct supervision of geotechnical engineers and the sampling, testing, and material descriptions will invariably be made using geotechnical engineering methods and terminology. The relationship between the dredgeability properties of the materials encountered and the geotechnical engineering description of the soil properties, therefore, needs to be clearly understood. The following is a discussion of:

- a. The dredgeability properties of soils that govern dredging equipment selection and performance.
- b. The geotechnical soil properties that are significant for indicating, or inferring, the dredgeability properties.
- c. Definitions of the significant geotechnical engineering soil properties.

This discussion is intended to serve as a common base of nomenclature and definitions for use by all readers. For more complete discussions of the topics reviewed here, the reader should consult textbooks and other publications on each topic.

### Dredging Processes

19. Dredgeability is defined as the facility with which an underwater sediment, soil or rock, can be excavated, removed, transported, and deposited with respect to known or assumed dredging equipment and methods and the physical characteristics of the in situ material. Dredgeability, as used here, refers only to that part of the total production rate and/or required fuel energy that is directly influenced by the properties of the soil/rock to be dredged. There are three independent variables that affect dredgeability: (a) type and size of dredging equipment, (b) stage of the dredging process, and (c) the physical characteristics of the soil or rock.

20. The stages of the process of dredging a soil sediment are:

- a. Excavation (loosening or dislodging) of the material from the bottom.
- b. Removal of the loosened material to the dredge vessel.
- c. Transportation of the material to the disposal area.
- d. Disposal of the material.

21. The mechanisms used in the various stages of a dredging operation are a function of the type of equipment used and the characteristics of the sediment being dredged. Each of the four dredging stages are accomplished using one or a combination of hydraulic, pneumatic, and mechanical devices. The final disposal action by the contractor may also include manipulation of the soil in the disposal area, such as shaping, or even drying and compacting the soil. The mechanisms are described in Table 1.

22. Dredging equipment is usually classified according to the specific methods used for excavating, removing, and transporting the soil. Several published references discuss dredging equipment in general and the interested reader is referred to them for detailed information. Among these are Bray (1975, 1979); Herbich (1992); International Association of Ports and Harbors (IAPH, 1987); Murden (1984); Reid (1986); Turner (1984); and Verhoeven, de Jong, and Lubking (1988). The common generic types of dredging equipment for performing the various stages of the dredging process are shown in Table 2.

#### Dredgeability Properties of Soil Sediments

23. The geotechnical engineering soil properties that govern during the excavation stage of a dredging project, for both the hydraulic/pneumatic and the mechanical methods, are the properties that govern shear strength. Once the soil has been excavated (loosened or dislodged), the in situ structure is destroyed, and only the soil material properties of the remolded soil remain of interest in dredging operations. Rheologic properties tests, sedimentation tests, and bulking factor tests are made on the remolded soil for specific applications.

24. The dredgeability of a soil deposit is directly dependent on the dredging equipment mechanism used. Considering the dredging mechanisms described in Table 1, the dredgeability properties of various soils during the stages of dredging operations are:

- a. Excavation Stage--suctionability, erodability, cuttability, scoopability, and flowability (slope instability).
- b. Removal and Transport Stages--pumpability, settleability in a hopper, and bulking.
- c. Disposal Stage--dumpability (stickiness), settleability in a disposal area, and compactability.



Table 1  
Dredging Mechanisms

<u>Type</u>	<u>Description</u>
<u>Excavation Mechanisms</u>	
Plain Suction	Suction is applied to a pipe inserted into extremely loose or soft soil. External pressure causes the soil to enter the pipe as a soft mass at nearly 100% of in situ volume, i.e., with little or no excess water.
Hydraulic Erosion (Scour)	Cavitation and impingement erosion occur. The flow of a high velocity, high volume water or air stream across the surface of a clean granular material causes cavitation erosion, which plucks (lifts) the grains into a water stream. Jetted water or air impinges on grains, pushing them into the fluid stream. Due to the high volume of water or air required for erosion, the resulting soil-water slurry is highly diluted and relatively low in solids content.
Mechanical Dislodgement -- Cutting	If soil/rock is dense granular, friable (easily crumbled or pulverized), or cohesive, cutting it with a rotating or fixed blade or ripping it with plows or knives moves the soil/rock particles into a water stream to form a low solids content soil-water slurry.
Mechanical Dislodgement -- Scooping	Scooping of the soil/rock may be done with a bucket, shovel, or clamshell.
<u>Removal Mechanisms</u>	
Hydraulic Pipeline	A suction pipeline is used to move the soft mass or the soil-water slurry from the excavation (dislodgement) area at the bottom to the pumping system on the dredge vessel.
Mechanical Containers	A bucket, scoop, shovel, clamshell, bucket ladder, bucketwheel, or other container is used to move the material from the bottom to the surface; often this is the same device used for excavation.
<u>Transport Mechanisms</u>	
Hydraulic Pipeline	The particles, clumps of material, or clay balls, are pumped in a pipeline as a soil-water slurry.
Mechanical Containers	The material is moved in the hold of a hopper ship, a barge (self-propelled or towed), or a land-based device such as a truck or conveyor belt.

(Continued)

Table 1 (Concluded)

Type	Description
<u>Disposal Mechanisms</u>	
Hydraulic Pipeline	The pipeline soil-water slurry is directly discharged into a land or water disposal area.
Mechanical Devices	Materials are discharged from mechanical containers by (a) bottom discharge from hopper ship or barge, (b) direct dumping from the transport unit, or (c) mechanical removal using a scraper, bucket, clamshell, or high pressure water stream.

Excavation stage

25. Suctionability during excavation. Suctionability is the facility with which a sediment can be excavated by plain suction; the sediment is drawn into a hydraulic suction pipe at, or very near, its in situ density, i.e., with little or no diluting water. If a fine-grained soil is extremely soft, the external pressure caused by direct suction in a pipe embedded in the soil mass will cause a shear failure in the soil and a flow of the soil into the pipe. Granular soils derive shear strength from grain-to-grain contact and do not easily flow in a constricted pipe except as a high water content slurry. Therefore, the soil to be suctioned must be cohesive, extremely soft, and have a very high water content and very low density.

26. Erodability (scourability) during excavation. Erodability, or scourability, is the ease with which a sediment can be excavated by the shearing or direct impact action of a fluid moving parallel, or at a slight angle, to the sediment surface. The critical tractive shear stress is directly related to the shear strength and the particle sizes of the sediment. Cohesionless soils behave as discrete particles and cohesive soils behave as coherent materials.

27. Cuttability during excavation. Cuttability is the relative ease with which a sediment can be excavated by shearing with a blade, knife, or plow. Cutting is used to dislodge: (a) cohesionless (clean granular), (b) friable mixed-grain, and (c) cohesive soils. Friability is the ability of the soil to be easily crumbled or pulverized. A friable soil must have low plasticity. The resulting particles, clumps of particles, or clods are then

Table 2  
Characteristics of Dredging Equipment

<u>Dredge Type</u>	<u>Excavation Method</u>	<u>Removal Method</u>	<u>Transport Method</u>	<u>Disposal Method</u>
<u>Hopper Dredges</u>				
Trailing Arm Hopper	Mechanical dislodgement using knives or blades; hydraulic suction	From bottom to dredge vessel pump in	Soil settles in vessel hopper	Bottom dump from hopper
Plain Suction Hopper	Hydraulic erosion	hydraulic pipeline as a soil-water slurry	(hold); vessel moves to disposal site	ship or barge; side casting from hopper ship
Bucket Hopper	Scooping by mechanical bucket system	Mechanical bucket		
<u>Pipeline Dredges</u>				
Cutter Suction	Mechanical dislodgement using rotary cutter	From bottom to dredge pump in	From dredge vessel to disposal area in pipeline	Direct discharge on land or water disposal site as a soil-water slurry
Plain Suction	Hydraulic or pneumatic erosion; direct suction	pipeline as a soil-water slurry	as a soil-water slurry	
Dustpan Suction	Plain suction; impingement scour using water or air jets			
Bucket Wheel Suction	Mechanical dislodgement, scooping with buckets			
<u>Mechanical Dredges</u>				
Bucket Ladder	Mechanical dislodgement, scooping with buckets	Series of buckets	Barge; land-based conveyor	Bottom dump or scraper
Clamshell	Mechanical dislodgement, scooping with clamshell	Clamshell bucket	belt; trucks	to unload barges; direct discharge from belt or trucks
Dipper	Mechanical dislodgement, scooping with bucket	Dipper bucket		
Dragline	Mechanical dislodgement, scooping with dragline bucket	Dragline bucket		
Backhoe	Mechanical dislodgement, scooping with backhoe	Backhoe bucket		

entrained in a high velocity, high volume water stream. The cutting forces on a saturated sand have been theoretically studied by Miedema (1984, 1985, 1986, 1989a, 1989b) and by Steeghs (1985a, 1985b). During the rapid cutting of a sand or any other granular soil, a rapid increase in volume tries to occur. If the permeability is low, volume change is inhibited and a water suction (negative pore water pressure) develops, causing an increase in shear strength. This effect is greater the lower the permeability of the soil; the finer the soil, the lower the permeability. Properties that govern cuttability are shear strength, grain-size distribution, percent fines, low plasticity (low stickiness), and adhesion to the metal cutting surface.

28. Scoopability (diggability) during excavation. Scoopability, or diggability, is the ease with which a sediment can be excavated, or dislodged, using the cutting edge of a scoop, bucket, or shovel. A scoop (bucket, clamshell, etc.) uses a cutting edge to mechanically dislodge a mass of soil. As described above under "Cuttability," the cutting resistance of granular soil is affected by negative pore water pressure caused by rapid shear strain; the finer the granular soil, the greater the resistance. The cutting resistance of a cohesive soil is directly related to shear strength as measured by its consistency. Properties that govern scoopability are shear strength, grain- size distribution, percent fines, low plasticity (low stickiness), and adhesion to the metal cutting surface.

29. Flowability (slope instability) during excavation. Flowability is the facility of a sloped soil deposit to fail and flow into an excavation at its lowest end; it is the instability of a sloped soil. If the soil is very soft or is loose and granular, a slope that is steepened during excavation may fail in shear and flow into the cut area. The disturbed sediment has a lower shear strength than it did before the disturbance. This promotes entrainment in the suction stream of hydraulic removal systems.

#### Removal and transport stages

30. Pumpability during removal and transport. Pumpability is the ease with which a soil slurry can be pumped in a pipeline. Sediment type is only one of the factors influencing the energy needed for pipeline transport of sediments. All other factors being held constant, such as the nature of the transporting fluid, the equipment geometry, and the slurry factors, the energy required to pump a slurry in a pipeline depends on the typical grain size of

the sediment. The typical size has been defined as the median size, d<sub>50</sub>, by Herbich (1992), Turner (1984), and others. Others have defined the typical grain size as the 85 percent size (d<sub>85</sub>) or as the geometric mean size. The maximum size of particle must be known for pump clearance.

31. Herbich (1992) discussed the effect of nonuniformity or dispersion of grain sizes (uniform versus well graded). The greater the dispersion (well graded) the greater the tendency for segregation of grain sizes in the pipeline, with the larger grains travelling along the bottom of the pipe. Grain shape affects the ease with which individual coarse grains will slip past each other in the slurry. Greatest slurry fluidity occurs with rounded grains. Hard angular soils will cause pipeline wear. Medium to high plasticity clays will form clay balls in the pipeline. The rheologic properties of slurry (dynamic shear strength) may affect pump energy required.

32. Sedimentation rate during transport. The rate at which a particle will settle in still water is a function of grain diameter and the viscosity of the settlement medium; larger particles settle faster. Silt particles can take hours to settle in the agitated water of a hopper and clay may not settle at all. Salinity of the water may cause flocculation of fine particles into coarser ones, hastening settlement. Assessment of settleability requires knowledge of grain-size distribution, percent silt, percent clay, plasticity of the fines, and salinity of the water.

33. Bulking factor of redeposited soils. A bulking factor is the ratio of the volume occupied by a given amount of soil in a containment area in either a hopper or a disposal area immediately after deposition by a dredging process, to the volume occupied by the same amount of soil in situ. Granular materials may increase or decrease volume, depending on the initial density state (loose or dense) and the final deposition manner. Cohesive soils tend to have a volume increase upon removal from their in situ position and to retain it during deposition unless they are mechanically compacted in the containment area.

34. DiGeorge and Herbich (1978) reported a laboratory study of bulking factors in fine-grained soil. They show that the deposition volume of a soil is not a constant, but depends on grain-size distribution, flocculation capacity (related to water salinity), percentage of fines (silt and clay), plasticity of the fines, and the initial and deposition water contents.



### Disposal stage

35. Dumpability during disposal. Cohesive soils that have a medium to high plasticity index, and are neither very dry nor extremely soft and wet, may be within the sticky range for that soil and may adhere to the barge or other metal equipment during dumping operations. Granular soils containing fines may "bridge" during dumping and may require jetting with high pressure water streams.

36. Sedimentation rate during disposal. The rate at which a particle will settle in still water is a function of grain diameter; larger particles settle faster. Silt and clay particles take hours and days to settle. Salinity of the water may cause flocculation of fine particles into coarser ones, increasing their apparent size, hastening settlement. Assessment of settleability requires knowledge of grain-size distribution, percent fines, plasticity of the fines, and salinity of the water.

37. Compactability during disposal. Machine compaction to a specification limit in a land disposal area requires either granular soil or low plasticity cohesive soil that has been dried to approximately the plastic limit water content. All soils at almost any water content can be densified mechanically, but not to specified compaction limits. Therefore, knowledge is needed of the grain-size distribution, plasticity, and water content.

### Geotechnical soil properties significant for dredgeability

38. In geotechnical engineering practice, all soils are characterized by their:

- a. Material (particle) properties, i.e., the properties of the individual grains or particles: mineralogical composition, grain specific gravity, surface chemistry, size, shape, angularity, and hardness.
- b. Mass (intact) properties. The position and arrangement of the soil particles in a soil mass determine the mass properties, i.e., in situ density, water content, gas content, and structure.
- c. Shear strength properties. Shear strength is a combined function of (a) the material properties, (b) the mass properties, and (c) the applied external force system.

39. The *soil material properties* that are used to indicate, or infer, dredgeability and that must be identified, by test or estimate, and described for every soil deposit found in the dredging prism are (Spigolon 1989a):

- a. Grain-size distribution of the soil.
- b. Plasticity of the fine (-No. 40 sieve) fraction.
- c. Grain angularity, shape, and hardness (granular soils only).
- d. Presence and estimated amount of peat, other organics, cementation, shells, and debris.

Additional tests and observations are: (a) the specific gravity of grains, needed for mass-volume calculations, (b) the color, useful in identifying similar soils and in correlating strata, and (c) the presence or absence of odor, indicating possible organic matter. The *soil mass properties* and *soil shear strength properties*, of the undisturbed soil, that are needed for dredgeability estimation are:

- a. In situ shear strength; i.e., compactness of cohesionless soils, consistency of cohesive soils, degree of cementation of cemented soils.
- b. In situ density.
- c. In situ water content.
- d. Structure of in situ soil (cohesive soils only).
- e. In situ permeability.

Estimates of in situ shear strength are based on (a) laboratory tests made on undisturbed samples of the soil, (b) direct or indirect measurements from field tests of the in situ soil, or (c) correlations with the index properties tests, i.e., soil material and mass properties tests such as grain-size distribution, plasticity, density, and water content. In addition, the special dredging properties that are often of importance and that are investigated and reported as needed include: (a) the rheologic properties of slurry at various densities, (b) the sedimentation rate in salty water, and (c) bulking factors for deposition areas such as hoppers, barges, and land or water disposal areas.

#### Geotechnical Soil Material Properties

40. The soil material properties are those of the soil components, without reference to their arrangement in a soil mass, i.e., the individual grains, the pore water, or the other materials present. Soil material identification tests are performed on a sample of soil whose in situ mass structure has been completely disturbed by remolding.

### Grain-size distribution

41. The distribution of particle sizes is determined by screening the soil through a set of sieves and the results are expressed in the form of a cumulative semilog plot of percentage finer versus grain diameter, as shown in Figure 1. The use of screens to fractionate silt- and clay-sized particles, smaller than about 0.075 mm (No. 200) to 0.063 mm (No. 230), is impractical because of the fineness of screens and their tendency to become clogged with particles. For that fraction of the soil the sedimentation rate in water is used to establish quantities of various sizes. Useful values determined from the grain-size distribution curve are:

- a. Maximum grain size: Smallest screen size through which all particles will pass.
- b. Median grain size: Grain diameter ( $d_{50}$ ) corresponding to the 50-percent finer ordinate on the grain-size distribution curve.
- c. Effective size: Grain diameter ( $d_{10}$ ) corresponding to the 10-percent finer ordinate on the grain-size distribution curve.
- d. Coefficient of uniformity: Ratio of the  $d_{60}$  size to the  $d_{10}$  size.
- e. Coefficient of curvature: Ratio of the square of the  $d_{30}$  size to the product of the  $d_{60}$  and the  $d_{10}$  sizes.

### Sedimentation rate in water

42. The rate at which individual or flocculated soil particles will settle in water is a function of their grain size and of the nature of the fluid. The settlement rate of deflocculated soils in distilled water may be determined from the standard laboratory test for grain-size distribution, or from expedient decantation or pipette tests, described in Part VI of this report. However, the presence of salt in the water affects the amount of flocculation of the fine-grained particles, seriously affecting the sedimentation rate (HQUSACE 1987).

### Sedimentation rate in salty water

43. Because of the electrical charges of attraction and repulsion acting on clay particles, the presence of seawater will cause clay particles to flocculate, or combine, to form apparently larger particles. The larger particles, or flocs, will then settle at a rate dependent on their floc size rather than individual grain sizes. The laboratory test procedure for silt and

Figure 1. Typical grain-size distribution curves

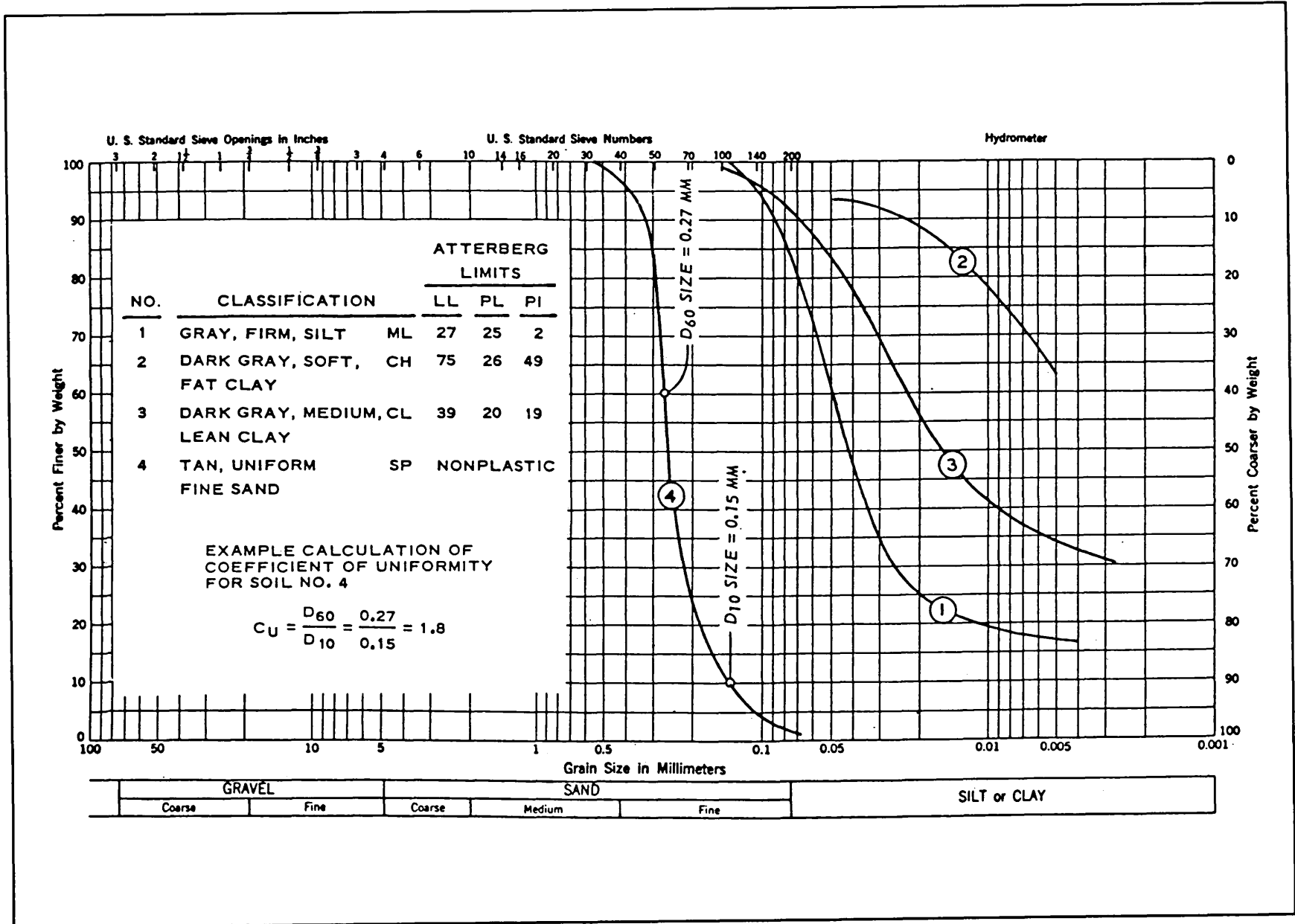

clay sizes (hydrometer or decantation test) usually requires dispersal of the individual particles using a chemical deflocculating agent. Therefore, the settlement rate of the various grain-size fractions of a soil may be faster if the clay particles have flocculated and act as coarser particles. A special sedimentation test using seawater as the suspending medium may be more instructive.

#### Plasticity of the fine fraction

44. A distinction exists between the terms clay *sizes* and clay *minerals*. The clay size fraction is determined by an appropriate gradation (sedimentation) test and includes all particles smaller than a given size, usually taken as 0.002 mm (2  $\mu$ m). The behavior of the fine fraction depends to a great extent on the mineralogical composition of that fraction, i.e., the type of clay minerals.

45. The plasticity of the fine-grained soil fraction (-No. 40 sieve) reflects the combined influence of the mineralogy of the clay and the physico-chemical interactions of the fine fraction of soils (Terzaghi and Peck 1967). The Atterberg limits, ASTM (1992) Method D4318, indicate the range of water content over which the portion of a soil finer than the No. 40 screen (0.425 mm) behaves in a plastic manner; the range is affected by the type and amount of -0.002-mm clay mineral present. The upper limit of the range is defined as the *liquid limit* (LL) and the lower limit is defined as the *plastic limit* (PL). The LL is the water content at which the soil will just begin to flow when jarred in the prescribed manner. The PL is the water content at which the soil will just begin to crumble when rolled into threads 3 mm (1/8 in.) in diameter. The *plasticity index* (PI) is calculated as the difference between the liquid limit (LL) and plastic limit (PL) water contents, i.e.,  $PI = LL - PL$ .

46. The Atterberg limits tests are expedient and inexpensive, making them a useful tool in fine-grained soil identification. Balling of clays in a dredging pipeline appears to be a direct function of the plasticity. Based on a chart developed by Casagrande (1948), the identification of the fine-grained fraction of soils in the Unified Soil Classification System (USAEWES 1960; ASTM 1992) is based solely on the Atterberg limits, as shown in Figure 2. When paired with a determination of the percent clay (-0.002 mm) fraction, they provide a simple method of estimating the clay mineral type.



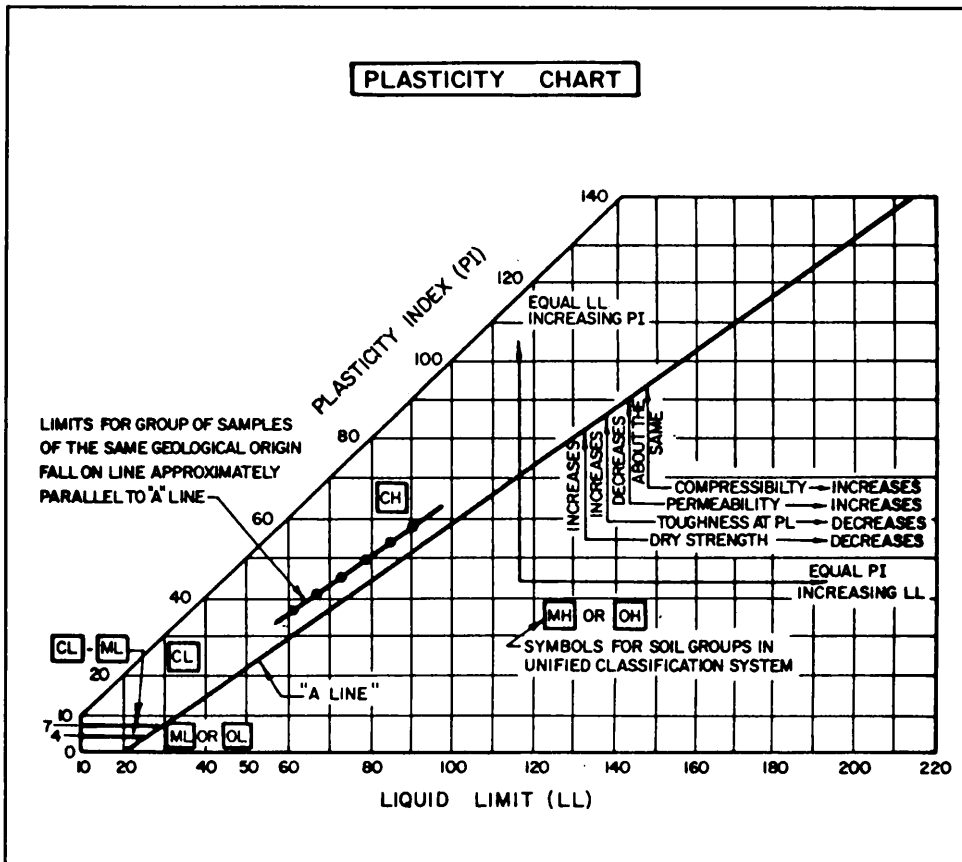

Figure 2. Casagrande plasticity chart for cohesive soils (NAVFAC 1982)

47. Liquidity index. The liquidity index (LI) is a numerical expression of the water content ( $w$ ) of cohesive soils *relative* to the limits of the plastic range of water contents for a disturbed clay soil. It is defined as  $LI = (w - PL) / (LL - PL)$ . Since the range of water content from the liquid limit (LL) to the plastic limit (PL) is the plasticity index, the range of plastic soil behavior for the specific clay soil, the existing water content may be related to the plasticity index (PI) as  $LI = (w - PL) / PI$ . A liquidity index of zero indicates that the remolded soil is at the plastic limit water content and is stiff, whereas at  $LI = 1.00$  (or 100 percent) the soil is at the liquid limit water content and is extremely soft. A liquidity index of greater than 1.00 indicates a liquid-like soil, i.e., a soil slurry.

48. Activity index. Skempton (1953) defined the activity of a clay as the ratio of the plasticity index to the percent  $>0.002$  mm clay, a direct linear relationship. He identified a large group of marine and estuarine clays, with illite as the main clay mineral, having activities ranging from

0.75 to 1.25, i.e.,  $A = PI / (\% - 0.002 \text{ mm}) = 0.75 \text{ to } 1.25$ . Sowers (1979) stated: "The activity expresses the plasticity of the . . . clay minerals. This . . . suggests whether the clay is a kaolinite (low activity,  $<1$ ), a montmorillonite (high activity,  $>4$ ), or illite (intermediate activity, 1-2)." The higher the liquid limit and/or plasticity index, and therefore the higher the clay content, the greater the cohesiveness, stickiness, and dry strength and the lesser the friability of the clay.

#### Angularity, shape, and hardness of coarse grains

49. Grain shape is a factor in the shear strength of granular soils. When coarse-grained soils are pumped as a slurry, the shape of the grains affects the energy required to maintain flow. The more angular or flat the particles, the greater the required energy. The hardness of the grains affects the wear of the pipeline (Herbich 1992, Turner 1984). Definitions and procedures for defining the angularity and shape of coarse particles are given in Part VI of this report.

#### Specific gravity of grains

50. The specific gravity of the solid constituents of a soil is the ratio of the unit weight of the solids to the unit weight of water. While it does not indicate dredging behavior, specific gravity is essential for the calculation of void ratio and porosity. The other properties needed are in situ density and water content. These calculations involve determination of the density and volume of the soil solids as part of the total in situ volume. During dredging, all measurements of total volume, or of weight, include the soil solids plus a variable amount of water. The only constant useful in determining quantities dredged is the volume of soil solids to be excavated, moved, and disposed of.

#### Color and odor

51. Soil color, while not of great consequence to the dredgeability of soils, is of considerable help in correlating soil samples from location to location during geotechnical analysis of the site investigation. Soil colors are often useful in (a) detecting different strata, (b) defining soil type based on experience in a local area, and (c) possible identification of materials. Dark or drab shades of brown or grey, and almost black, soils are typically organic. However, some soils are black from other minerals. Brighter colors are associated with inorganic soils (Terzaghi and Peck 1967). Red, yellow, and yellowish brown suggest iron oxide, whereas white or pink

indicate silica, calcium carbonate, or aluminum compounds. Odor is an immediate and evident indicator of organics or chemical pollutants.

#### Organic content

52. Sediments may contain organic matter that will affect the excavation and pumping processes. The organic content of a soil sediment may be established in the laboratory by dry combustion or wet combustion or by using the ASTM D2487 (ASTM 1992) Atterberg limits procedure. In the ASTM procedure, the Atterberg liquid limit is determined on a sample that has not been previously dried and again on the sample after it has been oven dried. If the liquid limit, oven dried, is less than 75 percent of the liquid limit, never dried, the soil is defined as organic. The *ash content* is the uncombusted residue, mostly clay minerals, after the sample has been dried at a sufficiently high temperature to burn all the organics.

#### Cementation

53. Granular and mixed-grain soils may be cemented with various natural cementing agents. These agents are primarily compounds of iron or alumina, or are calcium or magnesium oxides or carbonates. The only cementing agents for which terminology has been developed are those that will react with hydrochloric acid, mostly calcium carbonate (limestone) or calcium oxide (lime).

### Geotechnical Soil Mass Properties

54. The soil mass properties are those relating to the arrangement of the material components. They include the relative positions of the soil grains, their structure, and mass density. The soil material and soil mass properties are independent of each other. The same soil material can exist in a number of different arrangement states, and different soils can have the same water content, density, and other soil mass characteristics.

#### Mass density (unit weight)

55. The mass density is the total weight per unit of volume. *Wet density* (wet unit weight) is defined as the total weight of gas, water, and soil solids per unit of volume of the soil. *Dry density* (dry unit weight) is the dry weight of solids per unit volume of the soil. *Saturated density* (saturated unit weight) is the total weight of water and soil solids per unit of soil volume when the void space contains only water (no gas).

### Water content

56. The water content is defined as the weight of water in the soil expressed as a percentage of either (a) the dry weight of the solid matter present in the soil (used by geotechnical engineers), or (b) the total mass, including soil and water (used by most scientists and some other engineers). In a marine environment, a correction for salinity of the pore water is generally made (Eckert and Callender 1987). The water content is based on the loss of water at the arbitrary drying temperature of 105 to 110 °C.

### Degree of saturation

57. Degree of saturation is calculated as the volume of water as a percentage of the total volume of voids. Thus, at 100-percent saturation, all of the void space is occupied by water and at 0-percent saturation, all of the void space is occupied by gas (air or other gas).

### Porosity and void ratio

58. Porosity is calculated as the ratio of the volume of voids in a soil mass to the total volume of soil, which includes gas, water, and solids. Void ratio is calculated as the ratio of the volume of the void space, including water and gas, in a soil mass to the volume of the solid constituents. Void ratio is used in geotechnical engineering because of its value in further calculations involving weight-volume relations.

### Relative density

59. The terms loose and dense are, implicitly, terms that define relative density. Relative density is the dry unit weight of a clean granular soil relative to its minimum and maximum densities:

$$D_r = \frac{\gamma_d - \gamma_{dmin}}{\gamma_{dmax} - \gamma_{dmin}} \times \frac{\gamma_{dmax}}{\gamma_d} \times 100 \quad (1)$$

where

- Dr = Relative density, percent
- $\gamma_D$  = In-situ dry density
- $\gamma_{dmin}$  = Minimum dry density (loosest state)
- $\gamma_{dmax}$  = Maximum dry density (densest state)

The maximum and minimum densities of a soil sample are determined by laboratory tests using ASTM Test Methods D4253 and D4254 (ASTM 1992).

A relative density of 100 percent means the soil is at its maximum achievable density and 0 percent means it is at the minimum density state. It is possible to have in situ densities greater than the maximum or less than the minimum, since these values are defined by standardized laboratory tests. The method of calculation and an example are given in Figure 3. The terminology applies only to those soils that will densify, or loosen, readily as a result of vibration, i.e., gravels, sands, silty sands, and inorganic cohesionless silts. This implies a low fines content, with little or no plasticity (stickiness) in the fines. The percentage of fines that will allow a soil to be successfully densified by vibration is a function of the plasticity of the fines and the gradation of the granular component.

Permeability

60. The in situ permeability of a soil affects the shear strength. Its in situ measurement is very difficult. Correlations have been established

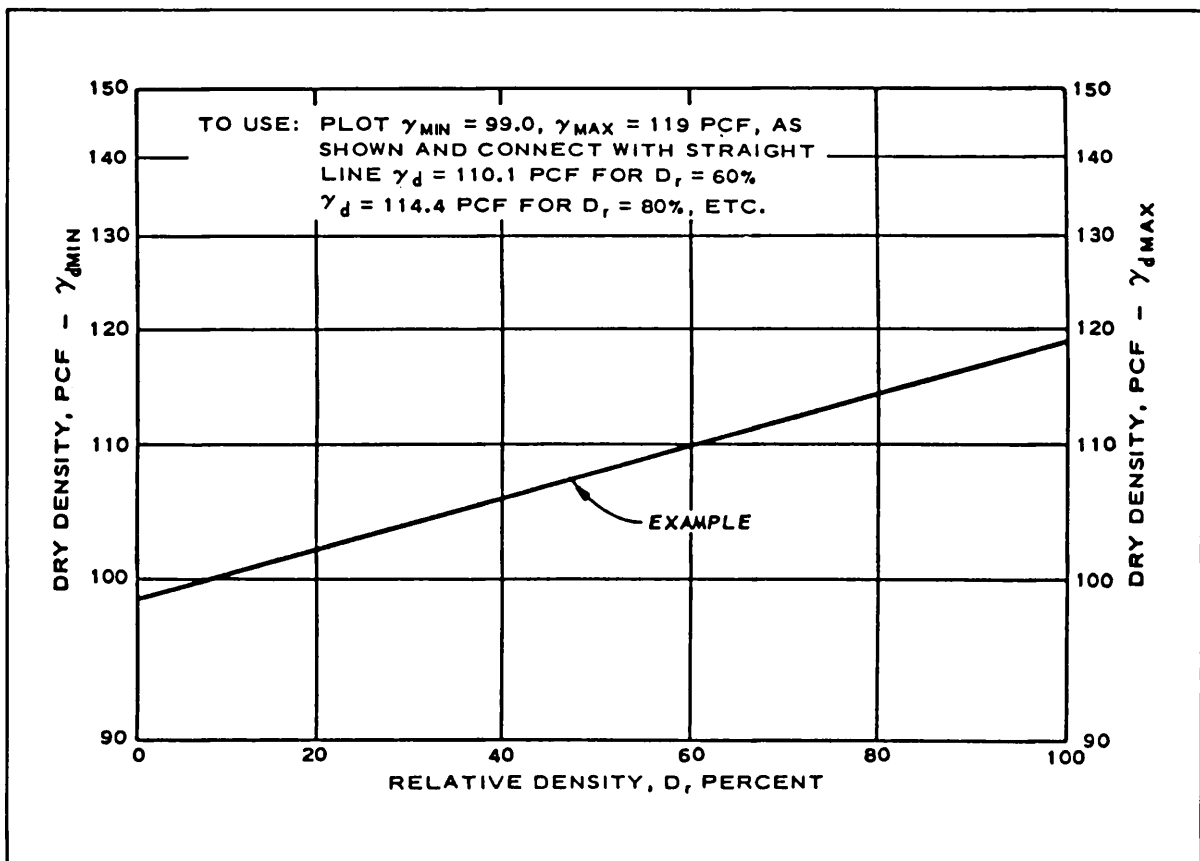

Figure 3. Example of graphical solution for relative density

with grain size distribution tests (NAVFAC 1982, Figure 1, p 7.1-139). Terzaghi and Peck (1967, p 55), and other authors have presented a tabulation of typical permeability values for various soil types. These broad characterizations of permeability values are sufficient for use in the evaluation, and understanding, of shear strength tests. Therefore, permeability can be estimated from the soil material properties tests and, although they may be of interest in research projects, there should never be a need for a field or laboratory permeability test as part of a dredging project site investigation.

#### Weight-volume relationships

61. The several soil mass properties defined above are interrelated. Calculations for weight-volume relationships are illustrated in Figure 4. Typical values for porosity, void ratio, saturated water content, and unit weight for natural soils in situ are given in Table 3. The tabulated values were taken from various published sources and are shown here for illustration only; actual measured values may differ slightly from those shown.

#### Geotechnical Soil Behavior Properties

62. The soil behavior properties of interest during excavation include cohesion, angle of internal friction, adhesion to steel cutting surfaces (stickiness), tendency to dilate, and permeability. Tests of the soil strength properties must be performed on undisturbed soil, either in situ or on undisturbed samples carefully taken and tested to preserve the in situ structure.

63. The shear strength of a soil mass is a fundamental engineering behavior property. The maximum shear stress is related to the normal stress as:

$$s = c + (\sigma - u) \tan \phi \quad (2)$$

where:

- s = shear stress
- c = cohesion intercept
- $\sigma$  = normal stress
- u = pore water pressure
- $\phi$  = soil angle of internal friction

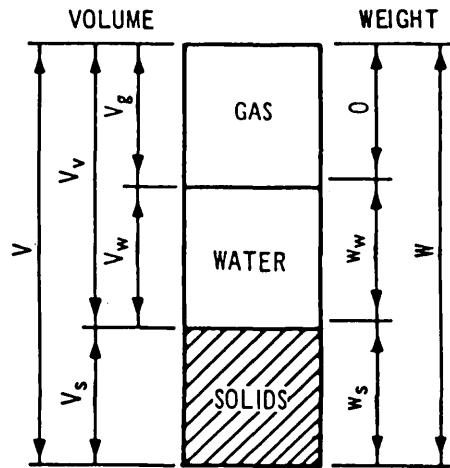

WATER CONTENT	$w = \frac{W_w}{W_s}$
SPECIFIC GRAVITY	$G_s = \frac{W_s}{V_s \gamma_w}$
VOLUME OF SOLIDS	$V_s = \frac{W_s}{G_s \gamma_w}$
VOLUME OF VOIDS	$V_v = V - V_s$
VOID RATIO	$e = \frac{V_v}{V_s} = \frac{n}{1-n}$
POROSITY	$n = \frac{V_v}{V} = \frac{e}{1+e}$
DEGREE OF SATURATION	$S = \frac{V_w}{V_v} = \frac{w G_s}{e}$
UNIT WEIGHT OF WATER (FRESH WATER)	$\gamma_w = \frac{W_w}{V_w} = 62.4 \text{ PCF}$
DRY UNIT WEIGHT	$\gamma_d = \frac{W_s}{V} = \frac{\gamma_m}{1+w}$
WET UNIT WEIGHT	$\gamma_m = \frac{W}{V}$
SUBMERGED (BOUYANT) UNIT WEIGHT	$\gamma' = \gamma_m - \gamma_w = \frac{G_s - 1}{1+e} \gamma_w$

Figure 4. Weight-volume relationships

Table 3  
Typical Weight-Volume Properties of Soils

<u>Soil Description</u>	<u>State</u>	<u>Porosity</u> n%	<u>Void Ratio</u> e	<u>Water Content</u> w%	<u>Unit Weight</u>				<u>Ref*</u>
					<u>Dry</u>		<u>Saturated</u>		
					<u>PCF</u>	<u>Kg/m<sup>3</sup></u>	<u>PCF</u>	<u>Kg/m<sup>3</sup></u>	
Uniform spheres (theoretical)	Loose	48	0.92						HOU
	Dense	26	0.35						
Well-graded silty, sandy gravel	Loose	39	0.65	25	100	1600	125	2000	SOW
	Dense	20	0.25	10	132	2120	145	2320	
Glacial till, mixed gr.	Firm	20	0.25	10	132	2120	145	2320	PHT
Sand, mixed-grained	Loose	40	0.67	25	99	1590	124	1990	PHT
	Dense	30	0.43	16	116	1860	135	2160	
Well-graded sand, subangular	Loose	41	0.70	27	97	1560	123	1970	SOW
	Dense	30	0.35	14	122	1960	139	2230	
Well-graded sand, fine to coarse, clean	Loose	49	0.95	35	85	1360	115	1840	HOU
	Dense	17	0.20	7	132	2210	148	2370	
Uniform sand	Loose	46	0.85	31	90	1440	118	1890	PHT
	Dense	34	0.51	19	109	1750	130	2080	
Uniform sand, fine to medium, clean	Loose	50	1.00	37	83	1330	114	1830	HOU
	Dense	29	0.40	15	118	1890	136	2180	
Silty sand, well graded	Loose	47	0.90	33	87	1390	116	1860	HOU
	Dense	23	0.30	12	127	2040	142	2280	
Sand & silt, micaceous	Loose	56	1.25	47	75	1200	110	1760	SOW
	Dense	44	0.80	30	94	1510	122	1960	
Windblown silt (loess)	Firm	50	0.99	36	85	1360	116	1860	PHT
Uniform inorganic silt	Loose	52	1.10	41	80	1286	113	1810	HOU
	Dense	29	0.40	15	118	1890	136	2180	
Organic silt	Loose	75	3.00	118	40	640	87	1390	HOU
	Dense	35	0.55	19	110	1760	131	2100	
Sandy or silty clay	Soft	64	1.80	67	60	960	100	1600	HOU
	Stiff	20	0.25	9	130	2160	147	2360	
Glacial clay	Soft	55	1.20	45	76	1220	110	1760	PHT
	Stiff	37	0.60	22	106	1700	129	2070	
Clay (30-50% clay sizes)	Soft	71	2.40	88	50	800	90	1510	HOU
	Stiff	33	0.50	19	112	1800	133	2130	
Slightly organic clay	Soft	66	1.90	69	58	930	98	1570	PHT
Very organic clay	Soft	75	3.00	107	43	690	89	1430	PHT
Organic clay (30-50% clay sizes)	Soft	81	4.40	170	30	480	81	1300	HOU
	Stiff	41	0.70	25	100	1600	125	2000	
Montmorillonitic clay	Soft	84	5.20	196	27	430	80	1280	PHT

\* HOU = Hough (1957), PHT = Peck, Hanson, and Thornburn (1974), SOW = Sowers (1979).



The following three laboratory shear test types, in which drainage conditions are used to control the pore water pressure, are in common use: (a) the Unconsolidated-Undrained (Q) test, (b) the Consolidated-Undrained (R) test, and (c) the Consolidated-Drained (S) test. During application of the normal force, prior to shearing, the sample may be unconsolidated or consolidated, depending on the drainage permitted. Then, during application of the shearing force, drainage may or may not occur, depending on the speed of testing relative to the permeability of the soil and the drainage conditions of the test device. Laboratory shear test methods in common use are the direct shear test and the triaxial compression test.

Direct shear test

64. The shearing resistance of a sediment may be determined by the direct shear test. In the direct shear test device shown in Figure 5, a sample of the soil is placed between the upper and lower halves of the shear box. A porous stone is placed above and below the sample. A constant vertical (normal) force is applied and the sample is allowed to consolidate to equilibrium with that load (Consolidated test). The upper box is moved with respect to the lower box. The maximum shearing force is the shearing resistance of the sediment under that normal load. If several samples are sheared, each at a different normal load, at such a rate that no drainage can occur during shear (Consolidated-Undrained, or R-test), and the points are

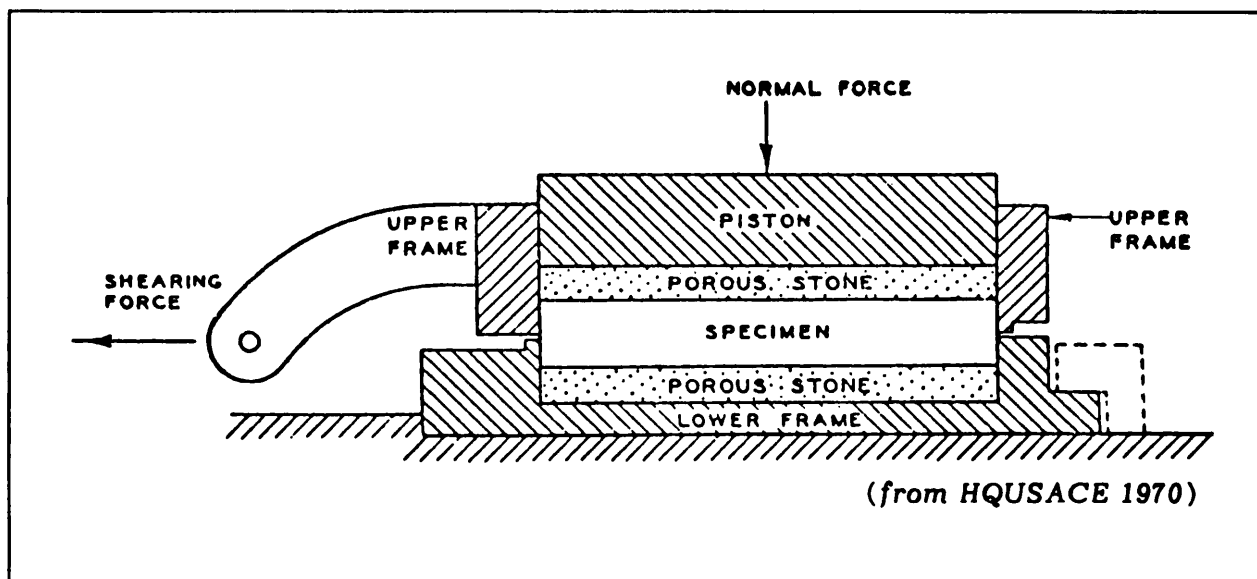

Figure 5. Schematic diagram of direct shear box

plotted on a shear strength versus normal load graph (Figure 6) a straight line through the points will satisfy the shear strength equation (Equation 2). An R-test may be made on cohesive soil because the permeability is so low that virtually no drainage occurs during the shear phase of the test. However, because drainage is not controllable, an R-test is nearly impossible in the direct shear test device in fast draining granular material. Therefore, that part of Figure 6 depicting cohesionless soils in an R-test represents the expected behavior of those soils under the very rapid shear of a cutterhead, knife, or plow in dredging excavation, even though this shear rate cannot be reproduced in the typical direct shear device. A device that permits drainage control during the R-test of cohesionless materials is the triaxial shear test.

Triaxial shear test

65. A cylindrical sample of soil, trimmed to a height twice its diameter, is encased in a watertight membrane and placed inside a fluid-filled test chamber (Figure 7). Chamber fluid pressure is applied to the sample. Drainage of the sample during both the initial consolidation phase and during shear is controlled so that an Unconsolidated-Undrained (Q-test), a

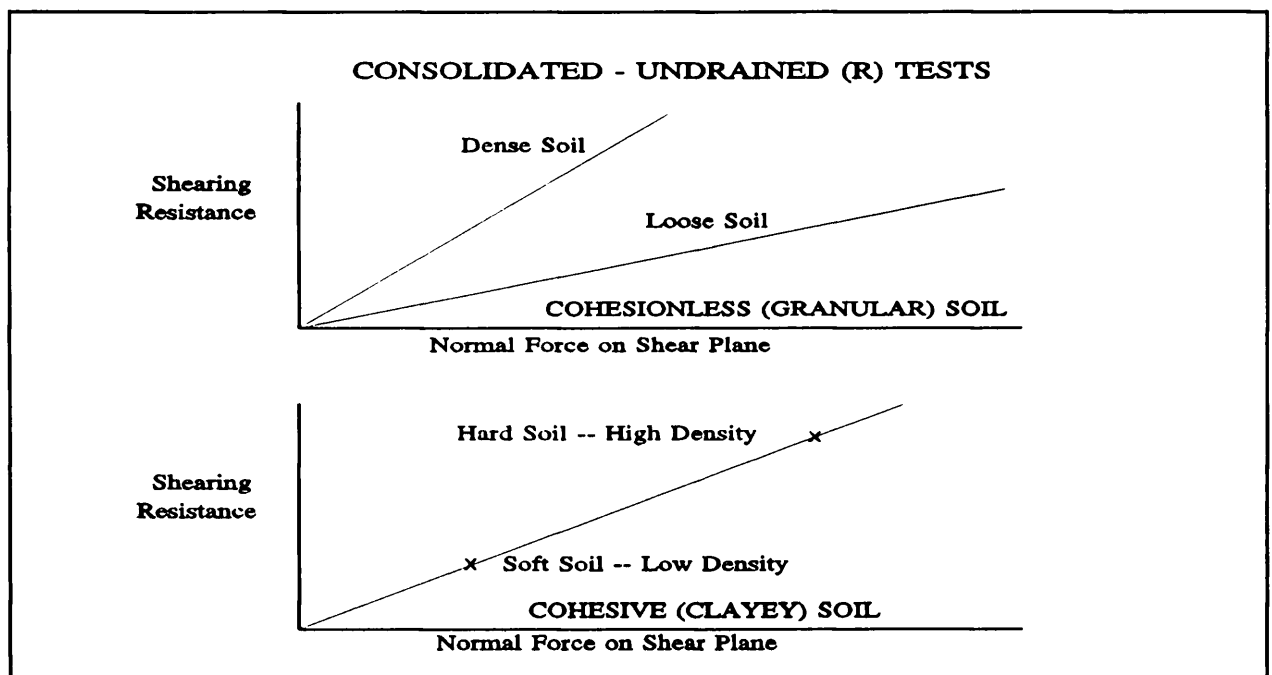

Figure 6. Relationship of shear strength and normal force

Consolidated-Undrained (R-test), or Consolidated-Drained (S-test) may be made. The specimen is usually deformed at a uniform rate vertically and the axial compressive force is measured. Analysis of test data uses concepts of combined stresses at a point to calculate the normal and shear stresses in the sample.

Shear strength of granular soils

66. When tested in either direct shear or triaxial compression, an initially dense granular soil will tend to dilate, or become looser, during shear deformation and an initially loose granular soil will tend to densify during shear. The initially dense granular soil, tending to increase in volume, creates a soil water suction, or negative pore water pressure,  $-u$ . Equation 2 shows that this causes an increase in shear strength. Conversely, an initially loose granular soil tends to collapse to a denser state during shear, causing an increase in the pore water pressure,  $+u$ . From Equation 2, this leads to a decrease in shear strength. If the increased pore water pressure is high enough, the soil loses all shear strength and temporarily liquefies.

67. Under the rapid shearing action of hydraulic erosion or a mechanical cutter during dredging excavation, even the relatively high permeability of loose granular soils is generally too low to permit any drainage during shear. Therefore, compared to slow, drained shear conditions, the required excavation force for very rapid shear is much higher than that estimated from the slower laboratory shear tests.

68. Peck, Hanson, and Thornburn (1974) have indicated: "For gravels, sands, silty sands, and inorganic cohesionless silts the value of . . . (friction angle) . . . depends primarily on the relative density, the grain size distribution, and the shape of the grains." Density is dependent on the

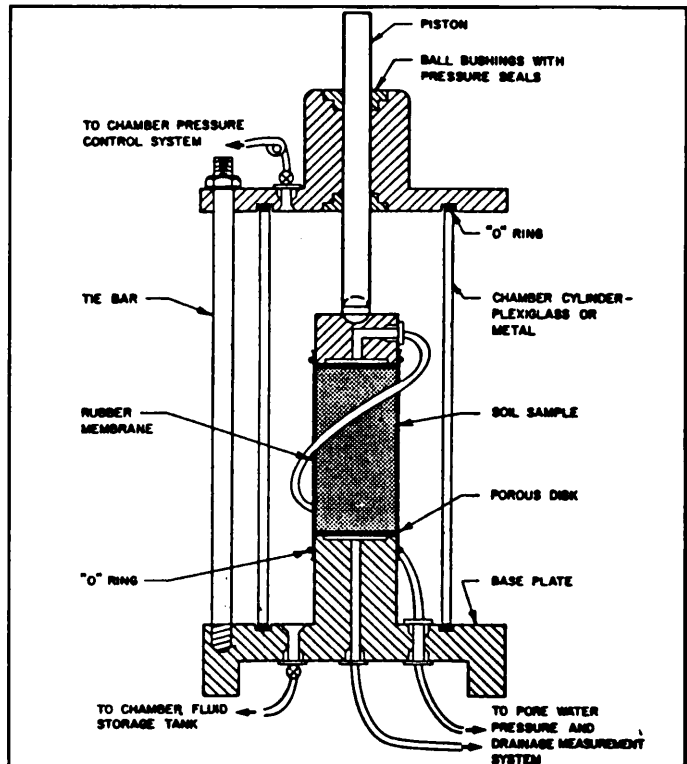

Figure 7. Schematic diagram of triaxial compression apparatus

specific gravity of the grains, the gradation, and the degree of packing (relative density) of the grains. A uniformly graded soil tends to be lighter than a well-graded soil of the same degree of packing because of the larger void space (porosity). A loose soil has a lower drained shear strength than a dense soil of the same gradation.

69. The interrelationship between shear strength and soil material properties is shown in Figure 8, from NAVFAC DM-7.1, Soil Mechanics (NAVFAC 1982) and in Figure 9, which is from Schmertmann as reported by Villet and Mitchell (1981). In Figure 8, the two-letter symbols define soil types from the Unified Soil Classification System (USAEWES 1960; ASTM 1992). At any given value of relative density, the dry density increases with increasing grain size, and with diversity of gradation within a grain size group. The permeability of relatively clean granular soils is generally related to porosity, grain size distribution, and grain shape. The presence of silts and clays greatly reduces permeability. Partial saturation, i.e., the presence of gas, also affects the friction angle and permeability.

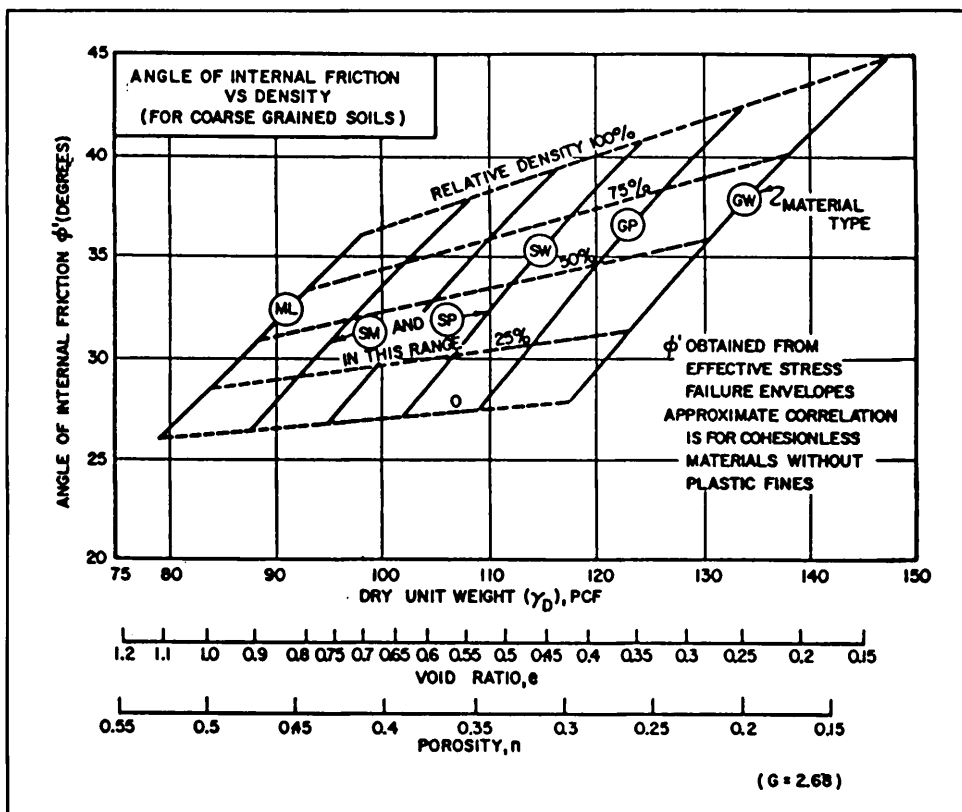

Figure 8. Correlation of strength properties for granular soil

70. Empirical relationships exist, in addition to those of Figures 8 and 9, between angle of internal friction or permeability and the physical soil properties of relative density, bulk density, and gradation in a number of published references. Many are included in geotechnical engineering textbooks such as those by Terzaghi and Peck (1967); Peck, Hanson, and Thornburn (1974); and Sowers (1979). Other useful sources are the Army/Air Force Technical Manual TM 5-818-1, Soils and Geology (HQDOA/AF 1983), and the Navy Design Manual DM 7.1, Soil Mechanics (NAVFAC 1982). An excellent review of the subject is

contained in several state-of-the-art summaries in the Proceedings of the ASCE Conference on "In situ Measurement of Soil Properties" (ASCE 1975).

Shear strength of cohesive soils

71. If the present overburden pressure (due to self-weight) on a cohesive (clayey) soil is the highest pressure the soil has ever been subjected to, and there is no excess pore water pressure, the soil is *normally consolidated*. If the soil was first consolidated to a pressure greater than the present one, and the effective overburden stress was then reduced to its present value, the soil is *overconsolidated*. Many marine deposits are *underconsolidated*, i.e., the cohesive soils have not reached equilibrium with their own self-weight; there is an excess pore water pressure (above hydrostatic). Sangrey (1977) has identified three causes of underconsolidation of shallow sediments: (a) rapid rate of sedimentation--the soil has not yet had time to consolidate under its self-weight; (b) gas pressure--gas formed in situ creates excess pore water pressure; and (c) repeated loading--cyclical stresses from storm waves and ships' propellers can induce excess pore water pressures.

72. Cohesive soils have a shearing behavior in the direct shear test or the triaxial compression test similar to that of granular materials. A

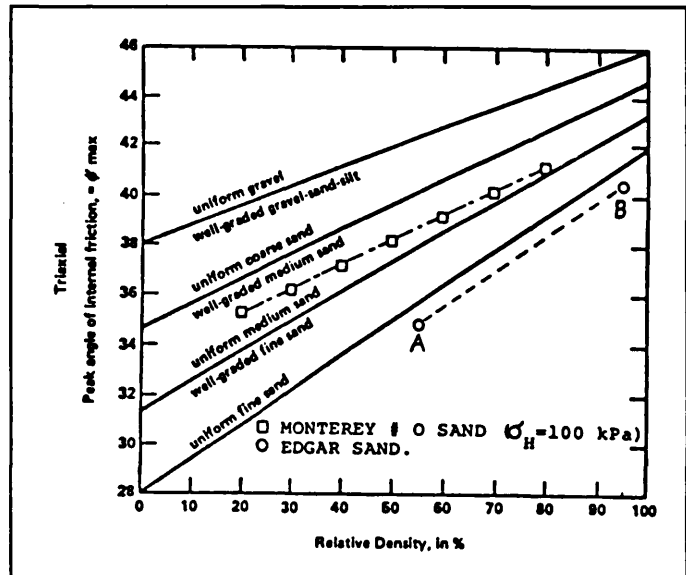

Figure 9. Effect of relative density on friction angle for sands

normally consolidated clay constricts during drained shear in the same manner as a loose sand and an overconsolidated clay dilates in drained shear like a dense sand. During rapid shear, however, cohesive soils behave in an undrained manner because of their very low permeability. The consistency of an undisturbed cohesive soil may be expressed quantitatively by the *unconfined compressive strength*  $q_u$  which is twice the unconsolidated undrained shear strength, or cohesion. This test is, effectively, an Unconsolidated-Undrained (Q-test) triaxial test with zero lateral pressure. Casagrande and Wilson (1951) and others have shown that the unconfined compressive strength of clays and shales tested at very rapid strain rates, such as those occurring during very rapid cutting, increases by 30-40 percent or more over the strength from the common laboratory test made at a slower rate.

#### Sensitivity of cohesive soils

73. It is possible to completely remold a cohesive soil sample, destroying its natural structure, and then re-form it to its original volume, shape, and water content. An unconfined compression test can then be used to determine its remolded strength. Sensitivity is the ratio of the unconfined compressive strength of an undisturbed cohesive soil to the unconfined compressive strength of the same soil sample whose structure has been destroyed by thorough remolding. Sensitivity indicates the strength available at a high deformation and at a high strain rate, as would occur in cutting or scooping a soil. Because of differences in original grain structure, flocculated or dispersed, and in mineralogy, different cohesive soils will have different values of sensitivity.

74. For any given saturated clay sample, the shear strength varies directly with density and, therefore, with water content, porosity, and void ratio. The liquidity index varies directly with water content for a saturated, remolded soil, relative to the liquid and plastic limit water contents, and is directly related to the shear strength for soils of low sensitivity. The liquidity index serves well as a quality check on undrained shear strength tests of low sensitivity soils.

#### Interrelationship of properties of clay

75. Figure 10 illustrates the interrelationship between void ratio/volume change, effective stress, shear strength, and water content for a normally consolidated, remolded, saturated clay of low sensitivity. Void ratio/volume is a function of effective normal stress at equilibrium (upper left, Figure 10). The consolidated-undrained shear strength is also directly

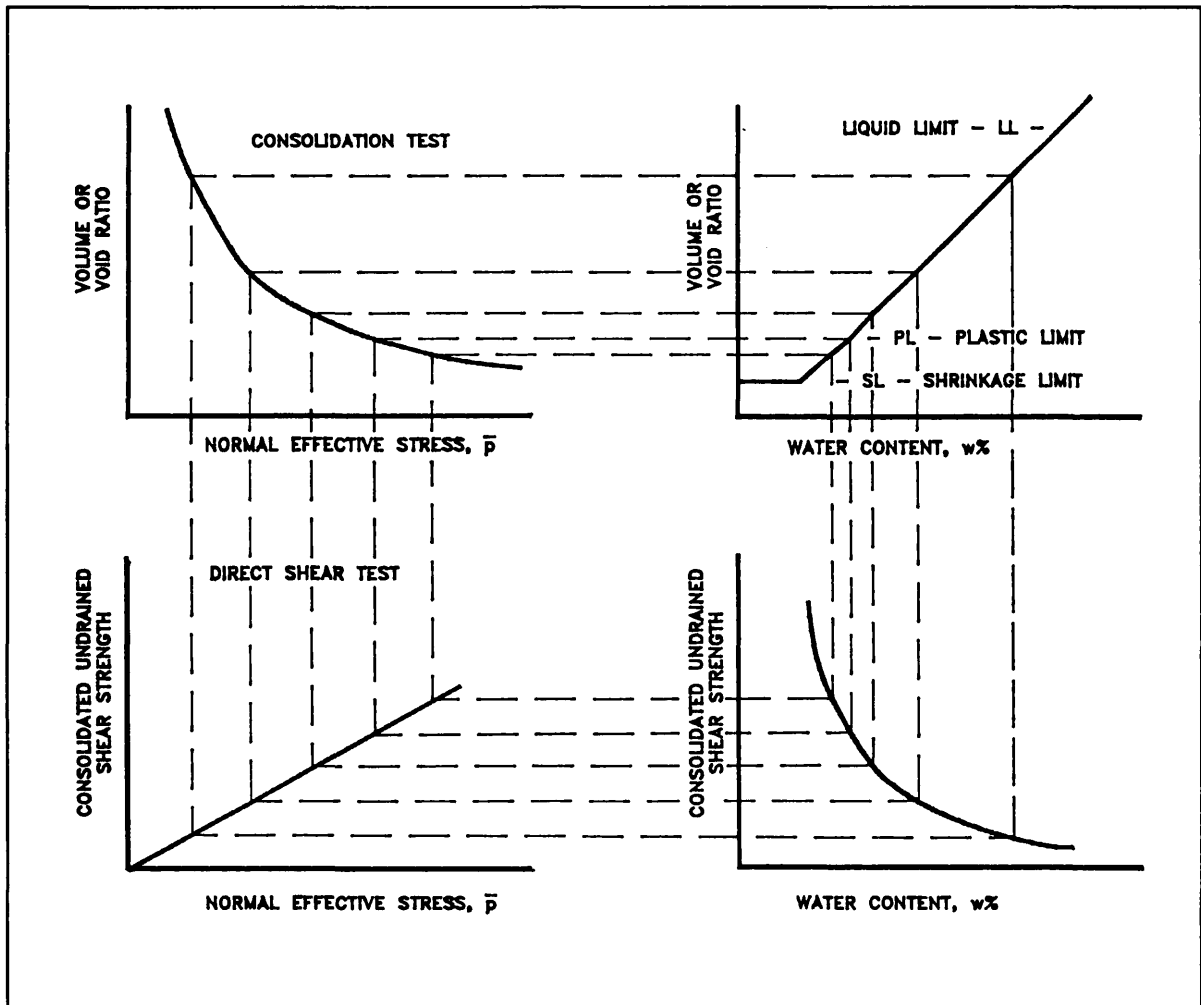

Figure 10. Interrelationship of properties of clay soils

related to effective stress at consolidation equilibrium (lower left, Figure 10). For any sample, this is equivalent to the unconfined compressive strength at that void ratio or density and the diagram indicates the rate of strength gain with increase in density. The shrinkage graph (upper right, Figure 10) shows the relationship of void ratio/volume to water content and the Atterberg limits. Finally, there is a relationship between consolidated-undrained shear strength and water content (lower right, Figure 10).

#### Rheological properties of slurry

76. The shear strength of a soil-water slurry is affected by the rate of shear. The rate of increase of shear resistance with increase in shear rate is called the *viscosity* of the fluid. Therefore, viscosity is a measure of the dynamic (rather than static) shear strength of a soil. If the amount of fine-grained soil (silt and clay) is more than about 35 percent of the total solids, the soil behaves as a viscous fluid. The viscous behavior of a

soil-water mixture affects (a) the determination of nautical bottom (Meyer and Melherbe 1987), and (b) the energy needed to pump the slurry in a pipeline.

77. The relationship between shearing resistance and shearing rate for fluids is illustrated in Figure 11. A true Newtonian fluid is one whose shearing resistance approaches zero as the rate of shear becomes very slow. As the slurry density increases, water molecules and charged clay particles interact, forming weak bonds. The slurry now behaves as a Bingham fluid. A *threshold shear stress*, or yield stress, exists at very low shear rates. The shear stress value increases, as shown in Figure 11, as the rate of shear increases and as the slurry density increases.

78. Figure 12 illustrates the relationship between yield stress and slurry density for various values of mud (silt and clay) content. At any solids concentration, the threshold shear increases with increasing mud content (Meyer and Malherbe 1987). Therefore, all slurries have an initial resistance to flow, and a minimum, or threshold, shear force is needed to

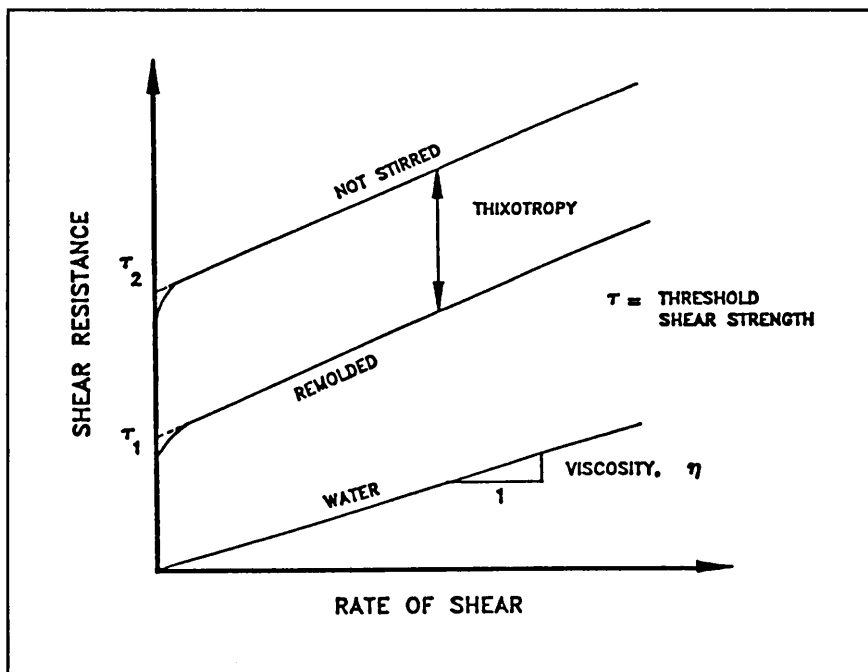

Figure 11. Rheologic behavior of a silt-clay slurry

initiate shear. The amount of shear force needed for higher shear rates increases with viscosity which depends on the shear rate, solids concentration, and mud content.



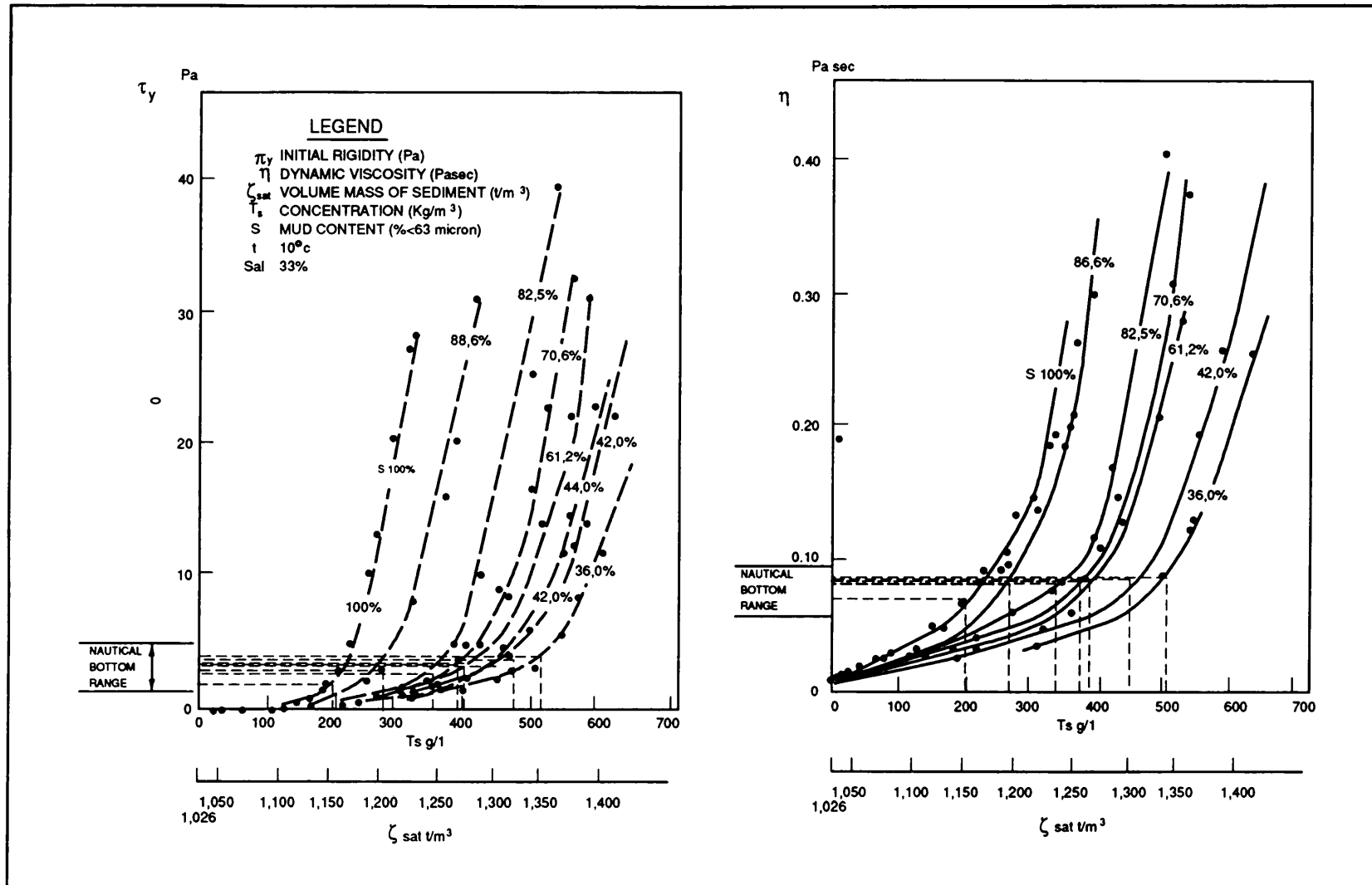

Figure 12. Relationship between yield stress and viscosity and slurry density (Meyer and Mahlherbe 1987)

### PART III: PROCEDURE FOR A GEOTECHNICAL SITE INVESTIGATION

79. Subsurface investigations for dredging projects have requirements that are significantly different from those for the typical foundation engineering project. Geotechnical engineering foundation investigations for structures, off- or on-shore, generally cover small areas, sometimes to great depths. Existing land-based techniques and equipment are best suited to serve the primary purpose of performing exacting geotechnical field soils tests and obtaining high quality samples for laboratory shear strength tests. Dredging projects, on the other hand, do not require the knowledge of soil strength and texture with the precision needed for foundation engineering. They do, however, require inferences about the subbottom geotechnical profile over long distances; average values and ranges of values are generally sufficient.

80. Dredging site investigations are similar in scope to those made for highways, canals, and pipelines in the sense that they involve long, narrow lengths, or large areas, and shallow depths in the soil to be excavated and removed. Maintenance work usually consists of one meter (3 ft) or less of shoaled material to be removed. New work channel deepening projects typically involve 1.5 to 3 m (5 to 10 ft) of excavation. New channel projects may involve greater depths of excavation. As an example of a completely new project, the Theodore Ship Channel in Mobile Bay, Alabama, was excavated partly in the bay and partly on shore to reach a new industrial area (Fowler and Spigolon 1988). The bay-cut channel was 8.3 km (5.2 miles) long, but only 122 m (400 ft) wide and 12.2 m (40 ft) deep below mean low water (MLW), with an average water depth of 3 m (10 ft). Therefore, the depth of sediment to be excavated underwater was about 9.2 m (30 ft). The land-cut part of the channel was 3.0 km (1.9 miles) long, 91.4 m (300 ft) wide, and about 18 m (60 ft) deep.

#### Procedure for a Geotechnical Site Investigation

81. A geotechnical site investigation for a dredging project must answer several questions:

- a. How many soil and rock deposits are there within the proposed dredging prism? Where are they located and what is their configuration?

- b. What kind of material does each deposit consist of? Which geotechnical properties will characterize each soil deposit? What are the average values and the range in values of each characteristic property?
- c. Are the deposits homogeneous, heterogeneous, or do the properties trend in a known, or predictable, manner?

82. The procedure for a typical geotechnical site investigation for a dredging project contains the following steps, as shown in Figure 13:

- a. A review is made of all available prior (existing) information--the geologic literature, both published and unpublished, records of previous geotechnical studies in the project area, and personal experiences with soils in the project area. This is sometimes called a desk study.
- b. Based on the prior information, an initial hypothesis of the geotechnical subbottom profile is developed, including the types, configuration, and geotechnical character of the subbottom soils present.
- c. If the available information is sufficient (see Part VII of this report for a discussion of sufficiency) for the project, the site investigation is terminated at this point. If it is not sufficient, then an estimate is made of site variability. If the site is known, from extensive prior information, to be fairly uniform or to vary in a known manner, a site exploration plan is developed (step f. below). If the site variability is not well known, then a geophysical survey may be appropriate.
- d. Where appropriate, continuous subbottom information is obtained by geophysical studies using acoustic subbottom profiling or other suitable method. The requirements for ground truth sampling and testing for correlation with the data are established.
- e. The geophysical data are used to amend the initial hypothesis of the soil profile. If the updated geotechnical information is now sufficient for the project, the site investigation is terminated.
- f. If the amended subsurface profile estimate is still not sufficient, then a geotechnical physical site exploration plan is formulated. The number and location of the test sites will be dictated by site variability (see Part VII of this report).
- g. At each exploration site, specific depths and specific methods are selected for sampling and testing the subbottom materials. Sampling depth may be reached by drilling or the digging of pits. Geotechnical field tests are made and samples are obtained for laboratory tests. Identification tests are made on the soil samples in the field and later confirmed in the laboratory or office. A description, and perhaps a classification, is made for each sample.

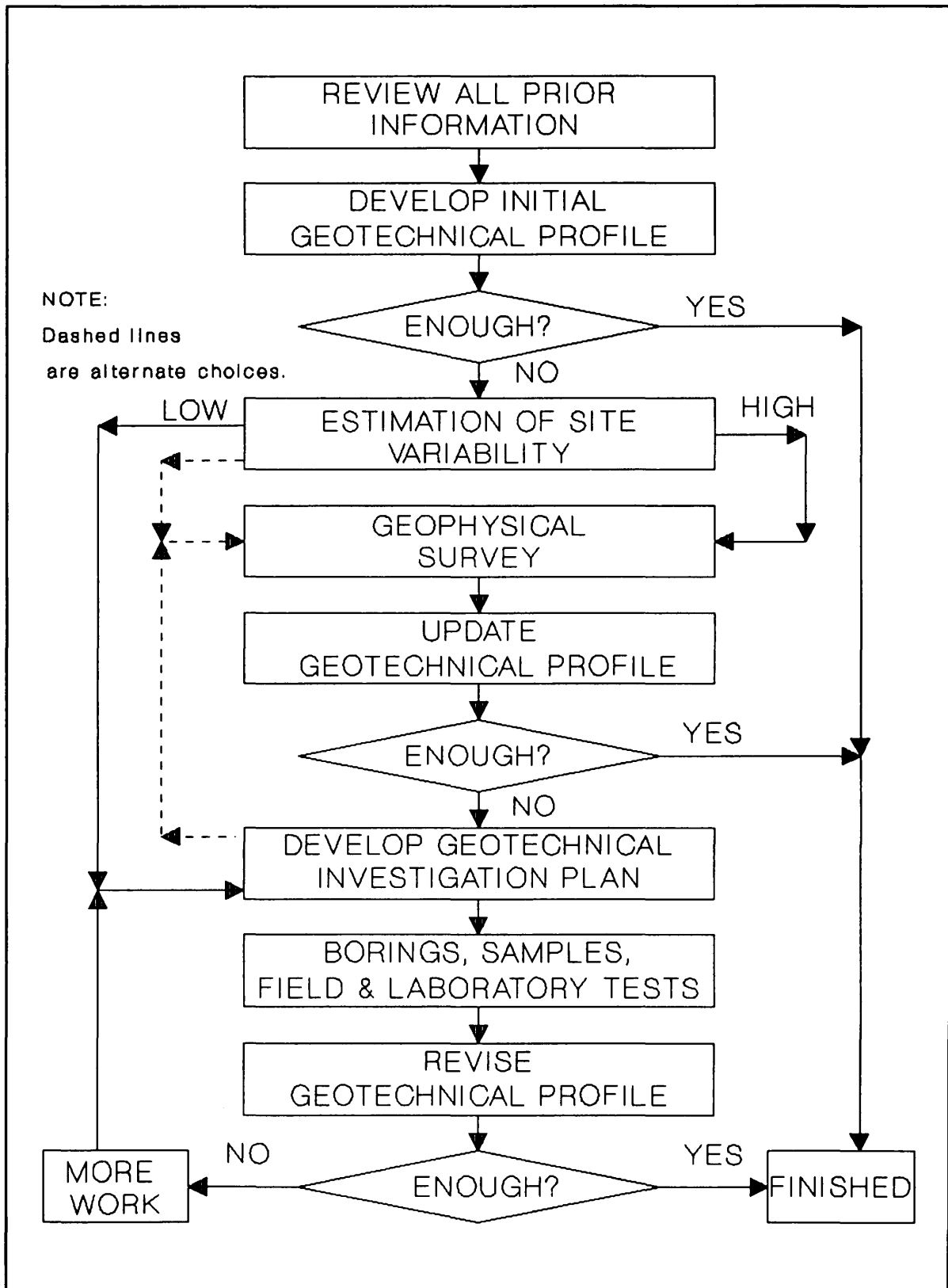

Figure 13. Procedure for a geotechnical site investigation.

- h. The new geotechnical information is summarized and added to the existing information. The previous subsurface profile estimate is reviewed for consistency with the new data and the estimated subbottom profile is revised as needed.
- i. If the revised subbottom profile estimate is now sufficient for the project, the site investigation is terminated. However, if more information is required, then additional geophysical and/or geotechnical sampling and testing are done. This iteration is continued until a point of sufficiency is reached (see Part VII of this report).

83. Several indirect methods for obtaining geotechnical information about a proposed dredging site are discussed below. These include a study of the existing sources of information and the methods for making geophysical surveys underwater. Methods for obtaining physical samples and for making in-situ and laboratory soil tests for the geotechnical properties defined in Part II are discussed in Parts IV, V, and VI of this report.

#### Sources of Prior (Pre-existing) Information

84. As discussed above, and shown on Figure 13, geotechnical site investigations start with an estimate of the soil profile based on the existing and available prior information from the geologic literature, former project records, general sources, and possibly remote imagery. An excellent summary of sources of geologic engineering data is given by Trautmann and Kulhawy (1983); this discussion is derived mainly from that source.

#### Geologic Data Sources

85. Geologic studies include a review of the geologic literature and related records for the project area. Sources of geologic data include:

- a. U. S. Geological Survey (USGS): The USGS continually publishes maps, reports, circulars, open-file reports, professional papers, and bulletins covering most of the United States. The Earth Resources Observation System (EROS) provides access to the NASA LANDSAT satellite (remote) imagery data.
- b. USDA Soil Conservation Service (SCS): SCS maps and publications are primarily intended for agricultural purposes. The reports typically contain discussions of near-surface geology.
- c. State Geological Surveys: All states have a State Geological Survey which publishes maps, reports, and other documents about the geology and mineral resources of that state. The work often is similar in scope to that of the USGS.

### Project Records

86. The documentation for many State and Federal projects contains a description of site investigations, analyses of data, construction drawings, and data references, all of which may be useful in establishing the preliminary soil profile at a dredging project site. The General Design Memorandum (GDM) for each Corps of Engineers project contains a summary of the geologic and geotechnical information available for use in the design of that project.

### Remote Imaging

87. Remote imaging, or sensing, is the process of obtaining information about an object using naturally occurring or man-made electromagnetic radiation. Aerial and/or satellite photography, using either visible or non-visible light waves, and ground probing radar are typical of this method. An instructive series of papers on this topic have been collected and reported by Siegal and Gillespie (1980). A summary of satellite imagery related to dredging is given by Land and Garrard (1986).

88. All materials exhibit an electromagnetic reflection signature and, given sufficient correlation with ground truth tests, can be reasonably identified from remotely acquired images. Light waves cannot penetrate the surface; radar can penetrate to shallow depths if the surface layer is more penetrable than lower layers. Therefore, this methodology is restricted to evaluation of surface deposits. Recently, for example, the presence of a hazardous waste site directly in the path of a proposed new land-cut channel to be dredged was found using remote imaging. This method does not permit any evaluation of underwater soils, although turbidity plumes, temperature changes, and abnormalities in the character of the water can be defined.

### General Sources

89. In addition to the direct sources of geologic data given above, there are several general sources, many of which contain local information not available elsewhere:

- a. Libraries: Libraries at state and private colleges and universities offering geology, geological engineering, and engineering geology programs have extensive holdings of USGS, SCS, and State Geological Survey publications. Geology-based theses and dissertations prepared by students at that school are on file. Bibliographic indexes of geologic publications and Ph.D. dissertations nation-wide are available, often as part of computer search facilities.

- b. Local and Regional Agencies: Local and regional planning boards will sometimes authorize geologic studies as part of an overall plan for an area. Such studies are generally made by private geologic or geotechnical firms; therefore, the information thus obtained sometimes contains data and analyses not available from government agency publications.
- c. Knowledgeable Individuals: In the initial stage of a geologic data search, knowledgeable individuals have information on references and a general geologic overview of the project area. People to contact include university professors, reference librarians, geotechnical engineering firms, site exploration firms, local quarry operators, construction aggregate suppliers, and appropriate persons from agencies such as State geological surveys, the USGS, and the U. S. Army Corps of Engineers.

90. All preexisting information is reviewed for the probable stratification and geotechnical character of the materials within the dredging prism. One or more working hypotheses of the geotechnical profile of the dredging prism are produced, as mental images or as physical drawings, with all materials classed in one of the following general categories:

- a. Fluid Mud
- b. Highly Organic Soils
- c. Cohesive Soil
- d. Friable Mixed Grain Soil
- e. Cohesionless (Clean Granular) Soil
- f. Boulders and Cobbles
- g. Shale and Cemented Soil
- h. Rock and Coral

The general characteristics of each of the primary material categories are shown in Table 4.

#### Geophysical Methods

91. Using direct contact with the soil deposit at various points, a large mass of soil can be investigated using electrical, acoustical, or seismic waves transmitted through the mass. Electrical resistivity and seismic surveys have been used in highway soil profile studies for many years. Geophysical methods are indirect and non-intrusive and are generally characterized by large scale measurements that produce an "averaging" of the soil properties over the zone of test influence, but without the capability of obtaining or testing a specific sample. A good overview of geophysical

methodology is given in Engineer Manual 1110-1-1802, "Geophysical Exploration," (HQUSACE 1979).

Table 4  
Characteristics of Basic Sediment Types

Fluid Mud	Fluid mud is a mixture of water and mud (clay and silt) existing at the surface of the bottom and exhibiting the physical properties of a fluid. A fluid, by definition, will flow to assume the shape of its container. Therefore, a fluid mud is characterized by: (1) location - at the surface of the bottom; in high turbidity area; (2) shear strength - sufficiently low to behave as a fluid, i.e., to flow and assume shape of container; has no unconfined compressive strength; (3) composition - solids are predominantly silt and clay; (4) density - very low (void ratio/porosity and water content very high); and (5) liquidity index - very high, water content above liquid limit.
Highly Organic Soils	Peat, humus, and swamp soils are typical. Typically have a spongy consistency, a high water content, and are dark brown to black color, although the color alone is not an indicator. Usually have an organic odor in a fresh sample or in wet sample that has been heated. Have a fibrous to amorphous texture; may contain vegetable matter (sticks, leaves, etc.).
Cohesive Soil	These are massive fine-grained soils, typically soft to hard clays and silty clays of medium to high plasticity. Not friable. Have sufficient density and clay content to have unconfined compressive strength. Exhibit plasticity, cohesiveness, and dry strength. Little or no grain-grain contact; shear strength derives from density, stress history, and amount and type of clay.
Friable Mixed-Grain Soil	Material is mixed-grain soils or low plasticity friable soils, such as small gravel, sand, silt with appreciable clay content. The presence of as little as 20 to 40% passing the No. 200 screen is sufficient for a granular soil to behave as a cohesive soil. Strength derives from combination of grain-to-grain friction and cohesion due to clay. Friable due to low plasticity of -No. 40 fraction.
Clean Granular Soil	Material is gravel, sand, or coarse silt with little or no plasticity; will not stand unconfined if dry. Shear strength derives from relative density, grain angularity, and lack of fines. Maximum size is 76 mm (3 in.). Grain to grain contact dominates the engineering behavior. Shear strength derives from relative density, grain angularity, and lack of fines. Will densify with vibration and will not stand unconfined if dry. Exhibit moderate to high friability.

(Continued)



Table 4 (Concluded)

Cobbles & Boulders	Individual grains between 76 mm (3 inches) to 305 mm (12 inches) are cobbles and over 305 mm in diameter are boulders. May be rounded from movement in a stream or may be angular rock fragments, either natural or as the result of ripping or blasting of solid rock. Usually dense and shear strength derives almost entirely from grain to grain contact.
Shale and Cemented Soil	Rock-like soils cemented with iron oxide, lime, silica, or magnesia or highly compressed clays (shale); have compressive strength below that of massive, hard rock; when cut or ripped, usually fragments into small particles.
Rock and Coral	Rock is massive, solid (non-granular), inorganic mineral matter with an unconfined compressive strength exceeding about 1000 kPa (10 TSF). Coral consists of living calcareous organisms usually formed into a massive offshore reef. Hard rock and coral require blasting to break the mass into particles that can be removed by normal dredging equipment. Softer rock and coral capable of being easily cut or ripped into small fragments.

92. The distinguishing character of all geophysical methods is the ability to provide a continuous soil profile, with only a few general soil characteristics indicated, and requiring extensive calibration, usually with ground truth (direct soil sampling and testing) studies of the in-situ project soils. Ground truth tests indicate only the characteristics of the soils in the immediate location of the boring or pit. Extrapolation of these data between borings or pits requires considerable interpretation of all other available data. Stratification that may be inferred from one or a group of borings may not be valid because of discontinuities or inclusions which have been missed. As stated by Jones (1984): "The two techniques, drilling and profiling, are therefore, in many ways, complementary. The strength of one being the weakness of the other and vice versa."

93. Most of the available geophysical systems can be operated from a vessel, many while the vessel is moving. Bray (1979) reported the use of high energy seismic sources, such as acoustic signals applied just below the water surface by a source towed from a moving ship, to permit seismic profiling where distinct strata changes occur. Jones (1984) reported the use of acoustic impedance to identify seabed soils for such characteristics as density, grain size, and porosity.

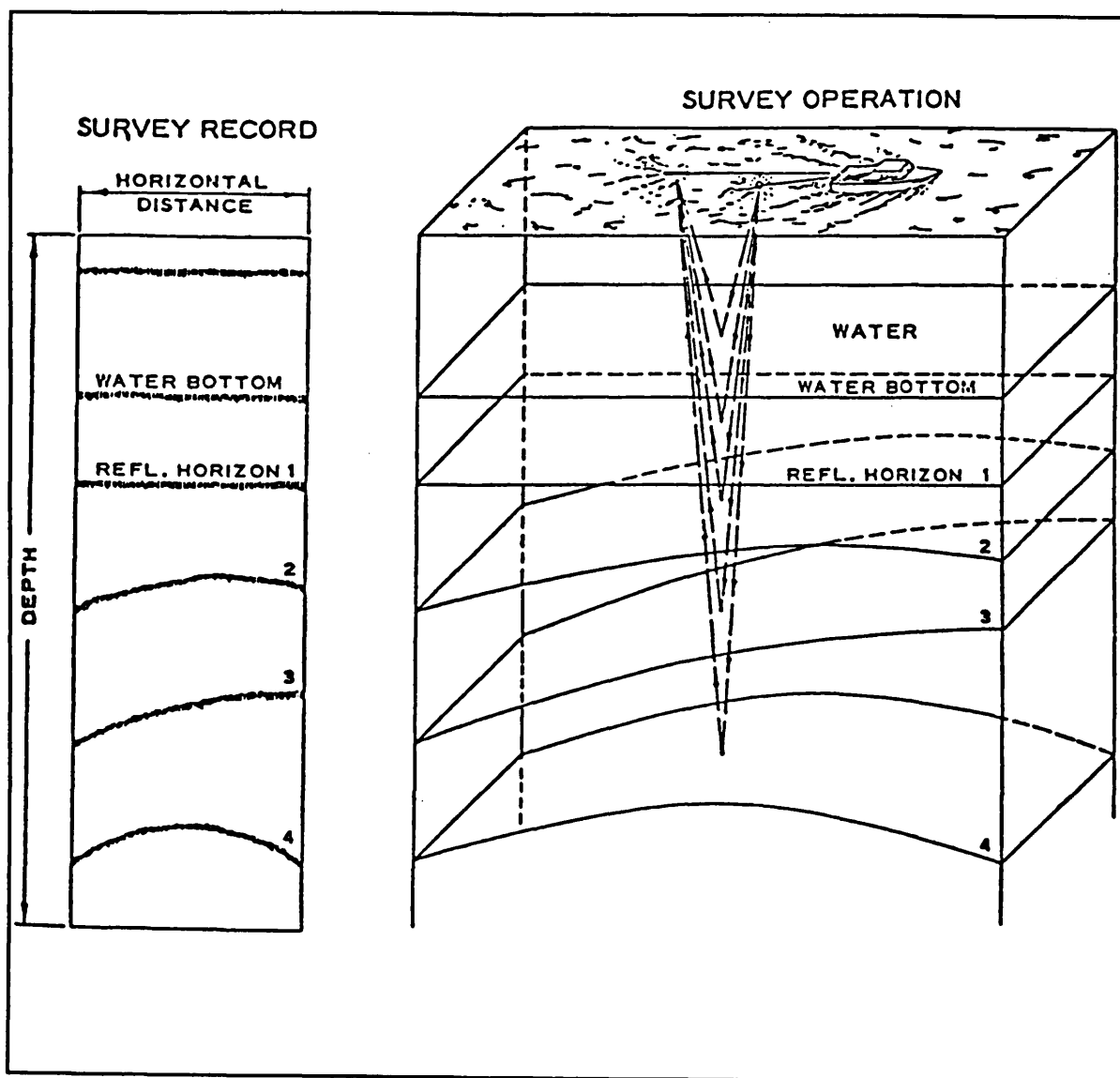

Figure 14. Geophysical acoustic sounding.

94. A research study titled: "Rapid Measurement of Properties of Consolidated Sediments" is presently (1990) being conducted as part of the Dredging Research Program at WES. A complete report of the findings and recommendations of the study will be published by WES; only highlights are given here. The research program employs acoustic reflection profiling with a seismic-acoustic device which is basically an echo-sounder. As shown in Figure 14, high frequency energy is pulsed or chirped from a transducer on a vessel. This method measures travel times of compressional waves through the water and subbottom materials and the amplitude of the reflected signal. Each

different material layer encountered will absorb and reflect energy as a function of its basic properties such as density, porosity, and grain size. The amount of energy absorbed is also a function of the frequency; therefore, signals are sent at several frequencies. In the proposed DRP system, several transducers emit signals of different frequencies, the return signals are picked up at a receiver, and the data are analyzed in an on-board computer using proprietary software. The proposed signal analysis system is expected to be capable of: (a) determining depth of water; (b) estimating the depth, thickness, and density of a fluid mud layer; (c) estimating the physical properties of bottom and subbottom soil sediments; (d) determining top of rock; and (e) providing a continuous two-dimensional subbottom profile of the survey area.

## PART IV: METHODS FOR SAMPLING UNDERWATER SOILS

95. Of the various techniques available for evaluating the properties of in-situ soils at a proposed dredging site, by far the most instructive, and perhaps most costly, is test dredging at the site with the proposed dredging equipment. Generally, however, it is much less costly (and less direct) to perform geotechnical tests on samples of the soils, either in the laboratory or in the field. Sampling and/or field testing of soils from the interior of the soil mass involves penetration or excavation of the soil to the sample or test depth. Such excavations are typically made by probing, pits, trenches, or borings. Because the sampling will be done underwater, an above-water working platform for personnel and equipment must be provided.

96. There are a number of methods available each of the processes involved in securing samples. Discussions are presented below for:

- a. Securing underwater samples of dredging project soils for geotechnical tests;
- b. Accessing (reaching) sampling/testing depth; and
- c. Providing a working platform for sampling/testing.

Each method has its own specific purpose, advantages, limitations, cost, and value. Methods for performing the geotechnical in-situ and laboratory soil tests for the geotechnical properties defined in Part II are discussed in Parts V and VI of this report.

### Methods for Underwater Soil Sampling

97. The sampling of soils for engineering investigations has been discussed in the geotechnical engineering textbooks and literature for over 50 years; reference to all of the significant literature is beyond the scope of this report. Among the more complete summaries are Hvorslev (1949) and Engineer Manual 1110-2-1907, "Soil Sampling" (HQUSACE 1990). Devices for underwater sampling in sandy, rocky, or cohesive formations take the form of (Rosfelder 1967; Noornay 1972; HQUSACE 1987, 1990):

- a. Undisturbed Sediment Samplers
  - (1) Thin wall tube samplers (for clays of soft to stiff consistency only); and
  - (2) Diamond core barrel samplers (for rock and hard sediments only).

b. Disturbed, Representative Soil Samplers:

- (1) SPT split tube samplers.
- (2) Thick-wall, split tube samplers.
- (3) Gravity projectile tube samplers.
- (4) Vibrating tube samplers.
- (5) Bucket auger samplers.
- (6) Surface grab samplers.
- (7) Liquid slurry samplers (for fluid mud only).

98. There are three terms regarding soil sampling that deserve strict definition: in-situ, undisturbed sample, and representative sample. *In-situ* derives from "at the site" and is generally used to indicate the condition of a soil as it exists at its naturally placed location, before intervention by man or machine. A truly *undisturbed sample* is one that maintains all of the in-situ soil mass characteristics including shape, volume, pore structure and size, grain orientation and structure, and the in-situ horizontal and vertical pressures. In reality, a so-called undisturbed sample cannot completely retain all of these attributes; however, except for the in-situ pressures, an attempt is made to maintain as much as possible of the other characteristics. An intact, or *representative sample*, on the other hand, may be remolded slightly or completely; i.e., it contains all of the soil material, both solids and fluids, of its in-situ state but does not maintain the structure, grain orientation, or in-situ density. Such samples are appropriate for soil material properties tests, but not for soil mass properties tests.

99. Many of the sediments being sampled are loose or soft. Two major problems with all types of underwater samplers are: (1) the expulsion of any water existing inside the sampler as the soil sample enters the device, and (2) the retention of the sample during withdrawal from the in-situ sediment. A well designed device will consider both problems. Water expulsion usually requires large exit ports. One solution is the use of an interior piston which is held in place until the soil surface is reached. Water is kept out of the interior of the device and air must be expelled instead. The sampling tube is inserted into the soil while the piston remains fixed at the top of the sample. The resulting suction keeps the sample from sliding out the tube during withdrawal. Another device, used with disturbed sample devices, is a "core catcher", a set of flexible metal fins near the mouth of the sampler

that permit a sample to enter the tube and then flex inward, keeping the sample from sliding back out.

### Thin-wall Tube Samplers

100. Laboratory strength tests of clays are heavily dependent on undisturbed sampling. The requirements for an undisturbed soil sampler for geotechnical evaluations are given in the classic paper by Hvorslev (1949). Hvorslev graphically showed the effects of sample disturbance and validated the need for thin-wall tubing, with a small area ratio, well-designed inside and outside clearance ratios, and a friction-free interior. A schematic of a thin-wall tube sampler is shown in Figure 15.

101. Undisturbed tube sampling requires careful technique. Sampling must be done from a stable platform; the tube must be inserted with a slow steady push (without impact or vibration); and it requires considerable time and effort for sealing the sample tubes, careful transport to the laboratory, care in sample extrusion and handling, and careful testing. A poorly sealed tube will allow drying of the sample in transit and in storage; drying changes the void ratio and hence increases the strength of a cohesive soil sample. Vibration or shock during transport can totally destroy the structure of

loose silt samples. Marcuson and Franklin (1979) and others have discussed the near-impossibility of undisturbed tube sampling of sands; the thickness of

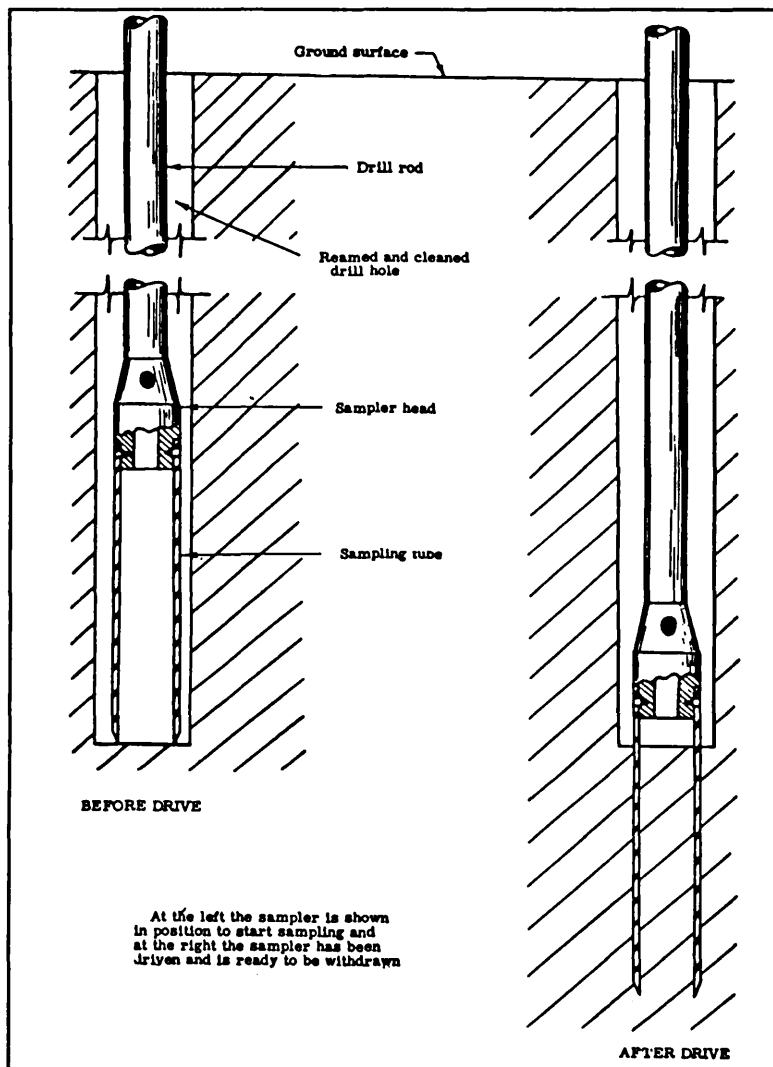

Figure 15. Schematic of thin wall tube sampler

the sampler walls, and the pushing or vibrating force, tend to cause volume changes in the granular soils, disturbing their in-situ structure. Only freezing with subsequent diamond coring appears to be successful (Marcuson and Franklin 1979; Adachi 1989).

#### Diamond Core Barrel Sampler

102. Extremely hard soils, such as shale and cemented soils, and rock are too hard for sampling by the direct insertion of a metal tube. Therefore, an undisturbed core is obtained by fitting the circular end of the sampling tube with a hardened steel cutting surface, or bit. For cutting rock, industrial diamonds are imbedded in the cutting edge of the bit. Hydraulic pressure and rotation cause abrasion of the rocky material from the annular space between the core and the wall of the drill hole. Water, or drilling fluid, is circulated down the drill stem, between the core and the inner face of the *single tube core barrel*, and then back up the hole to cool the bit and to return the cuttings to the surface. The core is retained in the core barrel and retrieved. This device is not often used commercially.

103. When the rock is erodible, because of softness due to decomposition or of interlaminated soil materials, a *double tube core barrel* must be used. In this system, two concentric tubes are used. The inner core barrel does not rotate; the drilling fluid flows between the inner and the outer, diamond tipped, barrel. The inner barrel protects the rock core from the eroding water. This is the most commonly used rock sampling device. For highly fractured rock, a *triple tube core barrel* is used. A third, concentric, inner, longitudinally split tube is used to facilitate removal of the sample from the tube.

104. Soft rock, cemented soils, shale, and hard clays can be drilled with a hardened steel serrated bit instead of diamonds in the tip of the core barrel. The *Denison sampler* is similar to a double tube core barrel except that the inner, nonrotating tube projects beyond the outer, rotating tube. The amount of projection can be adjusted for the type of material being sampled. A similar device is the *Pitcher sampler* which differs from the Denison sampler only in that the inner tube is spring controlled.

#### SPT and Other Thick Wall, Split Tube Samplers

105. Impact, or percussion, is used to drive a thick wall, split tube sampler. The samplers commonly used, and commercially available, have the sizes shown in Table 5. The best known of these devices is the split tube

Table 5 Thick Wall, Split Tube Samplers				
Outside Diameter	5.1 cm (2.0 in.)	6.4 cm (2.5 in.)	7.6 cm (3.0 in.)	8.9 cm (3.5 in.)
Inside Diameter	3.8 cm (1.5 in.)	5.1 cm (2.0 in.)	6.4 cm (2.5 in.)	7.6 cm (3.0 in.)
Drive Shoe	All samplers are typically fitted with a hardened steel drive shoe having the same OD as the sampler, but with an inside diameter 0.32 cm (0.125 in.) smaller than the sampler ID. This permits the use of a thin metal sample liner inside the sampling barrel, if desired.			
Length	All samplers normally are 61 cm (24 in.) long, but longer versions are available.			

(split barrel) sampler used in the Standard Penetration Test (Terzaghi and Peck 1967; ASTM 1992), which is 5.1 cm (2.0 in.) OD device of Table 5 and shown in Figure 16. These devices are capable of penetrating and retaining a wide variety of soil types and consistencies, and are usually deployed in a small diameter drilled hole. The maximum size of particle that can be retained is slightly smaller than the inside diameter of the drive shoe. The resistance to penetration has been used to indicate strength or consistency. Although extremely useful as a sampling device, this type of sampler requires a stable drive platform, a heavy drop weight, and somewhat longer time to operate than other sampler types. However, there is no requirement for a heavy (or any) weight as a reaction against penetration forces.

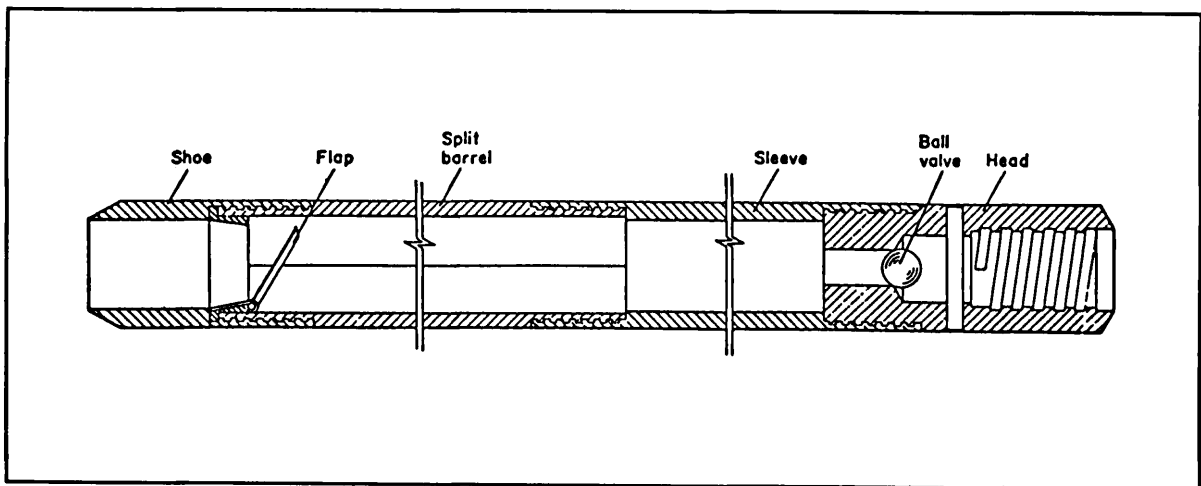

Figure 16. Split tube sampler used in the Standard Penetration Test.



### Gravity Projectile Tube Samplers

106. Various types of tube samplers are available that are intended to penetrate the surface of an underwater soil deposit using their dynamic force as a projectile (Hvorslev 1949; Rosfelder 1967). Gravity projectile corers use a heavy weight attached to the tube to provide the penetration force, as shown in Figure 17. Other corers use an explosive (gunpowder) to drive the tube after the penetrometer is in place on the bottom. The length of the core can reach 3 m (10 ft) or more in length and is dependent on the projectile force and the resistances of the soil strata encountered. Disturbance of the soil is a function of the area ratio (thick vs thin wall), the type of soil, its strength, side friction in the sample tube, and the ease with which water in the tube can be ejected in front of the entering sample. Pistons are particularly desirable in this type device. Projectile samplers are remotely operated and do not require a stable platform; they may be advantageously operated from floating platforms, boats or barges, of modest size.

### Vibrating Tube Samplers

107. High frequency vibration of the sampler during pushing is another means of inserting a sample tube into a soil deposit. There are several manufacturers of vibro-corer devices world-wide. As a typical example of vibrating tube coring devices, one proprietary device uses high frequency (7000 to 12000 vibrations per minute) and low amplitude vibrations applied to the drill string to shear the soils in the immediate vicinity of the cutting edge of the core barrel. This permits the device to enter unconsolidated granular and cohesive deposits at rates up to 1.5 m (5 ft) per minute. The specific proprietary equipment being described is lightweight, having a 39 kg (85 lb) engine, an 11 kg (25 lb)

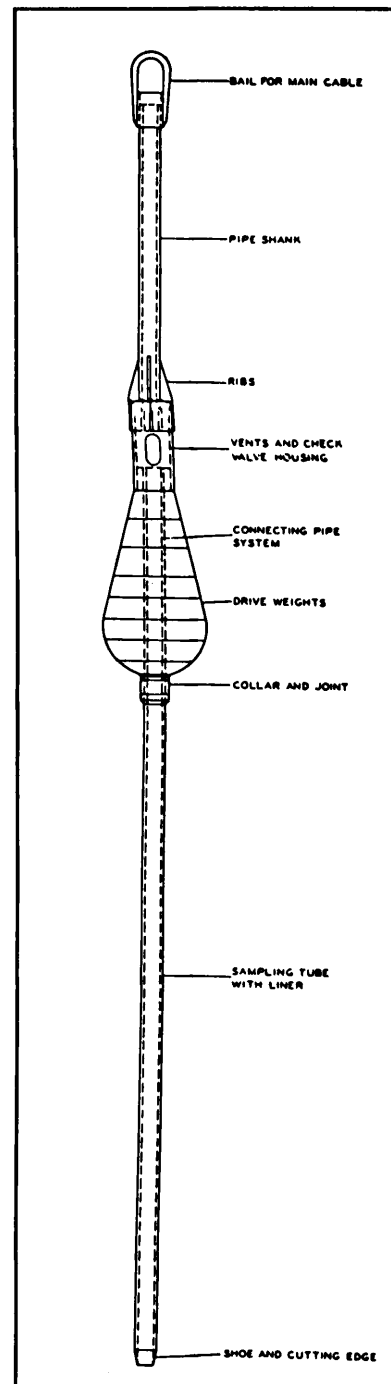

Figure 17. Gravity projectile sampler

drive head, and lightweight tubes of 85 mm and 135 mm (3.35 and 5.31 inches) diameter, and is portable and operable by a two person crew from a floating or fixed platform.

108. Miles (1986) reported efforts in Europe to increase the capability of vibrating tube corers by (a) providing periodic impact to the vertical vibrations for improved penetration of hard cohesive soils and (b) by adding jetting capability for penetration of dense granular soils. These devices impart a sample disturbance to the soil whose magnitude depends on the effect of the vibration, the side friction in the tube, and the vertical stability of the tube during penetration. It would appear logical that the rate of penetration of a vibrating tube sampler be related to the compactness of the soil. Babcock and Miller (1972) reported good results in field test to relate rate of vibro-corer penetration to the Standard Penetration Test N-values for sand.

#### Bucket Auger Samplers

109. A bucket auger consists of a fairly short metal tube, open at the top and connected to a drill rod. The partially closed bottom is provided with an open cutting edge for drilling and for retaining the excavated, highly disturbed sediment sample. Various cutting edges are available for drilling in different types of sediments (HQUSACE, 1972). Bucket sizes can vary from 2-3 inches to over 24 inches in diameter. The diameter of the bucket must be smaller than the inside of the casing. A small diameter bucket auger may be operated by hand; larger diameter buckets require machine rotation and handling in and out of bore hole.

110. Bucket auger sampling is applicable to all soil types except for those containing very coarse gravels, cobbles, or boulders. Sediments must be capable of being easily cut with the cutting edge of the bucket. They are suitable for soft rock. The bucket is used to both advance the hole and obtain a soil sample. Representative samples of the entire vertical reach of the boring are possible. The bucket is removed from the drill hole each time it is filled or if a sample is required. If the cased hole is kept free of outside water, the samples are representative. Care must be taken to provide for sample retention, especially in cohesionless or very soft cohesive soils (Hvorslev, 1949).

### Surface Grab Samplers

111. Various designs of grabs, scoops, and buckets, and push tubes have been successfully used for offshore recovery of representative samples of granular materials from the surface of the bottom, as shown in Figure 18. The samples are invariably disturbed so that little semblance of the original structure remains. All are designed to bite, or be pushed, into the sediment and enclose a representative sample; therefore, the design must ensure that once the sample is in the device there can be no loss of soil or dilution during the recovery from the bottom. This type of sampling device can be positioned accurately on the bottom. Sampling is limited to those surface soils that can be easily cut by the grab or scoop or are easily penetrated by a push tube. Push tubes can be operated from the surface, penetrating the soil by self weight (Hvorslev 1949) or by being pushed manually.

### Liquid Slurry Samplers

112. The undisturbed sampling of a fluid mud is virtually impossible because the material has an extremely low shear strength and therefore behaves as a fluid; i.e., it will alter its shape to assume the shape of its container. Representative sampling of fluid mud is possible. A tube sampler is used that has a side opening and closed end. In use, the empty sampler is inserted into the slurry, or fluid mud, to the desired depth. The side-acting door is opened and the fluid mud enters the chamber. If properly designed and used, the resulting sample in the chamber will have the same density and solids composition at any depth as occurred in situ. After sampling, the side door is closed tightly and the sample returned to the surface. Samplers of this type have been developed for sampling sludges and slurries in industries other than geotechnical engineering. The technical equipment catalogs of those industries should be consulted for suitable samplers.

### Methods for Accessing Sampling and Testing Depth

113. Samples that are to be secured from, and field tests made at, depths below the existing bottom (other than surface grab samples) require removal of sediment to access, or reach, the sampling location. This is generally done by a test pit or trench, for shallow depths, or a bore hole for any depth. Underwater test pit and boring techniques are generally similar to

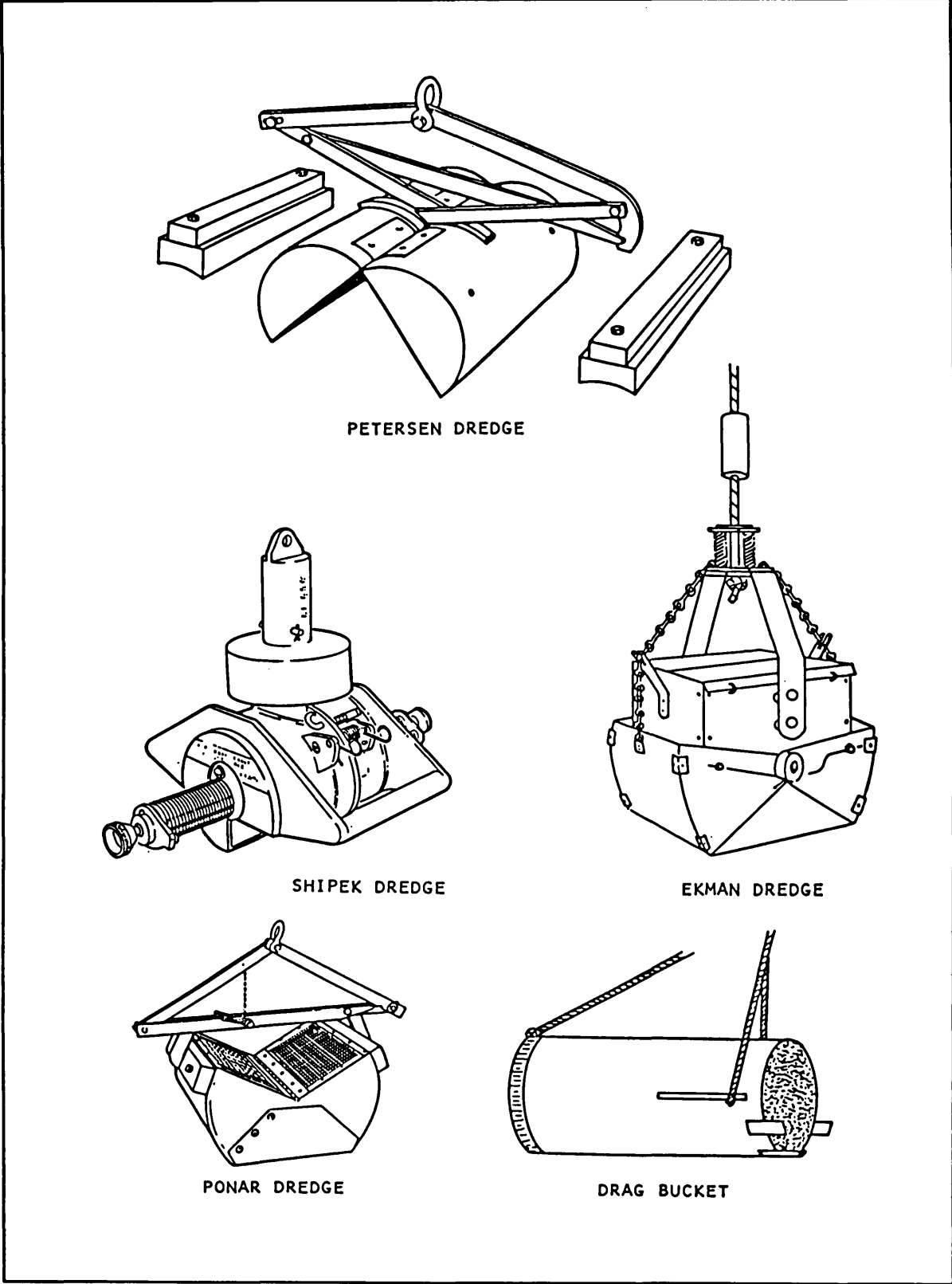

Figure 18. Various designs of surface soil samplers

those used for on-shore geotechnical investigations. Methods used for accessing underwater subbottom locations for sampling soils are:

- a. Test Pits and Trenches
- b. Cased Borings
  - (1) Cased wash boring
  - (2) Cased rotary drilling
  - (3) Cased bucket auger
  - (4) Cased continuous flight auger
- c. Self-Cased Borings
  - (1) Hollow stem auger
- d. Self-Boring Devices
  - (1) Vibrating tube sampler
  - (2) Gravity projectile tube sampler

#### Test Pits and Trenches

114. Test pits and trenches are usually made with mechanical cutting and removal equipment such as clamshell (grab), dragline, or backhoe machines. The process of excavating a pit or trench may, in itself, constitute a form of test dredging. The pit is dug to the sampling or testing depth. Sampling or testing are then done at the surface of the pit using a surface-operated system, by a bottom-supported remotely-operated device, or by a diver. The excavated material is usually a representative sample if care is taken in the excavation/sampling process.

115. Some sediments, such as coarse gravel, cobbles, boulders, shells, and debris, cannot be sampled effectively using the usual boring and sampling methods of geotechnical engineering. A test pit or trench is then the only way of obtaining a representative sample of the sediment. In these instances, in-situ strength is usually not a factor, and a disturbed, but representative sample is very useful for describing the character of the sediment.

#### Soil Boring Methods

116. The objective of boring is to excavate and clean out a small diameter hole to the specified depth to permit sampling, either representative or undisturbed, or field testing of the materials at the bottom of the hole. Underwater boring techniques are generally similar to those used for onshore geotechnical investigations (Sargent 1968, 1973; HQUSACE 1984). Two methods are in common use for advancing a bore hole in soils: hydraulic and mechanical. The hydraulic methods use a water jet, a chopping bit, or a

rotating bit to excavate the soil and rely on the continuous flow of water down the center of the drill stem to return the cuttings up the hole to the surface. Because the cuttings are mixed with, and sorted by, the drilling fluid, they are rarely a representative sample.

Mechanical systems use either a drill bucket or a continuous flight auger to excavate and return the excavated soil to the surface. Bucket samples may be representative, but auger samples rarely are because of the sorting action of the movement up the auger flights.

117. All boring methods except the hollow stem auger require a casing pipe extending from above the water surface to at, or below, the bottom. Because a portion of the drill stem goes through water, a casing pipe is used to provide a "hole" between the drill platform and the bottom. The use of a casing eliminates the problems of reentering the hole after sampling, of losing drilling fluids, and of drilling in moving water. Some devices, such as the vibrating tube corer and the gravity projectile permit penetration and sampling concurrently.

118. Cased wash boring. Water is pumped through a hollow drill rod and a lightweight bit is used in a hand-operated chopping, twisting, jetting

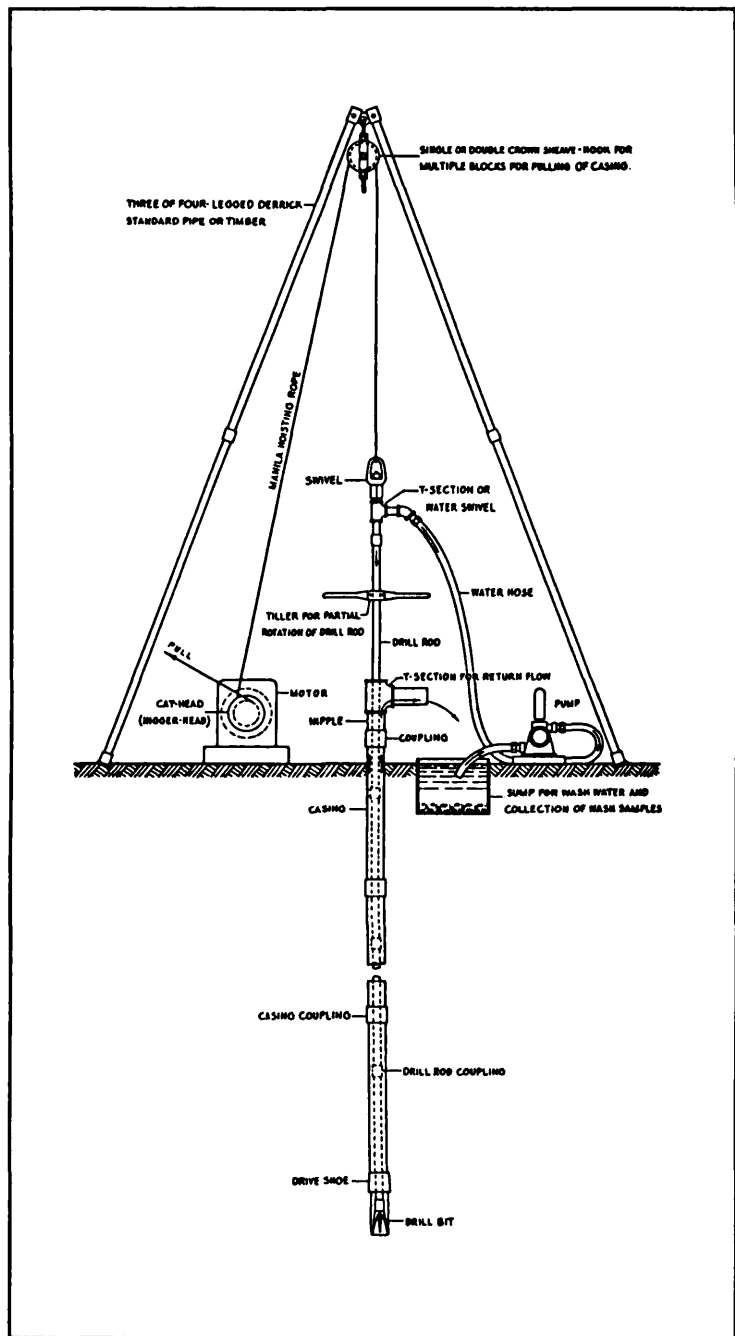

Figure 19. Wash boring system

action to loosen soil at the bottom of the drill hole, as shown in Figure 19. The drilling water returns the cuttings to the surface in the annular space between the rod and the hole wall or casing. Casing is used to prevent hole caving in soft or granular soils. Seawater can be used as the drill fluid. Wash boring may be used for all soil types except those containing very coarse gravels, cobbles, boulders, or strongly cemented soils. Drill units are lightweight and require only a two-man crew, a light tripod, and a water pump. A hand or motor-actuated drive weight for driving the casing below ground surface may be needed if the hole tends to collapse.

119. Cased rotary drilling. This method is similar to wash boring except that it uses a motor-driven rotating drill bit to advance the hole, as shown in Figure 20. Water alone may be used as the drilling fluid if the soil is stable and the depth is small. Thick drilling fluid (drilling mud) is used to stabilize the hole without the use of casing, although casing must be used from the work platform to a point just below the surface of the bottom. Applicable to all soil types except for those containing very coarse gravels, cobbles, or boulders and may also be used for soft rock with suitable drill bits. Equipment needed is heavier than for wash borings, must provide rotation power, and requires a mud pit for recirculating the drilling fluid.

120. Cased bucket auger. A drill rod and sampling bucket with a cutting edge on the bottom may be used to both advance the hole and obtain a soil sample. The bucket is removed from drill hole each time it is filled or if a sample is required. If the cased hole is kept free of outside water, the samples are representative. The diameter of the bucket must be smaller than the inside of the casing. This method is applicable to all soil types except for those containing very coarse gravels, cobbles, or boulders. Soils must be easily cut with the cutting edge of the bucket, i.e., soft or loose soils. A bucket auger may be operated by hand or rotated by machine.

121. Cased continuous flight auger. A continuous flight auger is hand or machine-rotated into the material, as in Figure 21. The auger is withdrawn periodically for removal of cuttings or cuttings return to the surface on the auger flights without withdrawal. Granular soils tend to separate by grain size during the return, leading to non-representation of the sample. The auger must also be withdrawn for sampling or in-situ testing. Applicable to all soil types except for those containing very coarse gravels, cobbles, or boulders. Uncased holes in soft clays and clean granular material below water

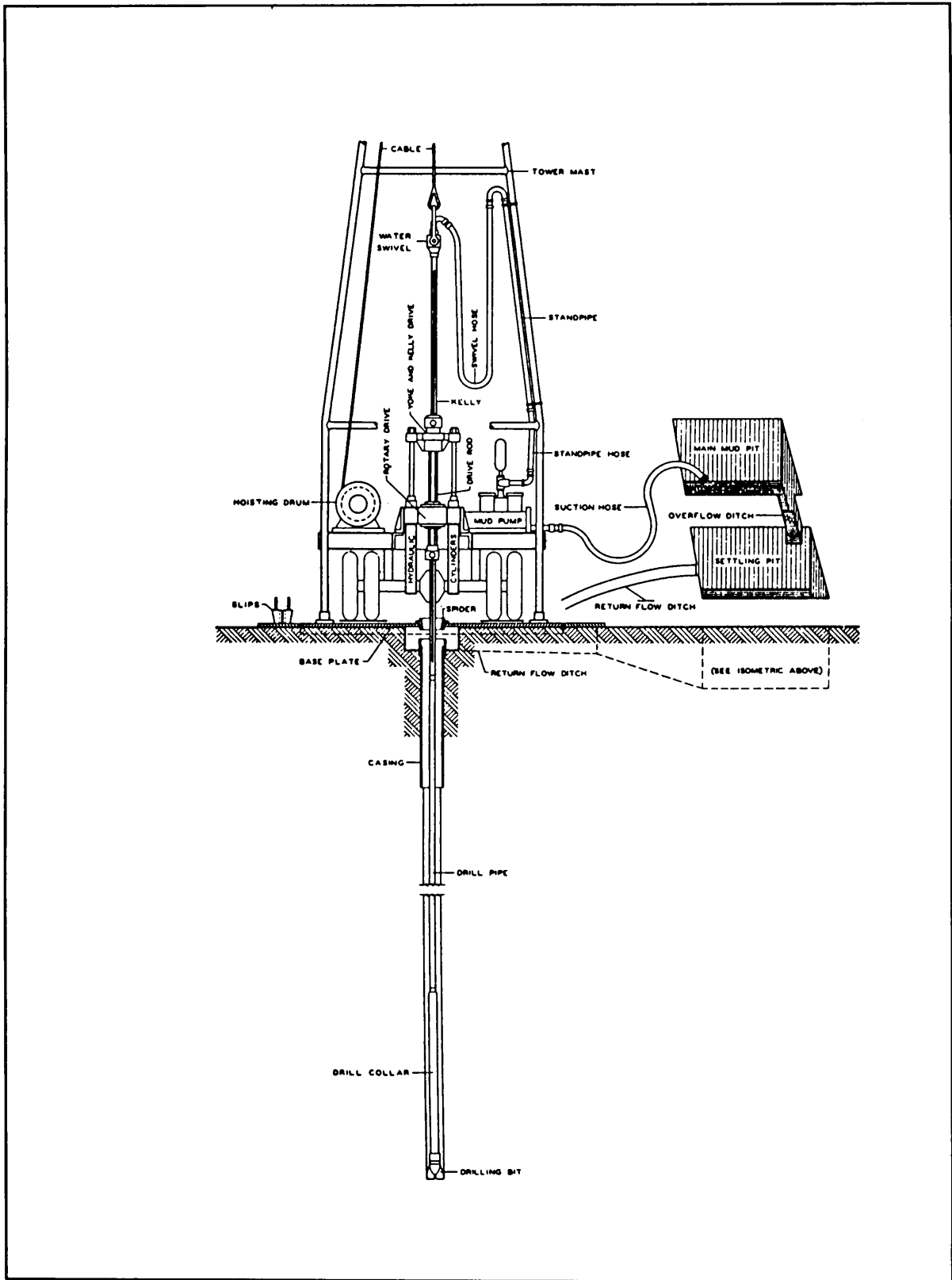

Figure 20. Rotary drilling system



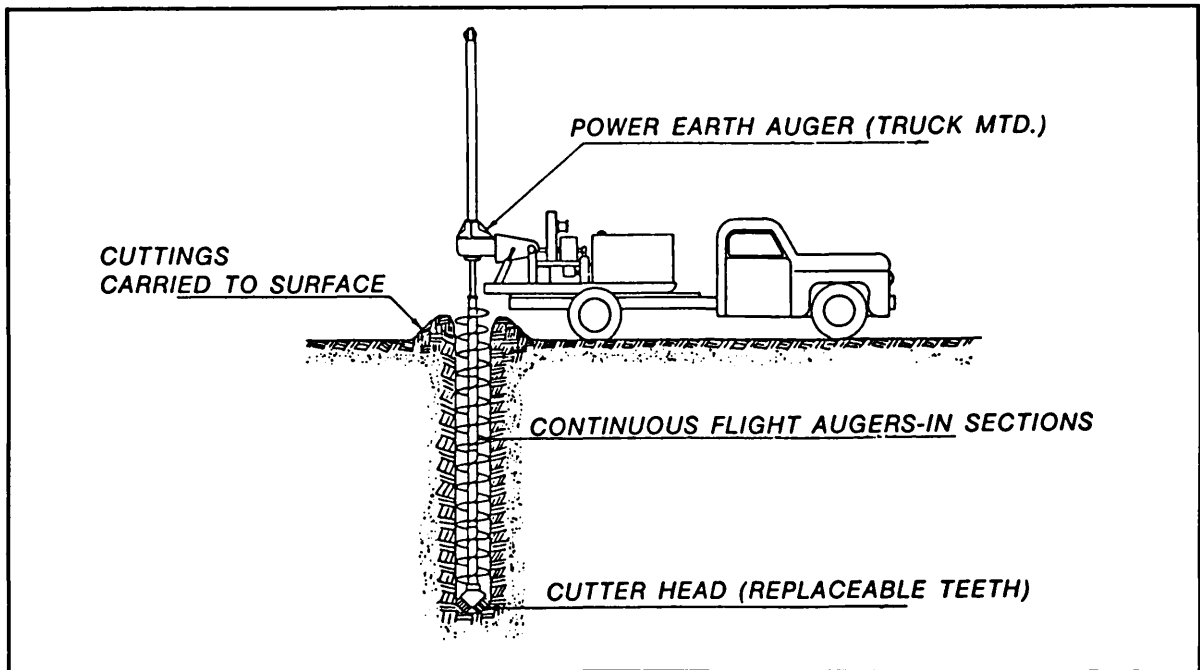

Figure 21. Continuous flight auger drilling system

tend to collapse on withdrawal of auger. Augering is very fast when power driven.

122. Hollow stem auger. A hollow stem auger is a combination system, with a continuous flight auger attached to the outside of a steel casing tube. This permits the simultaneous advancement of the drill hole and the hole-supporting casing. Watertight joints between sections of auger provide a cased "hole" through the water section of the drill stem. Applicable to all soil types except for those containing very coarse gravels, cobbles, or boulders. It is not necessary to remove the auger each time a sample or in-situ test is needed. The outside diameter of the auger flight is 7.6 to 10 cm (3 to 4 in.) larger than the inside diameter of the casing. The larger diameter of the auger requires a larger power source than for a simple flight auger.

#### Self Boring Devices

123. Vibrating tube corer. A thick-walled tube of several metres length is self-inserted, without casing, into a sediment by high frequency vibration. A disturbed sample is taken the length of the tube and the rate of penetration may be used as an estimator of shear strength. All soils except very hard, dense, or cemented soils may be excavated and retrieved. The units

are light enough to be operated by hand, over the side of a small boat, and the electric power unit is also light.

124. Gravity projectile tube sampler. A thick-walled tube of fairly short length is attached below a heavy weight. The unit is dropped vertically into an underwater sediment. On contact with the bottom, penetration is achieved either by the inertia of the heavy weight or by a small explosive charge, usually a rifle cartridge. A disturbed sample is taken the length of the tube and the deceleration rate may be used as an estimator of shear strength. All soils except very hard, dense, or cemented soils, very coarse gravels, cobbles, or boulders may be excavated and retrieved. Units are moderately heavy and must be used with a lightweight hoist for handling and retrieval.

#### Selection Among Drilling Methods

125. Several factors must be considered in the selection of a drilling method. The manpower and machine power needed, the capital investment, the weight of the entire system, the weight required as a force reaction, the time required for drilling to sampling depths, and cycle time for recovering a sampling device must all be weighed. Maintenance and channel deepening projects rarely require more than 1.5 to 3 m. (5 to 10 ft) of drilling per site. When each depth is reached for an undisturbed or representative sample, or a field strength test, it is necessary that the drill hole be cleared of drilling tools before the sampling device can be inserted. This requires that the hydraulic drill bit and rod, or the continuous flight auger, be removed. In the case of the bucket auger, a representative sample is generally obtained but not an undisturbed one. With a hollow stem auger rotation may be stopped at any sampling depth and sampling or testing started without removal of existing devices; however, a hollow stem auger requires larger rotational torque than the other drilling methods. Self-boring sampling methods eliminate the requirements for a boring. However, in the case of self-penetrating strength test methods (see Part V), there is still the need for a physical sample for material properties tests.

#### Powered vs. Hand-Operated Borings

126. Rotary drilling and flight augers, continuous or hollow stem, require considerable rotational force to operate, practically eliminating hand operation. Wash boring and bucket augering operations are amenable to hand operation (without a drill engine) alone, but they tend to be slow because of

the time needed to move drill rod into and out of the bore hole. The use of an engine to manipulate the drill rod greatly reduces the time needed for a boring. Hand operation can be accomplished from a floating platform in calm waters or from a lightweight fixed platform. Lightweight platforms have been used that can be moved by floatation or even by helicopter. The use of a drill engine requires a fixed work platform.

### Working Platforms for Underwater Sampling and Testing

127. The drilling, penetrating, sampling, and in-situ testing of soil sediments underwater requires a stable platform for: (a) attaching the penetrometer or casing, drill stem, and auger from the underwater soil surface to the machinery on the platform, (b) holding personnel, machinery, and equipment, and (c) providing working space. Because of the large number of widely spaced test locations likely to be involved in a site investigation program, the cost in time and money to move the platform is a major expense item, usually far exceeding the cost of the on-site drilling and sampling operations. Four types of platforms are in common use:

- a. Bottom-supported, fixed, moveable platforms;
- b. Floating platforms;
- c. Submersible, bottom-supported, surface-operated machines; and
- d. Diver-operated systems.

#### Bottom-Supported, Fixed, Moveable Platforms

128. Either fixed length or extensible legs (spuds) may be used to support a drilling platform on the bottom. This type of platform permits work above the level of waves and tides. Fixed drill casing may be used and the necessary stability is provided for all types of sampling and in-situ testing equipment. The platform may be nonfloating or floating; the floating platform may be a small barge-type unit or be built on pontoons and have three or four winch operated legs. The floating type may be towed from one site to another after retraction of the support legs from the bottom. Movement may be restricted to clear calm weather because of the instability of the platform with the legs retracted.

129. The U.S. Army Engineer District, Wilmington, NC, developed a unique platform for use in three to ten feet of water with waves five feet

high (Morgan and Robins 1987). A steel platform, 12 by 16 ft (3.7 by 4.9 m) by 20 ft (6.1 m) high was constructed of bolt-together steel members (I-beams, channels, and pipe) weighing about 7,000 lb (3175 kg). The system was proportioned to hold a skid-mounted drill, a moyno-type pump, and assorted drill tools and casing, all capable of being lifted by a U. S. Army Chinook CH-47C twin-rotor helicopter, with a lift capacity of 16,000 lb (7260 kg). Sampling and testing operations included undisturbed soil sampling, standard penetration testing, vane shear testing, vibro-corer sampling, and shallow seismic reflection profiling.

#### Floating Platforms

130. Floating site investigation platforms are either self-propelled, ships or small boats, or towed barges or pontoons. Self-propelled units have a higher capital cost and crew demands than unpowered barges and, therefore, a higher indirect cost while the unit is stationary. Self-propelled platforms have the advantage of being self-contained and mobile. Selection between these platform types is dependent greatly on the relative cost for the powered unit versus the cost of providing transport power, a tow boat, when needed for the unpowered unit. Fixed times at a test site may be part of a day to several days, depending on depth of penetration and types of samples or tests to be made. All floating platforms are affected by the wind, waves, and tides, making attachment to a fixed drill casing system nearly impossible. The tide and wave action is accounted for by anchoring, the use of spud bars, and special onboard heave compensators (Bray 1979; Richards and Zuidberg 1986). Floating platforms are ideal for use with vibrating tube samplers, bottom-supported devices, or diver-operated sampling devices because the connections to the platform are flexible (Land 1982; Johnson 1988).

#### Submersible, Bottom-Supported, Surface-Operated Machines

131. Submersible tethered systems, either fixed or moveable, have been developed (Marr 1981; Ruitter 1981; Johnson and Beard 1985; Hoeg 1986; Richards and Zuidberg 1986; and others) which rest on the bottom and can be operated from a surface vessel using flexible connections. The devices may permit drilling, sampling, and/or field soil testing. Noornay (1972), Tirey (1972), and others have described manned and unmanned devices for making acoustic measurements, drilling bore holes, operating vane shear and cone penetration devices, and securing undisturbed tube samples. Units of this type tend to be very expensive and to require highly skilled operators.

### Diver-operated Systems

132. The US Navy Civil Engineering Laboratory, Port Hueneme, California, has developed a suite of diver-operated sampling and testing devices (Johnson 1988): an impact sample tube, a miniature standard penetration tester, a vane shear tester, a rock classifier (basically a Schmidt Hammer), a jetted depth probe, and a vacuum-assisted sampler. It should also be possible for a diver, or group of divers, to operate bottom-supported drilling and sampling machines and devices powered by flexible connections from a small surface vessel. This has the inherent advantage of ease of movement with direct, rather than remote, control of the submersible devices.

## PART V: TEST METHODS FOR THE SOIL MATERIAL PROPERTIES

133. Tests are made in the field or in the laboratory to determine the geotechnical soil properties defined in Part II. They are the:

- a. Material (particle) properties, i.e., the properties of the individual grains or particles: mineralogical composition, grain specific gravity, surface chemistry, size, shape, angularity, and hardness;
- b. Mass (intact) properties; the position and arrangement of the soil particles in a soil mass determine the mass properties: in-situ density, water content, gas content, and structure; and
- c. Behavior properties; the shear strength is a combined function of (a) the material properties, (b) the mass properties, and (c) the applied external force system.

Most of the geotechnical soil test methods of particular relevance to dredging operations have been standardized by nationally recognized agencies such as the American Society for Testing and Materials (ASTM 1992) and by the U.S. Army Corps of Engineers in EM 1110-2-1906 (HQUSACE 1970). This part of the report contains a discussion only of the *soil material properties* tests. Tests for the soil mass properties and the behavior properties of shear strength and rheology are discussed in Part VI.

134. There are several choices among alternative groups of tests that will permit a suitable soil description for all the dredging-related characteristics listed in Part II. The rationale for deciding whether to perform a specific test, or group of tests, for any geotechnical property on the undisturbed soil in situ, at a field laboratory, or in a central laboratory will be considered in Part VII of this report. The choice is basically an economic one and often ends up as a matter of personal familiarity, confidence, and experience.

135. There are several soil properties that are of interest only if certain types of dredging equipment are to be used or if certain factors need to be known. These are performed as a special study rather than as a routine part of a site investigation. For a slurry pipeline project, the rheologic properties of a soil-water slurry should be determined for the range of soil types and slurry densities expected. Similarly, if a hopper dredge is indicated, or if sedimentation rate in a disposal area must be estimated, then

a series of sedimentation tests for the range of granular soils expected to be encountered, and at the water salinity found at the site, should be made. Bulking is dependent on several material property factors and on the method of placement of the soil. Bulking factors can only be truly known by simulating the deposition conditions.

#### Geotechnical Soil Material Properties

136. The geotechnical soil material properties are those of the disturbed and completely remolded material. They include tests for the:

- a. Distribution of particle sizes;
- b. Atterberg limits;
- c. Angularity, shape, and hardness of coarse grains;
- d. Amount of organics and cementitious materials;
- e. Specific gravity of the grains;
- f. Salinity of the pore water; and
- g. Visual-manual tests for estimating soil properties.

All of these properties are determined by standard test methods or are estimated by using acceptable alternative methods. The test methods in common use for dredging-related soil material properties, and references to national standards or published references, are given in Table 6. Most of the standard test methods listed in Table 6 have been devised for execution in a laboratory environment. This usually involves the availability of electric power, a water supply, freedom from dust and vibration, and reasonable control over temperature and humidity.

#### Particle-Size Distribution Tests

137. The fractionation of a soil into size groups is generally done by mechanical screening on a nest of sieves of different sized screen openings. The use of screens to fractionate silt- and clay-sized particles, smaller than about 0.075 mm (No. 200) to 0.063 mm (No. 230), is impractical because of the fineness of screens and their tendency to become clogged with particles. If the coarse fraction contains plastic fines, preliminary drying will cause some clay particles to adhere to the sand and gravel grains, giving erroneous test results. A thoroughly saturated sample of clay-coated coarse grains can be washed on the No. 200 screen with the fines passing through instead of adhering.

Table 6  
Geotechnical Soil Material Properties Tests

Property	Test Methods	References
Particle size distribution, sand and gravel sizes	Standard sieve analysis (+200 screen fraction)	ASTM D422
Particle size distribution, silt and clay sizes	Standard hydrometer (-200 screen fraction)	ASTM D422
Amount of material passing No. 200 screen	Standard sieve analysis (Wash through No. 200)	ASTM D1140
Clay content only (using sedimentation)	Decantation method Pipette method	Mills (1970) Mills (1970)
Atterberg liquid limit	Standard multipoint Standard one point	ASTM D4318 ASTM D4318
Atterberg plastic limit	Standard laboratory	ASTM D4318
Specific gravity of grains	Standard laboratory	ASTM D854
Grain shape/angularity	Visual-manual test	ASTM D2488
Grain hardness	Scratch (Mohs) test	-----
Organic content	Wet and dry methods	Bartos (1977)
Carbonate content	Rapid carbonate analyzer	Demars et al. (1983)

138. A laboratory test, based on the theoretical rate of sedimentation of spherical particles in water and using a hydrometer to measure slurry density, is used instead of screens for the fine-grained (finer than No. 200 screen) fraction of the soil sample. Clay particles tend to be in the form of platelets. Because of the flocculating effect of various dissolved minerals in water, distilled water and a dispersing (deflocculating) agent are usually used to determine the "equivalent spherical" sizes of the fine grains. Stokes' law of settling bodies in still water or other suspending medium is used to calculate the amounts of equivalent spherical sizes present at a given depth at stated times. Turbulence in the suspending medium will retard the settlement of the particles. Stokes' Law may be expressed as:



$$d = \sqrt{\frac{30 n L}{980 (G - G_1) T}} \quad (3)$$

where

- d = Maximum grain diameter in suspension, millimetres
- n = Coefficient of viscosity of the suspending medium (usually water), in poises; viscosity varies with temperature of the suspending medium
- L = Distance in centimetres through which the soil particles settle in a given period of time
- G = Specific gravity of the soil particles
- G<sub>1</sub> = Specific gravity of the suspending medium
- T = Time in minutes of sedimentation

Recently, the tedious methodology of the hydrometer test has been supplanted in the laboratory by electro-resistance multichannel particle-size analyzers such as the Coulter Counter (Poppe et al. 1985).

139. If only the amount of clay sizes is needed rather than the distribution, as is often the case, then two cost effective alternative methods, the decantation method and the pipette method (Mills 1970), should be considered. Both methods use the standard hydrometer test procedure for preparing the slurry, but rely on decantation or a pipette to remove all of the clay fraction still in suspension after a stated time period, leaving only the silt and coarser sizes. These methods will yield only the total percent clay; however, this may be sufficient in many situations.

#### Sedimentation Rate in Saline Water

140. The standard procedure for performance of the sedimentation rate test as part of the grain size analysis of a fine grained soil involves the use of distilled water and the addition of a water softener to deflocculate the clay fraction. This is of value in determining the equivalent spherical grain sizes, but does not give a true picture of the behavior of the same soil in its natural environment, which most often is saline water. Salts and other dissolved minerals tend to cause flocculation of the clay minerals. The flocs, or aggregations, act as particles of a larger diameter. Thus the flocs will have a greater settling rate than predicted by the standard hydrometer test result. The true settling rate must be determined using water of the

same salinity as will be encountered in-situ. A test method for flocculated settlement is given in Engineer Manual 1110-2-5027 (HQUSAE 1987).

#### Analysis of Grain-Size Data

141. The gradation information of interest concerns maximum size, median grain size ( $d_{50}$ ), some measure of uniformity, such as  $C_u$  ( $d_{60}/d_{10}$ ) or of dispersion ( $d_{85}$ ,  $d_{15}$ ), and fines content (-No. 200). Plotted grain-size distribution curves were used in the pre-computer era because of computation difficulties. The use of a plotted curve permits visual determination of the grain size corresponding to any percentage finer or coarser, especially if it is not coincident with a standard sieve size.

142. The availability of grain-size data as grain fractions for a group of sieves, with an appropriate computer analysis program, can easily yield the various grain size parameters of interest without the necessity for graphical plotting. The U.S. Geological Survey, among others, has developed an automated particle-size analysis system (Pope, Eliason, and Fredericks 1985). This system uses screening for the gravel fraction, a Rapid Sediment Analyzer for sand sizes, wet washing through a no. 230 screen, and a Coulter Counter for the fine fraction. Coupled with a microcomputer, this system ". . . integrates the coarse and fine-fraction data into a complete size distribution, performs [the] method of moments and inclusive graphical statistics, and texturally and statistically classifies the sediment with verbal equivalents. In addition . . . [the data] . . . are stored in a data-retrieval system that can be accessed by a large number and variety of users."

143. It is not even necessary that the individual screen sizes be at uniform logarithmic intervals for calculations. Most textbooks on analytical statistics show that, for the method of moments, uneven class intervals can be used provided each class is characterized by its area, i.e., frequency times width, rather than frequency alone. Then, typical calculations for mean and median grain size and the uniformity of the distribution can be made easily. A frequency histogram or a cumulative frequency ogive (i.e., a typical grain size curve) can be drawn by hand or by machine for presentation purposes.

#### Atterberg Limits Test Methods

144. The plasticity chart (Casagrande 1948) shown in Figure 2 was a major advance in cohesive soil description. The A-line is used to differentiate silts from clays, based on plasticity rather than grain size.

The Atterberg limits tests are performed on all material in a soil finer than 0.425 mm (No. 40 screen). The particles of sand and silt included in the material finer than 0.425 mm act as an inert filler. Silt is the result of mechanical degradation whereas clay is the result of chemical weathering. The type and amount of clay mineral present, and the ions in the pore water, determine the "plasticity" of a clayey soil. For a "pure" clay, the liquid limit and plasticity index are high for a montmorillonite clay, intermediate for illite, and low for kaolinite.

145. The standard test methods for liquid and plastic limits are given in various geotechnical textbooks and manuals, including ASTM (1992) Method D4318, and will only be summarized here:

- a. *Liquid Limit*: A pat of wet soil is placed in a shallow, flat cup and a standard size groove is cut in the soil. The cup is impacted by free falling onto a standard base and the number of impacts to cause the groove to close a distance of 1/2 inch is counted; a sample of this soil is tested for water content. The soil is slightly wetted or dried as needed and another test made. This is continued until several points requiring more and less than 25 blows is completed. A semilog plot of water content vs number of blows is made and a regression line drawn through the points. The water content corresponding to 25 blows is the liquid limit water content.
- b. *Plastic Limit*: A moist soil is rolled by hand until it forms a thread 3 mm (1/8 inch) in diameter. This is continued by slightly drying the soil for succeeding trials until the water content is reached at which the threads will begin to crumble on reaching the 3 mm (1/8 inch) diameter. The soil is then at the plastic limit water content.

146. The slope of the flow line, i.e., the regression line for the points in the standard multipoint liquid limit test, is fairly constant. Therefore, by making only one test at a single water content, as described above, and estimating the slope of the line, an estimate can be made of the water content corresponding to 25 blows. The one-point method for liquid limit is a reasonably close approximation of the standard method and is much easier, quicker, and more economical to perform. The one-point method test values, which are usually within one or two water content percent of the standard multi-point values, should suffice for almost all dredging-related classification work and should be used. Multipoint liquid limits tests are somewhat more precise when used in research correlation work with other

properties. However, the liquid limit is a function of the amount of clay mineral present in the tested portion of the sample. Since the amount of clay varies slightly at random throughout any sample, even the multipoint test will have a testing variance making the difference in accuracy of the multipoint vs one-point test methods almost trivial.

147. The recent literature reports the use of fall-cones to determine the Atterberg limits (cf. Budhu 1985; Wasti 1987). These devices are in general use in Europe, Asia, Canada, and in research efforts in the United States. The correlation of tests using these devices with those using the standard Atterberg-Casagrande device is not definite or complete at this time. It is therefore necessary that the Atterberg limit test method be given with the numerical test data.

#### Correlation of Atterberg Limits and Per Cent Clay

148. Every clay soil type appears to have a unique correlation between its liquid limit and its plasticity index with the per cent clay. Given the correlation for a specific locality, then the clay content, as a per cent of the -40 screen fraction, can be used to estimate the liquid limit and/or the plasticity index. A number of published correlations exist between the Atterberg limits and per cent clay sizes; two are presented here as examples. Davidson and Sheeler (1952) published test data for loess soils in Iowa having clay contents ( $< 0.002$  mm) less than 40%. Regression equations for the Atterberg limits vs per cent clay are shown in Table 7. Spangler and Handy (1982), based on the Davidson and Sheeler work, commented: "In general the liquid limit is directly proportional to the clay content whereas the plastic limit is directly proportional above about 45% clay and inversely proportional below. Since the activity index depends on the difference between these, which is the PI, it therefore should relate to clay minerals only in clay-rich soils." The USAE Waterways Experiment Station published (USAEWES 1962) test data from fine-grained alluvial soils from the lower Mississippi River valley. Regression equations for 73 samples from eight projects are also given in Table 7. Of this group, only one project, with 16 samples, had a plastic limit vs clay content relationship with a negative slope at a low clay content, less than 25 per cent clay. The regression line was positive above that amount of clay. The values of slope of plasticity index vs percent clay indicate a low to intermediate Activity Index for both soils. It should be

Table 7  
Correlation of Atterberg Limits and Percent Clay\*

Atterberg Limit	Loess (Davidson and Sheeler 1952)	Miss. River Alluvium (USAEWES 1962)
Liquid limit, LL	0.88 (% clay) + 18.32	1.31 (% clay) + 13.82
Plastic limit, PL	0.31 (% clay) + 22.48	0.21 (% clay) + 18.95
Plasticity index, PI	1.21 (% clay) - 11.50	1.04 (% clay) - 1.62
* Per cent of the -40 screen fraction that is finer than 0.002 mm.		

noted that the intercept (Plasticity index at zero per cent clay) is not necessarily zero. Regression lines are discussed further in Part V of this report.

Should Saltwater Be Used in Laboratory Soil Tests?

149. All standard laboratory tests that require the addition of water to a sample also require that distilled, demineralized water be used. HQUSACE (1987, p 3-2) recommended the use of saltwater at the in-situ salinity for: ". . . all [sediment] characterization tests and in the settling tests." The sediment characterization tests include the sedimentation part of grain-size analysis (the hydrometer test), Atterberg limits, and specific gravity of grains. Eckert and Callender (1987, p. 6-37) also recommended adding water at the in-situ salinity to those tests requiring addition of water. They argued that the Atterberg limits tests should be made without drying the soil sample during preparation; therefore the sample already contains saltwater. These are questionable recommendations and should be followed only if the effect is fully understood and reported.

150. The wet grain-size analysis, using a hydrometer, is a standardized test that uses a dispersing agent and demineralized water to deflocculate the soil. Obviously, the use of saltwater defeats the standard test because it tends to cause flocculation. Therefore, a choice must be made: either the standard test is used to indicated the amounts of silt and clay sizes present in the sample, or the test is used to measure the rate of sedimentation of the flocculated soil and is not expected to yield the grain size distribution; it cannot give both types of information at the same time. The use of saltwater in the specific gravity test makes no sense. The soil grains must be

deflocculated (dispersed) to permit measurement of the volume of solids. The Atterberg limits use an empirical test procedure as an index, or indicator, of the mineralogy of the soil grains and, therefore, of their plasticity. They are used because they are easier, and more cost effective, than other tests for the same purpose. Any change in the standard test procedure invalidates the test results and would, therefore, destroy the only function of the Atterberg limits. The effect of saltwater in the soil during Atterberg limits testing has not been established. Until that point has been clarified by suitable research, it is suggested that the saltwater be leached and replaced by demineralized water as required for the standard test.

Grain Angularity and Shape

151. Grain angularity and shape are most easily determined by visual comparison with standards. The simplest of these systems is the visual-manual (ASTM 1992, Method D2488) procedure where pictures of rounded, subrounded, subangular, and angular grains are used for comparison. Particle shape is easily identified as flat, elongated, or flat and elongated particles. Tables 8 and 9 are from ASTM D2488.

Table 8 <u>Angularity of Coarse Grained Particles Using Visual-Manual Methods</u> (ASTM D2488)	
Term	Criteria
Angular	Particles have sharp edges and relatively plane sides with unpolished surfaces.
Subangular	Particles are similar to angular description but have rounded edges.
Subrounded	Particles have nearly plane sides but have well-rounded corners and edges.
Rounded	Particles have smoothly curved sides and no edges.

Grain Hardness

152. Grain hardness can only be defined in terms of the test procedure used to identify it. The most commonly used hardness test for rock and for rock fragments (soil) is Mohs' relative hardness scale, described in virtually every elementary physical geology text. Ten minerals are identified in the

Table 9  
Shape of Coarse Grained Particles Using Visual-Manual Methods  
 (ASTM D2488)

Term	Criteria
Flat	Particles with width to thickness ratio greater than 3
Elongated	Particles with length to width ratio greater than 3
Flat and Elongated	Particles meeting criteria for both flat and elongated.
Spherical (typically not stated in description)	Particles having width to thickness ratio and length to width ratio less than 3.

system and the hardness of any grain is determined by its ability to scratch those minerals with lower hardness. Quartz, a component of many sands, has a Mohs hardness of 7, limestone has a hardness of 3, and gypsum has a relative hardness of 2. As a simple field test, the hardness of gravel particles may be tested by striking the grains with a hammer.

#### Organic Content

153. The organic content of a soil sediment may be established by dry combustion or wet combustion or by using the ASTM D2487 (ASTM 1992) Atterberg limits procedure. Bartos (1977) discusses several literature sources for the combustion tests, all of which involve drying the soil at a high temperature to burn the organics. Bartos adopted, for dredged materials, a dry combustion procedure involving (a) drying a sample to constant weight at 110°C, and then (b) after weighing the sample, burning off the organics at 440°C in a furnace for 4 hours. The *ash content* is the uncombusted residue, mostly clay minerals. Landva (1986) defined highly organic soils on the basis of ash content; they are given in Table 10. ASTM D4427 (ASTM 1992) defines peat as having less than 25% ash. Therefore, Landva's definition of peat has been modified in Table 10 from 20 to 25 percent.

154. In the ASTM procedure for organic soil, the Atterberg liquid limit is determined on a sample that has not been previously dried. A portion of the sample is oven dried to 110°C and liquid limit re-tested. If the liquid

limit, oven dried, is less than 75% of the liquid limit, never dried, the soil is defined as organic.

Table 10 Highly Organic Soils (After Landva 1986 and ASTM D4427)	
Soil Type	Description
Peat	Ash content less than 25%. Derived from plants. Very fibrous.
Peaty Organic Soils	Ash content 25 to 40%. Part fibers and part colloidal organics.
Organic Soils	Ash content 40 to 95%. All colloidal organics.
Soils With Organic Content	Ash content over 95%. All colloidal organics.

#### Carbonate Content

155. Demars et al. (1983) discuss several published methods for determination of both the presence and amount of carbonate material in soil and rock. They recommend a procedure using a "rapid carbonate analyzer" which (a) is accurate to plus or minus five per cent, (b) has a high analytical speed, (c) has a low equipment capital cost, and (d) requires minimal operator skills. Simply the presence, but not amount, of carbonates may be expediently tested by using dilute hydrochloric acid. A drop or two on a soil sample will cause a reaction in the presence of carbonates, which may be described as given in Table 11.

Table 11 <u>Reaction of Sediments with Hydrochloric Acid (HCl)</u> (ASTM D2488)	
Description	Criteria
None	No visible reaction
Weak	Some reaction, with bubbles forming slowly
Strong	Violent reaction, with bubbles forming immediately

#### Specific Gravity of Grains

156. The specific gravity of the soil grains is usually determined by laboratory testing. A dried sample of the soil is weighed in air. The same



sample is then immersed in water and the loss in weight, or the displacement, is used to determine the volume. The specific gravity of most soils tends to be fairly uniform in a limited area because of the sorting action of many geologic processes. A typical coefficient of variation of three percent has been reported in the literature (Lee, White, and Ingles 1983).

#### Salinity of Pore Water

157. Engineer Manual 1110-2-5027 (HQUSACE 1987) discusses two ways to determine the salinity of the pore water: electrical conductivity and measurement of dissolved solids or nonfilterable residue. The electrical conductivity is measured by a conductivity meter that electronically converts conductivity, adjusted for temperature, into salinity. The dissolved solids procedure (APHA 1985) involves filtration of water from the soil, evaporation of the water, and weighing of the solid residue.

#### Visual-Manual Soil Tests

158. The use of visual and simple manual procedures to identify and describe soils predates the formal geotechnical engineering tests. The most commonly used visual-manual methods are given in ASTM D2488, "Description and Identification of Soil (Visual-Manual Procedure)" (ASTM 1992). All of the methods are intended to be performed in a field situation without the need for a laboratory environment or laboratory-style equipment. All of the methods are useful, but crude, field expedients for estimating the results of the standard laboratory identification tests.

159. All soil types. *Color*, while not a fundamental property, is useful in stratum correlation and as an indicator of an oxidizing or reducing environment. *Odor* is an immediate and evident indicator of organics or chemical pollutants. The general *moisture* condition may be described as dry, moist, or wet. The coarse grains, if any, are examined for maximum size and approximate amounts of various *grain sizes* using the familiar examples of Table 12.

160. Cohesive soils. Several field expedient manual tests are prescribed in ASTM D2488 (ASTM 1992) for estimation of the properties of a cohesive soil. The *dry strength* of a clayey soil, defined in Table 13, is an indicator of the plasticity index, the higher the pressure between the fingers necessary to crush a ball of dried soil the higher the plasticity. The *dilatency* test indicates, as shown in Table 14, the absence or presence of

Table 12.  
Grain Size Identification

Name	Grain Size Limits		Familiar Example (Sowers, 1979, p. 82)
	USCS (ASTM 1992)	PIANC (1984)	
Boulder	> 300 mm > 12 in.	> 200 mm > 8 in.	Basketball
Cobble	300 - 75 mm 12 - 3 in.	200 - 60 mm 8 - 2.4 in.	Grapefruit
Coarse Gravel	75 - 19 mm 3 - 3/4 in.	60 - 20 mm 2.4 - 0.8 in.	Orange or lemon
Medium Gravel	Not defined	20 - 6 mm 0.8 - 0.25 in.	
Fine Gravel	19 - 4.75 mm 3/4 in. - No. 4	6 - 2 mm 0.25 in. - No. 10	Grape or pea
Coarse Sand	4.75 - 2.00 mm No. 4 - No. 10	2 - 0.6 mm No. 10 - No. 30	Rock salt
Medium Sand	2.00 - 0.42 mm No. 10 - No. 40	0.6 - 0.2 mm No. 30 - No. 70	Sugar; table salt
Fine Sand	0.42 - 0.074 mm No. 40 - No. 200	0.2 - 0.06 mm No. 70 - No. 230	Powdered sugar
Coarse Silt	All material passing No. 200 screen (74 $\mu$ ) is classed as fines (silt and clay); clay is finer than 0.002 mm	0.06 - 0.02 mm	Particles finer than fine sand cannot be discerned with the naked eye at a distance of 8 in. (20 cm).
Medium Silt		0.02 - 0.006 mm	
Fine Silt		0.006 - 0.002 mm	
Clay		< 0.002 mm	

clay particles in a fine grained soil; clay inhibits volume change due to vibration or shaking. The *toughness* of a soil, described in Table 15, is an indicator of the clay content and type, the tougher the soil the higher the plasticity of the clay. The three manual test results: dry strength, dilatency, and toughness are used in ASTM D2488 to identify the soil according to the Unified Soil Classification System, as shown in Table 16. Using an expedient field test, the estimated *consistency* of cohesive soils may be determined by manipulating the intact soil, as given in Table 17. It should be noted that there is a difference in the consistency terms defined in the

Table 13	
<u>Dry Strength of Cohesive Soils Using Visual-Manual Methods</u> (ASTM D2488)	
Term	Criteria
None	Dry specimen crumbles into powder with mere pressure of handling
Low	Dry specimen crumbles into powder with some finger pressure
Medium	Dry specimen breaks into pieces or crumbles with considerable finger pressure
High	Dry specimen cannot be broken with finger pressure. Specimen will break into pieces between thumb and hard surface
Very high	Dry specimen cannot be broken between the thumb and a hard surface

Visual-Manual procedure of ASTM D2488, Table 17, and the Unified Soil Classification System (USAEWES 1960) as shown in Table 19, which appears on page 95. A squeezing test may also be made on granular particles to establish their probable friability. An expedient field test for the degree of *cementation* of cemented soils as given in Table 18.

Table 14	
<u>Dilatency of Cohesive Soils Using Visual-Manual Methods</u> (ASTM D2488)	
Term	Criteria
None	No visible change in the specimen.
Slow	Water appears slowly on the surface of the specimen during shaking and does not disappear or disappears slowly upon squeezing.
Rapid	Water appears quickly on the surface of the specimen during shaking and disappears quickly upon squeezing.

Table 15	
<u>Toughness of Cohesive Soils Using Visual-Manual Methods</u> (ASTM D2488)	
Term	Criteria
Low	Only slight pressure is needed to roll the thread near the plastic limit. The thread and the lump are weak and soft.
Medium	Medium pressure is needed to roll the thread to near the plastic limit. The thread and the lump have medium stiffness.
High	Considerable pressure is needed to roll the thread to near the plastic limit. The thread and the lump have very high stiffness.

Table 16				
<u>Field Identification of Cohesive Soils from Visual-Manual Tests</u> (ASTM D 2488)				
Soil Description	Dry Strength	Dilatency	Toughness	Group Symbol
Silt	None to low	Slow to rapid	Low or thread cannot be formed	ML
Lean clay	Medium to high	None to slow	Medium	CL
Elastic silt	Low to medium	None to slow	Low to medium	MH
Fat clay	High to very high	None	High	CH

Table 17

Field Estimated Consistency of Cohesive Soils Using Visual-Manual Methods  
(ASTM D2488)

Description	Criteria
Very soft	Thumb will penetrate soil more than 1 in. (25 mm)
Soft	Thumb will penetrate soil about 1 in. (25 mm)
Firm (Stiff)	Thumb will indent soil about 1/4 in. (6 mm)
Hard	Thumb will not indent soil but readily indented with thumbnail
Very hard	Thumbnail will not indent soil

Table 18

Strength of Shale and Cemented Soils  
(After Jackson 1976)

Term	Definition
Weakly Cemented	Pick removes soil in lumps that can be abraded with thumb and broken with hands.
Strongly Cemented	Pick removes soils in lumps, but lumps cannot be abraded with thumb or broken with hands.
Indurated	Broken only with sharp pick blow, even when soaked. Makes hammer ring.

## PART VI: TEST METHODS FOR SOIL MASS AND SHEAR STRENGTH PROPERTIES

161. This part of the report contains a discussion of field and laboratory test methods for the:

- a. Soil mass properties--for the properties of the undisturbed soil mass;
- b. Soil behavior properties--shear strength tests for cohesive and cohesionless soils, made in either the field or the laboratory; and
- c. Rheologic properties of soil slurries.

Many of the geotechnical field and laboratory test methods of particular relevance to dredging operations have been standardized by nationally recognized agencies such as the American Society for Testing and Materials (ASTM 1992) and by the U.S. Army Corps of Engineers in EM 1110-2-1906 (HQUSACE 1970).

### Soil Mass Properties Tests

162. Many of the engineering behavior properties of a soil mass are directly related to the bulk density, the water content, and the gas content. The bulk density of a soil, in turn, is directly related to the combined effects of the grain material characteristics and the mode of formation of the soil deposit. In coarse-grained soils, gradation and external pressure together determine the degree of packing, which may be loose or dense, and the porosity. For fine-grained soils, an additional factor is the character of the pore water as it affects the degree of flocculation. A soil of given porosity can have any water content, up to the amount that will completely fill the voids, i.e., fully saturated. Tests for the properties of the soil mass include the:

- a. In-situ bulk density;
- b. Relative density of cohesionless soils;
- c. Bulking factor of redeposited soils; and
- d. Natural water content.

### Density (Unit Weight) Test Methods

163. The density, or unit weight, of a soil deposit is measured as weight per unit of volume. With water content known, the solids (dry) density

can be easily calculated. With the addition of specific gravity of grains, the solids volume and gas content can be determined. All of these parameters are useful in dredging productivity calculations. There are several methods for determining, or estimating, the in-situ bulk density: undisturbed tube samples of cohesive soils, nuclear devices, acoustic devices for slurries, and various estimating systems including the resuspended density test.

164. Undisturbed sample methods for in-situ bulk density. Relatively undisturbed samples may be taken from soft to stiff cohesive soils by using a thin-walled sampling tube inserted into the soil slowly and without impact (ASTM 1992; Method D1587). If no drying is permitted prior to testing, the bulk density of the soil may be measured by direct weighing and volume measurement, either in the tube or after extrusion. Determination of the average water content permits calculation of the dry density and of gas content.

165. Granular soils are almost impossible to sample undisturbed in a test boring or pit, i.e., sampled without volume and structure change (Hvorslev 1949; Marcuson and Franklin 1979). Physical displacement, using a scoop or other device to retrieve a known volume and measurable weight of soil, has been used with some success on land, provided adequate testing care is used (Weiler and Kulhawy 1978). The successful application of this type of device to underwater density determination has considerable merit -- it can also provide a disturbed, representative sample for specific gravity tests and gradation analysis -- if such a device can be developed.

166. Nuclear in-situ bulk density devices. Nuclear devices determine soil density by measuring the attenuation of gamma radiation in a specific time period and comparing this to the attenuation in one or more calibration standards. These devices have been used for over ten years in dredging-related in-situ studies and discussed in that capacity by a number of writers (Poloncsik et al. 1972; Parker, Sills, and Paske 1975; Parker and Kirby 1977; Montante 1980; Oostrom, Parker, and Kirby 1980; Oostrum and Bakker 1983; Caillot et al. 1984; Vlieger 1986; Vlieger and Cloedt 1987; Ruygrok 1988). At least one American manufacturer supplies a nuclear probe device (Montante 1980) used for both density and water content. That device has an operating length of about 1.2 m (4 feet). Optical (IHC Holland 1983) and nuclear devices are used to measure slurry density in pipelines.

167. Acoustic test devices for in-situ bulk density. Acoustic methods for density determination in-situ involve the direct transmission of sound waves through the soil or slurry. The echo sounding technique achieves penetration into layers of increasing density by varying the wave frequency. Among the writers discussing this methodology are Hellema (1984), Tarbotton and Murphy (1984), and the World Dredging and Marine Construction periodical (WDMC 1986). Most such devices are useful only in soil/water mixtures having a density much less or much greater than about 1100 to 1300 grams per liter (Vlieger and Cloedt 1987). The relationship between the attenuation of sound waves and soil/water density is nonlinear, with a positive (increasing) slope at low densities. The relationship reaches a peak at about 1100-1300 gr/liter, after which the attenuation decreases with increasing density, making it difficult to establish whether the measurement is in the high or low density range with certainty, unless auxiliary identification testing of some sort is used. The physico-chemical properties of the soil greatly affect the sound transmission, requiring extensive calibration efforts (Vlieger and Cloedt 1987). Hellema (1984) described a system in which nuclear density gauges are used to calibrate the acoustic device in a given harbor, after which the acoustic device gives a continuous density profile which is many times faster than nuclear gauge measurements.

168. Resuspended bulk density tests. Responding to the need for an estimate of granular soil density in a dredge hopper, the resuspended density test was developed over ten years ago. This is a non-standard sedimentation type laboratory test. As performed in the North Pacific Division laboratory, a 2000 ml clear plastic cylinder is filled about half depth with granular soil sampled from the project site, or taken from the hopper hold, and then filled with water. The soil is thoroughly dispersed through the water by agitation, after which the soil is allowed to sediment for about 24 hours. Following removal of the supernatant water, the final sedimented weight and volume of the soil is measured and the saturated density recorded as the "resuspended density". This system for estimating weight-volume relations for soils in a hopper hold has apparently been reasonably satisfactory in service.

#### Relative Density of Cohesionless Soils

169. Relative density measurement and application were discussed by a number of contributors to an ASTM meeting on the topic. Selig and Ladd (1973)



summarized the papers presented to the meeting. The determination of relative density involves three measurements: (1) in-situ density, (2) maximum density, usually by laboratory test involving vibration (Method D2049, ASTM 1992), and (3) minimum density, also by laboratory test, usually involving loose pouring of the dried soil (Method D2049, ASTM 1992). The difference in density between the minimum and maximum for many clean sands is typically on the order of 320 gr/litre (20 lb/cu ft). Methods for measurement of in-situ density in granular soil are particularly difficult and error prone. Errors on the order of +/-30 gr/litre (2 lb/cu ft) are not uncommon in the determination of field density, leading to potentially large errors in the value of relative density.

170. Selig and Ladd (1973) concluded their review of the several conference papers:

"As a concept, relative density has merit and it is useful in expressing general trends in performance of granular materials.

". . . physical behavior such as . . . shear strength and liquefaction potential are not uniquely related to (relative density). Other factors such as uniformity of size and angularity (of the grains) must also be involved. Thus for example, two different materials with the same (relative density) would probably not have the same value of angle of internal friction.

"Relative density is not a sufficient index to correlate physical properties with the density state of cohesionless materials. Other indices like angularity, sphericity, and uniformity are needed.

". . . relative density is not a precise index. Other field density measurements such as static cone . . . and SPT should be considered as an alternative to (use of in-situ density) for design . . . ."

#### Bulking Factor of Redeposited Soil

171. There are no standard procedures for estimating the bulked density of a soil redeposited under field conditions without compaction. The *bulking factor* is the ratio of the volume occupied by a soil after redeposition to the volume occupied by the same amount of soil in-situ. Laboratory tests used for this purpose were described in DiGeorge and Herbich (1978), based on work by Lacasse et al. (1977a, 1977b). A soil sample is dispersed throughout a volume of water, of appropriate salinity, by agitation. The soil is then allowed to settle in the same manner as the sedimentation portion of a grain size

analysis test. The resulting volume of sedimented soil, compared to the original volume, represents the bulking factor.

#### Water Content Test Methods

172. The natural water content of a soil must be accurately known for calculation of dry density and the degree of saturation. Generally, only a small portion of the specimen is tested. The distribution of water content is typically nonuniform through the specimen because of the nonuniformity of the fine-grained fraction. Unless the soil sample is thoroughly blended, the average water content of the specimen will not be accurately measured by the small tested portion. The blending must be done in a high humidity area to prevent loss of soil moisture during the manipulation of the soil. Three different techniques are in common use to measure water content: (a) oven drying methods; (b) nuclear methods; and (c) chemical methods.

173. Oven drying methods. The standard drying test for water content is based on measuring the loss of water from drying a soil specimen at a constant drying temperature of 105° to 110° C. This requires that a representative sample of the soil be retrieved and carefully sealed in the field to prevent loss of moisture during transport to the laboratory. For soils containing gypsum, a study by the Waterways Experiment Station (USAEWES 1954) showed that some of the bound water will evolve at temperatures below 105° C, affecting the test results.

174. Nuclear moisture methods. Equipment is readily available for measuring water content in situ using a nuclear moisture gauge, usually in conjunction with nuclear field density testing. A nuclear moisture/density gauge is commercially available that is contained in a probe (Montante 1980) that can be inserted into a soft or loose soil deposit to a distance of 1.2 m (4 feet). Nuclear soil moisture gauge methods use the thermalization, or slowing down, of neutrons colliding with hydrogen atoms to indicate water content as a percent of total weight. Because the gauge does not discriminate between hydrogen atoms in the pore water, those that are chemically bound, and those in organic matter, chemical effects such as organics in a soil deposit require calibration of the nuclear water content device against the standard oven drying method using soils from the specific project.

175. Chemical moisture methods. A patented chemical method (Speedy) uses calcium carbide to combine with the water to form acetylene gas. The gas

pressure formed in a closed container is directly related to water content, expressed as a percent of total weight. This method is well adapted to on-site testing if rapid recalibration of a nuclear moisture gauge is needed. Schwartz (1967) reported a calibration standard error of estimate of 1.44 percent water content, so that about one-half of all test values will be within one percent water content of the true value.

### Soil Shear Strength Tests

176. Tests for estimating the in-situ shear strength of a soil are of two types: (1) direct tests, that attempt to measure the shear strength by direct simulation of field shear conditions, and (2) indirect tests, that are used with empirical correlations to estimate shear strength.

177. Direct measures of in-situ shear strength used for dredging project site evaluations, and discussed below, are:

- a. Field Vane Shear Test (VST) of Cohesive Soil
- b. Laboratory Vane Shear Test of Cohesive Sample
- c. Compression Test of Undisturbed Cohesive Sample
- d. Compression Test of Thick-wall Tube Cohesive Sample
- e. Hand Penetrometer/Torvane Test of Cohesive Sample

178. Indirect, empirical estimators of the in-situ shear strength of soil, discussed below, are:

- a. Standard Penetration Test (SPT)
- b. Dynamic Penetrometer Test, Thick-wall Tube
- c. Dynamic Penetrometer Test, Solid Cone
- d. Static Cone Penetration Test (CPT)
- e. Hand-held Sounding Rod Test
- f. Penetration Rate of Vibrating Tube Corer
- g. Deceleration Rate of Gravity Projectile
- h. Laboratory Direct Shear Test of Re-densified Sand Sample

179. The shear strength of in-situ sediments affects the choice of equipment and the energy needed for excavation of the material. Unlike foundation engineering, where strength must be accurately and precisely known, dredging does not need high precision strength data. At the present state of the art, it is usually sufficient to categorize the strength of a sediment in

broad groups. Therefore, it suffices to use the compactness (loose to dense) of cohesionless soils, the consistency (very soft to very hard) of clayey soils, and the relative hardness of cemented soils and rock.

### Direct Tests of Shear Strength

180. Direct simulation testing requires an undisturbed sample. It is virtually impossible to obtain a true "undisturbed" sample of clean granular soils (Hvorslev 1949; Marcuson and Franklin 1979), loose saturated silts, very soft clays, or fluid muds. Therefore, direct tests of shear strength are usually limited to cohesive soils. The application of the test results requires a theoretical model base which is only partially developed for dredging excavation operations (Miedema 1989a, 1989b, Steeghs 1985a, 1985b).

#### Field Vane Shear Test

181. The Vane Shear Test (VST), Figure 23, attempts to measure the shear strength of a cohesive soil in a manner resembling an Unconsolidated-Undrained (Q) direct shear test, only vertically. The normal force on the shear surface is the lateral pressure of the soil deposit and the shearing force is the force on the shear vanes due to torsion of the shaft. This test is applicable only to cohesive soils. All of the requirements for a valid undrained test must be met, i.e., the soil must be a saturated cohesive soil with very low permeability (a clay) and the soil must be homogeneous and not stratified in the test zone. Furthermore, the soil must be soft enough that the thin blades will not deform during the test. Young et al. (1988) reported that the upper limit of shear strength for the VST is on the order of 200 kPa (2 tsf), or a stiff clay as defined in Table 19. The shear strength measured by the vane shear tester is one-half of the unconfined compressive strength.

182. The design of a multi-blade shear vane and method of field test are given in ASTM D 2573 (ASTM 1992). This type of device, using torque to indicate rotational resistance, requires a fairly stable platform but does not require a heavy reaction weight. Cox, Duersen, and Verhoeven (1986a, 1986b) describe a vane shear tester, based on the sea floor, with a multiblade vane sensitive enough to measure the shear strength of the fluid mud zone.

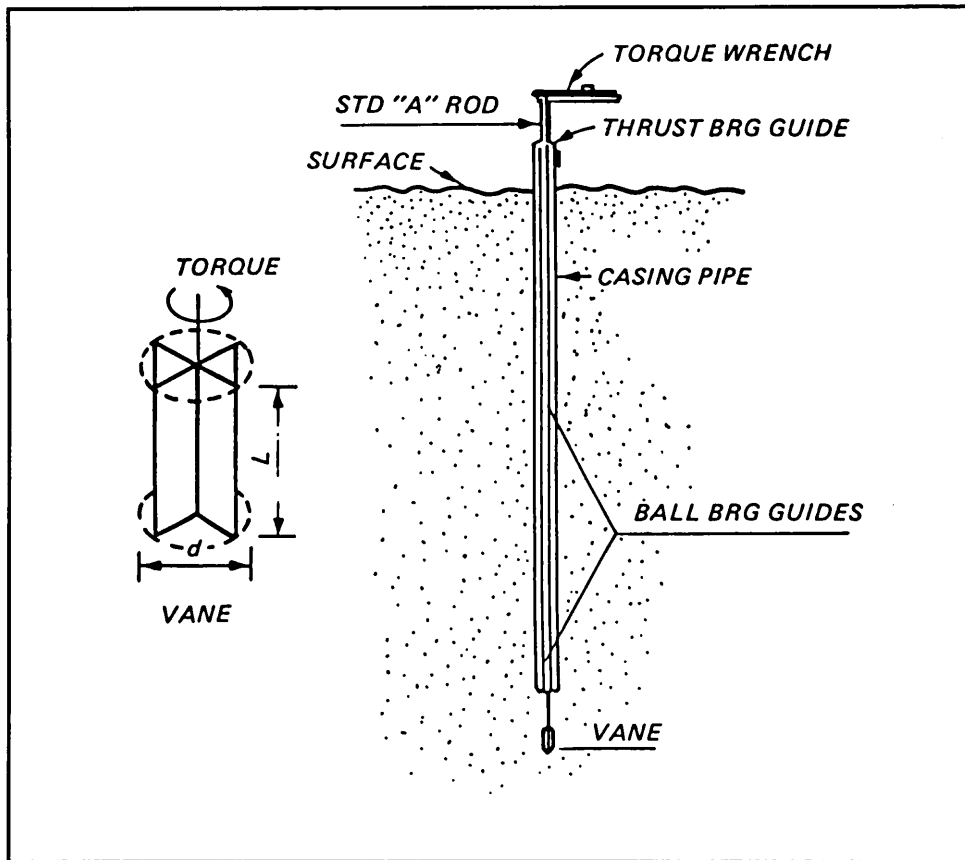

Figure 23. Field vane shear test

183. Interpretation of VST results appears, at first, to be simple and straightforward: a direct shear test has been made in situ and the measured shear strength is the undisturbed cohesion. However, Schmertmann (1975) pointed out that a great deal of confusion exists regarding interpretation of VST results. Bjerrum (1973) suggested a correction factor to be applied to the indicated shear strength :

$$C = 1.7 - 0.54 P I \quad (4)$$

where C - Correction factor  
 PI - Plasticity index of the soil

Starting with the Bjerrum correction to the undrained shear strength of clay for the effect of plasticity index, a number of other test variables have been identified that affect the test results (Ladd 1975). On this basis,

Schmertmann (1975) suggested that the VST be considered only "an intelligent sounding" or, at best, "a strength index test."

#### Laboratory Vane Shear Tester

184. A miniature shear vane, having the dimensions scaled down but relative to those given for the Field Vane Shear Test (VST) in ASTM D 2573 (ASTM, 1992) is sometimes used to provide a rapid test of an undisturbed clay soil specimen. This is most often done on a thin-wall tube sample of a clayey sediment. The laboratory vane shear test is used as an alternative to the unconfined compression test. The compression test requires that the sample be carefully extruded from the tube, handled, trimmed to size, and compression tested. Sensitive soils can be somewhat disturbed by poor handling practices during the extrusion, trimming, and testing, resulting in a lower compressive strength indication. The laboratory vane shear test can be made directly on the sample while it is still in the tube, eliminating the need for handling. Furthermore, several tests can be made along a short length of sample to determine variations of strength with depth.

#### Unconfined Compression Test of Cohesive Soil

185. Under the large strain rates used in dredging operations, soils shear in an undrained manner. The simplest, most straightforward, undrained shear strength test of cohesive soils is the unconfined compressive strength test. This is, in effect, an unconsolidated-undrained (Q) triaxial compression test (Figure 7) and simulates the shear strength available under rapid, undrained shear. A cylindrical undisturbed sample, with height twice the diameter, is tested in simple compression, without confining pressure, to failure within one to two minutes. The water content and bulk density of the test sample are normally measured in conjunction with the test. Casagrande and Wilson (1951) and others have shown that the unconfined compressive strength of clays and shales tested at very rapid strains rates, such as those occurring during very rapid cutting, increases by 30-40% or more over the strength from the common laboratory test made at a slower rate.

186. The *relative consistency* of cohesive soils is defined in terms of the unconfined compressive strength. The unconfined compression test is applicable only to saturated soils which will *stand unsupported* and have a low permeability so that undrained conditions exist during the test. Therefore it is not suitable for characterizing (a) the extremely soft slurries (often

referred to as fluid mud) encountered at the river/harbor bottom, (b) partially saturated soils, or (c) soils with a very low clay content. Descriptive terms for the consistency of cohesive soils in terms of  $q_u$ , from several sources, are given in Table 19.

Table 19			
<u>Consistency of Cohesive Soils</u>			
Consistency Term	Unconfined Compressive Strength		
	USCS (USA EWES 1960)		PIANC (1984)
	Tons/sq ft	kPa	kPa
Very Soft	< 0.25	< 25	< 40
Soft	0.25 - 0.50	25 - 50	40 - 80
Medium (Firm)	0.50 - 1.00	50 - 100	80 - 150
Stiff	1.00 - 2.00	100 - 200	150 - 300
Very Stiff	2.00 - 4.00	200 - 400	
Hard	> 4.00	> 400	> 300

Compression Test of Thick-wall Tube Cohesive Sample

187. The unconfined compression test of a thick-wall tube sample, from an SPT or larger sampler, can give a useful relative consistency if the cohesive soil is not very sensitive to remolding. For a sensitive soil, this test is not as accurate as a compression test made on a thin-wall tube sample. The effect of remolding is to cause a decrease in strength, with the amount of strength decrease dependent on the sediment's sensitivity to remolding and on the amount of remolding. The thickness of the sampler wall creates more remolding than does a thin-wall tube. However, the remolding is not total and the strength, in many cases, is only reduced 10 to 20 per cent.

Hand-Held Strength Testing Devices

188. Hand-held mechanical devices are used to estimate the unconfined compressive strength of clays. These include the hand, or pocket, penetrometer (Hvorslev 1943) and the Torvane device (Sibley and Yamane 1965). Fall cones have been used in the Scandinavian countries (Wood 1985) to estimate cohesive shear strength. It should be recognized that these methods provide only a rough estimate of consistency; however, this may be sufficient for

purpose of checking the validity of the primary test or as an aid in interpreting that test. For example, the hand penetrometer and/or the Torvane may be used on an intact, clayey SPT sample as a rough check on the visual field identification of soil type. For a given SPT N-value (blow count), a low plasticity, silty soil will give a lower hand penetrometer reading than expected from the usual correlation of N-value and compressive strength. For the same blow count, a medium to high plasticity clay will give a reading more nearly consistent with the correlation. Therefore, it may be concluded that the validity of hand penetrometer value varies directly with clay content, or plasticity, in the same manner that the unconfined compression test does.

### Indirect Shear Strength Tests

189. Commonly used indirect tests for estimating shear strength include various types of penetration tests, either dynamic or static. For example, the Standard Penetration Test (SPT) is a dynamic, impact test and the Cone Penetration Test (CPT) is a quasi-static test. All are based on empirical correlations between in-situ shear strength and some measure of penetration resistance. The various in-situ penetration tests have considerable value and merit in dredging-related site investigations. Because they reflect the shear strength of the soil, they also indirectly indicate the difficulty of cutting or eroding the soil. The geotechnical engineering literature abounds with correlations between the results of these test methods and measures of shear strength such as relative density. Among the most useful of the publications are: "In Situ Measurement of Soil Properties," (ASCE 1975), and "Cone Penetration Testing and Experience," (ASCE 1981). The geotechnical literature since 1981 includes some improvements in the techniques and understanding of the test methods.

#### Standard Penetration Test

190. Impact, or percussion, to drive a thick-walled sampler has been used for well over 50 years and the technology is well established. The resistance to penetration may be used to estimate the relative density of cohesionless soils and the compressive strength of cohesive soils. This type of device is capable of penetrating and retaining a wide variety of soil types and strengths, and is usually used in a small diameter drilled hole. The



recognized standard test for estimating the *relative compactness* of cohesionless soils is the Standard Penetration Test (SPT).

191. A thick-walled, split barrel sampler (Figure 16) is attached to the end of a drill rod string and placed at the cleaned out bottom of a drill hole. A 63.5 kg (140 lb) drop hammer is placed over the top of the drill string. The hammer is raised and allowed to drop freely a distance of 76 cm (30 in.) onto the top of the drill rod, forcing the sampler into the soil. The sampler is first driven 15 cm (6 in.) and the number of blows to drive the sampler another 30 cm (12 in.) is recorded as the SPT N-value or blow-count. The value of the test as an indicator of shear strength of soils has been much discussed over the past three decades. Schmertmann (1975) summarized many of the arguments, pro and con, presented up to 1975. Riggs (1986) discussed corrections to be made in the "standard" impact energy because of the effect of (a) different hammer designs, (b) different drill rod sizes, (c) different methods of operation.

192. SPT Test for Compactness of Sands: Terzaghi and Peck (1948) empirically related the Standard Penetration Test (SPT) to the relative density of sands. Since then, it has been shown that the relationship of relative density to SPT values is affected by the overburden pressure at the level of the test, by the effective hammer energy on the drill rods, by amount of overconsolidation, and by the age of the deposit. Gibbs and Holtz (1957) presented research-based corrections to the SPT blow-count to account for overburden pressure. The Gibbs and Holtz corrections were later modified (Peck and Bazaraa 1969) to reduce conservatism at high values of relative density.

193. Skempton (1986) summarized the results of several extensive investigations of the factors affecting the SPT: Energy of the hammer and hammer release system, rod length, presence of liner in the sampler, bore hole diameter, effective overburden pressure, overconsolidation, and ageing of the deposit. By making these corrections, as shown in Table 20, Skempton was able to rectify differences between recent laboratory studies and the original Terzaghi and Peck (1948) definition of relative density in terms of SPT. Skempton's recommendations for defining the compactness of sands using relative density in terms of the SPT, including the effects of ageing of the sand deposit, are given in Table 21. Given the relative density of the

Table 20

Corrections to Standard Penetration Test N-values  
(After Skempton, 1986)

$$(N_1)_{60} = N \frac{(E_v E_d)}{60} C_l C_s C_d C_N$$

where:  $(N_1)_{60}$  = Normalized SPT blow count, for 60 percent rod energy ratio and  $\bar{\sigma}_v = 1$  tsf (1 kg/cm<sup>2</sup>; 100 kPa).

N = Field SPT blow count, from 6 to 18 inches.

$E_v$  = Velocity energy ratio of hammer release system.

$E_d$  = Dynamic efficiency of hammer.

$C_l$  = Correction for rod length.

$C_s$  = Correction for sampler type.

$C_d$  = Correction for bore hole diameter.

$C_N$  = Correction for effective overburden pressure,  $\bar{\sigma}_v$ .

Energy of Release System and Hammer:

Release Type	Cathead	Energy Ratio, $E_v$	Hammer	Anvil Wt., Kg.	Dynamic Eff., $E_d$
(WES) Trip	None	1.00	Vicksburg	0	0.83
(USA) Slip rope, 2 turns	Large	0.70	Safety	2.5	0.79
(USA) Slip rope, 2 turns	Large	0.70	Donut	≈ 12	0.64
(Japan) Tombi	None	1.00	Donut	2	0.78
(Japan) Slip rope, 2 turns	Small	0.83	Donut	2	0.78
(UK) Trip	None	1.00	Pilcon	19	0.60
(UK) Slip rope, 1 turn	Small	0.85	Old Standard	3	0.71

Drill Rod Length, meters	=	3-4	4-6	6-10	over 10
Drill Rod Length, feet	=	10-13	13-20	20-33	over 33
Correction for Rod Length, $C_l$	=	0.75	0.85	0.95	1.00

Split Barrel Sampler Type	=	With Liner (1-3/8"ID)	w/o Liner (1-1/2"ID)
Correction for Sampler, $C_s$	=	1.2	1.0

Bore Hole Diameter, cm.	=	6.5-11.5	15	20
Bore Hole Diameter, in.	=	2.5-4.5	6	8.25
Bore Hole Correction, $C_d$	=	1.0	1.05	1.15

$$C_N = \frac{(a/b) + 1}{(a/b) + \bar{\sigma}_v}$$

where:  $a/b = 1.0$  for Normally Consolidated Fine Sand  
 $a/b = 2.0$  for Normally Consolidated Coarse Sand  
 $a/b = 0.7$  for Overconsolidated Fine Sand  
 $a/b = 1.4$  for Overconsolidated Coarse Sand

Table 21

Compactness of Sands Based on Standard Penetration Test  
After Skempton (1986)

Term	Relative Density, percent	Normalized* SPT N-values		
		Natural Deposits**	Recent Fills**	Laboratory Test Fills**
Very loose	0-15	0-3	0-2	0-2
Loose	15-35	3-8	2-6	2-5
Medium (firm)	35-65	8-25	6-18	5-16
Dense	65-85	25-42	18-31	16-27
Very dense	85-100	42-58	31-42	27-37

\* Corrected to 60% of free-fall energy of standard hammer weight and drop and normalized to unit effective overburden pressure of 100 kPa (1 Tsf).

\*\* 1. Natural deposits have been in place (undisturbed) for over 100 years; this corresponds to material that has never been dredged;  
 2. Recent fills have been in place for about 10 years; this corresponds to sediments that have been dredged within the past two to 50 years;  
 3. Laboratory test fills have been in place for less than one month; this corresponds to sediments that have been dredged within the past two years.

granular soil, the shear strength (angle of internal friction), may then be estimated from Figure 9 or a similar correlation.

194. SPT Test for Consistency of Cohesive Soils: Terzaghi and Peck (1948) presented an empirical relationship between the SPT N-value and unconfined compressive strength of cohesive soils. Sowers (1979) later modified this relationship, also based on empirical data, to correct for plasticity of the cohesive soil (Figure 24). The relationships for fine-grained soils contain a considerable test scatter.

Dynamic Penetrometer Test, Thick Wall Tube

195. The penetration resistances of the several sizes of thick wall, split tube samplers, from Table 5, have been roughly correlated with the SPT. The samplers of Table 5, and the drive hammer weights and free-fall distances usually used, are shown in Table 22.

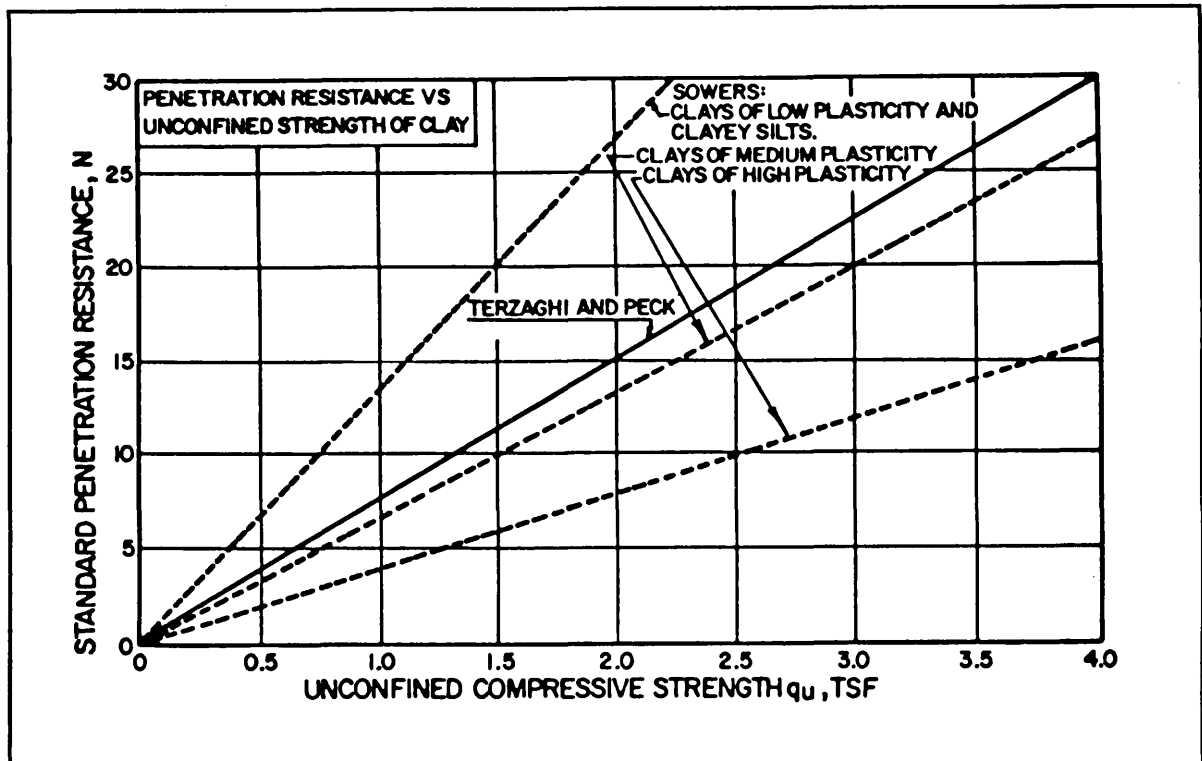

Figure 24. Unconfined compressive strength estimated from SPT N-values

	5.1 cm (2.0 in.)	6.4 cm (2.5 in.)	7.6 cm (3.0 in.)	8.9 cm (3.5 in.)
Outside Diameter	5.1 cm (2.0 in.)	6.4 cm (2.5 in.)	7.6 cm (3.0 in.)	8.9 cm (3.5 in.)
Inside Diameter	3.8 cm (1.5 in.)	5.1 cm (2.0 in.)	6.4 cm (2.5 in.)	7.6 cm (3.0 in.)
Hammer Weight	63.5 kg (140 lb)	136 kg (300 lb)	136 kg (300 lb)	136 kg (300 lb)
Hammer Drop	76 cm (30 in.)	46 cm (18 in.)	46 cm (18 in.)	46 cm (18 in.)
Drive Shoe	All samplers are typically fitted with a hardened steel drive shoe having the same OD as the sampler, but with an inside diameter 0.32 cm (0.125 in.) smaller than the sampler ID. This permits the use of a thin metal sample liner inside the sampling barrel, if desired.			
Length	Typically, all samplers are 61 cm (24 in.) long; longer versions are available.			

196. The penetration resistance measured with the 6.4 cm OD x 5.1 cm ID sampler is roughly similar to that measured by the SPT, according to Sowers (1979). The penetration resistance measured with the 7.6 cm OD x 6.4 cm ID sampler, as reported by Hvorslev (1949), is about double that of the SPT. There are no published correlations with the SPT for the penetration resistance measured with the 8.9 cm OD x 7.6 cm ID sampler, but the values are expected to be slightly greater than double the SPT value for the same sediment with the same compactness or consistency.

#### Dynamic Penetrometer Test, Solid Cone

197. Virtually all soil probing, or sounding, is done to evaluate or estimate the relative in-situ strength of a soil. Where successive layers vary widely in strength or hardness, the driving of a metal probing device can be used to define relative strength, and stratum changes, with fair to good accuracy. A cone-tipped penetrometer rod, or similar device, can be continuously impact driven using a machine- or hand-operated drop weight. Continuous driving obviates the need to withdraw the rods after each test. In some instances, devices have been devised to perform both cone penetrometer probing and impact tube sampling (Hvorslev, 1949; Haas, 1983). This test method is particularly effective for low-cost, rapid investigation of a sediment where the sediment type and stratification are well known in advance of testing, from prior experience or geophysical survey, because no sample is obtained. This method may be useful and cost effective in investigating maintenance dredging areas.

198. Resistance to penetration can be measured by (a) the number of drops of the drive weight required to drive the rod a given distance, or (b) the distance the rod is driven for a specified number of drops of the drive weight. Accurate measurement of in-situ strength will require (a) a consistent testing procedure and consistent equipment, and (b) correlation of sounding rod penetration resistance with another standard method. If the penetrometer rod is cased to reduce or eliminate sidewall friction on the rod, and the casing is driven concurrently with the rod so that very little of the rod extends beyond it, then the penetration resistance can be used to estimate the compactness or consistency of a sediment. If the outside diameter of the cone tip is the same as that of a thick wall, split tube device of Table 22, and the same size of hammer and same drop is used, then the solid cone tester

becomes the rough equivalent to the thick-wall, split tube penetration testers described above.

### Static Cone Penetration Test

199. The quasi-static Cone Penetration Test (CPT) is performed by slowly pushing a rod with an enlarged cone tip into the soil and measuring the force required for penetration. The cone tip is 36 mm (1.4 in.) diameter with a 60° cone point, giving an end area of 10 cm<sup>2</sup> (1.54 sq. in.), as shown in Figure 25. To reduce friction between the push rod and the surrounding soil, the rod is encased in a hollow rod. The hollow rod terminates in an enlarged sleeve just above the cone point. The sleeve is 13.26 cm (5.22 in.) long by 3.57 cm (1.4 in.) in diameter, with a surface area of 150 cm<sup>2</sup> (23.25 sq. in.), although sleeves with 200 cm<sup>2</sup> area have been used. The sleeve rod, in turn, is encased in a hollow shaft of 36 mm (1.4 in.) diameter. The three rods are pushed simultaneously at the rate of 2 cm/min (0.8 in./min) and the forces to push the cone and sleeve rods are separately measured. A typical force reaction is a 20 ton truck and force measurement may be mechanical, hydraulic, or by use of electric strain gages. The soundings and recordings for push forces are continuous.

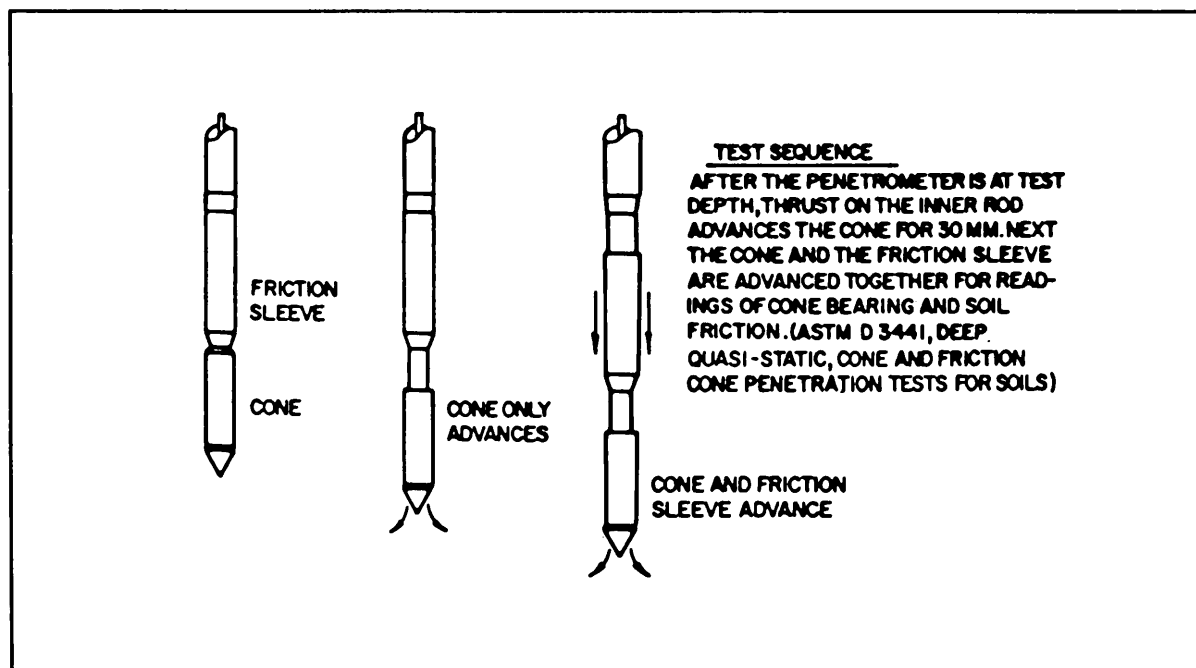

Figure 25. Cone penetrometer tip and sleeve

200. The tip resistance has been related to the angle of internal friction and the relative density of granular soils and to the compressive strength of cohesive soils. The interpretation of the tip resistance data requires knowledge of the soil type. By also measuring the sleeve frictional resistance, a ratio of the sleeve friction to the cone bearing, called the friction ratio, is calculated and used in estimating soil type.

201. CPT Test for Soil Identification: The relationship of cone bearing capacity to sleeve friction ratio, corrected for effective overburden pressure, has been empirically related to soil type (Olsen and Malone 1988) as shown in Figure 26.

202. CPT Test for Granular Soils: Among the many correlations of cone resistance and angle of internal friction for sands are those of Schmertmann (1978), Baldi et al. (1981), and Villet and Mitchell (1981). Based on these sources, Olsen and Farr (1986) developed a chart (Figure 27) showing angle of internal friction for normally consolidated sand with CPT cone resistance, normalized to an effective overburden pressure of one ton/sq ft (1 Kg/cm<sup>2</sup> or 100 kPa).

203. The relationship of cone bearing capacity to sleeve friction ratio, corrected for effective overburden pressure, has also been empirically related to Standard Penetration Test (SPT) N-values which have also corrected for the effect of overburden pressure (Olsen and Malone 1988), as shown in Figure 28.

204. CPT Test for Cohesive Soils: The unconsolidated, undrained shear strength, which is one-half of the unconfined compressive strength, is determined from:

$$S_u = \frac{q_c - \sigma_v'}{N_c} \quad (5)$$

where

- $S_u$  = Undrained shear strength (1/2 of unconfined compressive strength)
- $q_c$  = Cone penetration resistance
- $\sigma_v'$  = Effective overburden pressure
- $N_c$  = Bearing capacity factor

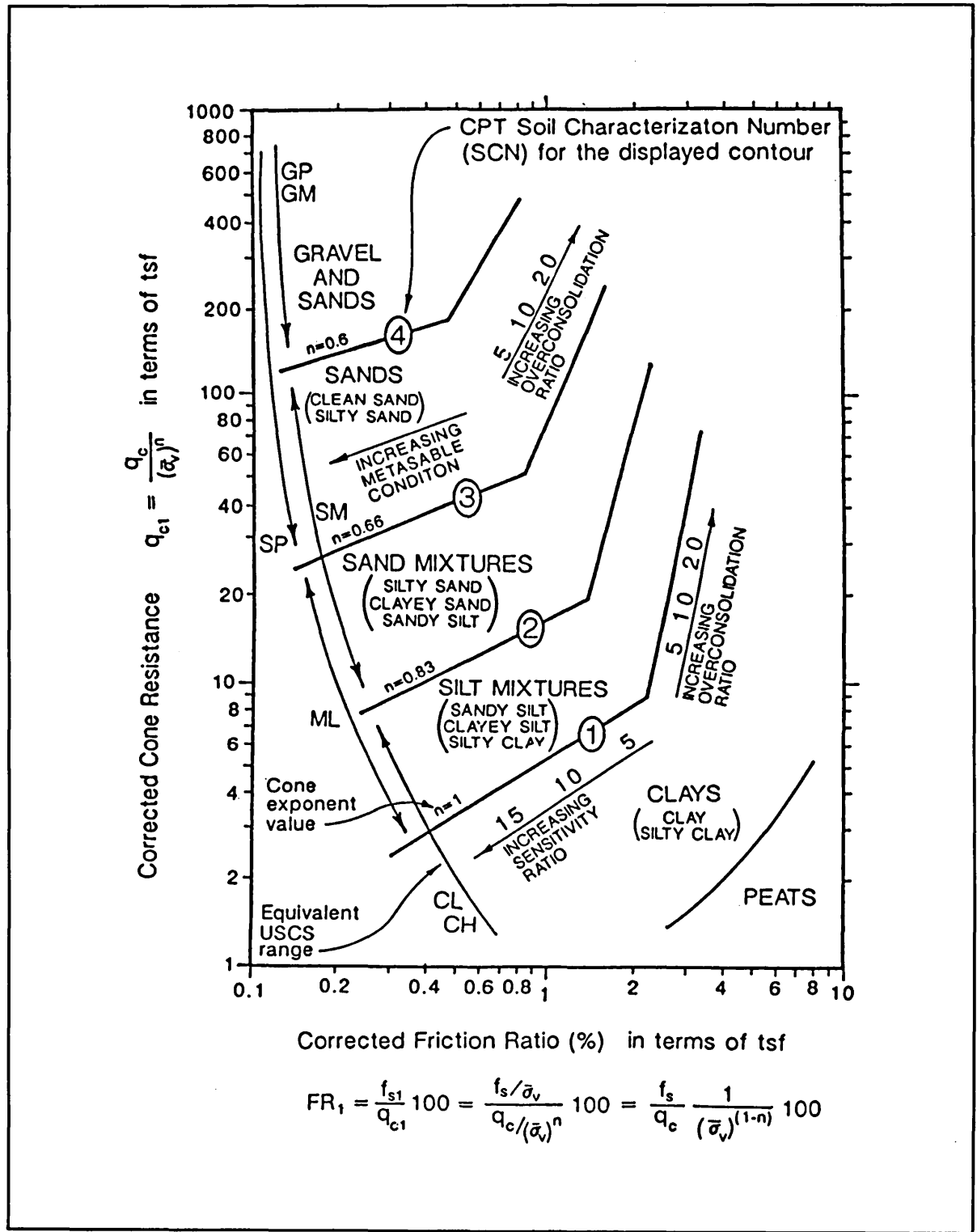

Figure 26. Estimation of soil description from CPT data (After Olsen and Malone 1988)



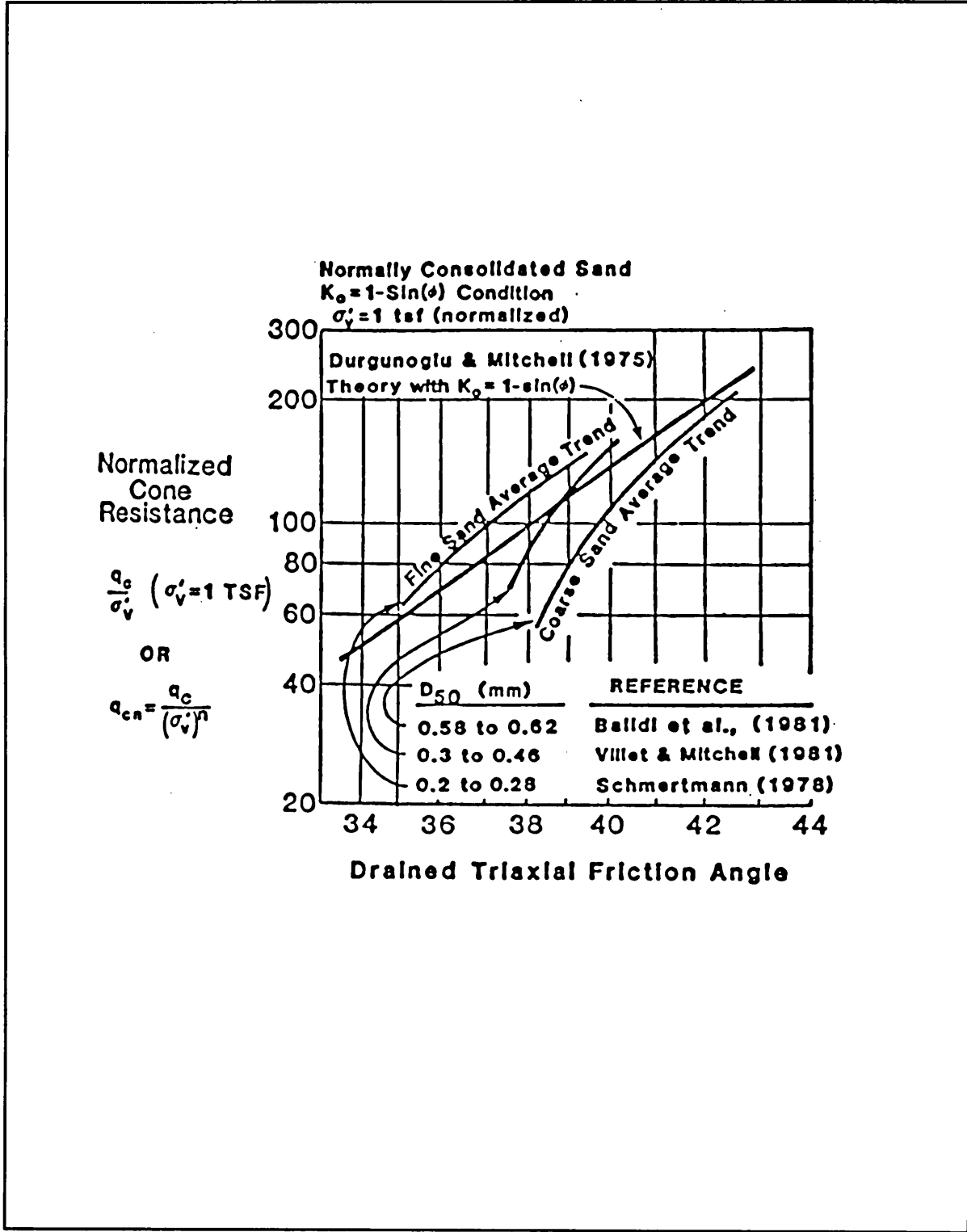

Figure 27. Estimation of angle of friction using CPT data  
 (After Olsen and Farr 1986)

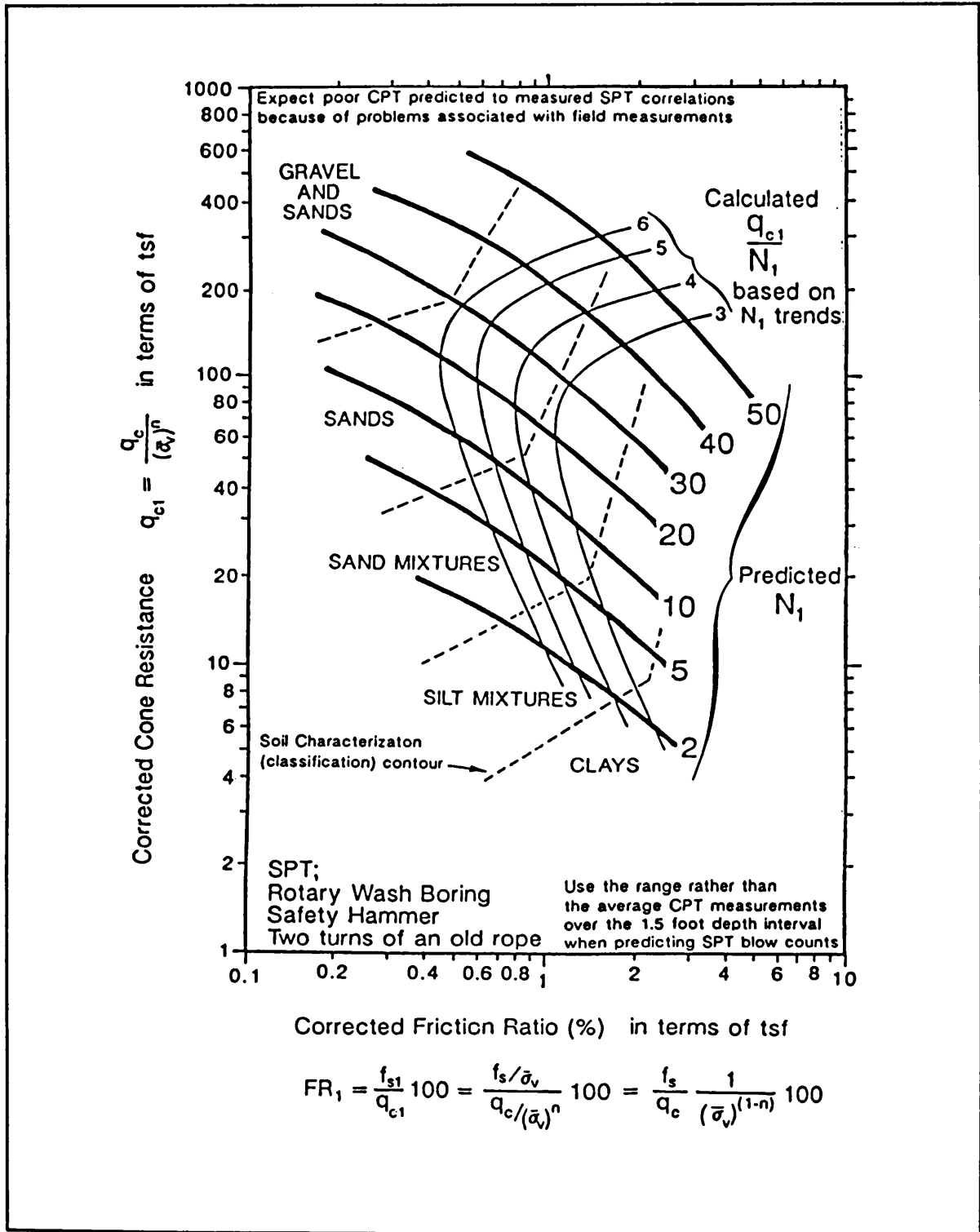

Figure 28. Correlation of CPT and SPT data (After Olsen and Malone 1988)

The value of bearing capacity factor,  $N_c$ , to use in Equation (5) has been examined theoretically and empirically (Schmertmann 1975). Values usually range from 12 to 20, with a typical value of  $N_c = 16$  recommended for general use (Olsen and Farr 1986) with the admonition that, where possible, an empirical correlation should be developed for local clays and CPT designs (Schmertmann 1975).

205. Underwater CPT Devices: Various devices have been developed for performing cone penetrometer tests (CPT) at sea, using a reaction frame resting on the seabottom (Zuidberg 1975). One of the most interesting of these is the Fugro unit described by Marr (1981) and Ruiter (1981). That unit is seafloor supported, can make continuous electric cone penetrometer profiles, and can take push tube samples of the soil. Unless it is anchored to the bottom, the weight of the total device must be sufficient to provide all of the needed force reaction. Muromachi (1981) has described a seafloor unit developed in Japan and a very sensitive cone capable of measuring the resistance of fluid mud.

#### Hand-held Sounding (Probing) Rod Test

206. Where successive strata vary widely in strength or hardness, the pushing or driving of a simple probing device, such as a rod or steel reinforcing bar, can be used to define the stratum changes with fairly good accuracy. This test method is particularly effective for a low-cost, rapid investigation of the surface of a hard layer or rock. No sample is obtained. Hand-held sounding, or probing, devices fall into several categories:

- a. Hand-pushed rods;
- b. Rods driven by a hand-operated drop weight (see Dynamic Penetrometer Test, Solid Cone); and
- c. Water-jetted rods.

207. Hand-pushed Sounding Rods. Steel rods, reinforcing bars, or similar devices, can be continuously pushed by hand into a soft or loose sediment. There is no need for a heavy reaction weight or the need to withdraw the rods after each test. In most circumstances, the operator can feel a sufficient change in pushing resistance to register a change in stratum hardness or type. This is particularly useful for very rapid searches for the surface of a hard layer or rock, overlain by a small thickness of soft or loose sediment, with the search conducted from a small boat.

208. If the sounding rod has an enlarged tip, is cased to reduce or eliminate sidewall friction on the rod, and the casing is pushed or driven concurrently with the rod so that very little of the rod extends beyond it, and the penetration resistance is measured, this test can be used to estimate the compactness or consistency of a sediment. Resistance to penetration can be measured by a force indicating device such as a proving ring, a calibrated spring, a Bourdon gage, or other suitable device. Accurate measurement of in-situ strength will require (a) a consistent testing procedure and consistent equipment, and (b) correlation of sounding rod penetration resistance with another standard method. With consistent testing procedure, this becomes the hand-operated Cone Penetration Test (CPT).

209. Weight-Driven Sounding Rods. Cone-tipped rods (penetrometers), or similar devices, can be continuously impact driven by a hand-operated drop weight rather than pushed, as in Figure 29. This obviates the need for a great pushing force or heavy reaction weight. In some instances, devices have been devised to perform either cone penetrometer probing or impact tube sampling (Haas 1983).

210. If the sounding rod is cased to reduce or eliminate sidewall friction on the rod, and the casing is driven concurrently with the rod so that very little of the rod extends beyond it, then the penetration resistance can be used to estimate the compactness or consistency of a sediment. Resistance to penetration can be measured by (a) the number of drops of the drive weight required to drive the rod a given distance, or (b) the distance the rod is driven for a specified number of drops of the drive weight. Accurate measurement of in-situ strength will require (a) a consistent testing procedure and consistent equipment, and (b) correlation of sounding rod penetration resistance with another standard method.

211. Water-Jetted Sounding Rods. A hollow metal rod, such a pipe or drill rod, can be used to

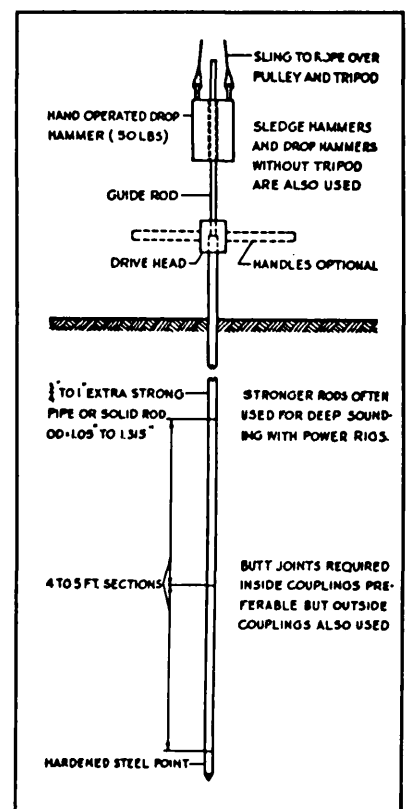

Figure 29. Simple light sounding rod (After Hvorslev 1949)

penetrate an easily eroded soil using a high pressure water stream. The jetting action will scour the soil, returning soil particles to the surface as in wash boring, permitting the sounding rod to easily be pushed into the soil until a hard layer or rock is reached. Penetration resistance is difficult if not impossible to measure; therefore, this method is not used to indicate strength except in terms of gross change in strength--such as going from loose sand to rock. This test method is particularly useful in locating the surface of a hard layer or rock in a fairly shallow waterway. Either fresh or seawater may be used in the pump. Pump size can be fairly small, permitting it to be operated from a small boat or other work platform.

#### Penetration Rate of Vibrating Tube Corer

212. It appears logical that the rate of penetration of a vibrating tube sampler should be related to the compactness of a cohesionless soil or the consistency of a cohesive soil. This methodology has not been thoroughly investigated nor has it received widespread acceptance. Babcock and Miller (1972) reported good results in field test to relate rate of vibro-corer penetration to the Standard Penetration Test N-values for sand.

#### Deceleration Rate of Gravity Projectile

213. Various types of tube samplers are available that are intended to penetrate the surface of an underwater soil deposit using their dynamic force as a projectile (see discussion of Gravity Projectile Samplers in Part IV of this report). As with all penetration testers, either static or dynamic, the resistance to penetration is a measure of the shear strength of the sediment. Assuming the mass of the projectile remains constant, it should be possible to employ Newton's Second Law that states the force is equal to the product of the mass and the acceleration ( $F = ma$ ). The penetration resistance is, therefore, directly proportional to the deceleration (negative acceleration) rate. Correlation is then needed between the deceleration rate (related to penetration resistance) and the strength of the sediment.

#### Laboratory Direct Shear Test of Redensified Sand Sample

214. Responding to the need for an estimate of granular soil density in a dredge hopper, the resuspended density test was developed in the late 1970's to early 1980's. This is a non-standard sedimentation type laboratory test. This method for estimating weight-volume relations for soils in a hopper hold has apparently been reasonably satisfactory in service. As performed in the

North Pacific Division laboratory, a 2000 ml clear plastic cylinder is filled about half depth with granular soil sampled from the project site, or taken from the hopper hold, and then filled with water. The soil is thoroughly dispersed through the water by agitation, after which the soil is allowed to sediment for about 24 hours. Following removal of the supernatant water, the final sedimented weight and volume of the soil is measured and the saturated density recorded as the "resuspended density."

215. The shear strength of a specific sand or coarse silt sample is a function of the initial density. Sands are generally not sensitive to remolding. Therefore, if a sample is tested at the resuspended density, reproduced in a direct shear box, it should reasonably well represent the shear strength of the sand in situ.

#### Pressuremeter, Marchetti Dilatometer, and Borehole Shear Tests

216. Several devices other than the VST, the SPT, and the CPT have been developed for estimating shear strength during foundation engineering site investigations. They include the Pressuremeter Test (PMT), the Marchetti Dilatometer (DMT), and the Borehole Shear Test (BST). The PMT and DMT are fairly new test methods that were developed primarily for measuring lateral stresses in soils, but have been extended to shear strength determination. The conduct of these tests requires a stable platform, delicate equipment, and highly trained personnel.

217. The Borehole Shear Test (BST) (Luteneger 1987) simulates the laboratory direct shear test on the walls of a boring. A normal force is applied hydraulically to two shear plates bearing on opposed sides of a bore hole; a shearing force is applied to the soil on the sides of the hole by a direct pull on the devices. Its intent is to measure the angle of internal friction directly on undisturbed soil. Like the laboratory direct shear test, drainage and volume change on the shear plane during shear is a function of soil permeability. In free-draining granular soils, the BST measures the drained shear strength; in cohesive soils, the BST measures the undrained strength (equivalent to the unconfined compressive strength). According to Luteneger (1987) the time required for a test sequence of three to four tests at different normal pressures ranges from 20 minutes to two hours, averaging about one hour. Great care must be used in preparing the boring and the equipment for the field test. The test procedure is sensitive to having a

smooth hole of constant diameter in the test area, which is difficult to achieve with common drilling methods.

#### Selection Among the In-Situ Shear Strength Test Methods

218. Schmertmann (1975) and a number of other geotechnical engineers have been very critical of Vane Shear Test (VST) and particularly of the Standard Penetration Test (SPT). They are proponents of the Cone Penetration Test (CPT), particularly the electronic cone and the piezo-cone, because of the wealth of continuous information this testing device yields in a foundation engineering investigation. The VST simulates an in-situ direct shear test of clay soils. Yet, the results require correction factors for plasticity index and for a number of other properties not yet fully understood. The SPT is a "non-standard standard test." Procedures, and even equipment, vary widely among users. Correlations with angle of friction and with relative density are of low precision, i.e., wide scatter of test data. Contractors interviewed for this report indicated confusion resulting from the use of nonstandard split barrel samplers (large size) during a site investigation.

219. Riggs (1986) argued for the SPT. He stated that: "Along with known weaknesses of the SPT, there are several advantages of the often used test as a practical engineering tool:

- a. Test procedures are relatively easy to follow, thus permitting rapid training of personnel and frequent, inexpensive testing;
- b. The equipment required to perform the SPT is simple and durable;
- c. A representative but remolded sample of soil is obtained simultaneously with performance of the test;
- d. The test can be performed in most soil types with the aid of a common soil exploration drill rig;
- e. The SPT can be performed during adverse weather conditions without significant effect on the test results; and
- f. The N-value of the test, i.e., the penetration resistance, in some cases is the only available soil test that has historically been used and can be interpreted readily with confidence, regardless of the accuracy of the application, by many practitioners . . . ."

220. Olsen and Farr (1986) presented argument for the CPT. Quoting from Olsen and Farr: "There are [several] major problems associated with the

conventional process of making soil borings, taking samples, and conducting laboratory soil tests:

- a. Soil borings are expensive to make;
- b. Soil samples are obtained continuously;
- c. Drilling and sampling can result in disturbed soil samples;
- d. Transporting, handling, cataloging, classifying, testing, and storing soil samples is expensive; and
- e. Soil identification can be subjective without numerous soil index properties tests."

About three times the test boring footage can be obtained with CPT than with SPT in the same time. However, when only a shallow depth is involved, the actual testing time is a very small part of the total time at a site and in moving from site to site. Total on-hole time is more of a concern than the time to make the boring and tests. In spite of claims to the contrary, it is still necessary to obtain representative samples of the soils to validate the CPT data and to determine the other laboratory tests such as organic content, specific gravity, and grain shape and hardness. This means that another suitable device, such as a vibrocorer, a projectile sampler, or a bucket auger (machine or hand operated), must be used to obtain representative samples.

221. Which test method, then, is the one to use to evaluate shear strength? The objective of the in-situ test is to indicate the suitability of equipment and the energy needed to erode, cut, or scoop a given soil. How that decision is reached is somewhat immaterial; it requires only that (a) the decision be reached with maximum confidence consistent with least cost, and (b) the decision be implemented in a way that rigorously complies with a well-known, preferably published, standard so there is no confusion as to what is being measured and what it may be appropriately correlated to.

#### Tests for the Rheologic Behavior of Soil Slurries

222. Cox, van Deursen, and Verhoeven (1986a, 1986b) define "silt" (fluid mud) as any clayey material with a high water content and with a shear strength below 10kPa (0.10 tons/sq ft) corresponding roughly to a density ranging from 1050 to 1400 gr/litre. Conversely, Meyer and Mahlerbe (1987) demonstrated that, at the nautical bottom, the threshold shear of virtually



all "muds" is less than 10 Pa (0.001 tons/sq ft), corresponding to an in-situ density of 1150 to 1350 gr/litre. They argue that the detection of the nautical bottom should be based on in-situ density as well as in-situ rheologic (vane shear) tests.

223. The relationship between yield stress (threshold shear strength) and slurry density depends on soil type, mineralogical composition, percentage of organic matter, and gas content (Cox, van Deursen, and Verhoeven 1986a, 1986b; Meyer and Mahlerbe 1987). Therefore, it must be determined for each soil type at the proposed project site that is expected to be pumped through a pipe. Figure 12 illustrates a typical relationship between yield stress and slurry density for various values of mud (silt and clay) content.

224. The determination of threshold shear strength and of viscosity is normally done in a laboratory using a viscometer. This device is essentially a laboratory vane shear tester in which a vane tip is inserted into a slurry of a specific composition and rotated while it slowly moves downward through the slurry so that the same soil is not continually tested. The rate of rotation is varied for viscosity determination. Because the relationship is dependent on solids concentration, on mud content, on the salinity of the water (which determines flocculation), and on the mineralogy of the clay particles, the variety of test conditions is nearly infinite. It is desirable, then, to establish an empirical relationship for all of these factors from tests on soils within a given region. Then, only the slurry density, fines content, and perhaps Atterberg limits tests need be made for comparison with the master nest of curves. A few check tests of laboratory viscosity will usually be needed to validate the empirical data.

225. For determination of navigation depth only, where only the threshold shear value is of interest, a sensitive field vane shear test device can be used in situ. Cox, van Deursen, and Verhoeven (1986a, 1986b) described a submersible vane shear device, using a multibladed vane, operated by a bottom-supported test frame. Meyer and Mahlerbe (1987) reported the use of a large rheometer suspended from cable on a vessel, operated electrically, with electronic recording of data at the surface.

## PART VII: FACTORS AFFECTING A SITE INVESTIGATION STRATEGY

226. The strategy, or plan, for a geotechnical subbottom investigation must consider three general factors that establish the necessary scope, i.e., the type and magnitude, of the study. The factors are:

- a. The site variability;
- b. The size of the sampling and testing program; and
- c. The value of additional information.

227. Some of the discussion in this part of the report contains a general treatment of geologic factors. Other parts of the discussion are a theoretical treatment of sampling statistics and decision theory. Details of these topics are beyond the scope of this report, but can be readily found in textbooks on geology and statistics. Among the more useful references in the published literature is Baecher (1987a) who discussed statistical site characterization. Baecher presented (a) a list of pertinent geotechnical engineering references on statistical site characterization, and (b) an assessment of statistical methods for the geotechnical aspects, including site characterization, of dam projects. Of particular significance is the retrospective assessment of statistical methods applied to the Carters Dam Project (Baecher 1987b).

228. The discussion given below represents an ideal. In the real world, because of the usual constraints of time and money and the lack of background information, it can only be approached but not reached. Even though the ideal cannot be reached practically, the planners and the ultimate users of a real geotechnical site investigation for a dredging project must keep the underlying geologic and sampling statistics factors in mind. In this manner, the weaknesses of the real site investigation can be recognized and the resulting information assessed accordingly.

### Factor of Variability of Natural Soil Deposits

229. The non-uniformity, or variability, in the properties of natural soils has been recognized for some time by geologists, sedimentologists, soil scientists, and geotechnical engineers. The literature of these disciplines contains many studies of soil property spatial variability, both horizontal and vertical, and of the variability of the testing processes themselves. The literature is so voluminous that it would be burdensome for this report to reference all of it. The variation of the measured properties of natural soil deposits is discussed, for example, by Terzaghi and Peck (1967); Peck, et al (1974), Harr (1977), Sowers (1979), Spangler and Handy (1982); Lee, White, and Ingles (1983), and Wu (1989).

230. The characterization of a single "homogeneous" soil deposit, for a single property (for example, water content or shear strength), is most effectively done by defining the trend line of local average values and the variability of individual test values about that trend line. All engineering measurements are made on a sample of the universe being characterized. The sample test results are then used to *estimate* the characteristics of the universe of possible test results for that soil. The capacity of the sample to provide a reasonable estimate of the universe parameters depends on the *size* of the sample and on the *variability* of the universe of sample values.

#### Definitions of Basic Statistical Terms

231. Assume, for discussion purposes, that the entire volume of an apparently "homogeneous" sediment deposit is of limited extent, so that no trend in values occurs, that it has been totally subdivided into an extremely large number of small portions, and that each sample portion has been tested for a soil property, water content for example. The totality of such measurements is called the *universe*, or *population*, of the tested parameter. The range of test results of the extremely large number of measurements can be divided into equally spaced classes. A bar diagram, or frequency histogram, can then be drawn showing the percentage of all the test results that fell into each class. Such a distribution of test data will most often have a shape similar to that of Figure 30. If the class limits are made very small, and the number of classes very large, then the shape of the histogram may be approximated by a smooth bell-shaped curve. A theoretical mathematical expression for such a shape results in the *normal* curve, also shown on Figure 30.

232. The mass of test data can also be characterized by a central value, the *arithmetic mean*, and by the dispersion about that value, the *variance*, or its square root, the *standard deviation*. In mechanics terms, the mean is the centroid of the frequency distribution about the vertical axis, the variance is equivalent to the second moment, or moment of inertia, of the class cells about the centroid, and the standard deviation is the counterpart of the radius of gyration. In this discussion, the notations of Hald (1952) and of ASTM (1992) Designation E177, "Use of Terms Precision and Accuracy as Applied to Measurement of a Property of a Material," have been combined. Although extensive references are made throughout this section of the report to the textbook by Hald (1952), most current books on statistics contain similar information. The basic measurement statistics can be calculated as shown in Table 23.

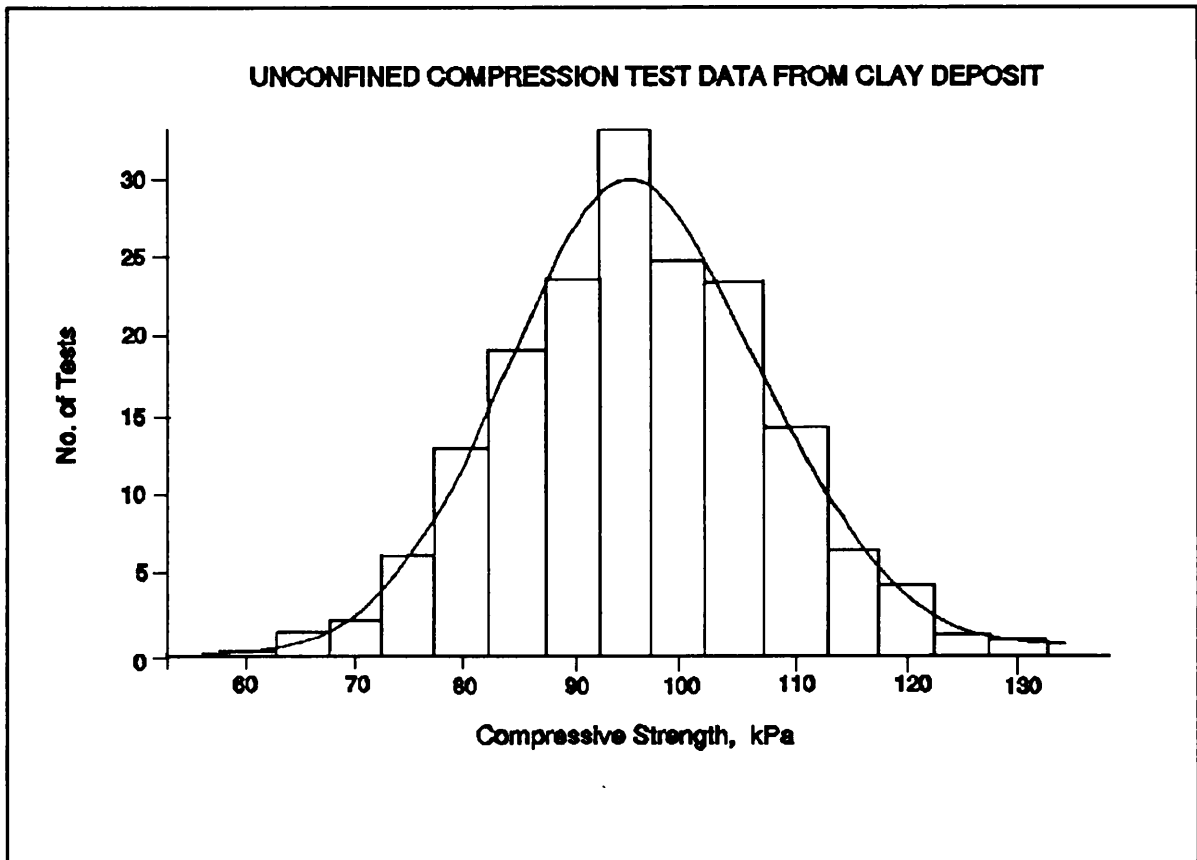

Figure 30. Frequency histogram of soil property test data

233. It can be shown that the probability that a randomly selected test value will have a deviation from the mean which is as large, or larger, than  $\epsilon = x - \bar{x}$  is the area of the frequency histogram, or the area under the normal curve, to the left or right of (outside of) the test value. For the theoretical normal distribution, about 68 percent of all test values taken at random will be within one standard deviation either side of the universe mean.

234. Variations from the mean, can be (a) random, (b) nonrandom, or (c) a combination of the two. *Random variations* occur without apparent aim or reason, determined only by chance. This uncontrollable variation results in test values that are clustered about a central, mean value and whose magnitude is defined by the variance, or standard deviation, of the data. *Nonrandom, or systematic variations* are due to some significant, assignable cause, or causes. The cause of a nonrandom deviation may be abrupt, such as a change from one soil type to another in a vertical profile. Or it may be gradual, such as the variation that often occurs in the character of a soil horizontally in a soil layer.

Table 23  
Definitions of Basic Statistical Terms

Arithmetic Mean (Arithmetic Average)	$\bar{x} = \frac{\sum x}{n} \quad (6)$
Variance, Large Samples	$\sigma^2 = \frac{\sum (x - \bar{x})^2}{n} = \frac{\sum \epsilon^2}{n} \quad (7)$
Variance, Small Samples (size n = 30 or less)	$s^2 = \frac{\sum (x - \bar{x})^2}{(n - 1)} = \frac{\sum \epsilon^2}{(n - 1)} \quad (8)$
Standard Deviation	Square root of variance
Coefficient of Variation (expresses standard deviation as percentage of the mean)	$V = \frac{\sigma}{\bar{x}} \quad (9)$
where:      x = numerical value of a measurement n = number of individual measurements in the sample $\Sigma$ = mathematical symbol for summation from one to n $\epsilon$ = deviation of an individual measurement from the mean	

Sources of Variability

235. Variation in the measured test results of a soil sample from the average value for the soil mass stem from three causes: (1) natural variations in the composition of the material, (2) natural variations in the deposition process, and (3) variations due to the sampling and testing process.

236. Material composition variability: All natural soils are the product of the weathering of rock, either physical breakage and abrasion or chemical decomposition. Within a local, homogeneous soil deposit, where the deposition process has been constant, random variations occur because of the heterogeneity of the parent rock and the non-uniformity of the degradation process. Grain size distribution, mineralogy of the coarse grains, clay mineralogy and surface forces, and the nature of the pore fluid in the soil are material composition variables. Natural weathering processes tend to be uniform only within a relatively small, local area where all environmental conditions are relatively constant.

237. Deposition process variability: Variations occur because of changes in the geologic processes of erosion, transportation, and deposition. In a soil of constant composition, depositional processing affects void ratio (unit weight or density), degree of saturation, the flocculated or dispersed structure of the clay fraction, the shape of the coarse grains, the gradation of the coarse grains, the clay content, and the shape and arrangement of the pore spaces. All of these factors determine the in-situ shear strength of the soil. Spatial variation in soil properties, vertically and/or horizontally, can occur gradually or abruptly. In soil sediments, vertical changes tend to be gradual within a soil layer and then to be abrupt as a new soil type (layer) is encountered. Lateral changes in the character of a soil, referred to as facies changes by geologists, tend to be relatively gradual, reflecting the lateral changes in the depositional process.

238. Examples of deposition process variation in the character of a soil occur in riverine deposits. A bend in a river, such as the Mississippi, usually produces point bar deposits, silt and clay filled swales, and intermittent gravel deposits. Cutoff meanders of the river are often filled with clay. River floodplains may contain alternating layers of silt and clay, sometimes underlain by sand. Lake deposits often contain alternating layers of sand, silt, and clay; these are often organic. Marine shore deposits may be complex or simple, dependent on geologic origin. Geology and geotechnical engineering publications should be consulted for further discussion of this topic.

239. Measurement process variability: The specific technique for obtaining a soil sample and performing a soil test will involve several factors that may result in both nonrandom and random variations in test results. Changes in significant details of procedure and/or instrumentation, in the testing technician, in technician fatigue and/or motivation, and in ambient conditions may cause a systematic, or bias, error. The measurement process may be considered to include the soil sampling process. Therefore, changes in sampling technique or equipment can result in non-random variation. Even if all conditions are held constant, repeated tests on the same test portion by the same technician, using the same equipment and procedure will result in randomly varying test values. These are due to the unassignable and uncontrollable accumulation of small variations that are part of any sampling and testing process.

240. Within any given homogeneous soil deposit, test measurement of any given soil property cannot normally differentiate between material and depositional variations and variations due to the measurement process. Therefore, in characterizing a deposit:

$$\sigma_o^2 = \sigma_m^2 + \sigma_d^2 + \sigma_t^2 \quad (10)$$

where  $\sigma_o^2$  = overall test measurement variance  
 $\sigma_m^2$  = variance due to material composition variation  
 $\sigma_d^2$  = variance due to deposition process variation  
 $\sigma_t^2$  = variance due to testing process variation

241. Table 24 contains data on the measured coefficient of variation for various geotechnical soil tests as compiled by Lee, White, and Ingles (1983). The recommended standards for coefficient of variation are based on a large number of published reference sources. Each data source presumably represents a "homogeneous" soil deposit and the ranges of coefficients of variation represent natural variations due to a combination of natural soil material and soil mass properties with variations due to the sampling and testing process. A coefficient of variation is, basically, a way of normalizing the standard deviation by expressing it as a percentage of the mean, permitting rational comparisons. For specific gravity and for density, it is low (1 to 10 percent), reflecting uniformity of the test process and of the mineralogy of grains in a limited area. For unconfined compressive strength, on the other hand, the coefficients of variation in the table range from 6 to 100 percent, indicating a high variability in the measured data. The value of using tests from one or two random specimens from any such stratum to be "representative" of the average (mean) test value of the layer can be judged from studies such as these. Lee, White, and Ingles (1983) observed that: ". . . it is common to find a coefficient of variation of about 10-25% in the measurement of soil properties, and therefore, values exceeding 25% should suggest caution . . . in the use of that particular test method . . ."

#### Trend Lines by Linear Regression Analysis

242. Regression analysis is used to evaluate the nonrandom trend relationship between data pairs (x, y) resulting from an experiment by employing the method of least squares. The simplest and most used method fits a straight line to the data. In a site investigation, the dependent variable is usually the result of a soil test and the independent variable is distance, either length or depth. The theoretical development of the method of least squares is given in most textbooks on statistical methods and the interested reader is referred to them for the derivations.

Table 24  
Coefficient of Variation for Geotechnical Soil Tests\*  
 (After Lee, White, and Ingles, 1983, Table 2.4)

Geotechnical Test	Reported Range of Coefficient of Variation (%)	Recommended Standard Coefficient of Variation (%)
Angle of friction: Sands Clays	5 - 15 12 - 56	10 Wide variation
Clay content	9 - 70	25
Cohesion (undrained) Sands Clays	25 - 30 20 - 50	30 30
Density	1 - 10	3
Liquid limit	2 - 48	10
Moisture content	6 - 63	15
Permeability	200 - 300	300
Plastic limit	9 - 29	10
Plasticity index Sandy soils Clayey soils	7 - 79	70 30
Sand content	1 - 43	20
Specific gravity	1 - 10	3
Standard Penetration Test	27 - 85	30
Unconfined Compressive Strength	6 - 100	40
Void ratio (and porosity)	13 - 42	25
* Coefficient of Variation is defined in Equation (9).		

243. In an experiment of finite size, the method of least squares fits the data with a straight line:

$$y = a + bx \tag{11}$$

where

- y - dependent variable
- x - independent variable (no random variation)
- a - y-intercept
- b - slope of the line



244. The random fluctuation of individual test values about the least squares fitted line is given by the *standard error of estimate*:

$$S_e^2 = \frac{\sum \epsilon^2}{(n - 2)} \quad (12)$$

where  $S_e^2$  = standard error of estimate.  
 $\epsilon$  = random deviation of an individual y-value, in the y-direction at a specific x-value, from its calculated value on the line,  $y = a + bx$ ; the independent variable (x = length or depth) is assumed to be without error.  
n = number of data pairs (x,y) in the sample.

The square root of the standard error,  $S_e$ , is basically the standard deviation of test values about the line. The concepts discussed above are depicted on Figure 31.

245. Figure 32 shows linear regression lines fitted to test data representing the vertical variation of shear strength (one-half of the unconfined compressive strength) in an offshore deposit of clays at the Craney Island Disposal Area, Norfolk, Virginia. Seventeen test values are available from a 1949 site investigation and nine test values from a 1971 site investigation, made before and after placement of dredged material in the containment area. The scatter of test data about the mathematically fitted lines indicates the combination of (a) the natural random variation in soil material and mass properties within the clay deposit and (b) the variation in the sampling and testing process. The initial (1949) sloped line indicates a typical gradual change in strength with depth and the change in position of the "least squares" lines indicates an increase in strength due to consolidation under the increased load. A statistical analysis of the data for confidence intervals, using the concepts illustrated in Figure 31, for both intercept and slope of the lines,  $y(\text{strength}) = a + b x(\text{depth})$ , indicates that the 1971 values almost certainly indicate a real change in strength. That is, the difference in intercept and slope could not have occurred at random due to the small sample size. Therefore, either (a) there really has been a change in the strength profile with depth between 1949 and 1971, or (b) the relationship of strength with depth is nonlinear (curved), or (c) there is more than one layer (deposit) present, requiring separate analyses. Verification of these alternatives would require a larger sample size, i.e., more tests.

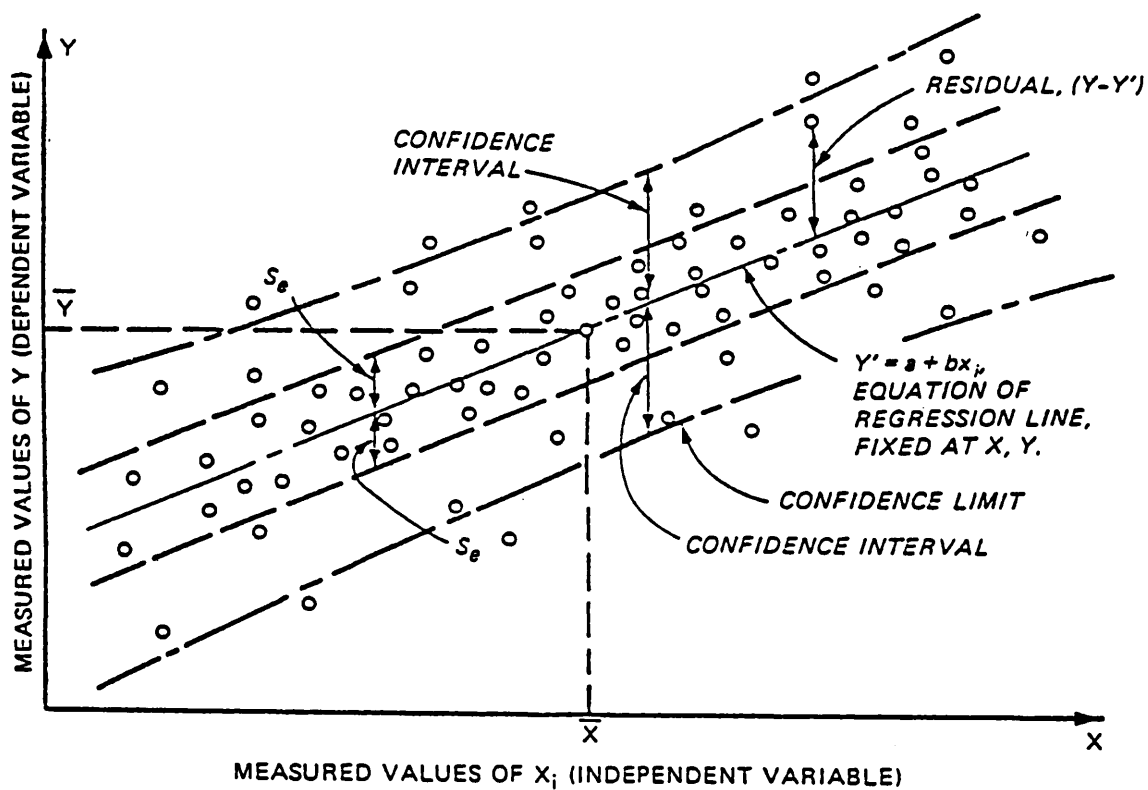
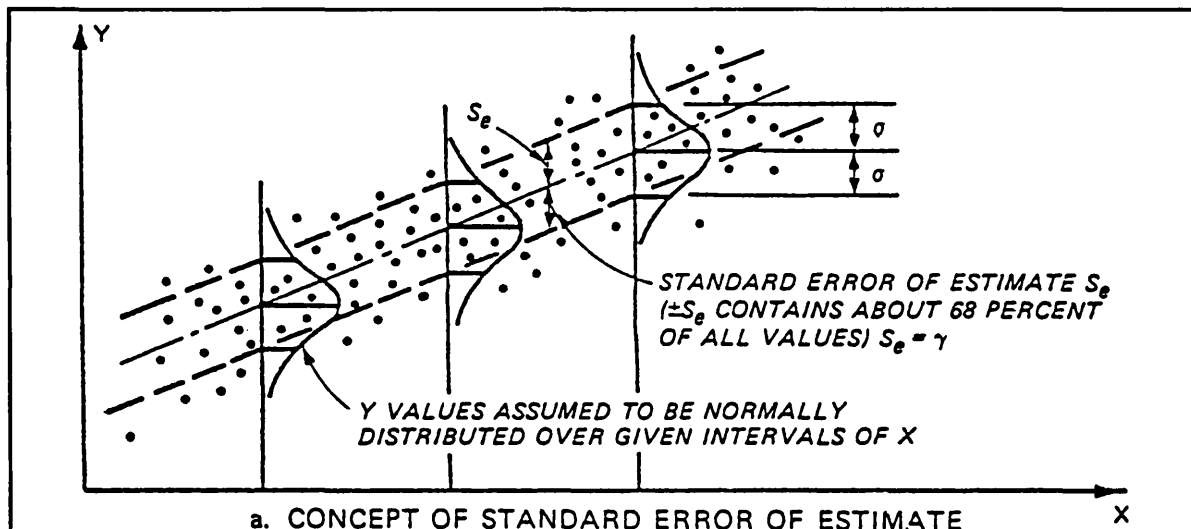

b. CONCEPT OF LINEAR REGRESSION LOAD

Figure 31. Concepts of regression analysis

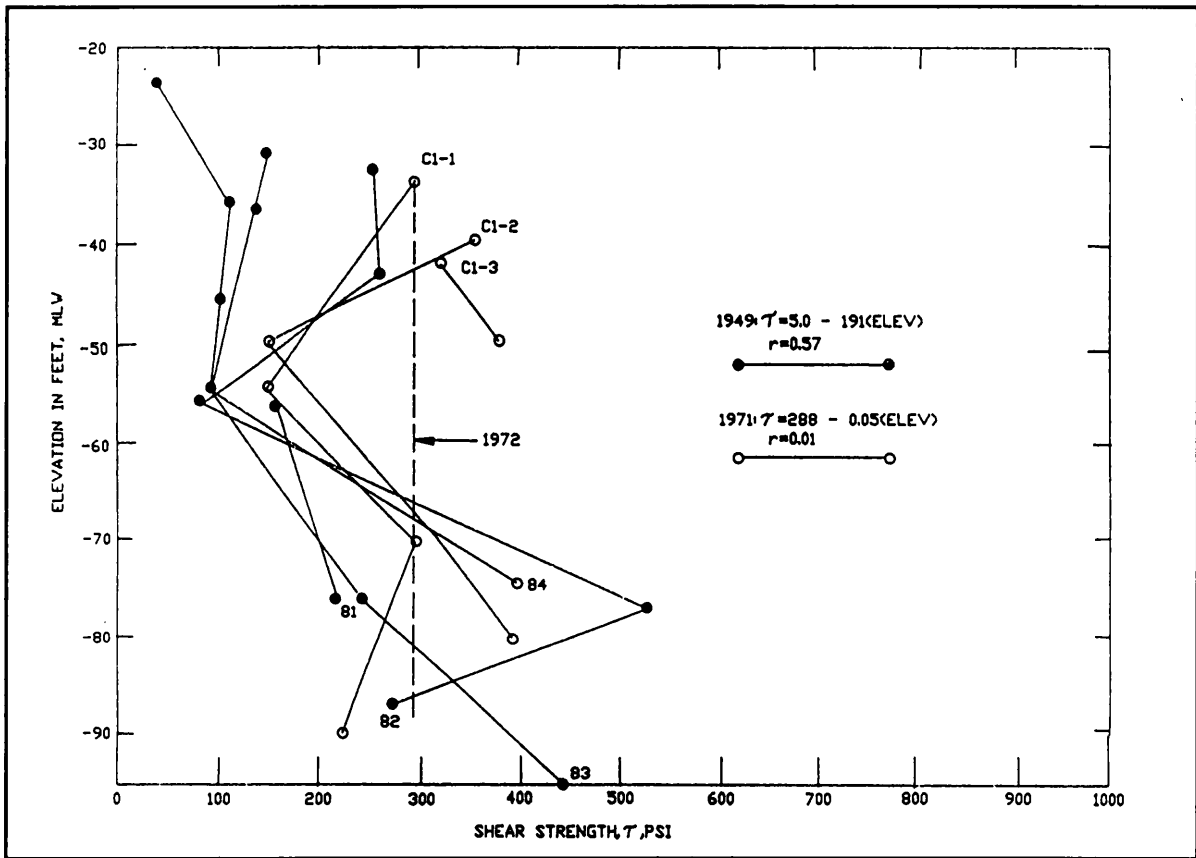

Figure 32. Variation in strength with depth in a marine clay

246. Lateral variations, with distance for a soil material property (for example, in-situ density,  $d_{50}$ , etc.) may also be portrayed by "least squares" regression lines. The regression lines are indicative of nonrandom, assignable variation in soil properties as a function of distance. A horizontal or slightly sloping line shows uniformity with distance. This would be expected, for instance, for a grain-size characteristic (e.g.,  $d_{50}$ , percent pass No. 200 screen, etc.) of maintenance material from a major river, such as the Mississippi or the Columbia. A steep line demonstrates a fairly rapid change in soil character; this might occur, for example, in a beach deposit. A rapid change in the slope or position of a fitted line with distance indicates a facies, or material type, change. This might occur laterally in a river bend or in a river delta. Again, the scatter of test points about each line shows the random variation that occurs because of local material and mass properties and testing variability.

## Factor of the Sampling and Testing Program

247. The amount of information needed to reduce uncertainty in site characterization to an acceptable level is a function of the complexity of the soil deposits at the site. If, in an idealized case, the entire project consisted of one soil type with a uniform set of properties (low universe standard deviation) and no variation with distance, then only one sample would need to be tested. As site characteristics become more complex, the amount of site investigation effort, i.e., the number of borings and samples, needed to reduce uncertainty increases. There is a maximum to the curve of amount of site investigation effort that is useful vs. complexity of site properties. If the site is highly complex and heterogeneous, the amount of necessary site investigation effort drops because no reasonable amount of site exploration can characterize the site adequately. In that case, there need only be sufficient site investigation effort to establish, to a reasonable level of certainty, that the site is highly complex.

### Definitions of Terms

248. A *deposit* is defined as a limited quantity of soil of essentially uniform composition and produced by essentially the same deposition process. There will be a number of such deposits within the typical dredging-related subsurface investigation. Every deposit of natural soil will have a random distribution of test data for any given soil property about the local average and a systematic, or assignable, deviation of the average values as a function of distance, vertical or horizontal.

249. Obviously, the entire deposit cannot be sampled and tested. A *specimen*, or *sample unit*, is a small portion of the soil taken from a deposit for the purpose of testing or visual inspection. That part of each sample unit actually tested is called a *test portion*. The test results form the basis for judging, or estimating, the characteristics of the deposit. When test results from several sample units are combined mathematically into a *sample*, the sample average is an estimator of the deposit average and the sample variance is an estimator of the deposit variance. The locations of sample units selected to represent the deposit can be established by (a) experience, judgement, or policy, or (b) statistical random selection.

### Judgement Sampling

250. Judgement sampling has been the traditional engineering method, based on a deterministic (non-statistical) attitude toward variability and the concept of the "representative" sample. The careful selection of a single sample unit, or the use of multiple sample units, with elements of the sample units blended into a single sample portion, has been used as a *representative sample* of the whole, i.e., a sample of the "average" of a section of the deposit. The judgmental selection of the sampling location(s) is usually left

up to the sampler, or his superiors, making the entire process dependent on the validity of his judgement, with its inherent tendency toward bias. Often, the sample portions actually selected for testing are the "poorer" ones, resulting in an additional measure of conservatism on the part of the evaluator.

251. Unfortunately, the single sample unit or the blending process does not yield a sample variance by which an estimate can be made of the deposit's variance. Without that value, no evaluation can be made of the nearness of the "representative" test result to the actual universe value can be made. As stated by Deming (1950): "Judgement samples . . . are not amenable to statistical analysis. ". . . (there is) no way to remove the biases of selectivity, availability, . . . , and incorrect assignment of weights. "The usefulness of data from judgement samples is determined by expert knowledge of the subject matter and comparisons with the results of previous [investigations] . . . , not from the knowledge of probability. Such remarks are not meant to imply that judgement samples cannot and do not deliver useful results, but rather that the reasons why they do when they do are not well understood."

#### Random Sampling

252. Whether intended or not, every sample used to estimate deposit universe parameters is a statistical sample. All units of a *random sample*: (a) must be selected without bias or prejudice, (b) all conditions must be the same for all items in the sample, (c) there must be no underlying differences between areas from which the sample elements are selected, and (d) the components of the sample must be completely independent of one another. Statistical random sampling is essential for securing a sample whose parameters will be used to estimate the average and variance of the universe from which it was taken. Hald (1952) has described several designs of sampling plans: uniform random sampling, systematic sampling with a random start, and two stage sampling. Each of these plans deals with sampling from a single "homogeneous" universe, or block.

253. The *uniform random sample* makes every potential sampling unit in the block equally likely to be selected. Uniform random sampling does not provide efficient coverage for obtaining information on systematic trends in soil properties over the length, area, or volume sampled. Some zones of the deposit will have a different standard error of estimate than other zones because of the random, non-uniform sample density, or numbers of sample units.

254. When the soil deposit to be sampled contains well-defined subsections, each with its own distinct mean and variance, but a single estimate of mean and variance for the whole is desired, then stratified sampling may be used. *Stratified random sampling* involves taking random samples from each stratum with sample sizes (number of sample units) *proportional* to the length,

area, or volume of the several subsections. If the systematic variation in soil characteristics for a deposit over a site is fairly uniform, but random variation is not, subdividing the deposit into subsections, or strata, for sampling permits sampling economy by maintaining a consistent sampling variance.

255. An often used sampling method is *systematic sampling with a random start*. This method involves the selection of successive sample units at uniform intervals of length, area, or volume. It is argued (Hald 1952) that if the first sample unit from that universe is randomly selected, then all successive sample units are randomly located also. Baecher (1983) has observed: "The advantages of such plans are that they are easy to design and administer, little time is lost in locating test positions, and at first glance they seem to provide better coverage of the site than do other plans. From a statistical standpoint of view this last advantage is at times fallacious, however systematic sampling in many cases leads to higher probabilities of detecting inhomogeneities in a . . . (soil) mass than do other plans."

256. The basic premise of *two stage sampling* is that the primary deposit can be rationally divided into discrete zones. A random selection is made of the zones to be sampled and a secondary random selection of sample units is made from each primary zone selected. This is useful when the sample borings are considered as the primary zones, each boring being located in the soil deposit in a uniform random manner or in a systematic manner with a random start (see discussion above). Then, within each soil stratum in the boring, the secondary sample units are located vertically at random. Deming (1950) and Hald (1952) discussed this method with respect to secondary sample size (number of sample units) as a function of the cost of obtaining a primary sample unit (boring or pit) and the cost of sampling and testing each secondary unit (soil sample and test). The greatest efficiency found, assuming equipment mobilization, sampling, and testing costs are the same, occurs in sampling only one secondary unit from each primary unit. A similar analysis, comparing the indirect costs of moving to and making a boring or pit and the cost of obtaining and testing soil sample units may be very instructive.

#### Selection of Sample Size

257. The total number of sample units needed from each soil deposit can be established by (a) judgement, experience, or requirement, (b) by classical statistics, or (c) Bayesian statistics. Classical statistics tells us how large a sample is needed for "no prior" information. Bayesian, and other strategies, let us continually monitor the sample size as information is developed. Because judgement can best be understood in terms of classical statistics, that topic will be covered first.

### Sample Size by Classical Statistics

258. The confidence interval for all randomly chosen future values of the dependent variable,  $y$ , at a specific value of the independent variable,  $x_0$ , is given by:

$$E = t S_e \sqrt{1 + \frac{1}{n} + \frac{(x_0 - \bar{x}')^2}{(n \sigma^2)}} \quad (13)$$

- where
- $E$  - the maximum expected difference between any future  $y$ -value and the true universe average  $y$ -value at the level,  $x = x_0$ , i.e., the confidence interval
  - $t$  - a probability factor, from "Tables of Student's  $t$ ", based on the chosen confidence level and the sample size
  - $S_e$  - standard error of estimate for the regression line at  $x = x_0$  (see Equation 12)
  - $n$  - number of sample units in the total sample
  - $\sigma^2$  - The estimated true value of the  $y$ -value universe standard deviation; may be estimated by the sample standard deviation

259. The **confidence level** is the probability that the difference between any new value of the dependent variable,  $y$ , at any given value of  $x_0$ , and the real (but unknown) universe mean at that value of  $x_0$  ( $y$ -value on the true regression line) will not exceed  $E$ , the confidence interval. By chance alone, most of the new  $y$ -values of the infinite number of sample units that might be taken will be clustered closer to the universe regression line than the confidence interval would indicate. There is, however, a small but finite probability (the confidence level) that the difference between any new  $y$ -value and its corresponding position on the regression line can be as large as the confidence interval.

260. Equation (13) can be solved, by successive approximations, for sample size  $n$  if (a) an acceptable level of  $E$  is stated, (b) if the probability, or confidence level, is stated, and (c) the universe standard error of estimate and the universe standard deviation are known or can be reasonably estimated. The latter values can be estimated from historical records for similar soils in similar geologic areas or from regression line data for a sample of size  $n$  data pairs. If new experimental data is to be developed, then an iteration process must be used in which  $n$  sample units are tested and the sample standard error of estimate and sample standard deviation are determined. Equation (13) is then solved for a new value of  $n$  to satisfy the required confidence interval at the specified confidence level and the process continued until reasonable convergence is reached. Values of Student's  $t$  are dependent on both probability level and sample size. However, as the

sample size,  $n$ , approaches and exceeds  $n = 30$ , then the value of  $t$  becomes constant and no longer a function of size,  $n$ .

261. When the systematic variation with length in the soil deposit is very small, or non-existent, the slope of the regression curve becomes flat. Then the numerator of the final term under the radical in Equation (13),  $(x_0 - x')^2$ , tends to zero. In that case, the confidence interval is the same as that for a single, "homogeneous" universe of the type shown in Figure 30.

#### Sample Size by Judgement or Requirement

262. If the universe of test results for a given test method from a soil deposit has a frequency distribution similar to that shown in Figure 30, then the distribution of test data for individual sample units has an average and a standard deviation. If a single sample unit is taken, at random, to be "representative" of the average of that universe, what is the likelihood, or probability, that the sample value will be close to that of the universe? Or that the difference (error) will be as large as one, or two, or even three standard deviations? If the standard deviation for the universe of that soil test parameter for that soil deposit is small (low coefficient of variation), then the single sample may be reasonably close. If the coefficient of variation is relatively high, however, a single sample may not estimate the universe average very well; and the magnitude of the error is unknown.

263. If, then, a sample of size  $n$  is judged or specified to represent a soil deposit that has a true regression line and a true standard error of estimate, Equation (13) shows that the confidence interval, with a "confidence level" probability of including the universe regression line, is established. The choice of any two of the three factors (sample size, confidence level, and confidence interval) determines the remaining one. This relationship is dependent on a random selection of sample units. If the sample units are selected with bias or prejudice, as is often the case, then the confidence interval is greater, or the confidence level lower, or the necessary sample size is larger.

#### Sample Size for Comparing Alternative Tests

264. Alternative test methods, field and laboratory, are often available for estimating the same engineering property or soil index property of interest. The usefulness of one test method versus an alternative depends on the sample size of each test required to give an equivalent confidence interval at a constant confidence level. If the test methods are equivalent in usefulness, the choice between alternatives can be made on the basis of relative cost to secure and test the two samples. The cost of a test result from a given technique must include the cost of mobilizing the equipment, of obtaining the required number of sample units, transporting them, testing the sample portions, analyzing the sample data, and reporting the results.



265. In the relationship between sample size (number of sample units in the sample), probability (confidence) level, and confidence interval discussed in paragraphs above, one factor was the standard deviation (or the variance) of the universe of test values for the chosen soil parameter. Variances from various sources are additive, but standard deviations are not. The overall variance of test results includes the combined effect of the material quality variance and the variance due to the testing process, assuming there is no systematic error present in either the material quality or testing method effects. The overall variance, defined above in Equation (10), may be given as:

$$\sigma_o^2 = \sigma_q^2 + \sigma_t^2 \quad (14)$$

where  $\sigma_o^2$  = overall test measurement variance  
 $\sigma_q^2$  = variance due to material quality, i.e., combined variance due to material composition and placement process variability as in Equation (10)  
 $\sigma_t^2$  = variance due to the testing process

266. If the standard deviation of a particular testing process,  $\sigma_t$ , is known or can be estimated, its relative effect on the overall test parameter standard deviation,  $\sigma_o$ , can be evaluated (Hald 1952) from Equation (14). As an example, if the testing process is precise, with a low standard deviation (testing variance is small), then Equation (14) indicates that the overall measured variance will be only slightly larger than the material quality variance. If the testing process is not precise, with a high standard deviation, (high testing variance) then the overall variance will be somewhat higher than the material quality variance. Therefore, using Equation (13), the same confidence interval at the same confidence level, can be achieved simply by using a larger number of sample units (sample size) for the less precise test than for the more precise test method. If the confidence interval and confidence level from both test methods are equal, then a sample of size  $n_A$  using Test Method A is equivalent to a sample of size  $n_B$  using Test Method B. One major criterion for using Method A or B is the relative cost of testing samples of the equivalent sizes.

267. One objective of the site investigation is to identify a change in soil type, or a significant change in universe average for a given soil parameter. Differences in soil types are generally much larger than the random variation of a sample of even rough field or laboratory tests. The amount of change in a universe average that can reliably be detected is a function of sample size, universe variance, and probability level. Even with relatively crude (high standard deviation) test methods, the discrimination

capability is high if the number of sample units is high. Given an equivalence in standard error of estimate,  $S_e$ , from Equation (12) and combining it with the concepts of Equation (14), then it can be concluded that a large number of simple, less precise soil samples and test methods, suitably calibrated, are preferable to a smaller number of sophisticated, very precise tests. They serve both statistical functions: (1) estimation of the universe average and variance with a chosen precision, and (2) identification of changes in universe characteristics. The greater coverage of area and depth with the greater samples size provides a greater chance of finding significant changes in soil properties, signifying a change in soil type or character.

### Bayesian Statistics

268. The classical statistical methods discussed above assume there is no prior information regarding the characteristics of the dredging site. Therefore, all information about the universe of values for any specific soil property is determined as a result of the current sampling and testing data. Another philosophic approach that has been developed within the past few decades uses Bayes' Theorem, which is stated as

$$p\left(\frac{B_i}{A}\right) = \frac{p\left(\frac{A}{B_i}\right) p(B_i)}{\sum p\left(\frac{A}{B_i}\right) p(B_i)} \quad (15)$$

and which is read as: The probability of the occurrence of an event,  $B_i$ , given that another event,  $A$ , has occurred is equal to the probability of event  $A$  given that event  $B_i$  has occurred times the probability of event  $B_i$  occurring divided by the summation of all possible values of the probability of event  $A$  given that an event  $B_i$  has occurred times the probability of  $B_i$  occurring, where  $i = 1, 2, \dots, n$ .

269. The probability  $B_i$  is called the "prior" probability, established before any sampling and testing, based on available information. The joint probability of both event  $A$  and event  $B_i$  occurring is the numerator of Equation (15) which reflects the outcome of an experiment in which event  $A$  occurred. The value of the quotient,  $p(B_i/A)$ , is the "posterior" probability, which is now a revision of the prior probability,  $p(B_i)$ , considering the additional information that event  $A$  has occurred.

270. As a simple example, consider a fictitious site investigation. Within the dredging prism, only two soil deposits are present: (1) a sand deposit with clay lenses, composed of 70% sand and 30% clay, and (2) a clay deposit with sand lenses, composed of 80% clay and 20% sand. A study of local geology leads us to believe the sand deposit occupies 1/3 of the dredging

prism and the clay deposit  $2/3$ . The prior probability of selecting a sample of sand at random is, therefore,  $p(B_s) = 0.333$  and the probability of randomly getting a clay sample is  $p(B_c) = 0.667$ . Within the sand deposit, the probability of selecting a sand sample is  $p(S/B_s) = 0.7$ . The joint probability of randomly selecting the sand deposit and then selecting a sample of sand in the sand deposit is  $0.333 \times 0.7 = 0.233$ . Similarly, the joint probability for both a sand sample and the clay layer is  $0.667 \times 0.2 = 0.133$ . A random sample of sand is obtained during the site investigation without knowing if it came from the sand or the clay deposit. What is the probability it was sampled from the sand deposit? The probability of the occurrence of the sand deposit given that a sample of sand has occurred is equal to:  $p(B_s/S) = 0.233 / (0.233 + 0.133) = 0.637$ . Therefore, on the basis of the single sample of sand, the decision that the sand deposit had actually been sampled has a probability of 0.637 of being correct, and of 0.363 of being wrong. An additional sample would obviously be of value. But, if these probabilities had been developed, and the conclusion stated, after 101 samples, then would another sample be of great value?

271. In the Bayesian process, new knowledge about a proposed dredging site is used to revise a prior estimate of the value of specific properties. Quoting from Spurr and Bonini (1967): "The Bayesian approach . . . serves as the completion of the classical theory of statistical inference, through providing the decision-maker with a logical framework within which to apply both his judgement and sample evidence, in proper proportions, to the economic consequences of his possible actions." This process closely follows the stages of a site investigation discussed above. An estimated soil profile is developed from prior records and knowledge. The prior information from a maintenance work project is much greater than in a channel deepening project, which in turn is much greater than in a completely new channel. New sampling and testing data are combined with the existing information to update the previous soil profile. Additional information is added to the mounting amount of prior information until an acceptable confidence level is reached regarding the nature and location of the soils in the dredging profile. If the prior information is close to reality, then the additional geotechnical data will not change the probabilities very much. On the other hand, if the prior information is poor, as in the simple example given above, even a few tests will dramatically change the probability levels.

272. Bayesian statistics has been extended beyond the simple probability example given above. Applications to normal distributions in engineering and business management have been discussed in such textbooks as Benjamin and Cornell (1970), Miller and Freund (1977), and Spurr and Bonini (1967). Bayesian methodology is not a panacea for a site investigation strategy. Actual numerical definition of prior probabilities is a matter of

personal capability and knowledge and is difficult if not impossible to quantify. The Bayesian process comes close to the actual intuitive process used by anyone involved with the geotechnical aspects of a dredging project. The prior probabilities are, in actuality, judgement calls and, hence, will differ from one decision-maker to another among the owners, geotechnical engineers, and dredging contractors.

#### Factor of the Value of Additional Information

273. In preparing a bid, the dredging contractor is faced with risk from a number of unknowns, including all of the weather, personnel, fuel, and equipment factors. The risk factors also include the geotechnical risk, i.e., the soil types expected to be encountered, the difficulty of dredging them, the cost of mobilization of the wrong equipment for the soil types, and the cost of pursuing a claim for changed conditions. Therefore, all contractors must include in their bid price a cost of risk, including the geotechnical risk, or soon go out of business.

274. Assume, for example, that a dredging contractor is faced with a channel deepening project. The owner has provided some prior information consisting of geologic literature about the general area and project records containing test boring logs from nearby the site, but no geotechnical data from within the dredging prism itself. Then a cost associated with geotechnical risk, assuming no sampling information, will be part of the total project cost as reflected in the bid price. Alternatively, assume that a very extensive geotechnical site investigation has been made; so extensive that the knowledge of the soil profile can be called perfect. Now, how much can the total project cost be reduced? The contractor now has all knowledge beforehand needed to match equipment to soil type and character, to schedule the equipment, and to determine fuel, personnel, and wear costs. There is absolutely no risk in the project due to lack of knowledge of the characteristics of the soils in the dredging prism. This savings in bid price is the *Value of Perfect Information (VPI)*, and represents an upper limit of project savings due to the availability of complete geotechnical information.

275. Using the concept of Bayes' Theorem discussed above, every piece of information derived from sampling and testing at the site is added to the total prior information available prior to the next amount of sampling and testing. In a relationship similar to a learning curve (which, in effect, it is), the first amount of sample data increases the contractor's knowledge about the site by a large amount and helps reduce the risk due to uncertainty about the project soils. The amount that the site investigation information reduces the total project cost, including the bid price and the total cost of

claims, is called the *Value of Sample Information (VSI)*. Each new amount of sample data adds to the total knowledge about the site, but with decreasing value. As the amount of information available increases, the VSI curve ultimately becomes asymptotic to the VPI line. This is shown graphically in Figure 33.

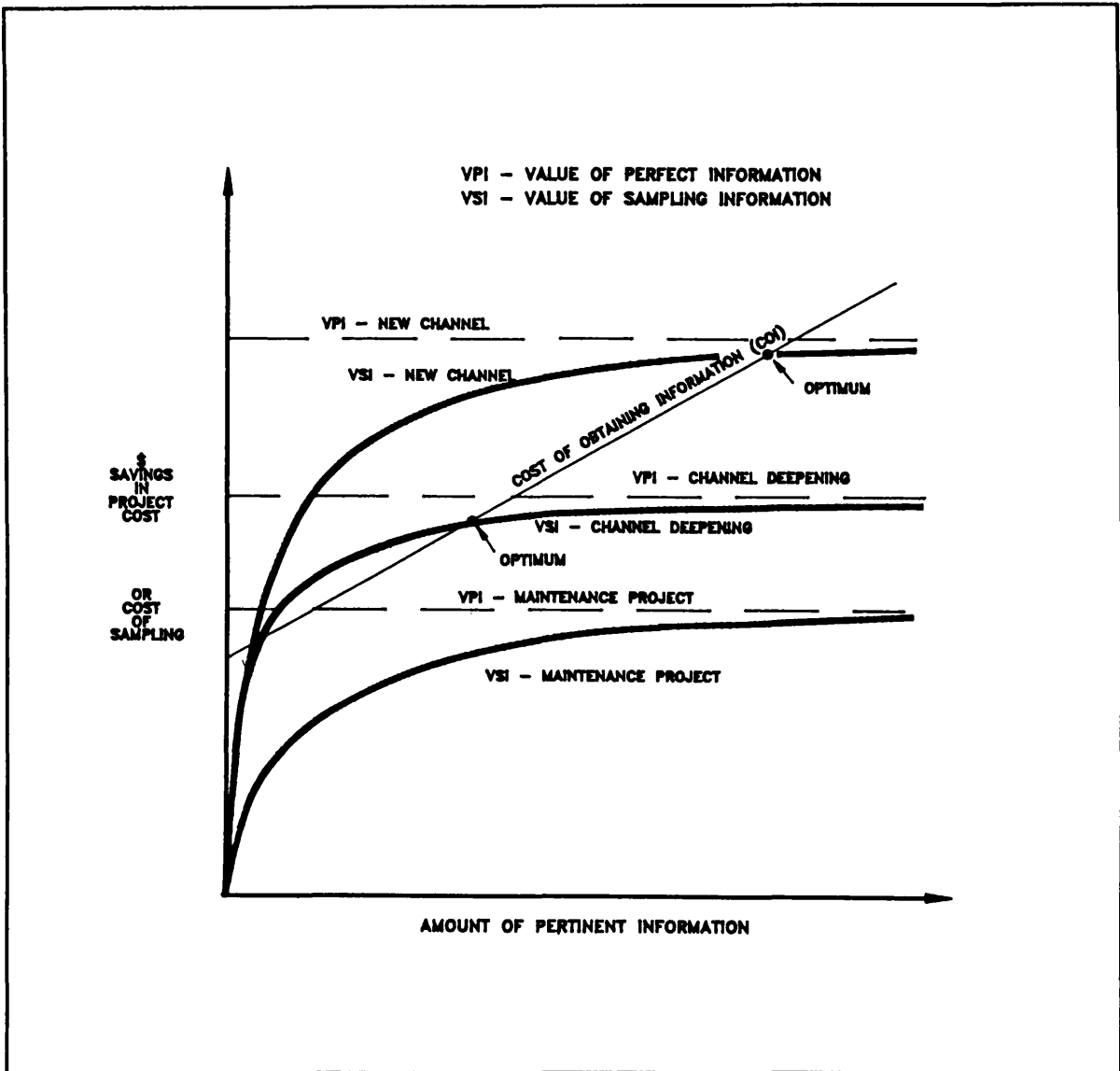

Figure 33. Value of additional information

276. Assume next that the cost of performing a geotechnical site investigation is a linear function of the value of that information in reducing geotechnical risk. This is a somewhat realistic assumption if money and effort are not wasted on meaningless tests for irrelevant soil properties and if the work is efficiently planned and carried out. It is also reasonable to include a fixed cost for mobilization, overhead, and other indirect costs

as the intercept of the line. The *Cost of Obtaining Information (COI)* line is also shown on Figure 33.

277. Figure 33 illustrates the larger cost savings due to perfect information for projects for which little or no prior information or experience exists. This has been shown as three lines, the lowermost VPI line is for a maintenance project on which much prior information exists. The intermediate VPI line is for a channel deepening project where at least some prior experience exists with the maintenance work soils above the new work portion. The upper VPI line assumes that very little prior information exists to guide the bidders. The magnitude of the ordinate and the slope of the COI (cost) line is arbitrary in Figure 33 and can be controlled somewhat by the type, method, and sequence of the investigation.

278. The three types of projects shown on Figure 33 each have a different "break even" point, i.e., the amount of geotechnical information above which the cost of obtaining more information is greater than its value in reducing the project costs. Below that point, the savings to the project, the VSI, is greater than the COI. In the figure, the VOI curve for a fictitious maintenance project is shown completely below the COI line. This illustrative example shows that, in some situations such as well-documented and experienced maintenance projects, the preexisting geotechnical knowledge is *sufficient* and no amount of site investigation will likely contribute to a reduction in project costs and, therefore, no site investigation is justified. The relationships shown in Figure 33 will vary from project to project as the complexity of the soil profile changes.

279. The selection of a confidence level (risk level) is of utmost influence in the planning and analysis of the data from a site investigation. In every analysis of data, whether statistical or judgmental, there is a risk that the conclusion reached on the basis of available data is not true. This is called a Type II error, which is the consumer's, or contractor's risk. Type I error occurs when a conclusion is rejected when in fact it is valid; this is the producer's or owner's risk. Then, what are the consequences of either type of risk? The cost of taking a risk is somewhat like liability or fire insurance--the greater the risk, the greater the premium. Uncertainty and risk are personal evaluations and are reflected in the concept of *utility*. The utility of money to a person with a personal aversion to risk is greater than it is to one with greater risk taking ability. To a person with a small amount of money, the risk of gambling and losing a large amount of money is somewhat greater than the perceived risk of gambling with a small amount of money. To a well-funded group, the value of the risk does not change much with the size of the gamble. Utility, then, is the decision-maker's attitude toward risk. Utility differs among and within owner organizations, engineers who are risking professional reputation, and dredging contractors.

## PART VIII: IMPLEMENTING A SITE INVESTIGATION STRATEGY

280. The previous sections of this report have presented factual information about geotechnical soil sampling and testing and theoretical discussions of variability and risk. That information is intended as a commonly understood background for understanding and formulating a dredging-related site investigation strategy, or plan. This part of the report presents a discussion of some of the topics presented in Parts II through VII and suggestions for the practical implementation of a geotechnical subbottom investigation plan.

281. As discussed in Part III of this report, a geotechnical site investigation proceeds in the same manner as any scientific research project. First, all available existing information is assembled and reviewed. If this is sufficient, then no further investigation is needed. If it is not sufficient, then additional site information is obtained. The additional studies, which usually include sampling and testing of the soil or rock, are made until a point of sufficiency is reached. It should be recognized that the geotechnical site characterization developed from this process is not necessarily the real one in all respects. It is simply the best estimate that can be made within the limitations of the time, the funds, the technology, and the capability to interpret geotechnical data that have been used.

282. The practical development and implementation of a site investigation strategy for a dredging site involves making decisions to answer a number of questions:

- a. What should be the scope of the investigation?
  - (1) Is the prior, or preexisting, information about the subsurface conditions at the site sufficient?
  - (2) Will a geophysical exploration be useful?
  - (3) Is sampling and/or testing at field exploration sites needed?
  - (4) If a field investigation is needed, how many individual exploration sites should be used?
  - (5) Where should the exploration sites be located?
- b. What should be done at each individual exploration site?
  - (1) How many samples and/or field tests should be made in the vertical reach?
  - (2) What kind of samples and/or field tests to make?
  - (3) Should a boring or a test pit be used? If a boring, what kind of boring?
  - (4) Which work platform to use?
  - (5) Which laboratory tests should be made on the samples?
  - (6) Will all samples be laboratory tested? If not, which criteria will be used to describe/classify them?

283. Sufficiency of a site investigation is a matter of the decision-maker's personal aversion to risk. The level of uncertainty at which any individual is comfortable in making decisions is based on his/her knowledge, capability, intuition, and personal biases. Every person has an acceptable level of risk and this is a function of the cost of being wrong. The acceptable level of risk is not the same for the owner, for the engineers, and for the contractor on a dredging project simply because each has a different set of values, monetary and professional, associated with the project. Sufficiency is sometimes dictated by the availability of funds, time, personnel, and equipment.

#### Risk Factors

284. The development of a site investigation strategy is typically done by the owner's organization without consultation with the dredging contractors interested in bidding the job. It is rational to expect that the owner is, or should be, responsible for the total reasonable cost of the work to be done at his request because the owner selects the time and place for the work to be done. The dredging contractor can, in fairness, only be held responsible for those things over which he has control:

- a. Personnel to perform the work;
- b. Selection and maintenance of equipment;
- c. Know-how to match equipment and work force to the job;
- d. Administration and scheduling of the work; and
- e. Financing of the work.

285. It is unrealistic to ask the contractor to take risks due to incomplete knowledge of the soil characteristics within the dredging prism. All this does is raise his cost of working because he must include a risk, or gamble, factor in his bid. In dredging, as with other major earthmoving jobs, the contractor mobilizes an expensive heavy equipment package for the anticipated site conditions. If the equipment is not suited to a part of the job, then he must demobilize and mobilize a new equipment package, usually at considerable cost. Another contractor, with a lower risk factor because he is less aware of soil variability at the project site, who is less experienced, more aggressive, and more needful of the work, may submit a lower bid and be awarded the job, leaving the more experienced and knowledgeable contractor without work. This successful bidder may lose money because of his inexperience and then have more claims and lawsuits, or may go out of business. This penalizes the entire dredging industry. The sensible objective, then, should be to provide all contractors with a sufficient amount of geotechnical site information that the only factors that determine who gets



the job are their own capabilities to manage personnel, equipment, scheduling, and financing.

#### Sufficiency of a Dredgeability Site Investigation

286. The amount of time, money, and effort that should be expended in a site investigation is, ideally, that which will match the savings in project cost due to its availability, as shown in Figure 33. This is the point of sufficiency, the "break even" point, and its interpretation is a matter of calculation--*provided the information for the calculation is available!* Unfortunately, it is virtually impossible to obtain the amount of information needed with presently available cost accounting systems. In the absence of known values of probability to be used in Bayes' Theorem, Equation (15), personal intuition and bias (personal utility factors) must be used to establish the point of sufficiency. The point of sufficiency will not be the same for all groups involved, the owner, the engineers, the contractors, because all have different personal utility factors.

287. Utility factors differ between (a) the owner's organization which is intent on reducing total job cost, (b) the geotechnical and other engineers who are risking their professional reputations, and (c) the dredging contractors who are bidding and risking money on the proposed project. Therefore, there can be no unique site investigation strategy or plan. No matter what the scope of the investigation, someone or some organization, with a different utility, or level of acceptable risk, will have a different VPI and different VSI and COI curves from everyone else.

288. A good approximation to Figure 33 can be obtained from frank, detailed discussions between project planners, estimators, geotechnical engineers, and the dredging contractors expected to bid on the project. All of their individual intuitions and biases, and utility factors, can therefore be brought to bear in establishing their personal evaluations of prior probabilities, whether they recognize them as such or not. This procedure is presented and discussed in many business management texts, such as Spurr and Bonini (1983). In this manner, by open and concerned discussion, a consensus can be established for a scope of work for the site investigation that is satisfactory to all. Details of the specific procedures for the site investigation, to answer the questions posed above, can then be developed by the geotechnical engineers using information of the type contained in this report.

## Suggestions for Implementing a Site Investigation Plan

289. The geotechnical sampling, in-situ testing, and laboratory testing methods presented in the preceding parts of this report have dealt with the description and classification of a single sample. Now, how can this information be extended to the geotechnical characterization of a body of soil, such as a layer or a stratum? Intuitively or formally, all investigators use statistical methods. A trend, i.e., a variation with length, width, or depth, is seen by observing, or by calculating, the best fitting line through the data. Gross changes in universe, i.e., a change in soil type, can be easily observed. Statistical methods such as those discussed in Part V are merely a formalization of intuitive thought processes. Even though these facts are recognized and understood, their application in planning a real project is difficult. Most desirably, we must know the mean and variance of the universe or have good random sample estimates. Until there is a database of statistical data to permit variance estimates during the planning phase of a site investigation, empirical methods will probably be used to decide on the number and type of borings, samples, and tests. These decisions will continue to be based on subjective judgement--because there is nothing better available and planners of the investigation must have guidelines. Objective judgement can be developed as statistical methods are used in the planning and in the evaluation of the results of site investigations.

### How Many Borings and Where?

290. The greater the variety of soil types and the variability of the soil properties in the dredging prism, the greater is the number of borings, samples, and tests needed to achieve a satisfactory level of confidence. Conventional ways of dealing with this subject have been to specify a uniform spacing of borings with a few samples from each boring. This is, basically, "systematic sampling with a random start" discussed above. This may not be the most economical method of sampling but has much merit in disclosing changes in soil type.

291. The closest type of land-based site investigation comparable to a dredging project is a study of a proposed highway subgrade. Teng (1962) recommended a boring spacing for highways that varied with the "horizontal stratification of the soil":

- a. for uniform stratification, 300 m (1000 ft);
- b. for average stratification, 150 m (500 ft), and
- c. for erratic stratification, 30 m (100 ft).

Sowers (1979) recommended a spacing for highway subgrade surveys of 60-600 m (200-2000 ft) with the admonition that the spacing depends on the complexity of the site. Although these boring spacings were not specifically recommended

for dredging projects, they are a starting point for consideration of boring spacings.

292. The availability of prior information is of great value in planning boring and sampling locations. The expected uniformity of soil types along the length of the project can often be determined from project records, especially in maintenance work. Because of the shallow depths usually involved in maintenance and channel deepening, geophysical acoustic soundings can provide a wealth of information about the uniformity of the bottom sediments. Then, it may be possible in some circumstances to space the borings widely, and fill in the intervening space with intermediate boring locations where it appears desirable to further define the soil profile.

#### Fixed or Variable Site Investigation Plan?

293. Sometimes, because of administrative or fiscal requirements, the owner will establish and contract for a specific, fixed, lump sum site investigation plan. That is, the number, locations, and types of borings and samples, and the laboratory testing program, are specified in advance. Unless there is very good prior knowledge of the variability of the site, an inflexible advance plan can be either over-extensive or ineffective. If the site is known that well, then why conduct the investigation at all? For greatest economy and effectiveness, there must be flexibility in the plan and the procurement of its implementation so that decisions can be made in the field during the conduct of the site investigation. This implies a sophisticated site investigation field crew, perhaps including one or more geotechnical engineers of a fairly high caliber in the field with the authority to make changes during the program. Or the changes may be authorized by the chief geotechnical engineer after daily telephone conference or radio-facsimile (fax) communication with the field engineer/geologist. Then, after a complete review of the data and the resulting estimated subsurface profile, using the progressive evaluation concept of Bayes' Theorem, Equation (15), a second or even third mobilization and investigation sequence may be needed to obtain missing or incomplete information.

#### Discussion of Soil Exploration, Sampling, and Testing Methods

294. A practical and cost-effective site investigation strategy includes selection among all of the available alternatives for soil exploration, sampling, and testing that were discussed in Parts IV, V, and VI in this report. A cost comparison between methods can only be made on the basis of total cost for the information to be gained at that location. Which combinations of drilling, sampling, and test methods will give equivalent results? The total process of obtaining soil information from a field investigation at any given test site consists of:

- a. Initial movement and preparation of personnel and equipment at the specific test site;
- b. Daily cycles of movement of personnel and supplies onto and off the site;
- c. Excavation to each sampling depth; should this be by test pit or trench or by drilling? If by drilling, which method?
- d. Making field consistency/compactness tests and obtaining samples for laboratory testing; making field visual-manual identification tests and evaluating the need for more field tests and samples at that location or for movement to a new location;
- e. Transporting samples to the laboratory, daily or at the end of work at that site, and making laboratory soils tests;
- f. Interpreting data. Is it consistent with previous data? Or should more tests be made? Where and when?
- g. Preparing a report of findings and disseminating it.

#### Preliminary Site Information

295. Spatial survey methods, such as remote imaging and acoustic geophysical systems, should be used as much as possible before establishing a drilling and sampling program. This type of information will be of greatest benefit in establishing the uniformity of the subbottom sediments so that boring spacings can be established rationally. These methods will require ground truth correlation and calibration with soil material identification tests on soils sampled from point sources such as borings. The geophysical acoustic survey may be made in combination with normal bottom mapping surveys, in the same vessel and at the same time.

#### Laboratory vs. In-Situ Soil Test Methods

296. A comparison is sometimes needed between laboratory and in-situ test methods for determination of specific soil properties. In general, the comparison for an equivalent amount of test information must include a comparison of costs, in time and money, for each test procedure: the length of time to perform each field test; the number of persons required; the availability of alternative methods, the relative accuracy and precision; and the capability to make the test or obtain the necessary sample in a marine environment.

297. In-Situ Tests. Tests for in-situ compactness or consistency, and for in-situ density, are best made in the field. If the boring or the pit is carefully made, the field test is made on undisturbed soil; an undisturbed sample is not needed even if it could be obtained. However, virtually all field tests are *estimators* of strength, or density, that rely on empirical correlations. For granular materials, this is often the only way that a test on undisturbed material can be made. Generally, the test results are available immediately. A comparison can be made, in the field, with other test data for consistency and a new test made immediately if an inconsistency is

found. Field testing requires working in the marine environment--weather, currents, traffic, and all of the other factors of that environment will affect testing accuracy and progress.

298. Laboratory Tests. Samples are obtained for laboratory tests of shear strength, water content, density of a tube sample, and soil material identification. Virtually all of these tests are inherently easier to perform in a laboratory environment than in a field laboratory or on a field work platform. Even if in-situ tests are made for shear strength and density, the standard soil material identification tests are best made in the laboratory. Shear strength and mass properties tests are valid only if made on undisturbed material. Laboratory testing requires undisturbed samples and these can only be obtained, economically, for soft to stiff clays, silty clays, and clayey silts. All samples must be transported to the laboratory. Undisturbed samples require careful handling to prevent disturbance during transport and removal from the sampling device. Silts with little or no clay binder act as very fine sands--they will liquefy when jolted in the sampling tube, destroying their undisturbed structure. All undisturbed sample tests, and most material properties tests, require testing for the natural water content. Therefore, samples must be carefully sealed in the field. Several of the soil material tests require time for sample preparation and time for drying or for a water content test; test results are usually not available for hours or even a day after testing actually starts.

#### Length of Time Needed to Make a Test

299. Because a site investigation is typically made months or even years before the general distribution of the results, the total time required for completion of a laboratory soil test is not a factor in its selection; the actual man-hours effort for each test is only of concern because of cost. Some of the standard tests have feasible, cost effective, alternatives. Conversely, the total time needed for obtaining a sample and of making a field test is of concern because a costly exploration crew and the working platform, and its prime mover, are present both during and between tests. For this reason it is often more cost-effective to perform a large number of quickly performed but less precise tests than a small number of time-consuming but very precise tests.

#### Must All Samples Be Fully Tested?

300. It is not practically necessary that all of the soil samples taken during a site investigation be laboratory-tested to establish their formal identification. Experienced soil test technicians can often estimate the soil material properties of a sample by visual comparison alone or by using ASTM Visual-Manual tests, i.e., by visually and texturally matching a sample with another soil sample whose geotechnical characteristics are known from testing. In this manner, the total cost of identifying the character of all of the soil

samples taken during a site investigation is drastically reduced without materially sacrificing the quality of the soil identifications. A rough estimate of the consistency of intact samples of clay soils can be made using either a hand penetrometer or a Torvane device. Table 24 shows differing coefficients of variation for different geotechnical tests. Therefore, for true economy, the number of tests for the different parameters need not be the same. They should only yield the same standard error of estimate, Equations (12) and (14), which is a function of sample size and sample variance.

#### Usefulness of Visual-Manual Tests

301. The purpose of field (visual-manual) identification tests is to assist the field geotechnical engineer/geologist to continually assess the developing soil profile while still at the test site; if there are anomalies or inconsistencies or missing information, then a change can be made in the boring locations or the sampling program. Also, by use of radio telephones and facsimile machines, the information can be sent directly to the geotechnical engineering office for concurrent evaluation. The only purpose for this is to facilitate efficient use of exploration crews and equipment. The cost to move personnel and equipment from one test site to another is generally higher than the cost to perform the drilling, sampling, and field testing at a specific site.

#### Selection Among Feasible Alternatives

302. Cost comparisons should be made on the total system needed to obtain equivalent strength, density, and material properties information at a test site. Any combination of an appropriate strength measuring device and a method for representative sampling of the soils penetrated should be compared with other combinations. There are several ways to measure compactness/consistency/cementation of sediments below the fluid mud level. The low sensitivity, or precision, of test results required for dredgeability evaluation permits almost any of the standard devices to be used. This means that VST can be used in clay, CPT in most soils, and SPT in a very wide range of soils. Examples from among the several feasible combinations are:

- a. Use a Vane Shear Test (VST) in a drilled hole in cohesive soils. This test method requires a drilled hole made from a stable surface platform. This method also requires a separate disturbed sample taken from the bore hole or from an adjacent hole to verify the presence of a clay and permit sampling for material identification tests. Samples may be taken by bucket auger, impact tube sampler, or equal.
- b. Use Standard Penetration Tests (SPT) every 0.5 m (1.5 ft) or larger depth spacing. This device indicates compactness/consistency and obtains a representative sample at the same time. Requires a stable platform for personnel and equipment. Needs drilled hole, but does not require smooth hole.

- c. Use Cone Penetration Test (CPT) for consistency/compactness and for estimate of soil type. Requires a stable platform at surface or bottom supported; no boring needed; requires heavy reaction weight. Because there is no representative sample, separate sampling is needed. Samples may be taken at a nearby location to the full length of the test depth (a) without drilling by using a vibrating tube sampler or gravity projectile sampler, (b) with drilling by impact tube of any size, or (c) a bucket auger.
- d. Use the rate of progress of a vibrating tube sampler, the deceleration rate of a gravity projectile tube sampler (with accelerometer), or similar device to measure compactness or consistency and to obtain a sample for laboratory testing. This type of device will require standardization of the apparatus and method for effective correlations with other performance properties or experience. The criteria for this type of device are: (a) be capable of consistently responding to variations in compactness/consistency, (b) be able to be manipulated by hand, or with minimal machinery, by one or two persons of minimum technical capability, (c) be capable of being remotely operated from a small vessel in moderate to heavy seas in extremes of temperature, and (d) be able to indicate test data immediately and be able to record the data for future manipulation.

## PART IX: SUMMARY AND RECOMMENDATIONS

### Summary of the Report

303. The objective of a geotechnical site investigation of a proposed dredging project is to obtain the most complete and accurate knowledge of the location, boundaries, and qualities of the materials to be dredged that is possible within the limits of available time, money, and practicality. Each dredging site and each dredging project is unique; therefore, there cannot be a standard site investigation plan, or strategy, to cover all situations.

304. There are several factors that most affect the objectives, the scope, and the methodology of a site investigation: soil property variability in the dredging prism, the amount and type of sampling and testing used, and the value of additional information in reducing risk costs. All of these factors must be considered in establishing the sufficiency of a site exploration program. Sufficiency occurs when the cost of making the site investigation equals the potential savings in project costs, including savings in bid price, due to the added information.

305. One objective of a site investigation is to define the variability of the project soils. Another objective is to provide sufficient appropriate information to the contractor to reduce his feeling of risk, and to improve his confidence in knowledge about project soils, thereby enabling him to reduce his bid price. Yet, the variability must be known to plan an effective site investigation strategy. The effect of the amount of information available will not be known until the information has been obtained. This, then, is a form of trial-and-error approach requiring iteration in obtaining information to reach the final desired result.

306. The selection of the group of soil characteristics that must be measured must consider all possibilities of dredging equipment. As a minimum, the geotechnical soil properties should include: the in-situ compactness of granular soils or the consistency of cohesive soils; the in-situ density and water content; the grain-size distribution of coarse grains; the Atterberg limits of fine grains; the specific gravity of the grains; the angularity, shape, and hardness of coarse grains; and the organic and carbonate contents of the soil.

307. A geotechnical site investigation is made in the following order: (1) a search is made of all prior information, including geologic and other publications, and project records; (2) a spatial survey is made to determine overall variability in the soil profile, possibly using remote imaging and geophysical acoustic soundings; (3) after a preliminary soil profile is established, test borings (or test pits) are made at selected locations, usually on a uniform spacing; the spacing should be varied to correspond with



the variability of the soil profile at any area of the dredging prism; (4) in-situ compactness/consistency tests and in-situ density tests are made and samples taken for laboratory analyses of soil material properties; visual-manual test are made in the field as a preliminary reevaluation of the previously assumed soil profile; (5) the representative samples are delivered to the laboratory for testing; and (6) the process is repeated with additional borings, sampling, and testing as needed until sufficiency is reached.

308. Sufficiency of information for a dredging project varies with the amount of new work to be done. Maintenance work may require very little beyond a search of prior project records, perhaps with some acoustic geophysical surveying. Channel deepening will require shallow borings in addition to the geophysical surveys. New channels may need deep borings beyond the depth of effective acoustic geophysical surveying.

309. The variability of soil properties within a homogeneous stratum differs with the property being measured; the variability of test data resulting from a test method varies with the test process; some test methods are more imprecise than others. Not all laboratory tests need be made on all samples; some properties can be estimated by visual comparison with a companion sample that has been tested. The precision of soil property data is not as critical in evaluating dredgeability as it is in foundation engineering. Because of the wide area or length of a dredging project, knowledge of the general trends and major changes in soil properties is crucial. At the same overall cost it is, therefore, more valuable to have a large number of fairly imprecise (crude) tests than it is to have a small number of very precise and exacting tests.

310. The cost of obtaining information at any specific test site includes the cost of moving to the site, setting up the drill platform, the daily cycle of movement of personnel and supplies, the fixed cost of equipment, the rate of progress of sampling and testing possible with the a system, and the cost for transporting and testing laboratory samples. All of these factors must be considered when evaluating relative costs for obtaining the same information. The combination of devices and tests that will provide the necessary information at minimum cost and that will provide for easiest re-entry of the site for additional drilling, sampling, and testing is the methodology to use.

#### Recommendations for Further Work

311. The US Army Corps of Engineers is responsible for more dredging than any other organization in the world. The complexity of site investigation, if it is to done in a cost-effective manner, requires expertise beyond that normally available within District geotechnical groups.

Therefore, it is suggested that the Corps of Engineers develop, operate, and maintain one or more complete dredging site investigation groups, including personnel and equipment, for use by any Division or District planning a new work project, either channel deepening or a new channel. This should include a vessel equipped for acoustic geophysical surveys using the latest equipment and methods, and the personnel to operate the equipment and analyze the data. This will provide a consistent system for use throughout the Corp's work.

312. The Corps of Engineers should also consider maintaining a crew of specialists that can work with local districts in planning, including conferences with estimators and contractors regarding scope of work, and conducting a site investigation. This organization should have the responsibility of maintaining records of site variability and project costs, including claims records, for all Corps of Engineers dredging projects to permit a Corps-wide database of information. Eventually, this database should contain enough project records to permit evaluations of probable sufficiency (prior probabilities) to advise the district offices on the amount of information needed from a site investigation. The cost of this team of specialists should easily be far less than the amount of total savings made on dredging projects.

313. The factors affecting adhesion and stickiness of clay soils should be reviewed. Which laboratory tests would best indicate the potential for this type of behavior?

314. A nonnuclear test method is needed for determination of in-situ density and water content in all types of soil. This should be a single purpose device, i.e., for density only. It should not be a requirement that the in-situ structure of the sediment be maintained for shear strength tests. The device may use any principle as long as it gets the job done. Acoustics or even direct displacement should be considered. A bucket or scoop type of device should work in granular soils. Simple tube samplers of the type presently in use will suffice in clay soils. If possible, the same device should work for all soil types and, if possible, should be capable, in shallow water, of being operated by a one- or two-man crew over the side of a small boat, and should not require the drilling of a boring to reach below the bottom.

## REFERENCES

- Adachi, K. 1989. "Sampling of Cohesionless and Gravelly Soils," The Art and Science of Geotechnical Engineering, Volume Honoring Ralph B. Peck, E. J. Cording et al., Eds., Prentice Hall, Englewood Cliffs, NJ, pp 221-239.
- APHA (American Public Health Association). 1985. Standard Methods for the Examination of Water and Wastewater, 16 ed., American Water Works Association, Water Pollution Control Federation, Washington, DC.
- ASCE. 1975 (Jun). "In Situ Measurement of Soil Properties," Proceedings of a conference held at Raleigh, North Carolina, American Society of Civil Engineers, New York, NY.
- ASCE. 1981. "Cone Penetration Testing and Experience," Proceedings of a session at the ASCE Conference, St. Louis, Mo., American Society of Civil Engineers, New York, NY.
- ASTM. 1992. "Natural Building Stones; Soil and Rock; Geotextiles" 1992 Annual Book of ASTM Standards, Volume 04.08, American Society for Testing and Materials, Philadelphia, PA.
- Babcock, F. M. and Miller, H. J. 1972. "Correlation of Standard Penetration Test Results with Vibracore Sampler Penetration Rates," Underwater Soil Sampling, Testing, and Construction Control, ASTM STP 501, American Society for Testing and Materials, Philadelphia, PA, pp 81-89.
- Baecher, G. 1983 (Sep). "Simple Statistical Methodology for Evaluating Rock Mechanics Exploration Data," Proceedings, Seminar on Probabilistic Methods in Geotechnical Engineering, Contract Report GL-87-1, USAE Waterways Experiment Station, Vicksburg, MS.
- Baecher, G. 1987a (Sep). "Statistical Analysis of Geotechnical Data," Contract Report GL-87-1, Contract DACW39-83-M-0067, USAE Waterways Experiment Station, Vicksburg, MS.
- Baecher, G. 1987b (Sep). "Uncertainty Analysis for Dam Projects," Contract Report GL-87-4, Contract DACW39-83-M-0067, USAE Waterways Experiment Station, Vicksburg, MS.
- Baldi, G., Bellotti, R., Ghionna, V., Jamiolkowski, M., and Pasqualini, E. 1981 (Oct). "Cone Resistance in Dry NC and OC Sands," Cone Penetration Testing and Experience, Proceedings of Geotechnical Engineering Session, ASCE Convention, St. Louis, MO., American Society of Civil Engineers, New York, NY, p 145.
- Bartos, M. J. 1977 (Sep). "Classification and Engineering Properties of Dredged Material," Dredged Material Research Program Technical Report D-77-18, US Army Engineer Waterways Experiment Station, Vicksburg, MS.

Benjamin, J. R. and Cornell, C. A. 1970. Probability, Statistics, and Decision for Civil Engineers, McGraw-Hill, New York, NY.

Bjerrum, L. 1973. "Problems of Soil Mechanics and Construction on Soft Clays," State-of-the-Art Report to Session IV, 8th International Conference on Soil Mechanics and Foundation Engineering, Moscow, USSR.

Bray, R. N. 1975 (Sep). "Practical Analysis of Dredger Capability," Proceedings of the First International Symposium on Dredging Technology, Canterbury, England, BHRA Fluid Engineering, Cranfield, Bedford, England, p A3-33.1

Bray, R. N. 1979. Dredging: A Handbook For Engineers, Edward Arnold, London.

Budhu, M. 1985 (Jun). "The Effect of Clay Content on Liquid Limit from a Fall Cone and British Cup Device," Geotechnical Testing Journal, American Society for Testing and Materials, Vol 8, No. 2, p 91.

Caillot, A., Meyer, G., Chambellan, D., and Tanguy, J. C. 1984 (Sep). "A New Nuclear Density Gauge to Measure Directly High Turbidities in Muddy Areas," Proceedings of the Nineteenth Coastal Engineering Conference, Houston, Texas, American Society of Civil Engineers, New York, NY, Vol III p 3172.

Calhoun, C. C., Richardson, T. W., McNair, E. C. Jr., Engler, R. M., Smith, H. J., and DeLoach, S. 1986 (Sep). "Dredging Research Program Development Report," US Army Engineer Waterways Experiment Station, Vicksburg, MS, and US Army Engineer Topographic Laboratories, Fort Belvoir, VA.

Casagrande, A. 1948. "Classification and Identification of Soils," Transactions of the American Society of Civil Engineers, American Society of Civil Engineers, New York, NY, Vol 113, pp 901-930.

Casagrande, A. and Wilson, S. D. 1951. "Effects of Rate of Loading on Strength of Clays and Shales at Constant Water Content," Geotechnique, Vol 2, p 251.

Cooling, L. F., Skempton, A. W., and Glossop, R. 1948. "Discussion" in Casagrande (1948).

Cox, C. M., Deursen, P. P. van, and Verhoeven, F. A. 1986a (Mar). "The Relevant Soil Properties for Dredging Silt," Proceedings of World Dredging Congress, WODCON XI, Brighton, England, CEDA, Delft, The Netherlands, p 650.

Cox, C. M., Deursen, P. P. van, and Verhoeven, F. A. 1986b (Aug). "The Relevant Soil Properties for Dredging Silt," Dredging and Port Construction, Vol 13, No. 8, p 39.

Davidson, D. T. and Sheeler, J. B. 1952. "Clay Fraction in Engineering Soils: III. Influence of Amount on Properties," Proceedings, Highway Research Board, Vol 31, pp 558-563.

Demars, K. R., Chaney, R. C., and Richter, J. A. 1983 (Mar). "The Rapid Carbonate Analyzer," Geotechnical Testing Journal, American Society for Testing and Materials, Vol 6, No. 1, p 30.

Deming, W. E. 1950. Some Theory of Sampling, John Wiley & Sons, New York, NY.

DiGeorge, III, F. P. and Herbich, J. B. 1978 (Aug). "Laboratory Determination of Bulking Factors for Texas Coastal Fine-Grained Materials," Center for Dredging Studies, Texas A&M University, College Station, TX.

Douglas, B. J. and Olsen, R. S. 1981 (Oct). "Soil Classification Using Electric Cone Penetrometer," Cone Penetration Testing and Experience, Proceedings of Geotechnical Engineering Session, ASCE Convention, St. Louis, Mo., American Society of Civil Engineers, New York, p 209.

Dunlap, W. 1989. "Geotechnical Descriptors in the European Dredging Industry," (In Review), Dredging Research Program, U.S.A.E. Waterways Experiment Station, Vicksburg, MS.

Eckert, J. and Callender, G. 1987 (Feb). "Geotechnical Engineering in the Coastal Zone," Instruction Report CERC-87-1, US Army Engineer Waterways Experiment Station, Vicksburg, MS.

Fowler, J. and Spigolon, S. J. 1988. "Hydraulic Fill Perimeter Dike, Gaillard Island Dredged Material Disposal Area, Mobile, Alabama", Proceedings of the Conference on Hydraulic Fill Structures, Ft. Collins, Colorado, Geotechnical Special Publication No. 21, American Society of Civil Engineers, New York, NY.

Gibbs, H. J. and Holtz, W. G. 1957. "Research on Determining the Density of Sands by Spoon Penetration Testing," Proceedings, 4th International Conference on Soil Mechanics and Foundation Engineering, London, Vol 1, pp 35-39.

Haas, W. J. M. de 1983 (Apr). "A Seabed Sampler for the Dredging Industry," Proceedings of the World Dredging Congress, WODCON X, Singapore, Malaysia, BHRA Fluid Engineering, Cranford, Bedford, England, Paper E3, pp 237-249.

Hald, A. 1952. Statistical Theory with Engineering Applications, John Wiley & Sons, New York, NY.

Harr, M. E. 1977. Mechanics of Particulate Media, McGraw-Hill, New York, pp 61-72 and 446-448.

Hellema, J. A. 1984 (Nov). "Acoustic Silt Density Measurement," Proceedings of the Conference Dredging '84, Dredging and Dredged Material Disposal, Clearwater Beach, FL, American Society of Civil Engineers, Vol 1, p 526.

Herbich, J. B. 1992. Handbook of Dredging Engineering, McGraw-Hill, Inc., New York, NY.

- Hoeg, K. 1986. "Geotechnical Issues in Offshore Engineering," Marine Geotechnology and Nearshore/Offshore Structures, ASTM STP 923, R. C. Chaney and H. Y. Fang, Eds., American Society for Testing and Materials, Philadelphia, PA, pp 7-50.
- Hough, B. K. 1957. Basic Soils Engineering, Ronald Press, New York, NY.
- HQDOA/AF. 1983 (Oct). "Soils and Geology: Procedures for Foundation Design of Buildings and Other Structures (Except Hydraulic Structures)," Army Technical Manual 5-818-1, Headquarters, Departments of the Army and Air Force, Washington, DC.
- HQUSACE. 1970 (Nov). "Laboratory Soils Testing," Engineer Manual 1110-2-1906, Department of the Army, Office of the Chief of Engineers, Washington, DC 20314.
- HQUSACE. 1972 (Mar). "Soil Sampling," Engineer Manual 1110-2-1907, Department of the Army, Office of the Chief of Engineers, Washington, DC 20314.
- HQUSACE. 1979 (May). "Geophysical Exploration," Engineer Manual 1110-1-1802, Department of the Army, Office of the Chief of Engineers, Washington, DC 20314.
- HQUSACE. 1984 (Feb). "Geotechnical Investigations," Engineer Manual 1110-1-1804, Department of the Army, Office of the Chief of Engineers, Washington, DC 20314.
- HQUSACE. 1987 (Sep). "Confined Disposal of Dredged Material," Engineer Manual 1110-2-5027, Department of the Army, Office of the Chief of Engineers, Washington, DC 20314.
- HQUSACE. 1990. "Soil Sampling," Engineer Manual 1110-2-1907, Department of the Army, Office of the Chief of Engineers, Washington, DC 20314.
- Hvorslev, M. J. 1943. "Pocket-Size Piston Samplers and Compression Test Apparatus," US Army Engineer Waterways Experiment Station, Vicksburg, MS.
- Hvorslev, M. J. 1949 (Nov). "Subsurface Exploration and Sampling of Soils for Civil Engineering Purposes," US Army Engineer Waterways Experiment Station, Vicksburg, MS.
- IAPH. 1987 (Apr). "Dredging for Development," Report of the Dredging Task Force, Committee on Port Safety, Environment, and Construction, International Association of Ports and Harbors, Terra et Aqua, No. 33.
- IHC Holland. 1983. "A New Type of Sedimentation Indicator," Ports and Dredging, IHC Holland, Papendrecht, Holland, No. 117, p 4.
- Johnson, B. 1988 (Oct). "Geotechnical Diver Tools: Operation and Maintenance Manual," Naval Civil Engineering Laboratory, Port Hueneme, CA, 93043.

- Johnson, B. A. and Beard, R. M. 1985. "A Lightweight 12-m Cone Penetrometer," Strength Testing of Marine Sediments: Laboratory and In-Situ Measurements, ASTM STP 883, R. C. Chaney and K. R. Demars, Eds., American Society for Testing and Materials, Philadelphia, PA, pp 125-139.
- Jones, G. 1984 (Jun). "New Geophysical Techniques in Seabed Sand Surveys," Dredging and Port Construction, Vol 11, No. 6, p 25.
- Lacasse, S. M., Lambe, T. W., Marr, W. A., and Neff, T. L. 1977a (Jun). "Void Ratio of Dredged Material," Proceedings of the Conference on Geotechnical Practice for Disposal of Solid Waste Material, University of Michigan, Ann Arbor, MI, American Society of Civil Engineers, New York, NY, p 153.
- Lacasse, S. E., Lambe, W. T., and Marr, A. W. 1977b (Oct). "Sizing of Containment Areas for Dredged Material," U.S. Army Engineer Dredging Research Program, Technical Report D-77-21, USAE Waterways Experiment Station, Vicksburg, MS.
- Ladd, C. C. 1975 (Jun). "Measurement of In Situ Shear Strength," Proceedings of the Specialty Conference on In Situ Measurement of Soil Properties, Raleigh, NC, Vol 2, American Society of Civil Engineers, New York, NY.
- Land, J. M. 1982 (Mar). "Ground Investigations for Dredging Works, Part II, Field Methods," Dredging and Port Construction, Vol 9, No. 3, pp 13-18.
- Land, J. M. and Garrard, G. 1986 (Feb). "The Practical Application of Multi-spectral Satellite Imagery to Dredging and Port Development Works," Dredging and Port Construction, Vol 13, No. 2, pp 31-34.
- Landva, A. 1986 (Jun). "In-Situ Testing of Peat," Use of In Situ Tests in Geotechnical Engineering, In Situ '86, Geotech. Sp. Publ. No. 6, Blacksburg, VA, S. P. Clemence, Ed., American Society of Civil Engineers, New York, p. 191
- Lee, I. K., White, W., and Ingles, O. G. 1983. Geotechnical Engineering, Pitman Publishing Co., Boston, MA.
- Leussen, W. van and Nieuwenhuis, J. D. 1984. "Soil Mechanics Aspects of Dredging," Geotechnique, Vol 34, No. 3, pp 359-381.
- Luteneger, A. J. 1987 (Mar). "Suggested Method for Performing the Borehole Shear Test," Geotechnical Testing Journal, American Society for Testing and Materials, Philadelphia, PA, Vol 10, No. 1, pp 19-25.
- Marcuson, W. F. and Franklin, A. G. 1979 (Jul). "State of the Art of Undisturbed Sampling of Cohesionless Soils," Miscellaneous Paper GL-79-16, US Army Engineer Waterways Experiment Station, Vicksburg, MS.
- Marr, L. S. 1981. "Offshore Applications of the Cone Penetrometer," Cone Penetration Testing and Experience, Proceedings of a session at the ASCE Conference, St. Louis, MO, American Society of Civil Engineers, New York, NY.

- Meyer, C. P. de and Malherbe, B. 1987. "Optimisation of Maintenance Dredging Operations in Maritime and Estuarine Areas," Terra et Aqua, No. 35, p 25.
- Miedema, S. A. 1984 (Oct). "The Cutting of Densely Compacted Sand Under Water," Terra et Aqua, No. 28, p 4.
- Miedema, S. A. 1985 (Jul). "Mathematical Modelling of the Cutting of Densely Compacted Sand Under Water," Dredging and Port Construction, Vol 12, No. 7, p 22, and errata in Dredging and Port Construction, Vol 12, No. 9, Sep, 1985.
- Miedema, S. A. 1986 (Jun). "Underwater Soil Cutting: A Study in Continuity," Dredging and Port Construction, Vol 13, No. 6, p 47.
- Miedema, S. A. 1989a (May). "On the Cutting Forces in Saturated Sand of a Seagoing Cutter Suction Dredge," Proceedings of World Dredging Congress, WODCON XII, Orlando, FL, WEDA, Fairfax, VA, p 331.
- Miedema, S. A. 1989b (Dec). "The Cutting Forces in Saturated Sand of a Seagoing Cutter Suction Dredger," Terra et Aqua, No. 41, pp 3-12.
- Miles, G. A. 1986 (Dec). "Pre-dredge Site Surveys: Getting to the Core of the Matter," Dredging and Port Construction, Vol 13, No. 12, p 35.
- Miller, I. and Freund, J. E. 1977. Probability and Statistics for Engineers, Prentice-Hall, Englewood Cliffs, NJ, 2nd Ed.
- Mills, W. H. 1970. "Grain Size Analysis of Soil by Elutriation," ASTM Special Technical Publication 479, American Society for Testing and Materials, Philadelphia, PA.
- Montante, V. 1980 (Oct). "The Nuclear Density Probe--an In-Situ Density Measuring Device," Proceedings of the World Dredging Congress, WODCON IX, Vancouver, B. C., Canada.
- Morgan, P. and Robins, W. T., III. 1987. "A Unique Drilling System--Nearshore/Surfzone, Oregon Inlet, North Carolina," Bulletin of the Association of Engineering Geologists, Vol XXIV, No. 4, pp 489-495.
- Murden, W. R. 1984 (Dec). "Dredging and the Environment," Dredging and Port Construction, pp 17-21.
- Muromachi, T. 1981. "Cone Penetration Testing in Japan," Cone Penetration Testing and Experience, Proceedings of a session at the ASCE Conference, St. Louis, MO, American Society of Civil Engineers, New York, NY, p 49.
- NAVFAC. 1982. Design Manual 7.1, Soil Mechanics, Department of the Navy, Naval Facilities Engineering Command, Alexandria, VA.
- Noornay, I. 1972. "Underwater Soil Sampling and Testing -- A State-of-the-Art Review," Underwater Soil Sampling, Testing, and Construction Control, ASTM STP 501, American Society for Testing and Materials, Philadelphia, PA, pp 3-41.



- Olsen, R. S. and Farr, J. V. 1986 (Jun). "Site Characterization Using the Cone Penetrometer Test," Use of In Situ Tests in Geotechnical Engineering, In Situ '86, Geotech. Sp. Publ. No. 6, Blacksburg, VA, S. P. Clemence, Ed., American Society of Civil Engineers, New York, pp 854-868.
- Olsen, R. S. and Malone, P. G. 1988 (Mar). "Soil Classification and Site Characterization Using the Cone Penetrometer Test," First International Symposium on Penetration Testing (ISOPT-1).
- Oostrum, W. H. A. van, Parker, W. R., and Kirby, R. 1980 (Jul). "Maintenance Dredging in Fluid Mud Areas," Terra et Aqua, No. 19.
- Oostrum, W. H. A. van and Bakker, N. 1983 (Apr). "Weightwatching, A Self-Paying Job," Proceedings of the World Dredging Congress, WODCON X, Singapore, Malaysia, BHRA Fluid Engineering, Cranford, Bedford, England, Paper E2, p 223.
- Parker, W. R., Sills, G. C., and Paske, R. E. A. 1975 (Sep). "In Situ Nuclear Density Measurements in Dredging Practice and Control," Proceedings of the First International Symposium on Dredging Technology, Canterbury, England, \*BHRA Fluid Engineering, Cranfield, Bedford, England, p B3-25.
- Parker, W. R. and Kirby, R. 1977 (Nov). "Fine Sediment Studies Relevant to Dredging Practice and Control," Proceedings of the Second International Symposium on Dredging Technology, Texas A&M University, USA, BHRA Fluid Engineering, Cranfield, Bedford, England, p B2-15.
- Peck, R. B., Hanson, W. E., and Thornburn, T. H. 1974. Foundation Engineering, 2nd Edition, John Wiley and Sons, New York, NY.
- Peck, R. B. and Bazaraa, A. R. S. 1969. Discussion of "Settlement of Spread Footings on Sand," Journal of the Soil Mechanics and Foundations Division, American Society of Civil Engineers, New York, NY.
- PIANC. 1984. "Classification of Soils & Rocks to be Dredged," Report of a Working Group of the Permanent Technical Committee II, Supplement to Bulletin No. 47, Permanent International Association of Navigation Congresses, also published in Terra et Aqua, No. 30, Nov. 1985.
- Poloncsik, S., Langdon, W. M., Nedved, T. K., and Fochtman, E. G. 1972 (Dec), "In-Place Measurement of Shoal Density," Journal of the Water Pollution Control Federation, Vol 44, No. 12, pp 2334-2341.
- Poppe, L. J., Eliason, A. H., and Fredericks, J. J. 1985. "APSAS -- An Automated Particle Size Analysis System," Circular 963, US Geological Survey, Alexandria, VA.
- Reid, B. 1986 (Feb). "A Decade of Rapid Progress in Dredging Technology," Dredging and Port Construction, Vol 13, No. 2, p 36.

- Richards, A. F. and Zuidberg, H. M. 1985. "In-Situ Determination of the Strength of Marine Soils," Strength Testing of Marine Sediments: Laboratory and In-Situ Measurements, ASTM STP 883, R. C. Chaney and K. R. Demars, Eds., American Society for Testing and Materials, Philadelphia, PA, pp 11-40.
- Richards, A. F. and Zuidberg, H. M. 1986. "Sampling and In-Situ Geotechnical Investigations Offshore," Marine Geotechnology and Nearshore/Offshore Structures, ASTM STP 923, R. C. Chaney and H. Y. Fang, Eds., American Society for Testing and Materials, Philadelphia, PA, pp 51-73.
- Riggs, C. O. 1986 (Jun). "North American Standard Penetration Test Practice," Use of In Situ Tests in Geotechnical Engineering, In Situ '86, Geotech. Sp. Publ. No. 6, Blacksburg, VA, S. P. Clemence, Ed., American Society of Civil Engineers, New York, pp 949-967.
- Rosfelder, A. M. 1967 (May). "Obtaining Located Samples From Sandy and Rocky Formations in Deep Water," Proceedings of the World Dredging Conference, WODCON '67, New York, NY, World Dredging Conference, Palos Verdes Estates, CA, pp 487-516.
- Ruiter, J. de 1981 (Oct). "Current Penetrometer Practice," Cone Penetration Testing and Experience, Proceedings of Geotechnical Engineering Session, ASCE Convention, St. Louis, MO, Amer. Society of Civil Engineers, New York, p 1.
- Ruygrok, P. A. 1988 (Mar). "Evaluation of the Gamma and Neutron Radiation Scattering and Transmission Methods for Soil Density and Moisture Determination," Geotechnical Testing Journal, American Society for Testing and Materials, Philadelphia, PA, Vol 11, No. 1, p 3.
- Sangrey, D. A. 1977. "Marine Geotechnology--State of the Art," Marine Geotechnology, Vol 2, pp 45-80.
- Sargent, J. H. 1968 (Oct). "Site Investigations for Modern Dredging Practice," Proceedings of the World Dredging Conference, WODCON II, Rotterdam, The Netherlands, World Dredging Conference, Palos Verdes Estates, CA, pp 315-337.
- Sargent, J. H. 1973. "Investigations for Dredging Projects," Terra et Aqua, No. 3/4, p 10.
- Saucier, R. T. 1970 (Apr). "Acoustic Subbottom Profiling Systems, a State-of-the-Art Survey," Technical Report S-70-1, US Army Engineer Waterways Experiment Station, Vicksburg, MS.
- Schmertmann, J. H. 1975 (Jun). "Measurement of In Situ Shear Strength," Proceedings of the Specialty Conference on In Situ Measurement of Soil Properties, Raleigh, NC, Vol 2, Amer. Society of Civil Engineers, New York, NY.
- Schmertmann, J. H. 1978. "Study of Feasibility of Using Wissa-Type Piezometer Probe to Identify Liquefaction Potential of Saturated Fine Sands," Technical Report S-76-2, U.S.A.E. Waterways Experiment Station, Vicksburg, MS.

Schwartz, A. E. 1967. "Rapid Means of Determining Density and Moisture Content of Soils and Granular Materials," Bulletin 109, Engineering Experiment Station, Clemson University, Clemson, SC.

Selig, E. T. and Ladd, R. S. 1973. "Evaluation of Relative Density Measurements and Applications," Evaluation of Relative Density and Its Role in Geotechnical Projects Involving Cohesionless Soils, ASTM STP 523, American Society for Testing and Materials, Philadelphia, PA, pp 487-504.

Sibley, E. A. and Yamane, G. 1965. "A Simple Shear Test for Saturated Cohesive Soil," Proceedings of the 5th Pacific Area National Meeting, ASTM, Seattle, Washington, American Society for Testing and Materials, Philadelphia, PA.

Siegal, B. S. and Gillespie, A. R. (Editors). 1980. Remote Sensing in Geology, John Wiley and Sons, New York.

Skempton, A. W. 1953. "The Colloidal 'Activity' of Clays," Proceedings, Third International Conference on Soil Mechanics and Foundation Engineering, Zurich, Switzerland, Vol 1, pp 57-61.

Skempton, A. W. 1986. "Standard Penetration Test Procedures and the Effects in Sands of Overburden Pressure, Relative Density, Particle Size, Ageing and Overconsolidation," Geotechnique, Vol 36, No. 3, pp 425-447.

Sowers, G. F. 1979. Soil Mechanics and Foundations: Geotechnical Engineering, Macmillan Publishing Co., New York, 4th Ed., pp 20-31.

Spangler, M. G. and Handy, R. L. 1982. Soil Engineering, Fourth Edition, Harper and Row, New York, NY.

Spigolon, S. J. 1993. "Geotechnical Factors in the Dredgeability of Sediments; Report 1, Geotechnical Descriptors for Sediments to be Dredged," Contract Report DRP-93-3, U.S. Army Engineer Waterways Experiment Station, Vicksburg, MS.

Spigolon, S. J. and Fowler, J. 1988 (Oct). "Geotechnical Descriptors for Dredgeability of Soil Sediments," Proceedings of the 21st Annual Dredging Seminar, Metairie, LA, Texas A&M University, College Station, TX.

Spigolon, S. J. and Fowler, J. 1989 (May). "Geotechnical Descriptors for Soils to be Dredged," Proceedings of the Twelfth World Dredging Congress, WODCON XII, Orlando, FL, pp 698-707.

Spurr, W. A. and Bonini, C. P. 1967. Statistical Analysis for Business Decisions, Richard D. Irwin, Inc., Homewood, IL.

Steeghs, H. 1985a. "Cutting Sand Underwater (1)," Ports and Dredging, IHC Holland, Papendrecht, Holland, No. 121, p 4.

Steeghs, H. 1985b. "Cutting Sand Underwater (2)," Ports and Dredging, IHC Holland, Papendrecht, Holland, No. 123, p 4.

- Tarbotton, M. R. and Murphy, D. S. 1984 (Nov). "An Application of Acoustic Core Analysis," Proceedings of the Conference Dredging '84, Dredging and Dredged Material Disposal, Clearwater Beach, FL, American Society of Civil Engineers, New York, NY, Vol 1, p 409.
- Taylor, D. W. 1948. Fundamentals of Soil Mechanics, John Wiley and Sons, New York, NY.
- Teng, W. C. 1962. Foundation Design, Prentice-Hall, Englewood Cliffs, NJ.
- Terzaghi, K. and Peck, R. B. 1948. Soil Mechanics in Engineering Practice, 1st Edition, John Wiley and Sons, New York, NY.
- Terzaghi, K. and Peck, R. B. 1967. Soil Mechanics in Engineering Practice, 2nd Edition, John Wiley and Sons, New York, NY.
- Tirey, G. B. 1972. "Recent Trends in Underwater Soil Sampling Methods," Underwater Soil Sampling, Testing, and Construction Control, ASTM STP 501, American Society for Testing and Materials, Philadelphia, PA, pp 42-54.
- Trautmann, C. H. and Kulhawy, F. H. 1983. "Data Sources for Engineering Geologic Studies," Bulletin of the Association of Engineering Geologists, Vol XX, No. 4, pp 439-454.
- Turner, T. M. 1984. Fundamentals of Hydraulic Dredging, Cornell Maritime Press, Centreville, MD.
- USAEWES. 1960 (Apr). "The Unified Soil Classification System," Technical Memorandum No. 3-357, US Army Engineer Waterways Experiment Station, Vicksburg, MS.
- USAEWES. 1954. "A Study of Moisture Content Determinations on Selected Soils" Miscellaneous Paper H-73, US Army Engineer Waterways Experiment Station, Vicksburg, MS.
- USAEWES. 1962 (Jun). "Engineering Properties of Fine-Grained Mississippi Valley Alluvial Soils, Meander Belt and Backswamp Deposits," Technical Report No. 3-604, US Army Engineer Waterways Experiment Station, Vicksburg, MS.
- Verhoeven, F. A., Jong, A. J. de, and Lubking, P. 1988 (Aug). "The Essence of Soil Properties in Today's Dredging Technology," Hydraulic Fill Structures, Ft. Collins, Colorado, Geotechnical Special Publication No. 21, American Society of Civil Engineers, New York, NY, pp 1033-1064.
- Villet, W. C. B. and Mitchell, J. K. 1981. "Cone Resistance, Relative Density and Friction Angle," Cone Penetration Testing and Experience, Proceedings of a session at the ASCE Conference, St. Louis, Mo., American Society of Civil Engineers, New York, NY, p 178.
- Vlieger, H. de 1986 (Mar). "Navitracker...A New System for Continuous Underway In Situ Density Surveys," Dredging and Port Construction, Vol 13, No. 3, p 33.

Vlieger, H. de and Cloedt, J. de. 1987 (Dec). "Navitracker: A Giant Step Forward in Tactics and Economics of Maintenance Dredging," Terra et Aqua, No. 35.

Wasti, Y. 1987 (Mar). "Liquid and Plastic Limits as Determined from the Fall Cone and the Casagrande Methods," Geotechnical Testing Journal, American Society for Testing and Materials, Vol 10, No. 1, p 26.

WDMC. 1986 (May). "Probe Measures Depth of Bottom Sediment Layers," World Dredging and Marine Construction, p 25.

Weiler, W. A., Jr., and Kulhawy, F. H. 1978 (Dec). "Accuracy of the Density Scoop for Unit Weight Determinations in Cohesionless Soils," Geotechnical Testing Journal, American Society for Testing and Materials, Vol 1, No. 4, pp 234-236.

Whitman, R. V. 1960. "Some Considerations and Data Regarding the shear Strength of Clays," Research Conference on Shear Strength of Cohesive Soils, Boulder, CO, American Society of Civil Engineers, New York, NY.

Wood, D. M. 1985. "Some Fall-Cone Tests," Geotechnique, Vol 35, No. 1, pp 64-68.

Wu, T. H. 1989. "Variability of Geological Materials," The Art and Science of Geotechnical Engineering, Volume Honoring Ralph B. Peck, E. J. Cording et al., Eds., Prentice Hall, Englewood Cliffs, NJ, pp 221-239.

Young, A. G., McClelland, B. and Quiros, G. W. 1988. "In-Situ Vane Shear Testing at Sea," Vane Shear Strength Testing in Soils: Field and Laboratory Studies, ASTM STP 1014, A. F. Richards, Ed., American Society for Testing and Materials, Philadelphia, PA, pp 46-67.

Zuidberg, H. M. 1975. "Seacalf: A Submersible Cone-Penetrometer Rig," Marine Geotechnology, Vol 1, No. 1, p 15.



# REPORT DOCUMENTATION PAGE

*Form Approved*  
*OMB No. 0704-0188*

Public reporting burden for this collection of information is estimated to average 1 hour per response, including the time for reviewing instructions, searching existing data sources, gathering and maintaining the data needed, and completing and reviewing the collection of information. Send comments regarding this burden estimate or any other aspect of this collection of information, including suggestions for reducing this burden, to Washington Headquarters Services, Directorate for Information Operations and Reports, 1215 Jefferson Davis Highway, Suite 1204, Arlington, VA 22202-4302, and to the Office of Management and Budget, Paperwork Reduction Project (0704-0188), Washington, DC 20503.

<b>1. AGENCY USE ONLY (Leave blank)</b>	<b>2. REPORT DATE</b> October 1993	<b>3. REPORT TYPE AND DATES COVERED</b> Report 2 of a series	
<b>4. TITLE AND SUBTITLE</b> Geotechnical Factors in the Dredgeability of Sediments; Report 2, Geotechnical Site Investigation Strategy for Dredging Projects		<b>5. FUNDING NUMBERS</b>  WU 32471	
<b>6. AUTHOR(S)</b>  S. Joseph Spigolon			
<b>7. PERFORMING ORGANIZATION NAME(S) AND ADDRESS(ES)</b>  SJS Corporation Coos Bay, OR 97420		<b>8. PERFORMING ORGANIZATION REPORT NUMBER</b>	
<b>9. SPONSORING / MONITORING AGENCY NAME(S) AND ADDRESS(ES)</b> U.S. Army Corps of Engineers Washington, DC 20314-1000; U.S. Army Engineer Waterways Experiment Station Geotechnical Laboratory 3909 Halls Ferry Road, Vicksburg, MS 39180-6199		<b>10. SPONSORING / MONITORING AGENCY REPORT NUMBER</b>  Contract Report DRP-93-3	
<b>11. SUPPLEMENTARY NOTES</b>  Available from National Technical Information Service, 5285 Port Royal Road, Springfield, VA 22161.			
<b>12a. DISTRIBUTION / AVAILABILITY STATEMENT</b>  Approved for public release; distribution is unlimited.		<b>12b. DISTRIBUTION CODE</b>	
<b>13. ABSTRACT (Maximum 200 words)</b>  The objective of a geotechnical site investigation for a dredging project is to obtain the most complete and accurate estimate of the location and character of the materials to be dredged that is possible within the limits of available time and money and of practicality. This information must then be communicated, in a readily understood manner, to all persons involved in the design, cost estimation, and construction of the project. A site investigation for dredging consists of studies of all available existing information, augmented, when necessary, by geophysical and geotechnical subbottom investigation, including the sampling and testing of soils and rock. The data are summarized in an estimated geotechnical subbottom profile. The validity of the estimated profile is dependent on the type and amount of site investigation made and on the knowledge and skill of the interpreter(s) of the data.			
<b>14. SUBJECT TERMS</b>		<b>15. NUMBER OF PAGES</b>	
Classification	Dredging	160	
Description	Excavation	<b>16. PRICE CODE</b>	
Dredgeability	Geotechnical soil sediments		
<b>17. SECURITY CLASSIFICATION OF REPORT</b>	<b>18. SECURITY CLASSIFICATION OF THIS PAGE</b>	<b>19. SECURITY CLASSIFICATION OF ABSTRACT</b>	<b>20. LIMITATION OF ABSTRACT</b>
UNCLASSIFIED	UNCLASSIFIED		





Destroy this report when no longer needed. Do not return it to the originator.