



LUND UNIVERSITY

GFDM Interference Cancellation for Flexible Cognitive Radio PHY Design

Datta, Rohit; Michailow, Nicola; Lentmaier, Michael; Fettweis, Gerhard

Published in:
IEEE Vehicular Technology Conference (VTC Fall), 2012

DOI:
[10.1109/VTCFall.2012.6399031](https://doi.org/10.1109/VTCFall.2012.6399031)

2012

[Link to publication](#)

Citation for published version (APA):
Datta, R., Michailow, N., Lentmaier, M., & Fettweis, G. (2012). GFDM Interference Cancellation for Flexible Cognitive Radio PHY Design. In *IEEE Vehicular Technology Conference (VTC Fall), 2012* (pp. 1-5). IEEE - Institute of Electrical and Electronics Engineers Inc.. <https://doi.org/10.1109/VTCFall.2012.6399031>

Total number of authors:
4

General rights

Unless other specific re-use rights are stated the following general rights apply:
Copyright and moral rights for the publications made accessible in the public portal are retained by the authors and/or other copyright owners and it is a condition of accessing publications that users recognise and abide by the legal requirements associated with these rights.

- Users may download and print one copy of any publication from the public portal for the purpose of private study or research.
- You may not further distribute the material or use it for any profit-making activity or commercial gain
- You may freely distribute the URL identifying the publication in the public portal

Read more about Creative commons licenses: <https://creativecommons.org/licenses/>

Take down policy

If you believe that this document breaches copyright please contact us providing details, and we will remove access to the work immediately and investigate your claim.

LUND UNIVERSITY

PO Box 117
221 00 Lund
+46 46-222 00 00

GFDM Interference Cancellation for Flexible Cognitive Radio PHY Design

R. Datta, N. Michailow, M. Lentmaier and G. Fettweis

Vodafone Chair Mobile Communications Systems,

Dresden University of Technology,

01069 Dresden, Germany

Email:[rohit.datta, nicola.michailow, michael.lentmaier, fettweis]@ifn.et.tu-dresden.de

Abstract—Generalized frequency division multiplexing (GFDM) is a new digital multicarrier concept. The GFDM modulation technique is extremely attractive for applications in a fragmented spectrum, as it provides the flexibility to choose a pulse shape and thus allows reduction of the out-of-band leakage of opportunistic cognitive radio signals into incumbent frequency space. However, this degree of freedom is obtained at the cost of loss of subcarrier orthogonality, which leads to self-inter-carrier-interference. This paper will explain how self-interference can be reduced by a basic and a double-sided serial interference cancellation technique and show that these interference cancellation techniques improve the GFDM bit error rate to match the theoretical performance of the well studied orthogonal frequency division multiplexing (OFDM).

I. INTRODUCTION

In today's scenario, radio spectrum is getting scarce and with opening up of some analog TV bands, the intelligent use of the available spectrum by cognitive radio (CR) [1] has become an important aspect of research in wireless communication. However, spectrum sharing of opportunistic users with licensed users needs to be done carefully so that incumbent user operation in adjacent frequency bands is not interfered with. One of the strict specifications for CR physical layer (PHY) modulation design is that the opportunistic signal should have extremely low out-of-band radiation, so that incumbent signals are not disturbed and co-existence is assured. Moreover, to cope with spectrum fragmentation, the receiver should be able to aggregate several TV white spaces (TVWS) by a single wide band signal. Hence, innovative waveform design with a new multicarrier modulation capable of interference mitigation has emerged as a very important topic of research.

The initial choice for CR physical layer design would be OFDM as it is well researched and offers the flexibility of multicarrier transmission. However, rectangular pulse shaping that is used in OFDM causes extensive spectral leakage to the adjacent incumbent frequency bands. A new PHY design technique, GFDM [2],[3], has the flexibility of shaping the pulses so that they have lower out-of-band radiation and cause less interference to the incumbent signals. Here, a root raised cosine (RRC) filter is considered. The RRC filter however, introduces inter-carrier interferences (ICI) which degrades the performance of the GFDM system. Another multicarrier modulation scheme being researched nowadays is filter bank multicarrier (FBMC) which avoids self-interference with offset-QAM [4],[5]. In OFDM, ICI cancellation is a well re-

searched area. [6],[7] proposed innovative ICI self-cancellation techniques for OFDM systems in presence of frequency offsets or time variations in the channel. The problem of ICI in GFDM is different, as the ICI is self-generated by the system itself due to the inherent non-orthogonality of the subcarriers because of RRC pulse shaping. Hence, in this paper we introduce a basic serial and a double sided serial interference cancellation procedure suitable for GFDM and demonstrate that the self introduced ICI caused by the RRC pulse can be mitigated successfully.

The rest of the paper is organized as follows: in section II, the GFDM system model is described. Section III describes the interference cancellation techniques and the results, followed by the conclusion in Section IV.

II. GFDM SYSTEM MODEL

GFDM is a multicarrier system with flexible pulse shaping. In this section, the GFDM system model is described in detail. First, binary data is modulated and divided into sequences of KM complex valued data symbols. Each such sequence $d[\ell]$, $\ell = 0 \dots KM - 1$, is spread across K subcarriers and M time slots for transmission. The data can be represented conveniently by means of a block structure

$$\mathbf{D} = \begin{pmatrix} \mathbf{d}_0 \\ \mathbf{d}_1 \\ \vdots \\ \mathbf{d}_{K-1} \end{pmatrix} = \begin{pmatrix} d_0[0] & \dots & d_0[M-1] \\ \vdots & & \vdots \\ d_{K-1}[0] & \dots & d_{K-1}[M-1] \end{pmatrix}, \quad (1)$$

where $d_k[m] \in \mathbb{C}$ is the data symbol transmitted on the k^{th} subcarrier and in the m^{th} time slot.

A. Transmitter Model

The GFDM transmitter structure is shown in Fig. 1. Consider the k^{th} branch of the transmitter. The complex data symbols $d_k[m]$, $m = 0, \dots, M-1$ are upsampled by a factor N , resulting in

$$d_k^N[n] = \sum_{m=0}^{M-1} d_k[m] \delta[n - mN], \quad n = 0, \dots, NM - 1 \quad (2)$$

where $\delta[\cdot]$ is the Dirac function.

Consequently, $d_k^N[n = mN] = d_k[m]$ and $d_k^N[n \neq mN] = 0$. With filter length $L \leq M$, the pulse shaping filter $g[n]$, $n = 0 \dots LN - 1$, is applied to the sequence $d_k^N[n]$.

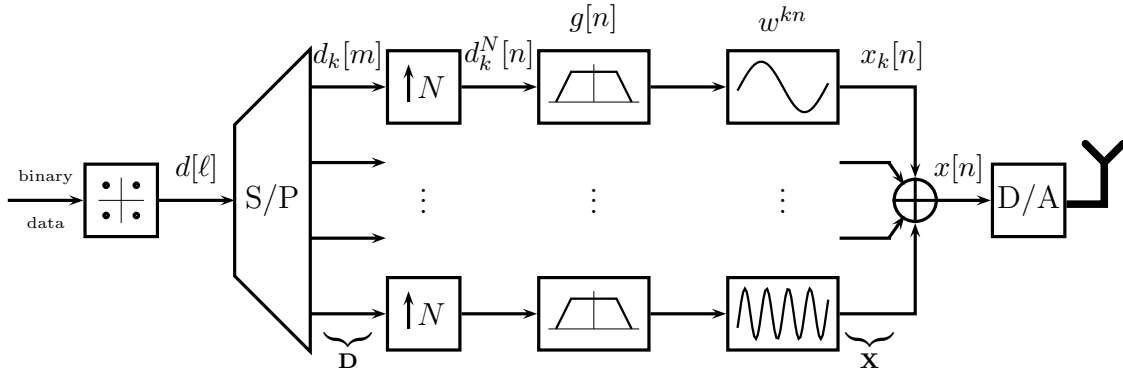

Fig. 1. GFDM transmitter system model

Additional rate loss from filtering is avoided with tail biting technique described in [2], [3], followed by digital subcarrier upconversion. The resulting subcarrier transmit signal $x_k[n]$ can be mathematically expressed as

$$x_k[n] = (d_k^N \otimes g)[n] \cdot w^{kn} \quad (3)$$

where \otimes denotes circular convolution and $w^{kn} = e^{j\frac{2\pi}{N}kn}$. N is the upsampling factor that is necessary to pulse shape each of the subcarriers respectively and in this paper we consider $N = K$.

Similar to (1), the transmit signals can also be expressed in a block structure

$$\mathbf{X} = \begin{pmatrix} \mathbf{x}_0 \\ \mathbf{x}_1 \\ \vdots \\ \mathbf{x}_{K-1} \end{pmatrix} = \begin{pmatrix} x_0[0] & \dots & x_0[MN-1] \\ \vdots & & \vdots \\ x_{K-1}[0] & \dots & x_{K-1}[MN-1] \end{pmatrix}. \quad (4)$$

The transmit signal for a data block \mathbf{D} is then obtained by summing up all subcarrier signals according to

$$x[n] = \sum_{k=0}^{K-1} x_k[n]. \quad (5)$$

This is then passed to the digital-to-analog converter and sent over the channel. According to the model described in this section, OFDM can be seen as a special case of GFDM, where $M = 1$ and rectangular pulse shaping is applied. Cyclic prefixed single carrier (CP-SC) transmission is another special case, where $K = 1$ and there is no restriction to the filter. Hence, GFDM can be thought of as a generalized case of frequency division multiplexing, where OFDM and single-carrier transmission are the two particular modes of transmission.

B. Receiver Model

The receiver structure is shown in Fig. 3. After analog-to-digital conversion the received signal shall be denoted as $y[n]$. The subcarrier receive signal is obtained after digital down conversion and is given as $\hat{y}_k[n]$. After convolving with the

receiver matched filter $g[n]$, the signal is defined as $\hat{d}_k^{(i),N}[n]$, where

$$\hat{y}_k[n] = y[n] \cdot w^{-kn} \quad (6)$$

$$\hat{d}_k^{(i),N}[n] = (\hat{y}_k \otimes g)[n] \quad (7)$$

The received data symbols, $\hat{d}_k^{(i)}[m]$ are obtained after down-sampling $\hat{d}_k^{(i),N}[n]$ according to $\hat{d}_k^{(i)}[m] = \hat{d}_k^{(i),N}[n = mN]$. Finally, the received bits are obtained after demodulation.

Fig. 3 also shows the interference cancellation unit. With i as the sub-iteration index, the cancellation signal $z^{(i)}[n]$ in the i -th sub-iteration depends on the scheme of interference cancellation. The processing that is necessary to cancel the ICI due to the adjacent subcarrier from the subcarrier of interest and then detect it, is defined as one *sub-iteration*. Performing this on all subcarriers in the signal is defined as one *iteration*. The interference cancelled received signal in the i -th sub-iteration is then given as

$$\hat{y}^{(i)}[n] = y[n] - z^{(i)}[n]. \quad (8)$$

The details of the interference cancellation schemes are given in the next section.

III. INTERFERENCE CANCELLATION

In GFDM, orthogonality between subcarriers is lost due to the cyclic pulse shaping filters. Hence, self-interference occurs which degrades the BER performance when compared to OFDM. If RRC filters are used as transmit and receive filters, then only the adjacent subcarriers interfere causing ICI. In Fig. 2 we show how the data on the k^{th} subcarrier is interfered with, by the data on the adjacent subcarriers in the frequency domain. This self-interference by adjacent carriers is the underlying reason why GFDM bit error rate (BER) performance was found to be worse than that of the OFDM in [2].

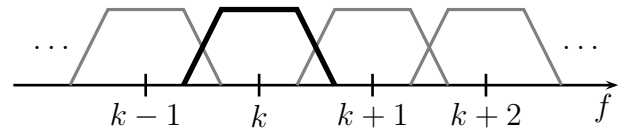

Fig. 2. The self-interference in the k -th subcarrier from adjacent subcarriers.

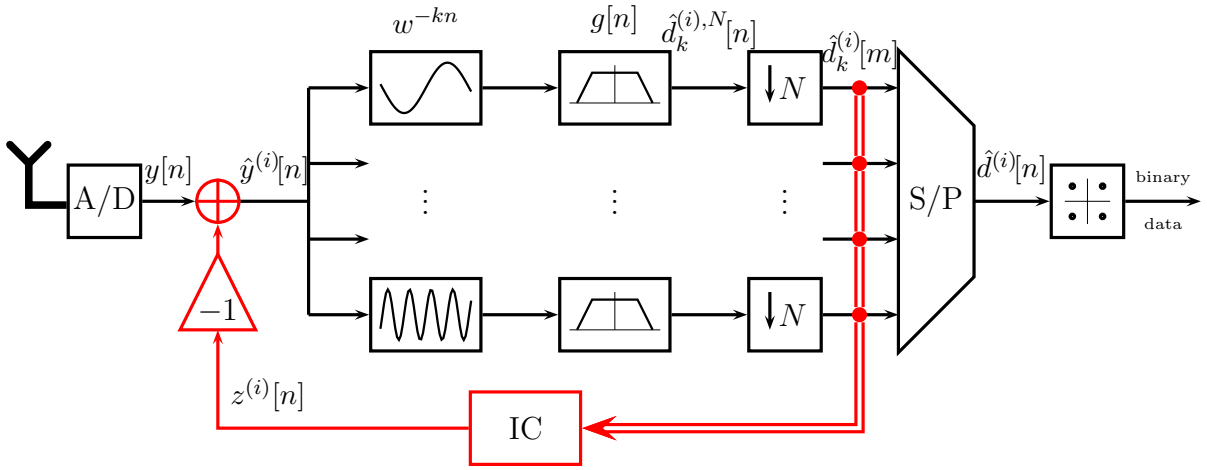

Fig. 3. GFDM receiver with interference cancellation unit

In Fig. 4, the interference cancellation unit is shown in detail. The received data symbols $\hat{d}_k^{(i)}[m]$ are fed to the interference cancellation block. Depending on the condition of the cancellation scheduler, the cancellation signal in the i -th subiteration, $z^{(i)}[n]$, is subtracted from the received signal, $y[n]$ as shown in Fig. 3. The basic and the double sided serial interference cancellation (SIC) techniques were implemented for GFDM to cancel ICI and these are explained in details in the following subsections.

A. Basic Serial Interference Cancellation

In the basic serial interference cancellation scheme, K subiterations are run to cancel out interference from succeeding subcarriers consecutively. In the subiteration $i = k$, the ICI due to subcarrier $k - 1$ is cancelled and the subcarrier k is detected¹. The cancellation scheduler passes a subset of the received symbols $\{\hat{d}_k^{(i)}[m]\}_{K \times M}$ to the GFDM Tx block, to construct the interference cancellation signal $z^{(i)}[n]$. In between, a detector maps the received symbols $\{\hat{d}_k^{(i)}[m]\}_{K \times M}$ onto the constellation grid to get $\{\hat{d}_k^{(i),e}[m]\}_{K \times M}$, where only the $(k - 1)$ th row has non-zero elements for the basic SIC scheduler.

As shown in Fig. 6, once $\hat{d}_{k-1}^{(i),e}[m], m = 1, \dots, M$ is obtained it is upsampled, filtered with the pulse shaping filter with sampled response $g[n]$, and digital subcarrier upconverted. The resulting interference cancellation signal $z^{(i)}[n]$ is then given as

$$z^{(i)}[n] = (\hat{d}_{k-1}^{(i),e} \otimes g)[n] \cdot w^{(k-1)n} \quad (9)$$

$z^{(i)}[n]$ is then subtracted from the composite received signal $y[n]$ to get $\hat{y}^{(i)}[n]$. This removes the interfering effects of the $(k - 1)$ th subcarrier from the k th subcarrier's data symbols.

Now the interference cancelled signal is digitally subcarrier downconverted, filtered with the pulse shaping filter sampled response and downsampled to get the received data symbols for the k th subcarrier. Mathematically this process can be

expressed as

$$\hat{y}_k^{(i)}[n] = \hat{y}^{(i)}[n] \cdot w^{-kn} \quad (10)$$

$$\hat{d}_k^{(i+1),N}[n] = (\hat{y}_k^{(i)} \otimes g)[n] \quad (11)$$

$$\hat{d}_k^{(i+1)}[m] = \hat{d}_k^{(i+1),N}[n = mN] \quad (12)$$

The intercarrier interference on the k th subcarrier is now removed and this process is continued for all subcarriers.

We start with cleaning subcarrier $k = 1$. For this, subcarrier K is detected initially. Then, in the 1st subiteration, the ICI from the K th subcarrier is cancelled from the 1st subcarrier and subcarrier $k = 1$ is detected. In the next subiteration, the ICI due to the 1st subcarrier is cancelled from the 2nd subcarrier and then detected. Thus the IC process continues.

The above procedure mitigates intercarrier interference effects of the preceding subcarriers. To cancel out ICI due to succeeding subcarriers, another K subiterations are performed with $i = K + 1, \dots, 2K$ and $k = 2K - i$.

This time the cancellation signal $z^{(i)}[n]$ is constructed from the $(k + 1)$ th subcarrier. This is explained by the following

¹The subcarriers are indexed with modulo K notations, i.e. $k - 1 = K$ for $k = 1$ and $k + 1 = 1$ for $k = K$

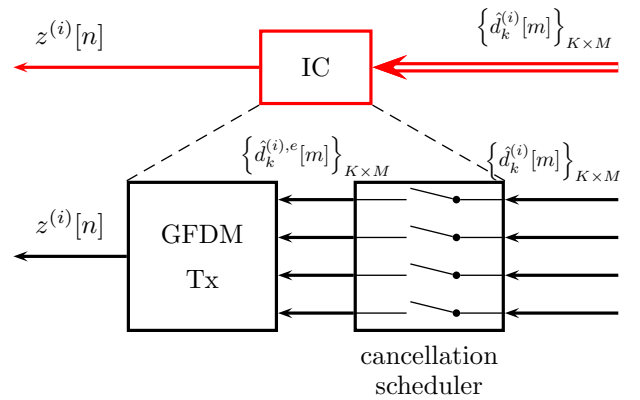

Fig. 4. Interference Cancellation Unit

equation

$$z^{(i)}[n] = (d_{k+1}^{(i),e} \otimes g)[n] \cdot w^{(k+1)n} \quad (13)$$

$z^{(i)}[n]$ is now subtracted from the composite received signal $y[n]$ and the data symbols on the preceding k^{th} carrier are decoded following a procedure similar to (10)-(12).

Parameter	Variable	GFDM
Modulation scheme	μ	2 (QPSK), 4 QAM
Samples per symbol	N	64
Subcarriers	K	64
Block size	M	15
Filter type		RRC
Roll-off factor	α	0.3
Channel	h	AWGN
Cyclic Prefix	CP	No
Transmission		Uncoded

TABLE I
GFDM SIMULATION PARAMETERS.

Performance results are obtained through simulation. The parameters are tabulated in Table I. The GFDM system is simulated in an additive white Gaussian noise (AWGN) channel with uncoded transmission. QPSK and 16 QAM modulation schemes have been implemented with number of subcarriers, $K = 64$ and samples per symbol, $N = 64$. The block size considered is $M = 15$. Root-raised-cosine (RRC) filters are chosen with roll-of-factor $\alpha = 0.3$. As an AWGN channel environment is simulated, cyclic prefix is not considered in the simulation setup.

The GFDM BER performance is improved by implementation of the SIC technique, as shown in Fig. 5. But it is unable to cancel out all the ICI and the GFDM performance is still about 1 dB worse compared to the theoretical OFDM curve.

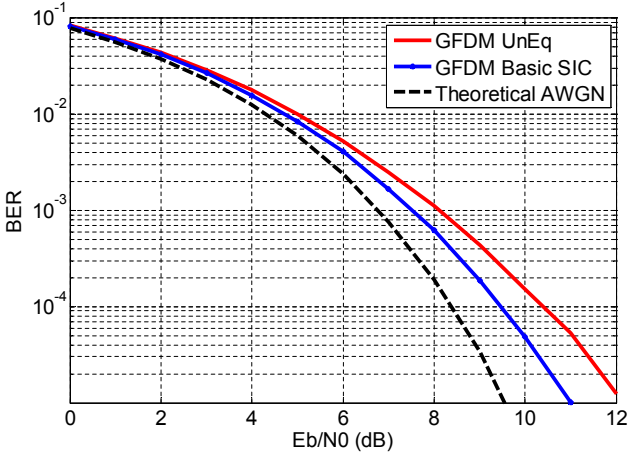

Fig. 5. GFDM Basic SIC BER Performance.

B. Double Sided Serial Interference Cancellation

In this technique, interferences from both the adjacent subcarriers are removed simultaneously. If k is the subcarrier

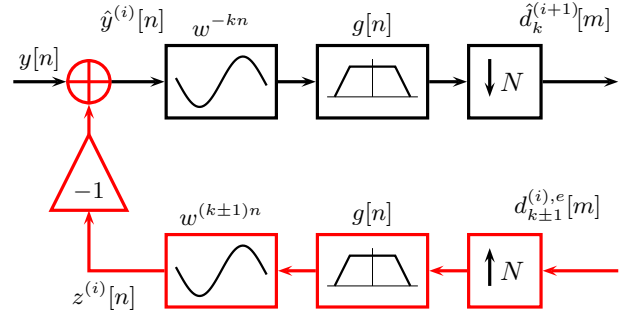

Fig. 6. Basic SIC flowchart

of interest, the data on the $(k-1)^{\text{th}}$ and on the $(k+1)^{\text{th}}$ subcarriers are $\hat{d}_{k-1}^{(i)}[m]$ and $\hat{d}_{k+1}^{(i)}[m]$. Now, $\hat{d}_{k-1}^{(i)}[m]$ and $\hat{d}_{k+1}^{(i)}[m]$ are mapped by a detector to the constellation grid to get $d_{k-1}^{(i),e}[m]$ and $d_{k+1}^{(i),e}[m]$. The data matrix in the interference cancellation unit, $\{d_k^{(i),e}[m]\}_{K \times M}$ now has non-zero elements in rows $k-1$ and $k+1$. This is then sent to the GFDM Tx block.

In the GFDM Tx block, the interference cancellation signal is obtained as follows

$$z^{(i)}[n] = (d_{k-1}^{(i),e} \otimes g)[n] \cdot w^{(k-1)n} + (d_{k+1}^{(i),e} \otimes g)[n] \cdot w^{(k+1)n} \quad (14)$$

$z^{(i)}[n]$ is then subtracted from the composite received signal $y[n]$ to get $\hat{y}^{(i)}[n]$, as shown in (8). This mitigates the intercarrier interference from subcarrier $k-1$ and $k+1$.

Now the interference cancelled signal, $\hat{y}^{(i)}[n]$, is digitally subcarrier down converted, filtered with the pulse shaping filter sampled response and down sampled to get the received data symbols for the k^{th} subcarrier. Mathematically, this process can be expressed as follows

$$\hat{y}_k^{(i)}[n] = \hat{y}^{(i)}[n] \cdot w^{-kn} \quad (15)$$

$$\hat{d}_k^{(i+1),N}[n] = (\hat{y}_k^{(i)} \otimes g)[n] \quad (16)$$

$$\hat{d}_k^{(i+1)}[m] = \hat{d}_k^{(i+1),N}[n = mN] \quad (17)$$

For cleaning the $(k+1)^{\text{th}}$ subcarrier, data symbols from the most recent sub-iteration are used.

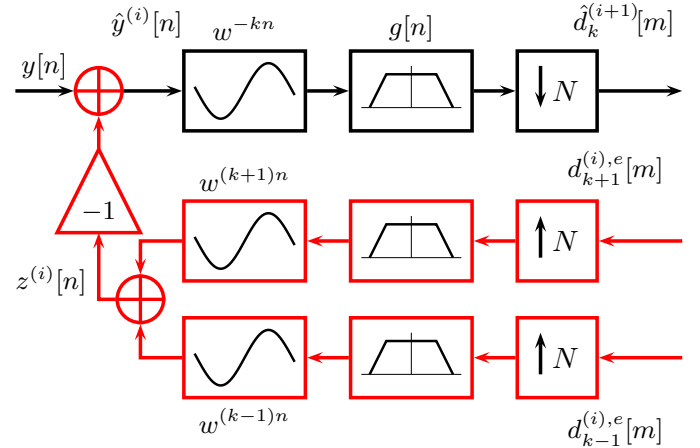

Fig. 7. Double Sided SIC flowchart.

Initially, all K subcarriers are detected. Then in the subiteration, $i = 1$, the ICI due to both the adjacent K^{th} and the 2^{nd} subcarriers are removed from the 1^{st} subcarrier. The ICI cancelled subcarrier 1 is now detected. In the next subiteration, the cleaned 1^{st} subcarrier and the ICI-affected 3^{rd} subcarrier is used to cancel out the ICI on the 2^{nd} subcarrier. Hence, the IC process continues in a similar fashion.

The BER performance of the GFDM system with double sided serial interference cancellation is shown in Fig. 8. The simulation parameters are the same as used in the case of basic SIC and is tabulated in Table 1. The double sided scheme mitigates the intercarrier interference from neighbouring subcarriers as is evident in the improved BER performance compared to [2] and the BER performance matches the theoretical OFDM bit error rate performance. Fig. 8 also shows relative improvement in BER performance that this interference cancellation method brings over the basic SIC. In case of 16 QAM scheme, the double sided SIC uses 3 iterations to completely cancel the ICI and matches the theoretical AWGN BER curve.

In a parallel interference cancellation scheme, received data symbols would be detected all at once to reconstruct the interference cancellation signal through the feedback IC unit and would then be updated all at once in the next iteration. But in the double sided SIC scheme, only two adjacent subcarriers are detected and subsequently the interference cancellation signal is constructed to remove all the ICI introduced by these two adjacent subcarriers. In the double sided SIC scheme, the interference cancelled k^{th} subcarrier is used to estimate the interference on the next subcarriers and this is done successively. Hence the double sided SIC can be considered as a hybrid between pure serial and pure parallel interference cancellation techniques.

C. Complexity Analysis

From the point of view of complexity, let the forward and the cancellation branch complexity be denoted as C_f and C_c for each subcarrier processing and let the number of iterations required be I . When no interference cancellation is done, then the receiver complexity is KC_f . In the basic SIC scheme, initially the $(k-1)^{\text{th}}$ subcarrier is detected first with complexity C_f . Now for the downward serial interference cancellation run, the forwarding and the IC processing is done only once. So the complexity for cancelling out the ICI from one of the adjacent carriers is $C_f + C_c$. Similarly for the upward basic SIC, the complexity is $C_f + C_c$. With K subcarriers, and I iterations, the total complexity is $C_f + 2KI(C_f + C_c)$.

In the double sided SIC, the K subcarriers are detected first with complexity KC_f . Then the ICI from adjacent subcarriers are removed simultaneously with two forwarding and two IC processing. Hence, for all K subcarriers and I iterations, the total complexity is $KC_f + KI(C_f + 2C_c)$. Thus it is seen that for higher iterations, double sided SIC provides better BER performance with lower complexity cost when compared to basic SIC.

An additional complexity cost of $KI(C_f + 2C_c)$ is incurred in the double sided SIC compared to the no interference cancellation, but the IC scheme improves the BER performance of GFDM significantly.

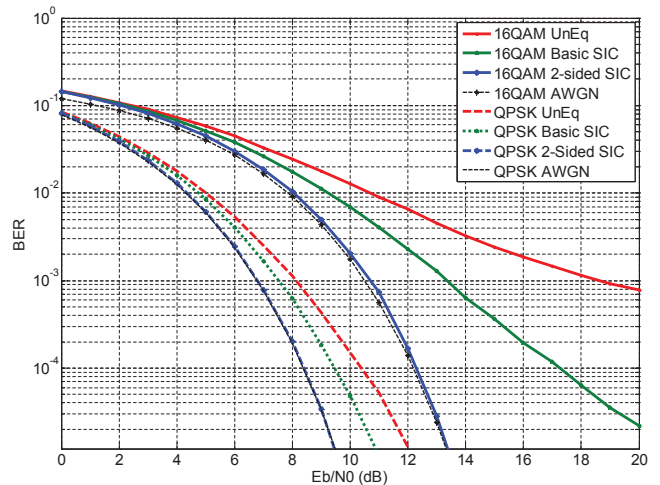

Fig. 8. GFDM Double Sided SIC BER performance.

IV. CONCLUSION

GFDM is a generalization of OFDM and it has an issue of self-ICI. This paper shows the implementation of basic and double sided serial interference cancellation for a GFDM multicarrier system. It is shown that self interference in GFDM is reduced by basic SIC and completely eliminated by double sided SIC. This paper explains the GFDM concept and details the implementation procedure of the interference cancellation algorithms. In an extremely fragmented spectrum, like the recently made available TV white spaces, GFDM can be an attractive option as a physical layer modulation design for cognitive radio application. With its flexibility to choose the pulse shape, so that out-of-band leakage is minimum into the incumbent frequency band of operation, GFDM can be thought of as a next generation PHY design concept.

V. ACKNOWLEDGMENT

The research leading to these results was derived from the European Community's Seventh Framework Program (FP7) under Grant Agreement number 248454 (QoSAMOS).

REFERENCES

- [1] J. Mitola, *Cognitive Radio: An Integrated Agent Architecture for Software Defined Radio*, Ph. D. thesis, Royal Institute of Technology, Stockholm, Sweden, May 2000.
- [2] G. Fettweis, M. Krondorf and S. Bittner, *GFDM - Generalized Frequency Division Multiplexing*, IEEE 69th Vehicular Technology Conference (VTC) Spring 2009.
- [3] N. Michailow, M. Lentmaier, P. Rost and G. Fettweis, *Integration of a GFDM Secondary System in an OFDM Primary System*, in the proceedings of the Future Network and Mobile Summit 2011 (FuNeMS'11), 15-17 June 2011.
- [4] T. Ihalainen, T. H. Stitz, and M. Renfors, *Efficient per-carrier channel equalizer for filter bank based multicarrier systems*, in Proceedings of IEEE International Symposium on Circuits and Systems (ISCAS'05), May 2005.
- [5] Zs. Kollar, G. Peceli and P. Horvath, *Iterative decision feedback equalization for FBMC systems*, in Proceedings of IEEE First International Conference on Advances in Cognitive Radio, (COCORA), April 2011.
- [6] Y. Zhao and S. Haeggman, *Inter-carrier Interference Self-Cancellation Scheme for OFDM Mobile Communication Systems*, in the proceedings of IEEE Transactions on Communications, vol. 49, no. 7, July 2001.
- [7] A. Seyedi and G. Saulnier, *General ICI Self-Cancellation Scheme for OFDM Systems*, in the proceedings of IEEE Transactions on Vehicular Technology, vol. 54, no. 1, Jan 2005.