

Mplus Short Courses  
Topic 4

**Growth Modeling With Latent Variables  
Using Mplus:  
Advanced Growth Models, Survival Analysis,  
And Missing Data**

Linda K. Muthén  
Bengt Muthén

Copyright © 2010 Muthén & Muthén

[www.statmodel.com](http://www.statmodel.com)

06/14/2010

1

**Table Of Contents**

General Latent Variable Modeling Framework	7
Advanced Growth Models	15
Modeling With Zeroes	16
Two-Part Growth Modeling	22
Regression With a Count Dependent Variable	34
Philadelphia Crime Data ZIP Growth Modeling	39
Growth Modeling With Multiple Populations	48
Growth Modeling With Multiple Indicators	78
Embedded Growth Models	100
Power For Growth Models	110
Survival Analysis	130
Discrete-Time Survival Analysis	132
Continuous-Time Survival Analysis	154
Analysis With Missing Data	167
MAR	173
Missing Data Correlates Using ML	193
Non-Ignorable Missing Data	203
Selection Modeling	209
Pattern-Mixture Modeling	212
Multiple Imputation	220
References	224

2

## Mplus Background

- Inefficient dissemination of statistical methods:
  - Many good methods contributions from biostatistics, psychometrics, etc are underutilized in practice
- Fragmented presentation of methods:
  - Technical descriptions in many different journals
  - Many different pieces of limited software
- Mplus: Integration of methods in one framework
  - Easy to use: Simple, non-technical language, graphics
  - Powerful: General modeling capabilities

3

## Mplus Background

- Mplus versions
  - V1: November 1998
  - V2: February 2001
  - V3: March 2004
  - V4: February 2006
  - V5: November 2007
  - V5.21: May 2009
  - V6: April, 2010
- Mplus team: Linda & Bengt Muthén, Thuy Nguyen, Tihomir Asparouhov, Michelle Conn, Jean Maninger

4

## **Statistical Analysis With Latent Variables A General Modeling Framework**

### **Statistical Concepts Captured By Latent Variables**

#### Continuous Latent Variables

- Measurement errors
- Factors
- Random effects
- Frailties, liabilities
- Variance components
- Missing data

#### Categorical Latent Variables

- Latent classes
- Clusters
- Finite mixtures
- Missing data

5

## **Statistical Analysis With Latent Variables A General Modeling Framework (Continued)**

### **Models That Use Latent Variables**

#### Continuous Latent Variables

- Factor analysis models
- Structural equation models
- Growth curve models
- Multilevel models

#### Categorical Latent Variables

- Latent class models
- Mixture models
- Discrete-time survival models
- Missing data models

Mplus integrates the statistical concepts captured by latent variables into a general modeling framework that includes not only all of the models listed above but also combinations and extensions of these models.

6

## General Latent Variable Modeling Framework

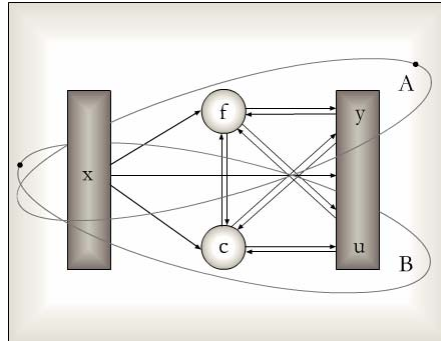

- Observed variables
  - x background variables (no model structure)
  - y continuous and censored outcome variables
  - u categorical (dichotomous, ordinal, nominal) and count outcome variables
- Latent variables
  - f continuous variables
    - interactions among f's
  - c categorical variables
    - multiple c's

7

## General Latent Variable Modeling Framework

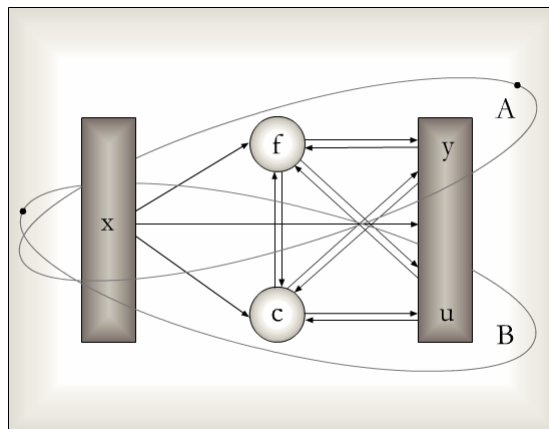

8

## General Latent Variable Modeling Framework

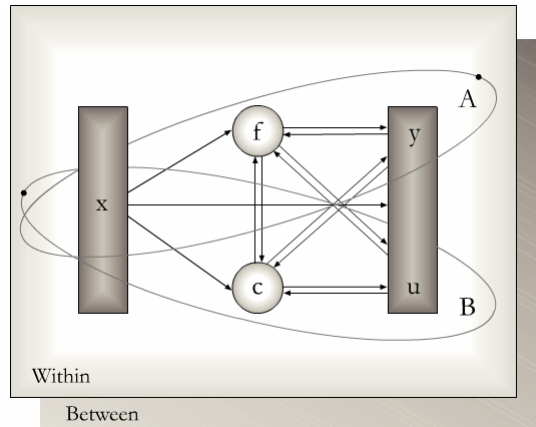

9

## General Latent Variable Modeling Framework

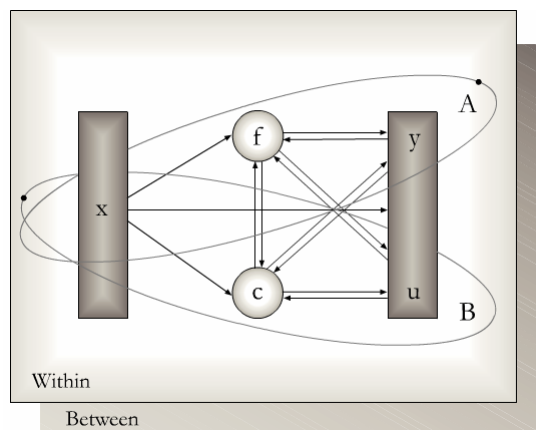

10

## General Latent Variable Modeling Framework

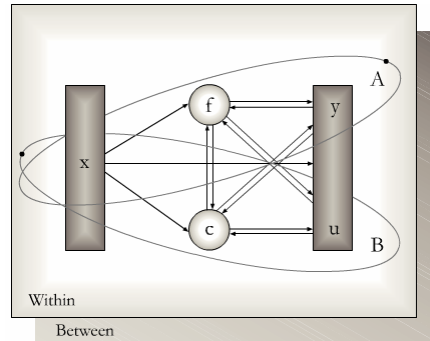

- Observed variables
  - $x$  background variables (no model structure)
  - $y$  continuous and censored outcome variables
  - $u$  categorical (dichotomous, ordinal, nominal) and count outcome variables
- Latent variables
  - $f$  continuous variables
    - interactions among  $f$ 's
  - $c$  categorical variables
    - multiple  $c$ 's

11

## Mplus

Several programs in one

- Exploratory factor analysis
- Structural equation modeling
- Item response theory analysis
- Latent class analysis
- Latent transition analysis
- Survival analysis
- Growth modeling
- Multilevel analysis
- Complex survey data analysis
- Monte Carlo simulation

Fully integrated in the general latent variable framework

12

## Overview Of Mplus Courses

- **Topic 1.** August 20, 2009, Johns Hopkins University: Introductory - advanced factor analysis and structural equation modeling with continuous outcomes
- **Topic 2.** August 21, 2009, Johns Hopkins University: Introductory - advanced regression analysis, IRT, factor analysis and structural equation modeling with categorical, censored, and count outcomes
- **Topic 3.** March 22, 2010, Johns Hopkins University: Introductory and intermediate growth modeling
- **Topic 4.** March 23, 2010, Johns Hopkins University: Advanced growth modeling, survival analysis, and missing data analysis

13

## Overview Of Mplus Courses (Continued)

- **Topic 5.** August 16, 2010, Johns Hopkins University: Categorical latent variable modeling with cross-sectional data
- **Topic 6.** August 17, 2010, Johns Hopkins University: Categorical latent variable modeling with longitudinal data
- **Extra Topic.** August 18, 2010, Johns Hopkins University: What's new in Mplus version 6?
- **Topic 7.** March, 2011, Johns Hopkins University: Multilevel modeling of cross-sectional data
- **Topic 8.** March, 2011, Johns Hopkins University: Multilevel modeling of longitudinal data

14

## **Advanced Growth Modeling**

15

## **Modeling With Zeroes**

16



## Advantages Of Growth Modeling In A Latent Variable Framework

- Flexible curve shape
- Individually-varying times of observation
- Regressions among random effects
- Multiple processes
- **Modeling of zeroes**
- Multiple populations
- Multiple indicators
- Embedded growth models
- Categorical latent variables: growth mixtures

17

## Modeling With A Preponderance Of Zeroes

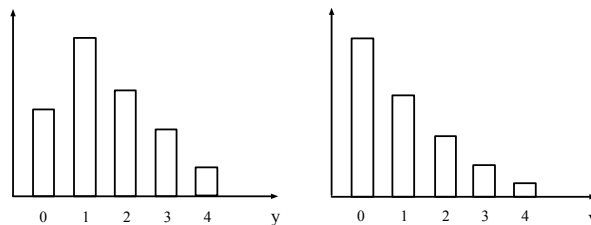

- Outcomes: non-normal continuous – count – categorical
- Censored-normal modeling
- Two-part (semicontinuous modeling): Duan et al. (1983), Olsen & Schafer (2001)
- Mixture models, e.g. zero-inflated (mixture) Poisson (Roeder et al., 1999), censored-inflated, mover-stayer latent transition models, growth mixture models
- Onset (survival) followed by growth: Albert & Shih (2003)

18

## Two-Part (Semicontinuous) Growth Modeling

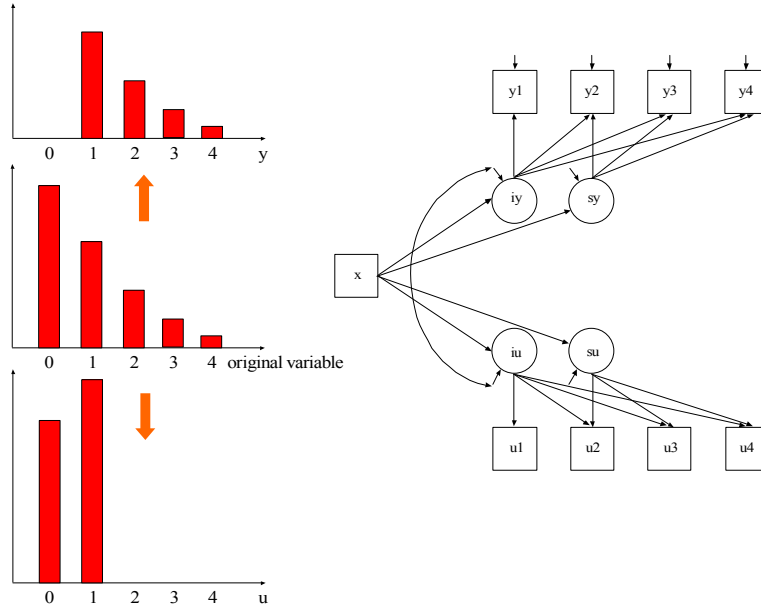

19

## Inflated Growth Modeling (Two Classes At Each Time Point)

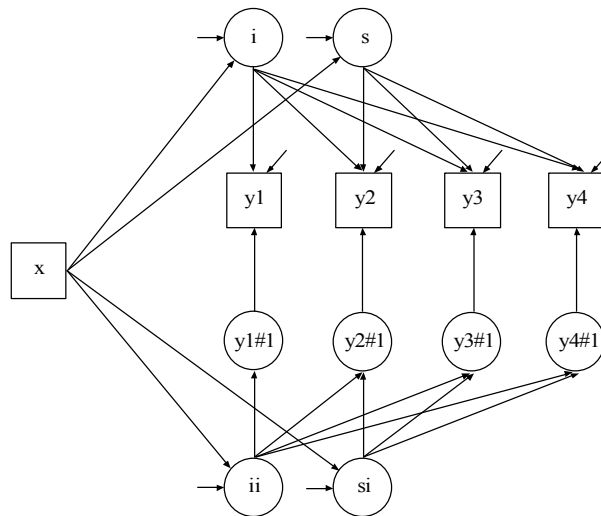

20

## Onset (Survival) Followed By Growth

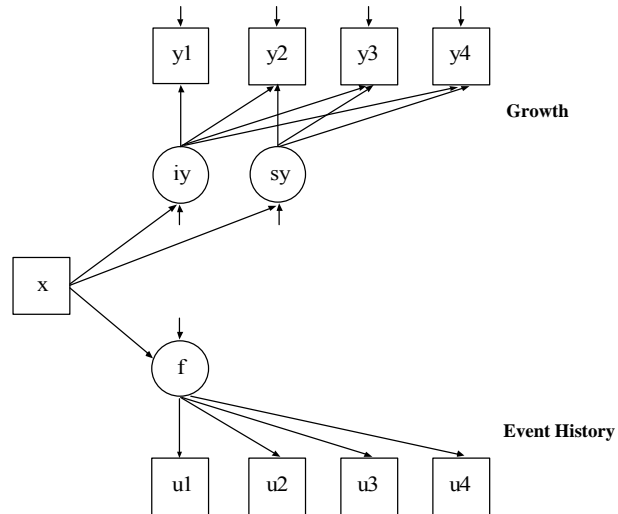

21

## Two-Part Growth Modeling

22

## NLSY Heavy Drinking Data

- The data are from the National Longitudinal Study of Youth (NLSY), a nationally representative household study of 12,686 men and women born between 1957 and 1964.
- There are eight birth cohorts, but the current analysis considers only cohort 64 measured in 1982, 1983, 1984, 1988, 1989, and 1994 at ages 18, 19, 20, 24, and 25.
- The outcome is heavy drinking, measured by the question: How often have you had 6 or more drinks on one occasion during the last 30 days?
- The responses are coded as: never (0); once (1); 2 or 3 times (2); 4 or 5 times (3); 6 or 7 times (4); 8 or 9 times (5); and 10 or more times (6).
- Background variables include gender, ethnicity, early onset of regular drinking (es), family history of problem drinking, high school dropout and college education

23

## NLSY Heavy Drinking Data

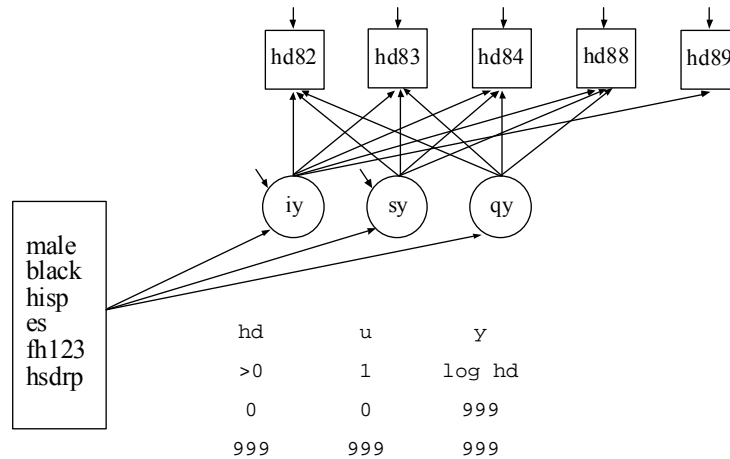

24

## NLSY Heavy Drinking Data

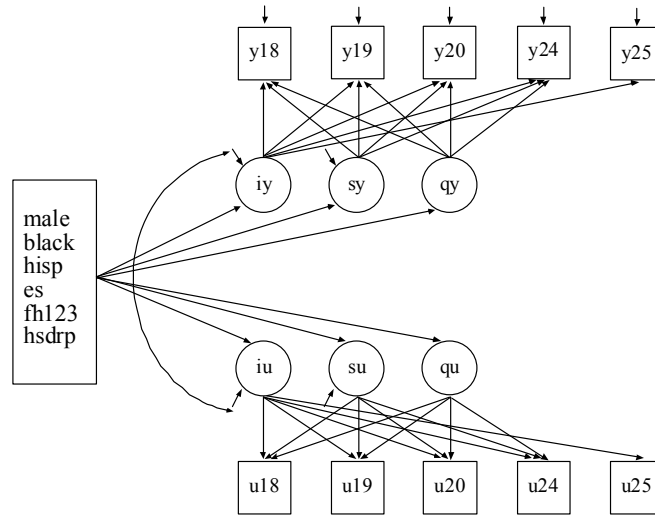

25

## Input For NLSY Heavy Drinking

```
TITLE:  nlsy36425x25dep.inp
        cohort 64
        centering at 25
        hd82-hd89 (ages 18 - 25)
        log age scale:  $x_t = a * (\ln(t-b) - \ln(c-b))$ , where t is
        time, a and b are constants to fit the mean curve
        (chosen as a = 2 and b = 16), and c is the centering
        age, here set at 25.

DATA:   FILE = big.dat;
        FORMAT = 2f5, f2, t14, 5f7, t50, f8, t60, 6f1.0, t67,
        2f2.0, t71, 8f1.0, t79, f2.0, t82, 4f2.0;

DATA TWOPART:
        NAMES = hd82-hd89;
        BINARY = u18 u19 u20 u24 u25;
        CONTINUOUS = y18 y19 y20 y24 y25;
```

26

## Input For NLSY Heavy Drinking (Continued)

```
VARIABLE: NAMES = id houseid cohort weight82 weight83 weight84
           weight88 weight89 weight94 hd82 hd83 hd84 hd88 hd89
           hd94 dep89 dep94 male black hisp es fh1 fh23 fh123
           hsdrp coll ed89 ed94 cd89 cd94;
USEOBSERVATIONS = cohort EQ 64 AND (coll GT 0 AND coll
           LT 20);
USEV = male black hisp es fh123 hsdrp coll u18-u25
           y18-y25;
CATEGORICAL = u18-u25;
MISSING = .;
AUXILIARY = hd82-hd89;
DEFINE: CUT coll (12.1);
ANALYSIS: ESTIMATOR = ML;
           ALGORITHM = INTEGRATION;
           COVERAGE = 0.09;
```

27

## Input For NLSY Heavy Drinking (Continued)

```
MODEL: iu su qu | u18@-3.008 u19@-2.197 u20@-1.621
           u24@-.235 u25@.000;
           iy sy qy | y18@-3.008 y19@-2.197 y20@-1.621 y24@-.235
           y25@.000;
           iu-qy on male black hisp es fh123 hsdrp coll;
OUTPUT: TECH1 TECH4 TECH8 STANDARDIZED;
PLOT: TYPE = PLOT3;
       SERIES = y18-y25(sy) | u18-u25(su);
```

28

## Regular Growth Modeling of NLSY Heavy Drinking

Parameter	Estimate	S.E.	Est./S.E.
-----------	----------	------	-----------

Regular growth modeling, treating outcome as continuous.  
Non-normality robust ML (MLR)

i ON			
male	0.769	0.076	10.066
black	-0.336	0.083	-4.034
hisp	-0.227	0.103	-2.208
<b>es</b>	<b>0.291</b>	<b>0.128</b>	<b>2.283</b>
fh123	0.286	0.137	2.089
hsdrop	-0.024	0.104	-0.232
coll	-0.131	0.086	-1.527

29

## Output Excerpts For Two-Part Growth Modeling of NLSY Heavy Drinking

Parameter	Estimate	S.E.	Est./S.E.
-----------	----------	------	-----------

Two-part growth modeling

iy ON			
male	0.329	0.058	5.651
black	-0.123	0.062	-1.986
hisp	-0.143	0.069	-2.082
<b>es</b>	<b>0.096</b>	<b>0.062</b>	<b>1.543</b>
fh123	0.219	0.076	2.894
hsdrop	0.093	0.063	1.466
coll	-0.030	0.056	-0.526

30

## Output Excerpts For Two-Part Growth Modeling of NLSY Heavy Drinking (Continued)

Parameter	Estimate	S.E.	Est./S.E.
iu ON			
male	1.533	0.164	9.356
black	-0.705	0.172	-4.092
hisp	-0.385	0.199	-1.934
<b>es</b>	<b>0.471</b>	<b>0.194</b>	<b>2.430</b>
fh123	0.287	0.224	1.281
hsdrop	-0.191	0.183	-1.045
coll	-0.325	0.161	-2.017

31

## NLSY Heavy Drinking Conclusions

As an example of differences in results between regular growth modeling and two-part growth modeling, consider the covariate es (early start, that is, early onset of regular drinking scored as 1 if the respondent had 2 or more drinks per week at age 14 or earlier):

Regular growth modeling says that es has a significant, positive influence on heavy drinking at age 25, increasing the frequency of heavy drinking.

Two-part growth modeling says that es has a significant, positive influence on the probability of heavy drinking at age 25, but among those who engage in heavy drinking at age 25 there is no significant difference in heavy drinking frequency with respect to es.

32



## **Output Excerpts For Two-Part Growth Modeling of NLSY Heavy Drinking (Continued)**

Correlations

	iu	su	qu	iy	sy	qy
iu	1.000					
su	0.572	1.000				
qu	0.511	0.923	1.000			
iy	0.945	0.524	0.454	1.000		
sy	-0.140	0.472	0.440	-0.041	1.000	
qy	-0.155	0.375	0.539	-0.101	0.847	1.000

33

## **Regression With A Count Dependent Variable**

34

## Poisson Regression

A Poisson distribution for a count variable  $u_i$  has

$$P(u_i = r) = \frac{\lambda_i^r e^{-\lambda_i}}{r!}, \text{ where } u_i = 0, 1, 2, \dots$$

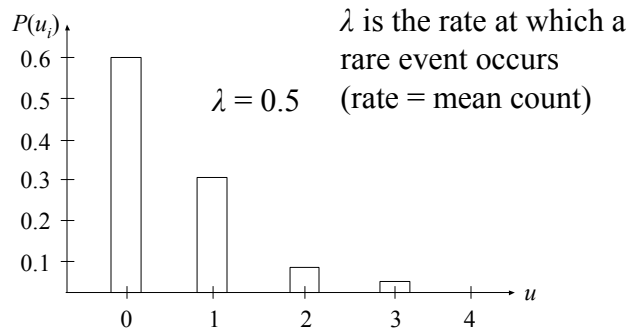

Regression equation for the log rate:

$$\log \lambda_i = \beta_0 + \beta_1 x_i$$

35

## Zero-Inflated Poisson (ZIP) Regression

A Poisson variable has mean = variance.

Data often have variance > mean due to preponderance of zeros.

$\pi = P$  (being in the zero class where only  $u = 0$  is seen)

$1 - \pi = P$  (not being in the zero class with  $u$  following a Poisson distribution)

A mixture at zero:      ZIP mean count:      ZIP variance of count:

$$P(u = 0) = \pi + (1 - \pi) \underbrace{e^{-\lambda}}_{\text{Poisson part}} \quad \lambda (1 - \pi) \quad \lambda (1 - \pi) (1 + \lambda * \pi)$$

The ZIP model implies two regressions:

$$\text{logit}(\pi_i) = \gamma_0 + \gamma_1 x_i,$$

$$\ln \lambda_i = \beta_0 + \beta_1 x_i$$

36

## Negative Binomial Regression

Unobserved heterogeneity  $\varepsilon_i$  is added to the Poisson model

$$\ln \lambda_i = \beta_0 + \beta_1 x_i + \varepsilon_i, \text{ where } \exp(\varepsilon) \sim \Gamma$$

Poisson assumes

$$E(u_i | x_i) = \lambda_i$$

$$V(u_i | x_i) = \lambda_i$$

Negative binomial assumes

$$E(u_i | x_i) = \lambda_i$$

$$V(u_i | x_i) = \lambda_i(1 + \lambda_i \alpha) \quad \text{NB-2}$$

NB with  $\alpha = 0$  gives Poisson. When the dispersion parameter  $\alpha > 0$ , the NB model gives substantially higher probability for low counts and somewhat higher probability for high counts than Poisson.

Further variations are zero-inflated NB and zero-truncated NB (hurdle model or two-part model).

37

## Zero-Inflated Poisson (ZIP) Growth Modeling Of Counts

$$u_{ti} = \begin{cases} 0 & \text{with probability } \pi_{ti} \\ \text{Poisson } (\lambda_{ti}) & \text{with probability } 1 - \pi_{ti} \end{cases}$$

$$\ln \lambda_{ti} = \eta_{0i} + \eta_{1i} a_{ti} + \eta_{2i} a_{ti}^2$$

$$\eta_{0i} = \alpha_0 + \zeta_{0i}$$

$$\eta_{1i} = \alpha_1 + \zeta_{1i}$$

$$\eta_{2i} = \alpha_2 + \zeta_{2i}$$

In Mplus,  $\pi_{ti} = P(u_{\#ti} = 1)$ , where  $u_{\#}$  is a binary latent inflation variable

38

## Philadelphia Crime Data ZIP Growth Modeling

- 13,160 males ages 4 - 26 born in 1958 (Moffitt, 1993; Nagin & Land, 1993)
- Annual counts of police contacts
- Individuals with more than 10 counts in any given year deleted (n=13,126)
- Data combined into two-year intervals

39

## Input Excerpts Philadelphia Crime Data

```
DATA:          FILE = phillywide_zero_ln2006_del.dat;
VARIABLE:     NAMES = cohortid erace sesdummy sescompl juvtot
              adttot
              y10 y12 y14 y16 y18 y20 y22 y24
              sex race;
MISSING = ALL (-9999);
USEVAR = y10 y12 y14 y16 y18 y20 y22 y24;
!y10 is ages 10-11, y12 is ages y12-13, etc
COUNT = y10-y24(i);
IDVAR = cohortid;
USEOBS = y10 LE 10 AND y12 LE 10 AND y14 LE 10 AND
y16 LE 10 AND y18 LE 10 AND y20 LE 10 AND y22 LE 10
AND y24 LE 10;
```

40

## Input Excerpts Philadelphia Crime Data (Continued)

```
ANALYSIS:
!           algorithm = integration;
           PROCESS = 4;
           INTERACTIVE = control.dat;

MODEL:     i s q | y10@0 y12@.1 y14@.2 y16@.3 y18@.4 y20@.5
           y22@.6 y24@.7;

OUTPUT:    TECH1 TECH10;

PLOT:      TYPE = PLOT3;
           SERIES = y10-y24(s);
```

41

## Output Excerpts Philadelphia Crime Data

### TESTS OF MODEL FIT

#### Loglikelihood

H0 Value	-40607.007
H0 Scaling Correlation Factor for MLR	0.931

#### Information Criteria

Number of Free Parameters	17
Akaike (AIC)	81248.155
Bayesian (BIC)	81375.355
Sample-Size Adjusted BIC	81321.330
(n* = (n + 2) / 24)	

42

## Output Excerpts Philadelphia Crime Data (Continued)

	Estimate	S.E.	Est./S.E.	Two-Tailed P-Value
Means				
I	-4.689	0.145	-32.402	0.000
S	14.003	0.749	18.700	0.000
Q	20.036	0.913	21.942	0.000
Y10#1	0.768	0.123	6.268	0.000
Y12#1	-0.557	0.119	-4.679	0.000
Y14#1	-1.763	0.156	-11.322	0.000
Y16#1	-3.023	0.310	-9.746	0.000
Y18#1	-0.284	0.061	-4.638	0.000
Y20#1	-0.319	0.074	-4.293	0.000
Y22#1	-1.521	0.166	-9.156	0.000
Y24#1	-13.723	9.974	-1.376	0.169
				43

## Output Excerpts Philadelphia Crime Data (Continued)

	Estimate	S.E.	Est./S.E.	Two-Tailed P-Value
Intercepts				
Y10	0.000	0.000	999.000	999.000
Y12	0.000	0.000	999.000	999.000
Y14	0.000	0.000	999.000	999.000
Y16	0.000	0.000	999.000	999.000
Y18	0.000	0.000	999.000	999.000
Y20	0.000	0.000	999.000	999.000
Y22	0.000	0.000	999.000	999.000
Y24	0.000	0.000	999.000	999.000
Variances				
I	5.509	0.345	15.960	0.000
S	32.931	4.568	7.206	0.000
Q	59.745	7.603	7.858	0.000
				44

## Output Excerpts Philadelphia Crime Data (Continued)

		Estimate	S.E.	Est./S.E.	Two-Tailed P-Value
S	WITH				
I		-8.320	1.206	-6.896	0.000
Q	WITH				
I		5.864	1.358	4.318	0.000
S		-35.766	5.594	-6.394	0.000

45

## Estimated Mean Counts For Philadelphia Crime Data

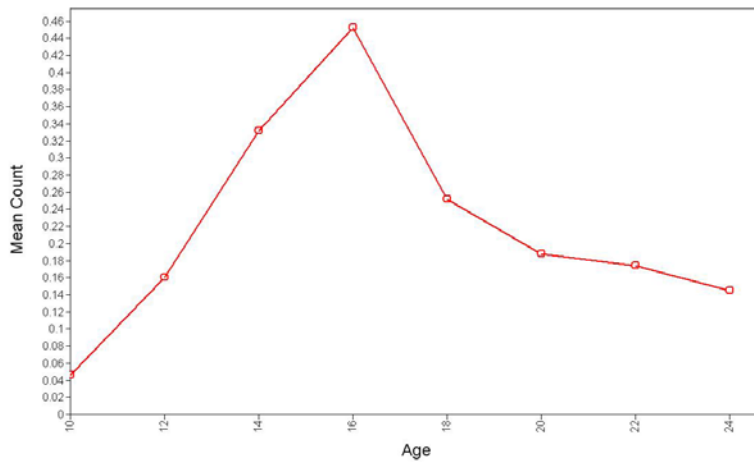

46

## Philadelphia Crime Data Model Fit To Counts For Most Frequent Response Patterns

Pattern	Observed	Estimated	Z Score
00000000	8021	7850	3.04
00010000	572	673	-4.00
00100000	378	433	-2.72
00001000	292	354	-3.32
00000010	203	233	-1.95
00000100	201	266	-4.03
20000000	181	173	0.60
00000001	141	157	-1.27
00110000	117	112	0.50
00020000	107	95	1.28

47

## Growth Modeling With Multiple Populations

48



## **Advantages Of Growth Modeling In A Latent Variable Framework**

- Flexible curve shape
- Individually-varying times of observation
- Regressions among random effects
- Multiple processes
- Modeling of zeroes
- **Multiple populations**
- Multiple indicators
- Embedded growth models
- Categorical latent variables: growth mixtures

49

## **Multiple Population Growth Modeling**

- Group as a dummy variable
- Multiple-group analysis
- Multiple-group analysis of randomized interventions

50

## Group Dummy Variable As A Covariate

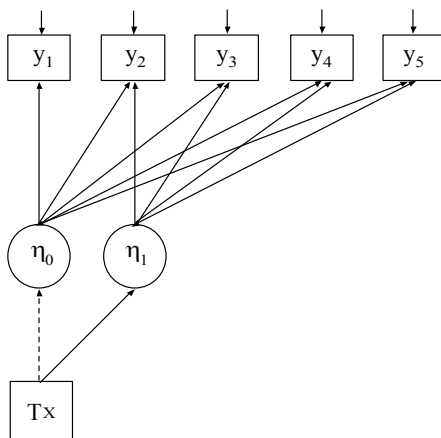

51

## Two-Group Model

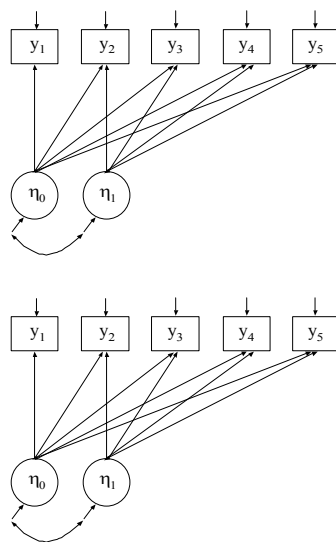

52

## Multiple Population Growth Modeling Specifications

Let  $y_{git}$  denote the outcome for population (group)  $g$ , individual  $i$ , and timepoint  $t$ ,

$$\text{Level 1: } y_{git} = \eta_{g0i} + \eta_{g1i} x_t + \varepsilon_{git}, \quad (65)$$

$$\text{Level 2a: } \eta_{g0i} = \alpha_{g0} + \gamma_{g0} w_{gi} + \zeta_{g0i}, \quad (66)$$

$$\text{Level 2b: } \eta_{g1i} = \alpha_{g1} + \gamma_{g1} w_{gi} + \zeta_{g1i}, \quad (67)$$

Measurement invariance (level-1 equation): time-invariant intercept 0 and slopes 1,  $x_t$

Structural differences (level-2):  $\alpha_g, \gamma_g, V(\zeta_g)$

Alternative parameterization:

$$\text{Level 1: } y_{git} = v + \eta_{g0i} + \eta_{g1i} x_t + \varepsilon_{git}, \quad (68)$$

with  $\alpha_{10}$  fixed at zero in level 2a.

### Analysis steps:

1. Separate growth analysis for each group
2. Joint analysis of all groups, free structural parameters
3. Joint analysis of all groups, tests of structural parameter invariance

53

## NLSY: Multiple Cohort Structure

Birth Year Cohort	Age <sup>a</sup>																			
	18	19	20	21	22	23	24	25	26	27	28	29	30	31	32	33	34	35	36	37
57								82	83	84	85	86	87	88	89	90	91	92	93	94
58							82	83	84	85	86	87	88	89	90	91	92	93	94	
59						82	83	84	85	86	87	88	89	90	91	92	93	94		
60					82	83	84	85	86	87	88	89	90	91	92	93	94			
61				82	83	84	85	86	87	88	89	90	91	92	93	94				
62			82	83	84	85	86	87	88	89	90	91	92	93	94					
63		82	83	84	85	86	87	88	89	90	91	92	93	94						
64	82	83	84	85	86	87	88	89	90	91	92	93	94							

<sup>a</sup> Non-shaded areas represent years in which alcohol measures were obtained

54

## Three Approaches To Cohort Structures

- Single group - using y18 - y37
- Single group - using 7 y's and AT with TSCORES to capture varying ages
- Multiple group - using 7 y's and 8 cohorts with s@xt

55

## Multiple Group Modeling Of Multiple Cohorts

- Data – two cohorts born in 1961 and 1962 measured on the frequency of heavy drinking in the years 1983, 1984, 1988, and 1989
- Development of heavy drinking across chronological age, not year of measurement, is of interest

Cohort/Year	1983	1984	1988	1989
1961 (older)	<b>22</b>	23	<b>27</b>	28
1962 (younger)	21	<b>22</b>	26	<b>27</b>

Cohort/Age	21	22	23	24	25	26	27	28
1961 (older)		<b>83</b>	<b>84</b>				<b>88</b>	<b>89</b>
1962 (younger)	<b>83</b>	<b>84</b>				<b>88</b>	<b>89</b>	

56

## Multiple Group Modeling Of Multiple Cohorts (Continued)

- Time scores calculated for age, not year of measurement

Age	21	22	23	24	25	26	27	28
Time score	0	1	2	3	4	5	6	7

Cohort 1961 time scores 1 2 6 7

Cohort 1962 time scores 0 1 5 6

- Can test the degree of measurement and structural invariance
  - Test of full invariance
    - Growth factor means, variances, and covariances held equal across cohorts
    - Residual variances of shared ages held equal across cohorts

57

## Input For Multiple Group Modeling Of Multiple Cohorts

```
TITLE:           Multiple Group Modeling Of Multiple Cohorts
DATA:            FILE IS cohort.dat;
VARIABLE:       NAMES ARE cohort hd83 hd84 hd88 hd89;
                 MISSING ARE *;
                 USEV = hd83 hd84 hd88 hd89;
                 GROUPING IS cohort (61 = older 62 = younger);
MODEL:          i s | hd83@0 hd84@1 hd88@5 hd89@6;
                 [i] (1);
                 [s] (2);
                 i (3);
                 s (4);
                 i WITH s (5);
```

58

## Input For Multiple Group Modeling Of Multiple Cohorts (Continued)

```
MODEL older:  
      i s | hd83@1 hd84@2 hd88@6 hd89@7;  
      hd83 (6);  
      hd88 (7);  
  
MODEL younger:  
      hd84 (6);  
      hd89 (7);  
  
OUTPUT:      STANDARDIZED;
```

59

## Output Excerpts Multiple Group Modeling Of Multiple Cohorts

### Tests Of Model Fit

Chi-Square Test of Model Fit		
Value		68.096
Degrees of Freedom		17
P-Value		.0000
Chi-Square Contributions From Each Group		
OLDER		39.216
YOUNGER		28.880
Chi-Square Test of Model Fit for the Baseline Model		
Value		3037.930
Degrees of Freedom		12
P-Value		0.0000
CFI/TLI		
CFI		0.983
TLI		0.988

60

## Output Excerpts Multiple Group Modeling Of Multiple Cohorts (Continued)

```

Loglikelihood
  H0 Value          -18544.420
  H1 Value          -18510.371

Information Criteria
  Number of Free Parameters      11
  Akaike (AIC)                   37110.839
  Bayesian (BIC)                  37175.770
  Sample-Size Adjusted BIC       37140.820
    (n* = (n + 2) / 24)

RMSEA (Root Mean Square Error Of Approximation)
  Estimate              0.047
  90 Percent C.I.     0.036  0.059

SRMR (Standardized Root Mean Square Residual)
  Value                0.033
  
```

61

## Output Excerpts Multiple Group Modeling Of Multiple Cohorts (Continued)

### Model Results

	Estimates	S.E.	Est./S.E.	Std	StdYX
<b>Group OLDER</b>					
I					
WITH					
S	-.111	.010	-11.390	-.537	-.537
<b>Residual Variances</b>					
HD83	1.141	.046	24.996	1.141	.445
HD84	1.062	.057	18.489	1.062	.453
HD88	1.028	.041	25.326	1.028	.455
HD89	.753	.053	14.107	.753	.358
<b>Variances</b>					
I	1.618	.068	23.651	1.000	1.000
S	.026	.002	13.372	1.000	1.000
<b>Means</b>					
I	1.054	.030	35.393	.828	.828
S	-.032	.005	-6.611	-.200	-.200

62

## Output Excerpts Multiple Group Modeling Of Multiple Cohorts (Continued)

### GROUP YOUNGER

#### Residual Variances

HD83	1.049	.066	15.916	1.049	.393
HD84	1.141	.046	24.996	1.141	.445
HD88	1.126	.056	19.924	1.126	.491
HD89	1.028	.041	25.326	1.028	.455

63

## Preventive Interventions Randomized Trials

Prevention Science Methodology Group (PSMG)

Developmental Epidemiological Framework:

- Determining the levels and variation in risk and protective factors as well as developmental paths within a defined population in the absence of intervention
- Directing interventions at these risk and protective factors in an effort to change the developmental trajectories in a defined population
- Evaluating variation in intervention impact across risk levels and contexts on proximal and distal outcomes, thereby empirically testing the developmental model

64



## **Aggressive Classroom Behavior: The GBG Intervention**

Muthén & Curran (1997, Psychological Methods)

The Johns Hopkins Prevention Center carried out a school-based preventive intervention randomized trial in Baltimore public schools starting in grade 1. One of the interventions tested was the Good Behavior Game intervention, a classroom based behavior management strategy promoting good behavior. It was designed specifically to reduce aggressive behavior of first graders and was aimed at longer term impact on aggression through middle school.

One first grade classroom in a school was randomly assigned to receive the Good Behavior Game intervention and another matched classroom in the school was treated as control. After an initial assessment in fall of first grade, the intervention was administered during the first two grades.

65

## **Aggressive Classroom Behavior: The GBG Intervention (Continued)**

The outcome variable of interest was teacher ratings (TOCA-R) of each child's aggressive behavior (breaks rules, harms property, fights, etc.) in the classroom through grades 1 – 6. Eight teacher ratings were made from fall and spring for the first two grades and every spring in grades 3 – 6.

The most important scientific question was whether the Good Behavior Game reduces the slope of the aggression trajectory across time. It was also of interest to know whether the intervention varies in impact for children who started out as high aggressive versus low aggressive.

Analyses in Muthén-Curran (1997) were based on data for 75 boys in the GBG group who stayed in the intervention condition for two years and 111 boys in the control group.

66

## The GBG Aggression Example: Analysis Results

Muthén & Curran (1997):

- Step 1: Control group analysis
- Step 2: Treatment group analysis
- Step 3: Two-group analysis w/out interactions
- Step 4: Two-group analysis with interactions
- Step 5: Sensitivity analysis of final model
- Step 6: Power analysis

67

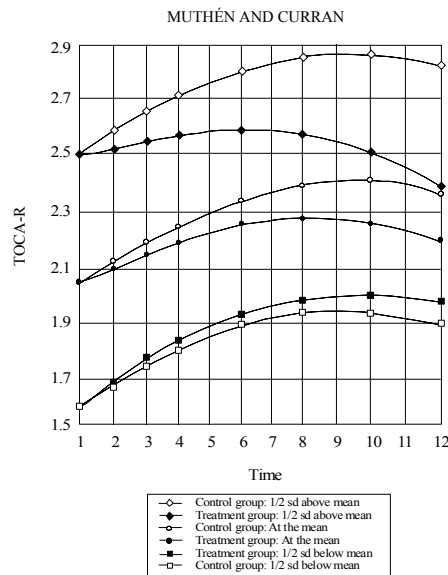
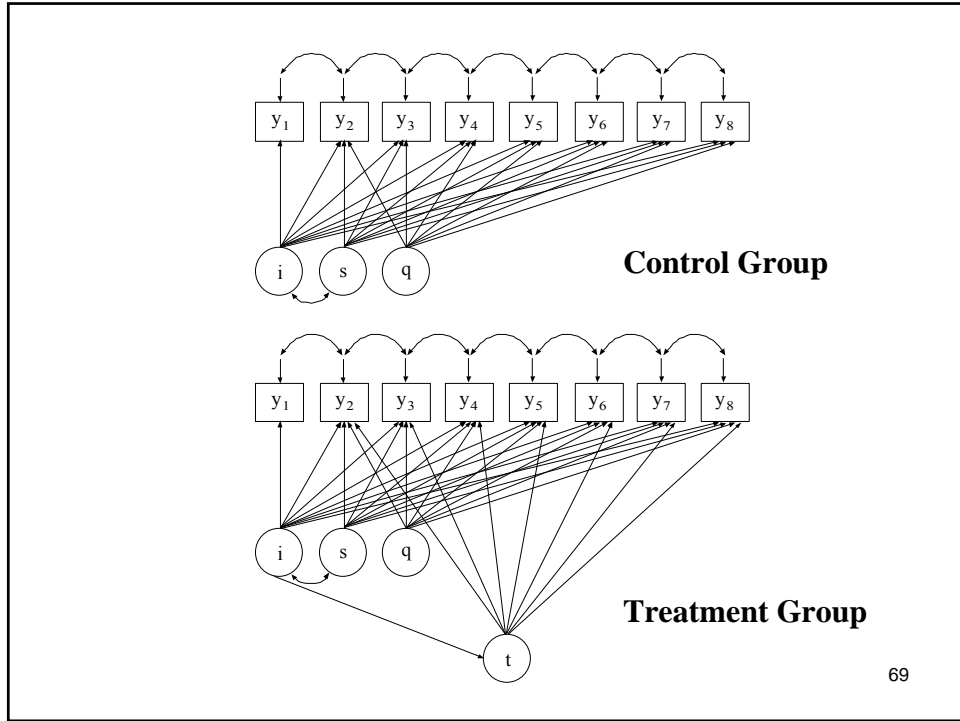

Figure 15. Model implied growth trajectories of Teacher Observation of Classroom Behavior—Revised (TOCA-R) scores as a function of initial status. Each timepoint represents one 6-month interval.

68



**Input Excerpts For Aggressive Behavior Intervention  
Using A Multiple Group Growth Model With A  
Regression Among Random Effects**

```

TITLE:      Aggressive behavior intervention growth model
            n = 111 for control group
            n = 75 for tx group

MODEL:      i s q | y1@0 y2@1 y3@2 y4@3 y5@5 y6@7 y7@9 y8@11;
            i t | y1@0 y2@1 y3@2 y4@3 y5@5 y6@7 y7@9 y8@11;
            [y1-y8] (1);      !alternative growth model
            [i@0];           !parameterization
            i (2);
            s (3);
            i WITH s (4);
            [s] (5);
            [q] (6);
            t@0 q@0;
            q WITH i@0 s@0 t@0; y1-y7 PWITH y2-y8;
            t ON i;
    
```

**Input Excerpts For Aggressive Behavior Intervention  
Using A Multiple Group Growth Model With A  
Regression Among Random Effects (Continued)**

```
MODEL control:  
      t ON i@0;  
      [t@0];
```

71

**Output Excerpts Aggressive Behavior Intervention  
Using A Multiple Group Growth Model With A  
Regression Among Random Effects**

**Tests Of Model Fit**

Chi-Square Test of Model Fit

Value	64.553
Degrees of Freedom	50
P-Value	.0809

RMSEA (Root Mean Square Error Of Approximation)

Estimate	.056
90 Percent C.I.	.000 .092

72

**Output Excerpts Aggressive Behavior Intervention  
Using A Multiple Group Growth Model With A  
Regression Among Random Effects (Continued)**

Group Control		Group Tx	
Observed Variable	R-Square	Observed Variable	R-Square
Y1	.644	Y1	.600
Y2	.642	Y2	.623
Y3	.663	Y3	.568
Y4	.615	Y4	.464
Y5	.637	Y5	.425
Y6	.703	Y6	.399
Y7	.812	Y7	.703
Y8	.818	Y8	.527

73

**Output Excerpts Aggressive Behavior Intervention  
Using A Multiple Group Growth Model With A  
Regression Among Random Effects (Continued)**

Group Control	Estimates	S.E.	Est./S.E.	Std	StdYX
<b>T ON</b>					
I	.000	.000	.000	999.000	999.000
Residual Variances					
Y1	.444	.088	5.056	.444	.356
Y2	.449	.079	5.714	.449	.358
Y3	.414	.069	6.026	.414	.337
Y4	.522	.080	6.551	.522	.385
Y5	.512	.079	6.469	.512	.363
Y6	.422	.074	5.677	.422	.297
Y7	.264	.083	3.186	.264	.188
Y8	.291	.094	3.097	.291	.182
T	.000	.000	.000	999.000	999.000
Variances					
I	.803	.109	7.330	1.000	1.000
S	.004	.001	3.869	1.000	1.000
Q	.000	.000	.000	999.000	999.000

74

**Output Excerpts Aggressive Behavior Intervention  
Using A Multiple Group Growth Model With A  
Regression Among Random Effects (Continued)**

Means	Estimates	S.E.	Est./S.E.	Std	StdYX
I	.000	.000	.000	.000	.000
S	.086	.021	4.035	1.285	1.285
Q	-.005	.002	-3.005	999.000	999.000
Intercepts					
Y1	2.041	.078	26.020	2.041	1.828
Y2	2.041	.078	26.020	2.041	1.823
Y3	2.041	.078	26.020	2.041	1.841
Y4	2.041	.078	26.020	2.041	1.753
Y5	2.041	.078	26.020	2.041	1.718
Y6	2.041	.078	26.020	2.041	1.711
Y7	2.041	.078	26.020	2.041	1.724
Y8	2.041	.078	26.020	2.041	1.612
T	.000	.000	.000	999.000	999.000

75

**Output Excerpts Aggressive Behavior Intervention  
Using A Multiple Group Growth Model With A  
Regression Among Random Effects (Continued)**

Group Tx	Estimates	S.E.	Est./S.E.	Std	StdYX
<b>T ON</b>					
I	<b>-.052</b>	<b>.015</b>	<b>-3.347</b>	<b>-1.000</b>	<b>-1.000</b>
Residual Variances					
Y1	.535	.141	3.801	.535	.400
Y2	.439	.122	3.595	.439	.377
Y3	.501	.108	4.653	.501	.432
Y4	.701	.132	5.332	.701	.536
Y5	.736	.133	5.545	.736	.575
Y6	.805	.152	5.288	.805	.601
Y7	.245	.104	2.364	.245	.297
Y8	.609	.182	3.351	.609	.473
T	.000	.000	.000	.000	.000
Variances					
I	.803	.109	7.330	1.000	1.000
S	.004	.001	3.869	1.000	1.000
Q	.000	.000	.000	999.000	999.000

76

**Output Excerpts Aggressive Behavior Intervention  
Using A Multiple Group Growth Model With A  
Regression Among Random Effects (Continued)**

Means	Estimates	S.E.	Est./S.E.	Std	StdYX
I	.000	.000	.000	.000	.000
S	.086	.021	4.035	1.285	1.285
Q	-.005	.002	-3.005	999.000	999.000
<b>Intercepts</b>					
Y1	2.041	.078	26.020	2.041	1.764
Y2	2.041	.078	26.020	2.041	1.893
Y3	2.041	.078	26.020	2.041	1.895
Y4	2.041	.078	26.020	2.041	1.785
Y5	2.041	.078	26.020	2.041	1.805
Y6	2.041	.078	26.020	2.041	1.764
Y7	2.041	.078	26.020	2.041	2.248
Y8	2.041	.078	26.020	2.041	1.799
T	-.016	.013	-1.225	-.341	-.341

77

**Growth Modeling With Multiple Indicators**

78

## Advantages Of Growth Modeling In A Latent Variable Framework

- Flexible curve shape
- Individually-varying times of observation
- Regressions among random effects
- Multiple processes
- Modeling of zeroes
- Multiple populations
- **Multiple indicators**
- Embedded growth models
- Categorical latent variables: growth mixtures

79

## Growth Of Latent Variable Construct Measured By Multiple Indicators

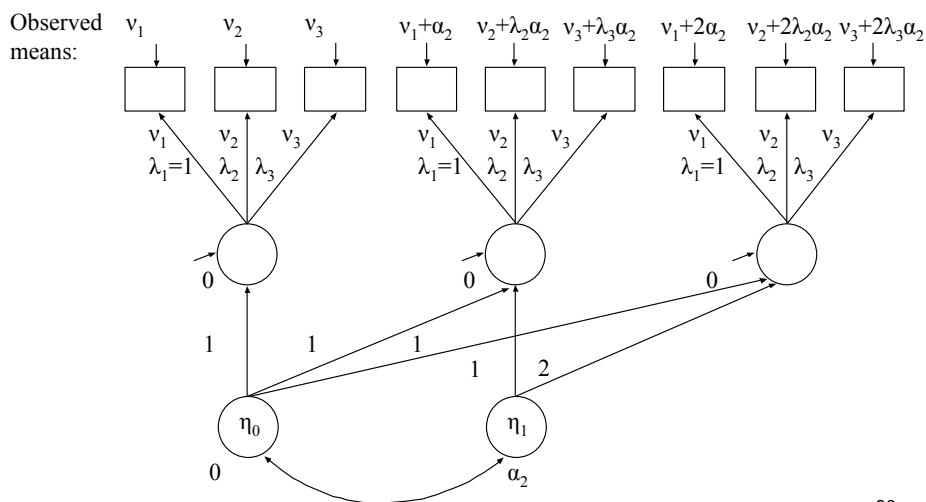

80



## Multiple Indicator Growth Modeling Specifications

Let  $y_{jti}$  denote the outcome for individual  $i$ , indicator  $j$ , and timepoint  $t$ , and let  $\eta_{ti}$  denote a latent variable construct,

*Level 1a (measurement part):*

$$y_{jti} = v_{jt} + \lambda_{jt} \eta_{ti} + \varepsilon_{jti}, \quad (44)$$

$$\text{Level 1b : } \eta_{ti} = \eta_{0i} + \eta_{1i} x_t + \zeta_{ti}, \quad (45)$$

$$\text{Level 2a : } \eta_{0i} = \alpha_0 + \gamma_0 w_i + \zeta_{0i}, \quad (46)$$

$$\text{Level 2b : } \eta_{1i} = \alpha_1 + \gamma_1 w_i + \zeta_{1i}, \quad (47)$$

Measurement invariance: time-invariant indicator intercepts and slopes:

$$v_{j1} = v_{j2} = \dots v_{jT} = v_j, \quad (48)$$

$$\lambda_{j1} = \lambda_{j2} = \dots \lambda_{jT} = \lambda_j, \quad (49)$$

where  $\lambda_1 = 1$ ,  $\alpha_0 = 0$ .  $V(\varepsilon_{jti})$  and  $V(\zeta_{ti})$  may vary over time.

Structural differences:  $E(\eta_{ti})$  and  $V(\eta_{ti})$  vary over time.

81

## Steps In Growth Modeling With Multiple Indicators

- Exploratory factor analysis of indicators for each timepoint
- Determine the shape of the growth curve for each indicator and the sum of the indicators
- Fit a growth model for each indicator—must be the same
- Confirmatory factor analysis of all timepoints together
  - Covariance structure analysis without measurement parameter invariance
  - Covariance structure analysis with invariant loadings
  - Mean and covariance structure analysis with invariant measurement intercepts and loadings
- Growth model with measurement invariance across timepoints

82

## **Advantages Of Using Multiple Indicators Instead Of An Average**

- Estimation of unequal weights
- No need to assume full measurement invariance:
  - Partial measurement invariance—changes across time in individual item functioning
- No confounding of time-specific variance and measurement error variance
- Smaller standard errors for growth factor parameters (more power)

83

## **Classroom Aggression Data (TOCA)**

The classroom aggression data are from an intervention study in Baltimore public schools carried out by the Johns Hopkins Prevention Research Center. Subjects were randomized into treatment and control conditions. The TOCA-R instrument was used to measure 10 aggression items at multiple timepoints. The TOCA-R is a teacher rating of student behavior in the classroom. The items are rated on a six-point scale from almost never to almost always.

Data for this analysis include the 342 boys in the control group. Four time points are examined: Spring Grade 1, Spring Grade 2, Spring Grade 3, and Spring Grade 4.

Seven aggression items are used in the analysis:

- Break rules
- Lies
- Yells at others
- Fights
- Stubborn
- Harms others
- Teasing classmates

84

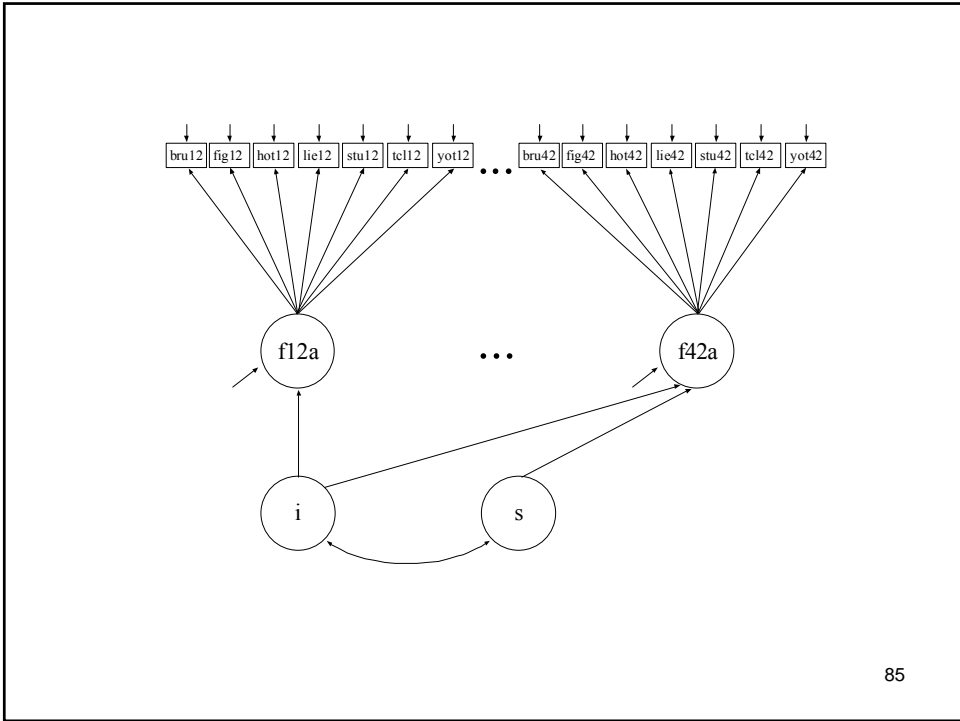

**Input Excerpts For TOCA Data Multiple Indicator CFA With No Measurement Invariance**

```

TITLE:      Multiple indicator CFA with no measurement invariance
.
.
.
MODEL:      f12a BY bru12-yot12;
            f22a BY bru22-yot22;
            f32a BY bru32-yot32;
            f42a BY bru42-yot42;

```

## **Input Excerpts For TOCA Data Multiple Indicator CFA With Factor Loading Invariance**

```
TITLE:      Multiple indicator CFA with factor loading invariance
.
.
.
MODEL:      f12a BY bru12
              fig12-yot12 (1-6);
            f22a BY bru22
              fig22-yot22 (1-6);
            f32a BY bru32
              fig32-yot32 (1-6);
            f42a BY bru42
              fig42-yot42 (1-6);
```

87

## **Input Excerpts For TOCA Data Multiple Indicator CFA With Factor Loading And Intercept Invariance**

```
TITLE:      Multiple indicator CFA with factor loading and intercept
              incariance
.
.
.
MODEL:      f12a BY bru12
              fig12-yot12 (1-6);
            f22a BY bru22
              fig22-yot22 (1-6);
            f32a BY bru32
              fig32-yot32 (1-6);
            f42a BY bru42
              fig42-yot42 (1-6);
```

88

**Input Excerpts For TOCA Data Multiple Indicator  
CFA With Factor Loading And Intercept Invariance  
(Continued)**

```
[bru12 bru22 bru32 bru42] (7);  
[fig12 fig22 fig32 fig42] (8);  
[hot12 hot22 hot32 hot42] (9);  
[lie12 lie22 lie32 lie42] (10);  
[stu12 stu22 stu32 stu42] (11);  
[tcl12 tcl22 tcl32 tcl42] (12);  
[yot12 yot22 yot32 yot42] (13);  
  
[f12a@0 f22a f32a f42a];
```

89

**Input Excerpts For TOCA Data Multiple Indicator  
CFA With Factor Loading Invariance And  
Partial Intercept Invariance**

```
TITLE: Multiple indicator CFA with factor loading and partial  
intercept invariance  
  
MODEL: f12a BY bru12  
fig12-yot12 (1-6);  
f22a BY bru22  
fig22-yot22 (1-6);  
f32a BY bru32  
fig32-yot32 (1-6);  
f42a BY bru42  
fig42-yot42 (1-6);
```

90

## Input Excerpts For TOCA Data Multiple Indicator CFA With Factor Loading Invariance And Partial Intercept Invariance (Continued)

```
[bru12 bru22 bru32 bru42] (7);
[fig12 fig22 fig32 fig42] (8);
[hot12 hot22 hot32   ] (9);
[lie12 lie22 lie32 lie42] (10);
[stu12 stu22         ] (11);
[tcl12 tcl122 tcl132 ] (12);
[yot12 yot22 yot32 yot42] (13);

[f12a@0 f22a f32a f42a];
```

91

## Summary of Analysis Results For TOCA Measurement Invariance Models

Model	Chi-Square (d.f.)	Difference (d.f. diff.)
Measurement non-invariance	567.08 (344)	
Factor loading invariance	581.29 (362)	14.21 (18)
Factor loading and intercept invariance	654.59 (380)	73.30* (18)
Factor loading and partial intercept invariance	606.97 (376)	25.68* (14)
Factor loading and partial intercept invariance with a linear growth structure	614.74 (381)	7.77 (5)

92

## Summary of Analysis Results For TOCA Measurement Invariance Models (Continued)

### Explanation of Chi-Square Differences

Factor loading invariance	(18)	6 factor loadings instead of 24
Factor loading and intercept invariance	(18)	7 intercepts plus 3 factor means instead of 28 intercepts
Factor loading and partial intercept invariance	(14)	4 additional intercepts
Factor loading and partial intercept invariance with a linear growth structure	(5)	1 growth factor mean instead of 3 factor means 2 growth factor variances, 1 growth factor covariance, 4 factor residual variances instead of 10 factor variances/covariances

93

## Input Excerpts For TOCA Data Multiple Indicator CFA With Factor Loading And Intercept Invariance With A Linear Growth Structure

```

MODEL:      f12a BY bru12
            fig12-yot12 (1-6);
            f22a BY bru22
            fig22-yot22 (1-6);
            f32a BY bru32
            fig32-yot32 (1-6);
            f42a BY bru42
            fig42-yot42 (1-6);

```

94

## Input Excerpts For TOCA Data Multiple Indicator CFA With Factor Loading And Intercept Invariance With A Linear Growth Structure (Continued)

```
[bru12 bru22 bru32 bru42] (7);
[fig12 fig22 fig32 fig42] (8);
[hot12 hot22 hot32      ] (9);
[lie12 lie22 lie32 lie42] (10);
[stu12 stu22          ] (11);
[tcl12 tcl22 tcl32    ] (12);
[yot12 yot22 yot32 yot42] (13);
```

```
i s | f12a@0 f22a@1 f32a@2 f42a@3;
```

Alternative language:

```
i BY f12a-f42a@1;
s BY f12a@0 f22a@1 f32a@2 f42a@3;
[f12a-f42a@0 i@0 s];
```

95

## Output Excerpts For TOCA Data Multiple Indicator CFA With Factor Loading And Intercept Invariance With A Linear Growth Structure

	Estimates	S.E.	Est./S.E.	Std	StdYX
F12A BY					
BRU12	1.000	.000	.000	.190	.786
FIG12	1.097	.039	28.425	.208	.868
HOT12	.986	.037	26.586	.187	.811
LIE12	.967	.041	23.769	.184	.742
STU12	.880	.041	21.393	.167	.667
TCL12	1.034	.039	26.206	.196	.786
YOT12	.932	.039	23.647	.177	.709
Intercepts					
STU12	.331	.013	25.408	.331	1.324
STU22	.331	.013	25.408	.331	1.231
STU32	.417	.017	24.345	.417	1.592
STU42	.390	.017	23.265	.390	1.496

96



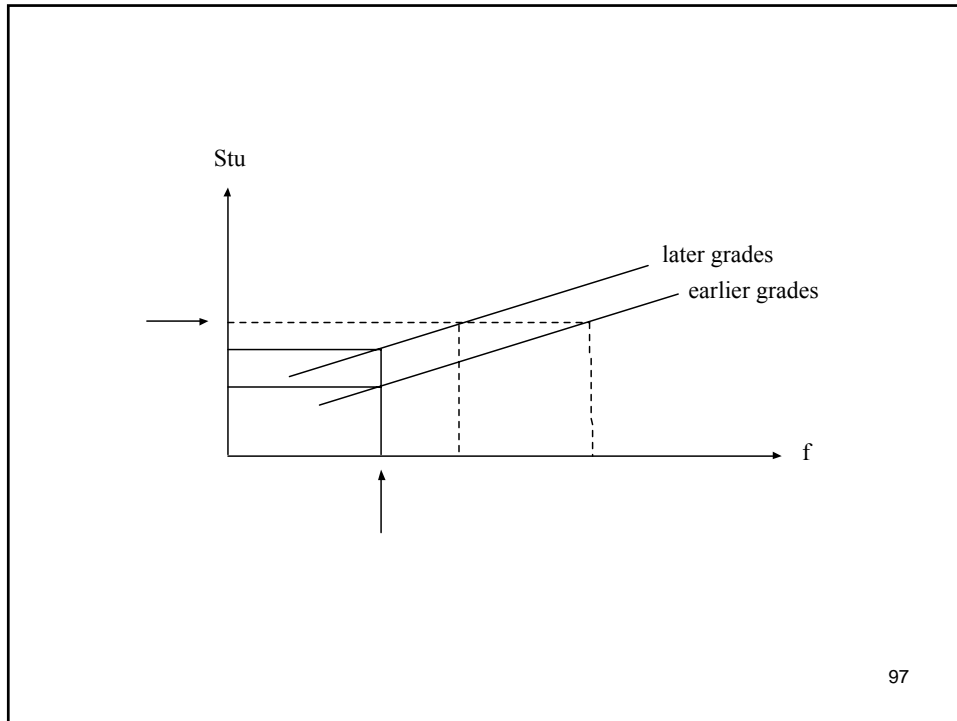

## Degrees Of Invariance Across Time

- Case 1
  - Same items
  - All items invariant
  - Same construct
- Case 2
  - Same items
  - Some items non-invariant
  - Same construct
- Case 3
  - Different items
  - Some items invariant
  - Same construct
- Case 4
  - Different items
  - Some items invariant
  - Different construct

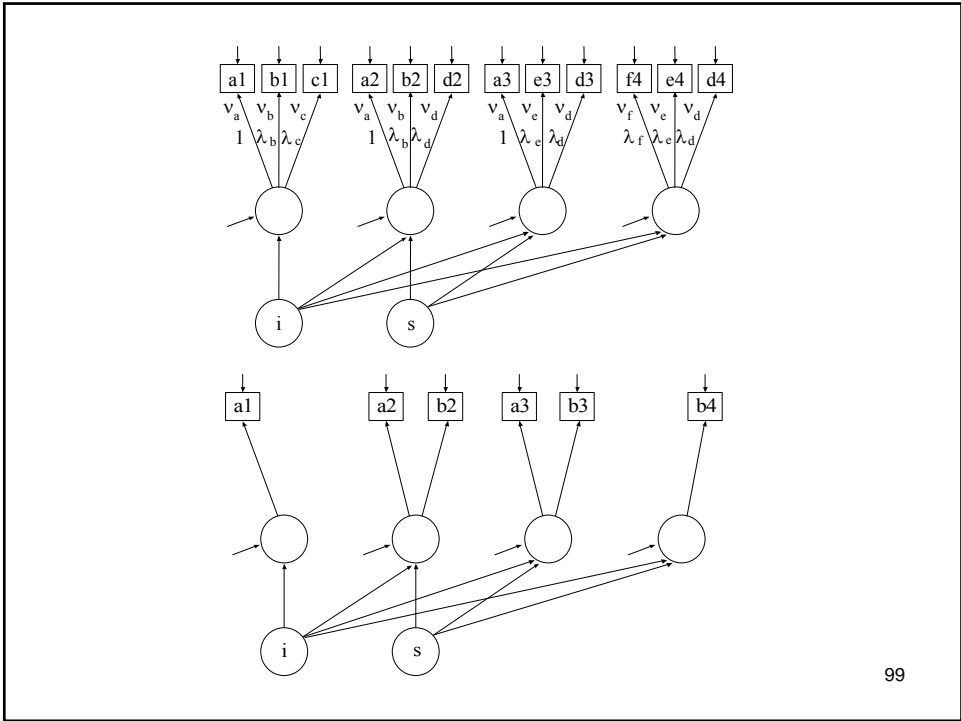

**Embedded Growth Models**

## Advantages Of Growth Modeling In A Latent Variable Framework

- Flexible curve shape
- Individually-varying times of observation
- Regressions among random effects
- Multiple processes
- Modeling of zeroes
- Multiple populations
- Multiple indicators
- **Embedded growth models**
- Categorical latent variables: growth mixtures

101

## Growth Modeling With Time-Varying Covariates

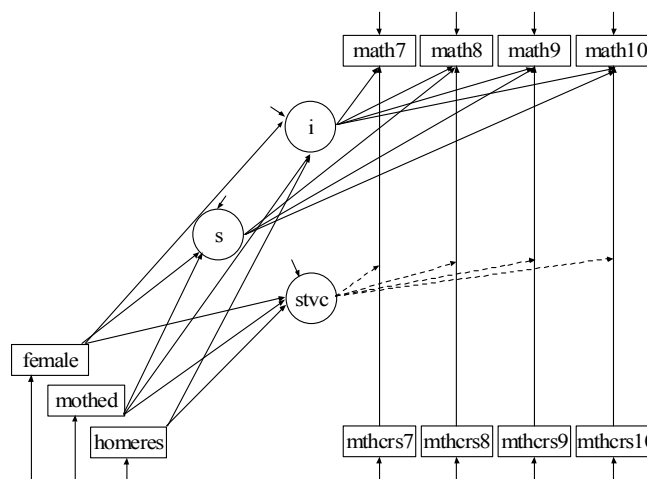

102

## A Generalized Growth Model

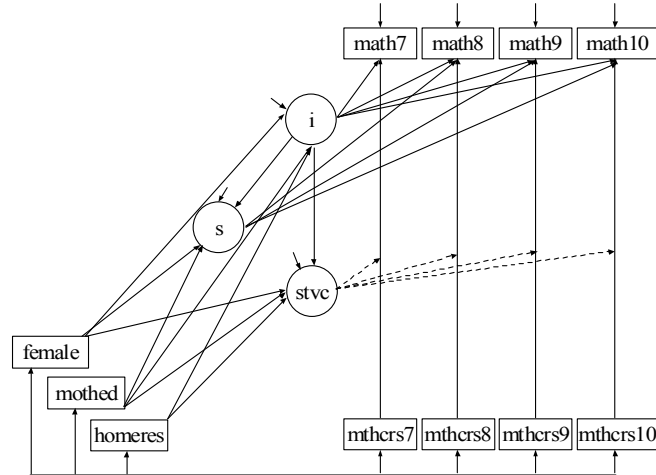

103

## A Generalized Growth Model

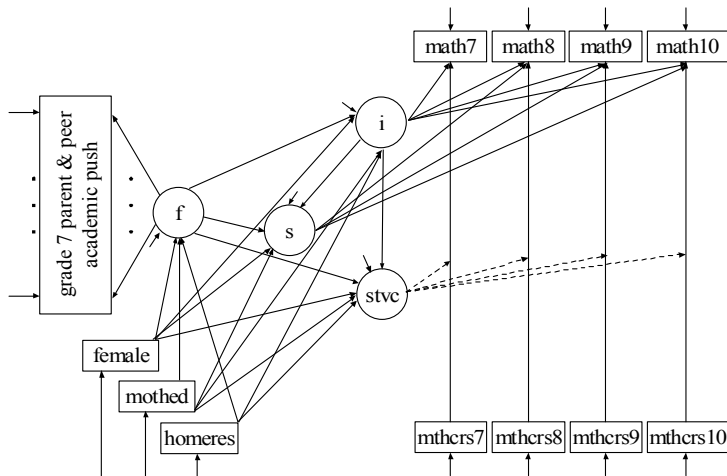

104

## A Generalized Growth Model

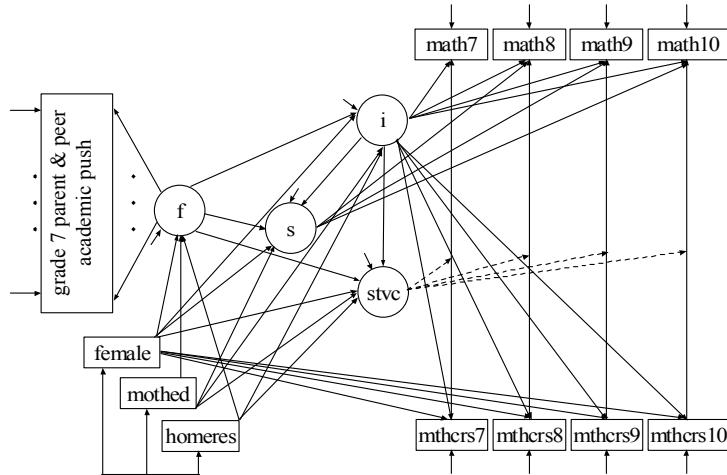

105

## A Generalized Growth Model

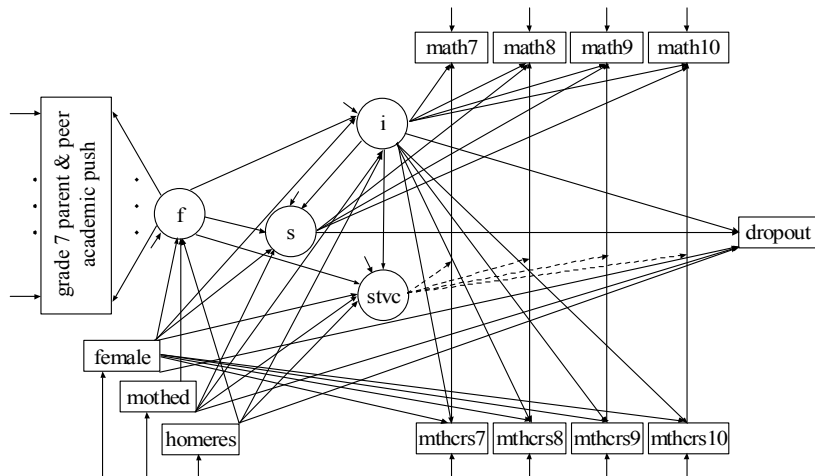

106

## Two Linked Processes

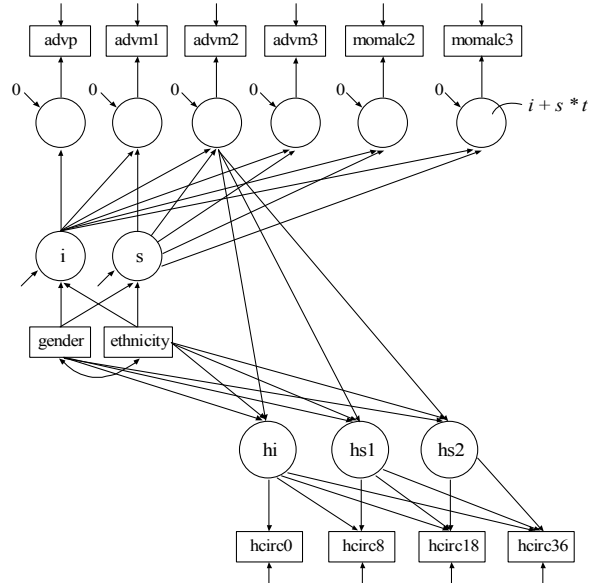

107

## Input Excerpts For Two Linked Processes With Measurement Error In The Covariates

TITLE: Embedded growth model with measurement error in the covariates and sequential processes  
 advp: mother's drinking before pregnancy  
 advm1-advm3: drinking in first trimester  
 momalc2-momalc3: drinking in 2nd and 3rd trimesters  
 hcirc0-hcirc36; head circumference

MODEL: fadvp BY advp; fadvp@0;  
 fadvm1 BY advm1; fadvm1@0;  
 fadvm2 BY advm2; fadvm2@0;  
 fadvm3 BY advm3; fadvm3@0;  
 fmomalc2 BY momalc2; fmomalc2@0;  
 fmomalc3 BY momalc3; fmomalc3@0;  
 i BY fadvp-fmomalc3@1;  
 s BY fadvp@0 fadvm1@1 fadvm2\*2 fadvm3\*3  
 fmomalc2-fmomalc3\*5 (1);  
 [advp-momalc3@0 fadvp-fmomalc3@0 i s];

108

## **Input Excerpts For Two Linked Processes With Measurement Error In The Covariates (Continued)**

```
advp WITH advm1; advm1 WITH advm2; advm3 WITH advm2;

i s ON gender eth; s WITH i;

hi BY hcirc0-hcirc36@1;
hs1 BY hcirc0@0 hcirc8@1.196 hcirc36@1.196 hcirc36@1.196;
hs2 BY hcirc0@0 hcirc8@0 hcirc18@1 hcirc36*2;

[hcirc0-hcirc36@0 hi*34 hs1 hs2];

hs1 WITH hs2@0; hi WITH hs2@0; hi WITH hs1@0;
hi WITH i@0; hi WITH s@0; hs1 WITH i@0;
hs1 WITH s@0; hs2 WITH i@0; hs2 WITH s@0;

hi-hs2 ON gender eth fadv2;
```

109

## **Power For Growth Models**

110

## Designing Future Studies: Power

- Computing power for growth models using Satorra-Saris (Muthén & Curran, 1997; examples)
- Computing power using Monte Carlo studies (Muthén & Muthén, 2002)
- Power calculation web site – PSMG
- Multilevel power (Miyazaki & Raudenbush, 2000; Moerbeek, Breukelen & Berger, 2000; Raudenbush, 1997; Raudenbush & Liu, 2000)
- School-based studies (Brown & Liao, 1999: Principles for designing randomized preventive trials)
- Multiple- (sequential-) cohort power
- Designs for follow-up (Brown, Indurkha, & Kellam, 2000)

111

## Designing Future Studies: Power

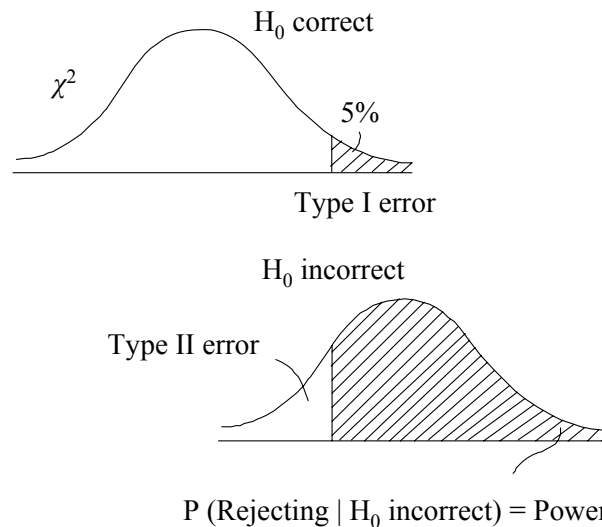

112



## Power Estimation For Growth Models Using Satorra & Saris (1985)

- Step 1: Create mean vector and covariance matrix for hypothesized parameter values
- Step 2: Analyze as if sample statistics and check that parameter values are recovered
- Step 3: Analyze as if sample statistics, misspecifying the model by fixing treatment effect(s) at zero
- Step 4: Use printed  $\chi^2$  as an appropriate noncentrality parameter and computer power.

Muthén & Curran (1997): Artificial and real data situations.

113

## Input For Step 1 Of Power Calculation

```
TITLE:      Power calculation for a growth model
            Step 1: Computing the population means and
            covariance matrix

DATA:       FILE IS artific.dat;
            TYPE IS MEANS COVARIANCE;
            NOBSERVATIONS = 500;

VARIABLE:   NAMES ARE y1-y4;

MODEL:      i s | y1@0 y2@1 y3@2 y4@3;
            i@.5;
            s@.1;
            i WITH s@0;
            y1-y4@.5;

OUTPUT:     STANDARDIZED RESIUDAL;
```

114

## Data For Step 1 Of Power Calculation (Continued)

```
0 0 0 0
1
0 1
0 0 1
0 0 0 1
```

115

## Input For Step 2 Of Power Calculation

```
TITLE:      Power calculation for a growth model
            Step 2: Analyzing the population means and
            covariance matrix to check that parameters are
            recovered

DATA:       FILE IS pop.dat;
            TYPE IS MEANS COVARIANCE;
            NOBSERVATIONS = 500;

VARIABLE:   NAMES ARE y1-y4;

MODEL:      i s | y1@0 y2@1 y3@2 y4@3;

OUTPUT:     STANDARDIZED RESIUDAL;
```

116

## Data For Step 2 Of Power Calculation (Continued)

### Data From Step 1 Residual Output

```
0 .2 .4 .6
1
.5 1.1
.5 .7 1.4
.5 .8 1.1 1.9
```

117

## Input For Step 3 Of Power Calculation

```
TITLE:      Power calculation for a growth model
            Step 3: Analyzing the population means and
            covariance matrix with a misspecified model

DATA:       FILE IS pop.dat;
            TYPE IS MEANS COVARIANCE;
            NOBSERVATIONS = 50;

VARIABLE:   NAMES ARE y1-y4;

MODEL:      i s | y1@0 y2@1 y3@2 y4@3;

OUTPUT:     STANDARDIZED RESIUDAL;
```

118

## Step 4 Of Power Calculation

### Output Excerpt From Step 3

Chi-Square Test of Model Fit

Value	9.286
Degrees of Freedom	6
P-Value	.1580

### Power Algorithm in SAS

```
DATA POWER;  
DF=1; CRIT=3.841459;  
LAMBDA=9.286;  
Power=(1 - (PROBCHI(CRIT, DF, LAMBDA)));  
RUN;
```

119

## Step 4 Of Power Calculation (Continued)

### Results From Power Algorithm

SAMPLE SIZE	POWER
44	0.80
50	0.85
100	0.98
200	0.99

**Note:** Non-centrality parameter =  
printed chi-square value from Step 3 =  
 $2 * \text{sample size} * F$

120

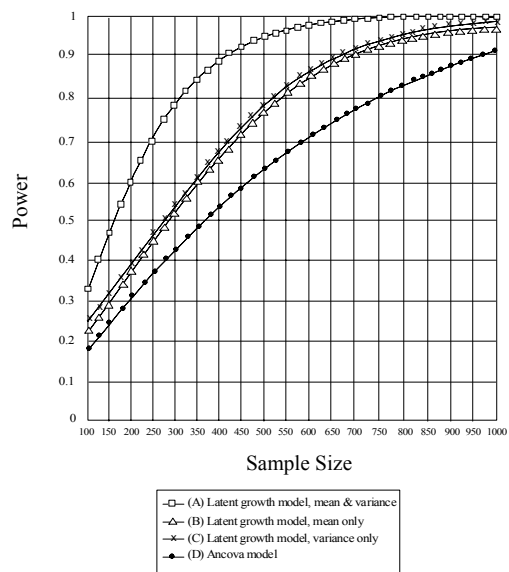

Figure 6. Power to detect a main effect of  $ES = .20$  assessed at Time 5.

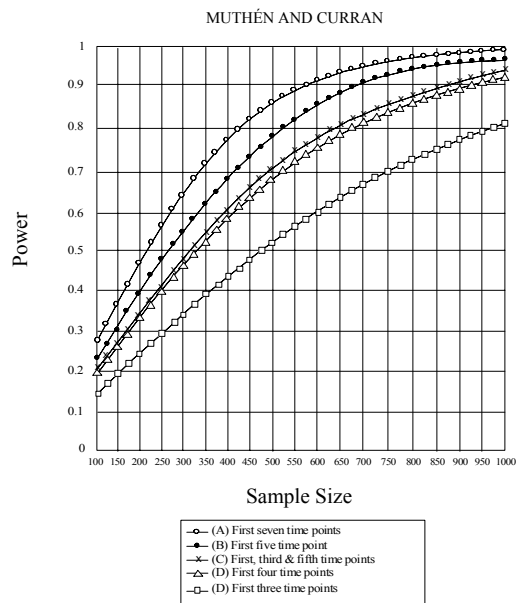

Figure 7. Power to detect a main effect of  $ES = .20$  assessed at Time 5 varying as a function of total number of measurement occasions.

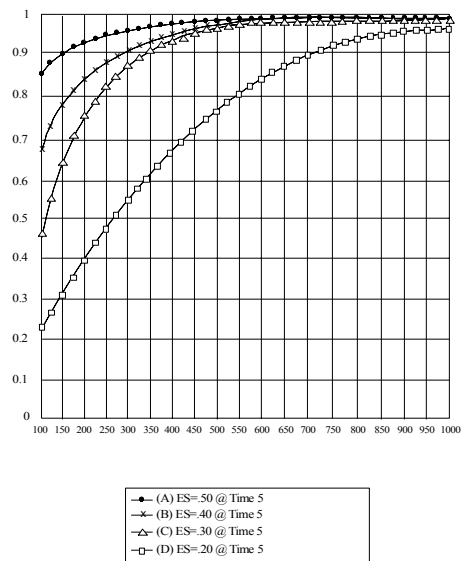

Figure 8. Power to detect various effect sizes assessed at Time 5 based on the first five measurement occasions

## Power Estimation For Growth Models Using Monte Carlo Studies

Muthén, L.K. and Muthén, B.O. (2002). How to use a Monte Carlo study to decide on sample size and determine power. Structural Equation Modeling, 4, 599-620.

## Input Power Estimation For Growth Models Using Monte Carlo Studies

```
TITLE:          This is an example of a Monte Carlo
                simulation study for a linear growth model
                for a continuous outcome with missing data
                where attrition is predicted by time-
                invariant covariates (MAR)

MONTECARLO:    NAMES ARE y1-y4 x1 x2;
                NOBSERVATIONS = 500;
                NREPS = 500;
                SEED = 4533;
                CUTPOINTS = x2(1);
                MISSING = y1-y4;
```

125

## Input Power Estimation For Growth Models Using Monte Carlo Studies (Continued)

```
MODEL POPULATION:  x1-x2@1;
                   [x1-x2@0];
                   i s | y1@0 y2@1 y3@2 y4@3;
                   [i*1 s*2];
                   i*1; s*.2; i WITH s*.1;
                   y1-y4*.5;
                   i ON x1*1 x2*.5;
                   s ON x1*.4 x2*.25;

MODEL MISSING:     [y1-y4@-1];
                   y1 ON x1*.4 x2*.2;
                   y2 ON x1*.8 x2*.4;
                   y3 ON x1*1.6 x2*.8;
                   y4 ON x1*3.2 x2*1.6;
```

126

## Input Power Estimation For Growth Models Using Monte Carlo Studies (Continued)

```

MODEL:      i s | y1@0 y2@1 y3@2 y4@3;
            [i*1 s*2];
            i*1; s*.2; i WITH s*.1;
            y1-y4*.5;
            i ON x1*1 x2*.5;
            s ON x1*.4 x2*.25;

OUTPUT:    TECH9;
    
```

127

## Output Excerpts Power Estimation For Growth Models Using Monte Carlo Studies

### Model Results

		ESTIMATES			S.E.	M. S. E.	95% Cover	%Sig Coeff
		Population	Average	Std. Dev.				
I	ON							
	X1	1.000	1.0032	0.0598	0.0579	0.0036	0.936 1.000	
	X2	0.500	0.5076	0.1554	0.1570	0.0241	0.952 0.908	
S	ON							
	X1	0.400	0.3980	0.0366	0.0349	0.0013	0.936 1.000	
	X2	0.250	0.2469	0.0865	0.0877	0.0075	0.938 0.830	

128



## **Cohort-Sequential Designs and Power**

Considerations:

- Model identification
- Number of timepoints needed substantively
- Number of years of the study
- Number of cohorts: More gives longer timespan but greater risk of cohort differences
- Number of measurements per individual
- Number of individuals per cohort
- Number of individuals per age

Tentative conclusion:

Power most influenced by total timespan, not the number of measures per cohort

129

## **Survival Analysis**

130

## **Survival Analysis**

- Discrete-time
  - Infrequent measurement (monthly, annually)
  - Limited number of time periods
- Continuous-time
  - Frequent measurement (hourly, daily)
  - Large number of time points

131

## **Discrete-Time Survival Analysis**

132

## Discrete-Time Survival Analysis

Other terms: event history analysis, time-to-event.

References: Allison (1984), Singer & Willet (1993), Vermunt (1997).

- Setting
  - Discrete time periods (e.g. grade), non-repeatable event (e.g. onset of drug use)
  - Uncensored and censored individuals
  - Time-invariant and time-varying covariates
- Aim
  - Estimate survival curves and hazard probabilities
  - Relate survival to covariates
- Generalized models using multiple latent classes of survival
  - Long-term survivors with zero hazard
  - Growth mixture modeling in combination with survival analysis
- Application: School removal and aggressive behavior in the classroom (Muthén & Masyn, 2005). Grade 1 sample,  $n = 403$  control group children.

133

## Data For Discrete-Time Survival Analysis

- Single non-repeatable event – data collection ends for individual  $i$  when the event has been observed, where  $j_i$  is the last time period of data collection for individual  $i$
- $u_{ij}$  ( $j = 1, 2, \dots, j_i$ ) are binary 0/1 event history indicators, where  $u_{ij} = 1$  if individual  $i$  experiences an event in time period  $j$

Event history information entered into an  $r \times 1$  data vector  $\mathbf{u}_i$  where  $r$  denotes the maximum value of  $j_i$  over all individuals and where  $u = 999$  denotes missing data.

134

## Data For Discrete-Time Survival Analysis (Continued)

Examples:

- An individual who is censored after time period five ( $j_i = 6$ )  
( 0 0 0 0 0 ),
- An individual who experiences the event in period four ( $j_i = 4$ )  
( 0 0 0 1 999 ),
- An individual who drops out after period three, i.e. is censored during period four before the study ends ( $j_i = 4$ )  
( 0 0 0 999 999 ).

135

## Model For Discrete-Time Survival Analysis

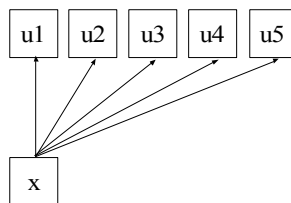

136

## Hazard, Survival, Likelihood

The hazard is the probability of experiencing the event in the time period  $j$  given that it was not experienced prior to  $j$ . Letting the time of the event for individual  $i$  be denoted  $T_i$ , the logistic hazard function with  $q$  covariates  $x$  is

$$P(u_{ij} = 1) = P(T_i = j | T_i \geq j) = h_{ij} = \frac{1}{1 + e^{-(\tau_j + \kappa_j x_i)}}, \quad (49)$$

where a proportional-odds assumption is obtained by dropping the  $j$  subscript for  $\kappa_j$ . The survival function is

$$S_{ij} = \prod_{k=1}^j (1 - h_{ik}). \quad (50)$$

137

## Hazard, Survival, Likelihood (Continued)

The likelihood  $L = \prod_{i=1}^n l_i$ , where

$$l_i = \prod_{j=1}^{j_i} h_{ij}^{u_{ij}} (1 - h_{ij})^{1 - u_{ij}}. \quad (51)$$

A censored individual is observed with probability

$$l_i = \prod_{j=1}^{j_i} (1 - h_{ij}). \quad (52)$$

An uncensored individual experiences the event in time period  $j_i$  with probability

$$l_i = h_{ij_i} \prod_{j=1}^{j_i-1} (1 - h_{ij}). \quad (53)$$

138

## School Removal Data (n = 403)

Gender	Grade	No School removal	At least one school removal	Sample Hazard
Male	1	0	4	4/200 = 0.02
	2	0	5	5/196 = 0.03
	3	0	7	7/191 = 0.04
	4	0	6	6/184 = 0.03
	5	0	14	14/178 = 0.08
	6	0	14	14/164 = 0.08
	7	122	28	28/150 = 0.19
	<b>Total</b>		<b>122</b>	<b>78</b>
Female	1	0	0	0/203 = 0.00
	2	0	1	1/203 = 0.005
	3	0	1	1/202 = 0.005
	4	0	3	3/201 = 0.01
	5	0	1	1/198 = 0.005
	6	0	9	9/197 = 0.05
	7	157	31	31/188 = 0.16
	<b>Total</b>		<b>157</b>	<b>46</b>

139

## Hazard Sample Estimates

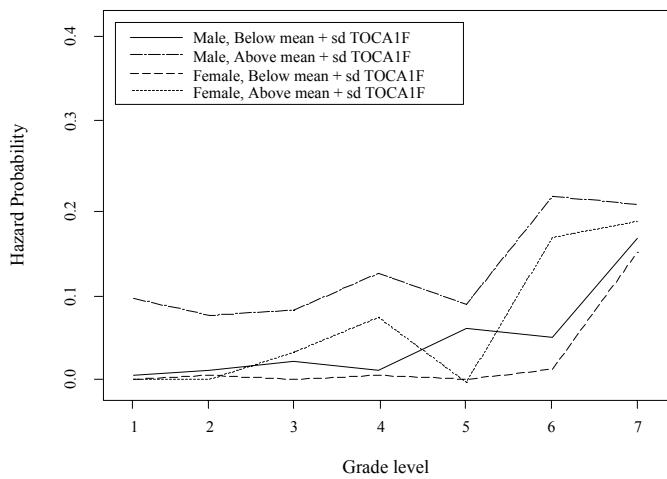

140

## Survival Sample Estimates

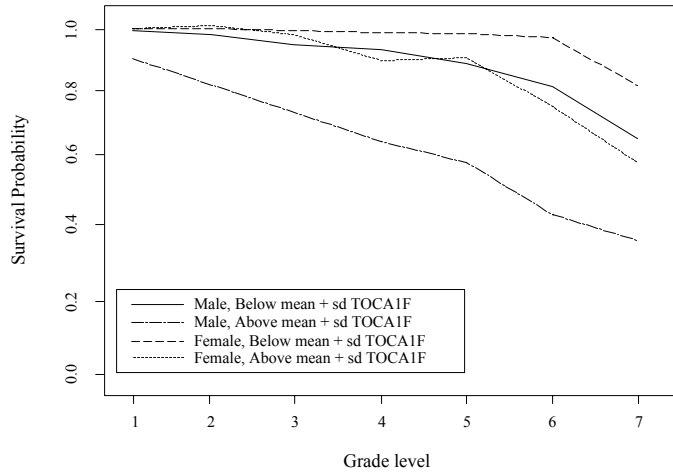

141

## Discrete-Time Survival Models

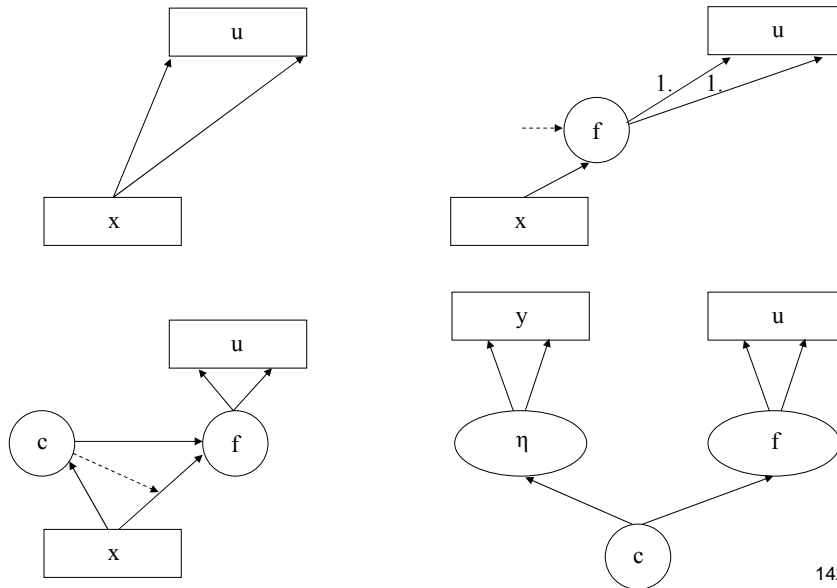

142

## Input For A Discrete-Time Survival Analysis

```
TITLE:          A discrete-time survival analysis
DATA:           FILE IS survival.dat;
VARIABLE:       NAMES ARE u1-u7 race lunch cavtoca cavlunch
                cntrlg y1 gender;
                MISSING are all (999);
                CATEGORICAL ARE u1-u7;
ANALYSIS:       ESTIMATOR = MLR;
MODEL:          f BY u1-u7@1;
                f ON race-gender;
                f@0;
OUTPUT:         TECH1 TECH8;
```

143

## Output Excerpts A Discrete-Time Survival Analysis

### Tests Of Model Fit

Loglikelihood		
	H0 Value	-388.074
Information Criteria		
	Number of Free Parameters	14
	Akaike (AIC)	804.147
	Bayesian (BIC)	860.132
	Sample-Sized Adjusted BIC ( $n^* = (n + 2)/24$ )	815.709

144



## Output Excerpts A Discrete-Time Survival Analysis (Continued)

### Model Results

	Estimates	S.E.	Est./S.E.
<b>Thresholds</b>			
U1\$1	4.707	0.694	6.782
U2\$1	4.118	0.782	5.269
U3\$1	3.764	0.658	5.725
U4\$1	3.588	0.648	5.537
U5\$1	2.958	0.677	4.371
U6\$1	2.382	0.625	3.809
U7\$1	1.048	0.609	1.721
<b>F ON</b>			
RACE	-0.449	0.379	-1.183
LUNCH	-0.136	0.268	-0.506
CAVTOCA	-1.104	0.295	-3.738
CAVLUNCH	1.571	0.476	3.302
CNTRLG	-0.336	0.213	-1.578
Y1	0.783	0.119	6.566
GENDER	-0.700	0.206	-3.402

145

## Multiple Latent Classes

Muthén & Masyn (2005)

Unobserved heterogeneity in hazard and survival

- Long-term survivors (one class has zero hazards, non-zero long-term survival probability)
- Latent classes of survival
- Growth mixtures and survival

Example: Long-term survivors

Individuals who are not censored, i.e. who experience the event within the observation period, are not long-term survivors (known latent class membership).

Two different latent classes of censored individuals:

*Eventually experiences the event* : 0...0|0...0 1

*Long-term survivor* : 0...0|0...0

146

## Input For A Two-Class Discrete-Time Survival Analysis

```
TITLE:      A 2-class discrete-time survival analysis in a
            mixture modeling framework including long-term
            survivors

DATA:      FILE IS long.sav;

VARIABLE:  NAMES ARE u1-u7 race lunch cavtoca cavlunch
            cntrlg y1 gender t1 t2;

            MISSING ARE ALL (999);

            CATEGORICAL ARE u1-u7;
            CLASSES = c(2);

            TRAINING = t1 t2;

ANALYSIS:  TYPE = MIXTURE;
```

147

## Input For A Two-Class Discrete-Time Survival Analysis (Continued)

```
MODEL:      %OVERALL%

            f BY u1-u7@1;
            f ON race-gender;
            [f@0];
            c#1 ON race-gender;

            %c#1% ! class of non-long-term survivors

            [u1$1*4 u2$1*3 u3$1*3 u4$1*3.5 u5$1*2.5 u6$1*4 u7$1*1];
            [f@0];
            f ON race-gender;

            %c#2% ! class of long-term survivors

            [u1$1-u7$1@10];
            f ON race-gender@0;

OUTPUT:    PATTERNS TECH1 TECH8;
```

148

## Output Excerpts A Two-Class Discrete-Time Survival Analysis

### Tests Of Model Fit

Loglikelihood		
H0 Value		-375.951
Information Criteria		
Number of Free Parameters		22
Akaike (AIC)		795.903
Bayesian (BIC)		883.879
Sample-Sized Adjusted BIC ( $n^* = (n + 2)/24$ )		814.071
Entropy		0.644

149

## Output Excerpts A Two-Class Discrete-Time Survival Analysis (Continued)

### Classification Information

FINAL CLASS COUNTS AND PROPORTIONS OF TOTAL SAMPLE SIZE

Class 1	201.96062	0.50114
Class 2	201.03938	0.49886

CLASSIFICATION OF INDIVIDUALS BASED ON THEIR MOST LIKELY CLASS MEMBERSHIP

Class Counts and Proportions

Class 1	190	0.47146
Class 2	213	0.52854

Average Latent Class Probabilities for Most Likely Latent Class Membership (Row) by Latent Class (Column)

	1	2
Class 1	0.916	0.084
Class 2	0.131	0.869

150

## Output Excerpts A Two-Class Discrete-Time Survival Analysis (Continued)

### Model Results

	Estimates	S.E.	Est./S.E.
Class 1			
Thresholds			
U1\$1	4.590	0.809	5.673
U2\$1	4.060	0.928	4.376
U3\$1	3.654	0.804	4.542
U4\$1	3.402	0.756	4.498
U5\$1	2.656	0.764	3.477
U6\$1	1.866	0.708	2.634
U7\$1	-0.026	0.841	-0.030

151

## Output Excerpts A Two-Class Discrete-Time Survival Analysis (Continued)

C#1	ON			
RACE		-1.099	0.552	-1.990
LUNCH		0.446	0.712	0.627
CAVTOCA		-2.459	0.824	-2.983
CAVLUNCH		2.907	1.470	1.977
CNTRLG		-0.101	0.498	-0.204
Y1		0.913	0.301	3.036
GENDER		0.150	0.665	0.226
Intercepts				
C#1		1.773	1.411	1.257
Class 1				
F	ON			
RACE		0.882	0.511	1.728
LUNCH		-0.679	0.550	-1.236
CAVTOCA		-0.234	0.642	-0.365
CAVLUNCH		0.540	0.809	0.667
CNTRLG		-0.441	0.355	-1.242
Y1		0.605	0.218	2.774
GENDER		-1.141	0.510	-2.237

152

## **Further Readings On Discrete-Time Survival Analysis**

- Allison, P.D. (1984). Event history analysis. Regression for Longitudinal Event Data. Quantitative Applications in the Social Sciences, No. 46. Thousand Oaks: Sage Publications.
- Masyn, K. E. (2008). Modeling measurement error in event occurrence for single, non-recurring events in discrete-time survival analysis. In Hancock, G. R., & Samuelsen, K. M. (Eds.), Advances in latent variable mixture models, pp. 105-145. Charlotte, NC: Information Age Publishing, Inc.
- Muthén, B. & Masyn, K. (2005). Discrete-time survival mixture analysis. Journal of Educational and Behavioral Statistics, 30, 27-28.
- Singer, J.D., & Willett, J.B. (1993). It's about time: Using discrete-time survival analysis to study duration and the timing of events. Journal of Educational Statistics, 18(2), 155-195.
- Singer, J. D. & Willett, J. B. (2003). Applied longitudinal analysis. Modeling change and event occurrence. Oxford, UK: Oxford University Press.
- Vermunt, J.K. (1997). Log-linear models for event histories. Advanced quantitative techniques in the social sciences, vol 8. Thousand Oaks: 153 Sage Publications.

## **Continuous-Time Survival Analysis**

## Kaplan-Meier Survival Curves

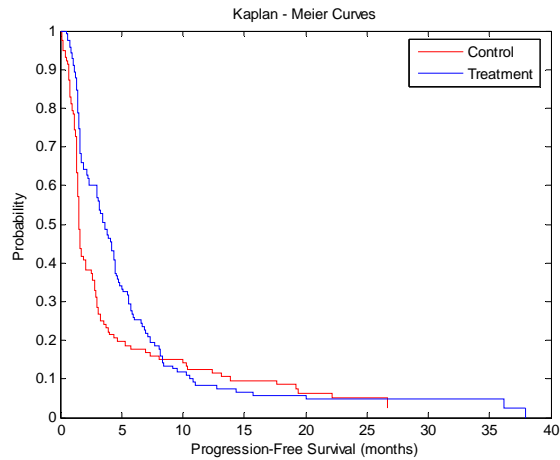

155

## Continuous-Time Survival Analysis

- $T_0$ : time-to-event such as time to death
- $I$ : time of censoring
- The survival variable  $T$  and the censoring indicator  $c$  are defined by

$$T = \min\{T_0, I\} \quad (1)$$

$$c = \begin{cases} 1 & \text{if } T_0 > I \\ 0 & \text{if } T_0 \leq I \end{cases} \quad (2)$$

For example,  $c = 1$  implies  $T = I$ , the time the individual leaves the sample

156

## The Proportional Hazard Model

The proportional hazard (PH) model specifies that the hazard function is proportional to the baseline hazard function,

$$h(t) = \lambda(t) \text{Exp}(\beta X) \quad (3)$$

$$\log h(t) = \log \lambda(t) + \beta X \quad (4)$$

Two proportional hazard models:

- Nonparametric shape for the baseline hazard function  $\lambda(t)$ :  
Cox regression
- Parametric model for the baseline hazard function  $\lambda(t)$ :  
parametric PH model

157

## Example 6.21: Continuous-Time Survival Analysis Using The Cox Regression Model

```
TITLE:      this is an example of a continuous-time survival
            analysis using the Cox regression model

DATA:      FILE = ex.6.21.dat;

VARIABLE:  NAMES = t x tc;
            SURVIVAL = t (ALL);
            TIMECENSORED = tc (0 = NOT 1 = RIGHT);

MODEL:     t ON x;
```



158

## Survival Curves For Kaplan-Meier Versus Cox Proportional Hazard Model

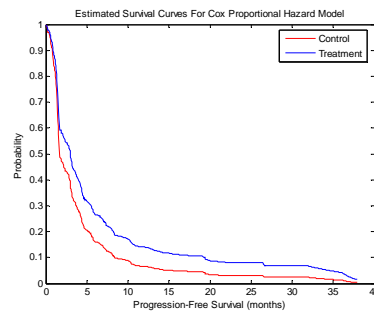
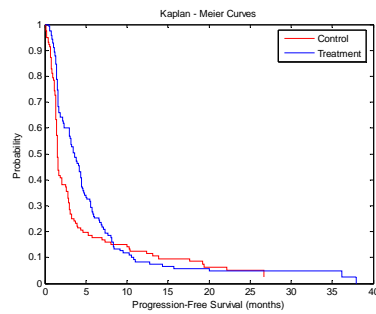

159

## Log Cumulative Hazard Curves For Kaplan-Meier Versus Nonproportional Hazard Model

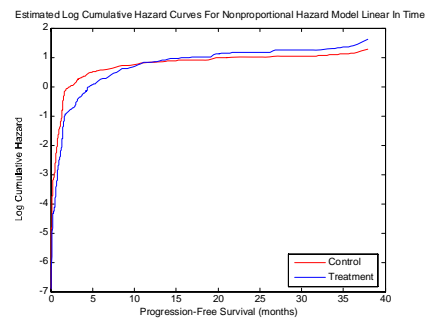
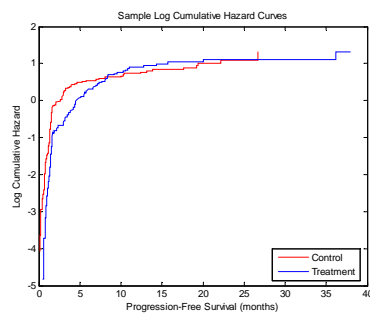

160



## Survival Analysis With Non-Proportional Hazard Models

Non-proportional hazard modeling

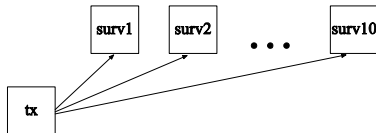

Growth and non-proportional hazard modeling

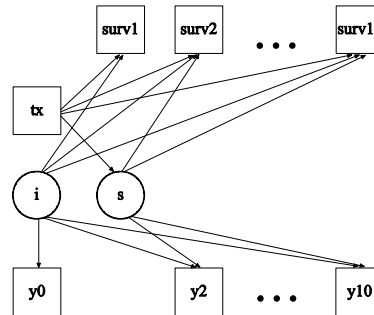

161

## Continuous-Time Survival Data

t	x	c
7.330493	-0.378137	1.000000
0.894182	-0.880031	1.000000
1.219113	0.369423	0.000000
0.134073	1.886903	0.000000
0.598567	1.118025	0.000000
0.725646	0.642068	0.000000
1.637967	-0.324017	0.000000
5.534057	-0.760867	0.000000
3.316749	0.194822	1.000000
4.176435	-0.311791	1.000000

→ Event occurred at time  
1.219113

162

## Translating Continuous-Time Survival Data To Discrete-Time Survival Data

```
VARIABLE:  NAMES = t x c;  
           ! t =time of death or censoring  
           ! c = not censored (0), censored (1)  
           CATEGORICAL = u1-u8(*);  
           USEVAR = x u1-u8;  
DATA:      FILE = surveql.dat;  
           VARIANCE = NOCHECK;  
DEFINE:    IF (t>2) THEN u1=0;  
           IF ((t>0) .AND. (t<2)) THEN u1=1-c;  
           ! u1 = 0 if c = 1, i.e. censoring time between 0 and 2  
           ! u1 = 1 if person died then  
  
           IF (t>4) THEN u2=0;  
           IF ((t>2) .AND. (t<4)) THEN u2=1-c;  
           IF (t<2) THEN u2=_missing;  
           ! u2 is missing either because u1 = 1 or because  
           ! u1 = 0 and c = 1
```

163

## Translating Continuous-Time Survival Data To Discrete-Time Survival Data (Continued)

```
           IF (t>6) THEN u3=0;  
           IF ((t>4) .AND. (t<6)) THEN u3=1-c;  
           IF (t<4) THEN u3=_missing;  
  
           IF (t>8) THEN u4=0;  
           IF ((t>6) .AND. (t<8)) THEN u4=1-c;  
           IF (t<6) THEN u4=_missing;  
  
           IF (t>10) THEN u5=0;  
           IF ((t>8) .AND. (t<10)) THEN u5=1-c;  
           IF (t<8) THEN u5=_missing;  
  
           IF (t>12) THEN u6=0;  
           IF ((t>10) .AND. (t<12)) THEN u6=1-c;  
           IF (t<10) THEN u6=_missing;
```

164

## Translating Continuous-Time Survival Data To Discrete-Time Survival Data (Continued)

```
IF (t>14) THEN u7=0;
IF ((t>12) .AND. (t<14)) THEN u7=1-c;
IF (t<12) THEN u7=_missing;

IF (t>16) THEN u8=0;
IF ((t>14) .AND. (t<16)) THEN u8=1-c;
IF (t<14) THEN u8=_missing;

MODEL:    u1-u8 ON x*1 (1);
ANALYSIS: ESTIMATOR = MLR;
          TYPE = MISSING;
```

165

## Further Readings For Continuous-Time Survival Analysis

- Asparouhov, T., Masyn, K. & Muthen, B. (2006). Continuous time survival in latent variable models. Proceedings of the Joint Statistical Meeting in Seattle, August 2006. ASA section on Biometrics, 180-187.
- Larsen, K. (2004). Joint analysis of time-to-event and multiple binary indicators of latent classes, Biometrics, 60(1), 85–92.
- Larsen, K. (2005). The Cox proportional hazards model with a continuous latent variable measured by multiple binary indicators, Biometrics, 61(4), 1049–1055.
- Singer, J.D., & Willett, J.B. (1993). It's about time: Using discrete-time survival analysis to study duration and the timing of events. Journal of Educational Statistics, 18(2), 155-195.
- Singer, J. D. & Willett, J. B. (2003). Applied longitudinal analysis. Modeling change and event occurrence. Oxford, UK: Oxford University Press.

166

## Analysis With Missing Data

167

## Analysis With Missing Data

Used when individuals are not observed on all outcomes in the analysis to make the best use of all available data and to avoid biases in parameter estimates, standard errors, and tests of model fit.

### Types of Missingness

- MCAR -- missing completely at random
  - Variables missing by chance
  - Missing by randomized design
  - Multiple cohorts assuming a single population
- MAR -- missing at random
  - Missingness related to observed variables
  - Missing by selective design
- Non-Ignorable (NMAR)
  - Missingness related to values that would have been observed
  - Missingness related to latent variables

168

## Estimation With Missing Data

### Types of Estimation (Little & Rubin, 2002)

- Estimation using listwise deleted sample
  - When MCAR is true, parameter estimates and s.e.'s are consistent but estimates are not efficient
  - When MAR is true but not MCAR, parameter estimates and s.e.'s are not consistent
- Maximum likelihood using all available data
  - When MCAR or MAR is true, parameter estimates and s.e.'s are consistent and estimates are efficient
- Selection and pattern-mixture modeling – used for non-ignorable missingness
- Imputation
  - Mean and regression imputation – underestimation of variances and covariances
  - Multiple imputation using all available data – a Bayesian approach – credibility intervals are Bayesian justifiable under MCAR and MAR

169

## Weighted Least Squares Estimation With Missing Data

Weighted least squares for categorical and censored outcomes

- Assumes MCAR when there are no covariates
- Allows MAR when missingness is a function of covariates

170

## MCAR: Missing By Design

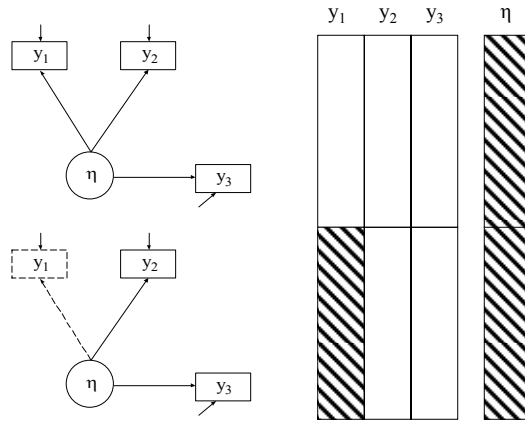

171

## Two-Cohort Growth Model

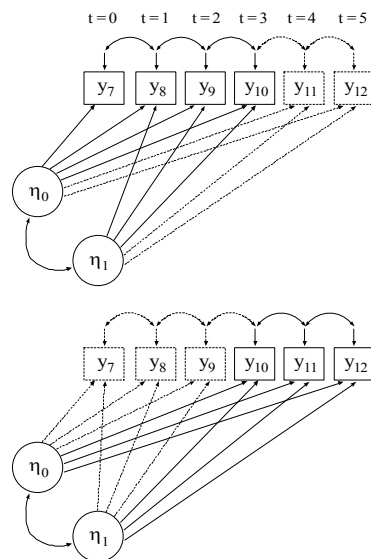

172

# MAR

173

## MAR: Bivariate, Monotone Missing Case

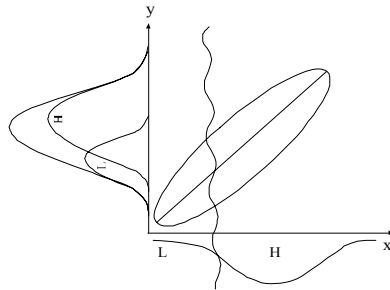

$$y_i = \alpha + \beta x_i + \zeta_i$$
$$E(\zeta) = 0, V(\zeta) = \sigma_\zeta^2$$
$$E(x) = \mu_x, V(x) = \sigma_x^2$$

□ Data Matrix:

	x	y	
$n_H$			Complete Data Group
$n_L$			

174

## Missing At Random (MAR): Missing On y In Bivariate Normal Case

$$\hat{\mu}_x = \sum_{i=1}^{n_L + n_H} x_i / (n_L + n_H) = \frac{n_L \bar{x}_L + n_H \bar{x}_H}{n_L + n_H}, \quad (52)$$

$$\hat{\sigma}_{xx} = \sum_{i=1}^{n_L + n_H} (x_i - \hat{\mu}_x)^2 / (n_L + n_H). \quad (53)$$

175

## Missing At Random (MAR): Missing On y In Bivariate Normal Case (Continued)

Consider the regression

$$y_i = \alpha + \beta x_i + \zeta_i \quad (54)$$

estimated by the complete-data (listwise present) sample  
(sample size  $n_H$ )

$$\hat{\alpha} = \bar{y} - \hat{\beta} \bar{x}, \quad (55)$$

$$\hat{\beta} = s_{yx} / s_{xx}, \quad (56)$$

$$\hat{\sigma}_{\zeta\zeta} = s_{yy} - s_{yx}^2 / s_{xx}. \quad (57)$$

This gives the ML estimates of  $\mu_y$  and  $\sigma_{yy}$ , adjusting the complete-data sample statistics:

$$\hat{\mu}_y = \hat{\alpha} + \hat{\beta} \hat{\mu}_x = \bar{y} + \hat{\beta} (\hat{\mu}_x - \bar{x}), \quad (58)$$

$$\hat{\sigma}_{yy} = \hat{\sigma}_{\zeta\zeta} + \hat{\beta}^2 \hat{\sigma}_{xx} = s_{yy} + \hat{\beta}^2 (\hat{\sigma}_{xx} - s_{xx}). \quad (59) \quad 176$$



## Correlates Of Missing Data

- MAR is more plausible when the model includes covariates influencing missing data
- Correlates of missing data may not have a “causal role” in the model, i.e. not influencing dependent variables, in which case including them as covariates can bias model estimates
  - Multiple imputation (Bayes; Schafer, 1997) with two different sets of observed variables
    - Imputation model
    - Analysis model
  - Modeling (ML)
    - Including missing data correlates not as x variables but as “y variables,” freely correlated with all other observed variables

Recent overview in Schafer & Graham (2002).

177

## Missing On X

- Regular modeling concerns the conditional distribution

$$[y | x] \quad (1)$$

that is, as in regular regression the marginal distribution of  $[x]$  is not involved. This is fine if there is no missing on  $x$  in which case considering

$$[y | x]$$

gives the same estimates as (Joreskog & Goldberger, 1975) considering the joint distribution

$$[y, x] = [y | x] [x]$$

178

## Missing On X (Continued)

- With missing on  $x$ , ML under MAR must make a distributional assumption about  $[x]$ , typically normality. The modeling then concerns

$$[y, x] = [y | x] [x] \quad (2)$$

which with missing on  $[x]$  is an expanded model that makes stronger assumptions as compared to (1).

- The LHS of (2) shows that  $y$  and  $x$  are treated the same - they are both “ $y$  variables” in Mplus terminology. This is the default in Mplus when all  $y$ 's are continuous. In other cases,  $x$ 's can be turned into “ $y$ 's” e.g. by the model statement

`x1-xq;`

179

## Technical Aspects Of Ignorable Missing Data: ML Under MAR

$$\text{Likelihood: } \sum_{i=1}^n \log [y_i | x_i]. \quad (87)$$

With missing data on  $\mathbf{y}$ , the  $i^{\text{th}}$  term of (87) expands into

$$[y_i^{obs}, y_i^{mis}, \mathbf{m}_i | x_i], \quad (88)$$

where  $\mathbf{m}_i$  is a 0/1 indicator vector of the same length as  $\mathbf{y}_i$ .

The likelihood focuses on the observed variables,

$$[y_i^{obs}, \mathbf{m}_i | x_i] = \int [y_i^{obs}, y_i^{mis} | x_i] [\mathbf{m}_i | y_i^{obs}, y_i^{mis}, x_i] dy_i^{mis}, \quad (89)$$

which, when assuming that missingness is not a function of  $\mathbf{y}_i^{mis}$  (that is, assuming MAR),

180

## Technical Aspects Of Ignorable Missing Data: ML Under MAR (Continued)

$$= \int [\mathbf{y}_i^{obs}, \mathbf{y}_i^{mis} | \mathbf{x}_i] d\mathbf{y}_i^{mis} [\mathbf{m}_i | \mathbf{y}_i^{obs}, \mathbf{x}_i], \quad (90)$$

$$= [\mathbf{y}_i^{obs} | \mathbf{x}_i] [\mathbf{m}_i | \mathbf{y}_i^{obs}, \mathbf{x}_i]. \quad (91)$$

With distinct parameter sets in (91), the last term can be ignored and maximization can focus on the  $[\mathbf{y}_i^{obs} | \mathbf{x}_i]$  term. This leads to the standard MAR ignorable missing data procedure.

181

## AMPS Data

The data are taken from the Alcohol Misuse Prevention Study (AMPS). Forty-nine schools with a total of 2,666 students participated in the study. Students were measured seven times starting in the Fall of Grade 6 and ending in the Spring of Grade 12.

Data for the analysis include the average of three items related to alcohol misuse:

During the past 12 months, how many times did you  
drink more than you planned to?  
feel sick to your stomach after drinking?  
get very drunk?

Responses: (0) never, (1) once, (2) two times,  
(3) three or more times

Four of the seven timepoints are studied: Fall Grade 6, Spring Grade 6, Spring Grade 7, and Spring Grade 8.

182

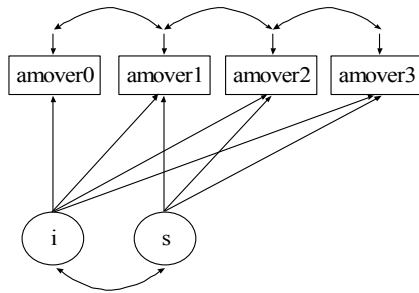

183

## Input For AMPS Growth Model With Missing Data

```

TITLE:      AMPS growth model with missing data
DATA:      FILE IS amps.dat;
VARIABLE:  NAMES ARE caseid
           amover0 ovrdrnk0 illdrnk0 vrydrn0
           amover1 ovrdrnk1 illdrnk1 vrydrn1
           amover2 ovrdrnk2 illdrnk2 vrydrn2
           amover3 ovrdrnk3 illdrnk3 vrydrn3
           amover4 ovrdrnk4 illdrnk4 vrydrn4
           amover5 ovrdrnk5 illdrnk5 vrydrn5
           amover6 ovrdrnk6 illdrnk6 vrydrn6;
USEV = amover0 amover1 amover2 amover3;
MISSING = ALL (999);

```

184

## Input For AMPS Growth Model With Missing Data (Continued)

MODEL:       i s | amover0@0 amover1@1 amover2@3 amover3\*5;  
              amover1-amover3 PWITH amover0-amover2;

OUTPUT:     **PATTERNS**  SAMPSTAT  MODINDICES  STANDARDIZED;

185

## Output Excerpts AMPS Growth Model With Missing Data

### Summary of Data

Number of patterns     15

#### SUMMARY OF MISSING DATA PATTERNS

##### MISSING DATA PATTERNS

	1	2	3	4	5	6	7	8	9	10	11	12	13	14	15
AMOVER0	x	x	x	x	x	x	x	x							
AMOVER1	x	x	x	x					x	x	x	x			
AMOVER2	x	x			x	x			x	x			x	x	
AMOVER3	x		x		x		x		x		x		x		x

##### MISSING DATA PATTERN FREIENCIES

Pattern	Frequency	Pattern	Frequency	Pattern	Frequency
1	685	6	29	11	104
2	143	7	11	12	237
3	73	8	64	13	6
4	164	9	866	14	1
5	65	10	208	15	3

186

## Output Excerpts AMPS Growth Model With Missing Data (Continued)

COVARIANCE COVERAGE OF DATA

Minimum covariance coverage value 0.100

PROPORTION OF DATA PRESENT

	Covariance Coverage			
	AMOVER0	AMOVER1	AMOVER2	AMOVER3
AMOVER0	0.464			
AMOVER1	0.401	0.933		
AMOVER2	0.347	0.715	0.753	
AMOVER3	0.314	0.650	0.610	0.682

187

## Output Excerpts AMPS Growth Model With Missing Data (Continued)

**Tests Of Model Fit**

Chi-square Test of Model Fit

Value	0.011
Degrees of Freedom	1
P-Value	0.9177

RMSEA (Root Mean Square Error Of Approximation)

Estimate	0.000
90 Percent C.I.	0.000 0.019
Probability RMSEA <= .05	0.997

188

## Output Excerpts AMPS Growth Model With Missing Data (Continued)

### Model Results

	Estimates	S.E.	Est./S.E.	Std	StdYX
I					
AMOVER0	1.000	0.000	0.000	0.426	0.921
AMOVER1	1.000	0.000	0.000	0.426	0.774
AMOVER2	1.000	0.000	0.000	0.426	0.645
AMOVER3	1.000	0.000	0.000	0.426	0.529
S					
AMOVER0	0.000	0.000	0.000	0.000	0.000
AMOVER1	1.000	0.000	0.000	0.109	.198
AMOVER2	3.000	0.000	0.000	0.327	0.494
AMOVER3	6.244	0.426	14.645	0.680	0.843
S	I				
WITH	-0.007	0.003	-2.278	-0.146	-0.146
AMOVER1 WITH					
AMOVER0	-0.022	0.011	-2.010	-0.022	-0.085
AMOVER2 WITH					
AMOVER1	0.017	0.007	2.505	0.017	0.047
AMOVER3 WITH					
AMOVER2	-0.001	0.027	-0.050	-0.001	-0.003 189

## Output Excerpts AMPS Growth Model With Missing Data (Continued)

Residual Variances					
AMOVER0	0.033	0.013	2.509	0.033	0.152
AMOVER1	0.123	0.011	10.950	0.123	0.406
AMOVER2	0.190	0.017	11.461	0.190	0.433
AMOVER3	0.091	0.068	1.340	0.091	0.140
Variances					
I	0.182	0.014	12.891	1.000	1.000
S	0.012	0.002	5.378	1.000	1.000
Means					
I	0.200	0.010	19.391	0.469	0.469
S	0.057	0.005	11.858	0.520	0.520
Intercept					
AMOVER0	0.000	0.000	0.000	0.000	0.000
AMOVER1	0.000	0.000	0.000	0.000	0.000
AMOVER2	0.000	0.000	0.000	0.000	0.000
AMOVER3	0.000	0.000	0.000	0.000	0.000

## Output Excerpts AMPS Growth Model With Missing Data (Continued)

R-SQUARE

Observed Variable	R-Square
AMOVER0	0.848
AMOVER1	0.594
AMOVER2	0.567
AMOVER3	0.860

191

## AMPS: Estimated Growth Curves

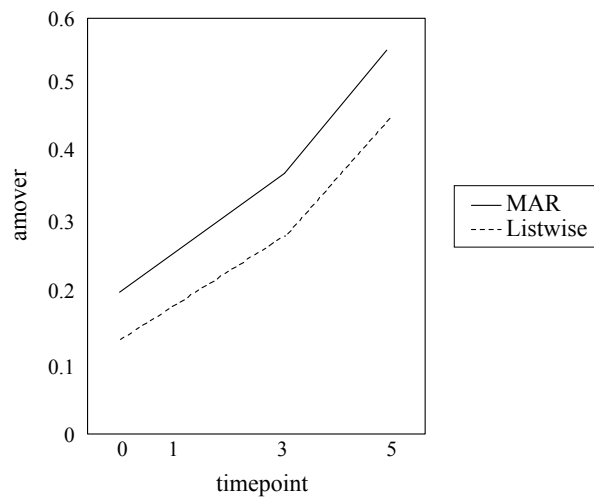

192



## Missing Data Correlates Using ML

193

## Missing Data Correlates

Handling missing-data-related variables that are different from analysis variables:

- Multiple imputation
- ML using missing data correlates
- References:
  - Collins, Schafer, Kam (2001) in Psych Methods
  - Graham (2003) in SEM
  - Enders and Peugh (2004) SEM
  - Savalei and Bentler (2007)

194

## Model Of Interest

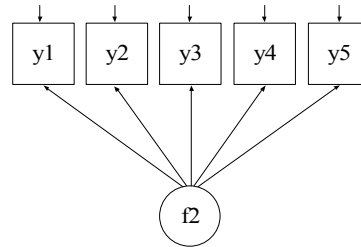

195

## Data-Generating Model

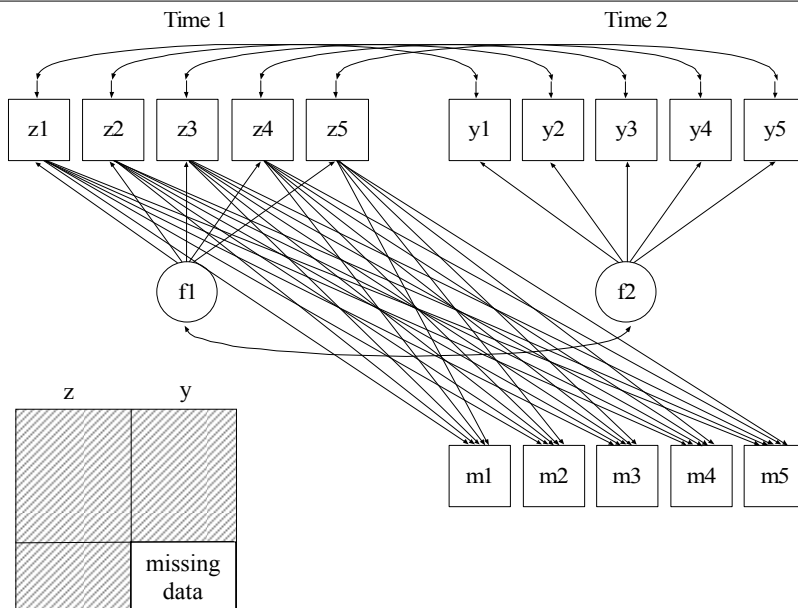

196

## Full Analysis Model (ML Under MAR)

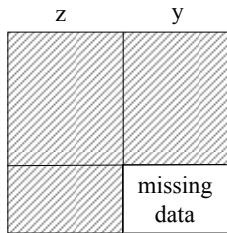
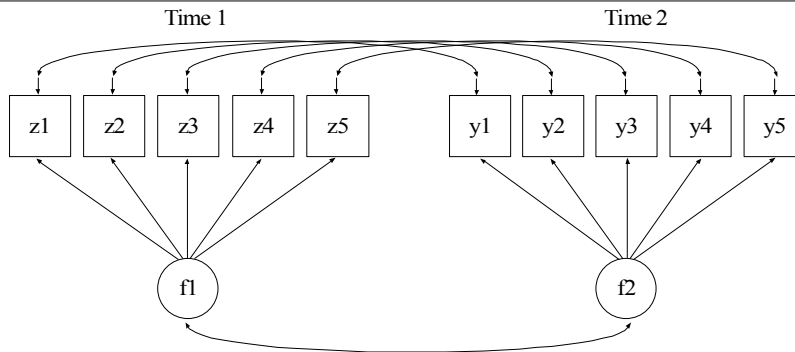

197

## Simple Analysis Model (ML Under MAR)

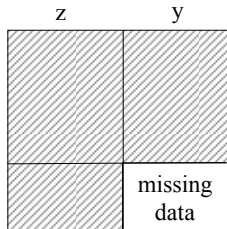
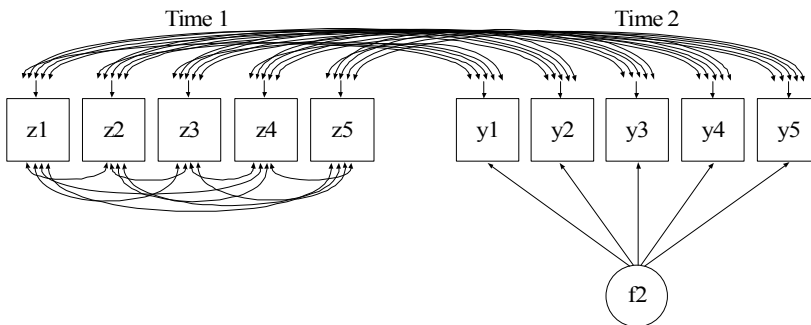

```
VARIABLE: NAMES = y1-y5 z1-z5;
          USEV = y1-y5;
          AUXILIARY = (M) z1-z5;
          MISSING = ALL(999);

MODEL:   f2 BY y1-y5;
```

198

## Monte Carlo Simulation Results (N = 200)

Y with z as aux

		ESTIMATES			S.E.	M.S.E.	95%
		Population	Average	Std. Dev.	Average		Cover
F2	BY						
	Y1	0.7000	0.6914	0.0820	0.0766	0.0067	0.9400
	Y2	0.7000	0.6854	0.0829	0.0766	0.0070	0.9300
	Y3	0.7000	0.6947	0.0650	0.0767	0.0042	0.9600
	Y4	0.7000	0.6934	0.0719	0.0767	0.0052	0.9600
	Y5	0.7000	0.6911	0.0804	0.0761	0.0065	0.9300

Y alone

F2	BY						
	Y1	0.7000	0.6482	0.0869	0.0797	0.0102	0.890
	Y2	0.7000	0.6392	0.0861	0.0803	0.0110	0.850
	Y3	0.7000	0.6450	0.0751	0.0802	0.0086	0.900
	Y4	0.7000	0.6474	0.0741	0.0802	0.0082	0.910
	Y5	0.7000	0.6463	0.0825	0.0796	0.0096	0.890

199

## References

Asparouhov & Muthen (2008). Auxiliary variables predicting missing data. Technical report. [www.statmodel.com](http://www.statmodel.com).

## LSAY Estimated Means

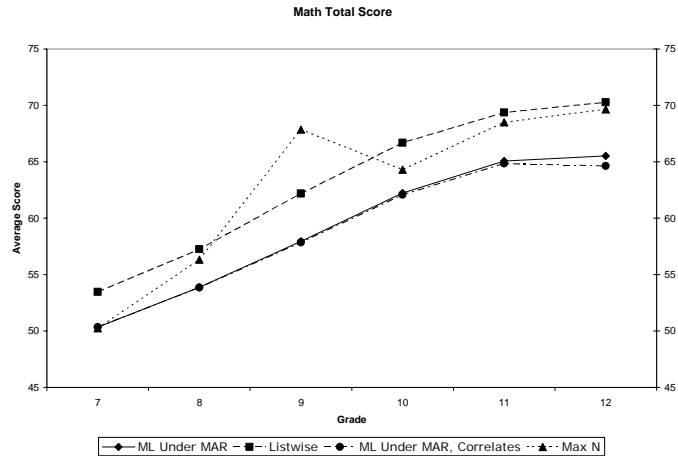

MAR sample size = 3102

Listwise sample size = 782

Max N sample size = 3065, 2581, 2241, 2040, 1593, 1168

201

## Input Excerpts LSAY Math Mean Using Missing Data Correlates

```

USEV = math7 math8 math9 math10 math11 math12;
AUXILIARY = (M) female mothed homeres expel arrest
             hisp black hsdrop
             expect droptht7
             lunch mstrat;
DEFINE:     lunch = lunch/100;
            mstrat = mstrat/1000;
MODEL:     math7 WITH math8-math12;
            math8 WITH math9-math12;
            math9 WITH math10-math12;
            math10 WITH math11-math12;
            math11 WITH math12;
PLOT:     TYPE = PLOT3;
            SERIES = math7-math12(*);
    
```

202

## Non-Ignorable Missing Data

203

## Non-Ignorable Missing Data Modeling Approaches And References

Selection modeling:  $[y | x] [m | y, x]$ . Different approaches to  $[m | y, x]$ :

Little & Rubin (2002) book, Little (2008) handbook chapter: overview

Diggle & Kenward (1994) in Applied Statistics:

predicting from  $y, y^*$  ( $y^*$  is non-ignorable dropout)

Wu & Carroll (1988), Wu & Bailey (1989) in Biometrics:

predicting from the slope  $s$

Pattern-mixture modeling:  $[m | x] [y | m, x]$ . Different approaches to  $[y | m, x]$ :

Little & Rubin (2002), Little (2008): overview

Conventional approach: predicting  $i, s$  from  $m$

Roy (2003) in Biometrics:

predicting  $i, s$  from a latent class variable  $c$  (missing data patterns)

204

## **Non-Ignorable Missing Data Modeling Approaches And References (Continued)**

Shared-parameter modeling:  $[y, m] = \sum_c [c] [m | c] [y | c] :$

Albert & Follman (2008) handbook chapter: overview  
Beunckens et al (2008) in Biometrics: using a latent class variable  $c$  and  $i, s$

205

## **Non-Ignorable Missing Data Modeling In Longitudinal Studies**

- Intermittent missingness versus dropout
- Muthén, B., Asparouhov, T., Hunter, A. & Leuchter, A. (2010). Growth modeling with non-ignorable dropout: Alternative analyses of the STAR\*D antidepressant trial. Submitted for publication.
- Applied to STAR\*D antidepressant trial data (n=4041)

206

## STAR\*D Antidepressant Trial

- STAR\*D multi-site NIMH antidepressant trial with  $n = 4041$
- Subjects treated with citalopram (Level 1). No placebo group
- Clinician-rated QIDS depression score measured at baseline and weeks 2, 4, 6, 9, and 12
- 25% have complete data, 60% have monotone (dropout) missing data patterns, 14% have non-monotone missing data patterns
- Coverage at baseline and weeks 2, 4, 6, 9, and 12: 1.00, 0.79, 0.69, 0.68, 0.57, and 0.39
- Reasons for leaving Level 1: Remission (moved to follow-up), medication inefficient or not tolerated (moved to Level 2), study exit

207

## STAR\*D Antidepressant Trial

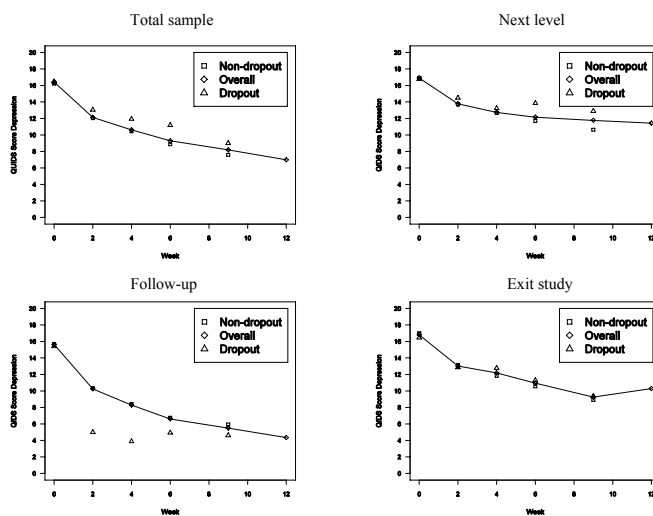

208



## Selection Modeling

Diggle-Kenward selection modeling

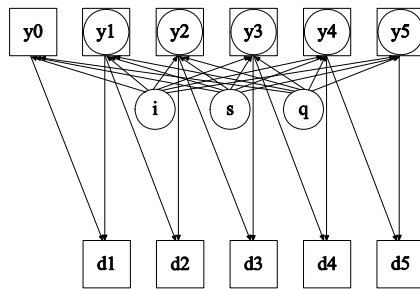

Beunckens mixture model  
(mixture Wu-Carroll model)

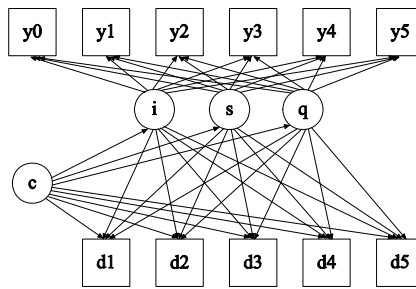

Selection modeling (d's are survival indicators)

209

## Input Excerpts Diggle-Kenward Selection Modeling

```

DATA:          FILE = StarD Ratings 1-23-09.dat;
VARIABLE:     NAMES = ...
              ... ;
              MISSING = ALL (-9999);
              USEV = y0 y1 y2 y3 y4 y5
              d1 d2 d3 d4 d5;
              CATEGORICAL = d1 d2 d3 d4 d5;
DATA MISSING: NAMES = y1 y2 y3 y4 y5;
              TYPE = SDROPOUT;
              BINARY = d1-d5;
ANALYSIS:     PROCESS = 4;
              ALGORITHM = INTEGRATION;
              INTEGRATION = MONTECARLO;
              INTERACTIVE = control.dat;
    
```

210

## Input Excerpts Diggle-Kenward Selection Modeling (Continued)

```

MODEL:          i s q | y0@0 y1@.2 y2@.4 y3@.6 y4@.9 y5@1.2;
                d1 ON y0 (beta2)
                y1 (beta1);
                d2 ON y1 (beta2)
                y2 (beta1);
                d3 ON y2 (beta2)
                y3 (beta1);
                d4 ON y3 (beta2)
                y4 (beta1);
                d5 ON y4 (beta2)
                y5 (beta1);

PLOT:          TYPE = PLOT3;
                SERIES = y0-y5 (s);

OUTPUT:        TECH1 SAMPSTAT RESIDUAL STANDARDIZED;
    
```

211

## Pattern-Mixture Modeling

Conventional pattern-mixture modeling

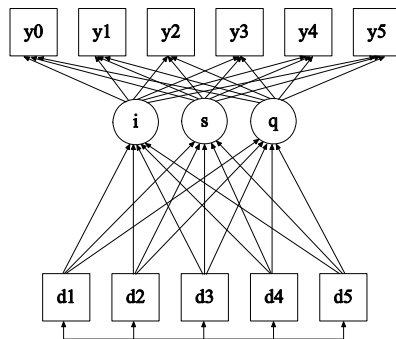

Roy latent class dropout modeling

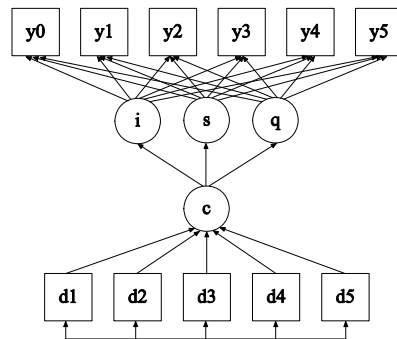

Pattern-mixture modeling (d's are dropout dummy variables)

212

## Input Excerpts Pattern-Mixture Modeling

```
TITLE:
DATA:      FILE = StarD Ratings 1-23-09.dat;
VARIABLE:  NAMES = ...
           ... ;
           MISSING = ALL (-9999);
           USEV = y0 y1 y2 y3 y4 y5
           d1 d2 d3 d4 d5;
DATA MISSING: NAMES = y1 y2 y3 y4 y5;
              TYPE = DDROPOUT;
              BINARY = d1-d5;
```

213

## Input Excerpts Pattern-Mixture Modeling (Continued)

```
MODEL:      i s q | y0@0 y1@.2 y2@.4 y3@.6 y4@.9 y5@1.2;
            i-q ON d4-d5;
            i ON d1 d2 d3;
            s ON d3;
            s ON d1 (1);
            s ON d2 (1);
            q ON d1 (2);
            q ON d2 (2);
            q ON d3 (2);
PLOT:      TYPE = PLOT3;
            SERIES = y0-y5 (s);
OUTPUT:    TECH1 SAMPSTAT RESIDUAL STANDARDIZED;
```

214

## Input Excerpts Roy 4-Class Latent Dropout Modeling

```
TITLE:
DATA:      FILE = StarD Ratings 1-23-09.dat;
VARIABLE:  NAMES = ...
           ... ;
           MISSING = ALL (-9999);
           USEV = y0 y1 y2 y3 y4 y5
           d1-d5;
           CLASSES = c(4);
DATA MISSING: NAMES = y1 y2 y3 y4 y5;
              TYPE = DDROPOUT;
              BINARY = d1-d5;
ANALYSIS:  TYPE = MIXTURE;
           PROCESS = 4(STARTS);
           INTERACTIVE = control.dat;
           STARTS = 200 40;
```

215

## Input Excerpts Roy 4-Class Latent Dropout Modeling (Continued)

```
MODEL:      %OVERALL%
           i s q | y0@0 y1@.2 y2@.4 y3@.6 y4@.9 y5@1.2;
           c ON d1-d5;
PLOT:      TYPE = PLOT3;
           SERIES = y0-y5 (s);
OUTPUT:    TECH1 SAMPSTAT RESIDUAL STANDARDIZED;
```

216

## STAR\*D Estimated Mean Growth Curves

Depression mean curves estimated under MAR, Diggle-Kenward selection modeling, and Roy latent dropout modeling

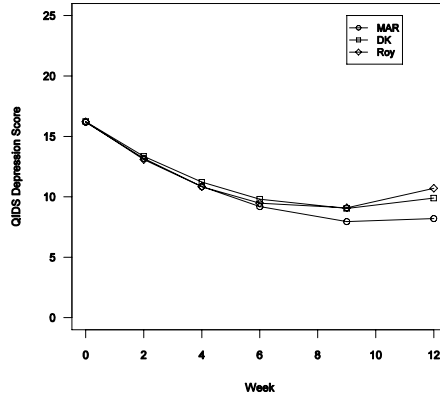

217

## STAR\*D Estimated Mean Growth Curves Under 4-Class Roy Model

4-class Roy latent dropout model

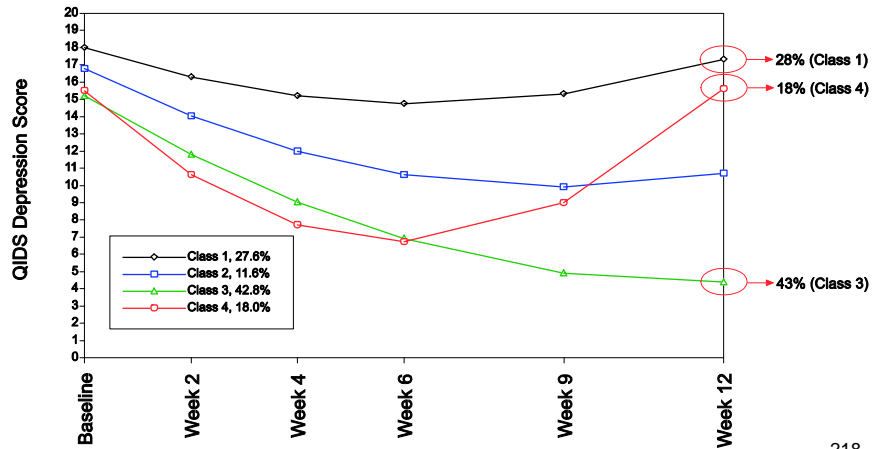

218

## STAR\*D Estimated Mean Growth Curves Under 4-Class MAR

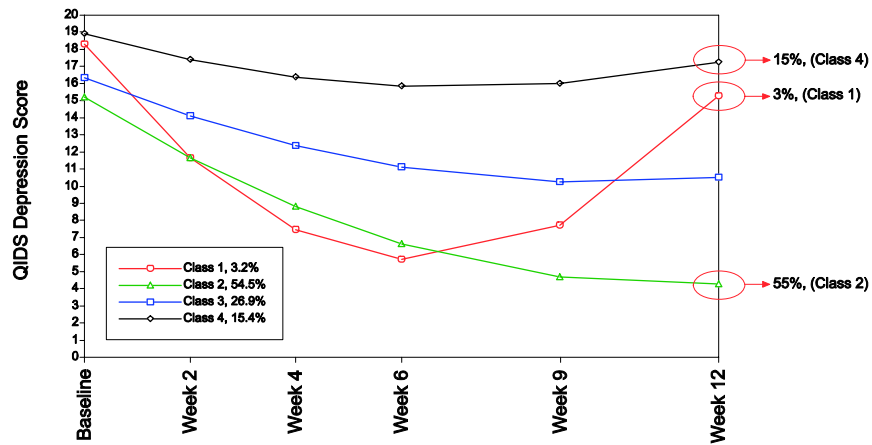

219

## Multiple Imputation Analysis In Mplus

- Multiply imputed data an input data alternative
- Estimates and SEs aggregated over the analyses
- Model testing

220

## Further Readings On Missing Data Analysis

- Albert, P.S. & Follman, D.A. (2008). Shared-parameter models. In Fitzmaurice, G., Davidian, M., Verbeke, G. & Molenberghs, G. (eds.), Longitudinal Data Analysis, pp. 433-452. Boca Raton: Chapman & Hall/CRC Press.
- Beunckens, C., Molenberghs, G., Verbeke, G., and Mallinckrodt, C. (2008). A latent-class mixture model for incomplete longitudinal Gaussian data. Biometrics, 64, 96-105.
- Dantan, E., Proust-Lima, C., Letenneur, L., & Jacqmin-Gadda, H. (2008). Pattern mixture models and latent class models for the analysis of multivariate longitudinal data with informative dropouts. The International Journal of Biostatistics, 4(1), 1-26.
- Diggle, P.D. and Kenward, M.G. (1994). Informative dropout in longitudinal data analysis (with discussion). Applied Statistics, 43, 84.
- Graham, J.W. (2003). Adding missing-data-relevant variables to FIML-based structural equation models. Structural Equation Modeling, 10(1), 80-100.

221

## Further Readings On Missing Data Analysis

- Hedeker, D. & Rose, J.S. (2000). The natural history of smoking: A pattern-mixture random-effects regression model. Multivariate applications in substance use research, J. Rose, L. Chassin, C. Presson & J. Sherman (eds.), Hillsdale, N.J.: Erlbaum, pp. 79-112.
- Little, R.J., & Rubin, D.B. (2002). Statistical analysis with missing data. 2<sup>nd</sup> edition. New York: John Wiley & Sons.
- Little, R.J. (2008). Selection and pattern-mixture models. In Fitzmaurice, G., Davidian, M., Verbeke, G. & Molenberghs, G. (eds.), Longitudinal Data Analysis, pp. 409-431. Boca Raton: Chapman & Hall/CRC Press.
- Morgan-Lopez, A.A. & Fals-Stewart, W. (2007) Analytic methods for modeling longitudinal data from rolling therapy groups with membership turnover. Journal of Consulting and Clinical Psychology, 75, 580-593.
- Muthén, B., Asparouhov, T., Hunter, A. & Leuchter, A. (2010). Growth modeling with non-ignorable dropout: Alternative analyses of the STAR\*D antidepressant trial. Submitted for publication.
- Muthén, B., Kaplan, D., & Hollis, M. (1987). On structural equation modeling with data that are not missing completely at random. Psychometrika, 42, 431-462. (#17)

222

## Further Readings On Missing Data Analysis (Continued)

- Muthén, B., Jo, B. & Brown, H. (2003). Comment on the Barnard, Frangakis, Hill & Rubin article, Principal stratification approach to broken randomized experiments: A case study of school choice vouchers in New York City. Journal of the American Statistical Association, 98, 311-314.
- Roy, J. (2003). Modeling longitudinal data with nonignorable dropouts using a latent dropout class model. Biometrics, 59, 829-836.
- Schafer, J.L. (1997). Analysis of incomplete multivariate data. London: Chapman & Hall.
- Schafer, J.L. & Graham, J. (2002). Missing data: Our view of the state of the art. Psychological Methods, 7, 147- 177.
- Wu, M.C. & Carroll, R.J. (1988). Estimation and comparison of changes in the presence of informative right censoring by modeling the censoring process. Biometrics, 44, 175-188.

223

## References

(To request a Muthén paper, please email [bmuthen@ucla.edu](mailto:bmuthen@ucla.edu).)

### **Analysis With Longitudinal Data** **Introductory**

- Bollen, K.A. & Curran, P.J. (2006). Latent curve models. A structural equation perspective. New York: Wiley.
- Collins, L.M. & Sayer, A. (Eds.) (2001). New methods for the analysis of change. Washington, D.C.: American Psychological Association.
- Curran, P.J. & Bollen, K.A. (2001). The best of both worlds: Combining autoregressive and latent curve models. In Collins, L.M. & Sayer, A.G. (Eds.) New methods for the analysis of change (pp. 105-136). Washington, DC: American Psychological Association.
- Duncan, T.E., Duncan, S.C., Strycker, L.A., Li, F., & Alpert, A. (1999). An introduction to latent variable growth curve modeling: concepts, issues, and applications. Mahwah, NJ: Lawrence Erlbaum Associates.
- Goldstein, H. (1995). Multilevel statistical models. Second edition. London: Edward Arnold.

224



## References (Continued)

- Jennrich, R.I. & Schluchter, M.D. (1986). Unbalanced repeated-measures models with structured covariance matrices. *Biometrics*, 42, 805-820.
- Laird, N.M., & Ware, J.H. (1982). Random-effects models for longitudinal data. *Biometrics*, 38, 963-974.
- Lindstrom, M.J. & Bates, D.M. (1988). Newton-Raphson and EM algorithms for linear mixed-effects models for repeated-measures data. *Journal of the American Statistical Association*, 83, 1014-1022.
- Littell, R., Milliken, G.A., Stroup, W.W., & Wolfinger, R.D. (1996). SAS system for mixed models. Cary NC: SAS Institute.
- McArdle, J.J. & Epstein, D. (1987). Latent growth curves within developmental structural equation models. *Child Development*, 58, 110-133.
- McArdle, J.J. & Hamagami, F. (2001). Latent differences score structural models for linear dynamic analyses with incomplete longitudinal data. In Collins, L.M. & Sayer, A. G. (Eds.), *New methods for the analysis of change* (pp. 137-175). Washington, D.C.: American Psychological Association.

225

## References (Continued)

- Meredith, W. & Tisak, J. (1990). Latent curve analysis *Psychometrika*, 55, 107-122.
- Muthén, B. (1991). Analysis of longitudinal data using latent variable models with varying parameters. In L. Collins & J. Horn (Eds.), *Best methods for the analysis of change. Recent advances, unanswered questions, future directions* (pp. 1-17). Washington D.C.: American Psychological Association.
- Muthén, B. (2000). Methodological issues in random coefficient growth modeling using a latent variable framework: Applications to the development of heavy drinking. In *Multivariate applications in substance use research*, J. Rose, L. Chassin, C. Presson & J. Sherman (eds.), Hillsdale, N.J.: Erlbaum, pp. 113-140.
- Muthén, B. & Khoo, S.T. (1998). Longitudinal studies of achievement growth using latent variable modeling. *Learning and Individual Differences*. Special issue: latent growth curve analysis, 10, 73-101.
- Muthén, B. & Muthén, L. (2000). The development of heavy drinking and alcohol-related problems from ages 18 to 37 in a U.S. national sample. *Journal of Studies on Alcohol*, 61, 290-300.

226

## References (Continued)

- Muthén, B. & Shedden, K. (1999). Finite mixture modeling with mixture outcomes using the EM algorithm. Biometrics, 55, 463-469.
- Rao, C.R. (1958). Some statistical models for comparison of growth curves. Biometrics, 14, 1-17.
- Raudenbush, S.W. & Bryk, A.S. (2002). Hierarchical linear models: Applications and data analysis methods. Second edition. Newbury Park, CA: Sage Publications.
- Singer, J.D. (1998). Using SAS PROC MIXED to fit multilevel models, hierarchical models, and individual growth models. Journal of Educational and Behavioral Statistics, 23, 323-355.
- Singer, J.D. & Willett, J.B. (2003). Applied longitudinal data analysis. Modeling change and event occurrence. New York, NY: Oxford University Press.
- Snijders, T. & Bosker, R. (1999). Multilevel analysis: An introduction to basic and advanced multilevel modeling. Thousand Oakes, CA: Sage Publications.
- Tucker, L.R. (1958). Determination of parameters of a functional relation by factor analysis. Psychometrika, 23, 19-23.

227

## References (Continued)

### Advanced

- Albert, P.S. & Shih, J.H. (2003). Modeling tumor growth with random onset. Biometrics, 59, 897-906.
- Brown, C.H. & Liao, J. (1999). Principles for designing randomized preventive trials in mental health: An emerging development epidemiologic perspective. American Journal of Community Psychology, special issue on prevention science, 27, 673-709.
- Brown, C.H., Indurkha, A. & Kellam, S.K. (2000). Power calculations for data missing by design: applications to a follow-up study of lead exposure and attention. Journal of the American Statistical Association, 95, 383-395.
- Collins, L.M. & Sayer, A. (Eds.), New methods for the analysis of change. Washington, D.C.: American Psychological Association.
- Duan, N., Manning, W.G., Morris, C.N. & Newhouse, J.P. (1983). A comparison of alternative models for the demand for medical care. Journal of Business and Economic Statistics, 1, 115-126.

228

## References (Continued)

- Ferrer, E. & McArdle, J.J. (2004). Alternative structural models for multivariate longitudinal data analysis. Structural Equation Modeling, 10, 493-524.
- Fitzmaurice, G., Davidian, M., Verbeke, G. & Molenberghs, G. (2008). Longitudinal Data Analysis. Chapman & Hall/CRC Press.
- Klein, A. & Moosbrugger, H. (2000). Maximum likelihood estimation of latent interaction effects with the LMS method. Psychometrika, 65, 457-474.
- Khoo, S.T. & Muthén, B. (2000). Longitudinal data on families: Growth modeling alternatives. In Multivariate applications in substance use research, J. Rose, L. Chassin, C. Presson & J. Sherman (eds), Hillsdale, N.J.: Erlbaum, pp. 43-78.
- Miyazaki, Y. & Raudenbush, S.W. (2000). A test for linkage of multiple cohorts from an accelerated longitudinal design. Psychological Methods, 5, 44-63.
- Moerbeek, M., Breukelen, G.J.P. & Berger, M.P.F. (2000). Design issues for experiments in multilevel populations. Journal of Educational and Behavioral Statistics, 25, 271-284.

229

## References (Continued)

- Muthén, B. (1996). Growth modeling with binary responses. In A.V. Eye & C. Clogg (eds), Categorical variables in developmental research: methods of analysis (pp. 37-54). San Diego, CA: Academic Press.
- Muthén, B. (1997). Latent variable modeling with longitudinal and multilevel data. In A. Raftery (ed), Sociological Methodology (pp. 453-380). Boston: Blackwell Publishers.
- Muthén, B. (2004). Latent variable analysis: Growth mixture modeling and related techniques for longitudinal data. In D. Kaplan (ed.), Handbook of quantitative methodology for the social sciences (pp. 345-368). Newbury Park, CA: Sage Publications.
- Muthén, B. & Curran, P. (1997). General longitudinal modeling of individual differences in experimental designs: A latent variable framework for analysis and power estimation. Psychological Methods, 2, 371-402.
- Muthén, B. & Muthén, L. (2000). The development of heavy drinking and alcohol-related problems from ages 18 to 37 in a U.S. national sample. Journal of Studies on Alcohol, 61, 290-300.

230

## References (Continued)

- Muthén, L.K. and Muthén, B. O. (2002). How to use a Monte Carlo study to decide on sample size and determine power. Structural Equation Modeling, 4, 599-620.
- Olsen, M.K. & Schafer, J.L. (2001). A two-part random effects model for semicontinuous longitudinal data. Journal of the American Statistical Association, 96, 730-745.
- Raudenbush, S.W. (1997). Statistical analysis and optimal design for cluster randomized trials. Psychological Methods, 2, 173-185.
- Raudenbush, S.W. & Liu, X. (2000). Statistical power and optimal design for multisite randomized trials. Psychological Methods, 5, 199-213.
- Roeder, K., Lynch, K.G., & Nagin, D.S. (1999). Modeling uncertainty in latent class membership: A case study in criminology. Journal of the American Statistical Association, 94, 766-776.
- Satorra, A. & Saris, W. (1985). Power of the likelihood ratio test in covariance structure analysis. Psychometrika, 51, 83-90.

231

## References (Continued)

### Missing Data Analysis

- Albert, P.S. & Follman, D.A. (2008). Shared-parameter models. In Fitzmaurice, G., Davidian, M., Verbeke, G. & Molenberghs, G. (eds.), Longitudinal Data Analysis, pp. 433-452. Boca Raton: Chapman & Hall/CRC Press.
- Beunckens, C., Molenberghs, G., Verbeke, G., and Mallinckrodt, C. (2008). A latent-class mixture model for incomplete longitudinal Gaussian data. Biometrics, 64, 96-105.
- Diggle, P.D. and Kenward, M.G. (1994). Informative dropout in longitudinal data analysis (with discussion). Applied Statistics, 43, 84.
- Graham, J.W. (2003). Adding missing-data-relevant variables to FIML-based structural equation models. Structural Equation Modeling, 10, 80-100.
- Hedeker, D. & Rose, J.S. (2000). The natural history of smoking: A pattern-mixture random-effects regression model. Multivariate applications in substance use research, J. Rose, L. Chassin, C. Presson & J. Sherman (eds.), Hillsdale, N.J.: Erlbaum, pp. 79-112.

232

## References (Continued)

- Little, R.J., & Rubin, D.B. (2002). Statistical analysis with missing data. 2<sup>nd</sup> edition. New York: John Wiley & Sons.
- Little, R.J. (2008). Selection and pattern-mixture models. In Fitzmaurice, G., Davidian, M., Verbeke, G. & Molenberghs, G. (eds.), Longitudinal Data Analysis, pp. 409-431. Boca Raton: Chapman & Hall/CRC Press.
- Morgan-Lopez, A.A. & Fals-Stewart, W. (2007) Analytic methods for modeling longitudinal data from rolling therapy groups with membership turnover. Journal of Consulting and Clinical Psychology, 75, 580-593.
- Muthén, B., Asparouhov, T., Hunter, A. & Leuchter, A. (2010). Growth modeling with non-ignorable dropout: Alternative analyses of the STAR\*D antidepressant trial. Submitted for publication.
- Muthén, B., Kaplan, D., & Hollis, M. (1987). On structural equation modeling with data that are not missing completely at random. Psychometrika, 42, 431-462. (#17)
- Muthén, B., Jo, B. & Brown, H. (2003). Comment on the Barnard, Frangakis, Hill & Rubin article, Principal stratification approach to broken randomized experiments: A case study of school choice vouchers in New York City. Journal of the American Statistical Association, 98, 311-314. (#99) 233

## References (Continued)

- Roy, J. (2003). Modeling longitudinal data with nonignorable dropouts using a latent dropout class model. Biometrics, 59, 829-836.
- Schafer, J.L. (1997). Analysis of incomplete multivariate data. London: Chapman & Hall.
- Schafer, J.L & Graham, J. (2002). Missing data: Our view of the state of the art. Psychological Methods, 7, 147- 177.
- Wu, M.C. & Carroll, R.J. (1988). Estimation and comparison of changes in the presence of informative right censoring by modeling the censoring process. Biometrics, 44, 175-188.

## References (Continued)

### Survival Analysis

- Allison, P.D. (1984). Event History Analysis. Regression for Longitudinal Event Data. Quantitative Applications in the Social Sciences, No. 46. Thousand Oaks: Sage Publications.
- Asparouhov, T., Masyn, K. & Muthen, B. (2006). Continuous time survival in latent variable models. Proceedings of the Joint Statistical Meeting in Seattle, August 2006. ASA section on Biometrics, 180-187.
- Larsen, K. (2004). Joint analysis of time-to-event and multiple binary indicators of latent classes, Biometrics, 60(1), 85–92.
- Larsen, K. (2005). The Cox proportional hazards model with a continuous latent variable measured by multiple binary indicators, Biometrics, 61(4), 1049–1055.
- Lin, H., Turnbull, B.W., McCulloch, C.E. & Slate, E. (2002). Latent class models for joint analysis of longitudinal biomarker and event process data: application to longitudinal prostate-specific antigen readings and prostate cancer. Journal of the American Statistical Association, 97, 53-65.

235

## References (Continued)

- Masyn, K. E. (2008). Modeling measurement error in event occurrence for single, non-recurring events in discrete-time survival analysis. In Hancock, G. R., & Samuelsen, K. M. (Eds.), Advances in latent variable mixture models, pp. 105-145. Charlotte, NC: Information Age Publishing, Inc.
- Muthén, B. & Masyn, K. (2005). Discrete-time survival mixture analysis. Journal of Educational and Behavioral Statistics, 30, 27-28.
- Muthén, B. & Muthén, L. (2000). Integrating person-centered and variable-centered analysis: growth mixture modeling with latent trajectory classes. Alcoholism: Clinical and Experimental Research, 24, 882-891. (#85)
- Singer, J.D., & Willett, J.B. (1993). It's about time: Using discrete-time survival analysis to study duration and the timing of events. Journal of Educational Statistics, 18(20), 155-195.
- Singer, J. D. & Willett, J. B. (2003). Applied longitudinal analysis. Modeling change and event occurrence. Oxford, UK: Oxford University Press.
- Vermunt, J.K. (1997). Log-linear models for event histories. Advanced quantitative techniques in the social sciences, vol. 8. Thousand Oaks: Sage Publications.

236