

1-1-2002

GTAP-E: An Energy-Environmental Version of the GTAP Model

Jean-Marc Burniaux
OECD

Truong P. Truong
University of New South Wales

Follow this and additional works at: <http://docs.lib.purdue.edu/gtaptp>

Burniaux, Jean-Marc and Truong, Truong P., "GTAP-E: An Energy-Environmental Version of the GTAP Model" (2002). *GTAP Technical Papers*. Paper 18.
<http://docs.lib.purdue.edu/gtaptp/18>

This document has been made available through Purdue e-Pubs, a service of the Purdue University Libraries. Please contact epubs@purdue.edu for additional information.



***GTAP-E: An Energy-Environmental
Version of the GTAP Model***

Jean-Marc Burniaux* and Truong P. Truong**

GTAP Technical Paper No. 16

Revised

January 2002

Jean-Marc Burniaux was on leave from the OECD as visiting Associate Professor with the Center for Global Trade Analysis, Purdue University, West Lafayette, Indiana when this paper was written. Truong P. Truong was visiting Associate Professor with the Center for Global Trade Analysis, Purdue University, West Lafayette, Indiana, on leave from the School of Economics, University of New South Wales, Sydney NSW 2052, Australia. This technical paper is a revised version of an earlier GTAP Technical Paper written by T.P. Truong (Truong, 1999).

GTAP stands for the Global Trade Analysis Project which is administered by the Center for Global Trade Analysis, Purdue University, West Lafayette, Indiana, USA 47907-1145. For more information about GTAP, please refer to our Worldwide Web site at: <http://www.agecon.purdue.edu/gtap/>, or send a request to conner@agecon.purdue.edu

GTAP-E: An Energy-Environmental Version of the GTAP Model

Jean-Marc Burniaux and Truong P. Truong *

GTAP Technical Paper No. 16

Abstract

Energy is an important commodity in many economic activities. Its usage affects the environment via CO₂ emissions and the Greenhouse Effect. Modeling the energy-economy-environment-trade linkages is an important objective in applied economic policy analysis. Previously, however, the modeling of these linkages in GTAP has been incomplete. This is because energy substitution, a key factor in this chain of linkages, is absent from the standard model specification. This technical paper remedies this deficiency by incorporating energy substitution into the standard GTAP model. It begins by first reviewing some of the existing approaches to this problem in contemporary CGE models. It then suggests an approach for GTAP which incorporates some of these desirable features of energy substitution. The approach is implemented as an extended version of the GTAP model called GTAP-E. In addition, GTAP-E incorporates carbon emissions from the combustion of fossil fuels and this revised version of GTAP-E provides for a mechanism to trade these emissions internationally. The policy relevance of GTAP-E in the context of the existing debate about climate change is illustrated by some simulations of the implementation of the Kyoto Protocol. It is hoped that the proposed model will be used by individuals in the GTAP network who may not be themselves energy modelers, but who require a better representation of the energy-economy linkages than is currently offered in the standard GTAP model.

* The authors are indebted to Tom Hertel for originally suggesting the topic of this study, and for his continued support and encouragement. Thanks are due also to Kevin Hanslow, and Mustafa Babiker for providing many helpful comments and suggestions on an earlier draft. Ken Pearson was quite indispensable in providing the technical advice for the illustrative experiments. Finally, note that this paper is a revised version of the GTAP Technical Paper No. 16 by Truong (see Truong, 1999).

Table of Contents

1. Introduction	1
2. Review of existing approaches.....	1
2.1 <i>The CETM model - Rutherford et al. (1997)</i>	2
2.1.1 The structure of CETM	2
2.1.2 The Linkage of ETA to MACRO	4
2.1.3 Comments on the structure of CETM.....	7
2.2 <i>The MEGABARE Model and the "Technology Bundle" Approach</i>	9
2.2.1 Description of the technology bundle approach.....	9
2.2.2 Comments on the technology bundle approach.....	11
2.3 <i>The OECD'S GREEN model</i>	12
2.3.1 Dynamics in GREEN.....	13
2.3.2 Inter-fuel substitution	14
2.3.3 Fuel-factor substitution.....	18
2.3.4 Comments on the GREEN model	19
2.4 <i>The Babiker-Maskus-Rutherford (BMR) model</i>	20
2.5 <i>Borges and Goulder (1984) model</i>	207
3. Towards a GTAP model with energy substitution.....	259
3.1 <i>Top-down versus bottom-up approach</i>	29
3.2 <i>The issue of energy-capital substitutability or complementarity</i>	30
3.2.1 Importance of the issue	30
3.2.2 Empirical estimates of σ_{EK}	31
3.3 <i>The structure of inter-fuel and fuel-factor substitution in GTAP-E</i>	32
3.3.1 Production structure with energy substitution	32
3.3.2 Consumption structure	38
4. Illustrative scenarios.....	40
4.1 <i>Alternative implementations of the Kyoto Protocol</i>	41

4.2 Macroeconomic results.....	45
5. Conclusion.....	47
References.....	62

Annexes

Annex 1 : General equilibrium elasticities in GTAP-E and GTAP.

Annex 2 : Specifying country-specific carbon reductions with no emission trading in GTAP-E

Annex 3 : Specifying emission trading in GTAP-E

Figures

Figure 1: Structure of CETM	3
Figure 2: MACRO production nest.....	4
Figure 3: MACRO consumption nest.....	4
Figure 4: ETA - MACRO linkage.....	8
Figure 5: Technology bundle approach.....	9
Figure 6: Composition of the technology bundle for the electricity industry.....	10
Figure 7: Composition of the technology bundle for the steel industry.....	10
Figure 8: The structure of production in GREEN.....	18
Figure 9: Energy and backstop technologies in GREEN.....	19
Figure 10: The structure of household demand in GREEN.....	20
Figure 11: Substitution elasticity when total output is held constant.	22
Figure 12: Structure of production in the Babiker-Maskus-Rutherford (1997) model.....	23
Figure 13: Structure of final demand in the Babiker-Maskus-Rutherford (1997) model.....	24
Figure 14: Structure of production in Borges and Goulder (1984) model.....	25
Figure 15: Standard GTAP production structure.....	30
Figure 16: GTAP-E production structure.....	304
Figure 17: GTAP-E capital-energy composite structure.....	34
Figure 18: GTAP-E government purchases.....	39
Figure 19: GTAP-E household private purchases.....	40
Figure 20: Emission trading among Annex 1 countries.....	43
Figure 21: Worldwide emission trading.....	43

Figure 22: Welfare decomposition of implementing the Kyoto Protocol with no use of the flexibility mechanisms	47
Figure 23: Welfare decomposition of implementing the Kyoto Protocol with trading among Annex 1 countries.....	47
Figure 24 : Welfare decomposition of implementing the Kyoto Protocol with worldwide emission trading	48

Tables

Table 17.1: List of Technologies in ETA.....	6
Table 17.2: List of Important Equations in ETA	8
Table 3 Summary Characteristics of CETM.....	11
Table 4: Summary Characteristics of MEGABARE.....	15
Table 5: Summary Characteristics of GREEN.....	23
Table 6: Summary Characteristics of BMR Model.....	27
Table 7: Summary Characteristics of Borges and Goulder Model	29
Table 8: Estimates of the partial Hicks-Allen elasticities of substitution (σ) and factor shares (σ).....	32
Table 9: Energy substitution elasticities in GTAP-E and other models.....	35
Table 10: Elasticities of substitution between different factors of production	36
Table 11: The relationship between inner ($\sigma_{KE-inner}$) and outer ($\sigma_{KE-outer}$) elasticities of substitution for the cases of Japan and the US.....	37
Table 12: Elasticities of substitution between domestic and foreign sources (σ_D).....	347
Table 13: Elasticities of substitution between different regions (σ_M).....	36
Table 14: Marginal costs of achieving the Kyoto targets with and without using the flexibility mechanisms.	44
Table 15: Macroeconomic impacts of implementing the Kyoto Protocol	46

GTAP-E: Incorporating Energy Substitution into GTAP Model

1. Introduction

Energy is an important commodity in many economic activities. Its usage affects the environment via CO₂ emissions and the Greenhouse Effect. Modeling the energy-economy-environment-trade linkages is an important objective in applied economic policy analysis. Up to now, however, the modeling of these linkages in GTAP has been incomplete. This is because energy substitution, a key factor in this chain of linkages, is absent from the standard model specification. This paper remedies this deficiency by incorporating energy substitution into the standard GTAP model. It begins by first reviewing some of the existing approaches to this problem in contemporary CGE models. It then suggests an approach for GTAP which incorporates some of these desirable features of energy substitution.

The approach is implemented as an extended version of the GTAP model called GTAP-E. In addition, GTAP-E incorporates carbon emissions from the combustion of fossil fuels as well as a mechanism to trade these emissions internationally. The policy relevance of GTAP-E in the context of the existing debate about climate change is illustrated by some illustrative simulations of the implementation of the Kyoto Protocol. This technical paper is a revised version of a earlier paper written by T.P. Truong (Truong, 1999). Compared with this version, the model used here is derived from the version 6.1 of the GTAP model based on 1997 data (version 5 of the GTAP data base). In addition to inter-fuel substitution, this model incorporates some further improvements, such as the computation of a Social Account Matrice (SAM) which provides a full account of the carbon tax revenues and expenditures and a more specific treatment of carbon emission trading.

2. Review of Existing Approaches

In this section, we review some of the existing approaches to incorporating energy substitution into AGE models. The purpose of this section is not to undertake an exhaustive review of the literature, but rather, to select some typical approaches and examine their important features for possible incorporation into the GTAP model. There are three main models to be considered in this section, and these are: (1) the CETM model by Rutherford *et al.* (1997), (2) the MEGABARE model by ABARE (1996), and (3) the OECD's GREEN model by Burniaux *et al.* (1992). Some other models are also considered in sub-section 2.4.

2.1 The CETM Model - Rutherford *et al.* (1997)

This model represents an attempt to bridge the gap between the (top down) economic models often used by economists, and the (bottom-up) process models used by engineers and environmentalists in studying the effect of energy policies on the environment. Recognizing that full integration of these two types of models is methodologically and computationally difficult, the authors of CETM attempted a ‘partial’ link. This means, firstly, the construction of a partial equilibrium ‘process model’ of the energy sector (ETA) (which is based on the MERGE model of Manne and Richels (1996)). The model is then linked to a general equilibrium model called MACRO. The process of linking the two sub-models is through the process of passing the energy price and quantity variables between the two sub-models and iteration until the ‘input reference quantities’ from ETA are close to the solutions of the MACRO model (Rutherford *et al.* (1997, p6)). In light of the fact that the energy sector makes up only a small fraction (less than 5%) of the gross output of most economies, ‘convergence’ of the two sets of results from ETA and MACRO is considered most likely. This is because if energy is only a small part of the industry cost structure then the changes in the prices and quantities of energy demand within ETA will affect only marginally the overall results of industry costs and prices within MACRO. This means convergence of the two sets of results from ETA and MACRO can be achieved through an iteration process as described above, rather than by having to solve the optimization problems of the two sub-models simultaneously.

2.1.1 The Structure of CETM

The structure of CETM is described in Figure 1. Within this structure, the MACRO sub-model is a conventional computable general equilibrium (CGE) model, which has 5 internationally traded commodities and five industries: Y - Other manufactures and services, NFM = Non-ferrous metals, PPP = Pulp and paper, TRN = Transport industries, OTH = Other energy intensive sectors. The first industry is an aggregate of non-energy intensive industries, and the other four represent energy-intensive industries. Factors of production include: land, labor, capital, electricity, and non-electric energy. The latter two energy inputs are linked to ETA.

There are nine regions in MACRO: USA, JAPAN, CANZ (Canada, Australia, New Zealand), OECD (Other OECD), CHINA, INDIA, EFFSU (Eastern Europe and Former Soviet Union), MOPEC (Mexico and OPEC countries), and ROW (The rest of the world). With eleven ten-year time periods, this model begins the period of simulation from 1990 (benchmark year) and ends in 2100.

The structure of industry production in MACRO is as described in Figure 2. First, capital and labor are combined via a Cobb-Douglas production function¹. So are electric and non-electric energy inputs. The composite of non-energy material inputs, however, is combined using Leontief technology. The overall aggregation of composite primary factors, energy inputs, and non-energy materials is CES with an elasticity of substitution of 0.5.

¹ Figure 3 in Rutherford *et al.* (1997, p. 15) did not show land but the text (p. 9) mentioned land as one of the factors of production.

Figure 1 Structure of CETM

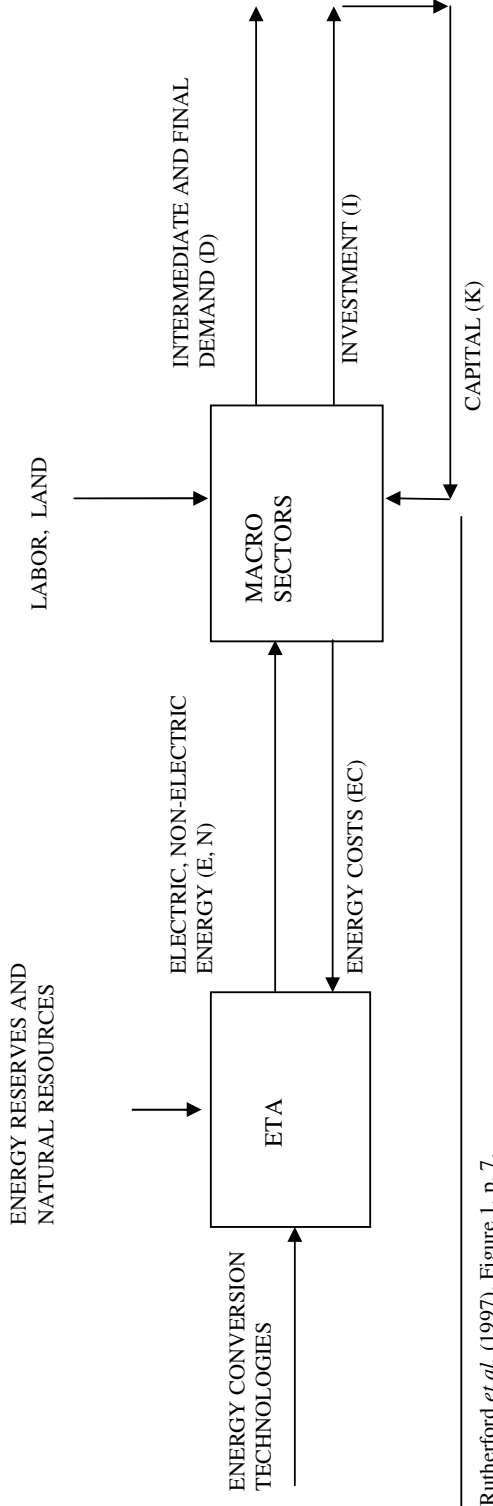

Source: Rutherford *et al.* (1997), Figure 1, p. 7.

Figure 2 MACRO Production Nest

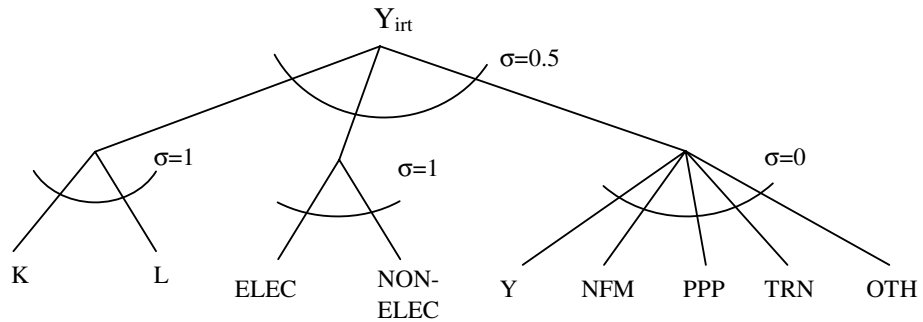

Source: Rutherford *et al.* (1997), Figure 3, p. 15.

Figure 3 MACRO Consumption Nest

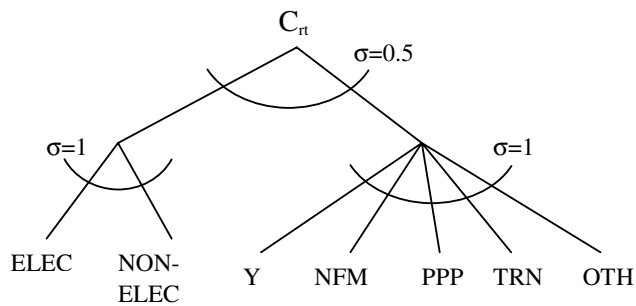

Source: Rutherford *et al.* (1997), Figure 2, p. 14.

Consumption in MACRO is described as CES-nested aggregate of energy and non-energy composite goods. Composite energy is a Cobb-Douglas aggregate of electric and non-electric inputs, while composite non-energy is a Cobb-Douglas aggregate of the five industrial goods. Consumers substitute composite energy and non-energy inputs with an elasticity of substitution of $\sigma_{end} = 0.5$, which is chosen to approximate the own-price elasticity of demand for energy.

MACRO is linked to ETA, a partial equilibrium sub-model which describes in greater details the energy sub-sector. ETA specifies the supply functions of electric and non-electric energy. Electric energy is produced by a combination of hydro-electricity, natural gas, oil, coal, and two 'backstop' technologies: advanced high cost, and advanced low cost. Non-electric energy can be produced either from oil, gas, coal, or by non-conventional technologies (such as carbon-free backstop, renewables, synthetic fuels). The list of electric and non-electric technologies in ETA are given in Table 1.

ETA includes the following internationally traded goods (g):

1	OIL	Crude oil
2	COAL	Coal
3	GAS	Natural gas
4	CRT	Carbon emission rights

ETA is formulated as a non-linear mathematical program. The decision variables in ETA include the following:

<i>SURPLUS</i>	The non-linear programming maxim and defined as the sum of consumer and producer surplus
$EC_{r,t}$	Energy cost (in region r and time period t) - trillion dollars
$EN_{r,t}$	Composite energy demand
$E_{r,t}$	Electric energy (total)
$N_{r,t}$	Non-electric energy (total)
$PE_{e,t,r}$	Production of electric energy (by source e) - tkwh
$PN_{n,t,r}$	Production of non-electric energy (by source n) - exaj
$GASNON_{t,r}$	Gas consumed to meet non-electric demands
$OILNON_{t,r}$	Oil consumed to meet non-electric demands
$RSC_{r,x,t}$	Undiscovered resources (by type x)
$RSV_{r,x,t}$	Proven reserves
$RA_{r,x,t}$	Reserve additions
$CLEV_{t,r}$	Carbon emissions level – billion tons
$CRLX_{t,r}$	Carbon limit relaxation – billion tons
$EXPRT_{g,t,r}$	Exports (of goods g)
$IMPRT_{g,t,r}$	Imports

To understand the internal workings of ETA, a list of some of the important equations in ETA is given in Table 2.

ETA solves for the aggregate shares of electric and non-electric energy. The solution is arrived at by MACRO first passing on to ETA the following variables and their time paths:

$\bar{e}_{r,t}$	Reference path of electric energy demand (TKW)
$\bar{n}_{r,t}$	Reference path of non-electric energy demand (EJ)
$pvcen_{r,t}$	Present value unit cost of energy sector inputs
$pvppe_{r,t}$	Present value price of electric energy
$pvpn_{r,t}$	Present value price of non-electric energy

Table 1 List of Technologies in ETA

No.	Short Name	Long Name	Restrictions
Electricity supply technologies (e):			
1	HYDRO	Hydro electric	
2	GAS-R	Existing gas-fired	
3	OIL-R	Existing oil-fired	
4	COAL-R	Existing coal-fired	
5	NUC-R	Existing nuclear	
6	GAS-N	New vintage gas-fired	DLE(e)
7	COAL-N	New vintage coal-fired	DLE(e)
8	ADV-HC	Advanced high-cost	DLE(e), XLE(e)
9	ADV-LC	Advanced low-cost	XLE(e)
Non-electricity energy supply technologies (n):			
10	OIL-LC	Low cost oil reserves	X(n)
11	OIL-HC	High cost oil reserves	X(n)
12	GAS-LC	Low cost gas reserves	X(n)
13	GAS-HC	High cost gas reserves	X(n)
14	CLDU	Coal for direct use	DLN(n)
15	NE-BAK	Non-electric backstop	DLN(n), XLN(n)
16	RNEW	Renewables	XLN(n)
17	SYNF	Synthetic fuels (coal shales)	DLN(n), XLN(n)

Note: X(n) Fossil fuels
DLE(e) Electricity technologies subject to decline limits,
DLN(n) Non-electric technologies subject to decline limits
XLE(e) Electricity technologies subject to expansion limits
XLN(n) Non-electric technologies subject to expansion limits

ETA then uses the ‘reference time path’ of energy demand to calculate other variables and parameters such as the ‘reference present value of energy demand’ $\bar{en}_{r,t}$ (equation (1)), the distributive share parameter of electric energy $evls_{t,r}$ (equation (2)) which is then used to calculate the composite energy demand (in volume terms) $EN_{r,t}$ (equation (4)), and the total of consumers’ and producers’ surplus (equation (3)). Note that the total surplus is normally calculated as the area between the consumers’ (regional) energy demand curve and the marginal cost curve. However, it can also be calculated as the total area under each region’s energy demand curve, then subtracting the total cost of energy supply. The demand function is assumed to have a constant own-price elasticity of σ and the function is ‘calibrated to MACRO’ (i.e. using the ‘reference present value of energy demand’ $\bar{en}_{r,t}$ as calculated from MACRO - see equation (3)). The total cost to produce energy is a linear combination of the direct costs to produce electric and non-electric energy, with an allowance for oil-gas price differential of OGPD = \$1.25/GJ for all regions, an allowance for interregional trade transportation costs of \$2/GJ for gas, \$1/GJ for coal, \$0.33/GJ for oil, and \$10/tonne for carbon emission rights (see equation (21)).

ETA then optimizes the mix of electric and non-electric technologies by maximizing the value of the total surplus subject to all the technological and institutional constraints (as described in equations (7-21) of Table 2). These constraints include things like: (a) market clearing conditions (supply of fuels and energy sources must at least meet the demand, total imports must equal total exports, etc.) (equations (7-9,20)), (b) ‘side constraints’ which control

the ‘availability’ of different technologies, through ‘expansion limits’ on new technologies, ‘decline limits’ on old (and new) technologies, and ‘exhaustion limits’ on non-renewable resources, etc. (equations (10-17)). In addition, equation (18) determines the carbon emission level and equation (19) specifies the limits on carbon emission rights which are given exogenously for each region and time period. Equation (22) defines the inverse demand function for composite energy in ETA, which is linked to the reference level in MACRO as explained in the next section below.

2.1.2 The Linkage of ETA to MACRO

In MACRO, the demand for composite (electric and non-electric) energy is structured as a CES function. This means the demand level for composite energy EN_j in sector j is related to the sector output Q_j , the sector unit cost C_j , and the composite energy price PEN_j by the relation:

$$EN_j = kQ_j \left(\frac{C_j}{PEN_j} \right)^\sigma \quad (i)$$

where k is some constant and σ is the own-price elasticity of demand for composite energy.

Let \overline{EN}_j , \overline{C}_j , and \overline{PEN}_j be the ‘reference level’ for these variables, i.e. the level as determined in the MACRO module. The linkage of ETA to MACRO is then defined by the following equation:

$$EN_j = \overline{EN}_j \left(\frac{PEN_j \overline{C}_j}{\overline{PEN}_j \overline{C}_j} \right)^{-\sigma} \quad (ii)$$

which follows from the previous relation, and

$$PEN_j = \left(\frac{P^E (1+t_j^E) + \mu_j^E}{P_j^E} \right)^{-a_j} \left(\frac{P^N (1+t_j^N) + \mu_j^N}{P_j^N} \right)^{1-a_j} \quad (iii)$$

where:

t_j^E, t_j^N are ad-valorem tax rates on electric and non-electric energy demand in sector j .

μ_j^E, μ_j^N are distribution margins on electric and non-electric energy (cost indices).

$\overline{P}_j^E, \overline{P}_j^N$ are the reference prices (user costs) of electric and non-electric energy.

The last equation is based on the assumption that the structure of the electric and non-electric energy composition is Cobb-Douglas.

If energy cost is only a small proportion of the overall sector cost, i.e.:

$$\frac{PEN_j \cdot EN_j}{C_j} = \frac{PEN_j (\partial C_j / \partial PEN_j)}{C_j} \ll 1,$$

then equation (b) can be approximated by:

$$EN_j = \overline{EN}_j \left(\frac{PEN_j}{PEN_t} \right)^{-\sigma} \quad (\text{iv})$$

or

$$PEN_j = \overline{PEN}_j \left(\frac{EN_j}{EN_t} \right)^{-\frac{1}{\sigma}} \quad (\text{v})$$

Equation (v) can be used to represent the inverse demand function for composite energy in ETA which will come out to be close to that modeled in MACRO. This is added to the list of equations for ETA (shown as equation (22) in Table 2).

Table 2 List of Important Equations in ETA

$$\overline{en}_{r,t} = pvpe_{r,t} \cdot \overline{e}_{r,t} + .pvpn_{r,t} \cdot \overline{n}_{r,t} \quad (1)$$

$$elvs_{r,t} = pvpe_{r,t} \cdot \frac{\overline{e}_{r,t}}{en_{r,t}} \quad (2)$$

$$SURPLUS = \sum_{r,t} \left(\overline{en}_{r,t} \cdot \frac{\sigma}{\sigma-1} \right) \left(\frac{EN_{r,t}}{\overline{en}_{r,t}} \right)^{\frac{\sigma-1}{\sigma}} - pvcen_{r,t} \cdot EC_{r,t} \quad (3)$$

$$E_{r,t}^{elvs} \cdot N_{r,t}^{1-elvs} = EN_{r,t} \quad (4)$$

$$E_{r,t} = \sum_e PE_{e,r,t} \quad (5)$$

$$N_{r,t} = OILNON_{t,r} + GASNON_{t,r} + PN_{cdu,t,r} + PN_{synf,t,r} + PN_{mew,t,r} + PN_{ne-bak,t,r} \quad (6)$$

$$GASNON_{t,r} = PN_{gas-lc,t,r} + PN_{gas-hc,t,r} + IMPRT_{gas,t,r} - EXPRT_{gas,t,r} - ch_{gas-r,t,r} \cdot PE_{gas-r,t,r} - ch_{gas-n,t,r} \cdot PE_{gas-n,t,r} \quad (7)$$

$$GASNON_{t,r} \leq 0.5 \cdot N_{r,t} \quad (7b)$$

$$OILNON_{t,r} = PN_{oil-lc,t,r} + PN_{oil-hc,t,r} + IMPRT_{oil,t,r} - EXPRT_{oil,t,r} - ch_{oil-r,htrt,r} \cdot PE_{oil-r,t,r} \quad (8)$$

Table 2 List of Important Equations in ETA

$$PN_{coal,t,r} = EXPRT_{coal,t,r} - IMPRT_{coal,t,r} - ch_{coal-r,htrt,r} \cdot PE_{coal-r,t,r} + ch_{coal-n,htrt,r} \cdot PE_{coal-n,t,r} + PN_{cldu,t,r} + (1 + syntpe) \cdot PE_{synf,t,r} \quad (9)$$

$$PE_{dle,ty+1,r} \geq PE_{dle,ty,r} \cdot decf_r^{10} \quad (10)$$

$$PE_{dln,tp+1,r} \geq PE_{dln,tp,r} \cdot decf_r^{10} \quad (11)$$

$$PN_{xln,t,r} \cdot nxpf_r^{10} + nshf_n \cdot N_{r,t+1} \geq PN_{xln,t+1,r} \quad (12)$$

$$\sum_{xle} (PE_{xle,tp,r} \cdot \exp J_{rg}^{10}) + nshf_{RG} \cdot E_{r,t+1} \geq \sum_{xle} (PE_{xle,t+1,r}) \quad (13)$$

$$RSC_{r,x,t+1} = RSC_{r,x,t} - 5 \cdot RA_{r,x,t} - 5 \cdot RA_{r,x,t+1} \quad (14)$$

$$RSV_{r,x,t+1} = RSV_{r,x,t} + 5 \cdot (RA_{r,x,t} - PN_{x,t,r}) + 5 \cdot (RA_{r,x,t+1} - PN_{x,t+1,r}) \quad (15)$$

$$rdf_{x,r} \cdot RSC_{r,x,t} \geq RA_{r,x,t} \quad (16)$$

$$prv_{x,r} \cdot RSV_{r,x,t} \geq PN_{x,t,r} \quad (17)$$

$$CLEV_{t,r} = \sum_e et, cece_{e,r} \cdot PE_{e,t,r} + \sum_n nt, cecn_{n,r} \cdot PN_{n,t,r} - (EXPRT_{gas,t,r} - IMPRT_{gas,t,r}) \cdot cecn_{gas,r} - (EXPRT_{oil,t,r} - IMPRT_{oil,t,r}) \cdot cecn_{oil,r} \quad (18)$$

$$CLEV_{t,r} = EXPRT_{crt,t,r} - IMPRT_{crt,t,r} \leq carlim_{t,r} \quad (19)$$

$$\sum_r (EXPRT_{q,t,r} - IMPRT_{q,t,r}) = 0 \quad (20)$$

$$EC_{t,r} = \sum_e (PE_{e,t,r} \cdot ecst_{e,r}) + \sum_n (PN_{n,t,r} \cdot ncst_{n,r}) + ogpd_r \cdot GASNON_{t,r} + \sum_n (cstcexp_q \cdot EXPRT_{q,t,r}) \quad (21)$$

$$PEN_j = \overline{PEN}_j \left(\frac{EN_j}{\overline{EN}_t} \right)^{-\frac{1}{\sigma}} \quad (22)$$

2.1.3 Comments on the Structure of CETM

2.1.3.1 The Structure of Production and Inter-fuel and Fuel-factor Substitution.

The structure of production in the MACRO module of the CETM model groups labor and capital together, and these factors are separated from the energy branch (see Figure 2). This means that energy-capital and energy-labor will have the same substitution elasticity and this implies a severe restriction (see the discussion on the issue of capital - energy substitutability or complementarity in section 3.2 below).

On the other hand, the internal structure of the inter-fuel substitution in the MACRO module makes a useful distinction between electric and non-electric energy inputs. Although econometric evidence is scarce with respect to the substitution between electric and non-electric energy inputs, this distinction is useful at least from a theoretical viewpoint. This is because the choice of the electricity generation technologies may have an important impact on the environment (such as the emission of CO₂), and hence the focus on electric energy consumption level may help focus attention on the choice of these technologies².

Different forms of non-electric energy such as oil, gas, coal (direct use), synthetic fuels, renewable fuels or the non-electric backstop technologies, are treated as perfect substitutes in the ETA module (see equation (6) in Table 2). This assumption is perhaps rather restrictive especially from the end-user's point of view. Natural gas, for example, is known to command a premium over coal because of its ease of handling. It may also come into conflict with other assumptions made in the model such as the fact that the market share for natural gas is limited (see equation (7)). Limited market share often implies some difficulty of substitution rather than limitation in supply. Finally, if these non-electric energy forms are perfectly substitutable, then their marginal costs (prices) must also be set equal to each other. These are strong assumptions.

2.1.3.2 The 'Small' Influence of the Energy Sector in Linking ETA to MACRO

Relying on the fact that the energy sector makes up less than 5% of the gross output of most economies, it is anticipated that any changes in the prices and quantities of energy demand within ETA will have only a small influence on the overall industry cost (and hence prices and demand within MACRO). This means that convergence of the results of ETA and MACRO can be achieved fairly rapidly. But this is likely to depend also on the assumptions regarding supply and demand elasticities. If the supply elasticity is much greater than the absolute value of the demand elasticity then convergence can be assured. However, if the converse is true, then even if energy is only a small proportion of the overall industry costs, it can still act as a constraint on consumption activities, and can give rise to significant fluctuations in energy prices and demand, and therefore, will not help for convergence (see Figure 4). Since ETA is a process model rather than a conventional econometric model, the concept of 'supply elasticity' cannot be clearly

² Furthermore, as Hogan (1989, p. 54) noted, the grouping of all energy forms together in an aggregate energy demand function may mask the historically important trend of 'electrification' in an energy economy (such as that observed in the US economy during the period from 1960 to 1982).

Figure 4 ETA - MACRO Linkage

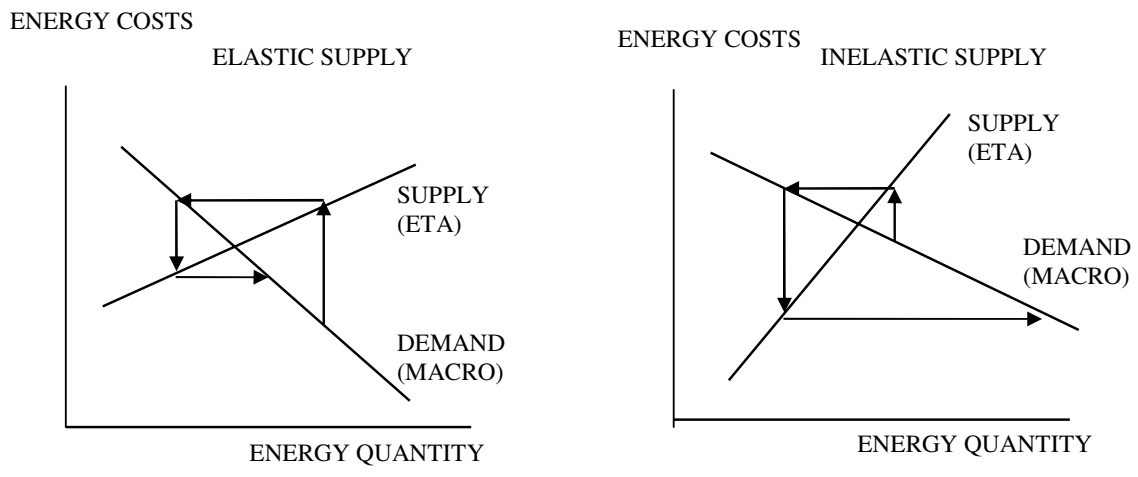

defined and tested. However, the general concept of supply responsiveness to price and demand changes may still be an important factor to consider when looking at the issue of convergence.

2.1.3.3 'Dynamic Adjustment Constraint' on Technologies could be Linked to Endogenous Factors within the MACRO economy.

Equations (10-13) represent the 'dynamic adjustment constraints' on new and existing technologies. They define the limits to which existing technologies can be retired (because of sunk capital costs) or new technologies to be introduced (because of the difficulty of market penetration). These constraints reflect economic as well as institutional factors within the current and future markets, and therefore, they could also be determined 'endogenously' within the model rather than being set exogenously. For example, the rate of market penetration for new technologies may be dependent on the differences in production costs between existing and new technologies. The rate of retirement for existing technology can also be specified as a function of the expected increase in future demand and supply and the cost of capital. In other words, the dynamic adjustment constraints could be linked to the investment decisions within the model, rather than being specified as exogenous. Since the absence of such a linkage is largely due to practical considerations, this is probably an area for further research.

Table 3 Summary Characteristics of CETM

Model Characteristics	CETM
Top-down versus bottom-up	Bottom-up in CETM, top-down in MACRO
Dynamic	Simultaneous
Inter-fuel substitution	Yes
Fuel-factor Substitution	Yes
Capital – Energy complementarity/substitutability	Energy and capital are substitutes in the MACRO production structure, but can be complements within the energy sub-module CETM.

2.2 The MEGABARE Model and the “Technology Bundle” Approach³

In building the MEGABARE model on top of the GTAP framework, the authors of that model made ‘a deliberate decision ...not to adopt the nested CES (constant elasticity of substitution) production function approach’ to energy substitution. This was because:

It was believed that it was possible to improve on the nested CES approach in terms of both accuracy and transparency by introducing what has been termed the ‘technology bundle’ approach. Using this approach, a level of detail about different technologies is introduced into MEGABARE that is normally found only in so-called ‘bottom up’ models. An attempt is made to introduce the realism in modelling substitution options that is a feature of ‘bottom up’ models while retaining extensive interactions between the energy and other sectors of the economy that is a feature of ‘top down’ models. (MEGABARE, 1996: 4).

2.2.1 Description of the Technology Bundle Approach

The ‘technology bundle’ approach is described below in figures 5-7. First, the intermediate inputs into production are divided into technology bundle inputs – typically primary factors and primary energy inputs - and non-technology bundle inputs (Figure 5). The technologies for an industry (for example, coal-fired electricity, gas-fired electricity etc.) are Leontief (fixed input-output coefficient) combinations of technology bundle inputs. The technology bundle for an industry is a conventional ‘smooth production function’ (such as CRESH) combination of the output of each technology. Industry output is a Leontief combination of the technology bundle and the non-technology bundle inputs

The technology bundle approach is used in the MEGABARE model to describe the input use of the *electricity* generation industry (Figure 6) and the *steel* industry, which represent typical examples of energy intensive industries. The approach, however, can also be used to describe other energy intensive industries. With the steel industry, the input structure differs slightly from the electricity industry: electricity and minerals are added to the input list, along with the primary factors and the primary energy inputs (Figure 7).

Figure 5 Technology Bundle Approach

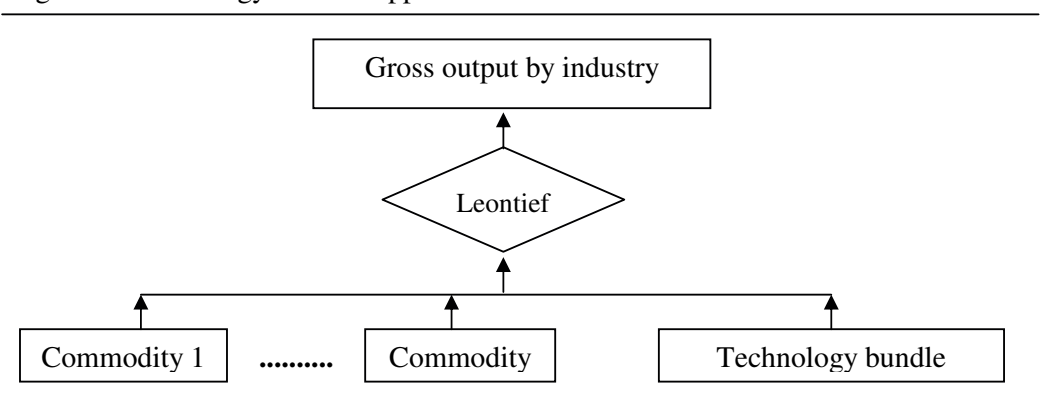

Source: ABARE (1996), Figure 6, p. 22.

³ ABARE (1996), *The MEGABARE model: interim documentation*, February.

Figure 6 Composition of the Technology Bundle for the Electricity Industry

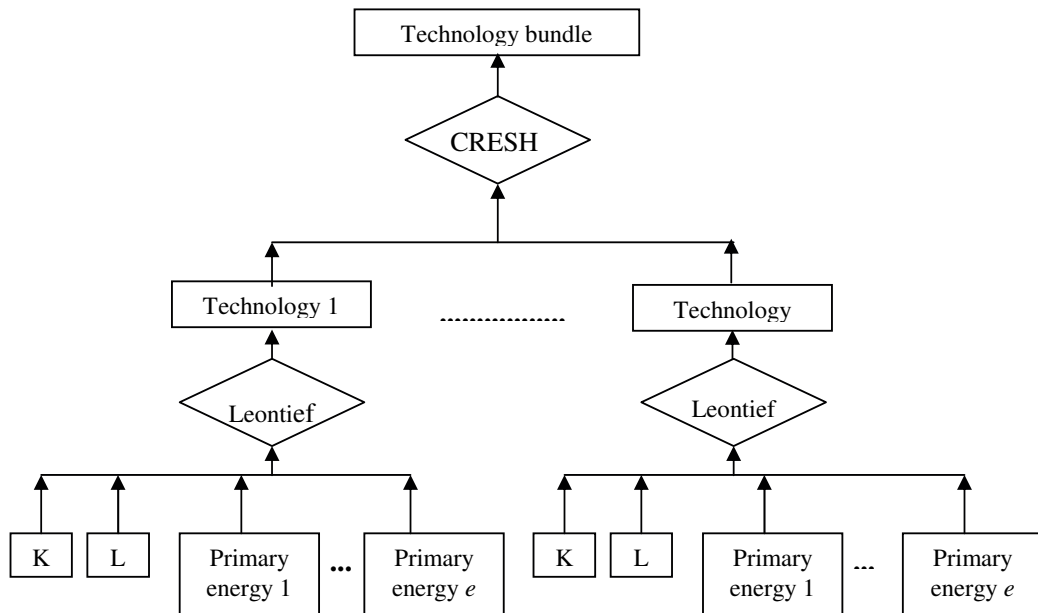

Source: ABARE (1996), Figure 9, p. 32.

Figure 7 Composition of the Technology Bundle for the Steel Industry

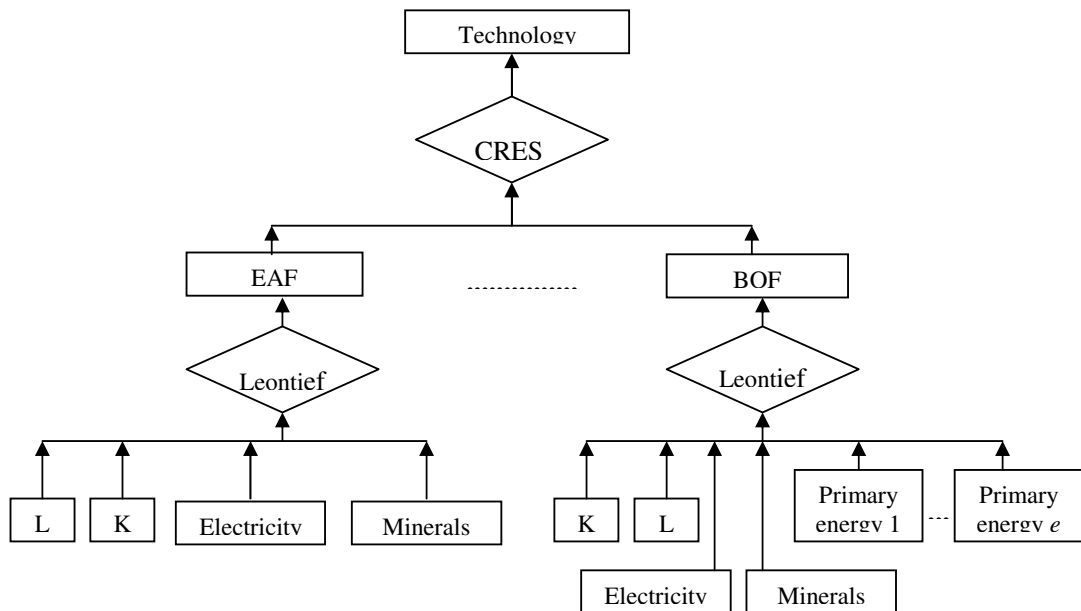

Source: ABARE (1996), Figure 10, p. 32.

'EAF' and 'BOF' stand for 'electric arc furnace' and 'basic oxygen furnace' respectively.

2.2.2 Comments on the Technology Bundle Approach

The technology bundle approach is interesting and innovative. It tries to introduce the concept of ‘substitution’ between alternative ‘technologies’ to give a more realistic description of the nature and range of substitution occurring within the energy producing and energy-using industries, in contrast to the more traditional concept of substitution between alternative energy and non-energy inputs. In doing so, the approach can claim the following advantages:

1. it ‘ensures that the pattern of input use is consistent with known technologies’ which usually exhibit what may be described as ‘lumpy’ or indivisibility constraints on certain inputs such as capital or labor,
2. it is highly transparent in the sense that it allows an assessment of how some policy change can lead to ‘relative changes in the use of different technologies’ rather than a mere observation of the derived changes in inputs use (ABARE, 1996: 35).
3. the elasticity of substitution parameters in the technology bundle approach can be estimated “by reference to the results from ‘bottom up’ models” and therefore, can cover ‘a wider range of data values that might occur in a simulation’ (ABARE, 1996: 36).

While in theory, it is true that the technology bundle approach can provide a more realistic description of the constraints facing the energy producing and energy-using industries than a conventional econometric approach, in practice, however, it is not clear how some of these potential advantages can always be implemented. In MEGABARE, for example, inputs into the technology bundles are still being specified as Leontief with no explicit ‘indivisibility’ or lumpy constraints imposed⁴. On point 3, it is not evident how the CRESH substitution parameter used in the MEGABARE model had been actually derived from some simulation experiment of a ‘bottom-up’ nature.

On a more important point, the technology bundle approach is not dissimilar to the conventional approach in econometrics where a nested production structure is used to describe complex substitution possibilities among the inputs⁵. As Powell and Rimmer (1998) note: “Models in which output is produced according to a technology in which capital (K), labor (L) and energy (E) are substitutable run into the difficulty of how to allow parsimoniously for the higher likely substitutability between K and E than between L and E”. In fact, the issue of ‘substitutability’ or ‘complementarity’ between K and E is a long-standing issue in the energy debate (see section 3.2 below). To handle this issue, most models allow for K and E to be separated from L. In the technology-bundle approach, although E and K are complements within a given technology structure, they are substitutes at the higher level, where technologies are substitutable for each other. Thus, given an energy price increase, although K cannot be used to replace E immediately in any given technology, a less energy-intensive but more capital-intensive technology can be put in place, to counter the energy price rise, thus fulfilling the

⁴ The MEGABARE documentation (ABARE, 1996) does not refer to any of these indivisibility constraints but in a different documentation (Hanslow *et al.* (1994:28)), a reference is made to ‘capacity constraint’ in the context of the discussion of the pricing formula for a commodity which is used as input into a particular ‘technology’. Here, it is stated that ‘capacity constrained technology earns above normal returns to capital’ which is to be represented by a ‘slack’ variable.

⁵ See for example, Perroni and Rutherford (1995), Powell and Rimmer (1998).

Table 4 Summary Characteristics of MEGABARE

Model Characteristics	MEGABARE
Top-down versus bottom-up	Bottom-up in technology bundle specification, top-down in the rest of the model structure
Dynamic	Recursive
Inter-fuel substitution	Indirectly through technology substitution
Fuel-factor Substitution	Indirectly through technology substitution
Capital – Energy complementarity/substitutability	Energy-capital are complements within a given technology, but can be substitutable through technology substitution.

function of substitutability between K and E in the longer run. In this respect, the technology bundle approach is quite innovative and flexible.

2.3 The OECD'S GREEN Model⁶

GREEN is a global, dynamic AGE model which highlights the relationships between depletion of fossil fuels, energy production and use, and CO₂ emissions. The main focus is on the energy sector and its linkage to the economy.

There are three types of fossil fuels in the model - oil, natural gas, and coal - and one source of non-fossil energy - the electricity sector. Each of these can be replaced at some future date by "backstop" technologies. These are assumed to become available at an identical time period in all regions. Their prices are determined exogenously and identically across all regions⁷. This implies an infinite elasticity of supply.

For each of the three fossil fuels, there are two alternative backstop technologies: one carbon-free (e.g. biomass) and one carbon-based (synthetic fuel derived from shale or coal, with higher carbon content than conventional technology). For electricity, the backstop technology is carbon-free (nuclear fusion, solar or wind power, but excluding hydro, or nuclear fission).

There are eight energy-producing sectors in GREEN: Coal mining, Crude oil, Natural gas, Refined oil, Electricity-gas-water distribution, Carbon-based back-stop, Carbon-free back-stop, Carbon-free electric back-stop. The three non-energy producing sectors are Agriculture, Energy-intensive industries, and Other industries and services.

There are four consumption goods: Food beverages and tobacco, Fuel and power, Transport and communication, and Other goods and services. These are chosen to be different from the outputs of the production sectors to highlight the principal components of final demand

⁶ Burniaux, J. M., Nicoletti, G., and J. Oliveira-Martins (1992), "GREEN: A Global Model for Quantifying the Costs of Policies to Curb CO₂ Emissions", *OECD Economic Studies No. 19*, Winter, 49-92; Lee, Hiro, Joaquim Oliveira-Martins, and Dominique van der Mensbrugge (1994), "The OECD GREEN Model: An Updated Overview", OECD Development Centre Technical Paper No. 97.

⁷ Their marginal costs, however, are not identical, and therefore, there is a return attributed to the fixed factor. Backstops are not traded. Their role is primarily to limit the rise in prices, and therefore in carbon taxes.

for energy. Consumers are assumed to be deciding on the optimal allocation of their given disposable income on saving and the four consumption goods. The demands for these consumption goods are then translated into the demands for producer goods (and energy) via a 'transition' or make matrix.

There are twelve regions in the GREEN model: United States, Japan, EC, Other OECD, Central and Eastern Europe, The former Soviet Union, Energy-exporting LDCs, China, India, Dynamic Asian Economies (Hong Kong, Philippines, Singapore, South Korea, Taiwan and Thailand), Brazil, Rest of the World (RoW).

Finally, there are five different types of primary factors: labor, sector-specific "old" capital, "new" capital, sector-specific fixed factors (for each fossil fuel type, and for the carbon-free backstop), and land in agriculture.

2.3.1 Dynamics in GREEN

One special feature of the GREEN model is in its dynamic treatment of the energy-capital complementarity / substitutability issue and also in the handling of the resource depletion issue. The dynamics in GREEN in fact come mainly from these two issues: depletion of exhaustible resources, and capital accumulation.

In the resource depletion 'sub-model', the total (proven plus unproven) reserves are assumed to be determined exogenously. However, the rate at which 'unproven' reserves are converted into 'proven' reserves (rate of discovery or rate of conversion) is made sensitive to the prices of oil and gas. This affects the 'potential supply', which is defined by the rate at which proven reserves are extracted⁸. Potential supply provides an upper bound on actual supply, and if actual demand falls short of potential supply, then the difference between potential and actual supply is added to the future reserves of the fossil fuels. The resource depletion sub-model is thus recursively dynamic (i.e. based on current and past prices only) rather than forward looking (i.e. based on some expected future prices).

Capital accumulation in the GREEN model is influenced by the putty/semi-putty assumption on the nature of capital. New capital (capital invested in current period) is putty, i.e. it is highly substitutable for other factors (elasticity of substitution is 2). Sector-specific old capital (capital invested in previous periods), on the other hand, is semi-putty and much less substitutable for other factors (elasticity of substitution can be as low as 0.25). Sector-specific old capital is also much less mobile between sectors (implying small and sector-specific supply elasticities). This can result in equilibrium rental values of old and new capital being significantly different from each other, and the ratio of these rental values is used in GREEN to stimulate 'disinvestment' of old capital (see Burniaux *et al.* (1992: 57)). Once disinvested, old capital becomes available for use in new investment. At any point in time, the stock of capital will consist of old and new capital, and the rate of substitution between the stock of capital as a whole and other factors will therefore depend on the vintage structure of capital. Apart from this dynamic vintage structure, GREEN does not include any other explicit investment behavior by firms. The total aggregate level of investment is defined as a residual from the aggregate level of

⁸ Though the extraction rate is assumed constant overtime, energy prices affect the potential supply of oil and gas through the price sensitive conversion rate (Burniaux *et al.* 1992, van der Mensbrugghe, 1994).

savings minus government sector balance and plus net capital inflows. Once the aggregate level of investment is determined, this is then distributed optimally to the various sectors in order to equate rates of return on new investment.

2.3.2 Inter-fuel Substitution

2.3.2.1 Inter-fuel Substitution in Production

In estimating the inter-fuel elasticities of substitution, the general assumption is that energy and capital are weakly separable in production. This means that firms choose the cost-minimizing energy-mix *given* an energy-capital bundle. But this makes sense only if there are dual-fired or multi-energy technologies available, otherwise, inter-fuel substitution will involve the installation of new capital and therefore, the assumption of separability between energy and capital breaks down (Burniaux *et al.* (1992, p. 75)). Thus, in choosing to represent the potential for inter-fuel substitution, the GREEN model assumes that short run to medium run elasticities of substitution between alternative forms of energy are small, between 0.5 and 1.0 in the medium term, and only 0.25 in the short term. Long-run⁹ elasticities of inter-fuel substitution, however, are set as high as 2.0. This latter value is said to be based on empirical estimates of elasticities based on samples which have multiple power-generating facilities (Burniaux *et al.*, *loc. cit.*). These inter-fuel substitution elasticities apply only to the non-energy producing sectors and the electricity generation sector. For the rest of the energy producing sectors (coal mining, crude oil, natural gas, refined oil), there is no inter-fuel substitution (see Burniaux *et al.* (1992, Table 3, p. 76))

The structure of inter-fuel substitution in production in the 1992 version of the GREEN model is as shown in Figure 9. In a subsequent version¹⁰, the structure is altered significantly to allow for three levels of nested substitution: (i) substitution between electricity and a 'non-electric' composite fuel, (ii) substitution between coal and a 'non-coal' composite within the non-electric branch, and finally, (iii) substitution between oil, gas, and refined fuels within the non-coal branch. All substitution elasticities are set within the range $0.25 < \sigma < 2$, depending on whether it is short-run, medium-run, or long-run.

2.3.2.2 Inter-fuel Substitution in Household Demand

Given the energy intensity of each consumer good, household demand for aggregate energy is derived from its demand for the four categories of consumer goods (see Figure 10). Once the demand for aggregate energy is known, this demand is then allocated optimally between the different fuels with the same structure of inter-fuel substitution as in the case of producers' demand for energy (Figure 9).

⁹ This long run is defined as the period over which new capital can be installed.

¹⁰ See Lee *et al.* (1994, Figure 1b, p. 49)

Figure 8 The Structure of Production in GREEN

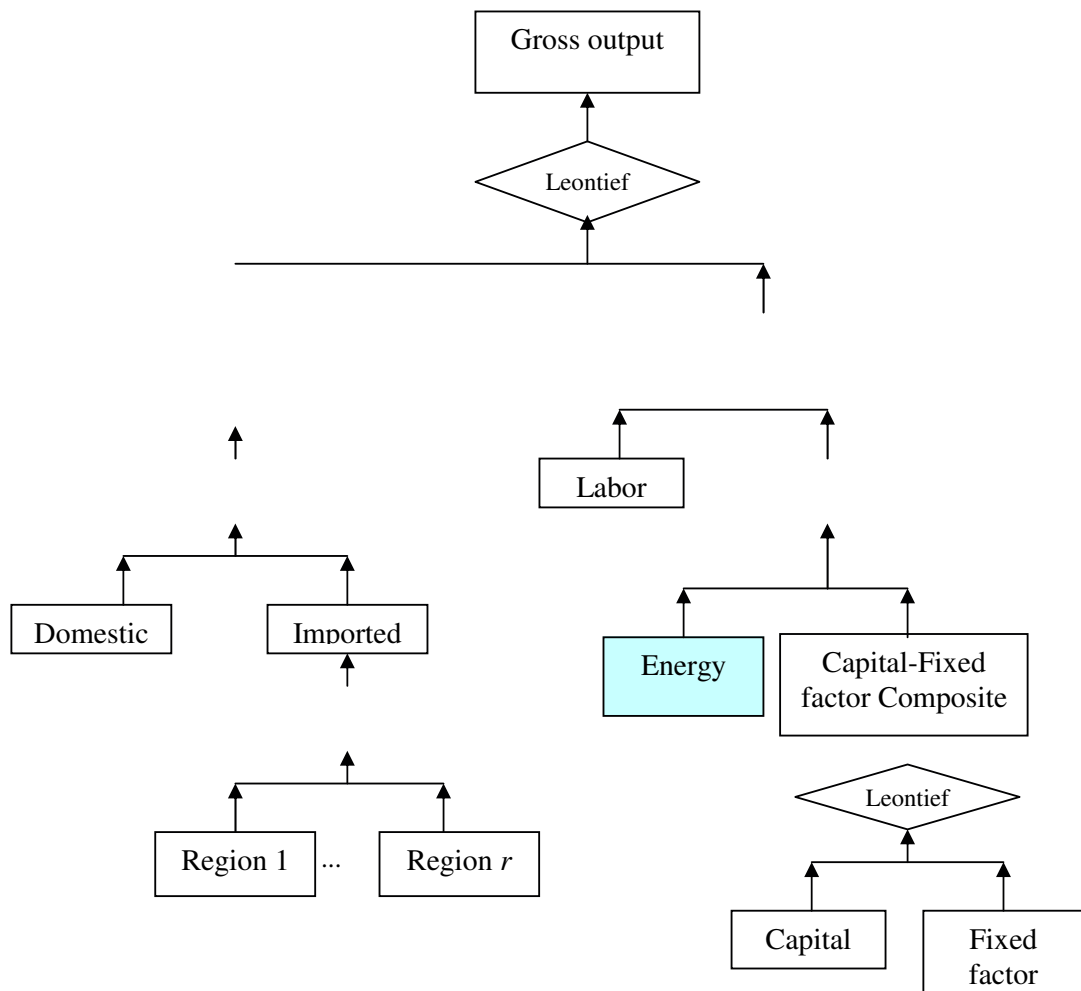
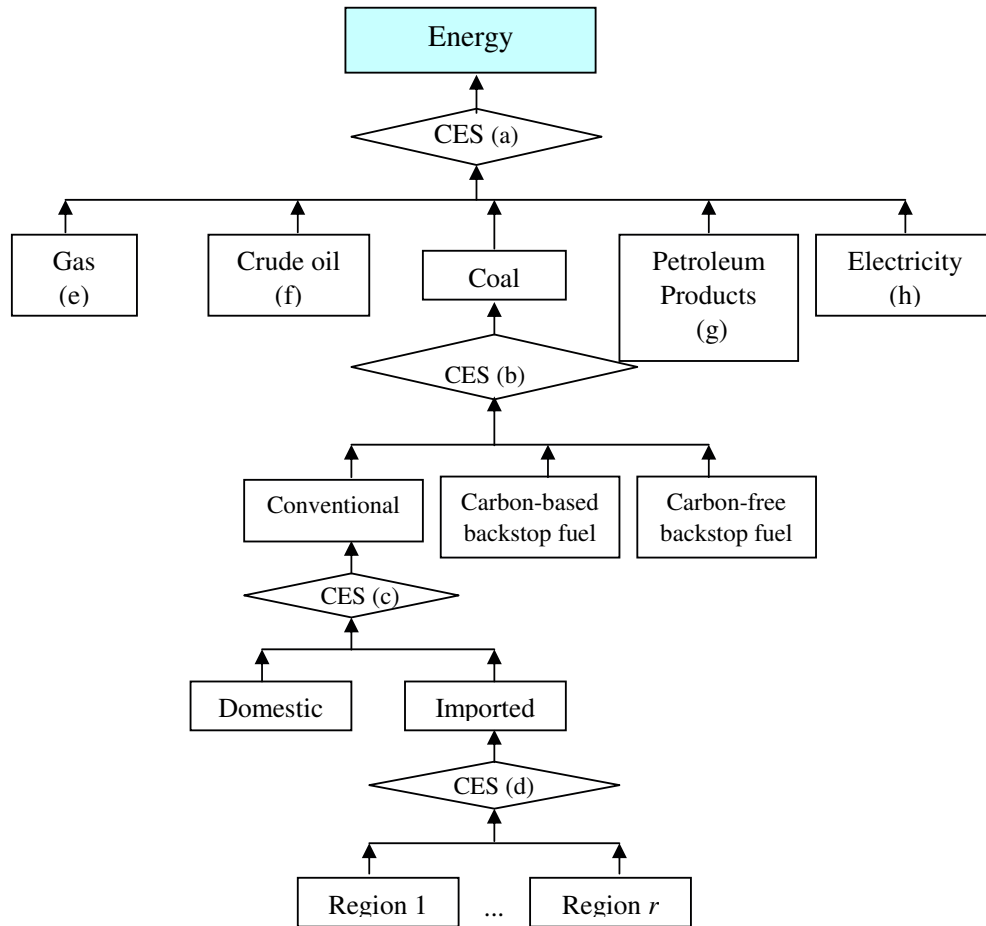
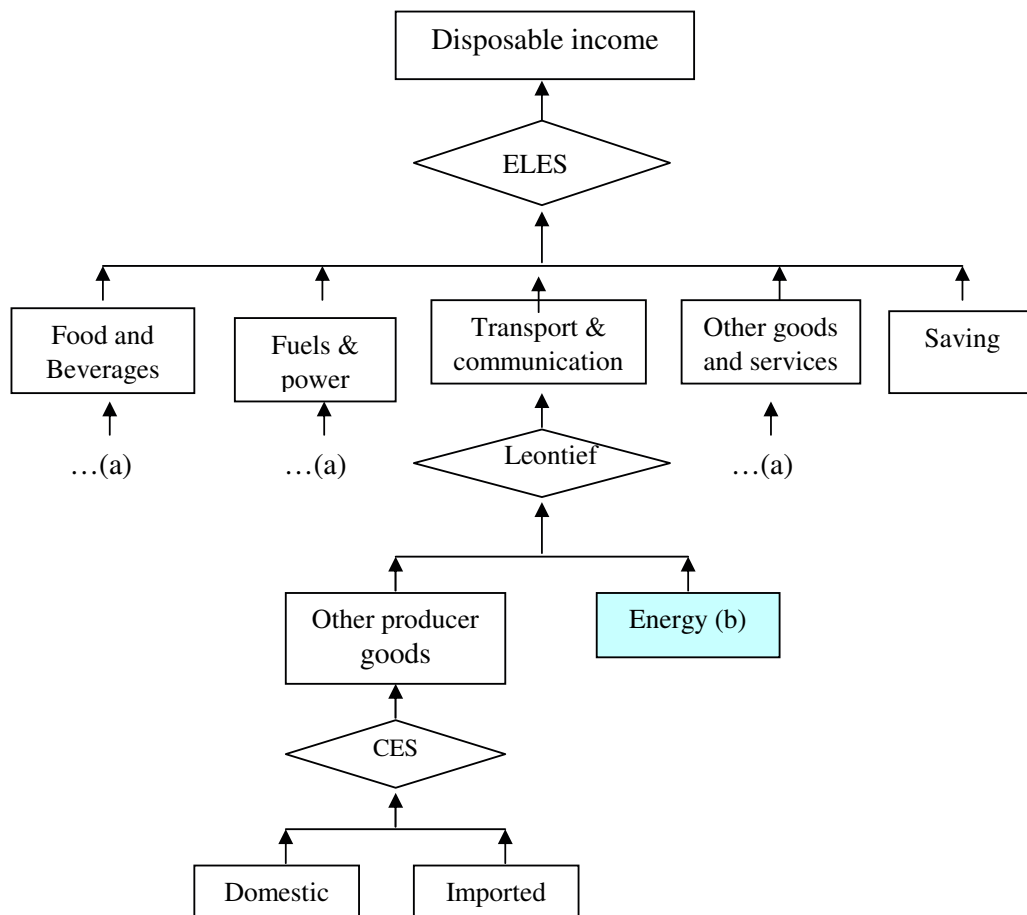

Figure 9 Energy and Backstop Technologies in GREEN



- (a) With elasticity of substitution ($\sigma=0.25$) for 'old' capital, and ($\sigma=2$) for 'new' capital, in all sectors except coal mining, crude oil, natural gas, and refined oil (see Burniaux *et al.*, 1992, Figure 1b, p. 56, and Table 3, p. 76). In Lee *et al.* (1994), there is some further nesting (all with $0.25 < \sigma < 2$): between electric and non-electric' composite, then between 'coal' and non-coal' composite within the non-electric branch, and finally between oil, gas, and refined fuel in the non-coal branch
- (b) Elasticity of substitution between conventional and backstop technologies is ($\sigma=10$) for agriculture, refined oil, electricity, energy-intensive industries, and other industries, as well as for consumer goods and government demand, and in the production of investment goods and inventories.
- (c) Elasticity of substitution between domestic and imported fuels is ($\sigma=4$) for all fuels, except electricity ($\sigma=0.3$), and crude oil ($\sigma=\infty$).
- (d) Elasticity of substitution for fuels from different regions (world trade elasticities) is ($\sigma=\infty$) for crude oil, ($\sigma=5$) for coal mining and natural gas, and ($\sigma=3.0$) for refined oil.
- (e) Same as for coal.
- (f) Same as for coal except with ($\sigma=\infty$) for domestic-imported and inter-regional substitutions.
- (g) Same as for coal except there are no backstop fuels and world trade elasticities is ($\sigma=3$).
- (h) Same as for coal except there is only one carbon-free backstop option and world trade elasticities is ($\sigma=0.5$).

Figure 10 The Structure of Household Demand in GREEN



- (a) Same as for transport & communication.
(b) See Figure 9.

2.3.3 Fuel-factor Substitution

The GREEN model assumes that capital-labor and energy-labor have the same (positive) elasticities of substitution. This assumption accords with empirical econometric evidence which supports substantial short-run and long-run substitutability between labor and capital on the one hand, and also between labor and energy on the other hand. On the issue of energy-capital substitutability or complementarity, however, empirical estimates seem to be more of a problem. A widely held opinion in this area is that perhaps energy and capital are complements in the short-run, but substitutes in the long-run. To incorporate this feature into the model, the approach in GREEN is to utilize a 'vintage capital' structure. Thus, short run substitution between 'old' capital and energy can be low, while long-run substitution between 'new' capital and energy can be high. The net effect will then depend on the capital vintage structure. Over time, the short-run elasticities will converge to the long-run elasticities (see Figure 5 in Burniaux *et al.* (1992, p. 66)). The gap between short- and long-run elasticities and the speed of the convergence depends on the dynamics of the capital stock adjustment process which in turn depends on assumptions made about depreciation rate and rate of new capital formation. The larger the net replacement rate, the smaller the gap between short- and long-run elasticities and the faster the convergence of the former to the latter.

In GREEN, capital is combined with a fixed factor through a Leontief structure before being combined with energy through a CES structure. The role of the fixed factor is to limit the substitution away from/towards capital formation in the energy-producing sectors so as to avoid an unrealistic situation where, for example, following an increase in the relative price of energy, 'too much' investment will occur in these sectors even in the short run. The role of the fixed factor in primary-energy producing sectors is thus to impose limits on the supply elasticities of these primary energies. These supply elasticities have a critical role to play, especially in energy-environmental policy simulation studies.

Substitution between energy and the fixed factor-capital composite is set at zero for all energy-producing sectors, except electricity. For electricity and other non energy-producing sectors, it is set at zero for 'old' capital, and at a low value of 0.8 for new capital. Substitution between labor and capital-energy-fixed factor composite is also set at zero for all energy-producing sectors including electricity. For other sectors, it is set at a low value of 0.12 for old capital and a high value of 1.0 for new capital (Burniaux *at al.* (1992, Table 3, p. 76).

According to Borges and Goulder (1984, p. 340), to ensure that the capital-energy complementarity condition can be achieved, it is 'sufficient' that the elasticity of substitution between K and E within the KE nest be given a 'substantially smaller (even if positive)' value as compared to the elasticity of substitution between the KE composite and labor (or other factors) in the 'outer nest'. To be more precise, we can use the following formula established for the case of a nested CES structure by Keller (1980, p. 83):

$$\sigma_{KE-outer} = [\sigma_{KE-inner} - \sigma_{VA}] / S_{KE} + \sigma_{VA}$$

In this formula, S_{KE} is the share of the KE-composite in the outer (value-added) nest, and $\sigma_{KE-inner}$ and $\sigma_{KE-outer}$ stand for the inner and outer substitution elasticities between K and E respectively. If $\sigma_{KE-inner}$ is less than σ_{VA} , then the first term on the right hand side is negative. But whether $\sigma_{KE-outer}$ is negative (implying complementarity between K and E in the outer nest) depends on the size of S_{KE} as well. If S_{KE} is small, then this is likely even if σ_{VA} is large. For

example, using the upper limit values of 0.8 and 1.0 for $\sigma_{KE-inner}$ and σ_{VA} respectively as used in the GREEN model for the case of new capital, this requires $S_{KE} < 0.2$ for $\sigma_{KE-outer} < 0$ (complementarity between K and E in the outer nest). Using the lower limit values of 0.0 and 0.12 respectively for $\sigma_{KE-inner}$ and σ_{VA} for the case of old capital, this requires $S_{KE} < 1.0$ for $\sigma_{KE-outer} < 0$. The condition is always satisfied since S_{KE} is always less than 1. Overall, thus, ‘old’ capital and energy will always come out as complements in the value added nest of the GREEN model production structure. For ‘new’ capital, this will also be the case if the share of capital-energy-fixed factor component in the value-added nest is less than 20 percent. Note that all these discussions apply to the non energy-producing sectors only. For the energy-producing sectors (except electricity) there is no fuel-factor substitution. The electricity sector is characterized by an ‘inner’ substitution elasticity of $\sigma_{KE-inner} = 0.8$ (for new capital only), and a zero ‘outer’ substitution elasticity of $\sigma_{VA} = 0$ in the value-added nest. This implies ‘new capital-fixed factor bundle’ and ‘energy’ are always substitutes in the electricity sector.

2.3.4 Comments on the GREEN Model

One innovative feature of the GREEN model is in the handling of the energy-capital complementarity / substitutability issue through the use of a dynamic capital vintage structure. Through this structure, the issue of long-run substitutability versus short-run complementary between capital and energy is handled quite flexibly (see the illustrative numerical calculations carried out in the previous section). This is a significant improvement over many other models which do not handle this issue explicitly.

The specification of the capital vintage structure is an important first step. However, the next step can perhaps focus attention also on the issue of capital investment. Currently, the aggregate level of investment in the GREEN model is specified as a residual from the level of aggregate saving minus government sector balance plus net capital inflows. Once the aggregate level of investment is determined, the aggregate level of new investment is then distributed optimally among the sectors. Following from this, the ratio of the new- to old-capital rates of return is also determined, and this will then influence the rate of old-capital disinvestment (i.e. the rate at which old capital is transformed back into the pool of ‘new’ investment in the next period). All of this will affect the capital vintage structure. Throughout this process, energy prices play an important role, in influencing the rate of return on (old and new) capital, and hence on aggregate investment. However, this influence is still indirect via the aggregate return on capital. A more direct role for energy prices may be in influencing the capital vintage structure directly, for example, in bringing about a rate of investment which will ‘equalize’ the rates of return on ‘old’ and ‘new’ capital over the ‘long run’. This, however, implies a more ‘forward looking’ investor than is currently assumed for the GREEN model.

Table 5 Summary Characteristics of GREEN

Model Characteristics	GREEN
Top-down versus bottom-up	Top-down with some bottom-up details in backstop technologies specifications.
Dynamic	Recursive
Inter-fuel substitution	Yes
Fuel-factor Substitution	Yes
Capital – Energy complementarity/substitutability	Given the vintage structure of production, capital and energy tend to be compliments in the short term and substitution over the longer term.

2.4 The Babiker-Maskus-Rutherford (BMR) Model

Babiker, Maskus, and Rutherford (1997) utilize a model for studying the economic impact of international trade and environmental policies on the world economy. The model includes a detailed structure of the inter-fuel and energy-factor substitution possibilities for the firm and for the household sector (see Figures 12 and 13).

The structure of production in the BMR model groups labor and capital together. This means that one cannot give to the energy-capital components a different elasticity of substitution as compared to the energy-labor or capital-labor components, and this is a severe restriction. On the other hand, the internal structure of the inter-fuel substitution in the BMR model does contain a rich structure, firstly with a distinction between electricity and non-electricity inputs, and then further disaggregation of the non-electric inputs into various types of fuels using a nested-CES structure (see Figure 12) with 5 levels: oil and natural gas at level 0 (bottom level); coal at level 1; electricity, land, labor, and capital are at level 2; aggregate energy and aggregate primary factor is at level 3; intermediate input and the combined energy-primary factor is at level 4; and finally output is at level 5.

To calculate the elasticity of substitution between any two inputs n and m at a particular level L in the nested-CES structure, we can refer to the formula derived by Keller (1980, p. 83):

$$\sigma_{nm} = \sigma_{n,K} S_{n,K}^{-1} - \sum_{l=K+1}^L \sigma_{n,l} [S_{n,l-1}^{-1} - S_{n,l}^{-1}]$$

where K represents the lowest level in the nested-CES structure at which a component exists, associated with both the n and the m inputs (the lowest common level) and L is the highest level in the nested structure at which the elasticity σ_{nm} is calculated, and the cost share $S_{n,l}$ is defined by:

$$S_{n,l} = \sum_{i \in n} S_i$$

i.e. the sum of all the cost shares associated with the aggregate input n at level l , or, in other words, the cost share of the input component n .

Using this formula, and considering the production structure of Figure 12, we can conclude that:

- (1) energy-capital¹¹ substitution elasticity σ_{EK} (considered at the top level, i.e. holding output constant, $L=5$) is simply equal to $0.5/S_{EF}$ where S_{EF} is the cost share of aggregate energy-primary factors (land, labor, capital) in the production structure. Since this value is less than 1.0, σ_{EK} is greater than 0.5 - the CES substitution elasticity at level $K=4$.
- (2) For inter-fuel substitution, electricity and non-electricity have an elasticity of substitution of:

$$1/S_E - 0.5*[1/S_E - 1/S_{EF}] = 0.5/S_{EF} + 0.5/S_E$$

where S_E is the cost share of aggregate energy in the production structure. Since S_E is rather small, the elasticity of substitution between electricity and non-electricity can therefore be very large. For example, with $S_E = 0.05$, $S_{EF} = 0.70$, the overall, output- constant, elasticity of substitution between electricity and non-electricity is 10.71.

- (3) The elasticity of substitution between oil and gas is given by:

$$1/S_{OG} - 0.5*[1/S_{OG} - 1/S_{COG}] - 1*[1/S_{COG} - 1/S_E] - 0.5 [1/S_E - 1/S_{EF}] =$$

$$0.5/S_{OG} - 0.5*/S_{COG} + [0.5/S_{EF} + 0.5/S_E]$$

where S_{OG} or S_{COG} is the cost share of inputs (*oil, gas*) or inputs (*coal, oil, gas*) in the total production structure. Again, assuming that $S_{OG} = 0.010$ and $S_{COG} = 0.015$, the overall elasticity of substitution between *oil* and *gas* is then $22 + 10.71 = 32.71$. This is a very large figure.

The large magnitude of these output-constant (upper level) elasticities of substitution as compared to the composite input-constant (lower-level) elasticities of substitution can be explained as follows. When a composite input (such as aggregate energy E) is held constant, there is only a limited opportunity for the various components (fuels) of this composite energy to be substituted for one another. When the level of output is held constant, however, there are also substitutions between different types of aggregate inputs (e.g. aggregate energy E for capital K , or composite K - E for labor L , etc). This increases the range of substitution (or complementarity) between the lower-level inputs (fuels). Refer to Figure 11, for example, where it is assumed for simplicity that aggregate energy consists of only oil and gas. When the level of aggregate energy is held constant, an increase in the price of oil (relative to gas) will induce a substitution of gas for oil (movement from A to B). When the level of output is held constant, aggregate energy consumption may fall because aggregate energy price has increased relative to other factors: B may now move towards C. The total movement is now from A to C, which shows a larger reduction in oil consumption following an oil price increase, and therefore, it seems as though the degree of 'substitutability' between oil and gas is now much larger. Furthermore, as we go up the production structure, the share of the energy inputs will get smaller, and since the elasticity of

¹¹ Or energy-labor, or energy-land: since labor, land, and capital are grouped together, their substitution elasticity with respect to energy will be the same for all three primary factors.

substitution is price elasticity 'normalized' by the cost share, it will get even larger as the cost share gets smaller.

The purpose of these upper- or outer-level elasticity calculations is to show that the overall level of substitution between any two input components within a particular nest may be much larger than the magnitude of the substitution elasticities. This point is important to keep in mind when we compare different models which may have similar elasticities, but different nested structures.

Figure 11 Substitution Elasticity when Total Output is Held Constant.

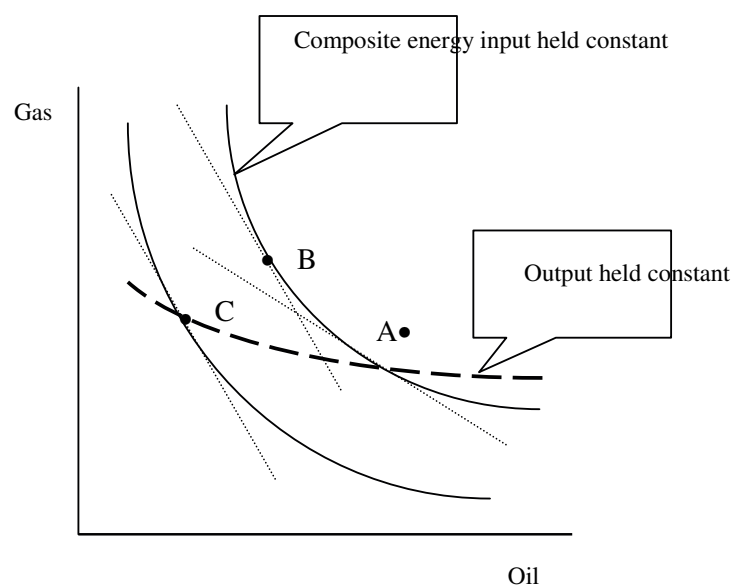

Figure 12 Structure of Production in the Babiker-Maskus-Rutherford (1997) Model

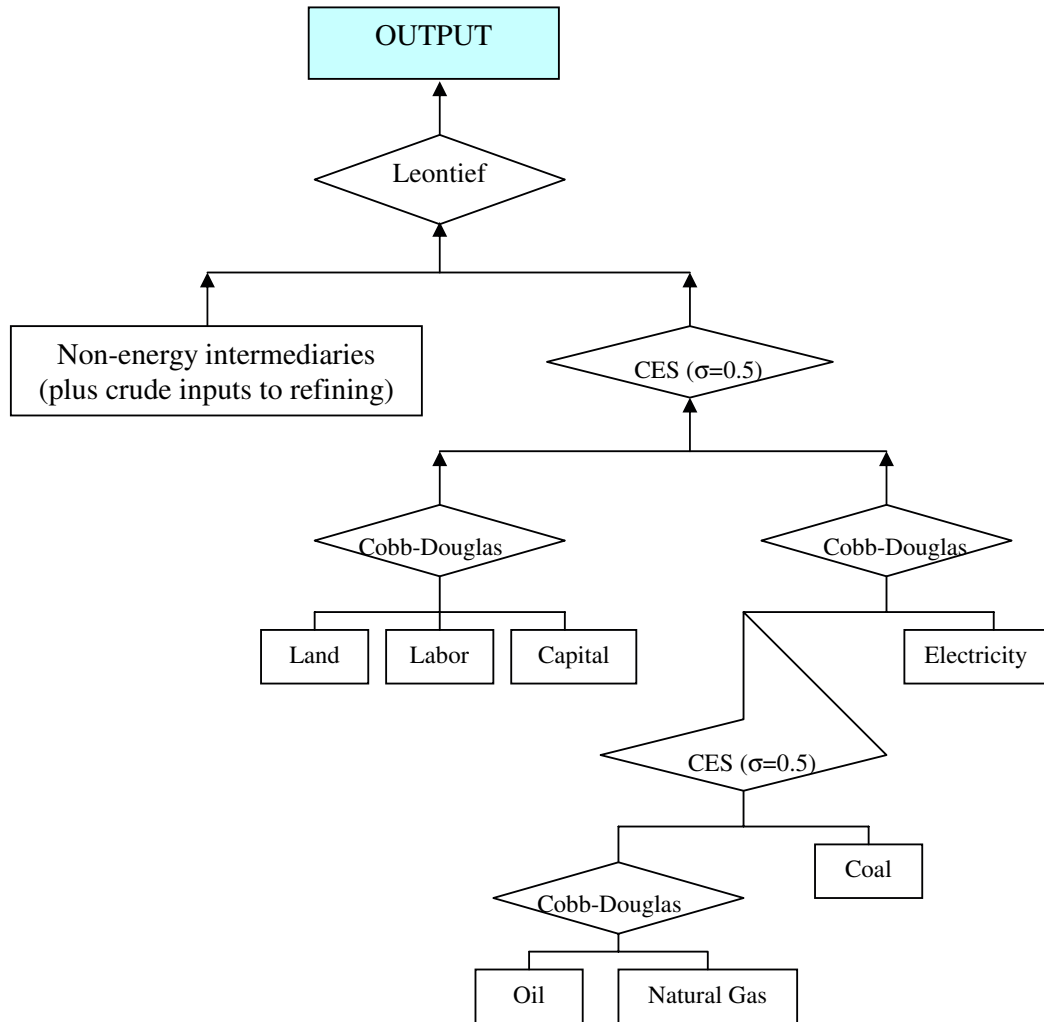

Table 6 Summary Characteristics of the BMR Model

Model Characteristics	BMR Model
Top-down versus bottom-up	Top-Down
Dynamic	Recursive
Inter-fuel substitution	Yes
Fuel-factor Substitution	Yes
Capital – Energy complementarity/substitutability	Energy is rather a compliment to capital (as is land and labor).

2.5 Borges and Goulder (1984) Model

Borges and Goulder (1984, p. 340) assume a much simpler structure for the inter-fuel and fuel-factor substitution possibilities. However, the model allows for labor to be separated from capital, and energy and capital are to be grouped together in one nest. This is consistent with the approach taken in the GREEN model. To allow for the possibility of significant complementarity between K and E, Borges and Goulder assumed a fixed-coefficient structure for the KE composite. Using the Keller formula as described in the previous section, the substitution elasticity between energy and capital at the top level would then be given by $\sigma_{EK} = -1*[1/S_{EK} - 1]$, where S_{EK} is the cost share of capital and energy inputs. Since $S_{EK} < 1$, then $\sigma_{EK} < 0$, i.e. capital and energy are significant complements at the top level of the production structure. On

Figure 13 Structure of Final Demand in the Babiker-Maskus-Rutherford (1997) Model

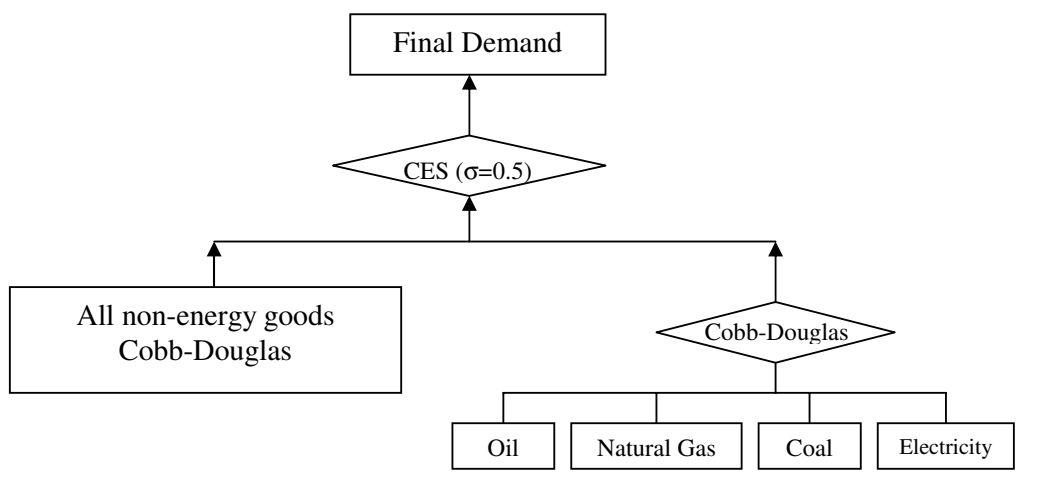
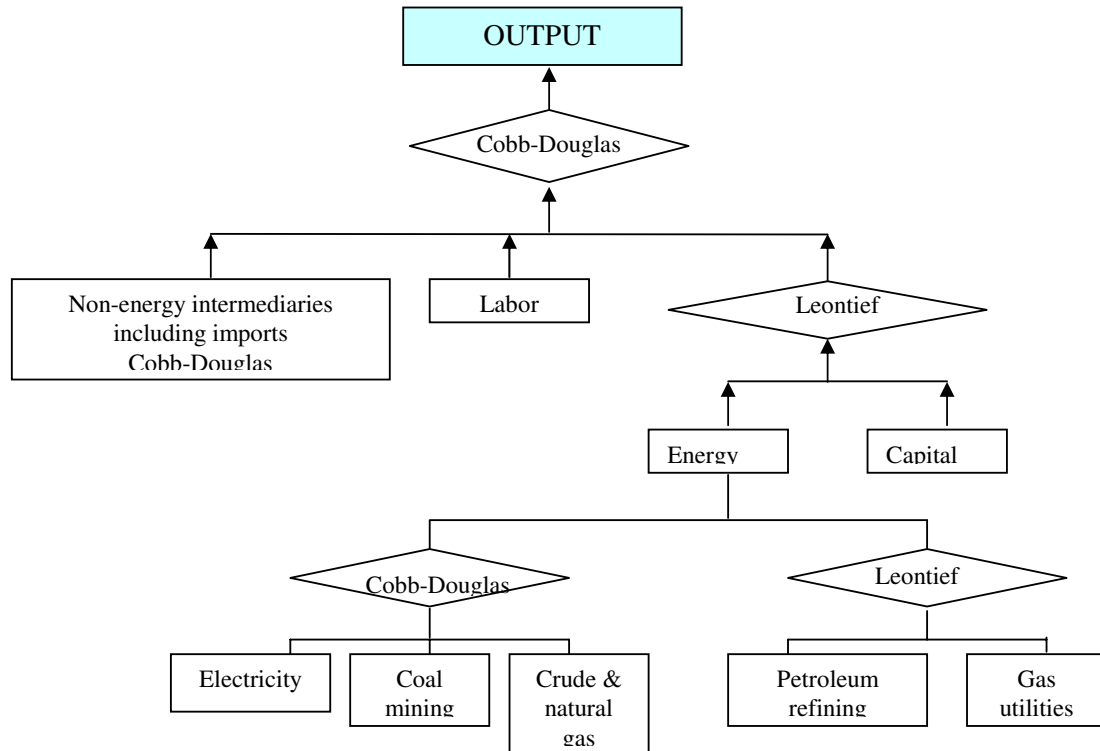

Figure 14 Structure of Production in Borges and Goulder (1984) Model



the issue of inter-fuel substitution, Borges and Goulder assume a Cobb-Douglas structure, but recognize that perhaps with the petroleum product and gas sectors, a fixed coefficient technology would be more appropriate (see Figure 14).

On the household consumption side, the utility structure allows for substitution between ‘current consumption and future consumption’, as well as between ‘goods and services’ and leisure. The goods and services sector is Cobb-Douglas with three different types of energy commodities: electricity, gas and ‘gasoline and other fuels’.

Table 7 Summary Characteristics of the Borges and Goulder Model

Model Characteristics	Borges and Goulder Model
Top-down versus bottom-up	Top-Down
Dynamic	Simultaneous
Inter-fuel substitution	Yes
Fuel-factor Substitution	Yes
Capital – Energy complementarity/substitutability	Strict complementarity between capital and energy.

3. Towards a GTAP Model with Energy Substitution

In this section we discuss the issue of how to incorporate the important features of energy substitution as reviewed in the previous section into the GTAP model. Currently, in the standard GTAP model¹², there is no inter-fuel, nor fuel-factor (energy - primary factor) substitution, even though recent version of the model allows for a non-zero constant elasticity of substitution between *all* intermediate inputs. This latter feature is an improvement over previous versions. However, it still does not go far enough to allow for an adequate treatment of the issue of energy substitution, hence a more substantial approach needs to be taken here.

There are two important issues which must be addressed when considering extending the GTAP model to include energy substitution in its structure. The first relates to the question of a choice between a ‘top-down’ versus a ‘bottom-up’ approach. The second relates to the question about complementarity / substitutability between energy and capital inputs over time.

3.1 Top-Down Versus Bottom-Up Approach

In selecting an approach for incorporating energy-substitution into the GTAP model, there are generally two different approaches¹³. The ‘bottom-up’ (engineering) approach often starts with a detailed treatment of the energy-producing processes or technologies, and then asks the questions: *given* a particular level of demand for energy *services* (which may be defined in terms of the level of outputs of certain activities, such as travel, heating, air conditioning, lighting, or even steel making, etc.), what is the most efficient way of going about meeting these demands in terms of the energy technologies employed and the level of inputs. The top-down (economic) approach, on the other hand, starts with a detailed description of the macro (and international) economy and then derives from there the demand for energy inputs in terms of the demand for various sectors’ outputs through highly aggregate production or cost functions.

The advantage of a bottom-up approach is in the detailed specification of the energy technologies, through which newly developed or future technologies can be incorporated into the

¹² As documented in Hertel, T.W. and M.E. Tsigas "Structure of GTAP", Chapter 2 in Hertel (1997).

¹³ See, for example, Wilson and Swisher (1993).

analysis. This provides it with much more realism than in the econometrically-specified ‘production function’ of the top-down approach. On the other hand, the latter can claim advantage in the fact that there is historical evidence in support of the assumed *behavioral* response implied in the production function specification, whereas the bottom-up technology specifications may lack this behavioral content¹⁴. To utilize the advantages of both approaches, a top-down (macro-econometric or computable general equilibrium) model can be ‘linked’ to a bottom-up process model and the two models are solved simultaneously. However, there are many theoretical and computational difficulties associated with such a linkage. As a result, in some cases, a ‘partial link’ is pursued (such as the ETA-MACRO link in the CETM model discussed in section 2) or a ‘simulated’ approach to a process model is used (such as the specification of the energy-sector production possibilities in terms of ‘technology bundles’ in the MEGABARE model, see also section 2). While there are certain advantages associated with these ‘partial’ approaches, the price to pay for such an approach is in the added complexity in model specification, and also the additional data and parameter requirements. For example, in the MEGABARE model, there is the question of what parameters are to be used for the substitution between the ‘technology bundles’ to ensure some consistency with observed behavior based on historical data. As a result of these difficulties, and the desire to offer a widely-accessible energy model, these approaches are not pursued here. Instead, it is suggested that a simple ‘top-down’ approach be used, which can incorporate most of the important features of the existing top-down models in this area, such as the GREEN or BMR models.

3.2 The Issue of Energy-Capital Substitutability or Complementarity

Having settled on a top-down approach to represent energy-substitution, the next question to consider is: which particular structure should be used to represent the substitution possibilities between alternative fuels (inter-fuel substitution) and between the energy aggregate as a whole and other primary factors, such as labor and capital (fuel-factor substitution). In particular, the question of energy-capital complementarity or substitutability is a major issue in this literature. In this section, we look at this issue from a theoretical viewpoint and then go on to review some of the empirical estimates of the parameters for energy and capital substitution /complementarity in the literature.

3.2.1 Importance of the Issue

According to Vinals (1984), the issue of energy-capital complementarity or substitutability may turn out to be a crucial one in determining the direction of the adjustment of aggregate output following energy price changes:

‘...the key parameter that determines whether output produced goes up or down after an energy price increase is the degree of complementarity/substitutability between energy and capital, measured by σ_{EK} [the substitution elasticity between energy and capital]’ (Vinals, 1984: 237-238).

¹⁴ As a result, there would be some difficulties in guessing what would be the future rates of penetration of new technologies into the market.

In Vinals' simple one-sector model with no distortions, when the capital stock is given, and the wage level is flexible, energy-capital substitutability 'is a sufficient condition for output produced to decline following an energy price increase. Alternatively, energy-capital complementarity is a necessary condition for output produced to rise following an energy price increase'. These results point out '*how crucial it is for macroeconomic analysis to determine whether energy and capital are complements or substitutes*' (Vinals, 1984, p 238, italics original)

3.2.2 Empirical Estimates of σ_{EK}

Despite the theoretical importance of the σ_{EK} parameter, *empirical* estimates of this parameter must overcome many difficulties. Table 4 gives some indicative values of σ_{EK} as estimated from various empirical studies. It can be seen from this Table that both the sign and magnitude of this parameter varies significantly between different studies.

The problem arises partly because energy-capital substitutability is a long-term adjustment process, and therefore, empirical estimates of σ_{EK} must take into account the issue of how short-term energy usage can be dynamically adjusted to a 'theoretically optimal' level in the long run, based on the level of investment. Conversely, capital must also adjust to the expected level of energy prices in the long term. Hogan (1989) has shown that where a 'correct' specification of a dynamic capital-energy usage structure is specified, more meaningful and accurate estimates of the inter-fuel and energy-primary factor substitution elasticities can be achieved. The key to the problem of specification is that a model must be able to represent the flexibility (in energy usage) in the long run but also allow for rigidity or inflexibility in the short to medium term due to capital constraint:

....responses to price changes take time. Although there is overwhelming evidence of great flexibility in the use of energy and other inputs, the most important changes in energy utilization depend upon changes in energy-using equipment. If this equipment changes slowly, then the full response to energy price changes will take many years to unfold... Initially, the price shocks have little effect on demand per unit of output; often the effects are so small as to suggest little response at all. But the new prices unleash forces that eventually produce dramatic changes in total energy demand...this demand response can be both a substantial break from trend and a confusing mixture of fuel substitutions. Analysis of this short-run record, in the search for insights into long-run possibilities, places great emphasis on the need for a description of the dynamics of energy demand adjustment¹⁵.

Inflexibility in capital adjustment comes from technological factors (such as discrete or lumpy investments), as well as adjustment costs. To describe this 'inflexibility', one approach is to use a technology or *process* model. Alternatively, the long-term adjustment process of capital can also be specified directly in an economic model (such as in GREEN). However, it is not always easy to find empirical estimates for the parameters of these models, hence the uncertainty surrounding the extent of energy-capital substitutability or complementarity.

¹⁵ Hogan (1989, p. 54)

Table 8 Estimates of the Partial Hicks-Allen Elasticities of Substitution (σ) and Factor Shares (σ).

	US Berndt-Wood (1975)	US Kulatilaka (1980)	US Pindyck (1979)	Europe Pyndyck (1979)	Australia Truong (1985)
σ_{KK}	-8.8	-2.75	-1.66	-0.98	-16.46
σ_{LL}	-1.5	-0.22	-1.19	-0.82	-1.388
σ_{EE}	-10.7	-2.70	-24.21	-13.16	-19.60
σ_{MM}	-0.39				-0.222
σ_{KL}	1.01	0.69	1.41	0.69	1.02
σ_{KE}	-3.5	-1.09	1.77	0.60	-2.95
σ_{LE}	0.68	0.61	0.05	1.13	1.77
σ_{KM}	0.49				0.78
σ_{LM}	0.61				0.42
σ_{EM}	0.75				0.17
σ_L	0.289	0.76	0.478	0.526	0.263
σ_E	0.044	0.10	0.032	0.055	0.023
σ_K	0.046	0.14	0.488	0.409	0.044
σ_M	0.619				0.67

K = Capital, L= Labor, E = Energy, M= Material.

Source: Vinals (1984), Table 3, p. 242, and Truong (1985).

3.3 The Structure of Inter-fuel and Fuel-factor Substitution in GTAP-E

3.3.1 Production Structure with Energy Substitution

Based on the various structures of inter-fuel and fuel-factor substitutions adopted in other models as described in section 2, the following is suggested as a good option for GTAP-E.

On the production side, energy¹⁶ must be taken out of the intermediate input 'nest' to be incorporated into the 'value-added' nest (see Figures 15 and 16). The incorporation of energy into the value-added nest is in two steps. First, following the structure in the CETM model as well as the Babiker-Maskus-Rutherford (1997) model, energy commodities are first separated into 'electricity' and 'non-electricity' groups. Some degree of substitution is allowed within the non-electricity group (σ_{NELY}) as well as between the electricity and the non-electricity groups (σ_{ENER}). The values of these substitution elasticities are shown in Table 5. These are chosen to be in the middle range of the values adopted in other models.

¹⁶ Primary energy (such as coal, gas, crude oil) can be used, not only as a source of energy input for various industrial and household activities (e.g. natural gas to provide the energy source for electricity production, coal as energy source for steel making), they can also be used as a 'feedstock'. In this latter use, the chemical content of the energy input (such as natural gas) is simply 'transformed' to become part of the output commodity (such as fertilizer) rather than being 'used up' as an energy source. Similar examples are crude oil used as feedstock in the petroleum refinery industry, coke used as a feedstock in steel production, etc.

Next, the energy composite is then combined with capital to produce an energy-capital composite¹⁷, which is in turn combined with other primary factors in a value-added-energy (VAE)¹⁸ nest through a CES structure (See Figure 17). The substitution elasticity between capital and the energy composite (σ_{KE}) is still assumed to be positive (indicating energy and capital are substitutes in the ‘inner nest’). However, provided the value of σ_{KE} is set at a level lower than σ_{VAE} , the overall substitution elasticity (as viewed from the ‘outer nest’) between capital and energy may still be negative (Borge and Goulder (1984, p. 340)). To be more precise, we can use the formula derived by Keller (1980, p. 83) which specifies the relationship between the ‘inner’ and ‘outer’ elasticity of substitution between K and E as follows:

$$\sigma_{KE-outer} = [\sigma_{KE-inner} - \sigma_{VAE}] / S_{KE} + \sigma_{VAE} / S_{VAE}$$

where S_{KE} is the cost share of the KE -composite in the outer (value-added) nest, and $\sigma_{KE-inner}$ and $\sigma_{KE-outer}$ indicate the inner and outer substitution elasticities between K and E respectively.

Figure 15 Standard GTAP Production Structure

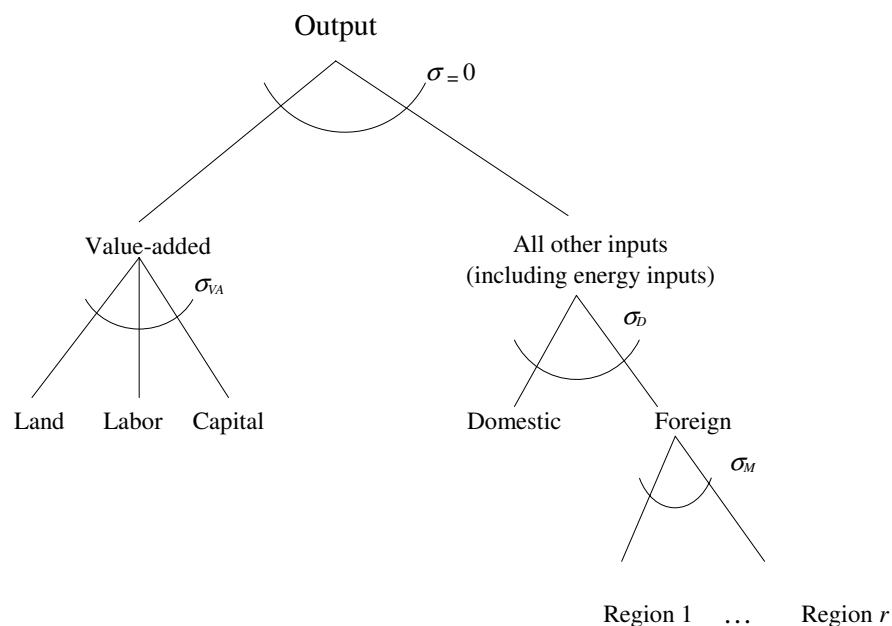

¹⁷ The reason for a focus on the energy-capital composite was given in section 3.2. See also the discussion in section 2.3.3 regarding the differences between energy-capital and energy-labor substitution.

¹⁸ The term ‘value-added-energy’ is used to emphasize the fact that energy is now present in this nest.

²¹ For details on the industry sector aggregation, see Table A1 of the Appendix.

Figure 16 GTAP-E Production Structure

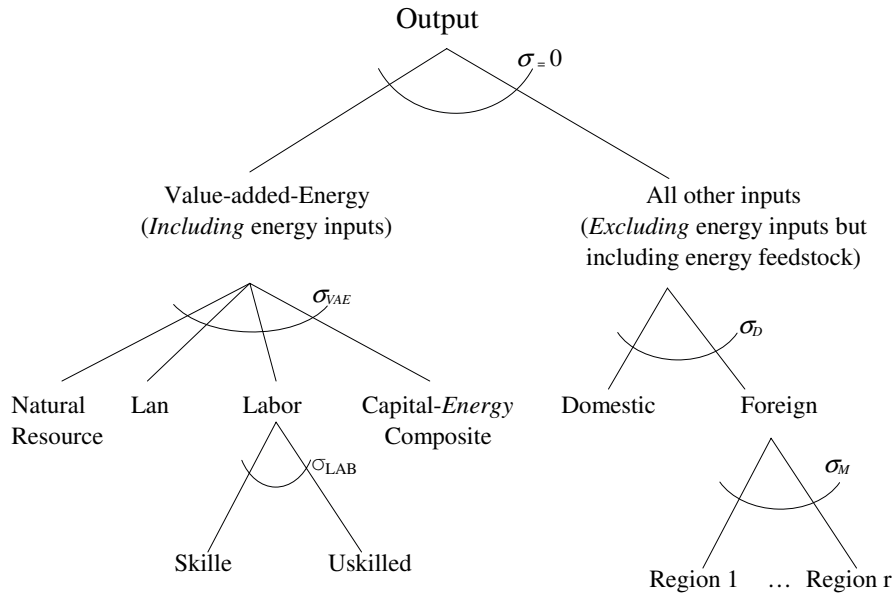

Figure 17 GTAP-E Capital-Energy Composite Structure

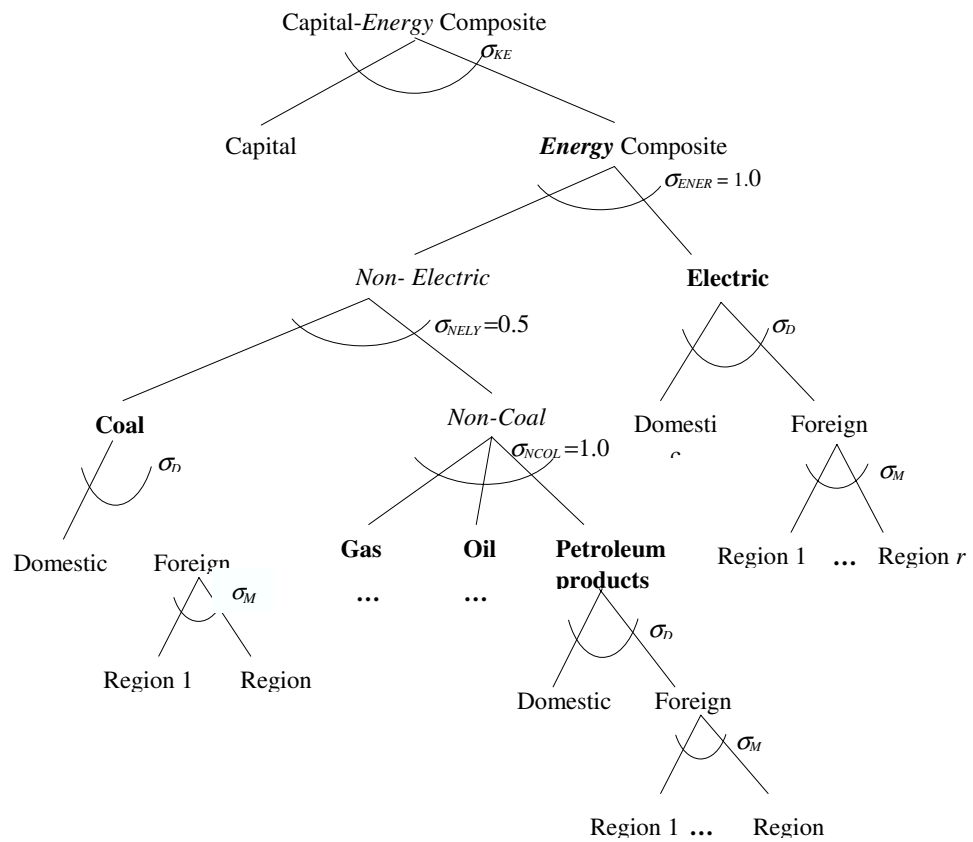

Table 9 Energy Substitution Elasticities in GTAP-E and Other Models

SECTOR	Capital-Energy ($K-E$)					Inter-Fuel		
	GTAP-E (a)	GREEN (b)	Rutherford (c)	GTAP-E (e)				
				Electric vs Non-electric	Coal vs other non-electric	between non-coal, non-electric	GREEN	
Coal	0.0	0.0	0.0	0.0	0.0	0.0	0.0	0.0
Crude Oil	0.0	0.0	0.0	0.0	0.0	0.0	0.0	0.0
Gas	0.0	0.0	0.0	0.0	0.0	0.0	0.0	0.0
Petroleum, coal products	0.0	0.0	0.0	0.0	0.0	0.0	0.0	0.0
Electricity	0.5	0.0 - 0.8	-(d)-	1.0	0.5	1.0	1.0	0.25 - 2.0
Ferrous metals	0.5	0.0 - 0.8	0.5	1.0	0.5	1.0	1.0	0.25 - 2.0
Chemical, rubber, plastic products	0.5	0.0 - 0.8	0.5	1.0	0.5	1.0	1.0	0.25 - 2.0
Other manufacturing; trade, transport	0.5	0.0 - 0.8	0.5	1.0	0.5	1.0	1.0	0.25 - 2.0
Agriculture, forestry, and fishery	0.0	0.0 - 0.8	0.5	1.0	0.5	1.0	1.0	0.25 - 2.0
Commercial/public services, dwellings	0.5	0.0 - 0.8	0.5	1.0	0.5	1.0	1.0	0.25 - 2.0

For details on the sector aggregation, see Table A1 of the Appendix.

^aTo ensure capital and energy are complements in the short run, while substitutes in the long run, the elasticity of substitution between K and E aggregate must be set lower than the elasticity between K and other primary factors (σ_{VAE}).

^bIn the GREEN model, if the long-term elasticity between K and E is equal to 2.0 and the short run value set equal to 0.25, then the 'intermediate' term (approximately 5 years) elasticity - which depends on the vintage structure of the capital - will be about 0.8 (see Figure 5, Burniaux *et al.* (1992), p. 66).

^cIn Rutherford models, a value of 0.5 is set for substitution between energy composite and land-labor-capital composite in the non energy-producing industries (Babiker *et al.* (1997)), or between energy composite and labor-capital composite (Rutherford *et al.* (1997), and Bohringer and Pahlke (1997)).

^d $K-E$ substitution for the electricity industry is determined, not by an econometric parameter, but by the specification of alternative electricity-generation technologies in the 'process model'.

^eThis is based on the values of 1.0 chosen for the substitution between electric and non-electric, and between non-coal fossil fuels in (Babiker *et al.* (1997)), Rutherford *et al.* (1997), Bohringer and Pahlke (1997) however, chose a value of 2.0 for the substitution between non-coal fossil fuels. For substitution between coal and non-coal fossil fuels, Babiker *et al.* (1997) chose a value of 0.5, whereas Bohringer and Pahlke (1997) chose a value of 0.25 if the non-coal aggregate includes electricity.

In GTAP-E, the (inner) value of σ_{KE} is assumed to be 0.5 for most industries²¹ (including electricity), and is set equal to 0.0 for coal, oil, gas, petroleum and coal products, and agriculture/forestry/fishery. This is based on the (low-to-middle) range of the values adopted by other models, such as the GREEN model, and the models used by Babiker *et al.* (1997), Rutherford *et al.* (1997), Bohringer and Pahlke (1997) (see Table 5). The value of σ_{VAE} ranges from 0.2 to 1.45 and this seems to be slightly larger than the values adopted by other models (see Table 6), but these are the values currently used in the standard GTAP model.

Based on the values of S_{KE} for some typical regions in the GTAP- 4E data base²², the ‘outer’ values of σ_{KE} are derived using the above formula and are shown in Table 7. From this Table, it can be seen that most industries (with the exception of ‘electricity’ in the USA, and ‘electricity’, ‘ferrous metals’, and ‘chemical, rubber, plastic products’ in Japan) are characterized as having an overall complementarity relationship between energy and capital despite the fact that σ_{KE} is still specified as non-negative within the energy-capital nest.

Table 10 Elasticities of Substitution Between Different Factors of Production

Sector	GTAP-E ^a	GREEN		Rutherford ^d
	(\square_{VAE})	$L - KEF^b$	$E - KF^c$	
Coal	0.2	0.0	0.0	1.0
Crude Oil	0.2	0.0	0.0	1.0
Gas	0.84	0.0	0.0	1.0
Petroleum, coal products	1.26	0.0	0.0	1.0
Electricity	1.26	0.0	0.0 - 0.8	1.0
Ferrous metals	1.26	0.12 - 1.0	0.0 - 0.8	1.0
Chemical, rubber, plastic products	1.26	0.12 - 1.0	0.0 - 0.8	1.0
Other manufacturing; trade, transport	1.45	0.12 - 1.0	0.0 - 0.8	1.0
Agriculture, forestry, and fishery	0.23	0.12 - 1.0	0.0 - 0.8	1.0
Commercial/public services, dwellings	1.28	0.12 - 1.0	0.0 - 0.8	1.0

^a In GTAP-E: between land, natural resources, aggregate labor, and capital-energy composite.

^b Between labor (L), and energy-capital-fixed factor composite (EKF).

^c Between energy (E) and capital-fixed factor composite (KF).

^d Between land, labor, and capital (see Babiker *et al.* (1997)), or between labor and capital (Rutherford *et al.* (1997), and Bohringer and Pahlke (1997)).

²² See Malcolm and Truong (1999).

Table 11 The Relationship Between Inner ($\sigma_{KE-inner}$) and Outer ($\sigma_{KE-outer}$) Elasticities of Substitution for the Cases of Japan and the US

Sector	Japan				USA			
	$\sigma_{KE-inner}$	σ_{VAE}	S_{VAE}	S_{KE}	$\sigma_{KE-outer}$	S_{VAE}	S_{KE}	$\sigma_{KE-outer}$
Coal	0.0	0.2	0.49	0.11	-1.50	0.67	0.16	-0.97
Crude Oil	0.0	0.2	0.64	0.24	-0.52	0.69	0.34	-0.30
Gas	0.0	0.84	0.97	0.95	-0.02	0.81	0.55	-0.49
Petroleum, coal products	0.0	1.26	0.68	0.59	-0.28	0.91	0.88	-0.04
Electricity	0.5	1.26	0.83	0.71	0.45	0.84	0.71	0.43
Ferrous metals	0.5	1.26	0.51	0.34	0.27	0.43	0.18	-1.35
Chemical, rubber, plastic products	0.5	1.26	0.42	0.26	0.05	0.50	0.30	-0.05
Other manufacturing; trade, transport	0.5	1.45	0.46	0.16	-2.65	0.51	0.18	-2.45
Agriculture, forestry, and fishery	0.0	0.23	0.58	0.20	-0.77	0.46	0.26	-0.38
Commercial/public services, dwellings	0.5	1.28	0.62	0.30	-0.58	0.63	0.23	-1.41

Note: $\sigma_{KE-outer} = [\sigma_{KE-inner} - \sigma_{VAE}] / S_{KE} + \sigma_{VAE} / S_{VAE}$, where S_{KE} , $\sigma_{KE-inner}$ are the cost share and substitution elasticity respectively for the capital-energy composite and S_{VAE} , σ_{VAE} are the cost share and substitution elasticity respectively for the value-added-energy composite.

Finally, Tables 8 and 9 show the Armington elasticities for the substitution between domestic and imported good (σ_D), and between imported goods from different regions (σ_M). The values of σ_D and σ_M for GTAP-E are taken from the ‘standard’ GTAP model, and are seen to be lower than some of the values used in other models, such as those in Babiker *et al.* (1997). In studies which seek to simulate the trade effect of a ‘homogeneous energy commodity market’ (such as that for coal) in response to an energy-environmental shock (such as the imposition of a carbon tax), these Armington elasticities may play a crucial role. However, this issue is not considered in this paper.

Table 12 Elasticities of Substitution Between Domestic and Foreign Sources (σ_D)

Sector	GTAP-E	GREEN ^b	Rutherford ^c Low-High
Coal	2.80	4.0	2.0
Crude Oil	10.0 ^a	∞	∞
Gas	2.80	4.0	2.0
Petroleum, coal products	1.90	4.0	2.0
Electricity	2.80	0.3	2.0
Ferrous metals	2.80	2.0	4.0 – 8.0
Chemical, rubber, plastic products	1.90	2.0	4.0 – 8.0
Other manufacturing; trade, transport	2.59	2.0	4.0 – 8.0
Agriculture, forestry, and fishery	2.47	3.0	4.0 – 8.0
Commercial/public services, dwellings	1.91	2.0	4.0 – 8.0

^aThis is higher than the standard value of 2.8 used in most GTAP applications.

^bBurniaux *et al.* (1992), p. 76.

^cBabiker *et al.* (1997),

Table 13 Elasticities of Substitution Between Different Regions (σ_M)

Sector	GTAP-E	GREEN ^b	Rutherford ^c Low-High
Coal	5.60	5.0	4.0
Crude Oil	20.0 ^a	∞	∞
Gas	5.60	5.0	4.0
Petroleum, coal products	3.80	3.0	4.0
Electricity	5.60	0.5	4.0
Ferrous metals	5.60	3.0	8.0 - 16.0
Chemical, rubber, plastic products	3.80	3.0	8.0 - 16.0
Other manufacturing; trade, transport	6.04	3.0	8.0 - 16.0
Agriculture, forestry, and fishery	4.62	4.0	8.0 - 16.0
Commercial/public services, dwellings	3.80	3.0	8.0 - 16.0

^a This is higher than the standard value of 5.6 used in most GTAP applications.

^b Burniaux *et al.* (1992), p. 76.

^c Babiker *et al.* (1997).

3.3.2 Consumption Structure

On the consumption side, the existing structure of GTAP assumes a separation of ‘private’ consumption from ‘government’ consumption (consumption by households of publicly provided goods) and private savings. Government consumption expenditure is then assumed to be Cobb-Douglas with respect to all commodities ($\sigma_G = 1$). In the GTAP-E model, energy commodities are separated from the non-energy commodities with a nested-CES structure as shown in Figure 18. If, however, the substitution elasticity σ_{GEN} given to the inner energy nest and σ_{GENNE} given to the outer nest are both equal to 1 (substitution elasticity σ_{GNE} in the non-energy nest is assumed to be equal to σ_G and is therefore also equal to 1), then the GTAP-E structure is equivalent to the original GTAP structure. In general, however, if $\sigma_{GEN} \neq \sigma_{GENNE} \neq 1$, then the GTAP-E structure allows for different substitution elasticities within the energy and non-energy sub-groups, as well as between the two groups. For the current version of GTAP-E, the following values are adopted: $\sigma_{GEN} = 1$, and $\sigma_{GENNE} = 0.5$. This structure is very similar to the structure of household demand given in Rutherford *et al.* (1997) (see Figure 3), and Bohringer and Pahlke (1997), except that in the model of Bohringer and Pahlke, a smaller value of 0.3 is used for substitution between energy and non-energy aggregates, and a higher value of 2 is used for substitution between fossil fuels (excluding coal).

Figure 18 GTAP-E Government Purchases

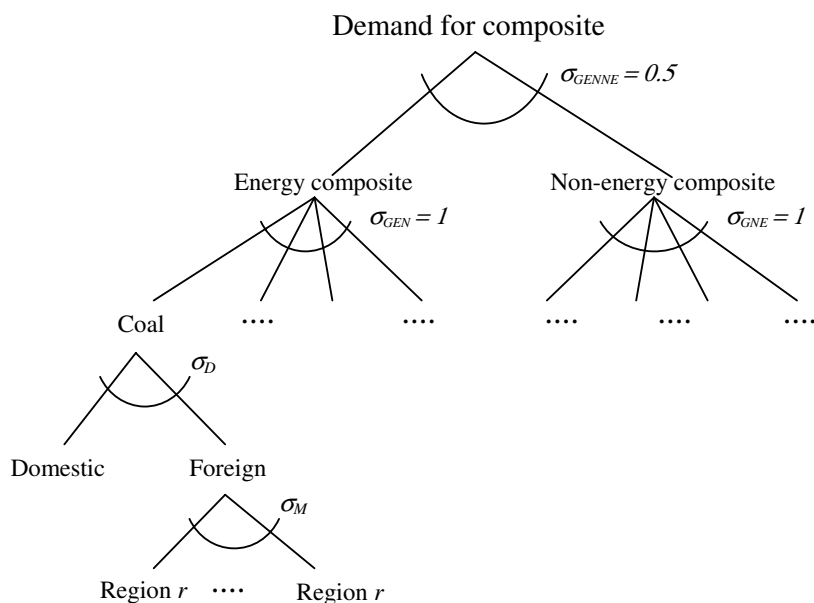

Household ‘private’ consumption (i.e. consumption of private goods) is assumed to be structured according to the constant-difference of elasticities (CDE) functional form in the existing GTAP model. If the energy commodities within the CDE structure have the same income and substitution parameters, then according to the theory of the CDE structure, these commodities can be aggregated into a single composite with the same parameters as that of the individual components. Currently, in fact, within the GTAP model, four of the five energy commodities (coal, oil, gas, and electricity) have similar parameters, which differ only from that of the ‘petroleum and coal products’. This implies we can aggregate the energy commodities into a composite which remains in the CDE structure and has the same (or the average of the) CDE parameter values characterizing the individual energy commodities. To allow for flexible substitution between the individual energy commodities, the energy composite is now specified as a CES sub-structure, with a substitution elasticity of $\sigma_{PEN} = 1$ (see Figure 19) which is similar to the value given to σ_{GEN} (see Figure 18). This is the same as the value adopted in Rutherford *et al.* (1997) (see Figure 3) and consistent with the medium term value adopted in the GREEN model (see section 2.3.2).

Figure 19 GTAP-E Household Private Purchases

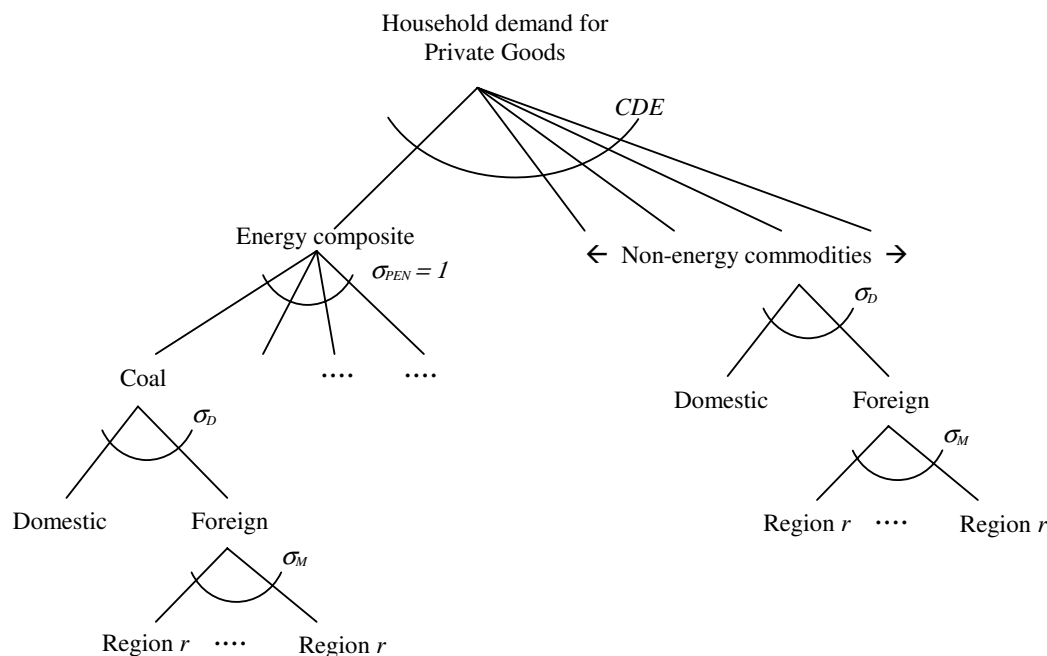

To better characterize the behavior of GTAP-E in comparison with GTAP, it is worth calculating the overall general equilibrium elasticities in both models (see Annex 1). GE elasticities depend on the structure of the model, the value of the substitution parameters and the particular closure assumed. They also depend on the benchmark database. The elasticities in Annex 1 have been calculated by using the version 4 of the GTAP data base. Thus the elasticities reported in Annex 1 are primarily to illustrate the behavioral implications of introducing inter-fuel substitution. Since these elasticities are also dependent on the base data, they are different in the current version of the model that is based on the version 5 of the GTAP data base.

4. Illustrative Scenario

GTAP-E has been specifically designed to simulate policies in the context of Greenhouse Gas (GHG) mitigation. This is best illustrated by using GTAP-E (based on GTAP Version 5 Data Base) to simulate the Kyoto Protocol. By signing this Protocol in 1997, a number of industrialized countries – referred to hereafter as Annex 1 countries – committed themselves to reduce their GHGs emissions relative to their 1990 levels. Initially, the Protocol aimed at ambitious reductions: the total emissions of Annex 1 countries were planned to be brought down in 2012 by 5 per cent below their 1990 levels. The Protocol made provision for country specific targets. A number of so-called “flexibility mechanisms” were also provided in order to allow emission reductions to be reallocated among Annex 1 countries. The “Emission Trading” (ET)

mechanism and the “Joint Implementation” (JI) mechanism aimed at reallocating the burden of the emission reductions among Annex 1 countries. In contrast, the “Clean Development mechanism” (CDM) would allow Annex 1 countries to fund emission reductions in non-Annex 1 countries.

However, the initial impetus of the Protocol rapidly faded away. While subsequent COP (Conferences of Parties) meetings struggled with intricate methodological and implementation issues, emissions in most Annex 1 countries were growing well beyond the Kyoto targets. As time passed, the Kyoto objectives increasingly appeared out of range to some Annex 1 members - particularly the USA. In March 2001, the USA decided to withdraw from the Protocol. Though the remaining Annex 1 countries reiterated their commitment to implement the Protocol in Bonn, it is most likely that the US withdrawal will make the Protocol aggregate constraint nearly non-binding at the level of the remaining Annex 1 countries²³.

The scenarios discussed in this section are primarily illustrative. Specific limitations include, firstly that they refer to the initial version of the Protocol, including the US. Secondly, they only consider emissions of carbon dioxide while the Protocol covers a basket of GHGs and includes net emissions from land use changes. Thirdly, the use of the flexibility mechanisms is approximated by assuming unrestricted emission trading leading to complete equalization of the marginal of costs of abatement among participating countries, an outcome that is most unlikely given the real-world limitations associated with flexibility mechanisms. Finally, the Protocol is simulated in a static framework that leaves aside all aspects related to the timing of its implementation.

4.1 Alternative Implementations of the Kyoto Protocol

Three scenarios are considered. The first one is the “no trade” case. Here, Annex 1 countries meet their commitments individually without relying on the use of the flexibility mechanisms. The applied emission constraints correspond to the reductions that Annex 1 countries are forecast to achieve in 2012 – i.e. the first commitment period of the Protocol – relative to their corresponding emission levels in an unconstrained baseline scenario. Since this information requires using a dynamic model with an explicit time dimension, it is not readily available in GTAP-E. The emission constraints used here are taken from the OECD GREEN model (OECD, 1999, p. 29). In the second scenario, unrestricted emission trading among Annex 1 countries approximates the use of ET and JI mechanisms (“Annex 1 trade” case). The total emission constraint applied to Annex 1 countries in the second scenario is the same as in the first one, augmented by the amount of “hot air”²⁴ from the Former Soviet Union. The third scenario assumes that carbon emissions are traded worldwide without any restriction (“world trade” case). The constraint applied to world emissions is the sum of the Annex 1 commitments and of the benchmark emission levels for the non-Annex1 countries.

²³ This is because the emission surplus originating from the economic recession in the Former Soviet Union – often referred to as “hot air” – suffices to compensate the reductions to be achieved in the remaining Annex 1 countries.

²⁴ If Emission Trading is used, the emission surplus in the Former Soviet Union can be, in principle, transferred to other Annex 1 Parties at no cost. In this scenario, the amount of “hot air” in the Former Soviet Union is assumed equal to 100 million tons of carbon or 13 percent of the 1997 emission levels of the EEFSU region.

Table 10 reports the emission changes relative to the benchmark levels and the corresponding marginal abatement costs of meeting the emission limitations. In the no-trade case, emission reductions range from 20 to almost 40 percent. These relatively sharp reductions reflect the fast growth rates of emissions, as observed in many Annex 1 countries since 1990, the reference year of the Protocol. The GREEN model makes the assumptions that these rates will remain almost unchanged during the first decade of the 21st century. The marginal abatement costs corresponding to these reductions range from \$126 in the US to \$233 in Japan (where these are 1997 US dollars). These costs are in the range of estimates from other studies (see Weyant and Hill, 1999; OECD, 1999). Marginal costs are lower in the US than in other Annex 1 countries – despite the higher reduction rate – because the US uses relatively more coal and taxes energy less heavily. In more carbon-efficient countries, such as Japan, the marginal abatement costs rise faster, other things being equal.

The first column of Table 10 shows that while emissions are reduced in Annex 1 countries that are subject to binding constraints, they increase in the other countries, a phenomenon that used to be referred to as “carbon leakage”. The causes of carbon leakage are multiple and involve competitiveness effects as well as the reactions of the world energy markets²⁵. In this scenario, the leakage rate – defined as the additional emissions in countries with no binding constraint relative to the emission reductions in countries with binding constraints – amounts to 7 per cent including the EEFSU region and 4 percent, excluding EEFSU²⁶

Allowing unrestricted trade among Annex 1 countries shifts the burden of the reduction away from oil products in the relatively carbon-efficient economies (USA, EU, JPN, and RoA1) towards coal in the Former Soviet Union. This induces a substantial reduction of the marginal abatement costs: from around \$150 in the no-trade case to \$78 in the “Annex 1 trade” case). These cost savings imply that the EEFSU region sells about 300 million tons of carbon per year to other Annex 1 Parties, the largest single share of which is purchased by the USA (see Figure 20). This represents a transaction worth \$24 billion per year.

The right-hand section of Table 10 shows the results from a hypothetical worldwide emission trading system. In this case, the largest reduction takes place in the CHIND region (China and India) while the Annex 1 countries account for less than half of the world reduction. The world marginal abatement cost does not exceed \$30 per ton of carbon. At this price, around 650 million tons of carbon are traded each year, with China and India accounting for the largest sale share and the USA buying more than half of these emissions (see Figure 21).

²⁵ See Burniaux and Oliveira-Martins (2002) for an analytical assessment of these effects.

²⁶ Emission trading among Annex 1 countries implies that constraint of the EEFSU region becomes effective as part of the Annex 1 total constraint while this constraint is not binding in the “no trade” scenario. As a result, Annex 1 emissions increase “ex post” relative to their levels in the “no trade” scenario by an amount equal to the “hot air” less the leakage that would occur in the EEFSU in the “not trade” case. In the same way, world emissions in the “world trade” case are higher than in the “no trade” case by an amount equal to the “hot air: less the total leakage generated in the EEFSU and in the non-Annex 2 regions in the “no trade” case. As for the non-Annex 1 regions, this might not be realistic as most analysts recognize that the Clean Development Mechanisms is not going to prevent carbon leakages.

Figure 20 : Emission trading among Annex 1 countries

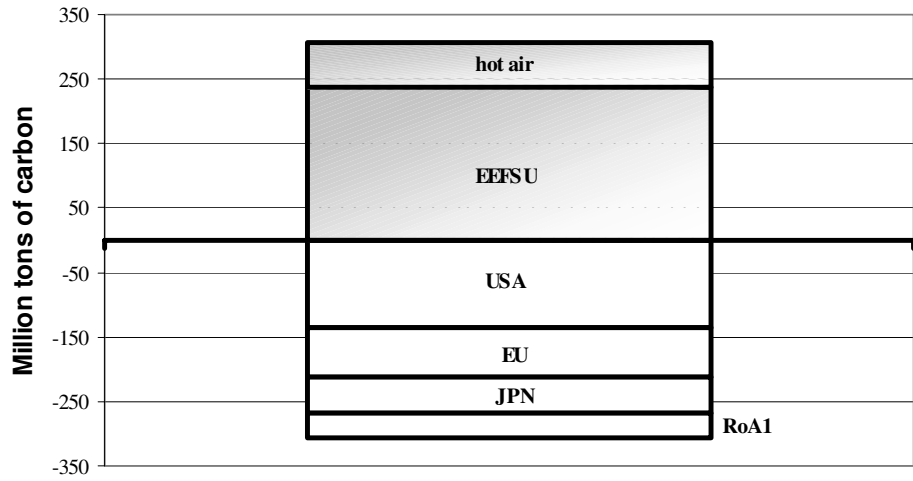

positive figures are sales; negative figures are purchases

Figure 21 : Worldwide emission trading

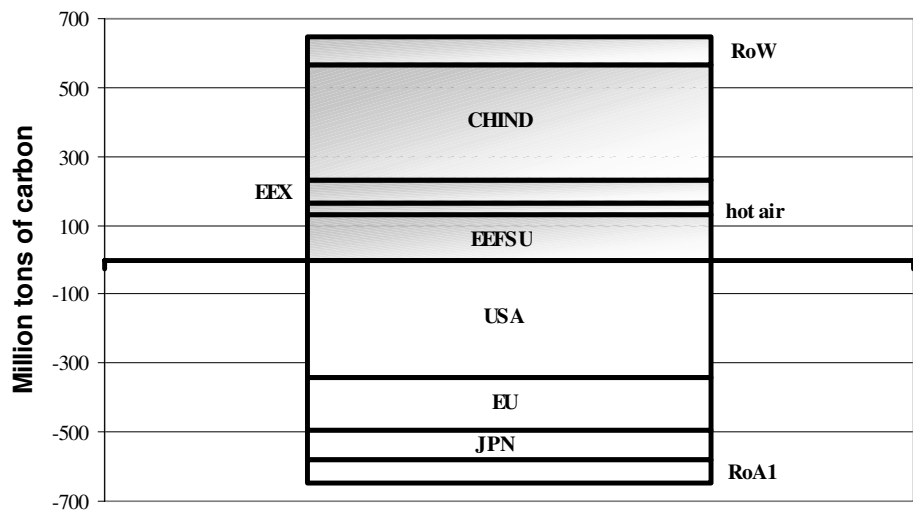

positive figures are sales; negative figures are purchases

Table 14 Marginal Costs of Achieving the Kyoto Targets with and Without Using the Flexibility Mechanisms

	Kyoto with No Use of the Marginal Costs		Kyoto with Emission Trading		Kyoto with Worldwide Marginal Costs	
	% Reduction of Emissions	(1997 USD per Ton of Carbon)	% Reduction of Emissions	(1997 USD per Ton of Carbon)	% Reduction of Emissions	(1997 USD per Ton of Carbon)
USA	-36	126	-27	78	-13	30
EU	-22	147	-14	78	-6	30
EEFSU	4	0	-27	76	-13	30
JPN	-32	233	-15	78	-6	30
RoA1	-36	178	-21	78	-9	30
EEx	3	0	2	0	-7	30
CHIND	-1	0	-1	0	-32	29
RoW	4	0	4	0	-9	30
Annex 1	-24		-22		-10	
Non-Annex 1	2		1		-19	
Leakage rate (incl. EEFSU)	7.1%		na		na	
Leakage rate (incl. EEFSU)	4.0%		3.7%		na	

Note that the marginal costs are expressed in real terms (i.e. deflated by the GDP deflator of each country/region). Therefore, slightly different marginal costs in case of emission trading are consistent with a common trading price of nominal terms

4.2 Macroeconomic Results

Table 11 reports the macroeconomic costs of implementing the Kyoto Protocol in terms of the percentage change in per capita utility of the representative household and the associated terms-of-trade changes. If the flexibility mechanisms are not used, the costs for the Annex 1 Parties (measured in terms of utility of the representative regional household) ranges from 0.25 per cent in the USA to 1.3 per cent in the RoA1 region. The higher cost in the RoA1 region is partly explained by the degradation of the terms-of-trade related to the fact that many countries belonging to this region are net energy exporters. In contrast, in the net energy-importing, Annex 1 economies, the costs of imposing carbon restrictions are partly mitigated by terms-of-trade improvements associated with the reduction in international energy prices – particularly for oil. The EEFSU region loses 0.4 % of its welfare despite the fact that it has no carbon constraint to comply with; this loss is entirely explained by the fall of the energy exports value. Interestingly, some non-Annex 1 countries/regions might even lose more than the Annex 1 countries following the implementation of the Kyoto Protocol. This is clearly the case for the energy exporters (EEx).

Emission trading among Annex 1 countries (see the middle columns of Table 11) reduces the losses in all Annex 1 countries while generating substantial gains (+ 2.8 percent) in the EEFSU region. It also contributes to a reduction in the losses incurred by the non-Annex 1 energy exporters as it shifts the burden of the reduction from oil towards coal and therefore implies a lower fall of the international oil price. A worldwide emission trading system would contribute to a reduction in the economic costs for the Annex 1 countries and energy exporters, while generating net gains in China, India and the EEFSU region.

Figures 22 to 23 summarize the real income changes (in terms of equivalent variation) implied by the three alternative implementations of the Kyoto Protocol and provide a decomposition of the real income variations into terms-of-trade and allocative²⁷ effects. The most noticeable outcome is that substantial cost saving can be achieved by allowing emissions to be traded. Annex 1 trading would cut the aggregate world real income loss by a half (\$110 billion (1997 USD) to \$50 billion) and a worldwide trading system would further reduce the cost by another half (from \$50 billion to less than \$25 billion). It must also be noted that almost every party has a vested interest in some form of emission trading (with the noticeable exception of the RoW region) though the Former Soviet Union has an unambiguous interest in restricting trading to Annex 1 countries only.

²⁷ In Figures 22 to 24, allocative effects include pure losses from less efficient allocations of production and consumption as well as the real income benefits and losses from the sales and purchases of carbon emissions.

Table 15 Macroeconomic Impacts of Implementing the Kyoto Protocol: Percent change in welfare (in) and terms of trade (tot)

	Kyoto With No Use of the Flexibility Mechanisms		Kyoto with Emission Trading Among Annex 1 Countries only		Kyoto with Worldwide Emission Trading	
USA	-0.25	0.96	-0.26	0.54	-0.16	0.18
EU	-0.48	0.33	-0.27	0.20	-0.06	0.12
EEFSU	-0.41	-0.87	2.75	0.92	0.66	0.05
JPN	-0.61	1.34	-0.27	0.66	-0.07	0.43
RoA1	-1.30	-0.65	-0.86	-0.56	-0.42	-0.40
EEx	-1.00	-3.02	-0.73	-2.19	-0.53	-1.47
CHIND	0.08	0.03	0.05	-0.01	0.44	-0.80
RoW	0.16	0.26	0.13	0.22	0.10	0.32

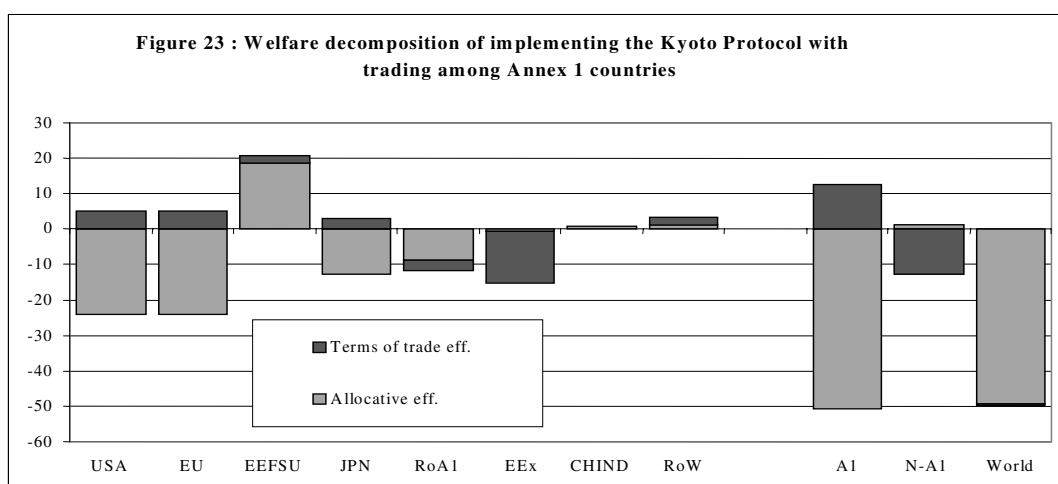
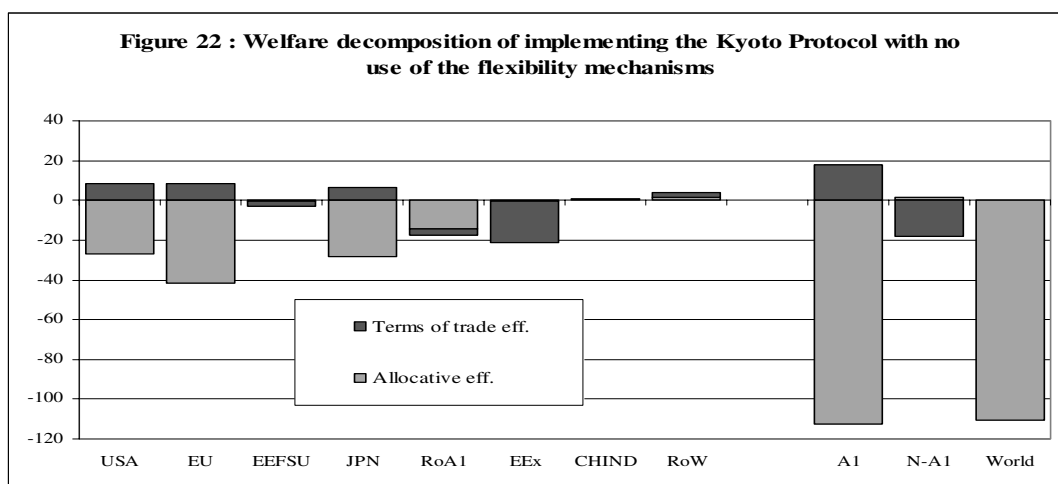

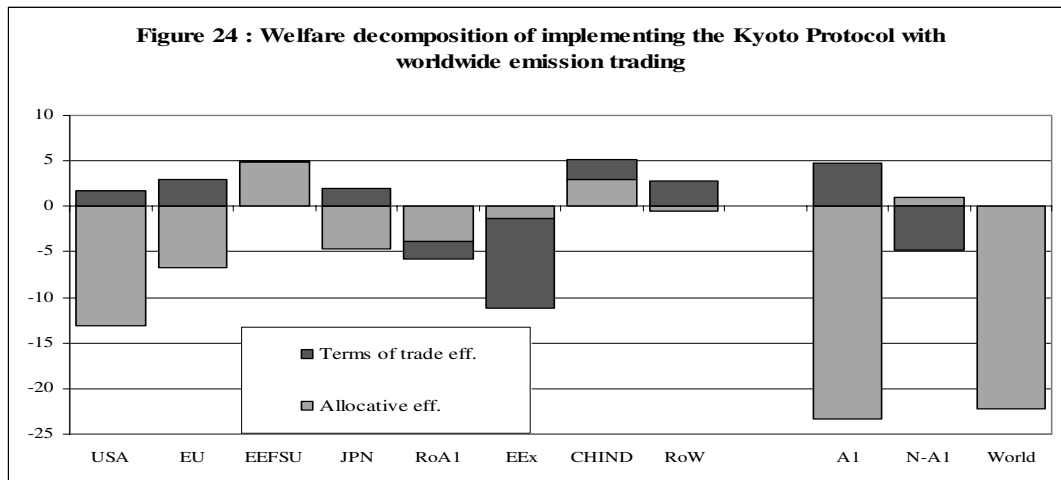

5. Conclusion

This technical paper has surveyed some existing CGE models which deal with the issue of energy substitution. Important features of these models are highlighted, and where possible, some of these important features have been adapted into the existing standard GTAP model. The result in the model, nick-named GTAP-E is then used to conduct some alternative scenarios involving implementation of the Kyoto Protocol. The main purpose of these experiments is to highlight the suitability of the GTAP-E model in analyzing the implications of alternative strategies to reduce GHG emissions. The introduction of the energy-environmental dimension in GTAP is only one step towards the elaboration of a GTAP framework that is suitable to analyze GHG issues. It is hoped that the current version of GTAP-E could be further extended in order to incorporate some other aspects, such as the complex relationship between land uses and GHG emissions.

```

! closure with exogenous trade balances
exogenous
  pop
  psaveslack pfactwld
  profitslack incomeslack endwslack
  tradslack
  ams atm atf ats atd
  aosec aoreg avasec avareg
  afcom afsec afreg afecom afesec afereg
  aoall afall afeall
  au dppriv dpgov dpsave
  to tp tm tms tx txs
  qo(ENDW_COMM,REG)
  RCTAX
  MARKCTAX
  dcwfd(NEGYCOM3,PROD_COMM,REG)
  dcwfd(COALS,COALS,REG)
  dcwfd(OILS,OILEXS,REG)
  dcwfd(GASS,GASEXS,REG)
  dcwfd(OIL_PCS,OIL_PCEXS,REG)
  dcwfi(NEGYCOM3,PROD_COMM,REG)
  dcwfi(COALS,COALS,REG)
  dcwfi(OILS,OILEXS,REG)
  dcwfi(GASS,GASEXS,REG)
  dcwfi(OIL_PCS,OIL_PCEXS,REG)
  dcwpi(NEGYCOM3,REG)
  dcwpi(NEGYCOM3,REG)
  dcwgd(NEGYCOM3,REG)
  dcwgi(NEGYCOM3,REG)
  c_CTAXBAS(REG,NEGYCOM3B)
! DTBAL exogenous for all regions except one,
! and cgdslack exogenous for that one region (which can be any one).
  dtbal("USA")
  dtbal("EU")
  dtbal("EEFSU")
  dtbal("JPN")
  dtbal("RoA1")
  dtbal("EEx")
  dtbal("CHIND")
  cgdslack("RoW") ;
Rest Endogenous ;
swap gco2t("USA")=RCTAX("USA");
swap gco2t("EU")=RCTAX("EU");
swap gco2t("JPN")=RCTAX("JPN");
swap gco2t("RoA1")=RCTAX("RoA1");

Shock gco2t("USA") = -35.6;
Shock gco2t("EU") = -22.4;
Shock gco2t("JPN") = -31.8;
Shock gco2t("RoA1") = -35.7;

```

Annex 1 General Equilibrium Elasticities in GTAP-E and GTAP

To compare GTAP-E with GTAP, the simplest and most effective way is to compare the overall general-equilibrium (GE) elasticities of the GTAP-E model with those of the GTAP model. The GE elasticities are a function of the structure of the model, the values of the substitution parameters assumed, the benchmark database and the particular closure assumed²⁸. For a standard GE closure where all the prices and quantities of non-endowment commodities are allowed to be endogenously determined, the GE elasticities calculated for this closure will truly reflect the general equilibrium character of the demand elasticities²⁹.

First we look at the GE *own-price* elasticities. These elasticities measure the percentage change in the output of commodity i in region r (i.e. $qo(i,r)$) following a 1% change in its own-price ($pm(i,r)$) induced by an appropriate perturbation in the output tax $to(i,r)$. The change in the output level can come from two different causes: (i) changes in the general level of activity (we can refer to this as the “output (expansion or contraction) effect”), and (ii) changes due to the substitution of one input or commodity for another (the “substitution effect”³⁰).

For the energy commodities, because of the additional (energy) input-substitution structure introduced into the GTAP-E model, we expect the negative “substitution effect” in this model to add to the negative “output effect” when the price of an energy commodity increases. This means the magnitude of the GE own-price elasticities for energy commodities in the GTAP-E model is likely to be greater than those in the GTAP model. This is in fact confirmed in Table 10: the changes in the GE elasticities for the energy commodities are all negative when we go from GTAP to GTAP-E, indicating that the magnitudes of the (negative) elasticities are all increasing.

For the non-energy commodities, on the other hand, since both the GTAP and GTAP-E models have similar structures for these commodities, we will expect that there are insignificant changes in the GE own-price elasticities as we move from GTAP to GTAP-E. From Table 10, this is again confirmed: the small variations in the magnitudes of these elasticities for the non-energy commodities arise only from the output (expansion/contraction) effects and which are seen to be small. Also, the variation can be in either direction.

Tables 11 and 12 give the GE *cross-price* elasticities for the US and China for illustrative purposes. For both of these countries, we notice that all energy commodities are substitutes (cross-price elasticities being positive), with the exception of the pairs: COL and ELY, and OIL and P_C. These pairs of energy commodity are complements because COL is a significant input into ELY, and similarly OIL is a significant input into P_C.

As we move from GTAP to GTAP-E, the magnitudes of the cross-price GE elasticities for the energy commodities become greater, as expected. This is in contrast to the case of the GE

²⁸ As the GE elasticities are a function of the particular closure assumed, in this section, we present the GE elasticities which are associated with the experiment considered in the next section. Changing this experiment and its closure will affect the GE elasticities.

²⁹ See Chapter 5 of Hertel (ed.) (1997).

³⁰ Here substitution can occur between different *outputs* (i.e. in final demand) as well as between different *inputs* (intermediate demand).

cross-price elasticities for the non-energy commodities. In the latter case, since both GTAP and GTAP-E assume similar structures for these non-energy commodities, their corresponding GE cross-price elasticities as thus also similar³¹.

Finally, between the energy and non-energy commodities, we notice a significant degree of complementarity (negative cross-price elasticities) between P_C and ELY on the one hand, and the non-energy commodities on the other hand. This reflects the importance of P_C and ELY as major energy inputs into the production of these non-energy commodities.

³¹ The non-energy commodities are also observed to be all 'substitutable' for each other despite the fact that in the intermediate input sub-structure, zero substitution was assumed between these non-energy intermediate inputs. The 'substitution' as reflected in the GE cross-price elasticities, however, reflects mainly the output (contraction/expansion) effects, which come from a re-allocation of resources resulting from a change of the relative prices among these commodities.

Table A1-1 General-Equilibrium Own-Price Elasticities

Sectors/ Commodities	GE Elasticities WITH Energy Substitution from GTAP-E Model (A):							
	JPN	CHN	IND	USA	E_U	FSU	NEX	NEM
COL	-3.75	-0.43	-0.07	-0.85	-1.19	-1.59	-1.22	-1.38
OIL	-9.88	-3.02	-9.39	-3.33	-7.09	-5.27	-0.88	-7.39
GAS	-1.69	-1.03	-0.72	-0.94	-1.46	-1.68	-1.27	-1.18
P_C	-0.91	-0.83	-1.13	-0.97	-0.91	-1.28	-1.28	-1.05
ELY	-0.84	-1.00	-0.79	-0.82	-1.15	-1.07	-1.21	-1.15
I_S	-0.47	-0.86	-1.09	-0.78	-1.00	-2.83	-1.66	-1.78
CRP	-0.50	-1.02	-1.15	-0.95	-0.96	-1.27	-1.40	-1.26
OMN	-0.75	-1.66	-1.43	-0.89	-0.87	-1.34	-1.40	-1.46
AGR	-0.40	-0.32	-0.24	-0.67	-0.59	-0.99	-0.55	-0.56
SER	-0.25	-0.27	-0.30	-0.32	-0.31	-0.30	-0.37	-0.35
Sectors/ Commodities	GE Elasticities WITHOUT Energy Substitution from GTAP Model (B):							
	JPN	CHN	IND	USA	E_U	FSU	NEX	NEM
COL	-3.71	-0.40	-0.02	-0.26	-0.69	-1.14	-0.81	-1.03
OIL	-9.82	-2.16	-9.13	-1.92	-4.70	-3.58	-0.24	-6.05
GAS	-1.20	-0.03	0.00	-0.27	-0.92	-1.13	-0.65	-0.47
P_C	-0.41	-0.32	-0.79	-0.40	-0.50	-0.85	-0.90	-0.54
ELY	-0.22	-0.08	-0.03	-0.16	-0.34	-0.33	-0.48	-0.27
I_S	-0.47	-0.85	-1.09	-0.78	-1.00	-2.82	-1.66	-1.78
CRP	-0.50	-1.03	-1.16	-0.95	-0.96	-1.27	-1.40	-1.26
OMN	-0.80	-1.59	-1.62	-0.93	-0.84	-1.41	-1.38	-1.48
AGR	-0.40	-0.31	-0.24	-0.67	-0.59	-0.99	-0.54	-0.56
SER	-0.25	-0.25	-0.29	-0.32	-0.29	-0.31	-0.37	-0.34
Sectors/ Commodities	Change in Own-Price Elasticity from (B) to (A)							
	JPN	CHN	IND	USA	E_U	FSU	NEX	NEM
COL	-0.04	-0.03	-0.05	-0.59	-0.50	-0.45	-0.41	-0.35
OIL	-0.06	-0.86	-0.26	-1.41	-2.39	-1.69	-0.64	-1.34
GAS	-0.49	-1.00	-0.72	-0.67	-0.54	-0.55	-0.62	-0.71
P_C	-0.50	-0.51	-0.34	-0.57	-0.41	-0.43	-0.38	-0.51
ELY	-0.62	-0.92	-0.76	-0.66	-0.81	-0.74	-0.73	-0.88
I_S	0.00	-0.01	0.00	0.00	0.00	-0.01	0.00	0.00
CRP	0.00	0.01	0.01	0.00	0.00	0.00	0.00	0.00
OMN	0.05	-0.07	0.19	0.04	-0.03	0.07	-0.02	0.02
AGR	0.00	-0.01	0.00	0.00	0.00	0.00	-0.01	0.00
SER	0.00	-0.02	-0.01	0.00	-0.02	0.01	0.00	-0.01

Table A1.2 General-Equilibrium Cross-Price Elasticities for the USA

GE Cross-price Elasticities WITH Energy Substitution from GTAP-E Model (A):										
Sectors/ Commodities	COL	OIL	GAS	P_C	ELY	I_S	CRP	OMN	AGR	SER
COL		0.06	0.00	0.03	-0.15	-0.01	-0.01	0.14	-0.03	0.03
OIL	0.01		0.01	-0.21	0.05	0.01	0.01	0.52	0.02	0.06
GAS	0.00	0.14		0.16	0.09	-0.01	0.04	0.47	-0.13	0.11
P_C	0.02	-0.51	0.03		0.13	-0.02	-0.13	-0.94	-0.03	0.14
ELY	-0.07	0.10	0.01	0.10		-0.01	-0.02	0.20	-0.12	0.09
I_S	-0.01	0.04	0.00	-0.04	-0.03		0.06	0.21	0.04	0.32
CRP	0.00	0.02	0.00	-0.06	-0.01	0.01		0.90	0.03	0.36
OMN	0.00	0.02	0.00	-0.02	0.00	0.00	0.04		0.01	0.35
AGR	-0.01	0.03	-0.01	-0.02	-0.08	0.01	0.04	0.28		0.18
SER	0.00	0.00	0.00	0.01	0.00	0.01	0.03	0.56	0.01	
GE Cross-price Elasticities WITHOUT Energy Substitution from GTAP Model (B):										
Sectors/ Commodities	COL	OIL	GAS	P_C	ELY	I_S	CRP	OMN	AGR	SER
COL		0.02	0.00	0.00	-0.09	-0.01	-0.01	0.40	-0.05	0.13
OIL	0.00		0.00	-0.11	-0.01	0.01	0.01	0.81	0.02	0.15
GAS	0.00	0.02		0.00	-0.06	-0.01	0.02	0.50	-0.11	0.19
P_C	0.00	0.02	0.00		0.00	-0.01	-0.12	-0.29	-0.01	0.36
ELY	0.00	0.01	0.00	0.00		-0.01	-0.03	0.19	-0.10	0.14
I_S	0.00	0.03	0.00	-0.02	-0.03		0.06	0.21	0.04	0.33
CRP	0.00	0.02	0.00	-0.01	-0.01	0.02		1.00	0.03	0.36
OMN	0.00	0.02	0.00	-0.01	-0.01	0.00	0.04		0.01	0.37
AGR	0.00	0.02	0.00	-0.01	-0.02	0.01	0.03	0.26		0.19
SER	0.00	0.00	0.00	0.01	0.01	0.01	0.03	0.62	0.01	
Absolute difference:(A) - (B)										
Sectors/ Commodities	COL	OIL	GAS	P_C	ELY	I_S	CRP	OMN	AGR	SER
COL		0.04	0.00	0.03	-0.06	0.00	0.00	-0.26	0.02	-0.10
OIL	0.01		0.01	-0.10	0.06	0.00	0.00	-0.29	0.00	-0.09
GAS	0.00	0.12		0.16	0.15	0.00	0.02	-0.03	-0.02	-0.08
P_C	0.02	-0.53	0.03		0.13	-0.01	-0.01	-0.65	-0.02	-0.22
ELY	-0.07	0.09	0.01	0.10		0.00	0.01	0.01	-0.02	-0.05
I_S	-0.01	0.01	0.00	-0.02	0.00		0.00	0.00	0.00	-0.01
CRP	0.00	0.00	0.00	-0.05	0.00	-0.01		-0.10	0.00	0.00
OMN	0.00	0.00	0.00	-0.01	0.01	0.00	0.00		0.00	-0.02
AGR	-0.01	0.01	-0.01	-0.01	-0.06	0.00	0.01	0.02		-0.01
SER	0.00	0.00	0.00	0.00	-0.01	0.00	0.00	-0.06	0.00	

GE Cross-price Elasticities WITH Energy Substitution from GTAP-E Model (A):										
Sectors/ Commodities	COL	OIL	GAS	P_C	ELY	I_S	CRP	OMN	AGR	SER
COL		0.05	0.01	0.04	-0.01	0.02	0.04	1.19	0.06	0.01
OIL	0.01		0.00	-0.11	0.04	0.03	0.03	1.97	0.06	0.05
GAS	0.16	0.19		0.22	0.07	0.03	-0.30	0.60	0.01	0.02
P_C	0.03	-0.50	0.01		0.14	-0.04	-0.20	-2.01	-0.11	0.00
ELY	-0.01	0.16	0.00	0.14		-0.06	-0.13	-0.30	-0.03	0.01
I_S	0.01	0.06	0.00	-0.02	-0.03		0.14	2.12	0.21	-0.03
CRP	0.01	0.03	0.00	-0.06	-0.04	0.09		2.61	0.05	0.06
OMN	0.01	0.07	0.00	-0.02	-0.01	0.03	0.07		0.09	0.05
AGR	0.00	0.01	0.00	-0.01	-0.01	0.03	0.01	0.76		0.12
SER	0.00	0.01	0.00	0.00	0.00	0.00	0.02	0.73	0.08	
GE cross-price elasticities WITHOUT energy substitution from GTAP model (B):										
Sectors/ Commodities	COL	OIL	GAS	P_C	ELY	I_S	CRP	OMN	AGR	SER
COL		0.01	0.00	0.00	0.00	0.03	0.05	1.10	0.04	0.00
OIL	0.00		0.00	-0.05	0.00	0.04	0.04	2.68	0.09	0.06
GAS	0.01	0.04		0.00	-0.01	0.02	-0.40	0.85	0.03	0.08
P_C	0.00	0.04	0.00		-0.01	-0.01	-0.18	0.40	0.03	0.08
ELY	0.00	0.04	0.00	0.00		-0.07	-0.13	0.39	0.05	0.06
I_S	0.00	0.05	0.00	-0.01	-0.01		0.15	2.26	0.21	-0.04
CRP	0.01	0.05	0.00	0.00	0.00	0.08		2.71	0.05	0.05
OMN	0.01	0.05	0.00	-0.01	-0.01	0.05	0.09		0.10	0.05
AGR	0.00	0.03	0.00	0.01	0.01	0.02	0.00	0.98		0.13
SER	0.00	0.01	0.00	0.01	0.01	-0.02	0.00	0.89	0.09	
Absolute difference:(A) - (B)										
Sectors/ Commodities	COL	OIL	GAS	P_C	ELY	I_S	CRP	OMN	AGR	SER
COL		0.04	0.01	0.04	-0.01	-0.01	-0.01	0.09	0.02	0.01
OIL	0.01		0.00	-0.06	0.04	-0.01	-0.01	-0.71	-0.03	-0.01
GAS	0.15	0.15		0.22	0.08	0.01	0.10	-0.25	-0.02	-0.06
P_C	0.03	-0.54	0.01		0.15	-0.03	-0.02	-2.41	-0.14	-0.08
ELY	-0.01	0.12	0.00	0.14		0.01	0.00	-0.69	-0.08	-0.05
I_S	0.01	0.01	0.00	-0.01	-0.02		-0.01	-0.14	0.00	0.01
CRP	0.00	-0.02	0.00	-0.06	-0.04	0.01		-0.10	0.00	0.01
OMN	0.00	0.02	0.00	-0.01	0.00	-0.02	-0.02		-0.01	0.00
AGR	0.00	-0.02	0.00	-0.02	-0.02	0.01	0.01	-0.22		-0.01
SER	0.00	0.00	0.00	-0.01	-0.01	0.02	0.02	-0.16	-0.01	

Annex 2 Specifying Country-specific Carbon Reductions with no Emission Trading in GTAP-E.

The following box shows the closure and shocks used to simulate the “no-trade” case. This scenario assumes no change of the trade account: thus the variable DTBAL (a linear variable expressed in changes) is exogenous and equal to zero in all countries/regions except one. Accordingly, the slack variable cgdslack is made endogenous (while it is exogenous in the standard closure). Thus investment is calculated as a residue in order to guarantee no change of the trade account. The quantitative restrictions applied to carbon emissions are introduced by making the real carbon tax RCTAX (i.e. the nominal carbon tax deflated by the GDP deflator) endogenous and the emission growth rates gco2t exogenous and equal to the Kyoto commitments (expressed as a percentage reduction relative to the corresponding emission levels in 2010 in a scenario with no constraints). Alternatively, one might impose an exogenous real or nominal carbon tax (RCTAX or NCTAX) and leave the emission growth rates to be determined endogenously.

An accompanying program calculates the Social Account Matrices (SAMs). The Table A2-1 below shows the SAM of the US after the emission constraint has been applied. The best way to interpret the income flows associated to the restriction is to assume that the restriction is imposed through a domestic market of emission rights. The row CAG shows the revenues that are perceived by some kind of centralized Carbon Agency from selling emission permits. The total proceeds of these sales amounts to 124 billion 1997 USD, two thirds of which originate from sales to the electricity sector (42 billion 1997 USD) and to the other industries and services (40 billion 1997 USD). Thus, in the electricity sector, purchases of emission permits would amount up to 15 per cent of all electricity sales. The total proceeds from domestic permit sales are then refunded to the Regional Household (see the entry of 124 billion 1997 USD paid by of the RHH).

Box A.2.1 Closure and Shocks for No Trading Scenario

```
! closure with exogenous trade balances
exogenous
  pop
  psaveslack pfactwld
  profitslack incomeslack endwslack
  tradslack
  ams atm atf ats atd
  aosec aoreg avasec avareg
  afcom afsec afreg afecom afesec afereg
  aoall afall afeall
  au dppriv dpgov dpsave
  to tp tm tms tx txs
  qo(ENDW_COMM,REG)
  RCTAX
  MARKCTAX
  dcwfd(NEGYCOM3,PROD_COMM,REG)
  dcwfd(COALS,COALS,REG)
  dcwfd(OILS,OILEXS,REG)
  dcwfd(GASS,GASEXS,REG)
  dcwfd(OIL_PCS,OIL_PCEXS,REG)
  dcwfi(NEGYCOM3,PROD_COMM,REG)
  dcwfi(COALS,COALS,REG)
  dcwfi(OILS,OILEXS,REG)
  dcwfi(GASS,GASEXS,REG)
  dcwfi(OIL_PCS,OIL_PCEXS,REG)
!   dcwpd(NEGYCOM3,REG)
  dcwpi(NEGYCOM3,REG)
  dcwgd(NEGYCOM3,REG)
  dcwgi(NEGYCOM3,REG)
  c_CTAXBAS(REG,NEGYCOM3B)
DTBAL exogenous for all regions except one,
! and cgdslack exogenous for that one region (which can be any one).
  dtbal("USA")
  dtbal("EU")
  dtbal("EEFSU")
  dtbal("JPN")
  dtbal("RoA1")
  dtbal("EEx")
  dtbal("CHIND")
  cgdslack("RoW") ;
Rest Endogenous ;
swap gco2t("USA")=RCTAX("USA");
swap gco2t("EU")=RCTAX("EU");
swap gco2t("JPN")=RCTAX("JPN");
swap gco2t("RoA1")=RCTAX("RoA1");
Shock gco2t("USA") = -35.6;
Shock gco2t("EU") = -22.4;
Shock gco2t("JPN") = -31.8;
Shock gco2t("RoA1") = -35.7;
```

Table A2.1 : Social Account Matrix of the USA in the "no trade" scenario (billions 1997 USD).																					
	1 Agriculture	2 Coal	3 Oil	4 Gas	5 Oil_Pcts	6 Electricity	7 En_Int_ind	8 Oth_ind_ser	9 Land	10 Lab	11 Capital	12 NatlRes	13 PHH	14 GOV	15 CGDS	16 RHH	17 CAG	18 ROW	19 TRUST	Total	
1 Agriculture	45	0	0	0	0	0	2	152	0	0	0	0	0	31	1	0	0	0	0	267	
2 Coal	0	0	0	0	0	13	1	0	0	0	0	0	0	0	0	0	0	0	0	0	16
3 Oil	0	0	0	0	44	0	0	0	0	0	0	0	0	0	0	0	0	0	0	0	45
4 Gas	4	0	0	1	0	9	3	8	0	0	0	0	4	0	0	0	0	0	0	0	29
5 Oil_Pcts	2	0	0	0	7	3	16	53	0	0	0	0	30	0	0	0	0	0	0	6	117
6 Electricity	14	0	0	0	0	49	36	119	0	0	0	0	62	0	0	0	0	0	0	0	279
7 En_Int_ind	14	1	1	0	2	1	213	425	0	0	0	0	115	18	3	0	0	0	114	0	907
8 Oth_ind_ser	84	5	19	12	18	38	221	4223	0	0	0	0	5036	1150	1244	0	0	0	701	0	12751
9 Land	36	0	0	0	0	0	0	0	0	0	0	0	0	0	0	0	0	0	0	0	36
10 Lab	39	2	5	7	5	36	209	4636	0	0	0	0	0	0	0	0	0	0	0	0	4938
11 Capital	40	1	11	7	5	87	137	2653	0	0	0	0	0	0	0	0	0	0	0	0	2941
12 NatlRes	1	6	9	0	0	0	2	0	0	0	0	0	0	0	0	0	0	0	0	0	17
13 PHH	0	0	0	0	0	0	0	0	0	0	0	0	0	0	0	5575	0	0	0	0	5575
14 GOV	0	0	0	0	0	0	0	0	0	0	0	0	0	0	0	1219	0	0	0	0	1219
15 CGDS	0	0	0	0	0	0	0	0	0	0	0	0	0	0	0	528	0	0	0	0	528
16 RHH	-24	0	0	0	0	0	1	11	36	4938	2941	17	7	1	-731	0	124	0	0	0	7322
17 CAG	4	0	0	0	0	42	16	40	0	0	0	0	22	0	0	0	0	0	0	0	124
18 ROW	8	1	1	1	36	3	52	430	0	0	0	0	268	49	162	0	0	0	0	0	1011
19 TRUST	0	0	0	0	0	0	0	0	0	0	0	0	0	0	0	0	0	0	0	0	0
Total	267	16	45	29	117	279	907	12751	36	4938	2941	17	5575	1219	679	7322	124	1011	0	0	38273

Annex 3 Specifying Emission Trading in GTAP-E.

Setting up an emission trading system requires to identify a global emission constraint for the group of countries/regions involved in trading and to allocate emission quotas among these countries/regions, the sum of which is equal to the global constraint. The global constraint in GTAP-E is imposed by making exogenous the variable `gmarkco2t` (see the box below), while the corresponding marginal abatement cost for the trading area (i.e. corresponding to the common price at which permits are traded) is specified as an endogenous variable (see `MARKCTAX` in the box below). The quotas allocated to each trading partners are specified by making the corresponding variables `gco2q` exogenous (note that these variables are endogenous and automatically equal to `gco2t` in the “no trade” scenario) and by “shocking” these variables along with a given quota allocation. It is to the user to verify that the sum of the quotas in terms of emission levels corresponds to the total constraint imposed to the exogenous variable `gmarkco2t` (in the example below, the weighted sum of the quotas growth rates specified for the Annex 1 countries/regions must be equal to the exogenous reduction of the Annex 1 emissions by 22.13 % imposed to the variable `gmarkco2t`). Failure to specify a consistent quota allocation will result into trading flows imbalances.

The closure below implies that the sum of the trade account and the net carbon flows (i.e. the proceeds of emission sales and the expenditures of emissions purchases) is set exogenous and equal to zero. In other words, if a country buys emission rights, it has to compensate for it by exporting more goods and services such as to satisfy to the assumption of a constant net capital flow with the rest of the world (i.e. the net investment-saving balance remains unchanged as will be illustrated later on). Alternative closure rules might, of course, be used.

The Table A3-1 shows the SAM for the US in the “Annex 1 trade” case. The total revenue perceived by the Carbon Agency (CAG) is lower than in the “no trade” case (76 billion of 1997 USD compared with 124 billion of 1997 USD). The explanation is twofold. First, extending emission trading to Annex 1 countries lowers the price of permits (from 126 1997 USD to 78 1997 USD per ton of carbon). Second, assuming that the Carbon Agency plays a centralized role in articulating the domestic and the international permit market, it has now to pay for buying permits to the Former Soviet Union (see the negative entry of 11 billion 1997 USD of the CAG row to the ROW column). The Table A3-2 reports the international flows including those related to permit trading. It shows that the total amount of permit sales by the EEFSU region amounts to 24 billion of 1997 USD, 11 billions of it are sales to the USA (see the row `CTRAD`). Given the closure rule, the net capital flows in each country/region (`ISBAL`) remains constant and equal to their benchmark values so that any flow associated to permit trading has to be balanced by a compensatory change of the trade account (`BALPW`). For instance, permit sales in the EEFSU region make possible a deficit of the trade account by 41 billion of 1997 USD.

To summarize, specifying a permit-trading scheme involving a sub-group of countries/regions requires the following steps:

- The countries/regions that are involved in trading are specified in the base data (basedata.har) by setting the corresponding values of the D_MARK coefficients (du variable for participation to permit trading, header EMTR) equal to unity.
- The corresponding RCTAX variables are set endogenous in the closure.
- The country/region specific quotas have to be specified. This is done by making corresponding gco2q variables exogenous in the closure and by specifying the growth of quotas in the SHOCK file.
- The aggregate emission growth for the trading area (gmarkco2t) is set exogenous “shocked” accordingly while the equilibrium permit price for the area (i.e. the price at which permits are exchanged: MARKCTAX) becomes endogenous (see the corresponding SV statement below).

Note that all values of the D_MARK coefficients should be equal to zero unless a permit-trading scheme is specified.

Box A.3.1 Closure and Shocks for Emissions Trading Among Annex 1 Countries

```

! basic closure
exogenous
  pop
  psaveslack pfactwld
  profitslack incomeslack endwslack
  tradslack
  ams atm atf ats atd
  aosec aoreg avasec avareg
  afcom afsec afreg afecom afesec afereg
  aoall afall afeall
  au dppriv dpgov dpsave
  to tp tm tms tx txs
  qo(ENDW_COMM,REG)
  RCTAX("EEEx")
  RCTAX("CHIND")
  RCTAX("RoW")
  MARKCTAX
  dcwfd(NEGYCOM3,PROD_COMM,REG)
  dcwfd(COALS,COALS,REG)
  dcwfd(OILS,OILEXS,REG)
  dcwfd(GASS,GASEXS,REG)
  dcwfd(OIL_PCS,OIL_PCEXS,REG)
  dcwfi(NEGYCOM3,PROD_COMM,REG)
  dcwfi(COALS,COALS,REG)
  dcwfi(OILS,OILEXS,REG)
  dcwfi(GASS,GASEXS,REG)
  dcwfi(OIL_PCS,OIL_PCEXS,REG)
  dcwpi(NEGYCOM3,REG)
  dcwgd(NEGYCOM3,REG)
  dcwgi(NEGYCOM3,REG)
  c_CTAXBAS(REG,NEGYCOM3B)
! DTBALCTRA (incl. permit trading) exogenous for all regions except one,
! and SAVESLACK exogenous for that one region (which can be any one).

  dtbalctra("USA")
  dtbalctra("EU")
  dtbalctra("EEFSU")
  dtbalctra("JPN")
  dtbalctra("RoA1")
  dtbalctra("EEEx")
  dtbalctra("CHIND")
  cgdslack("RoW")
  gco2q("USA") gco2q("EU") gco2q("EEFSU") gco2q("JPN") gco2q("RoA1") ;
Rest Endogenous ;
swap gmarkco2t=MARKCTAX;

Shock gco2q("USA") = -35.6;
Shock gco2q("EU") = -22.4;
Shock gco2q("JPN") = -31.8;
Shock gco2q("RoA1") = -35.7;
Shock gco2q("EEFSU") = 12.869;

Shock gmarkco2t = -22.132;

```

Table A3.1: Social Account Matrix of the USA in the "Annex 1 trade" scenario (billions 1997 USD).																					
	1 Agriculture	2 Coal	3 Oil	4 Gas	5 Oil_Pcts	6 Electricity	7 En_Int	8 Int_ser	9 Land	10 Lab	11 Capital	12 NatRes	13 PHH	14 GOV	15 CGDS	16 RHH	17 CAG	18 ROW	19 TRUST	Total	
1 Agriculture	45	0	0	0	0	0	2	152	0	0	0	0	31	1	0	0	0	0	35	0	267
2 Coal	0	0	0	0	0	16	1	0	0	0	0	0	0	0	0	0	0	0	3	0	19
3 Oil	0	0	0	0	47	0	0	0	0	0	0	0	0	0	0	0	0	0	1	0	48
4 Gas	4	0	0	1	10	0	4	9	0	0	0	0	5	0	0	0	0	0	0	0	33
5 Oil_Pcts	3	0	0	0	8	3	18	59	0	0	0	0	35	0	0	0	0	0	6	0	131
6 Electricity	13	0	0	0	0	44	33	113	0	0	0	0	61	0	0	0	0	0	0	0	264
7 En_Int	14	1	1	0	3	1	213	421	0	0	0	0	114	18	3	0	0	0	117	0	904
8 Oth_int_ser	84	6	20	14	19	36	223	421	0	0	0	0	5004	1143	1236	0	0	0	709	0	12710
9 Land	40	0	0	0	0	0	0	0	0	0	0	0	0	0	0	0	0	0	0	0	40
10 Lab	39	3	5	8	6	33	206	4621	0	0	0	0	0	0	0	0	0	0	0	0	4921
11 Capital	39	2	11	8	5	86	139	2658	0	0	0	0	0	0	0	0	0	0	0	0	2949
12 NatRes	1	7	10	0	0	0	2	0	0	0	0	0	0	0	0	0	0	0	0	0	19
13 PHH	0	0	0	0	0	0	0	0	0	0	0	0	0	0	0	0	0	0	0	0	5538
14 GOV	0	0	0	0	0	0	0	0	0	0	0	0	0	0	0	0	0	0	0	0	1211
15 CGDS	0	0	0	0	0	0	0	0	0	0	0	0	0	0	0	0	0	0	0	0	525
16 RHH	-25	0	0	0	0	0	1	11	40	4921	2949	19	7	1	-727	0	76	0	0	0	7274
17 CAG	3	0	0	0	0	30	11	27	0	0	0	0	15	0	0	0	0	0	-11	0	76
18 ROW	8	1	1	2	44	3	52	427	0	0	0	0	266	48	161	0	0	0	0	0	1011
19 TRUST	0	0	0	0	0	0	0	0	0	0	0	0	0	0	0	0	0	0	0	0	0
Total	267	19	48	33	131	264	904	12710	40	4921	2949	19	5538	1211	675	7274	76	1011	1011	0	38091

Table A3-2 International Flows in the "Annex 1 Trade" Scenario (billion of 1976 USD)

	1 USA	2 EU	3 EFSU	4 JPN	5 RoAI	6 EEx	7 CHIND	8 RoW	Total
1 BALPW	-140	99	-41	92	52	-4	25	-83	0
2 CTRAD	-11	-6	124	-4	-3	0	0	0	0
3 ISBAL	150	-93	17	-88	-49	4	-25	83	0
Total	0	0	0	0	0	0	0	0	0

Annex 4 Specifying Emission Trading in GTAP-E

Table A4-1 Regional Disaggregation

No.	New Code	Region Description	Comprising GTAP V5 Countries/Regions
1	USA	United States	United States
2	EU	European Union	Austria; Belgium; Denmark; Finland; France; Germany; United Kingdom; Greece; Ireland; Italy; Luxembourg; Netherlands; Portugal; Spain; Sweden
3	EEFSU	Eastern Europe and FSU	Hungary; Poland; Rest of Central European Assoc: Former Soviet Union
4	JPN	Japan	Japan
5	RoA1	Oth. Annex 1 Countries	Australia; New Zealand; Canada; Switzerland; Rest of EFTA
6	EEx	Net Energy Exporters	Indonesia; Malaysia; Viet Nam; Mexico; Colombia; Venezuela; Rest of Andean Pact; Argentina; Rest of Middle East; Rest of North Africa; Rest of Southern Africa; Rest of Sub-Saharan Africa; Rest of World
7	CHIND	China and India	China; India
8	RoW	Rest of the World	Hong Kong; Korea, Republic of; Taiwan; Philippine; Singapore; Thailand; Bangladesh; Sri Lanka; Rest of South Asia; Central America and Caribbean; Peru; Brazil; Chile; Uruguay; Rest of South America; Turkey; Morocco; Botswana; Rest of SACU; Malawi; Mozambique; Tanzania, United Republic of; Zambia; Zimbabwe; Uganda

Table A4-2 Sectoral Disaggregation

No.	New Code	Region Description	Comprising GTAP V5 Countries/Regions
1	Agriculture	Primary Agric., Forestry and Fishing	paddy rice; wheat cereal grains n.e.c.; vegetables, fruit, nuts; oil seeds; sugar cane, sugar beet; plant-based fibers; crops n.e.c.; bovine cattle, sheep and goats; animal products n.e.c.; rat milk; wool, silk-worm cocoons; forestry; fishing
2	Coal	Coal Mining	coal
3	Oil	Crude Oil	oil
4	Gas	Natural Gas Extraction	gas; gas manufacture, distribution
5	Oil_Pcts	Refined Oil Products	petroleum, coal products
6	Electricity	Electricity	electricity
7	En_Int_Ind	Energy Intensive Industries	minerals n.e.c.; chemical, rubber, plastic prod; mineral products n.e.c.; ferrous metals; metals n.e.c.
8	Oth_Ind_Ser	Other Industry & Services	bovine cattle, sheep and goad; meat products; vegetable oils and fats; dairy products; processed rice; sugar; food products n.e.c.; beverages and tobacco products; textiles; wearing apparel; leather products; wood products; paper products, publishing; metal products; motor vehicles and parts; transport equipment n.e.c.; electronic equipment; machinery and equipment n.e.c.; manufactures n.e.c.; water; construction; trade; transport n.e.c.; water transport; air transport; communication; financial services n.e.c.; insurance; business services n.e.c.; recreational and other services; public admin. And defense, edu; ownership of dwellings

References

- ABARE. (Australian Bureau of Agricultural and Resource Economics) 1996. *The MEGABARE model: interim documentation*, February.
- ABARE. 1997. *Energy – Australian Energy Consumption and Production*, Research Report 97.2.
- Babiker, M. H., Maskus, K. E., and T. F. Rutherford. 1997. “Carbon Taxes and the Global Trading System,” Working Paper 97-7, University of Colorado, Boulder.
- Bohringer, C., and A. Pahlke. 1997. “Environmental Tax Reforms and the Prospects for a Double Dividend – An Intertemporal General Equilibrium Analysis for Germany”, Working Paper, University of Colorado, Boulder.
- Borges, A. M., and L. H. Goulder. 1984. “Decomposing the impact of higher energy prices on long-term growth,” Chapter 8 in Scarf, H. E., and J. B. Shoven (eds.), *Applied General Equilibrium Analysis*, Cambridge University Press.
- Burniaux JM, J. Oliveira Martins. 2000. "Carbon emission leakages : a general equilibrium view", OECD Economic Department, Working Paper No. 242, May .
- Burniaux, J. M., Nicoletti, G., and J. Oliveira-Martins. 1992. “GREEN: A Global Model for Quantifying the Costs of Policies to Curb CO₂ Emissions,” *OECD Economic Studies No. 19*, Winter, 49-92.
- Chang, Kuo-Ping. 1994. “Capital-energy substitution and the multi-level CES production function,” *Energy Economics*, 16 (1), 22-26
- Hanslow, K., Hinchy, M., Small, J., Fisher, B. and D. Gunasekera. 1994. “Trade and welfare effects of policies to address climate change,” ABARE Conference Paper 94.24.
- Hertel, T. W. (editor). 1997. *Global Trade Analysis: Modeling and Applications*, Cambridge University Press.
- Hogan, W. W. 1989. “A dynamic putty-semi-putty model of aggregate energy demand,” *Energy Economics*, January, pp. 53-69.
- Keller, W. J. 1980. *Tax Incidence, A General Equilibrium Approach*, North Holland.
- Lee, H., Oliveira-Martins, J., and D. van der Mensbrugge. 1994. “The OECD GREEN model: an Updated Overview” OECD Technical paper No. 97, OECD Development Center.
- Manne, A. S. and R. G. Richels. 1996. “MERGE: A Model for Evaluating Regional and Global Effects of GHG Reduction Policies,” *Energy Policy*.
- Malcolm, G. and Truong P. Truong. 1999. “The Process of Incorporating Energy Data into GTAP”, Draft GTAP Technical Paper, Center for Global Trade Analysis, Purdue University, West Lafayette, Indiana, USA.
- Nguyen, The-Hiep. 1984. “On energy coefficients and ratios,” *Energy Economics*, April, pp. 102-109.

- Nordhaus, W.D. 1979. *The Efficient Use of Energy Resources*, Yale University Press, New Haven.
- OECD. 1999. *Action Against Climate Change: The Kyoto Protocol and Beyond*.
- Perroni, C., and T. F. Rutherford. 1995. "Regular flexibility of nested CES functions," *European Economic Review*, Vol. 39, 335-343.
- Powell, A. A., and M. T. Rimmer. 1998. "The Nested- Binary CES Composite Production Function," Impact General Paper No. OP-89, Centre of Policy Studies and the Impact Project, Monash University, Clayton, Australia.
- Rutherford, T. F., W. D. Montgomery, and P. M. Bernstein. 1997. "CETM: A Dynamic General Equilibrium Model of Global Energy Markets, Carbon Dioxide Emissions and International Trade," Working Paper 97-3, University of Colorado, Boulder.
- Truong, T. P. 1999. "GTAP-E : Incorporating Energy Substitution into the GTAP Model", GTAP Technical Paper No. 16, December.
- Truong, T. P. 1985. "Inter-Fuel and Inter-factor Substitution in N.S.W. Manufacturing Industry", *Economic Record*, 61, September, pp. 644-653.
- Van der Mensbrugghe, D. 1994. "Green: The reference Manual," Economic Department Working Paper No. 143, OECD, Paris
- Vinals, J. M. 1984. "Energy-Capital Substitution, wage flexibility and aggregate output supply," *European Economic Review*, Vol. 26, No. 1-2, Oct-Nov, 229-245.
- Weyant J.P., Hill J.N. 1999. "Kyoto Special Issue, Introduction and Overview", *The Energy Journal*, Special Issue, The Costs of the Kyoto Protocol: A Multi-Model Evaluation, May.
- Wilson, D., and J. Swisher. 1993. "Exploring the gap - Top-down versus bottom-up analyses of the cost of mitigating global warming," *Energy Policy*, March, pp. 249-263.
- World Bank. 1997. *Expanding the Measure of Wealth – Indicators of Environmentally Sustainable Development*, Washington, D.C.