



3-2012

HALO: Haptic Alerts for Low-hanging Obstacles in White Cane Navigation

Katherine J. Kuchenbecker
University of Pennsylvania, kuchenbe@seas.upenn.edu

Yunqing Wang
University of Pennsylvania

Follow this and additional works at: https://repository.upenn.edu/meam_papers

Recommended Citation

Kuchenbecker, Katherine J. and Wang, Yunqing, "HALO: Haptic Alerts for Low-hanging Obstacles in White Cane Navigation" (2012). *Departmental Papers (MEAM)*. 290.
https://repository.upenn.edu/meam_papers/290

Y. Wang, K. J. Kuchenbecker. *HALO: Haptic Alerts for Low-hanging Obstacles in white cane navigation*. In Proceedings, IEEE Haptics Symposium, 527-532, March 2012. doi: [10.1109/HAPTIC.2012.6183842](https://doi.org/10.1109/HAPTIC.2012.6183842)
© 2012 IEEE. Personal use of this material is permitted. Permission from IEEE must be obtained for all other uses, in any current or future media, including reprinting/republishing this material for advertising or promotional purposes, creating new collective works, for resale or redistribution to servers or lists, or reuse of any copyrighted component of this work in other works.

This paper is posted at ScholarlyCommons. https://repository.upenn.edu/meam_papers/290
For more information, please contact repository@pobox.upenn.edu.

HALO: Haptic Alerts for Low-hanging Obstacles in White Cane Navigation

Abstract

White canes give the visually impaired the freedom to travel independently in unknown environments, but they cannot warn the user of overhead hazards such as tree branches. This paper presents the development and evaluation of a device that provides haptic cues to warn a visually impaired user of low-hanging obstacles during white cane navigation. The Haptic Alerts for Low-hanging Obstacles (HALO) system is a portable and affordable attachment to traditional white canes. By pairing distance data acquired from an ultrasonic range sensor with vibration feedback delivered by an eccentric mass motor, the device aims to alert users of low-hanging obstacles without interfering with the standard functionality of a white cane. We conducted a preliminary validation study wherein twelve blindfolded subjects navigated a custom obstacle course with and without vibration alerts from HALO. The results showed that this new device is intuitive and highly effective at enabling the user to safely navigate around low-hanging obstacles.

Comments

Y. Wang, K. J. Kuchenbecker. *HALO: Haptic Alerts for Low-hanging Obstacles in white cane navigation*. In Proceedings, IEEE Haptics Symposium, 527-532, March 2012. doi: [10.1109/HAPTIC.2012.6183842](https://doi.org/10.1109/HAPTIC.2012.6183842)

© 2012 IEEE. Personal use of this material is permitted. Permission from IEEE must be obtained for all other uses, in any current or future media, including reprinting/republishing this material for advertising or promotional purposes, creating new collective works, for resale or redistribution to servers or lists, or reuse of any copyrighted component of this work in other works.

HALO: Haptic Alerts for Low-hanging Obstacles in White Cane Navigation

Yunqing Wang* and Katherine J. Kuchenbecker[§]

Haptics Group, GRASP Laboratory
Departments of Bioengineering and Mechanical Engineering and Applied Mechanics, University of Pennsylvania

ABSTRACT

White canes give the visually impaired the freedom to travel independently in unknown environments, but they cannot warn the user of overhead hazards such as tree branches. This paper presents the development and evaluation of a device that provides haptic cues to warn a visually impaired user of low-hanging obstacles during white cane navigation. The Haptic Alerts for Low-hanging Obstacles (HALO) system is a portable and affordable attachment to traditional white canes. By pairing distance data acquired from an ultrasonic range sensor with vibration feedback delivered by an eccentric mass motor, the device aims to alert users of low-hanging obstacles without interfering with the standard functionality of a white cane. We conducted a preliminary validation study wherein twelve blindfolded subjects navigated a custom obstacle course with and without vibration alerts from HALO. The results showed that this new device is intuitive and highly effective at enabling the user to safely navigate around low-hanging obstacles.

INDEX TERMS: H.5.1 [Information Interfaces and Presentation]: Multimedia Information Systems—Artificial, augmented, and virtual realities; H.5.2 [Information Interfaces and Presentation]: User Interfaces—Haptic I/O; K.4.2 [Computers and Society]: Social Issues—Assistive technologies for persons with disabilities

1 INTRODUCTION

Visual impairment is a surprisingly prevalent health problem among a significant population in the world. According to the World Health Organization (WHO), there are an estimated 314 million people globally who are visually impaired, 45 million of whom are blind [1]. Of these blind individuals, 90% live in low- and middle-income countries without access to sophisticated electronic navigation aids.

There are typically three main types of navigation aids used by the visually impaired: guide dogs, white canes, and electronic travel aids (ETAs) [2]. Of the three, guide dogs are the best at helping the user travel safely in unknown environments by not only detecting obstacles, but also steering around them. However, because it costs approximately \$42,000 to raise and train a guide dog [3], and because guide dogs have a working life of only from six to eight years [3], the number of available dogs is very limited. Furthermore, the strength and walking speed of the dog must be compatible with its owner [4], so a good match is not always guaranteed. In addition to the time, money, space, and effort needed to care for any animal, these factors make guide dogs a viable navigation aid for only a small portion of blind individuals.

As such, the majority of visually impaired individuals have adopted the use of a white cane to aid them in independent



Figure 1. A standard white cane fitted with the HALO system.

walking [2]. A cane's one-time cost of approximately \$40 is very reasonable, and it provides the user with a wealth of information regarding his or her immediate environment: the location of walls, the transition between different surfaces on the ground, and the presence of obstacles such as chairs, trash cans, and people. Not only does a white cane help the user in navigation, but it also provides a visual cue to others, informing them of the user's visual impairment. However, there are drawbacks to using a white cane. A long white cane can be unwieldy when using public transportation, or even indoors. Furthermore, while a white cane is adept at alerting users of impending ground-level obstacles, it offers no warning of low-hanging obstacles such as tree branches and open cabinet doors.

To try to overcome the shortcomings of guide dogs and white canes in navigation, some have turned to the use of ETAs. Lévesque [2] details many commercial ETAs including the Binaural Sensory Aid (SonicGuide), the Laser Cane, and the UltraCane. The SonicGuide uses an ultrasonic emitter attached between the lenses of a pair of glasses, with ultrasonic receivers at the temples of the frame. The difference in the signals at each of the receivers contains distance information, which is relayed to the user through a frequency-modulated auditory alert. The Laser Cane contains three lasers that scan different fields in the area ahead of the user, and each laser activates a different tone when it detects an obstacle. The UltraCane contains two ultrasonic sensors and alerts users of the location and distance of any obstacles through four vibrotactile motors located in the grip.

Beyond these commercial ETAs, several research groups [5] - [9] have also developed methods to aid the visually impaired in navigation. By attaching a pedometer, laser range finder, and three-axis gyroscope to a standard white cane, Hesch and Roumeliotis [5] were able to determine the heading and location

*e-mail: yunqing@seas.upenn.edu

[§]e-mail: kuchenbe@seas.upenn.edu

of the user. If individuals were traversing an environment with a known layout, it would then be possible to guide them around all obstacles. The GuideCane [6] combines robotics with mobility assistance by attaching a guidance device to the tip of the cane. Whenever the device's array of ultrasonic sensors detects an obstacle, it uses its servo driven wheels to steer the cane around the obstacle. Palleja et al. [7] developed an electronic white cane consisting of a wrist-mounted detector that uses a three-axis accelerometer and Light Detection and Ranging (LIDAR) sensors to jointly determine arm orientation and obstacle location; obstacle locations are conveyed to the user via a vibrotactile belt. In [8], shoulder-mounted ultrasonic sensors complement a third sensor located on a cane to provide information about obstacles, both overhead and ground level, via a synthetic speech output. Most recently, Gallo et al. [9] developed a custom white cane grip that uses ultrasonic sensors to detect both ground level and overhead obstacles. A haptic feedback system was integrated into the handle to notify the user of upcoming ground obstacles and provide distance information. An audio alert is used to warn the user of low-hanging obstacles. Clearly, many researchers have been motivated to create technology to facilitate independent navigation by the visually impaired.

Some of these systems aim to provide an alternative to the white cane, while others try to extend its range through forward-facing sensors. Although all of these devices can provide some benefit over a traditional white cane, none are strictly focused on what we believe to be one of the most important dangers of white cane navigation: head-level collisions with low-hanging obstacles. A technical report from the University of California, Santa Cruz [10] determined that low-hanging obstacles present a significant risk for the visually impaired. Out of 307 blind or legally blind individuals, 54% reported having head-level accidents once a year or more frequently. Of these accidents, 23% required medical attention and 43% resulted in users changing their walking habits (walking more slowly or raising their arms to protect their head whenever possible) [10]. The danger of low-hanging obstacles in an active urban area was also substantiated through extensive discussions with Suzanne Erb, a congenitally blind alumna of the University of Pennsylvania who is Chair of the Philadelphia Mayor's Commission on People with Disabilities. The creation of HALO is an attempt to lessen the danger of low-hanging obstacles in white cane navigation in an affordable, portable, and effective manner.

This paper describes the design, development, and testing of the HALO system. Section 2 details the rationale for its electrical and mechanical design, which underwent significant informal testing and refinement over the course of the project. Once we were satisfied with HALO's technical performance, we conducted the human subject experiment discussed in Section 3 to formally evaluate the system's effect on unsighted navigation in environments containing low-hanging obstacles. The paper concludes in Section 4 with a summary of contributions and suggestions for future work on this topic.

2 INSTRUMENTATION

As stated previously, the main benefits of using a white cane for navigation are that the cane provides the user with a great deal of navigationally relevant information in a simple and intuitive manner. In addition, the white cane is widely accessible, inexpensive, and easy to use. These benefits led us to develop HALO as a supplement to traditional white canes as opposed to a replacement. Furthermore, we aimed to design a system that is easily attachable to any cane instead of a separate device that needed to be held or mounted to the body. This design choice eliminates the need to calibrate the device to specific body types, and it ensures that the system is as unobtrusive to the user as

possible. With this goal in mind, we have designed an attachable device consisting of three main parts: an ultrasonic range sensor for obstacle detection, a shafted eccentric-mass motor for delivering vibrational alerts, and control circuitry to link the two.

2.1 Sensing

The two main factors that determined the type of sensor chosen for obstacle detection were price and robustness. Laser range sensors are excellent in acquiring accurate distance data, but their high cost outweighed their benefit. On the other hand, infrared emitter-detector pairs are inexpensive, but they are typically unreliable, especially outdoors. Ultrasonic range sensors proved to be a good compromise between cost and functionality. As shown in Fig. 2, the sensor chosen was the LV-Maxsonar-EZ4, by Maxbotix. It is small (2.2 x 2.0 x 1.5 cm) and lightweight (4.3 grams) for easy attachment to a cane. When powered by a regulated 5 V source, it has a reliable beam length of approximately 1.83 meters and a maximum beam width of 0.61 meters (at 1.83 meters). This beam length allows the sensor to detect obstacles from immediately in front of the sensor up to head level for users of all possible heights. The sensor is not mounted perpendicular to the cane, but is instead attached at a 30 degree incline so that when the cane is in use, the beam angles slightly forward from being normal to the ground. Because the user typically sweeps the cane in a left-right arc on the ground, this positioning guarantees that the narrow beam width of the sensor will only detect obstacles that are directly above the cane. This allows HALO to scan the same area as the tip of the cane, the only difference being that it detects low-hanging obstacles instead of ground-level ones.

The output of the sensor is an analog voltage reading that varies linearly with the distance to the nearest obstacle in the beam. This feature allows one to easily set the distance thresholds for haptic alerts, as described in Section 2.3.

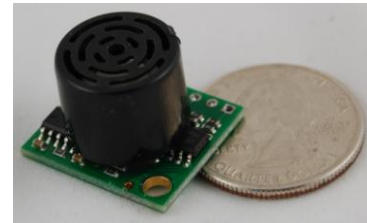

Figure 2. Ultrasonic range sensor by Maxbotix.

2.2 Haptic Alerts

Equally important to detecting low-hanging obstacles is a method for delivering this information to the user in a salient, intuitive, and discreet manner. As discussed in Section 1, auditory alarms are commonly used for warnings because they are simple and can convey significant information; however, this approach has several disadvantages when used in white cane navigation. Visually impaired individuals already strongly rely on their sense of hearing to gather information about their environment, such as the position and direction of motion of a passing car. Adding auditory cues for low-hanging obstacles could overload the sense and introduce new, unforeseen dangers. Ambient noise may also mask auditory alerts, removing the benefit of the detection system. In contrast, white cane users already treat the cane as an extension of their arm while navigating, using it to feel the texture of the surface and the location of any obstacles ahead. After reviewing the available options with Suzanne Erb, a representative potential user, we hypothesized that it would be most intuitive to users to be warned of overhead obstacles through

haptic alerts to the hand. Furthermore, this modality is private and discreet, unlike auditory cues, to avoid intruding on the auditory experience of the user and others around them.

Both shaftless (coin-type) and shafted eccentric-mass vibrating motors were tested as potential actuators. While the former are smaller and lighter, they generally require direct contact with the user's hand to deliver vibration alerts. Because different white cane users prefer different methods of gripping the cane, the motor would need to be relocated for each user, which complicates the design. Voice coil actuators such as the C2 were also removed from consideration after testing for this same reason. As an alternative, several different types of shafted eccentric-mass motor were mounted to the cane handle, and they were found to deliver stronger cues that did not vary much with changes in grip configuration. The motor chosen was an eccentric mass motor manufactured by Motorola, as shown in Fig. 3a. This particular model was selected for its small size, low current draw, and strong vibration feedback. With a diameter of 8 mm, length of 19 mm, and current draw of 0.4 A at 6 V, this motor was well suited for the purposes of the device. The motor spins at 9000 RPM (150 Hz), providing a vibratory cue that seemed to stand out from the accelerations felt in normal cane usage. To mount the motor to the cane, a custom housing was designed in SolidWorks and fabricated via 3D printing (Fig. 3b). It slides up the length of the cane from the tip until it reaches the grip, where it is held in place via a friction-fit.

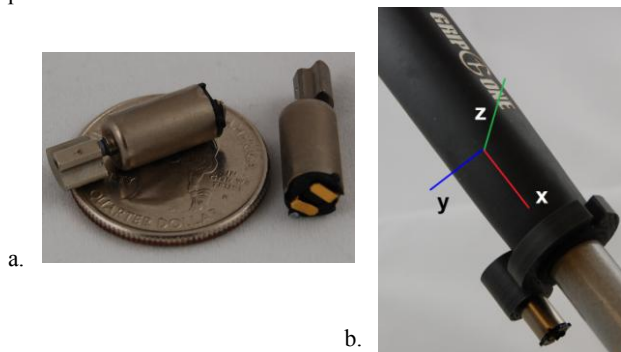

Figure 3. Shafted eccentric-mass vibration motor by Motorola.

To measure the vibration strength and salience of the vibration alert, we mounted a high-bandwidth MEMS-based accelerometer (STMicroelectronics LIS344ALH) to the grip of a white cane equipped with HALO. Tests were conducted on three common ground surfaces: hard floor, carpet, and sidewalk. For each surface, we used a National Instruments DAQ device to collect three ten-second recordings of accelerations in the y-axis of the cane being swept back and forth on the ground. As shown in Fig. 4, the first recording collected vibrations produced by the ground alone, the second recorded those produced when a ground-level obstacle was encountered, and the third introduced a low-hanging obstacle. In each plot, a horizontal line marks the instant when an obstacle was encountered. The fourth subplot of each figure shows a spectrogram of the vibration data from the test with a low-hanging obstacle, detailing the intensity of vibrations at varying frequencies over the ten second trial. These results match our qualitative experiences with HALO: its vibration alerts are straightforward to feel when using a cane on a variety of surfaces.

2.3 Control

To keep cost low, HALO does not require the use of an expensive microcontroller; the delivery of alerts in response to obstacles is controlled solely by a few extremely common and affordable analog circuit components: an LM393 comparator, an

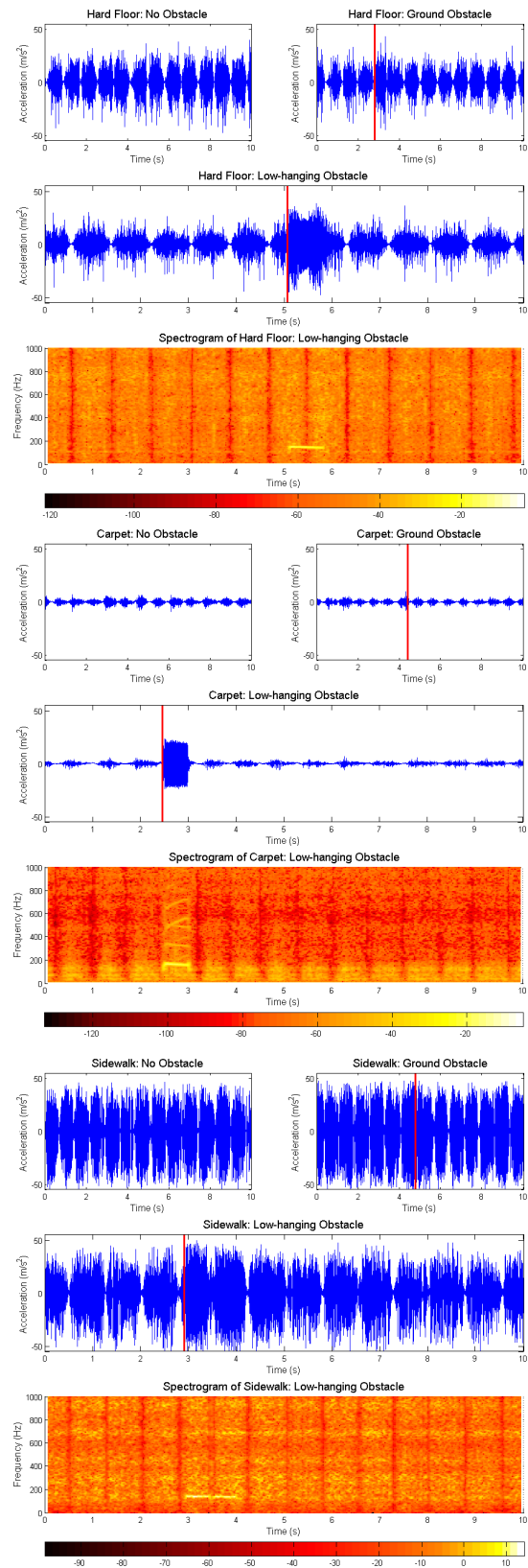

Figure 4. Acceleration recordings from the handle of a HALO equipped white cane. The user swept the cane along three different ground surfaces. The red vertical line shows the onset time of the specified obstacle. The vibration alert for the low-hanging obstacle is clearly visible in the spectrogram for all three surfaces.

LM555 timer, an L293D half-H motor driver IC with internal protection diodes, a TIP32 PNP transistor, and an LM7805 5-volt regulator. Additional electrical components include a potentiometer, five resistors, four capacitors, and a light-emitting diode (LED).

A user-adjustable knob controls the potentiometer, which in turn sets the distance at which a detected object is considered a low-hanging obstacle. This adjustability prevents the device from alerting the user of obstacles that are higher than the head, such as ceilings or high pipes. When the comparator detects that the sensor voltage is below the user-defined threshold, a trigger is sent to the LM555 timer to signal the presence of an obstacle.

The timer is set up in a retriggerable monostable mode that acts as a pulse extender. Using the circuit in the highlighted section of Fig. 5, a trigger of any duration under 0.5 s will produce a 0.5 s square wave output pulse. For longer triggers, the output pulse has the same duration as the trigger. The purpose of this pulse extender is to lengthen alerts that are too brief to be noticed, which could arise if the user sweeps the cane past an obstacle very quickly, or if the obstacle is narrow. Finally, this output pulse is passed to the eccentric-mass motor through the motor driver to vibrate the cane's handle. The timer output is also passed to an LED to provide a visual cue for those not using the cane, allowing for easier testing and evaluation of the system. All electrical elements were designed into a custom printed circuit board (PCB) for robustness. The system is powered by a set of four AA batteries mounted in two battery holders.

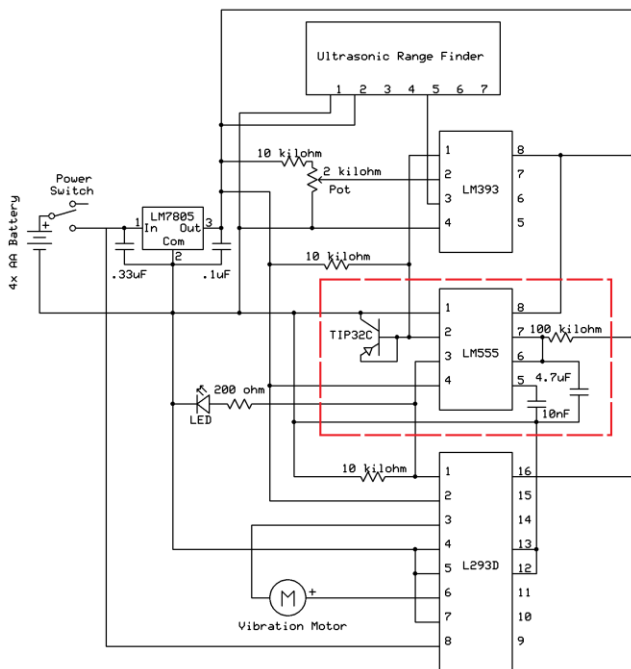

Figure 5. Circuit schematic for HALO. Highlighted section shows the LM555 timer configured in a retriggerable monostable mode.

2.4 Housing

To enclose and protect all of the electrical components, a custom case was designed in SolidWorks and constructed via 3D printing. We sought to minimize the size of the housing by locating the internal components as close to the shaft of the cane as possible. A custom U-channel was fabricated for the PCB and battery packs to attach to in order to simply assembly. The two pieces of the case are secured around the cane using four threaded fasteners. Fig. 6 shows a CAD rendering of an exploded view of the design.

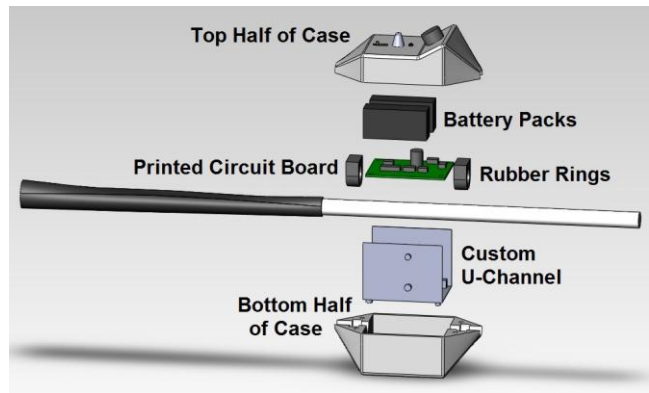

Figure 6. CAD rendering of the components of the device. The top half houses the power switch, height control knob, LED and ultrasonic range sensor. The battery packs and PCB are attached to the U-channel and secured to the bottom of the half of the case. The two halves are secured around the cane on two rubber rings to prevent the device from slipping off or rotating around the cane.

3 DEVICE EVALUATION

A human subject study was conducted to evaluate the effectiveness of the HALO system. We were particularly interested in its ability to detect low-hanging obstacles and alert the user in a manner that enables them to successfully avoid the hazard. Sighted subjects were used to test the initial merits of the approach. All procedures were approved by the University of Pennsylvania IRB under protocol #814096.

3.1 Materials and Methods

To evaluate the effectiveness of the device, a course containing simulated low-hanging obstacles was constructed (Fig. 7). Ten cardboard mailing tubes were hung from the walls of a long, straight hallway, spaced approximately three meters apart. The horizontal location of each obstacle was assigned by a MATLAB script that generated random course configurations. Each obstacle could occupy a position close to the left wall or close to the right wall. Furthermore, the mailing tubes were positioned in a way that ensured that each one would be encountered if a person walked directly down the middle of the hallway. With the exception of the protruding support columns along the right hand side of the wall, there were no ground level obstacles present.

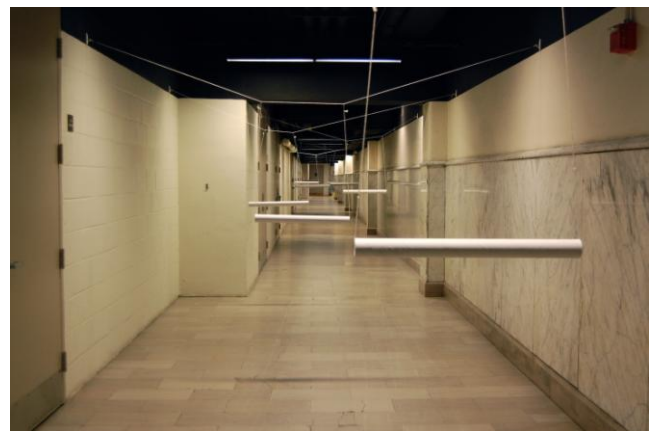

Figure 7. Custom course with ten low-hanging obstacles.

After a brief practice session of less than five minutes in a separate staging area, blindfolded volunteers were asked to use a properly sized HALO-equipped cane to navigate obstacle course four times: twice with and twice without the vibration alerts. The subject's goal was to navigate to the far end the hallway while avoiding obstacles as best as possible. This was a within-subject study wherein all the subjects performed the same activity. The only aspect that was varied between each subject was the order in which they experienced the vibration guidance. Half of the subjects performed their first two trials with vibration feedback and the second two trials without, while the other half had the opposite presentation order. Furthermore, the genders of the subjects were balanced so there was an even number of males and females in the two groups.

As a subject traversed the course, each simulated obstacle was recorded as "B" (Bypassed - subject was never in line to hit the obstacle), "A" (Actively Avoided - subject was on track to hit the obstacle, but moved out of the way upon nearing it), or "E" (Encountered - subject hit the obstacle). Upon completion of each trial, the subject was asked to walk back to the staging area so the course configuration could be changed. After each pair of trials, the subject was asked to rate their experience with the task using the NASA Task Load Index (NASA TLX) [11]. At the end of the study, subjects rated their preference between the two tested modes (with and without vibration alerts).

3.2 Results and Discussion

A total of 12 subjects aged 19 – 30 were recruited for the study, 8 males and 4 females. Three main outcomes were of interest in evaluating the success of the device: obstacle avoidance rate, course completion time, and qualitative feedback provided by each subject. We hypothesized that the addition of vibration alerts would cause users to take longer to complete the course due to the need to process additional information, but would avoid most, if not all, low-hanging obstacles. In addition, we wanted to determine whether the order of presentation impacted the results. We use $\alpha = 0.05$ to determine significance.

3.2.1 Obstacle Avoidance Rate

For each subject, the obstacle avoidance rate ρ was calculated for each trial as the proportion of obstacles that were avoided (A) out of those that were not bypassed (A+E), giving $0 \leq \rho \leq 1$. However, because success rate is a proportion and follows a binomial distribution, it was transformed before analysis to stabilize its variance, as dictated by standard practice [12]. Table 1 shows the mean and standard deviation for both raw and transformed obstacle avoidance rate. The overall average obstacle avoidance rate was 0.025 without vibration alerts and 0.925 with vibration alerts.

		First Trial		Second Trial	
		ρ	$\sin^{-1}(\sqrt{\rho})$	ρ	$\sin^{-1}(\sqrt{\rho})$
Vibration Alerts Off	\bar{y}	0.01	0.03	0.04	0.08
	(σ)	(0.03)	(0.10)	(0.10)	(0.20)
Vibration Alerts On	\bar{y}	0.89	1.33	0.96	1.47
	(σ)	(0.13)	(0.26)	(0.08)	(0.19)

Table 1. Chart of Success Rate for each Subject

A three-way ANOVA was run on the collected obstacle avoidance rate data with the factors of interest being: vibration

alerts (on or off), order (first or second trial of a set) and subject (1 through 12). Of these three factors, subject ($F(1,34) = 1.33, p < 0.25$) and order ($F(1,34) = 3.14, p < 0.09$) were not found to be significant. However the presence or absence of vibration alerts had a large, significant effect on the proportion of obstacles avoided ($F(1,33) = 620, p < 0.00001, \eta^2 = 0.923$). Order not having a significant impact on obstacle avoidance rate suggests that the system is intuitive to use, as subjects only needed a short training session to become proficient in its use. Furthermore, there was no significant difference between subjects asked to complete the course with vibration alerts first and those who completed the first two trials without vibration alerts. In addition, the small standard deviation of the data shows that all subjects performed similarly well with haptic alerts on suggesting that all users will be able to successfully avoid low-hanging obstacles with the use of HALO.

3.2.2 Course Completion Time

The time to complete each trial was also analyzed. Completion time was recorded as the time the subject took to navigate from the beginning of the course to the tenth obstacle. As soon as the subject either encountered, avoided or bypassed the last obstacle, the experimenter stopped the timer. A graph of completion times can be seen in Fig. 8. The times for each set of trials are shown stacked to present total times for completing the course with and without vibration alerts. The average completion time was 89.6 seconds without vibration alerts and 159.4 with vibration alerts with standard deviations of 38.0 and 64.8 seconds, respectively.

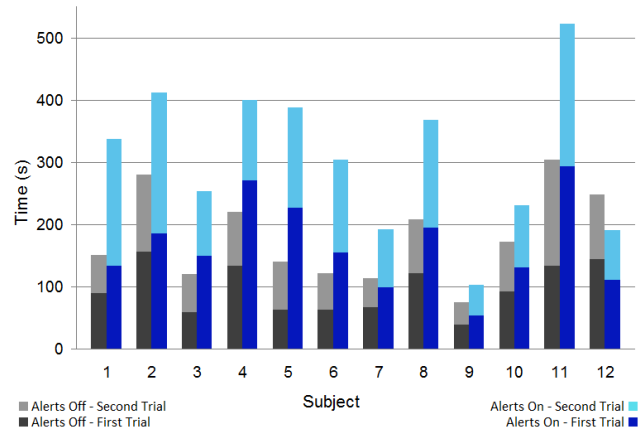

Figure 8. Course completion time per subject.

Statistical analysis was performed on the data to determine which factors significantly affected course completion time. Of the three factors tested previously, vibration alert mode ($F(1,34) = 42.35, p < 0.00001, \eta^2 = 0.276$) and subject ($F(1,34) = 6.67, p < 0.00001, \eta^2 = 0.479$) were significant, whereas order ($F(1,34) = 3.48, p < 0.07$) was not. Throughout the study, these results were also apparent. Without vibration alerts, most subjects immediately realized they had no method of detecting obstacles before encountering them, so they moved quickly through the course. When vibration alerts were activated, the subjects suddenly had access to information regarding these low-hanging obstacles. The majority of them slowed their pace in order to acclimate to and process this new information. Furthermore, each subject had a preferred walking speed and caution level that carried through both sets of trials. As a result of these two factors, the both presence of vibration alerts and the identity of the subject showed significant effects on the course completion time.

3.2.3 User Preference

In addition to the previous quantitative data gathered, users were also asked to rate their experience in doing the task with and without vibration alerts. Using the NASA TLX, subjects were asked to rate their mental demand, physical demand, temporal demand, performance, effort, and frustration. In addition, subjects were asked to rate their preference for completing the task either with or without haptic feedback. Each of these factors was broken down into 20 gradations. The results of these surveys can be seen in Fig. 9.

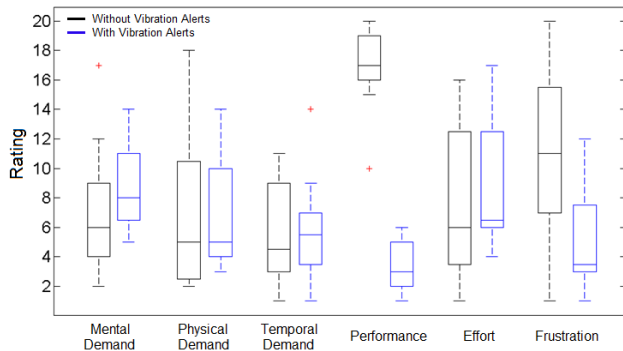

Figure 9. User evaluation results. The rating is on a scale of 1 – 20, where one (1) represents no mental, physical or temporal demand, perfect perceived performance, no effort needed to complete the task and a complete lack of frustration.

On the scale, a rating of one represents no mental, physical, or temporal demand, perfect perceived performance, no effort needed to complete the task, and a complete lack of frustration. Thus smaller numerical scores generally signify an easier task. As seen in Fig. 8, physical and temporal demand did not vary much between the two sets. However, users rated both mental demand and required effort as being higher when vibration alerts were present. From the comments, this was understood to stem from the addition of information regarding low-hanging obstacles. Users had to focus more in order process this information to successfully avoid the obstacles. However, this increased effort resulted in much better performance and lower frustration in completing the obstacle course. After subjects completed both sets of trials and NASA TLX rating forms, they were asked to rate which system they preferred to use for navigation in areas with potential low-hanging obstacles. To keep continuity with the NASA TLX, this preference was also rated on a scale of 1 – 20, where one (1) represents a strong preference for a white cane with HALO providing haptic feedback and twenty (20) represents a strong preference for a standard white cane with no feedback, the average preference rating was 1.83, with a standard deviation of 0.94, indicating an overwhelming preference towards having vibration alerts for low-hanging obstacles.

4 CONCLUSION AND FUTURE WORK

This paper details the creation and preliminary evaluation of a device that aims to improve the safety of independent navigation by visually impaired individuals. The device we constructed can easily attach to most white canes used for navigation. It integrates an ultrasonic range sensor with an eccentric-mass vibrating motor to detect and alert the user of potentially hazardous low-hanging obstacles. A human subject study was conducted to evaluate the device in a challenging task. HALO was found to be hugely successful in these experimental conditions. All twelve participants were able to almost completely avoid low-hanging obstacles they would otherwise have encountered. Furthermore,

their qualitative feedback suggests that the use of the device was intuitive and a welcome addition to blind navigation.

Two subjects commented that HALO was somewhat heavy on the cane. To improve upon this version, other battery options should be tested to reduce the size and weight of the device. Currently, the device is powered by four AA batteries, which contribute half of the weight of the device as well as the majority of the bulk. The use of lithium polymer batteries would greatly reduce both the size and weight of HALO. In addition, a study should be conducted using blind individuals instead of sighted ones. Such a study will provide insight into whether or not the device will be useful to its target population. Nonetheless, the data gathered from sighted participants suggest that HALO shows promise in helping the visually impaired more safely navigate through areas that contain potential low-hanging obstacles

5 ACKNOWLEDGEMENTS

The authors thank Suzanne Erb for sharing valuable advice throughout this project; Eza Koch and Ben Goodman for their help in the mechanical design and manufacturing of the HALO case; and Theparit Perrasathien, Dheeraj Chandrashekar, and Huan Zhu for helping design an early prototype of the presented device.

REFERENCES

- [1] World Health Organization. *Action plan for the prevention of avoidable blindness and visual impairment, 2009-2013* [Online]. Available: http://www.who.int/blindness/ACTION_PLAN_WHA62-1-English.pdf
- [2] V. Lévesque, “Blindness, Technology and Haptics,” Haptics Laboratory, Centre Intell. Mach., McGill Univ., Montréal, Québec, Canada, Tech. Rep., 2005.
- [3] Guide Dogs of America. *FAQ* [Online]. Available: <http://www.guidedogsofamerica.org/1/mission/>
- [4] The Seeing Eye. *2010 Annual Report: The Match* [Online]. Available: <http://www.seeingeye.org/images/publications/ar2010.pdf>
- [5] J. A. Hesch and S. I. Roumeliotis, “An Indoor Localization Aid for the Visually Impaired,” in *Proc. Int. IEEE Conf. Robotics and Automation*, Roma, Italy, April 2007, pp. 3545-3551.
- [6] I. Ulrich and J. Borenstein, “The GuideCane – Applying Mobile Robot Technologies to Assist the Visually Impaired,” *IEEE Trans. Sys., Man Cybern. A., Syst. Humans*, Vol. 31, No. 2, Mar. 2001, pp. 131-136.
- [7] T. Pallejà et al., “Bioinspired Electronic White Cane Implementation Based on a LIDAR, a Tri-Axial Accelerometer and a Tactile Belt,” *Sensors*, vol. 10, pp. 11322-11339, Dec. 2010.
- [8] M. Bousbia-Salah et al., “A Navigation Aid for Blind People,” *J. Intell. Robot Syst.*, May 2011.
- [9] S. Gallo et al., “Augmented White Cane with Multimodal Haptic Feedback,” in *Proc. 2010 3rd IEEE RAS & EMBS Int. Conf. Biomedical Robotics and Biomechanics*, Tokyo, Japan, 2010.
- [10] R. Manduchi and S. Kurniawan, “Watch your Head, Mind Your Step: Mobility-Related Accidents Experienced by People with Visual Impairment,” Dept. Comp. Eng., Univ. California, Santa Cruz, Tech. Rep., 2010.
- [11] S. G. Hart and L. E. Staveland, “Development of NASA-TLX (Task Load Index): Results of Empirical and Theoretical Research,” in *Human Mental Workload*, Elsevier, Amsterdam: North Holland Press, 1988, pp.239-250.
- [12] W. Mendenhall and T. Sincich, *Statistics for Engineering and the Sciences*, 4th ed. Prentice Hall, 1995, ch. 12, p.652.