

HAMILTON PATHS IN GRID GRAPHS*

ALON ITAI†, CHRISTOS H. PAPADIMITRIOU‡ AND JAYME LUIZ SZWARCFITER§

Abstract. A grid graph is a node-induced finite subgraph of the infinite grid. It is rectangular if its set of nodes is the product of two intervals. Given a rectangular grid graph and two of its nodes, we give necessary and sufficient conditions for the graph to have a Hamilton path between these two nodes. In contrast, the Hamilton path (and circuit) problem for general grid graphs is shown to be NP-complete. This provides a new, relatively simple, proof of the result that the Euclidean traveling salesman problem is NP-complete.

Key words. Hamilton circuit, Hamilton path, grid graphs, rectangular grid graphs, NP-complete problem, Euclidean traveling salesman problem

1. Introduction. Let G^∞ be the infinite graph whose vertex set consists of all points of the plane with integer coordinates and in which two vertices are connected if and only if the (Euclidean) distance between them is equal to 1. A *grid graph* is a finite, node-induced subgraph of G^∞ . Thus, a grid graph is completely specified by its vertex set. Let v_x and v_y be the *coordinates* of the vertex v . We say that vertex v is *even* if $v_x + v_y \equiv 0 \pmod{2}$; otherwise, v is *odd*. It is immediate that all grid graphs are bipartite, with the edges connecting even and odd vertices.

Let $R(m, n)$ be the grid graph whose vertex set is $V(R(m, n)) = \{v : 1 \leq v_x \leq m \text{ and } 1 \leq v_y \leq n\}$. A *rectangular graph* is a grid graph which, for some m and n , is isomorphic to $R(m, n)$. Thus m and n , the *dimensions*, specify a rectangular graph up to isomorphism.

Let s and t be distinct vertices of a graph G . We say that the *Hamilton path problem* (G, s, t) has a solution if there exists a Hamilton path from s to t in G . In this paper we examine the Hamilton path problem for grid graphs; rectangular grid graphs were examined first in [LM]. In § 2 we show that the Hamilton path and Hamilton circuit problems for general grid graphs are NP-complete. Consider now a bipartite graph $B = (V^0 \cup V^1, E)$. If $|V^0| = |V^1| + 1$, then all Hamilton paths of B must start and end at vertices of V^0 . If $(R(m, n), s, t)$, with $m \times n$ odd, has a solution, then the number of even vertices is greater by one than that of the odd vertices. Hence, a necessary condition for the solvability of $(R(m, n), s, t)$ is that both s and t be even. In § 3 it is shown that this condition is also *sufficient* for nontrivial (i.e., $m, n > 1$) odd rectangular graphs. If $m \times n$ is even, then a solution is possible only if s and t have different parity. However, this condition is not sufficient. There are three families of configurations for which even though s and t have different parity $(R(m, n), s, t)$ has no solution. In § 3 we give the precise necessary and sufficient conditions for a Hamilton path problem to have a solution. Partial results in this direction were first proved in [LM].

* Received by the editors September 22, 1980, and in final form August 25, 1981.

† Department of Computer Science, Technion, Haifa, Israel. Part of this work was conducted while this author was visiting the Electrical Engineering and Computer Science Department, University of California at Berkeley, and the Laboratory for Computer Science, Massachusetts Institute of Technology.

‡ Laboratory for Computer Science, Massachusetts Institute of Technology, Cambridge, Massachusetts 02139, and National Technical University of Athens, Greece. The work of this author was supported by the National Science Foundation under grant MCS 76-01193.

§ Universidade Federal do Rio de Janeiro, Brasil. Present address: Computer Science Division, University of California, Berkeley, California 94720. The work of this author was supported by the Conselho Nacional de Desenvolvimento Científico e Tecnológico (CNPq), Brasil, processo 574/78.

2. NP-completeness. Before showing that finding Hamilton paths and circuits in grid graphs is NP-complete, we first show several lemmas:

LEMMA 2.1. *The Hamilton circuit problem for planar bipartite graphs with maximum degree 3 is NP-complete.*

Proof. The Hamilton circuit problem is NP-complete for planar digraphs such that for all vertices v :

$$\text{indegree}(v) + \text{outdegree}(v) = 3 \quad (\text{see [GJ], [P]}).$$

To prove the lemma, we conduct for all vertices v the appropriate transformation as illustrated in Fig. 2.1. The resulting graph is planar (the digraph was), bipartite and has maximum degree less than or equal to 3. \square

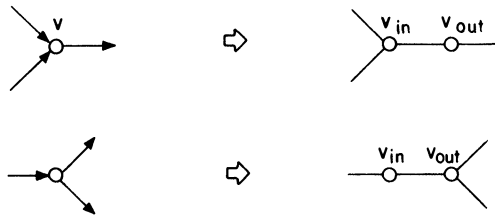

FIG. 2.1

Let $B = (V^0 \cup V^1, E)$ be a bipartite graph, G_1 a rectangular grid graph and let emb be a one-to-one function from $V^0 \cup V^1$ to the vertices of G_1 and from E to paths in G_1 . We say that emb is a *parity-preserving embedding* of B into G_1 if:

1. The vertices V^0 are mapped to even vertices of G_1 . (If $v \in V^0$, then $\text{emb}(v)$ is even.)
2. The vertices of V^1 are mapped to odd vertices of G_1 . (If $v \in V^1$, $\text{emb}(v)$ is odd.)
3. The edges of B are mapped to vertex-disjoint (except perhaps for endpoints) paths of G_1 (i.e., if $vu \in E(B)$, then $\text{emb}(vu)$ is a path P from $\text{emb}(v)$ to $\text{emb}(u)$, and the intermediate vertices of P do not belong to any other path).

See Fig. 2.2 for an example of a parity-preserving embedding.

LEMMA 2.2. *If B is a bipartite planar graph with n vertices and maximum degree 3, then we can construct in polynomial time a parity preserving embedding of B into a rectangular graph $R(kn, kn)$ (for some constant k).*

Proof. It is a quite well-known and straightforward result (see, for example, [S], [V]) that all cubic planar graphs with n nodes can be embedded in $R(n, n)$. Our extra requirement, preserving parity, can be accommodated by multiplying the scale by 3 and moving the vertices “locally” as in Fig. 2.3. \square

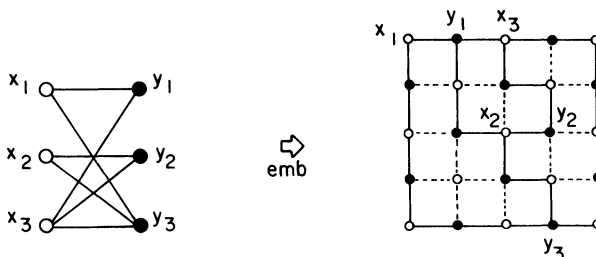

FIG. 2.2

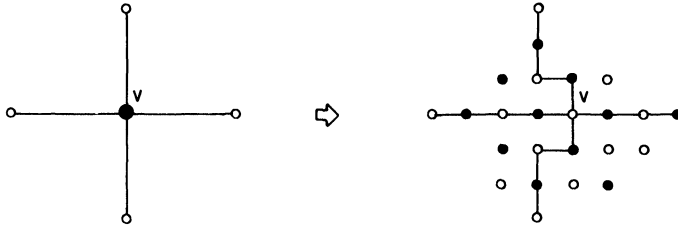

FIG. 2.3

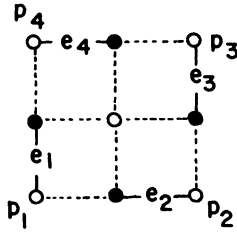

FIG. 2.4

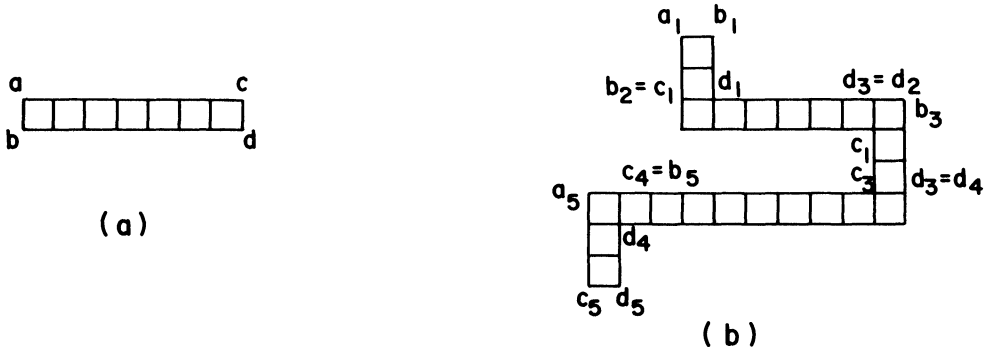

FIG. 2.5

To show NP-completeness of the Hamilton circuit problem for grid graphs, we shall transform an arbitrary planar, bipartite, cubic graph B into a grid graph. Each vertex of B will correspond to a 9-cluster, the nine vertices of a square of size 2 (Fig. 2.4).

LEMMA 2.3. *Let C_9 be a 9-cluster, as in Fig. 2.4. Then for all $1 \leq i < j \leq 4$, there exists a Hamilton path from p_i to p_j which contains all four edges $\{e_1, e_2, e_3, e_4\}$.*

Proof. By inspection. \square

A strip is a rectangular graph with minimum dimension 2 (Fig. 2.5a). The strip with corners a, b, c, d (a is adjacent to b and c is adjacent to d) is denoted $S(a, b; c, d)$.

A tentacle T is a grid graph which is a union of a series of strips,

$$T: S(a_1, b_1; c_1, d_1) \cup S(a_2, b_2; c_2, d_2) \cup \dots \cup S(a_k, b_k; c_k, d_k),$$

such that both

$$c_i, d_i \in V(S(a_{i+1}, b_{i+1}; c_{i+1}, d_{i+1})), \quad i = 1, \dots, k - 1$$

and one of

$$a_{i+1}, b_{i+1} \in V(S(a_i, b_i; c_i, d_i)), \quad i = 1, \dots, k-1;$$

there is no other intersection between the vertex sets of the strips; and each edge of T belongs to one of the S 's.

From the definition the overlap must be in the corners of the strips as in Fig. 2.5a.

The vertices a_1, b_1, c_k, d_k are the *corners* of T .

LEMMA 2.4. *Let s and t be corners of a tentacle T . There is a HP from s to t in T if and only if s and t have different parity.*

Proof. By an easy induction on the number of strips. \square

THEOREM 2.1. *The Hamilton circuit problem for grid graphs is NP-complete.*

Proof. Given a planar, degree ≤ 3 , bipartite graph B , we shall construct a grid graph G_9 such that G_9 has a Hamilton circuit if and only if there exists a Hamilton circuit in B .

First we embed B in a grid graph G_1 , as in Lemma 2.2. The graph G_9 will be an induced subgraph of the grid resulting by multiplying the scale of G_1 by 9. Each image of a vertex $w = (w_x, w_y)$ of B corresponds to the following 9-cluster of G_9 :

$$\{z \mid w_x \leq z_x \leq w_x + 2, w_y \leq z_y \leq w_y + 2\}.$$

The edges of B are simulated by tentacles. Suppose vu is an edge leading from $v \in V^0(B)$ to $u \in V^1(B)$. Consider the path in G_1 corresponding to vu . G_9 will include the blown up image of this path and another layer to obtain a tentacle. Some care must be taken as to how the tentacle is connected to the 9-clusters corresponding to v and u . By the construction the corners of the 9-cluster corresponding to v are all even. If in G_1 vu leaves v from below, then the corresponding tentacle is connected as in Fig. 2.6a (recall that v is even). The other cases are symmetric (just rotate the figure $90^\circ, 180^\circ$ or 270°). Since u is odd the connection is completed as in Fig. 2.6b. This concludes the description of G_9 . An example is shown in Fig. 2.8.

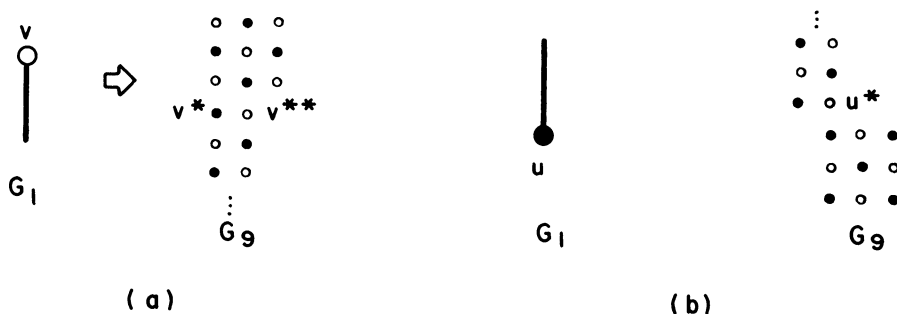

FIG. 2.6

By Lemma 2.4 a tentacle T_{uv} can be covered by two Hamilton paths: the *cross* path from v^* to u^* (Fig. 2.7a) and the *return* path from v^* to v^{**} (Fig. 2.7b).

The following two claims complete the proof of the theorem.

CLAIM 1. *Let HC_B be a Hamilton circuit in B . Then there exists a Hamilton circuit HC_9 in G_9 .*

Proof. HC_9 is constructed as follows: If $vu \in HC_B$, the tentacle T_{uv} is covered in HC_9 by a cross path; otherwise, it is covered by a return path. The clusters themselves



are covered as in Lemma 2.3. The partial paths can be connected to constitute a Hamilton circuit. (Some edges of type e_i in Fig. 2.4 must be deleted.)

CLAIM 2. *If HC_9 is a Hamilton circuit in G_9 , then there exists a Hamilton circuit HC_B in B .*

Proof. By construction each tentacle T_{vu} is covered either by a cross path or by a return path (connected to v). C_B consists of all edges corresponding to tentacles covered by cross paths. This is a Hamilton circuit because each 9-cluster cannot be covered by HC_B unless it is incident upon exactly two cross paths. \square

COROLLARY 1. *The Hamilton path problem for grid graphs is NP-complete.*

Proof. Reduction from the Hamilton circuit problem for grid graphs. Let G be a grid graph without degree-1 nodes. Since it is finite, it must have a vertex s of degree 2. Let t be any of the neighbors of s . Then (G, s, t) has a solution if and only if G has a Hamilton circuit. \square

By adding two nodes of degree 1 to G , we may also conclude that the Hamilton path problem without specified endpoints is NP-complete.

A *rectangular subgrid graph* is a subgraph (not necessarily induced) of G^∞ that has $V(R(m, n))$ as its vertices for some $m, n > 0$.

COROLLARY 2. *The Hamilton circuit and path problems for rectangular subgrid graphs are NP-complete.*

Sketch of proof. The grid graph constructed in the proof of the theorem may be considered as a rectangular one minus certain ‘‘holes’’. We can now ‘‘fill’’ these holes with long paths so as to transform the graph into a rectangular *subgrid* one. \square

The Euclidean version of the traveling salesman problem was proved NP-complete in [Pa]. It is interesting, however, to notice that the Hamilton circuit problem for grid graphs is a *special case* of the Euclidean traveling salesman problem, with cities the nodes of the grid graph and with length of the tour equal to the number of nodes. We therefore have:

COROLLARY 3. *The Euclidean traveling salesman problem is NP-complete.*

We notice that this proof is much simpler than that in [Pa]. It also avoids an annoying complication having to do with the precision in which the distances are calculated (see [Pa]).

3. Hamilton path problems in rectangular graphs.

3.1. Necessary conditions. Let $B = (V^0 \cup V^1, E)$ be a bipartite graph with $|V^0| \geq |V^1|$. We will think of the vertices of B as colored by two colors, black and white. All the vertices of V^0 will be colored by one color, the *majority color*, and the vertices V^1 by the *minority color*.

The Hamilton path problem (B, s, t) is *color compatible* if

- (1) B is even ($|V^0| = |V^1|$) and s and t have different color or
- (2) B is odd ($|V^0| = |V^1| + 1$) and s and t are colored by the majority color (i.e., $s, t \in V^0$).

Since the vertices of any Hamilton path alternate between the two colors, color compatibility is a necessary condition for the existence of a Hamilton path. Another source of necessary conditions arises from the connectivity of the graph. If s or t is a separating vertex (i.e., $G - \{s\}$ or $G - \{t\}$ is not connected), then there exists no s, t Hamilton path in G . For rectangular graphs this implies the following conditions for the graph to have no s, t Hamilton path.

(F1) G is a 1-rectangle, and either s or t is not a corner (Fig. 3.1a).

Also, no s, t Hamilton path exists if $\{s, t\}$ is a separating pair, i.e., $G - \{s, t\}$ is not connected. For rectangular graphs this implies

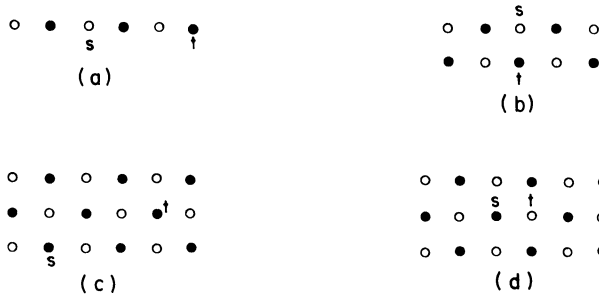

FIG. 3.1

(F2) G is a 2-rectangle, and st is a nonboundary edge (i.e., st is an edge, and it is not on the outermost face, see Fig. 3.1b).

Consider Fig. 3.1c or 3.1d. The vertices s and t are color compatible, the connectivity is greater than two, but still there is no s, t Hamilton path. These cases can be generalized to yield the following condition:

(F3) (G, s, t) is isomorphic to (G', s', t') which satisfies:

1. $G' = R(m, n)$ with $n = 3$ and m even.
2. s' is colored differently from t' and the left corners of G' .
3. $s'_x < t'_x - 1$ (Fig. 3.1c) or $s'_y = 2$ and $s'_x < t'_x$ (Fig. 3.1d).

A Hamilton path problem (G, s, t) is *forbidden* if it satisfies one of the conditions (F1), (F2) and (F3).

LEMMA 3.1. *If (G, s, t) is forbidden, then there exists no Hamilton path from s to t in G .*

The proof is a straightforward case analysis. \square

We summarize this section with the following definition and theorem:

A Hamilton path problem (G, s, t) is *acceptable* if it is color compatible and not forbidden.

THEOREM 3.1. *If there exists an s, t Hamilton path in G , then (G, s, t) is acceptable.*

3.2. Sufficient conditions. In this section it is shown that all acceptable HP problems have solutions (i.e., acceptability is sufficient). The method of proof is to break large acceptable HP problems into disjoint acceptable subproblems, the HPs of which can be used to construct an HP for the original problem. The two methods, *stripping* and *splitting*, are discussed in the following subsection. We will be done if we show that for prime problems (those which cannot be stripped or split) acceptability implies solvability. However, since the size of these problems is small, their number is finite and can be handled by a case analysis (§ 3.2.2).

3.2.1. Stripping and splitting. A *separation* of a rectangle R is a partition of R into two subrectangles, i.e., $V(R)$ is a disjoint union of $V(R_1)$ and $V(R_2)$.

A strip S *strips* a Hamilton path problem (R, s, t) if

1. $S, R - S$ is a separation of R ,
2. $s, t \in R - S$,
3. $(R - S, s, t)$ is acceptable.

LEMMA 3.2.1. *Let (R, s, t) be an acceptable Hamilton path problem and S strips R . If $(R - S, s, t)$ has a solution, then (R, s, t) also has a solution.*

Proof. Let P be a Hamilton path of $R - S$. Then there exists an edge $pq \in P$ such that pq is on the boundary of $R - S$ facing S . A Hamilton path for (R, s, t) can be obtained by the construction illustrated in Fig. 3.2. \square

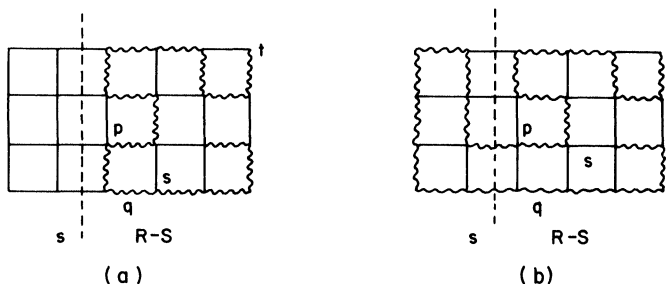

FIG. 3.2

Let $R(m, n)$ be a rectangle with $m \geq n$. $v, w \in V(R(m, n))$ are called *antipodes* if $v_x \leq 2$ and $w_x \geq m - 1$.

LEMMA 3.2.2. *Let $(R(m, n), s, t)$ be an acceptable Hamilton path problem which cannot be stripped (by any strip S) and $2 \leq n \leq m(n, m) \neq (4, 5), (4, 4)$. Then s and t are antipodes.*

Proof. Without loss of generality, let $s_x \leq t_x$. Let S be the leftmost strip of R (i.e., $V(S) = \{v \in V(R) : v_x \leq 2\}$). It suffices to show that $s \in S$. Assume to the contrary that $s \notin S$. Let $H_{s,t}$ be the rectangle resulting from deleting S from R . A contradiction will be obtained if $(H_{s,t}, s, t)$ is acceptable. Note that $(H_{s,t}, s, t)$ is color compatible. Now we must show that it is not forbidden.

Case 1. $n \times m$ is odd. $H_{s,t}$ is also odd, so it cannot be forbidden.

Case 2. $m > 5, n > 3$. Both the dimensions of $H_{s,t}$ are greater than 3, so it cannot be forbidden.

Case 3. $n = 3, m > 5$. If $(H_{s,t}, s, t)$ is forbidden, it must be F3, but then so is (R, s, t) .

Case 4. $n = 2$. Since (R, s, t) is not forbidden, neither is $(H_{s,t}, s, t)$. Note that if $m = 5, (H_{s,t}, s, t)$ may be F3, but in this case (R, s, t) is F2.

Case 5. $m = 4, n = 3$. The only possibility for $(H_{s,t}, s, t)$ to be forbidden is depicted in Fig. 3.3b. However, then (R, s, t) satisfies F3. \square

Let (R, s, t) be an acceptable Hamilton path problem and pq an edge. pq splits (R, s, t) if there exists a separation of R to R_p and R_q such that:

1. $s, p \in R_p$ and (R_p, s, p) is acceptable, and
2. $q, t \in R_q$ and (R_q, q, t) is acceptable.

The following lemma follows immediately from the definition of splitting.

LEMMA 3.2.3. *Let pq be an edge which splits (R, s, t) . If both (R_p, s, p) and (R_q, q, t) have a solution, then so does (R, s, t) .*

3.2.2. Prime problems. A Hamilton path problem (R, s, t) is *prime* if it cannot be stripped or split. The following lemma allows us to confine the discussion to a finite number of cases.

LEMMA 3.2.4. *Let $(R(m, n), s, t)$ be an acceptable prime Hamilton path problem, then $(n, m) = (4, 5)$ or $n, m \leq 3$.*



FIG. 3.3

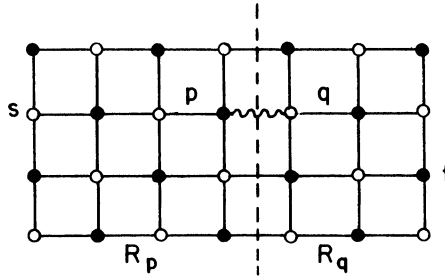

FIG. 3.4

Proof. Assume first that $(n, m) \notin \{(4, 4), (4, 5)\}$. Then s and t are antipodes. Let S be the leftmost strip, then $s \in S$. We show that there exists a split such that $R_p = S$.

Case 1. $m > 5, n \geq 4$. There are at least two vertices, v^i , with $v_x^i = 2, i = 1, 2$ and colored differently than s . Let p be a v^i not connected to s by a nonboundary edge of S and q be the adjacent vertex in $R - S$. The edge pq splits $R: R_p = S$, and (R_p, s, p) is acceptable by the construction. As for $(R_q, q, t), q \neq t$, since $t_x \geq m - 1 > 3 = q_x$; since s and q have the same color, (R_q, q, t) is color compatible; R_q has dimensions $(m - 2, n) > 3$; hence, (R_q, q, t) is not forbidden and, therefore, is acceptable.

Case 2. $m > 5, n = 3$ (Fig. 3.5a). Without loss of generality, the left corners of R are white. Let $p = (2, 1)$ and $q = (3, 1)$. We show that edge pq splits (R, s, t) . Note that p is black and q is white. If m is even, then s is white and t black; otherwise (R, s, t) is not acceptable. Therefore $p \neq s$ and $q \neq t$. Consequently (R_p, s, p) and (R_q, q, t) are color compatible. If m is odd, then both s, t are white. Therefore $p \neq s$, and because $q_x = 3 < t_x$, also $q \neq t$. Again, (R_p, s, p) and (R_q, q, t) are color compatible. In both cases p is a corner of R_p and q a corner of R_q . Hence, the subproblems are not forbidden.

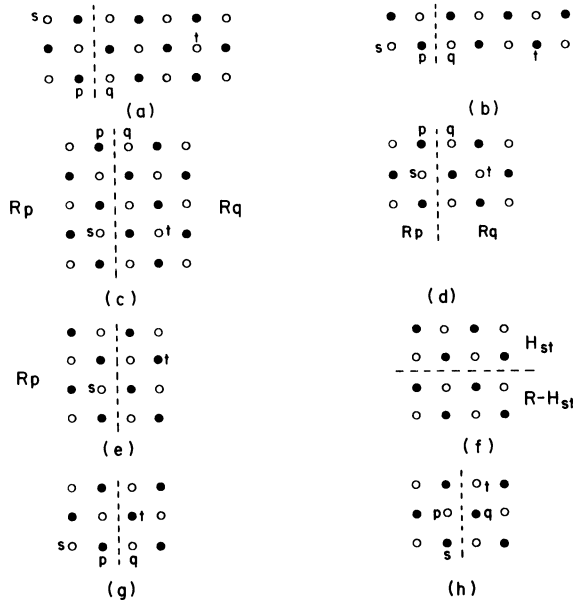

FIG. 3.5

Case 3. $n = 3$ (Fig. 3.5b). Without loss of generality s is white. The edge $pq = (2, 1)(3, 1)$ splits (R, s, t) $q \neq t$ since q is white and t is black.

Case 4. $m = 5, n = 5$ (Fig. 3.5c). Let p be a black vertex not connected to s such that $p_x = 2, q = (p_x + 1, p_y)$. Since R_q is odd, pq splits (R, s, t) .

Case 5. $m = 5, n = 3$ (Fig. 3.5d). Similar to Case 4.

Case 6. $m = 4, n = 4$. If s and t are antipodes, then either $(2, 1)(3, 1)$ or $(2, 4)(3, 4)$ splits (R, s, t) (Fig. 3.5e). If s and t are not antipodes, we may assume that $s_x s_y, t_x, t_y \leq 2$. Therefore, either the rightmost or the uppermost strip may be stripped off (R, s, t) (Fig. 3.5f).

Case 7. $m = 4, n = 3$.

If s is white, then $pq = (2, 1)(3, 1)$ splits (R, s, t) (Fig. 3.5g). Otherwise, s is black and $s_x = 2, t_x = 3$. Therefore, $(2, 2)(3, 2)$ splits (R, s, t) (Fig. 3.5h). \square

LEMMA 3.2.5. Any $(R(5, 4), s, t)$ acceptable Hamilton path problem is solvable.

Proof. It suffices to prove the lemma for prime problems. First, s and t cannot be antipodes. If they were, either edge, $(2, 1)(3, 1)$ or $(2, 4)(3, 4)$, splits (R, s, t) . We can then assume that both s, t do not belong, say, to the rightmost strip. Now, if one of s, t belongs to the lowermost strip and the other to the uppermost, then either edge $(4, 2)(4, 3)$ or $(5, 2)(5, 3)$ splits (R, s, t) . Therefore without loss of generality we can restrict to the case $s_x, t_x \leq 3$ and $s_y, t_y \leq 2$. Then the rightmost strip can be stripped off, except when (R, s, t) is isomorphic to the problem of Fig. 3.6. That is a prime problem, solvable as indicated in the figure.

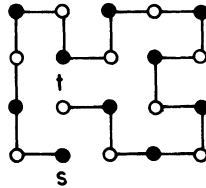
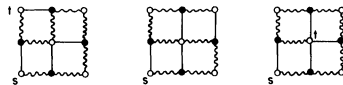

FIG. 3.6

LEMMA 3.2.6. If (R, s, t) is an acceptable prime Hamilton path problem, then it is solvable.

Proof. From Lemmas 3.2.4 and 3.2.5, we may assume that $n, m \leq 3$. For all values of m and n , all nonisomorphic problems and their corresponding paths are illustrated in Fig. 3.6.

Case 1. $m = n = 3$.



Case 2. $n = 2, m = 3$.



Case 3. $n = 2, m = 2$.



Following the discussion at the beginning of this section, the preceding lemmas yield the following:

THEOREM 3.2. *There exists a Hamilton path from s to t in R if and only if (R, s, t) is acceptable.*

3.3. An algorithm. The proof of Theorem 3.2 is constructive. To decide whether a Hamilton path problem $(R(n, m), s, t)$ has a solution, we check whether it is acceptable. This requires time linear with the representation of n, m, s and t . To find the path itself, we first try to strip off the strips, constructing partial paths, and try to split the problem. This process is repeated until we are left with prime problems, for which a path can be found in constant time. The partial paths are pasted together as in Lemmas 3.2.1, 3.2.3. The entire process takes time linear in the length of the path, $O(nm)$. We note here that the results of this and the previous section leave open the question whether the Hamilton circuit problem is polynomial for grid graphs that are not rectangular, but neither have “holes”, i.e., both G and $G^\infty - G$ are connected.

REFERENCES

- [AHU] A. V. AHO, J. E. HOPCROFT AND J. D. ULLMAN, *The Design and Analysis of Computer Algorithms*, Addison-Wesley, Reading, MA., 1974.
- [GJ] M. R. GAREY AND D. S. JOHNSON, *Computers and Intractability: A Guide to the Theory of NP-Completeness*, Freeman, San Francisco, CA, 1979.
- [GJT] M. R. GAREY, D. S. JOHNSON AND R. E. TARJAN, *The planar Hamilton circuit problem is NP-complete*, this Journal, 5 (1976), pp. 704–714.
- [K1] R. M. KARP, *Reducibility among combinatorial problems*, in *Complexity of Computer Computations*, R. E. Miller and J. W. Thatcher, eds., Plenum Press, New York, 1972, pp. 85–104.
- [K2] M. S. KRISHNAMOORTHY, *An NP-hard problem in bipartite graphs*, SIGACT News, 7 (1975), 1, 26.
- [LM] F. LUCCIO AND C. MUGNAI, *Hamiltonian paths on a rectangular chessboard*, 16th Annual Allerton Conference, 1978, pp. 73–78.
- [Pa] C. H. PAPADIMITRIOU, *The Euclidean traveling salesman problem is NP-complete*, Theoret. Comp. Sci., 4 (1977), pp. 237–244.
- [P] J. PLESNIK, *The NP-completeness of the Hamiltonian cycle problem in planar digraphs with degree two*, IPL, to appear.
- [S] Y. SHILOACH, *Linear and planar arrangements of graphs*, Ph.D. dissertation, Appl. Math. Dept., Weizmann Institute of Science, Rehovot, Israel, 1976.
- [V] L. G. VALIANT, unpublished manuscript, 1979.