

Handheld-Impedance-Measurement System with seven-decade capability and potentiostatic function

*Original*

Handheld-Impedance-Measurement System with seven-decade capability and potentiostatic function / Angelini, EMMA PAOLA MARIA VIRGINIA; Carullo, Alessio; Corbellini, Simone; Ferraris, F.; Gallone, V.; Grassini, Sabrina; Parvis, Marco; Vallan, Alberto. - In: IEEE TRANSACTIONS ON INSTRUMENTATION AND MEASUREMENT. - ISSN 0018-9456. - STAMPA. - 55:2(2006), pp. 436-441. [10.1109/TIM.2006.870103]

*Availability:*

This version is available at: 11583/1464102 since:

*Publisher:*

IEEE / Institute of Electrical and Electronics Engineers Incorporated:445 Hoes Lane:Piscataway, NJ 08854:

*Published*

DOI:10.1109/TIM.2006.870103

*Terms of use:*

openAccess

This article is made available under terms and conditions as specified in the corresponding bibliographic description in the repository

*Publisher copyright*

(Article begins on next page)

# Handheld-Impedance-Measurement System With Seven-Decade Capability and Potentiostatic Function

Emma Angelini, Alessio Carullo, Simone Corbellini, Franco Ferraris, Vincenzo Gallone, Sabrina Grassini, Marco Parvis, *Senior Member, IEEE*, and Alberto Vallan

**Abstract**—This paper describes design and test of a new impedance-measurement system for nonlinear devices that exhibits a seven-decade range and works down to a frequency of 0.01 Hz. The system is specifically designed for electrochemical measurements, but the proposed architecture can be employed in many other fields where flexible signal generation and analysis are required. The system employs an unconventional signal generator based on two pulsewidth modulation (PWM) oscillators and an autocalibration system that allows uncertainties of less than 3% to be obtained over a range of 1 k $\Omega$  to 100 G $\Omega$ . A synchronous demodulation processing allows the noise superimposed to the low-amplitude input signals to be made negligible.

**Index Terms**—Corrosion testing, electrochemical devices, impedance measurement, intelligent systems, signal processing.

## I. INTRODUCTION

METALLIC objects suffer from degradation, which depend on the metal nature and on the environment. Coatings can be employed to mitigate the corrosion problems, but there are several problems related to both coating durability and compatibility with the protected alloy. This is true both in industrial environments and in the field of antiquities and works of art, where nonaggressive and easily removable coatings must be employed. These different requirements lead to rather different types of coatings with very different properties, so that the quality assessment of coating, either newly deposited or after some exposure to contaminants, is difficult to state.

Several techniques can be used to carry out these tests as well as to investigate the corrosion conditions of the surface. Examples of techniques [1] include atomic force microscopy (AFM), scanning electron microscopy (SEM), X-ray diffraction (XRD), Raman infrared spectroscopy (RIRS), Fourier transform infrared spectroscopy (FTIR), and electrochemical impedance spectroscopy (EIS). This last technique is the only one that can be carried out in the field with compact and portable instruments [2], [3].

Manuscript received June 15, 2004; revised December 7, 2005.

E. Angelini and S. Grassini are with the Dipartimento dei Materiali ed Ingegneria Chimica, Politecnico di Torino, Torino 24-10129, Italy (e-mail: emma.angelini@polito.it).

A. Carullo, S. Corbellini, F. Ferraris, M. Parvis, and A. Vallan are with the Dipartimento di Elettronica, Politecnico di Torino, Torino 24-10129, Italy (e-mail: marco.parvis@polito.it).

V. Gallone is with the Assing SpA, Monerotoondo 14-00016, Italy.

Digital Object Identifier 10.1109/TIM.2006.870103

## II. ELECTROCHEMICAL IMPEDANCE SPECTROSCOPY (EIS)

The EIS consists in the measurement of amplitude and phase of the surface impedance of coated metallic objects at different frequencies in order to highlight the barrier properties of the coating.

The impedance measurement is usually carried out by using an electrochemical cell containing a solution that allows the measurement system to establish electrical connection with the coating. The cell consists of three electrodes: the Counter electrode (C), the Reference electrode (R), and the Working electrode (W), which is the object whose protection has to be tested, and it is usually considered part of the cell. The impedance of interest is measured between the reference and the working electrode and is obtained as the ratio between the voltage  $v_{RW}$  and the current  $i_C$  that flows from C to W as a consequence of a small alternating voltage applied between the same two electrodes. The three-electrode structure is required to avoid measuring the voltage drop, due to the current flowing through the solution resistance, which could affect the final measured values. All measurements have to be carried out by applying a small alternating voltage superimposed to a variable bias dc voltage that has to be controlled in order to compensate the electrochemical potential of R and W electrodes due to the electrochemical nature of the measurement system; such control is hereafter referred to as potentiostatic function.

The impedance is typically measured in the frequency range of 1 mHz to 100 kHz, while the expected impedance amplitude depends on the area of the coating that is exposed to the solution; such area is often referred as electrode surface. For an electrode surface of 1 cm<sup>2</sup>, the amplitude is in the range of 1 k $\Omega$ , for greatly damaged coatings, to 10 G $\Omega$ , for very protective coatings at low frequency.

Many different complete EIS systems have been proposed by several instrument manufacturers, which work in the electrochemical corrosion field. Such instruments exhibit excellent performance but are either to be used in a laboratory or have structure and dimension that impair real portability.

The instrument described in this paper tries to increase the portability by embedding all the components into a single fully independent device that provides both portability and low-cost requirements and can be operated with one hand.

## III. PROPOSED EIS SYSTEM

Two constraints make it difficult to arrange an EIS: low-minimum frequency that can reach 1 mHz and the tremendous

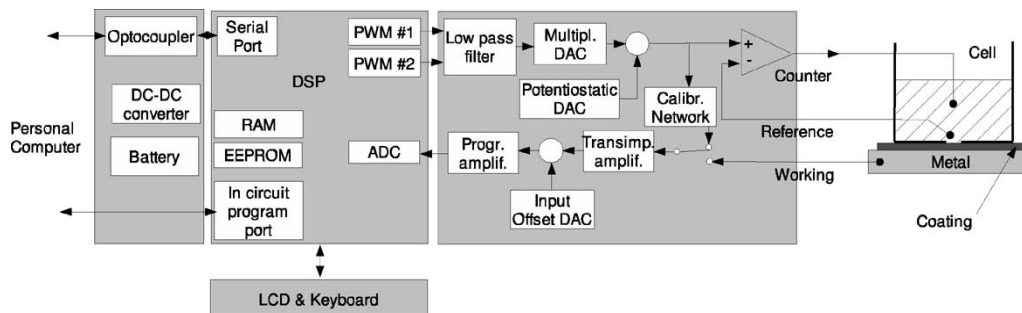

Fig. 1. Block diagram of the proposed impedance meter. On the right, the cell, which actually consists of two electrodes since the working electrode is directly connected to the metal, both the reference and the counter electrodes are immersed in the solution; the reference is located close to the coating to avoid measuring the potential drop through the solution.

changes in the impedance with both frequency and coating quality, which may require costly and very stable components in order to achieve an acceptable overall accuracy. In addition, the instrument has to deal with rather critical noise conditions, especially when measurements are taken at frequencies close to the mains frequency.

Both the problems of the component stability and of the noise are tackled in the proposed instrument by employing a measurement system that is based on a digital approach, where a digital signal processor (DSP) is used to

- 1) control the generation of both the ac sinusoidal stimulus and the dc bias voltage, which is used for the potentiostatic function;
- 2) control the input analog amplifiers so that the current, which flows through the cell, is converted back into a voltage by means of a transimpedance amplifier in order to be sampled by an analog-to-digital converter (ADC). Since the input range covers more than nine decades, with currents that span in the range of less than 1 pA to more than 1 mA, the measurement requires a dynamic range of 32 bits;
- 3) control the sampling process to obtain amplitude and phase of the coating impedance;
- 4) quickly estimate the coating status to provide the user with an immediate feedback.

By carefully selecting the DSP, it is possible to greatly reduce both instrument cost and complexity. The proposed prototype employs the \$10 single chip MSP430F149 provided by Texas Instruments that embeds a fast ADC (sampling frequency up to 220 kHz), although with limited resolution (12 bits), a large memory (64 kB), and several peripherals all contained in about 1 cm<sup>2</sup> footprint.

Fig. 1 shows the block diagram of the proposed instrument and the connections with the cell: the DSP, with its embedded peripherals is shown in the center, while on the left are the blocks related to the power system and to the connection to the personal computer (PC). The analog section is shown on the right.

The absence of a fast digital-to-analog converter (DAC) within the DSP and the limited ADC resolution can be over-



Fig. 2. System during an outside measurement of a common painted metallic door and a detailed photo of the electrochemical cell.

come in this kind of application by taking advantage of the DSP flexibility.

- 1) In order to avoid external high-accuracy DACs, the analog output voltage is obtained by means of pulsewidth modulation (PWM) technique. The outputs of PWM circuits used for coarse and fine generation are summed together and lowpass filtered to obtain an equivalent resolution of 10 bits. The PWMs can be easily created from the internal DSP timers, thus leaving the DSP core free to perform the other tasks.
- 2) The input dynamic range is obtained by actively controlling both the input stage gain and the stimulus amplitude while a synchronous sine-fit algorithm is employed to greatly reduce the noise effects; the required 32-bit dynamic range is obtained thanks to the 12-bit ADC resolution and the selection of the input stage gain that spans over seven decades.
- 3) The amplitude accuracy is obtained by means of an auto-calibration technique that employs some stable resistors as impedance standards.

The instrument contains a simple keyboard and a liquid crystal display (LCD) that are used during stand-alone operations. In the stand-alone mode, the instrument can be programmed to perform a measuring sequence and analyze the results to give an immediate though raw judgment of the coating state. However,

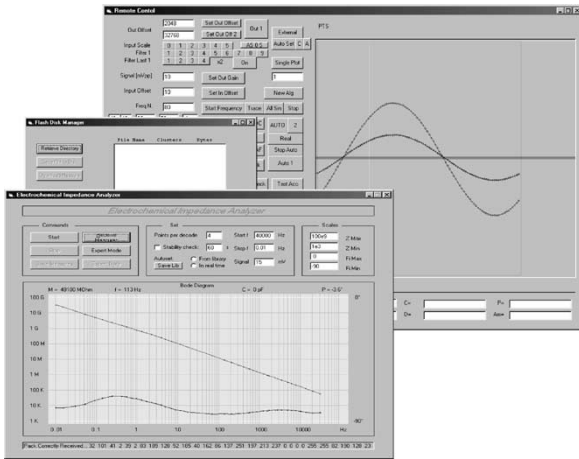

Fig. 3. Screenshot of the PC program which allows special measurements to be performed.

all the measurements are stored inside a nonvolatile memory and can be downloaded into a PC at a later time to produce reports for further analyses.

Fig. 2 shows the device during an outdoors measurement with a measuring head, which includes the electrochemical cell, designed for flat surfaces. The instrument is arranged as a compact gun-shaped device that also acts as support for the cell.

When connected to a PC, a program allows one to control all the instrument features, thus enabling complex or unusual measurements to be performed. In addition, the program produces impedance plots and exports the results to perform other analyses. Fig. 3 shows an example of the program panels during an impedance measurement where it is possible to observe the acquired traces in real time.

The communication between instrument and computer is performed by means of a common RS232 port. By using this connection, the computer is able to ask the instrument to perform specific actions and to receive back results these tasks produce. Usually, a command consists of a single-byte opcode and of one or more parameters. Some commands control electronic components, and others perform complex measurement processes.

Thanks to this simple protocol, new programs with new measurement procedures can be easily implemented. Moreover, the different hardware blocks inside the instrument can be quickly tested whenever an electronic failure occurs.

By means of a second connection, which can be driven by a PC parallel port, and a specific interface, it is possible to upgrade the firmware stored inside the flash memory of the instrument.

The instrument is battery operated thus avoiding both noise and ground loops problem connected to the power supply. The rechargeable batteries last about 15 h of measurements, without problems of data loss, since all the measured results are stored in a nonvolatile RAM.

#### IV. EXPERIMENTAL RESULTS

Measurements have been performed firstly in the laboratory and then in the field, in order to investigate the system ability to

work under different conditions. The aims of the first step were also to collect enough data to verify the system performance over the entire measurement range and to permit the fitting algorithm to be tested, as explained in the next section.

During the first part, a sequence of measurements has been performed with common capacitors in the range of 10 pF to 22 nF and resistors in the range of 1 k $\Omega$  to 10 M $\Omega$ . Such components have been previously characterized with an LRC meter so that accurate values were available for the system characterization. Then, the same components have been used to arrange more complex circuits in order to obtain more realistic behaviors as the one plotted in the Fig. 4, which refers to the circuit on the left of Fig. 5. During these preliminary measurements, the electrochemical cell was not involved; thus, the reference electrode was directly connected to the counter electrode.

The instrument accuracy depends on both frequency and amplitude value and is shown Fig. 6. The overall working area is divided into regions with constant accuracy. The accuracy decreases at greater frequencies and impedance values but remains within 3% up to 10 kHz and for impedances equivalent to capacitors of 15 pF. The upper right region is above the instrument capabilities and implies uncertainties above 5%.

After this preliminary characterization, the impedance meter has been used to analyze different coatings both of new, highly protective types and of old and damaged types. Fig. 7 shows an example of measurements obtained on a new coating: the undamaged coating has a quasi-perfect capacitive behavior, as highlighted by the phase plot, which is consistently near to  $-90^\circ$ .

The impedance amplitude in this case reaches very high values, more than 40 G $\Omega$  at the frequency of 10 mHz. Such a measurement has been useful to test the input dynamic range since a tremendous change in amplitude is applied to the system.

The values of the amplitude and phase of the measured impedance can immediately suggest the overall status of the coating; nevertheless, an electric-model-based approach is necessary to fully understand the character of the coating from the impedance results, as explained in the next section.

#### V. DATA FITTING

The EIS is a simple and powerful method for investigating the metal-coating interface. The main advantage of this technique is the ability to relate the acquired frequency spectrum with the physical process in the electrochemical system, which usually consists of a superimposition of some known phenomena as electrode kinetics, electrode double layer capacitance, diffusion layer, and others.

The common way used to join the measured spectrum with these phenomena is to explain their behaviors in terms of simple electrical components. For this reason, data fitting and electrical modeling become an indispensable step of the EIS technique. Unfortunately, the classical set of components is not exhaustive to fulfil this aim, since some chemical processes exhibit complex behaviors; thus, some specialized electrical elements have been introduced to overcome this lack [7]. The

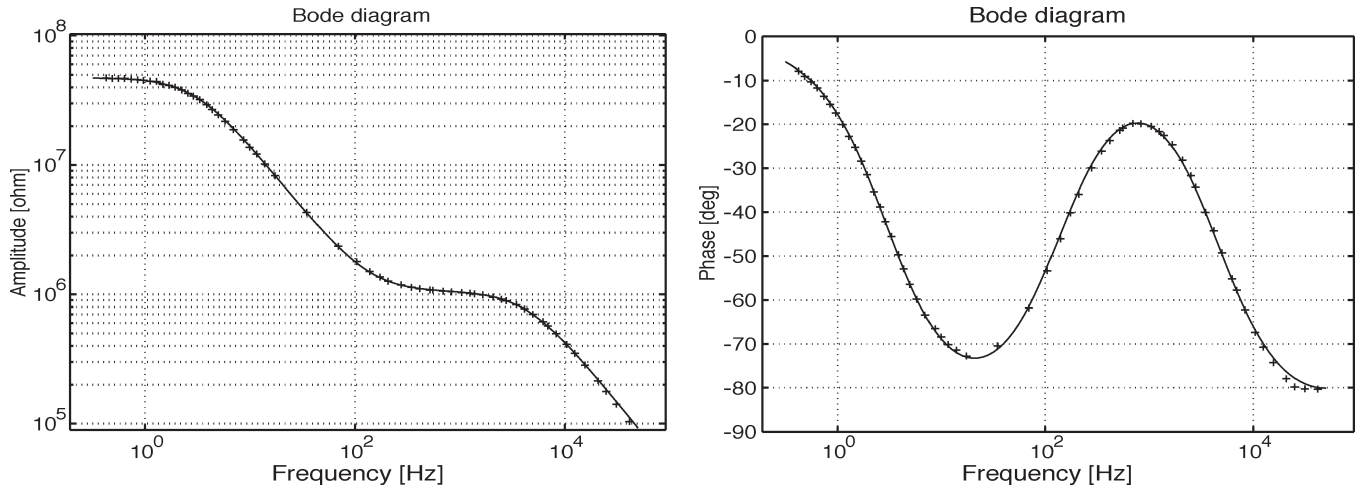

Fig. 4. Amplitude and phase traces for a measurement of a double-RC circuit. These results have been used to estimate the system accuracy and to test the fitting algorithm. The dots represent the acquired values, while the solid line represents the result obtained from the fitted model.

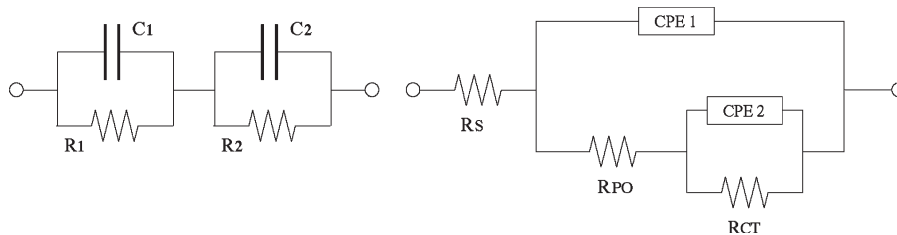

Fig. 5. Fitted model for a double-RC measurement and a common model for a metallic substrate protected with an organic coating.

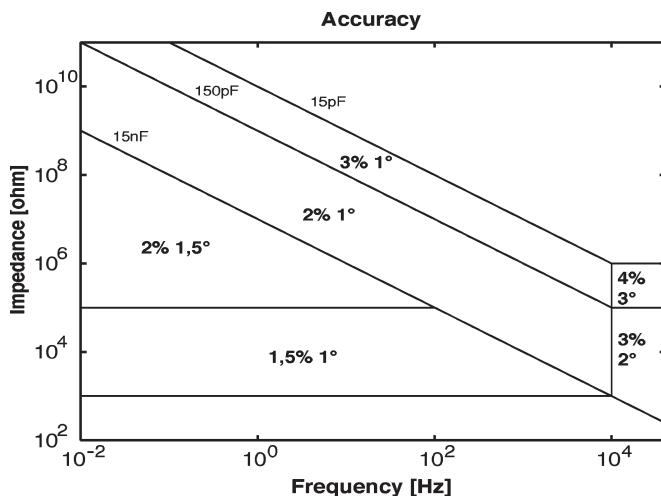

Fig. 6. Instrument uncertainty. The instrument has been characterized in the laboratory with known capacitors and resistors.

most important example is the constant phase element (CPE), which is represented by

$$Z = \frac{1}{(j \cdot 2\pi f C)^\alpha} \tag{1}$$

where  $\alpha$  is a coefficient ranging between 0 and 1. As shown by its impedance expression, this element is a generalization of a classic capacitor, which becomes a specialized case of a

CPE, when the coefficient  $\alpha$  is imposed to 1. Even though the physical explanations are still under discussion, this component has been introduced in order to permit the data fitting in all the cases where a constant phase region is obtained, or from another point of view, when magnitude in a region of the bode diagram drops off at an arbitrary constant rate.

A possible explanation for this behavior takes into account the phenomena related to the heterogeneous surface and the diffusion processes. An example of this behavior can be seen also in the plot of the Fig. 7, where at high frequencies, the phase approaches to  $-90^\circ$ , but it settles only at about  $-88^\circ$ , which corresponds to  $\alpha = 0.98$ .

Often, the coated metallic modeling leads to the electric circuit [4], [5] shown in the Fig. 5, where the most important component is the charge transfer resistance ( $R_{ct}$ ), by means of which the corrosion-process speed can be directly estimated. The resistors  $R_s$  and  $R_{po}$  instead are the solution resistance and coating micropore resistance, whereas  $CPE_1$  represents the intact coating capacitance, and  $CPE_2$  depicts the double layer capacitance, which takes place between an electrode and its surrounding electrolyte.

To focus on the modeling problem of some measurement data, in this work, two different approaches have been employed. For fitting results that laid far from behaviors represented by classical components, the fitting process has been carried out by stating the electric model and finding out its parameter values by employing a nonlinear least square method. For example, Fig. 8 shows the measurements

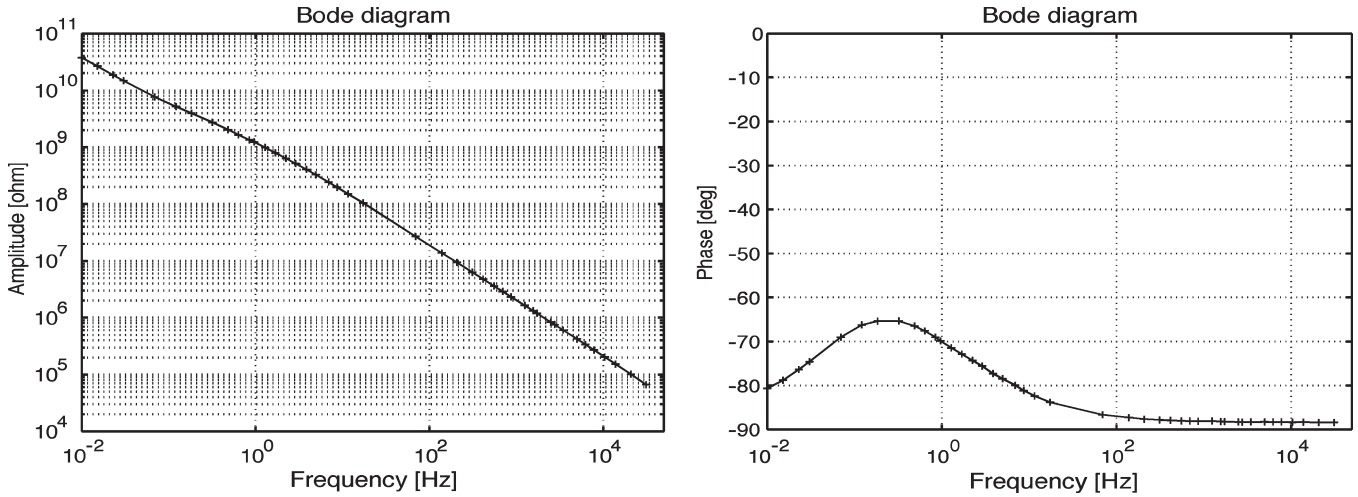

Fig. 7. Measurement result for a good new coating in which the impedance reaches  $40 \text{ G}\Omega$  at  $0.01 \text{ Hz}$  with a span greater than five decades. The phase plot settles only at about  $-88^\circ$ .

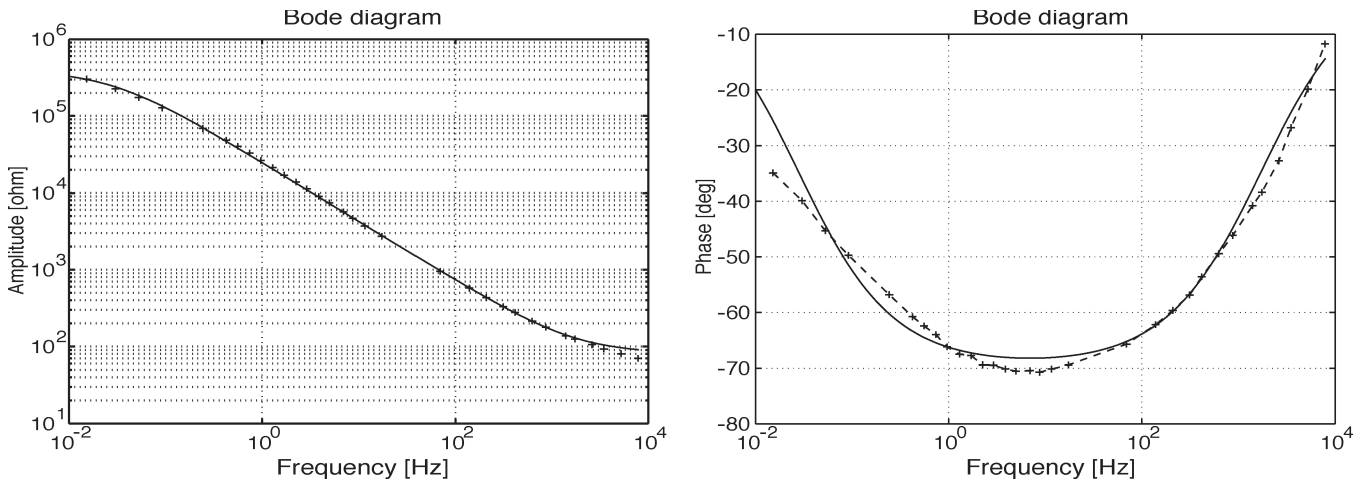

Fig. 8. Measurement results for an Aluminum substrate (Al Series 5005) covered with an  $\text{SiO}_2$ -like coating deposited by plasma enhanced chemical vapor deposition (PECVD). The dotted line represents the real measures, while the solid line represents the fitted data. The asymptotic phase value is about  $-70^\circ$  while the amplitude coherently decreases of about  $-15 \text{ dB/dec}$ .

obtained on an aluminum substrate covered with a  $\text{SiO}_2$  like coating [6]. As shown by the amplitude plot, which does not exhibit the expected  $20 \text{ dB/dec}$  behavior, classical capacitors are not appropriate to perform the fitting. A good result has been obtained employing the CPE. In this case, the intact coating capacitance is negligible; thus, the associated capacitor has been removed from the electric model, and resistors  $R_s$  and  $R_{po}$  have been merged together. The obtained values are  $R_s + R_{po} = 87 \text{ }\Omega$ ,  $R_{ct} = 397 \text{ k}\Omega$ ,  $C = 350 \text{ nF}$ , and  $\alpha = 0.77$ .

Since the CPE elements often degrade in common capacitors and no other specialized elements are required, a vector-fitting approach can be used to avoid the necessity of *a priori* selecting a model. In fact, the algorithm can be employed to easily find out both the position and the number of the impedance zeros and poles, from which the electric model can be guessed. This second method has been applied during the system performance investigation in order to assess the instrument accuracy.

For instance, a double-RC circuit, whose impedance is shown in the Fig. 4, has been measured and then fitted by the vector-fit program that has produced the correct model of the Fig. 5.

## VI. CONCLUSION

In this paper, a portable impedance meter for coatings characterization has been described that combines a low-cost and a lightweight design with good performance. The coating impedance is measured in the range of a few kilohms to several tens of gigaohms with an uncertainty of about 3%, while the phase is measured with an uncertainty of about  $1^\circ$ . These values, even though less accurate than the ones obtained with laboratory equipment, allow one to perform a complete and reliable characterization of most coatings, with the advantage of a really portable instrument. The DSP-based architecture gives users the ability of remotely controlling all the instrument operations to enhance the range of applications while still leaving a simple operation mode for ordinary users.

## REFERENCES

- [1] R. W. Clarke and S. M. Blackshaw, "Conservation of iron, maritime monographs and reports," National Maritime Museum, Greenwich, U.K., 1982, Monograph 53.
- [2] C. Price, D. Hallam, G. Heath, D. Creagh, and J. Ashton, "An electrochemical study of waxes for bronze sculpture," in *Proc. Int. Conf. Metal Conservation (Metal'95)*, Semur En Auxois, France, 1997, pp. 233–241.
- [3] F. Mansfeld, "Use of electrochemical impedance spectroscopy for the study of corrosion protection by polymer coatings," *J. Appl. Electrochem.*, vol. 25, no. 3, pp. 187–202, Mar. 1995.
- [4] P. L. Bonora, F. Deflorian, and L. Fedrizzi, "Electrochemical impedance spectroscopy as a tool for investigating underpaint corrosion," *Electrochim. Acta*, vol. 41, no. 7/8, pp. 1073–1082, May/June 1996.
- [5] E. Angelini, S. Grassini, F. Rosalbino, F. Fracassi, and R. d'Agostino, "Surface analysis of PECVD organosilicon films for corrosion protection of steel substrates," *Surf. Interface Anal.*, vol. 34, no. 1, pp. 155–159, Aug. 2002.
- [6] E. Angelini, F. Fracassi, R. d'Agostino, S. Grassini, and F. Rosalbino, "PECVD of organosilicon thin films for corrosion protection of metals," in *Trends in Electrochemistry and Corrosion at the Beginning of the 21st Century, in the Series*. Barcelona, Spain: Univ. Barcelona, 2004, Homenajes 20.
- [7] Gamry Instruments, *Electrochemical Impedance Spectroscopy Theory: A Primer*. [Online]. Available: [http://www.gamry.com/App\\_Notes/EIS\\_Primer/EIS\\_Primer.htm](http://www.gamry.com/App_Notes/EIS_Primer/EIS_Primer.htm)



**Emma Angelini** was born in Torino, Italy, in 1951. She received the B.S. degree in chemistry from Torino University.

Since 1976, she has been a Professor of applied physical chemistry with the Faculty of Engineering, Information Sector, at Politecnico di Torino. She is involved in National and European projects on corrosion and protection of metals. Her research areas include corrosion and protection of metallic materials, as stainless steels, amorphous and nanocrystalline alloys, biomaterials for dentistry, and tangible cultural heritage.

Prof. Angelini is a member of the European Federation of Corrosion (EFC).



**Alessio Carullo** was born in Italy in 1966. He received the M.S. degree in electronic engineering from Politecnico di Torino, Torino, Italy, in 1992 and the Ph.D. degree in electronic instrumentation from the Università di Brescia, Italy, in 1997.

Currently, he is an Assistant Professor with the Dipartimento di Elettronica, Politecnico di Torino, where he is responsible for the Italian Calibration Service (SIT) Calibration Center n. 139. He works in the development of intelligent instrumentation and in the validation of automatic calibration systems.



**Simone Corbellini** was born in Italy in 1977. He received the M.S. degree in electronic engineering from Politecnico di Torino, Torino, Italy, in 2002. He is working toward the Ph.D. in metrology at the Politecnico di Torino.

His main fields of interest are digital signal processing, distributed measurement systems, and intelligent microcontroller-based instrumentation. At present, he is working on the development of a measuring systems for physical and chemical characterization of thin films.



**Franco Ferraris** was born in Italy in 1945. He received the degree in electrical engineering from Politecnico di Torino, Torino, Italy, in 1969.

Until 1989, he was Associated Professor of electronic measurements with the Dipartimento di Automatica e Informatica, Politecnico di Torino. In 1990, he became Full Professor of electronic measurements with the Dipartimento Elettrico, Elettronico e Sistemistico, University of Catania, Italy. Since 1991, he has been with the Dipartimento di Elettronica, Politecnico di Torino. His fields of interest

include automatic controls and system theory, biomedical measurements, intelligent measurement systems, and intelligent sensors.

**Vincenzo Gallone** was born in Milano, Italy, in 1949. He received the M.S. degree in electronic engineering from the Faculty of Engineering, University of Roma, Italy, in 1978.

He joined Assing SpA, Monterotondo, Italy, in 1977. Initially involved in the development of hardware (H/W) interfaces for Data Logger, he moved to the Hi Tech Instruments Division in 1981. He was appointed to the office of Director of the Customer Support, with the responsibility of managing the Customer Service unit and the End-user Training and Applications facility. Recently, he was appointed to the office of Manager of the R&D Division, with the responsibility of managing innovative projects and the development of analytical instruments.



**Sabrina Grassini** was born in Italy in 1972. She received the M.S. degree in chemistry from Università di Torino, Torino, Italy, in 1999 and the Ph.D. degree in metallurgical engineering from the Politecnico di Torino in 2004.

Currently, she is a Postdoc Researcher with the Dipartimento di Scienza dei Materiali e Ingegneria Chimica, Politecnico di Torino. Her research areas include plasma chemistry and coatings deposition, corrosion and protection of metallic materials, and conservation of cultural heritage.



**Marco Parvis** (SM'01) was born in Italy in 1958. He received the M.S. degree in electrical engineering from the Politecnico di Torino, Torino, Italy, in 1982 and the Ph.D. degree (Italian Doctorate) in metrology from the same university, in 1987.

He is now a Full Professor of electronic measurements at the Second Faculty of Engineering, Politecnico di Torino. He is the Chair of the TC 25 Medical Measurement of the IEEE Society on Instrumentation and Measurement. His main fields of interest are intelligent instrumentation, application of signal processing to measurement, biomedical, and chemical measurements. At present, he is working on new sensors for mechanical and chemical quantities, and is involved in the development of new distributed measuring systems as well as in the development of a new remotely exercised calibrator for personal computer (PC)-based acquisition boards. He is an author of more than 100 publications.



**Alberto Vallan** was born in Italy in 1967. He received the M.S. degree in electronic engineering from Politecnico di Torino, Torino, Italy, in 1996 and the Ph.D. degree in electronic instrumentation, in 2000.

He is now an Assistant Professor with the Electronic Department, Politecnico di Torino. His main fields of interest are power measurement in distorted environment, development of sensors for physical and chemical quantities, and intelligent measurement systems.