

Handover Delay in Mobile WiMAX: A Simulation Study

Bhaskar Ashoka, David Eyers and Zhiyi Huang
Department of Computer Science
University of Otago
Dunedin, New Zealand
Email: {bhaskar;dme;hzy}@cs.otago.ac.nz

Abstract—Worldwide Interoperability for Microwave Access (WiMAX) deployment is growing at a rapid pace. Since Mobile WiMAX has the key advantage of serving large coverage areas per base station, it has become a popular emerging technology for handling mobile clients. However, serving a large number of Mobile Stations (MS) in practice requires an efficient handover scheme. Currently, mobile WiMAX has a long handover delay that contributes to the overall end-to-end communication delay. Recent research is focusing on increasing the efficiency of handover schemes. In this paper, we analyse the performance of the two standardised handover schemes, namely the Mobile IP and the ASN-based Network Mobility (ABNM), in mobile WiMAX using simulation. Our results clearly indicate that ABNM is more efficient for handover in terms of handover delay and throughput.

Index Terms—WiMAX, Mobile WiMAX, Next Generation Wireless Network (NGWN), Mobility Management, Handover Delay

I. INTRODUCTION

The Internet Protocol (IP) has become a vital part of modern life. With the increasing number of applications, such as video streaming, Internet TV, music downloads, video conferencing, VoIP, and social networking, there is an increasing expectation of anytime and anywhere access to the Internet. This expectation is driving next generation networks (NGN) to augment cellular, satellite, and other mobile network technologies with a backbone of the core IP network technology.

Unlike mobile data networking based on 2G, 2.5G and 3G technology that is largely based on the cellular telephone network, NGN systems will facilitate the large range of Internet applications and services in addition to those available today. At the network level, NGNs are packet-based and are able to provide high-speed broadband alongside the Quality of Service (QoS) mappings required to share bandwidth between services with very different needs. Mobile WiMAX is one such NGN system that can provide the required QoS to a large range of services and applications.

Mobile WiMAX is attracting a large number of users due to its capability to provide users with high quality services in terms of speed and coverage. It is in increasing demand: according to the Maravedis 4GCounts Quarterly Report network [1], the subscriber base for WiMAX reached 17.25 million at the end of March 2011, which is far beyond that of its competitor LTE, which only had 320,000 subscribers

at that time. This report predicts that the WiMAX subscriber base will reach approximately 28.6 million by the end of 2012. Of these subscribers, 21 million will be mobile, using devices relying on the 802.16e-2005 standard (mobile WiMAX).

Despite the fast growth of WiMAX, there are still technical challenges to be resolved to make it work to its full potential. Efficient mobility management in mobile WiMAX is one of the key research challenges. Mobility management in WiMAX involves two-phases: the first relates to location management, and the second relates to handover management. Location management helps the system to recognise and establish a connection with the user. Handover management involves the transfer of each user's applications' context from from one base station (BS) to another. In this paper, we focus on the study of handover management, more specifically handover delay in WiMAX.

Mobile WiMAX has different types of handover techniques. The current commonplace approach is to use the Mobile Internet Protocol (IP). The Mobile IP standard is defined by the Internet Engineering Task Force (IETF) [2], and is intended to support IP mobility in most wireless networks, such as those based on the IEEE 802.11 and 802.16e standards. It has been very important and helpful in providing mobility management for these wireless networks. Though it is a mature standard, Mobile IP has not been well regarded by the telecommunications community due to various technical problems. One problem in particular is that the handover management in Mobile IP is host-based, which requires the Mobile Stations (MS, i.e. mobile devices) to support Mobile IP and be involved in the handover procedure of the protocol. This procedure is time consuming for MS and it is hard for MS to support and be upgraded to different versions of Mobile IP. New updates may also increase power consumption of MS.

However, for most commercial network providers, there was no practical alternative to replace Mobile IP [3, 4].

To address many of the problems with Mobile IP, the IETF has developed the concept of network-based handover. The network-based handover protocol has completely changed how handover management must be done. Based on the concept of network-based handover, the notion of Access Service Networks (ASNs) [5] has been developed for mobile WiMAX, and contains their own version of network mobility and handover protocols: ASN-based Network Mobility (ABNM) [5].

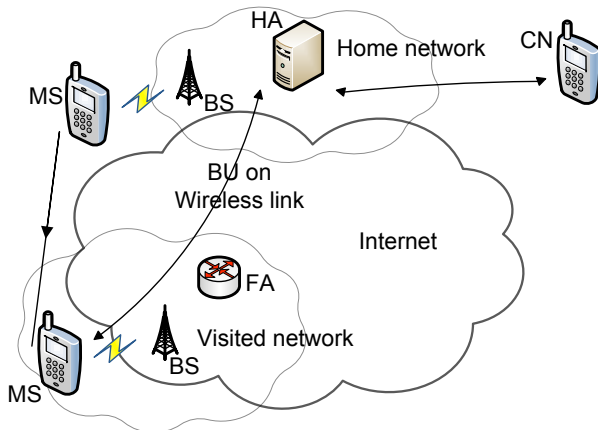

Fig. 1. Host-based handover and its signal messages.

In this paper, we will study and compare Mobile IP and the ABNM in terms of handover delay. Both schemes have been implemented in our simulation environment: we explain our results both quantitatively and qualitatively. Our results show ABNM is more effective than Mobile IP in terms of both handover delay and throughput.

The remainder of this paper is organised as follows. First in Section II, we briefly present an overview and discuss problems of host-based handover approaches, and then identify some key strengths of the network-based handover approach. Then in Section III we present a technical overview of the host-based and network-based handover protocol in terms of how they facilitate IP mobility. Section IV describes our simulation environment and presents the experimental analysis of network-based and host-based handover protocols and compares their performance. In Section V, we discuss future work related to network-based handover and scanning techniques that are appropriate for mobile WiMAX. Finally in Section VI, we draw conclusions.

II. MOTIVATION

Handover is a frequent operation in mobility management. Take the example of commuters travelling to and from work: their mobile devices will need to roam between different base stations, during which the IP subnet of each domain may change. With a host-based handover protocol like Mobile IP, the roaming mobile device will need a new IP address to identify itself within the coverage of the new base station.

In a host-based handover protocol, a mobile station has to support the protocol stack and handle the signalling messages during the handover procedure. For example, Figure 1 shows the main components of Mobile IP and its signalling messages. Mobile IP involves a Home Agent (HA), a Foreign Agent (FA), a Mobile Station (MS), and a Corresponding Node (CN). The design of Mobile IP manages what is required to allow an MS to roam freely between different wireless zones.

According to Mobile IP, an MS holds a home address assigned by its home network. While moving to another

network, the MS needs to configure itself with a Care of Address (CoA). The MS requests an FA of the new local network to configure a CoA for it. After identifying itself with the CoA in the network that it is currently visiting, the MS informs its HA of its CoA. This process is called Binding Update (BU). The BU process includes two signalling messages: a binding address update request and a binding acknowledgement. Once the HA receives the new CoA from the MS, it updates its routing table. Then packets sent to the MS from the CN are encapsulated by the HA with the CoA and forwarded to the network the MS is currently visiting.

The above BU process may incur long delays. If this process takes a long time, there is a high chance that the packets from the CN destined to the old address of the MS will be lost: the handover performance is delay sensitive. In the case of Mobile IP, every time an MS moves to a new network, the amount of wireless signalling traffic required to update its new CoA is crucial. These signals will adversely affect the wireless bandwidth which is one of the most precious resources in mobile networks. To start the signalling exchanges between the MS and the HA on the wireless channel, the channel access time and the wireless link transmission delay will impact the handover delay. More details of signalling exchanges in Mobile IP can be found in [6].

Another problematic aspect of Mobile IP is the security concern regarding location privacy. The replacement of the CoA may allow eavesdroppers to pinpoint the position of the MS by monitoring the CN. Once they can map the subnets of the MS into the corresponding geographical locations, they can track the MS spatially. This poses a significant threat to users' privacy [4].

Extensions to Mobile IP [7, 8] have been proposed to reduce this handover delay by using a local HA that is closer to the MS. In this way, the handover can be achieved within a local network. However, in this scheme, the MS still has to go through the BU process. Mobile IP and its extensions rely heavily on the signal strength of the network in order to work efficiently. Though wireless networks can meet this requirement in urban areas, in many rural geographical areas signal strength may be a problem: even for a normal session of video streaming on the MS, packet loss rates may be very high. In such cases, the handover delay introduced in the BU process will make the situation even worse when handover is required. Also, as suggested in [9], the handover management based on these Mobile IP extensions does not perform well for a large number of mobile stations.

Mobile IP has two standard versions: MIPv4 and MIPv6. Both are considered to be robust protocols. The basic functionality of the two versions is similar though they are used for IPv4 and IPv6 respectively. However, in MIPv6, the MS is independent of the FA and configures the CoA automatically through the use of auto-configuration [10] and neighbour discovery [11] protocols. IPv6 also provides route optimisation. This involves bypassing the HA by setting up a tunnel that directly connects the MS to the CN and ensures the CN is routing its packets to the CoA of the MS. However, this

optimisation requires additional messages to be exchanged between the MS and the CN, which is after the initial BU process between the MS and the HA. In total, the optimisation involves four messages: first, two messages are exchanged between the MS and the HA in the BU process, and then two messages are exchanged between the MS and the CN. This optimization may further increase the handover delay and packet loss.

Another technical problem for Mobile IP is its many versions [7, 8, 12] lead to deployment challenges. In particular, to upgrade Mobile IP to a different version, the software stack on the MS needs to be modified, which is often difficult in practice. To make matters even worse, the software stack of the CN needs to be upgraded as well to support communication with the MS. This is more difficult since the CN may be from a different vendor. In summary, managing different versions of Mobile IP on all the MSes is a difficult task. This is why only a small number of networks provide Mobile IP support [3, 4]. Network providers are trying different solutions to the handover procedure without using Mobile IP in the MS, in order to get rid of the problems discussed above.

Fortunately, the IETF has recently proposed a network-based handover to fix the problems in host-based handover protocols like Mobile IP. A network-based handover protocol keeps the permanent identifier of the MS available to its home network, the CN, and the foreign network. The MS also needs to get a new registration ID from the foreign network to facilitate roaming within the local network. This new ID is equivalent to the CoA in Mobile IP. However, instead of the MS sending the CoA to its HA, the FA informs the HA of the CoA, as shown in Fig. 2. The obvious benefit of the network-based handover protocol is that, from the perspective of the MS, it has never changed its network. It has the illusion that it only moves inside one network domain. The network-based handover protocol also has the benefit of short handover delay since the network takes care of the handover on its wired lines, which are likely to have small transmission delays and (comparatively) minimal bandwidth constraints. Also since there is only a single permanent ID of the MS known to the CN, that makes it extremely difficult for eavesdroppers to track the user's position. We will discuss the benefits of the network-based handover further in the following section.

Although we believe it to be intuitive that network-based handovers would have shorter delays, there has been no quantitative study yet on its performance in terms of handover delay. In this paper, we will have a simulation study on the performance of the network-based and host-based handover protocols using ASN and Mobile IP as examples.

III. OVERVIEW OF ASN-BASED NETWORK MOBILITY

As introduced above, ASN-based Network Mobility (ABNM) is the system proposed for WiMAX in order to integrate network-based handover.

As shown in Fig. 3, each ASN includes many Base Stations (BS) and ASN-gateways (ASN-GW). The ASN is responsible

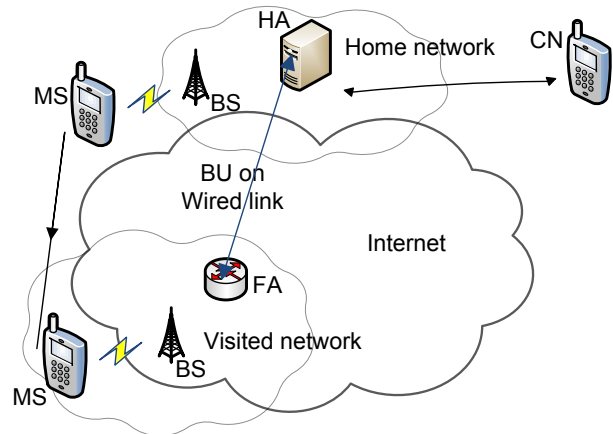

Fig. 2. Network-based handover and its signal messages.

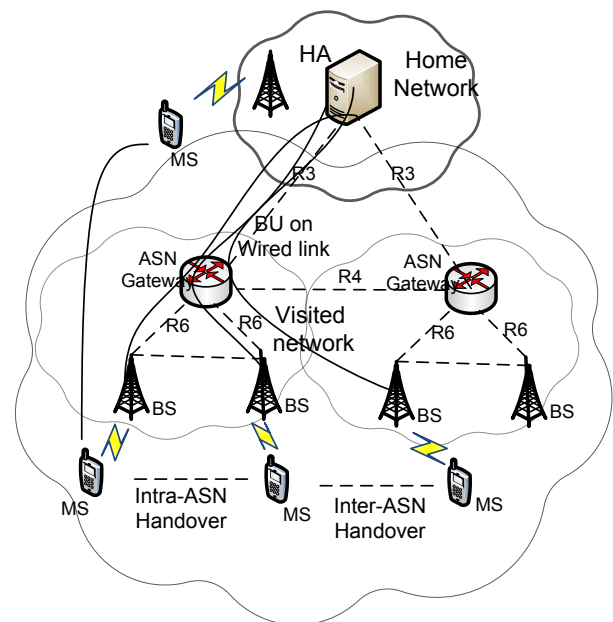

Fig. 3. Overview of ABNM.

for providing mobility-related functions, radio resource management, network discovery and authentication services. Each MS is associated with an ASN-GW. The ASN-GW works as the foreign agent for the MS to inform the HA of the CoA.

ABNM refers to the set of procedures associated with the movement (handover) of a MS between two BSs (referred to in the IEEE 802.16 standard as Serving BS and Target BS), where the target BS may belong to the same ASN or a different ASN. The handover occurs without changing the traffic anchor point (i.e. the HA) of the MS in the serving (anchor) ASN. There are two types of ABNM: inter-ASN handover and intra-ASN handover. Intra-ASN handover is also known as R6 handover: the MS roams in the same ASN but

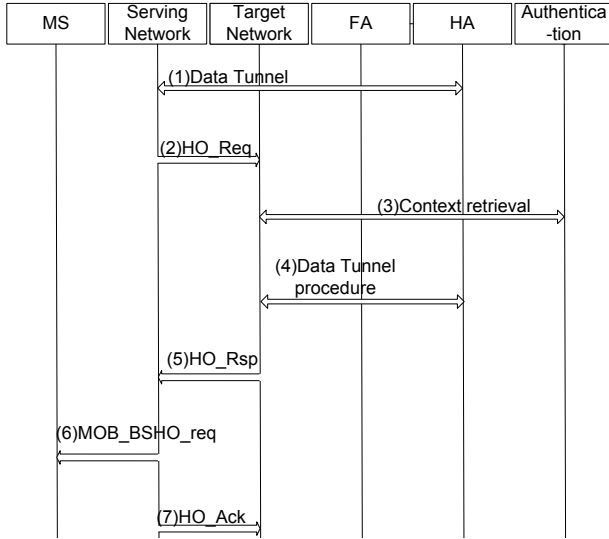

Fig. 4. Network-Based handover procedure

with different ASN-GWs. R6 is a wired interface from the BS to the ASN-GW, which is a set of protocols for communication between BS and the ASN-GW. R3 is a wired interface from the ASN to the core network. It supports tunnel establishment, AAA (Authentication, Accounting and Authorization) and other policy enforcements. R6, along with R3, forms a tunnel to transfer packets between the HA and the MS. Inter-ASN handover is also known as R4 handover. R4 is a wired interface between different ASNs' that supports mobility between them. In this case, a MS moves between different ASNs. R4 along with R6 and R3 establishes a tunnel to transfer packets between the HA and the MS, which is attached to a BS of different ASN. The handover process involves transferring the context of all service flows together with other context from the previous BS to the new BS, while attempting to ensure minimal delay and data loss during this transition [13].

Figure 4 shows the steps of the handover procedure in ABNM. We describe each step in detail in the following text. Further technical details are available in [13].

- 1) The state of the MS is shown before the handover.
- 2) The Serving network sends an HO-Req message to one or more target ASNs establishing the potential target BSs for handover. This message contains a timer TR-HO-Req. The message also includes an authenticator ID that points to the authenticator distributor function at the authenticator ASN and the anchor ASN-GW.
- 3) The target network(s) sends an application context retrieval message to the ASN authenticator (AAA server).
- 4) The target network(s) may initiate a data tunnelling path for the MS with the Anchor ASN after receiving the HO-Req message.
- 5) The target network(s) sends an HO-Rsp message to the serving network to acknowledge the handover request and starts timer TR-HO-Rsp. Upon receipt of

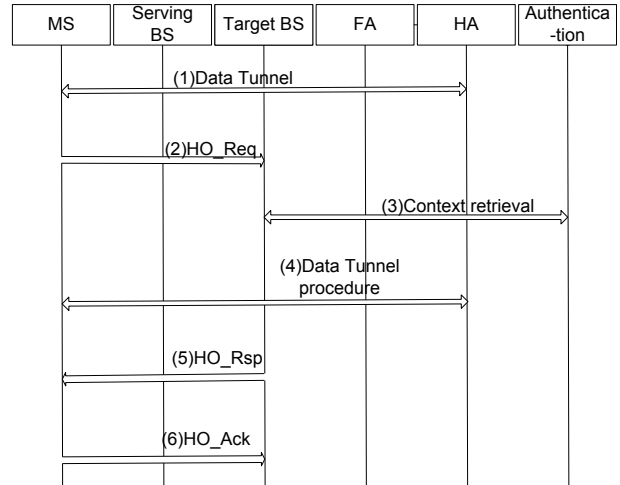

Fig. 5. host-based-procedure

the HO-Rsp message, the Serving network stops timer TR-HO-Req.

- 6) The Serving network sends a MOB-BSHO-REQ message to the MS containing one or more potential target BSs selected by the network for the MS to handover.
- 7) The Serving network sends an HO-Ack message to the target network(s) controlling the candidate target BS(s) selected for the MS. Upon receipt of the HO-Ack message, the target ASN(s) stops timer TR-HO-Rsp.

Figure 5 shows the steps of the handover procedure in host-based handover. In contrast to network based-handover, the MS makes the handover decision and the procedures to attach itself to another BS.

By deploying ABNM, network providers can profit from the fact that they are no longer required to modify the software stack on each MS in order to accommodate handover protocol changes. In addition to the advantages of the network-based handover as discussed before, ABNM brings modularity in the mobility management architecture.

IV. RESULTS

A. Simulation setup

The simulation involves examining how a single MS moves across three BSs at various specific speeds. All simulations were performed using OPNET [14]. The movement path travels from a starting point outwards through each BS once, then returns along the reverse of its outward path, back to the starting point. Mobile WiMAX can have 3, 4 or 6 sectors per BS: in our simulation, each of the three BS's coverage is divided into three sectors. Sectors play an important role in distributing the load of the network, depending on the congestion of the traffic. Standard mobile WiMAX installations come with a setup of 3 sectors per BS, [15, 16] so we also use this configuration. Full mobility is a standard within mobile WiMAX, which supports speeds of 60 km/h and higher [17]. In this work, we evaluate full mobility. However, we also consider a speed

TABLE I
SIMULATION PARAMETERS

Parameter	Value
Coverage area	3km
Scanning thresold	1db
Scan duration	25 frames
Interleaving interval	140 frames
Scan iterations	10
Maximum handover attempts	3

of 20 km/h to verify the protocols at lower speed, as well. We evaluate it in the context of a workload of bi-directional voice over IP (VoIP). We analyse the handover delay and throughput measurements. Unsolicited Grant Service (UGS) is selected as our desired quality of service, as it provides a Constant-Bit-Rate (CBR) data stream, which is appropriate for supporting VoIP. UGS is designed to send fixed-size packets at regular intervals. Uplink and downlink data are mapped symmetrically to UGS at the rate of 120kbps. The objective of this setup is to evaluate the handover delay and throughput of the mobile WiMAX mobility management system when supplied with a constant volume of traffic. Some of the key OPNET parameters that were used are listed in Table I.

B. Handover delay analysis

In the analysis of handover delay, the following assumptions were made:

- MIPv4 is used, but the results are intended to generalise to MIPv6. This is justified as the MIPv6 mechanisms for mobility support are the same as those for MIPv4 but for some extra features that are not relevant here [18].
- Hypothetical road vehicles' speed in urban areas are tested at 20 km/h and 70 km/h, and express trains' speed tested at 120 km/h and 160 km/h. These speeds may vary across different geographical locations of course, but are considered to be usefully illustrative here.

The equations below assume the following terms are defined:

- The time duration for sending a binding update and an acknowledgment to the HA is represented in variables T_{BU} and T_{BA} respectively.
- The time duration for sending a binding update to the CN and back are represented by the variables T_{CN} and T_{CNK} respectively.
- T_{AUTH} is the delay involved in authenticating the MS profile within the network.
- T_{RADV} and T_{RSOL} are the Router Solicitations Advertisements message delays in Mobile IP. The MS can issue a router solicitation message requesting nearby routers to send it advertisements. Routers periodically send router advertisements anyway, but the MS may incur the T_{RSOL} message delay if it has rebooted, or has failed to read signals. After this solicitation, there will be a delay of T_{RADV} for routers to deliver their information to the MS.

- T_{DAD} is the time taken to detect whether an IP address is a duplicate after the MS acquires the necessary care of address.

During the handover process, the system may suffer packet loss. The probability of this packet loss is directly related to link handover start delay, and the IP subnet configuration completion time. During this time, the mobile node is unreachable at its former topological location on the previous link, to which correspondents are still sending packets. Such misrouted packets are dropped [6].

Handover delay is computed from the time the MS sends a `mobile-HO-req` message, to start the hand-off process, until the initial ranging with the new serving BS is completed. In the case of ABNM, it is the time from which the ASN sends the `HQ-req` message to the serving BS to the time by which the MS completes its handover.

The entire handover delay should be between 40-70 ms in order to avoid any degradation in call quality [6]. However, research has shown [19, 20] that a 1.2 second handover delay can occur in real-world MIPv6 implementations: this would be highly disruptive for users even if it only occurs for a small percentage of handovers. Note that real-world measurement results for ASN network mobility are yet published to our knowledge.

Equation 1 describes the handover delay for Mobile IPv4, and equation 2 describes handover delay for ABNM.

$$HD_{MIPv4} = T_{AUTH} + T_{RADV} + T_{RSOL} + T_{DAD} + T_{BU} + T_{BA} \quad (1)$$

$$HD_{ASN} = T_{BU} + T_{BA} + T_{AUTH} \quad (2)$$

When using Mobile IPv4, the MS after acquiring the COA, has to go through the process of duplicate address detection [21]. This is one of the delay components shown in equation 1, leading to a longer delay than compared to ABNM. The registration process of binding updates from MS to HA and HA to MS in MIPv4 occurs on the wireless channel, thereby also adding wireless transmission link and wireless channel access delays. These wireless resources are critical and severely limited for most wireless networks: if handover signaling use increases, the scalability of the network will decrease. ABNM does the registration process from the serving BS to the Anchor ASN over wired network links, thereby avoiding extra load on the mobile WiMAX connections, and in turn helping to increase the scalability of the network.

Equation 3 describes handover delay for Mobile IPv6:

$$HD_{MIPv6} = T_{AUTH} + T_{RADV} + T_{DAD} + T_{BU} + T_{BA} + T_{CN} + T_{CNK} \quad (3)$$

Mobile IPv6 adds a route optimisation capability, which helps the MS directly tunnel packets to the CN after successful handover. However, this capability come with an additional cost of T_{CN} and T_{CNK} , thus increasing the handover delay.

Figure 6, Figure 7, Figure 8 and Figure 9 shows the handover delay of Mobile IP and ABNM for different speeds. The graphs have different sample points for different speeds,

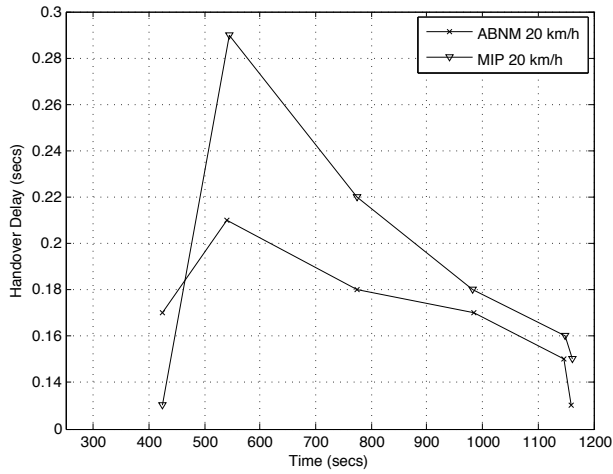

Fig. 6. Average handover delay of ABNM and Mobile IP for 20 km/h.

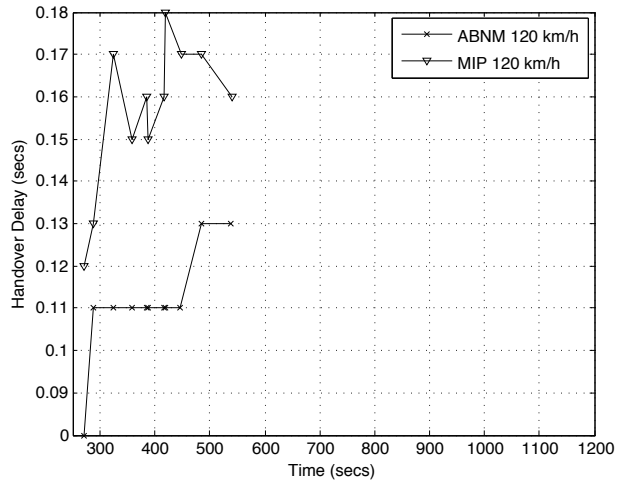

Fig. 8. Average handover delay of ABNM and Mobile IP for 120 km/h.

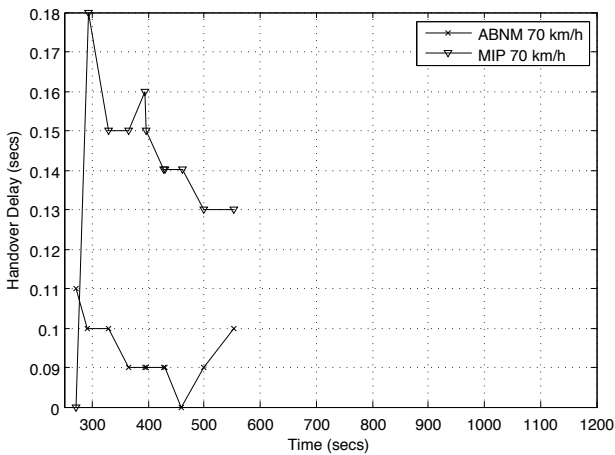

Fig. 7. Average handover delay of ABNM and Mobile IP for 70 km/h.

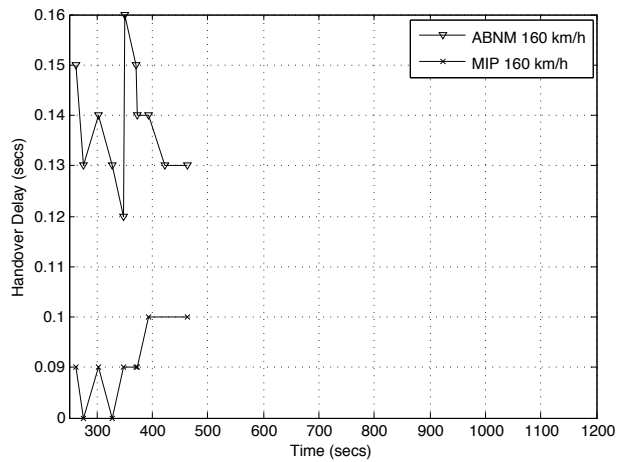

Fig. 9. Average handover delay of ABNM and Mobile IP for 160 km/h.

this is due to the sharper and longer delay values at different speeds.

The MS is configured to move from BS1 to BS2, then to BS3 and afterwards to return along the reverse of its outward path, finishing at BS1. Together there are four single handovers, assuming, no multiple handovers due to poor signal strength. These graphs plot the average handover delay of the four handovers of the MS moving at different speeds. As the simulator has an initialisation time, the graph data of interest to us does not start at time zero, and is appropriately shown in the graphs. Considering the urban area city speed limit and walking users, fewer mobile users in WiMAX will be moving at 70 km/h than 20 km/h. At higher speeds, the MS would not have enough time to scan multiple BSs for handovers. In Mobile IP, the MS will use its scanning time to connect to the different network points, discovering the number of BSs available in its vicinity. In the case of ABNM, the number of BSs to scan is allocated by the anchor ASN in the ASN

network. For this reason, the mobile WiMAX system can, and does, allocate shorter scanning times. Thus we can see a shorter handover window size for the series in the graphs with higher speeds. The ABNM handover delay is less than the Mobile IP for the whole range of different speeds. Table II and Table III show the maximum, minimum, mean and standard deviation of the handover delay for Mobile IP and ABNM respectively. Taken together, these figures and tables indicate that ABNM outperforms Mobile IP in terms of handover delay.

C. Throughput analysis

The throughput measurement included here describes the total number of packets/second received and forwarded to the higher network layers by the mobile WiMAX MAC.

Throughput varies depending on the noise interference and the signal to noise ratio (SINR). In case of Mobile IP, the exchange of signals to update the HA with BU occurs on the wireless transmission link. Transmission of packets on

TABLE II
MOBILE IP HANDOVER DELAY STATISTICS

Speed (km/h)	Max (s)	Min (s)	Sample mean (s)	Standard deviation
20	0.44	0.07	0.15	0.13
70	0.28	0.07	0.13	0.06
80	0.45	0.07	0.16	0.11
90	0.51	0.09	0.15	0.12
100	0.33	0.08	0.14	0.07
120	0.37	0.09	0.16	0.08
160	0.36	0.06	0.13	0.08

TABLE III
ABNM HANDOVER DELAY STATISTICS

Speed (km/h)	Max (s)	Min (s)	Sample mean (s)	Standard deviation
20	0.25	0.06	0.13	0.06
70	0.24	0.06	0.1	0.05
80	0.24	0.06	0.11	0.05
90	0.33	0.06	0.14	0.07
100	0.23	0.09	0.12	0.04
120	0.34	0.07	0.13	0.07
160	0.14	0.07	0.1	0.02

the wireless channel tends to adversely affect the overall SINR. This causes the number of packets buffering during the handover procedure to be increased or dropped thereby reducing the system throughput. In ABNM, the registration process occurs on wired media thereby enhancing the system throughput compared to Mobile IP.

We have measured throughput for various speeds, which are listed in Table IV and Table V. Due to space constraints, we have only included graphs showing the MS travelling at 70 km/h and 120 km/h: a subset of the data in the tables. Figure 10 and Figure 11 show the throughput for Mobile IP and ABNM, respectively. The graph suggests the throughput in the case of Mobile IP for different MS motion speeds is consistently lower than ABNM. The throughput in these graphs measures the packet flow after the completion of the handover. ABNM maintains higher consistency in terms of the rate of buffering the packets, hence maintains a higher, reliable throughput. Mobile IP would suffer throughput loss, and degrade the quality of VoIP calls, for example.

V. FUTURE WORK

Handover delay is one of the key parameters that research schemes seek to optimise so as to produce an effective mobility architecture. Another significant parameter is scanning delay. With the increased growth rate of the wireless industry, there are many bandwidth-heavy applications on offer for users to enjoy. Normally, handover management works independently from the QoS point of view (e.g. prioritised packed scheduling). However, with the growing demand for bandwidth-heavy applications, handover management should consider bandwidth requirements before selecting the next BS for the handover. This ideally requires historical knowledge of the way in which these applications are being served from different host entities such as BSs. In our future research, we will use history-based selection of BS and network-based

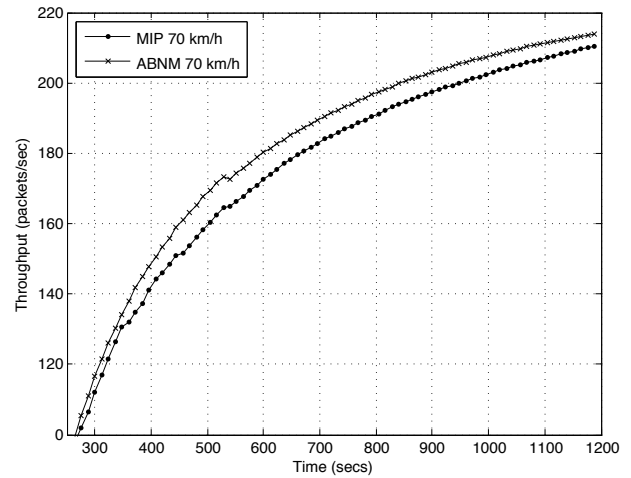

Fig. 10. Average throughput with MS speed of 70 km/h.

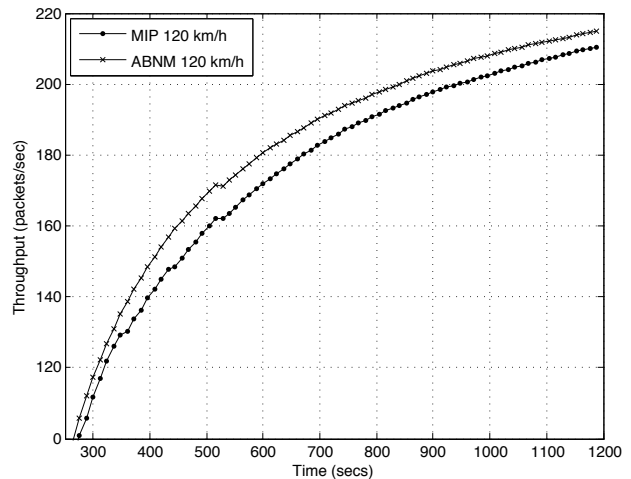

Fig. 11. Average throughput with MS speed of 120 km/h.

handover to reduce the scanning time and the handover delay in mobile WiMAX.

VI. CONCLUSION

To our knowledge, this is the first experimental study presented on network-based handover and host-based handover in mobile WiMAX. The results are promising for the applicability of network-based handover technology, and encouraging for network-based handover research. Mobile WiMAX network providers are particularly satisfied with the ASN-anchored protocol because of the fact that it is their own protocol, and also the changes to the protocol will not affect the mobile devices of their users. Most other protocols for mobility management tend to require modifications to the MS software stack. With the MS being independent of mobility management, vendors can design mobile phones for mobile WiMAX without needing to cater for frequent software

TABLE IV
MOBILE IP THROUGHPUT STATISTICS

Speed (km/h)	Max (packets/sec)	Sample mean (packets/sec)	Standard deviation ($\bar{\sigma}$)
20	261.67	209.05	85.21
70	264.25	210.36	84.96
80	259.58	209.03	85.25
90	260.75	209.47	85.67
100	260.33	209.3	85.6
120	262.42	210.4	85.47
160	259.08	210.29	85.51

TABLE V
ABNM THROUGHPUT STATISTICS

Speed (km/h)	Max (packets/sec)	Sample mean (packets/sec)	Standard deviation ($\bar{\sigma}$)
20	260.92	214.59	85.35
70	264.83	214.02	85.62
80	265.58	214.3	86.09
90	261.83	215.43	85.82
100	260.17	214.81	85.66
120	260.17	214.79	85.9
160	261.92	214.46	85.78

updates. Vendors can manufacture mobile devices irrelevant of the handover protocol used in the network. Overall in this paper we have demonstrated that the ABNM handover scheme can strengthen the capability of mobile WiMAX network operators to manage and control their networks more efficiently.

REFERENCES

- [1] www, <http://www.4gcounts.com/Samples/LatestNews.html>.
- [2] C. Perkins, "Mobile ip," *Communications Magazine, IEEE*, vol. 35, no. 5, pp. 84–99, 1997.
- [3] N. Banerjee, W. Wu, and S. Das, "Mobility support in wireless internet," *Wireless Communications, IEEE*, vol. 10, no. 5, pp. 54–61, 2003.
- [4] J. Kempf, "Problem statement for network-based localized mobility management (netlmm)," 2007.
- [5] (2011, August). [Online]. Available: <http://www.wimaxforum.org/resources/documents/technical/T33>
- [6] J. Kempf, "Goals for network-based localized mobility management (netlmm)," 2007.
- [7] E. Fogelstroem, A. Jonsson, and C. Perkins, "Mobile ipv4 regional registration," 2007.
- [8] H. Soliman, C. Castelluccia, K. El-Malki, and L. Bellier, "Hierarchical mipv6 mobility management," *IETF draft, draft-ietf-mobileip-hmipv6-05.txt*, 2001.
- [9] P. Reinbold and O. Bonaventure, "Ip micro-mobility protocols," *Communications Surveys & Tutorials, IEEE*, vol. 5, no. 1, pp. 40–57, 2003.
- [10] T. Jinmei, T. Narten, and S. Thomson, "Ipv6 stateless address autoconfiguration," 2007.
- [11] T. Narten and E. Nordmark, "W. simpson," neighbor discovery for ip version 6 (ipv6)," RFC 2461, December, Tech. Rep., 1998.
- [12] G. Dommetty, A. Yegin, C. Perkins, G. Tsirtsis, K. El-Malki, and M. Khalil, "Fast handovers for mobile ipv6," *draft-ietf-mobileip-fast-mipv6-05 (work in progress)*, 2002.
- [13] W. F. Proprietary, "Stage 2: Architecture tenets, reference model and reference points." Tech. Rep., 2009.
- [14] (2011, August). [Online]. Available: <http://www.opnet.com/>
- [15] M. Paolini, "Compact base stations: a new step in the compact base stations: a new step in the evolution of base station design," Tech. Rep., 2010.
- [16] "Business case for wireless broadband access," Ruckus Wireless Inc, Tech. Rep., 2009.
- [17] J. Pinola and K. Pentikousis, "Mobile wimax," vol. 11, no. 2, 2008, pp. 19–35.
- [18] D. Johnson, C. Perkins, and J. Arkko, "Rfc 3775: Mobility support in ipv6," *IETF, June*, 2004.
- [19] A. Mishra, M. Shin, and W. Arbaugh, "An empirical analysis of the ieee 802.11 mac layer handoff process," *ACM SIGCOMM Computer Communication Review*, vol. 33, no. 2, pp. 93–102, 2003.
- [20] A. Cabellos-Aparicio, H. Julian-Bertomeu, J. Núñez-Martínez, L. Jakab, R. Serral-Gracià, and J. Domingo-Pascual, "Measurement-based comparison of ipv4/ipv6 mobility protocols on a wlan scenario," *Performance Modelling and Evaluation of Heterogeneous Networks (HET-NETS' 05)*, 2005.
- [21] Y. Han, J. Choi, H. Jang, and S. Park, "Advance duplicate address detection," *draft-han-mobileip-adad-00.txt*, 2003.