

HEAT STORAGE CAPABILITY OF A ROLLING CYLINDER USING GLAUBER'S SALT

C. S. Herrick and K. P. Zarnoch
General Electric Company

PROJECT OUTLINE

Project Title: Thermal Energy Storage Subsystems for Solar Heating Applications

Principal Investigator: W. E. Smith

Organization: General Electric Company
Corporate Research and Development
P. O. Box 8
Schenectady, NY 12301
Telephone: (518) 385-8147

Project Goals: Develop the rolling cylinder phase-change heat store concept to the point where a prototype design is completed and a cost analysis prepared.

A series of experimental and analytical tasks are defined to establish the thermal, mechanical, and materials behavior of rolling cylinder devices. These tasks include analyses of internal and external heat transfer, performance and lifetime testing of the phase-change materials, corrosion evaluation, development of a mathematical model, and design of a prototype and associated test equipment.

Project Status: Technical feasibility of the concept was demonstrated. Manufacturability studies were completed; baseline concept for prototype was selected.

Contract Number: EM-78-C-05-5759

Contract Period: August 1978 to October 1980

Funding Level: \$373,600

Funding Source: U.S. Department of Energy
Conservation and Solar Applications

HEAT STORAGE CAPABILITY OF A ROLLING CYLINDER USING GLAUBER'S SALT

**C. S. Herrick and K. P. Zarnoch
Corporate Research and Development
General Electric Company
Schenectady, NY 12301**

INTRODUCTION

Thermal energy storage by the melting and refreezing of a chemical compound (phase change storage) has the possibility of a high energy storage density and isothermal behavior. Both features are thought to be highly desirable for thermal storage in systems intended for the solar heating and cooling of buildings.

Unfortunately these attractive possibilities are difficult to realize in practice because they require that the refreezing step be carried out with a very high and constant Carnot efficiency and with fast kinetics to produce high heat release rates. High thermodynamic efficiency and fast kinetics are rarely operative in the same process.

Salt hydrates have relatively high latent heats of fusion (melting) as well as melting temperatures which are convenient for space heating and cooling systems. Most salt hydrates exhibit refreezing problems which are severe enough to prevent their widespread adoption for heat storage.

One potential solution to the salt hydrate refreezing problem is the Rolling Cylinder Heat Storage Device invented at the General Electric Research and

Development Center.[1-3] Prior experimental work in this laboratory has demonstrated that sodium sulfate decahydrate can be made to freeze rapidly, completely, and repeatedly when it is contained in a cylindrical vessel rotating slowly about its cylindrical axis with its axis horizontal. At rotational speeds near 3 rpm this mechanical arrangement produces just enough stirring action in the two phases to create effective chemical equilibrium even though the solid Na_2SO_4 still hovers near the bottom of the vessel. Complete freezing is obtained with a calculated low expenditure of energy to generate the rolling motion. Satisfactory repeatable nucleation has been obtained over many cycles through the use of a tubular nucleator. Refreezing progresses without buildup of a crust of decahydrate crystals on the cylinder wall to interfere with rapid heat transfer.

To use a rolling cylinder in a heating/cooling system, the system designer must have accurate information describing the heat storage capacity, the temperature profile required to empty out a store and then refill it, and the rates at which heat can be withdrawn from the store or added to it.

Sensible heat storage in tanks of water is characterized by a generally low storage capacity, by wide temperature swings, and by permissible high rates of heat removal per unit of heat transfer area.

-
- [1] C. S. Herrick, "A Rolling Cylinder Latent Heat Storage Device for Solar Heating/Cooling", ASHRAE Transactions, 85, 512 (1979).
 - [2] C. S. Herrick, U.S. Patent No. 4,154,292, May 15, 1979.
 - [3] C. S. Herrick and D. C. Golibersuch, "Qualitative Behavior of a New Latent Heat Storage Device for Solar Heating/Cooling Systems", General Electric Company Report No. 77CRD006, March 1977.

Phase change storage, on the other hand, is characterized by a generally high storage capacity, by narrow temperature swings, and by limiting low rates of heat removal per unit of heat transfer area. Configurations chosen by others for phase change storage usually try to provide a large heat transfer area and allow a crust of solid storage material to accumulate on the heat exchange surface. In the rolling cylinder solids do not accumulate on the heat exchange surface so the required heat transfer area is much smaller. In principle this smaller heat transfer area should be an advantage for the rolling cylinder store.

The broad goal of this work is to produce a quantitative assessment of the engineering properties needed to design a rolling cylinder heat store for use in space heating and cooling. This report describes calorimetry on a laboratory scale rolling cylinder to measure its thermal properties.

Calorimeter Construction:

Figure 1 shows the calorimeter which consisted mainly of a plywood box lined with foamed polystyrene insulation. A cylindrical chamber in the center holds the rolling cylinder. Figure 2 is a sketch of the assembled calorimeter. Air from the surrounding room is propelled into the calorimeter by a blower. After passing through the annular space between the cylinder and insulation thereby cooling the rolling cylinder, the air passes over a heater and out of the instrument. Resistance thermometers measure the air temperature rise due to heat from the cylinder and then a second rise due to the electric heater. A known electrical input to this heater provides the basic air flow rate measurement. Cylinder wall temperature was measured by a block of copper sliding against the rotating wall.

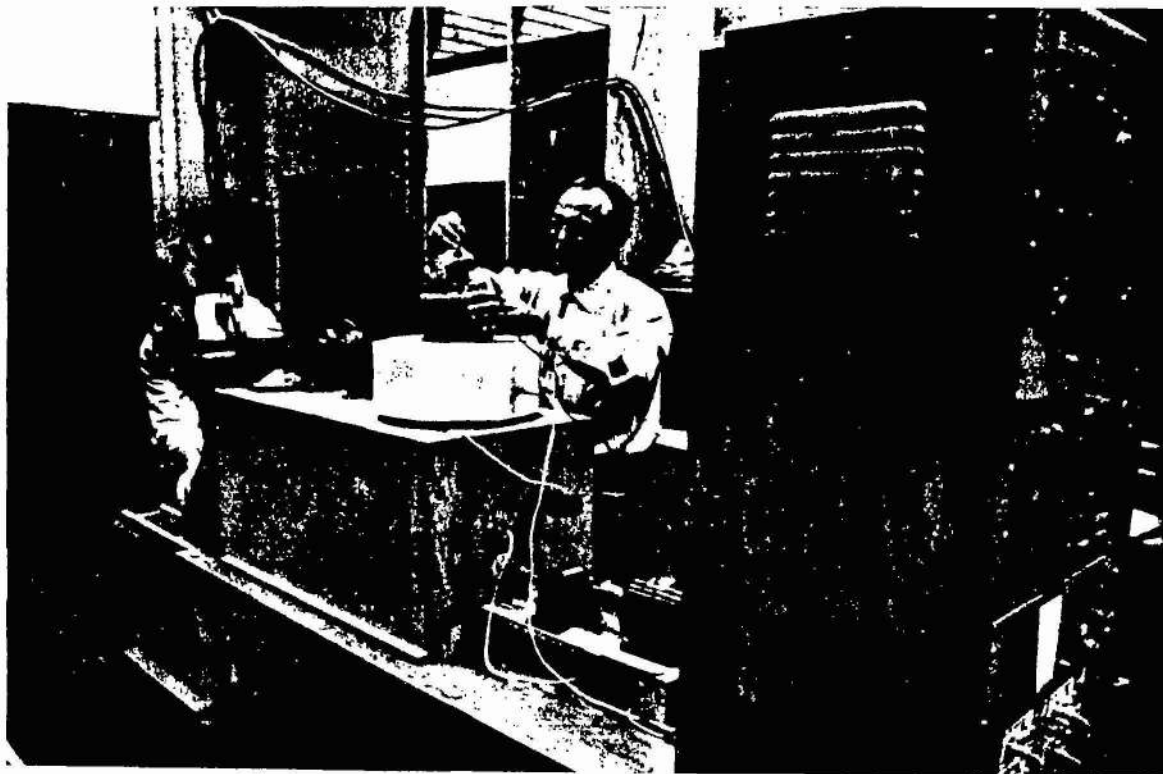
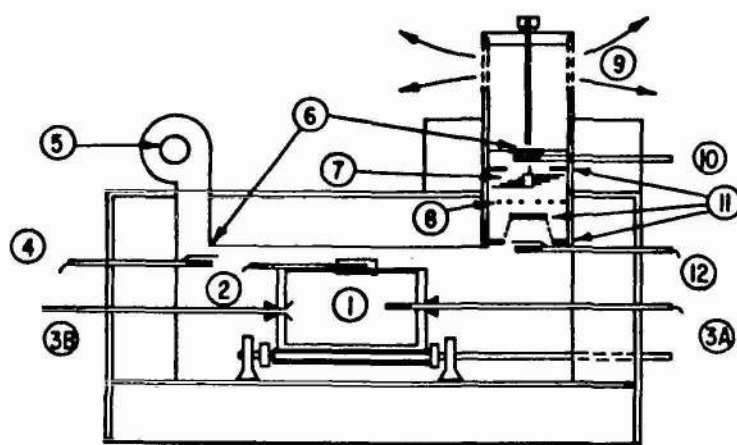

Figure 1 Calorimeter for Measuring Heat Flow Rates in a Rolling Cylinder

LEGEND



- ① ROLLING CYLINDER
- ② CYLINDER OUTSIDE TEMP.
- ③A CYLINDER INSIDE TEMP.
- ③B NUCLEATOR
- ④ INLET AIR TEMP.
- ⑤ AIR BLOWER
- ⑥ RADIATION SHIELDS
- ⑦ AIR MIXING SYSTEM
- ⑧ HEATER (CALROD)
- ⑨ EXHAUST AIR
- ⑩ OUTLET AIR TEMP.
- ⑪ AIR BAFFLE SYSTEM
- ⑫ AFTER CYLINDER TEMP.

Figure 2 Air Cooled Calorimeter for the Rolling Cylinder

Much care is required to assure that average air temperatures are measured rather than superheated-flow-streamline temperatures. All sensors provided a direct reading digital output, both visual and Binary Coded Decimal. Sensors were scanned at 3 minute intervals during the 15-18 hours required to complete one run. A programmable microprocessor directed the scanning and formatted the BCD output for recording on magnetic tape. Data reduction at a later time provided a heat balance around the calorimeter for each scan interval. After start-up the experiment ran to completion unattended, usually overnight. Computer data reduction and computer directed graph drawing were essential to convenient management of the large data output. Random error cancellation occurred to an important degree due to the large number of data points.

Rolling Cylinder Construction

The rolling cylinders used in the calorimeter were 6 inches outside diameter, 12 inches long, and had transparent ends so the freezing process could be observed visually. Both ends were thermally insulated during calorimetry so that all heat was removed through the cylindrical surfaces where the heat transfer conditions were well defined. Two differing cylinder constructions were used, and both were satisfactory. The first consisted of a FERNICO metal cylinder (iron-nickel-cobalt alloy) 40-mil thick with FN glass plates applied to the cylinder ends by glass-blowing, see Figure 3. FERNICO metal alloy and FN glass make a satisfactory joint because they have matching coefficients of expansion. A tapered opening for a No. 7 rubber stopper was placed at the center of each end plate, one for a thermowell entry, and one for a tubular nucleator.

The second cylinder construction consisted of a length of commercial 304 stainless steel tubing. Some internal buffing of the tubing was required to control roughness. A plate of 1/2" thick polymethylmethacrylate with outward facing

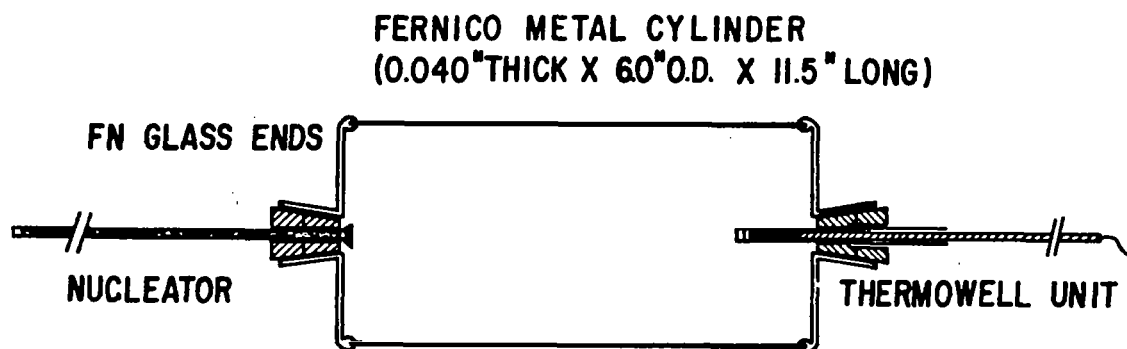

Figure 3 A Rolling Cylinder for Laboratory Scale Calorimetry

beveled edges was inserted on each end and sealed in place by filling the bevel spaces with RTV—room temperature vulcanizing silicone rubber. 1/4-inch IPS pipe threads at the center of each end provided for thermowell and nucleator connections.

Both the thermowell and nucleator were fabricated from 1/4-inch diameter copper tubing. The thermowell projected 6 inches inside the rolling cylinder along the central axis. The nucleator projected about 1/2 inch inside and 13 inches outside along the central axis but at the opposite end.

Calorimeter Operation

Over 50 experiments have been completed in the calorimeter apparatus using Glauber's salt, sodium sulfate decahydrate, as the phase change thermal storage medium. Operating experience suggests an accuracy of about $\pm 8\%$ in the quantity of heat measured.

Thermal Profile

In Figure 4 one can see the entire thermal profile of a typical calorimetric run during the freezing of Glauber's salt as it progressed from start to finish. It is convenient and helpful to present all of the calorimetric data in terms of the percentage of the theoretical latent heat evolved. This permits meaningful comparison between cylinders of differing size, between cylinders operated at differing rates, or between differing kinds of storage. The latent heat of fusion of sodium sulfate decahydrate was taken to be 105.6 Btu/lb. [4].

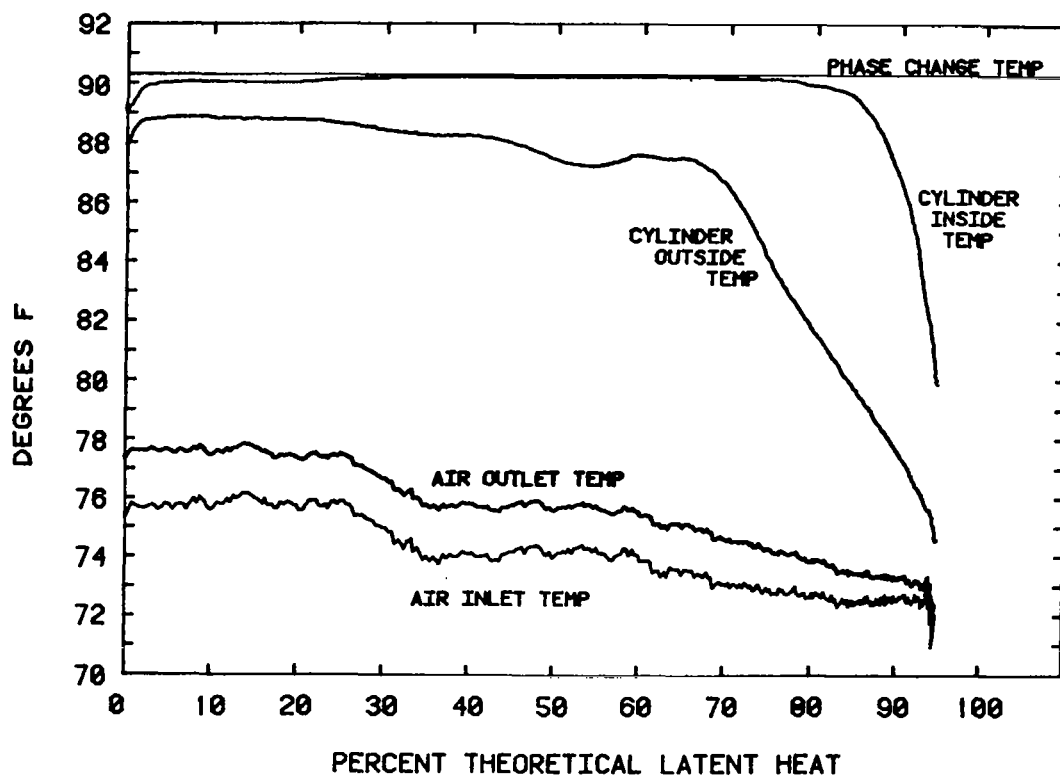

Figure 4 Run 52 at 3 RPM and 25% Excess Na_2SO_4 . Cycle 31.

[4] G. Brodale and W. F. Giauque, J. Am. Chem. Soc., 80, 2042 (1958).

Zero percent latent heat occurs at the moment of nucleation. Normally nucleation occurs when the supercooling below phase change temperature is greatest. Thus the separation between cylinder inside temperature and phase change temperature at zero percent latent heat is a measure of the maximum supercooling and an indicator of nucleator performance. In Figure 4 nucleation occurred at about 89°F, a supercooling of 1.3°F for the cylinder contents. The total heat removal was 95% of the theoretical amount.

In addition to the air temperatures, the cylinder wall (outside) temperature and the cylinder axial (inside) temperature, one can find temperature drops (ΔT) from crystal face to cylinder contents (bulk liquid), from cylinder liquid to cylinder wall, and from cylinder wall to the cooling air.

The cylinder outside wall temperature remains within 3°F of the phase change temperature until 70% of the latent heat has been discharged from the cylinder. This is the most significant feature, the temperature of the heat exchanger surface. It can and will be used presently as the principal comparison between the results of different experiments.

Due to the 10% empty space at the top of the cylinder, the cylinder outside wall temperature will vary somewhat with angular position around the circumference. It was desirable and convenient to measure the lowest value; consequently, in design work these data will cause heat transfer rates to be slightly underestimated.

Heat Removal Rates:

The heat removal rate measured in run 52 (corresponding to Figure 4) appears in Figure 5. For comparison the ideal heat removal behavior is indicated by a dashed line forming a rectangle. The rolling cylinder performance does approximate the ideal behavior thus fulfilling the advance promise of good and sustained heat transfer capability. This desirable behavior results from avoiding the progressive accumulation of solids on the heat transfer surface where they become a thermal barrier.

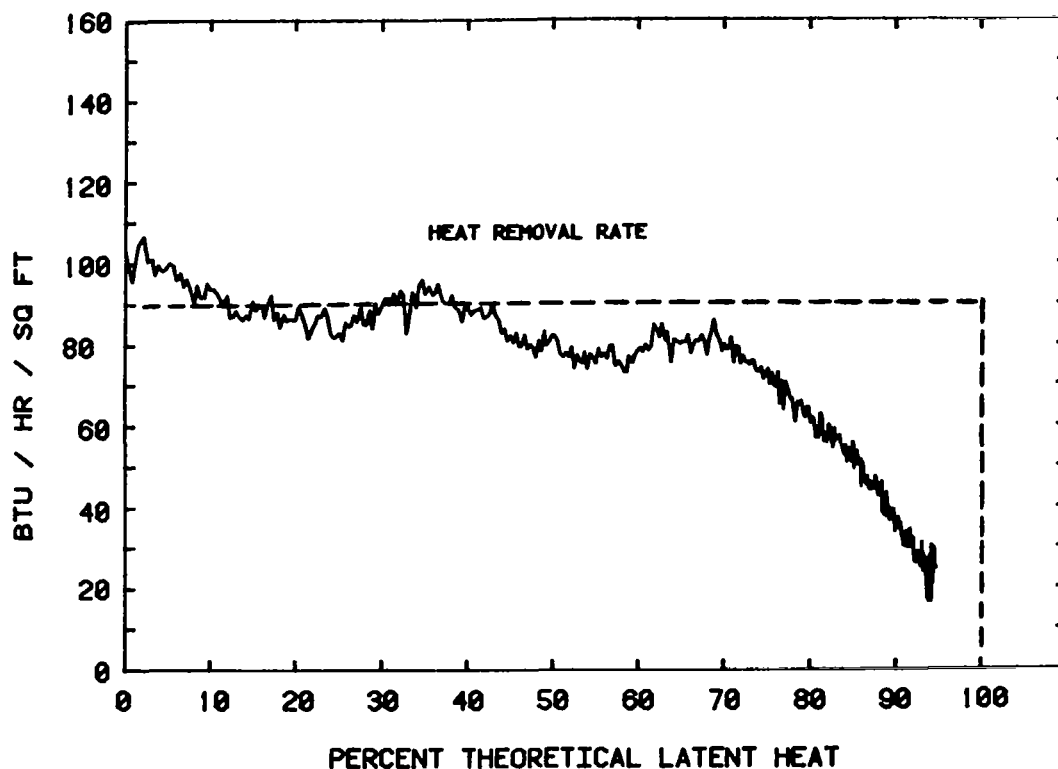

Figure 5 Run 52 Heat Removal Rate Illustrating the Close Approach to Ideal Behavior (dashed line)

Figure 6 illustrates a sustained heat removal rate of 200 Btu/hr/sq ft. This is the highest rate obtainable under experimental conditions convenient for the calorimeter, thus it is most probably not a limiting rate. Again, as in Figure 5 the shape of the heat removal rate compares well with the ideal behavior suggested by the dashed rectangle.

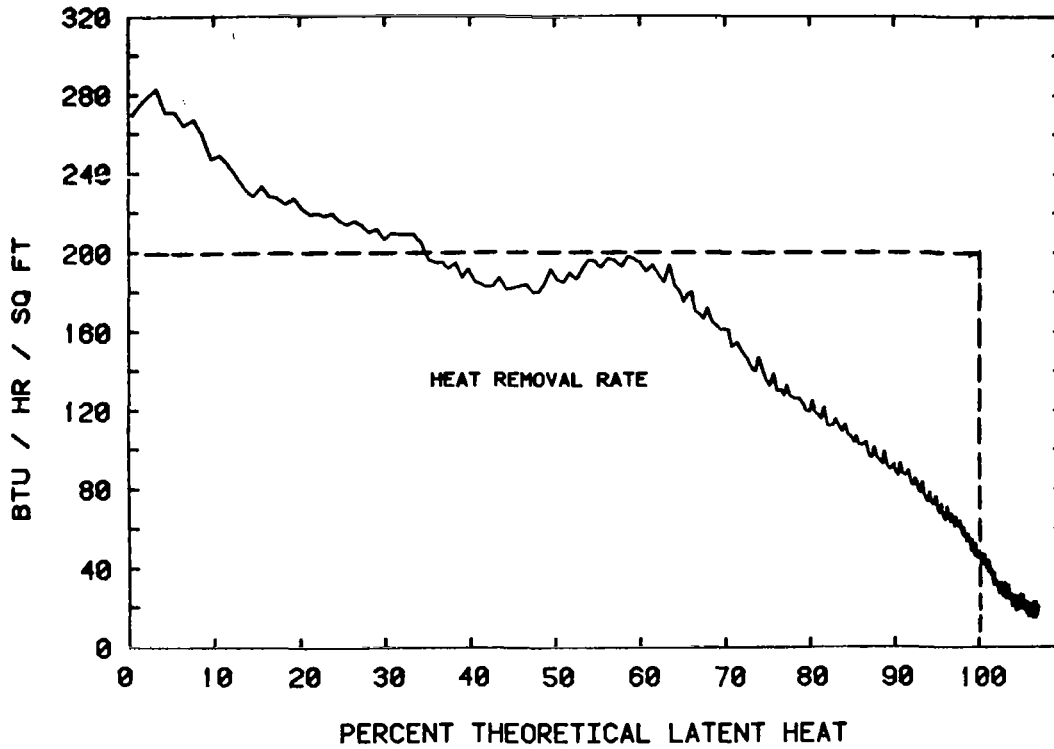

Figure 6 Heat Removal Rate in Run 80 at 3 RPM, 25% Excess Na_2SO_4

It is strongly recommended that comparisons between latent heat storage subsystems be made using diagrams similar to Figures 5 and 6.

Heat Transfer Coefficients:

Figure 7 shows the calculated values of heat transfer coefficients on each side of the cylinder wall. The outside coefficient is the expected value for air under the existing conditions. The inside value is based on the axial temperature and the metal wall temperature and thus is an overall value which includes the effects of mechanical motion or stirring, and diffusion in addition to boundary layer phenomena. The four distinct steps shown here suggest the possible existence of four different behavioral regimes inside the cylinder. Other runs provided less pronounced steps and many showed fewer than four, however all

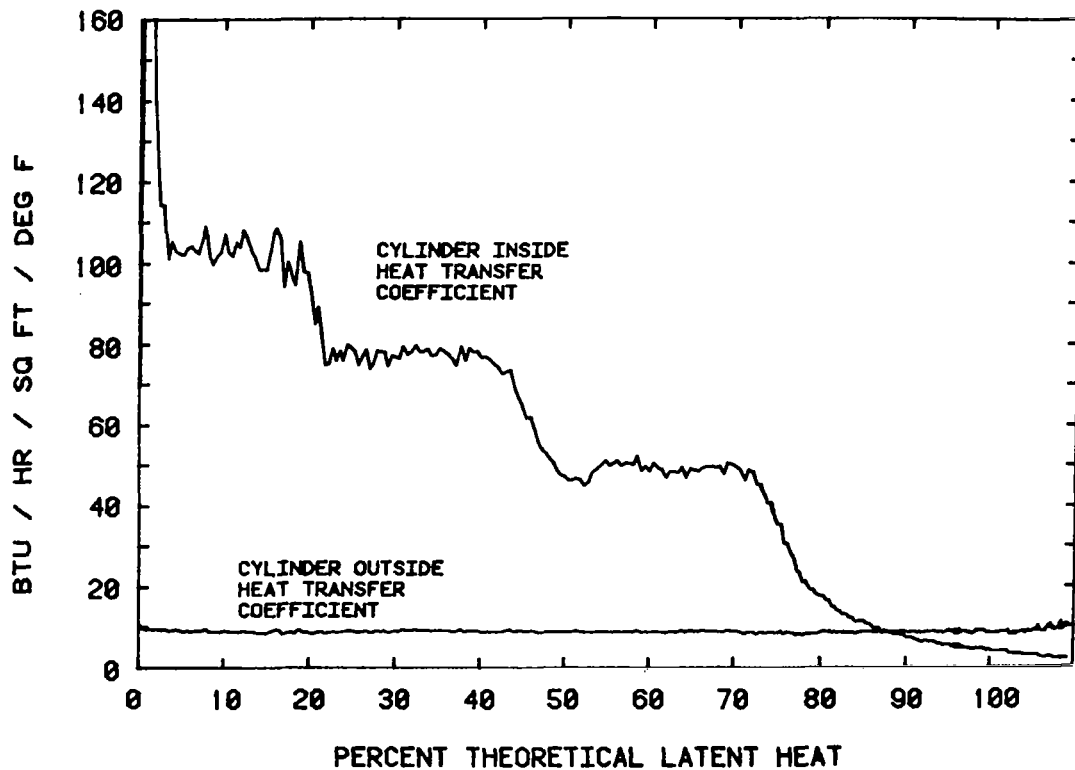

Figure 7 Heat Transfer Coefficients for Run 44, 3 RPM, 25% Excess Na₂SO₄, Cycle 10

showed at least one step. The following identifications are tentatively assigned to the four separate behavioral patterns.

The first step (L to R in Fig. 7) is an artifact created by less-than-perfect liquid mixing in the cylinder at less than 25% of theoretical latent heat. The second step then becomes the initial state of the cylinder contents. The third step represents the introduction of a diffusional barrier probably associated with the encapsulation of Na_2SO_4 by $\text{Na}_2\text{SO}_4 \cdot 10\text{H}_2\text{O}$. The fourth step covers the region in which the solids cease to move relative to the cylinder causing internal heat transport to decline to its lowest level.

Excess Sodium Sulfate:

A newly identified encapsulation effect operates in the rolling cylinder. Individual crystals of sodium sulfate decahydrate and anhydrous sodium sulfate adhere to one another tenaciously when they come into physical contact. Crystals of decahydrate formed early in the freezing process gather up a surface coating of anhydrous crystals due to this mutual adhesive effect. In turn the anhydrous crystals attract a coating of decahydrate. As the freezing process continues alternating layers of the two types accumulate on each growing crystal until all of the anhydrous sodium sulfate is buried beneath a layer of decahydrate. Since the continuing formation of decahydrate (at constant temperature) is dependent upon the availability of some solid anhydrous sodium sulfate it is likely that the encapsulating effect just described will create a visible resistance to the rate of crystallization at some point in the freezing process. In a cylinder containing stoichiometric decahydrate rotating at 3 rpm and cooling at 80 Btu/hr/sq ft this resistance becomes significant at about 45% frozen. At this point the cylinder outside wall temperature begins to fall rapidly because the combined effects of

solid out-diffusion, water in-diffusion, water in-migration along crystal defects, and crystal-crystal grinding is no longer able to provide access to sodium sulfate at the required rate.

The exact details of when this solution starvation point is reached and the size and population of growing crystals depend strongly on the degree of supercooling at the time nucleation occurs. Larger degrees of supercooling lead to larger and fewer growing crystals with deeper burial of anhydrous sodium sulfate in decahydrate.

It should be pointed out that in a stoichiometric mixture without encapsulation the quantity of anhydrous sodium sulfate, and thus its surface area available for reaction with solution to form new decahydrate approaches zero as the freezing reaction nears completion. Thus another form of anhydrous sodium sulfate starvation can be expected to slow down the completion of the reaction.

Both causes of reactant starvation can be effectively relieved by adding an excess of anhydrous sodium sulfate to the system. Figure 8 shows that at 3 rpm a 25% excess extends the high temperature nominally flat portion of the cylinder outside wall temperature to about 75% theoretical latent heat evolved and also allows the mixture to ultimately release 99.7% of theoretical latent heat. This excess causes about a 10% decrease in volumetric heat storage capacity.

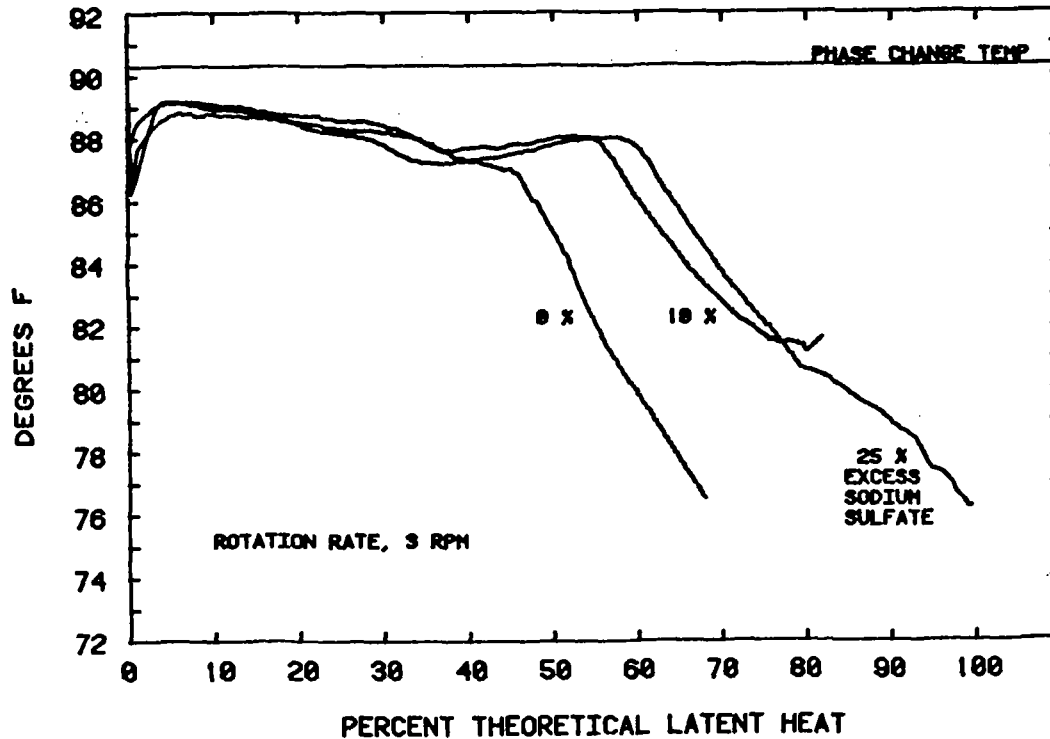

Figure 8 The Effect of Excess Sodium Sulfate on Decahydrate Formation. Cylinder Outside Wall Temperatures for Run 5, 8, 13

Rotation Rate:

Cylinder rotation rate determines the amount of stirring and the radial mixing of cylinder contents. The cylinder outside wall temperature is the best indicator of how well this internal mixing is being carried out. It is also probable

that a significant amount of crystal-crystal grinding results from the rotation. Figure 9 shows the effect of changing rotation rate on the outside wall temperature. There is little difference between speeds of 2 and 3 rpm as well as between 5 and 7 RPM. There is certainly an improvement in performance at the two higher speeds and the effect seems highly non-linear. No explanation for this behavior other than crystal-crystal grinding can be offered at the present time. Rotation rates of 2 or 3 RPM may be usable in working storage systems.

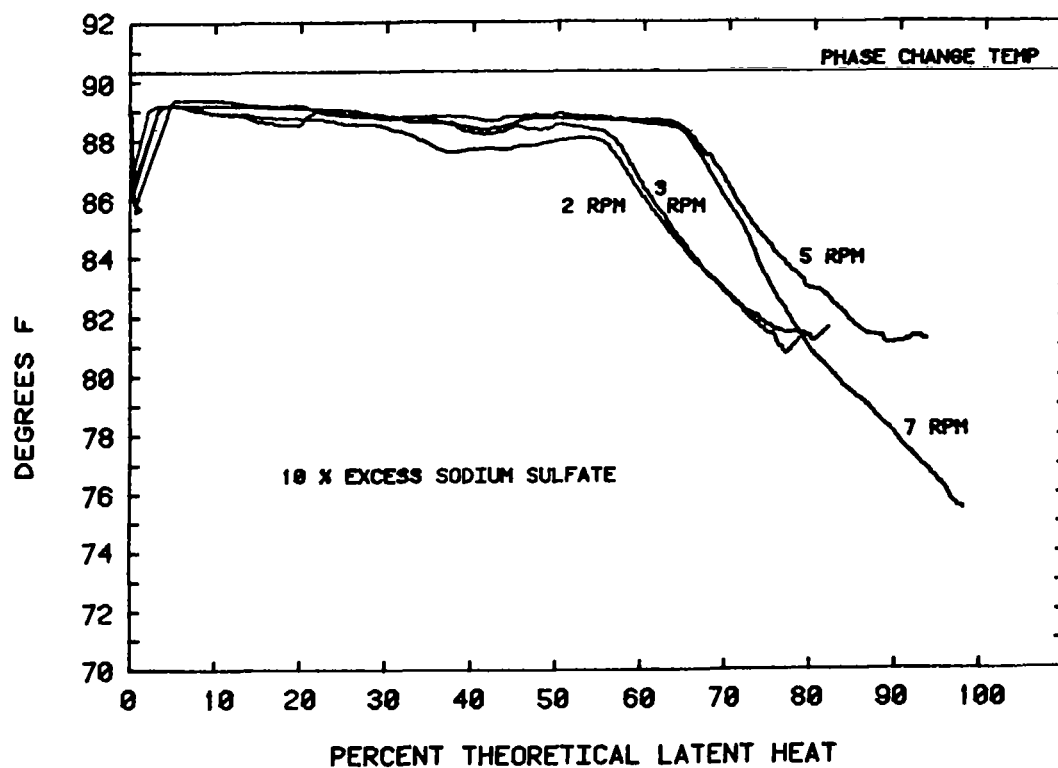

Figure 9 The Effect of Cylinder Rotation Rate on the Outside Wall Temperature

Commercial Sodium Sulfate:

All of the early experiments were done using reagent grade sodium sulfate. Later experiments explored the use of sodium sulfate from four commercial sources, Prior Chemical Company, Ashland Chemical Company, Saskatchewan Chemical Company, and FMC. No differences in behavior were detected. The conclusion is that commercially pure sodium sulfate from most sources will be satisfactory for phase change heat storage in the rolling cylinder.

pH:

Aqueous solutions of sodium sulfate from different sources vary widely in hydrogen ion concentration with reagent grade being acid and commercial grades being usually basic. The effect of pH, if any, on the sodium sulfate decahydrate - sodium sulfate - water system is not known at the present time. pH however is frequently an important variable in many crystallizing systems. To remove the possibility of an uncontrolled variable influencing the experimental results in an unknown way, all sodium sulfate was adjusted to pH 7.0 before use by adding sodium hydroxide or sulfuric acid as appropriate.

Melting

Quantitative measurements of the heat required to melt Glauber's salt were not considered necessary as long as the system continues to yield 100% of the theoretical latent heat (within experimental error) with each refreezing cycle. The melting cycle is quite uneventful but differs somewhat from the refreezing cycle. In cases where refreezing proceeds to 100.0% initial melting produces one large

cylinder of solid which rolls with the rotary motion without causing problems. After a time it separates into the original constituent crystals and re-establishes the same internal flow patterns observed during refreezing.

The melting cycle was usually carried out at about 300 Btu/hr which is 3 times the usual refreezing rate. This high rate was achieved by raising the air temperature flowing over the cylinder. With the 40 mil wall thickness at 10% void space the maximum allowable air temperature was about 140°F. Higher air temperatures caused crystallization of Na_2SO_4 adhered to the cylinder wall and should be avoided. Presumably these events occurred in the thin liquid film on the cylinder wall as it rotates past the void space. Reducing the void space should permit even higher air temperatures.

Melting $\text{Na}_2\text{SO}_4 \cdot 10\text{H}_2\text{O}$ produces solid Na_2SO_4 particles in colloidal sizes. Recrystallization of Na_2SO_4 occurs rapidly so that the crystals are large enough to re-establish the initial solid-liquid flow pattern by the time the melting cycle is finished.

Axial Solids Transport:

The behavior of a long thin rolling cylinder when cooling is applied unevenly along its length has an important effect on heat storage system design. If complete freezing occurs at one end of the cylinder first, then moves progressively along the length of the cylinder to the other end, then the cylinder surface area available for heat transfer is reduced by the fraction of storage material frozen. To meet a selected heating load at a high fraction frozen would require a significant increase in storage size (and cost) over that necessary to meet the same load at a low fraction frozen. Uniform freezing would minimize storage size and cost.

In the calorimetry experiments just described where cylinder $\text{Length/Diameter} = 2$, the freezing process always occurred uniformly throughout the cylinder. It is possible that in some domestic heating systems L/D would have a value of 10 or 20. To evaluate the possibility of uniform freezing in such systems the apparatus of Figure 10 was constructed. L/D was 14. When a step upset was introduced by placing all of the solids at one end of the cylinder the time required to establish equilibrium (at 3 RPM) was always 0.5% of storage discharge time. This rapid equilibration of solids inside the cylinder strongly suggests that cylinders with L/D ratios as large as 20 or more will freeze uniformly due to the rapid internal heat transport by the axial flow of solids.

In a qualitative demonstration of internal heat transport it proved possible to maintain the Fig. 10 cylinder in a steady state by heating one end while cooling

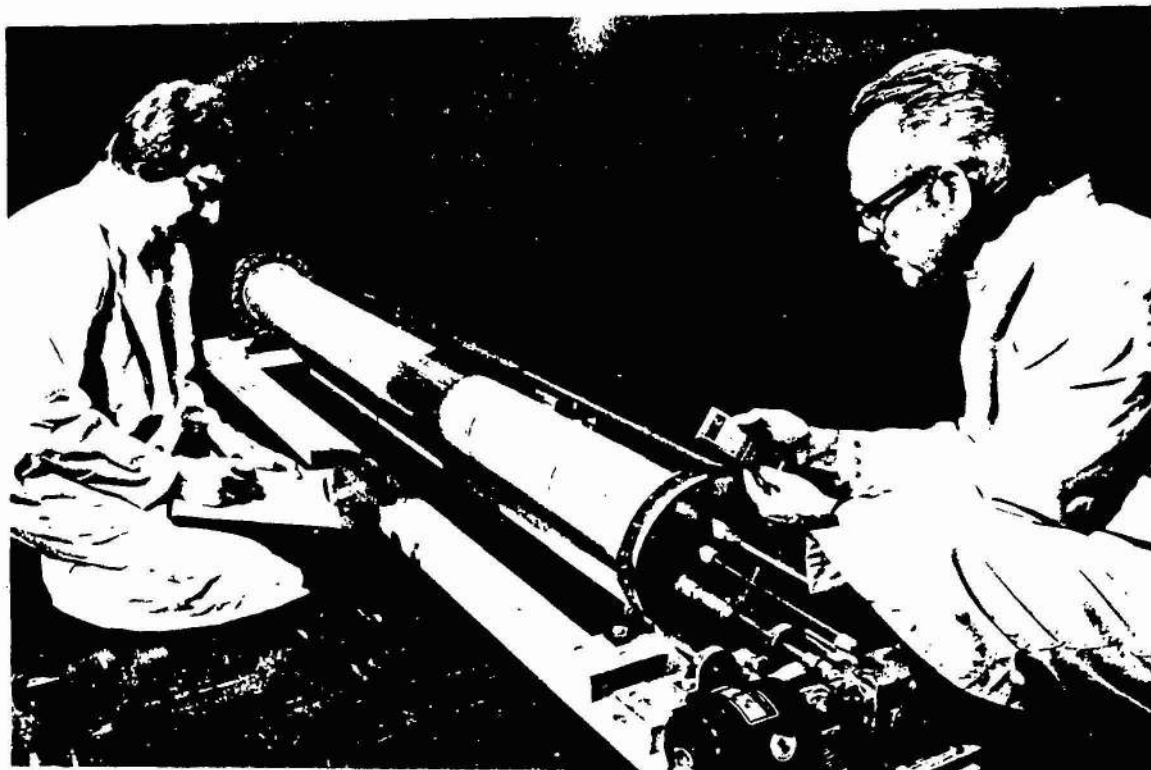

Figure 10 The Axial Solids Transport Experiment Demonstrated Uniform Freezing in Long Cylinders

the other at approximately 100 Btu/hr/sq ft. The accompanying axial flow of solids was rapid enough that no end to end differences in solids levels could be detected visually.

Life Testing:

Life tests are underway at a rate of one freeze/melt cycle per day, or 5 cycles per week. Freezing conditions (room air) are imposed from 4 pm to 8 am next day then melting conditions from 8 am until completely melted, usually about 2 pm. Normally the cylinders are frozen solid without visible amounts of liquid phase remaining.

Calorimetry is done every ten cycles to document possible changes in freezing performance. At the time this text was prepared more than 150 cycles had been completed. There has been no change in the quantity of latent heat evolved upon freezing which remains at 100%. The ability of the system to freeze completely has not been adversely affected by up to 150 freeze-melt cycles.

Summary

The quantity of heat stored and the heat flow rates achieved have been measured in a laboratory sized rolling cylinder. In general the promises of good performance based on earlier qualitative results have been fulfilled. This report provides a brief summary of the quantitative evidence which has been accumulated to support the following statements concerning the rolling cylinder with Glauber's salt.

- Complete phase change
- Theoretical latent heat release
- Repeatable performance over 150 cycles
- High heat release rates
- High internal heat transfer rates
- High heat exchanger surface temperatures
- Commercial source salts are satisfactory
- Freezing occurs uniformly

Conclusion

The quantitative laboratory scale results suggest that the rolling cylinder will be a high performance low temperature thermal storage device. No technical barriers were discovered to the further development of the rolling cylinder thermal storage device.

Acknowledgement

We thank D. B. Sorenson and B. J. Lederman for advice and assistance with the instrument and computer aspects of this effort. The work described here was partially funded by the United States Department of Energy.