

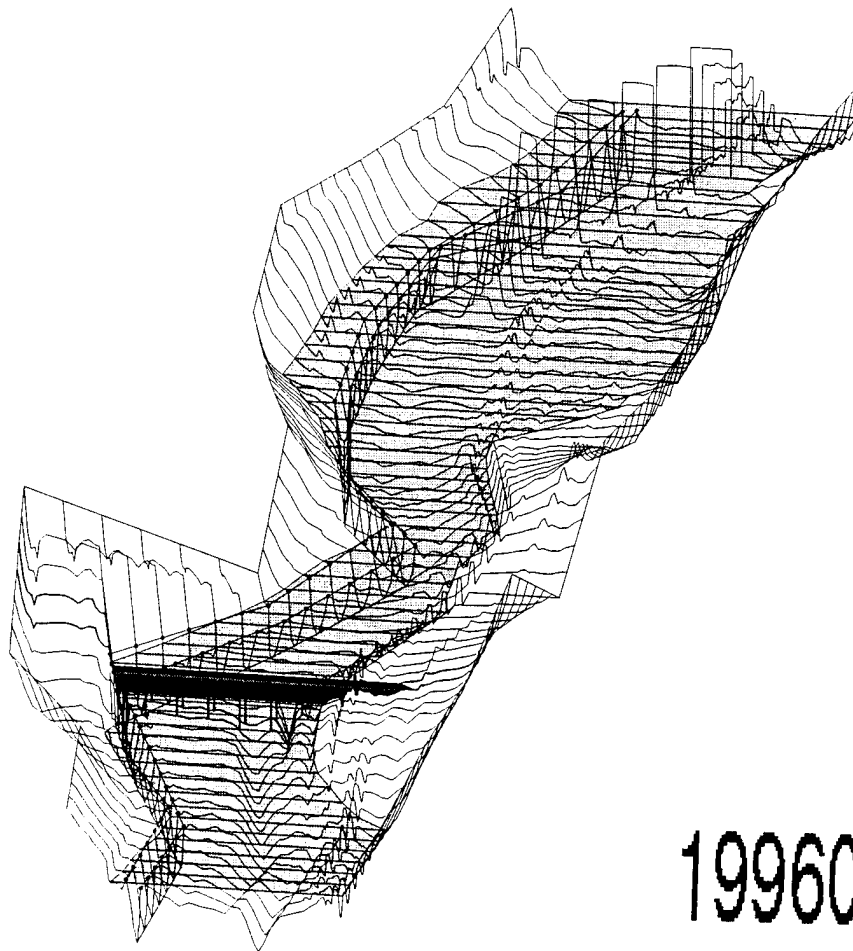

US Army Corps
of Engineers
Hydrologic Engineering Center

HEC-RAS

River Analysis System



19960807 018

Hydraulic Reference Manual

Version 1.0
July 1995

DTIC QUALITY INSPECTED 1

CPD-69

Approved for Public Release. Distribution is unlimited.

HEC-RAS

River Analysis System

Hydraulic Reference Manual

Version 1.0

July 1995

US Army Corps of Engineers
Hydrologic Engineering Center
609 Second Street
Davis, CA 95616

(916) 756-1104
(916) 756-8250 FAX

CPD-69

Table of Contents

Foreword	iv
Chapter 1 Introduction	1-1
General Philosophy of the Modeling System	1-2
Overview of Hydraulic Capabilities	1-2
HEC-RAS Documentation	1-4
Overview of This Manual	1-4
Chapter 2 Theoretical Basis for One-Dimensional Flow Calculations	2-1
General	2-2
Steady Flow Water Surface Profiles	2-2
Equations for Basic Profile Calculations	2-2
Cross Section Subdivision for Conveyance Calculations	2-4
Composite Manning's n for the Main Channel	2-6
Velocity Coefficient Alpha	2-8
Friction Loss Evaluation	2-8
Contraction and Expansion Loss Evaluation	2-9
Computation Procedure	2-10
Critical Depth Determination	2-12
Applications of the Momentum Equation	2-15
Program Limitations	2-19
Chapter 3 Basic Data Requirements	3-1
General	3-2
Geometric Data	3-2
The River System Schematic	3-2
Cross Section Geometry	3-4
Optional Cross Section Properties	3-6
Ineffective Flow Areas	3-6
Levees	3-7
Blocked Obstructions	3-8
Reach Lengths	3-10
Energy Loss Coefficients	3-11
Manning's n	3-11
Contraction and Expansion Coefficients	3-17
Stream Junction Data	3-18
Steady Flow Data	3-19
Flow Regime	3-19
Boundary Conditions	3-19
Discharge Information	3-21

Chapter 4 Overview of Optional Capabilities	4-1
Multiple Profile Analysis	4-2
Multiple Plan Analysis	4-2
Optional Friction Loss Equations	4-2
Cross Section Interpolation	4-4
Mixed Flow Regime Calculations	4-6
Modeling Stream Junctions	4-9
Energy Based Junction Method	4-9
Momentum Based Junction Method	4-15
Flow Distribution Calculations	4-19
Chapter 5 Modeling Bridges	5-1
General Modeling Guidelines	5-2
Cross Section Locations	5-2
Defining Ineffective Flow Areas	5-4
Contraction and Expansion Losses	5-6
Hydraulic Computations Through the Bridge	5-7
Low Flow Computations	5-7
Class A Low Flow	5-8
Class B Low Flow	5-13
Class C Low Flow	5-13
High Flow Computations	5-14
Energy Equation	5-14
Pressure and Weir Flow Method	5-14
Combination Flow	5-20
Selecting a Bridge Modeling Approach	5-21
Low Flow Methods	5-21
High Flow Methods	5-22
Unique Bridge Problems and Suggested Approaches	5-23
Perched Bridges	5-23
Low Water Bridges	5-23
Bridges on a Skew	5-23
Parallel Bridges	5-24
Multiple Bridge Openings	5-24
Chapter 6 Modeling Culverts	6-1
General Modeling Guidelines	6-2
Types of Culverts	6-2
Cross Section Locations	6-3
Expansion and Contraction Coefficients	6-6
Limitations of the Culvert Routines	6-7
Culvert Hydraulics	6-7
Introduction to Culvert Terminology	6-7
Flow Analysis for Culverts	6-9
Computing Inlet Control Headwater	6-10
Computing Outlet Control Headwater	6-10
FHWA Full Flow Equations	6-12

Direct Step Water Surface Profile Computations	6-13
Normal Depth of Flow in the Culvert	6-14
Critical Depth of Flow in the Culvert	6-14
Horizontal Culvert Slope	6-15
Weir Flow	6-15
Supercritical Culvert Flow	6-16
Culvert Data and Coefficients	6-16
Culvert Shape and Size	6-16
Culvert Length	6-17
Number of Identical Barrels	6-17
Manning's Roughness Coefficient	6-17
Entrance Loss Coefficient	6-19
Exit Loss Coefficient	6-21
FHWA Chart and Scale Number	6-22
Culvert Invert Elevations	6-27
Weir Flow Coefficient	6-28
Chapter 7 Modeling Multiple Bridge and/or Culvert Openings	7-1
General Modeling Guidelines	7-2
Multiple Opening Approach	7-2
Locating the Stagnation Points	7-4
Computational Procedure for Multiple Openings	7-5
Limitations of the Multiple Opening Approach	7-6
Divided Flow Approach	7-7
Chapter 8 Floodway Encroachment Calculations	8-1
Introduction	8-2
Encroachment Methods	8-2
Encroachment Method 1	8-2
Encroachment Method 2	8-3
Encroachment Method 3	8-4
Encroachment Method 4	8-5
Encroachment Method 5	8-6
Bridge, Culvert, and Multiple Opening Encroachments	8-7
General Modeling Guidelines	8-8
Appendix A References	A-1

Foreword

The HEC-RAS software was developed at the Hydrologic Engineering Center (HEC). The software was designed by Mr. Gary W. Brunner, leader of the HEC-RAS development team. The user interface and graphics were programmed by Mr. Mark R. Jensen. The steady flow water surface profiles module was programmed by Mr. Steven S. Piper. The routines that import HEC-2 data were developed by Ms. Joan Klipsch. The cross section interpolation routines were developed by Mr. Alfredo Mantalvo.

Many of the HEC staff made contributions in the development of this software, including: Vern R. Bonner, Richard Hayes, John Peters, and Michael Gee. Mr. Darryl Davis was the director of HEC during the development of this software..

This manual was written by Mr. Gary W. Brunner.

CHAPTER 1

Introduction

Welcome to the Hydrologic Engineering Center's River Analysis System (HEC-RAS). This software allows you to perform one-dimensional steady flow, unsteady flow, and sediment transport calculations.

The current version of HEC-RAS only supports one-dimensional, steady flow, water surface profile calculations. This manual specifically documents the hydraulic capabilities of the Steady flow portion of HEC-RAS. Documentation for unsteady flow and sediment transport calculations will be made available as these features are added to the HEC-RAS.

This chapter discusses the general philosophy of HEC-RAS and gives you a brief overview of the hydraulic capabilities of the modeling system. Documentation for HEC-RAS is discussed, as well as an overview of this manual.

Contents

- General Philosophy of the Modeling System
- Overview of Hydraulic Capabilities
- HEC-RAS Documentation
- Overview of This Manual

General Philosophy of the Modeling System

HEC-RAS is an integrated system of software, designed for interactive use in a multi-tasking, multi-user network environment. The system is comprised of a graphical user interface (GUI), separate hydraulic analysis components, data storage and management capabilities, graphics and reporting facilities.

The system contains three one-dimensional hydraulic analysis components for: (1) steady flow water surface profile computations; (2) unsteady flow simulation; and (3) movable boundary sediment transport computations. A key element is that all three components use a common geometric data representation and common geometric and hydraulic computation routines. In addition to the three hydraulic analysis components, the system contains several hydraulic design features that can be invoked once the basic water surface profiles are computed.

The current version of HEC-RAS only supports Steady Flow water surface profile calculations. New features and additional capabilities will be added in future releases.

Overview of Hydraulic Capabilities

HEC-RAS is designed to perform one-dimensional hydraulic calculations for a full network of natural and constructed channels. The following is a description of the major hydraulic capabilities of HEC-RAS.

Steady Flow Water Surface Profiles. This component of the modeling system is intended for calculating water surface profiles for steady gradually varied flow. The system can handle a full network of channels, a dendritic system, or a single river reach. The steady flow component is capable of modeling subcritical, supercritical, and mixed flow regime water surface profiles.

The basic computational procedure is based on the solution of the one-dimensional energy equation. Energy losses are evaluated by friction (Manning's equation) and contraction/expansion (coefficient multiplied by the change in velocity head). The momentum equation is utilized in situations where the water surface profile is rapidly varied. These situations include mixed flow regime calculations (i.e. hydraulic jumps), hydraulics of bridges, and evaluating profiles at river confluences (stream junctions).

The effects of various obstructions such as bridges, culverts, weirs, and structures in the flood plain may be considered in the computations. The steady flow system is designed for application in flood plain management and flood insurance studies to evaluate floodway encroachments. Also,

capabilities are available for assessing the change in water surface profiles due to channel improvements, levees, and ice cover.

Special features of the steady flow component include: multiple plan analyses; multiple profile computations; optimization of flow splits; automatic n-value calibration; and multiple bridge and/or culvert opening analysis.

Unsteady Flow Simulation. This component of the HEC-RAS modeling system is capable of simulating one-dimensional unsteady flow through a full network of open channels. The unsteady flow equation solver has been adapted from Dr. Robert L. Barkau's UNET model (Barkau, 1992 and HEC, 1993). This unsteady flow component was developed primarily for subcritical flow regime calculations.

The hydraulic calculations for cross-sections, bridges, culverts, and other hydraulic structures that were developed for the steady flow component have been incorporated into the unsteady flow module. Additionally, the unsteady flow component has the ability to model storage areas, navigation dams, gated spillways, tunnels, pumping stations, and levee failures.

Sediment Transport/Movable Boundary Computations. This component of the modeling system is intended for the simulation of one-dimensional sediment transport/movable boundary calculations resulting from scour and deposition over moderate time periods (typically years, although applications to single flood events are possible).

The sediment transport potential is computed by grain size fraction, thereby allowing the simulation of hydraulic sorting and armoring. Major features include the ability to model a full network of streams, channel dredging, various levee and encroachment alternatives, and the use of several different equations for the computation of sediment transport.

The model is designed to simulate long-term trends of scour and deposition in a stream channel that might result from modifying the frequency and duration of the water discharge and stage, or modifying the channel geometry. This system can be used to evaluate deposition in reservoirs, design channel contractions required to maintain navigation depths, predict the influence of dredging on the rate of deposition, estimate maximum possible scour during large flood events, and evaluate sedimentation in fixed channels.

HEC-RAS Documentation

The HEC-RAS package includes several documents, each are designed to help the modeler learn to use a particular aspect of the modeling system. The documentation has been divided into the following three categories:

Documentation	Description
<i>User's Manual</i>	This manual is a guide to using the HEC-RAS. The manual provides an introduction and overview of the modeling system, installation instructions, how to get started, simple examples, detailed descriptions of each of the major modeling components, and how to view graphical and tabular output.
<i>Hydraulic Reference Manual</i>	This manual describes the theory and data requirements for the hydraulic calculations performed by HEC-RAS. Equations are presented along with the assumptions used in their derivation. Discussions are provided on how to estimate model parameters, as well as guidelines on various modeling approaches.
<i>Applications Guide</i>	This document contains a series of examples that demonstrate various aspects of the HEC-RAS. Each example consists of a problem statement, data requirements, general outline of solution steps, displays of key input and output screens, and discussions of important modeling aspects.

Overview of This Manual

This manual presents the theory and data requirements for hydraulic calculations in the HEC-RAS system. The manual is organized as follows:

- Chapter 2 provides an overview of the hydraulic calculations in HEC-RAS.
- Chapter 3 describes the basic data requirements to perform the various hydraulic analyses available.
- Chapter 4 is an overview of some of the optional hydraulic

capabilities of the HEC-RAS software.

- Chapters 5, 6, and 7 provide detailed discussions on modeling bridges and culverts.
- Chapter 8 describes how to perform floodway encroachment calculations.

CHAPTER 2

Theoretical Basis for One-Dimensional Flow Calculations

This chapter describes the methodologies used in performing the one-dimensional flow calculations within HEC-RAS. The basic equations are presented along with discussions of the various terms. Solution schemes for the various equations are described. Discussions are provided as to how the equations should be applied, as well as applicable limitations.

Contents

- General
- Steady Flow Water Surface Profiles

General

This chapter describes the theoretical basis for one-dimensional water surface profile calculations. This chapter is currently limited to discussions about steady flow water surface profile calculations. When unsteady flow and sediment transport calculations are added to the HEC-RAS system, discussions concerning these topics will be included in this manual.

Steady Flow Water Surface Profiles

HEC-RAS is currently capable of performing one-dimensional water surface profile calculations for steady gradually varied flow in natural or constructed channels. Subcritical, supercritical, and mixed flow regime water surface profiles can be calculated. Topics discussed in this section include: equations for basic profile calculations; cross section subdivision for conveyance calculations; composite Manning's n for the main channel; velocity weighting coefficient alpha; friction loss evaluation; contraction and expansion losses; computational procedure; critical depth determination; applications of the momentum equation; and limitations of the steady flow model.

Equations for Basic Profile Calculations

Water surface profiles are computed from one cross section to the next by solving the Energy equation with an iterative procedure called the standard step method. The Energy equation is written as follows:

$$WS_2 + \frac{\alpha_2 V_2^2}{2g} = WS_1 + \frac{\alpha_1 V_1^2}{2g} + h_e \quad (2-1)$$

Where: WS_1, WS_2 = water surface elevations at cross sections

V_1, V_2 = average velocities (total discharge/ total flow area)

α_1, α_2 = velocity weighting coefficients

g = gravitational acceleration

h_e = energy head loss

A diagram showing the terms of the energy equation is shown in Figure 2-1.

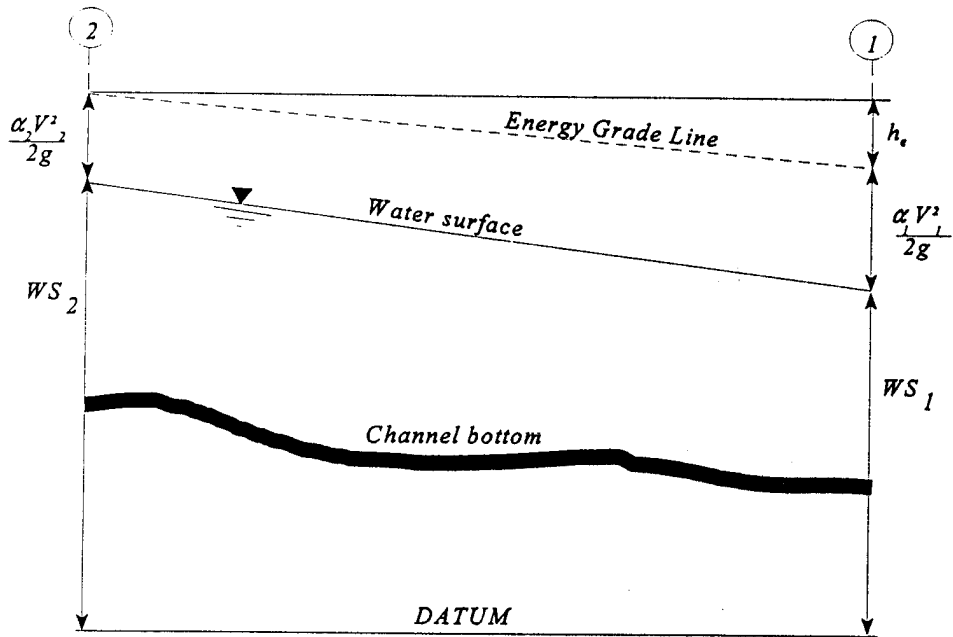

Figure 2.1 Representation of Terms in the Energy Equation

The energy head loss (h_e) between two cross sections is comprised of friction losses and contraction or expansion losses. The equation for the energy head loss is as follows:

$$h_e = L \bar{S}_f + C \left| \frac{\alpha_2 V_2^2}{2g} - \frac{\alpha_1 V_1^2}{2g} \right| \quad (2-2)$$

Where: L = discharge weighted reach length

\bar{S}_f = representative friction slope between two sections

C = expansion or contraction loss coefficient

The distance weighted reach length, L , is calculated as:

$$L = \frac{L_{lob} \bar{Q}_{lob} + L_{ch} \bar{Q}_{ch} + L_{rob} \bar{Q}_{rob}}{\bar{Q}_{lob} + \bar{Q}_{ch} + \bar{Q}_{rob}} \quad (2-3)$$

Where: L_{lob} , L_{ch} , L_{rob} = cross section reach lengths specified for flow in the left overbank, main channel, and right overbank, respectively

\bar{Q}_{lob} , \bar{Q}_{ch} , \bar{Q}_{rob} = arithmetic average of the flows between sections for the left overbank, main channel, and right overbank, respectively

Cross Section Subdivision for Conveyance Calculations

The determination of total conveyance and the velocity coefficient for a cross section requires that flow be subdivided into units for which the velocity is uniformly distributed. The approach used in HEC-RAS is to subdivide flow in the **overbank** areas using the input cross section n-value break points (locations where n-values change) as the basis for subdivision (Figure 2-2). Conveyance is calculated within each subdivision by the following equation (based on English units):

$$K = \frac{1.486}{n} A R^{2/3} \quad (2-4)$$

where: K = conveyance for subdivision

n = Manning's roughness coefficient for subdivision

A = flow area for subdivision

R = hydraulic radius for subdivision (area / wetted perimeter)

The program sums up all the incremental conveyances in the overbanks to obtain a conveyance for the left overbank and the right overbank. The main channel conveyance is normally computed as a single conveyance element. The total conveyance for the cross section is obtained by summing the three subdivision conveyances (left, channel, and right).

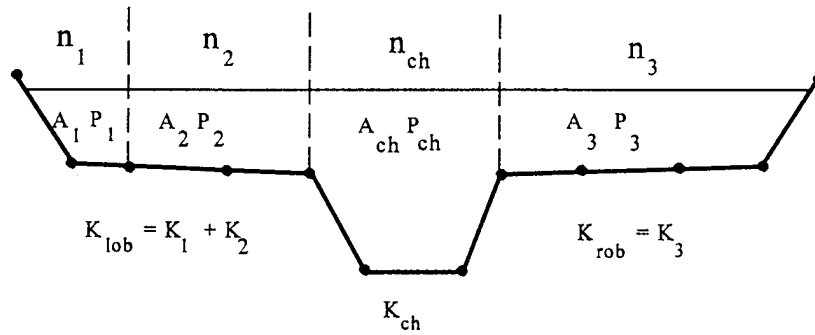

Figure 2.2 HEC-RAS Default Conveyance Subdivision

An alternative method available in HEC-RAS is to calculate conveyance between every coordinate point in the overbanks (Figure 2.3). The conveyance is then summed to get the total left overbank and right overbank values. This method is used in the Corps HEC-2 program. The method has been retained as an option within HEC-RAS in order to reproduce studies that were originally developed with HEC-2.

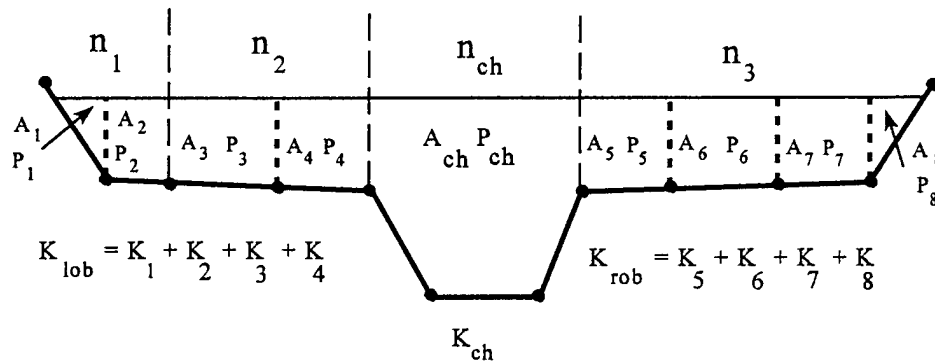

Figure 2.3 Alternative Conveyance Subdivision Method (HEC-2 style)

The two methods for computing conveyance will produce different answers whenever portions of the overbanks have ground sections with significant vertical slopes. In general, the HEC-RAS default approach will provide a lower total conveyance for the same water surface elevation.

In order to test the significance of the two ways of computing conveyance, comparisons were performed using 97 data sets from the HEC profile accuracy study (HEC, 1986). Water surface profiles were computed for the 1% chance event using the two methods for computing conveyance in HEC-RAS. The results of the study showed that the HEC-RAS default approach will generally produce a higher computed water surface elevation. Out of the 2048 cross section locations, 47.5% had computed water surface elevations within 0.10 ft. (30.48 mm), 71% within 0.20 ft. (60.96 mm), 94.4% within 0.4 ft. (121.92 mm), 99.4% within 1.0 ft. (304.8 mm), and one cross section had a difference of 2.75 ft. (0.84 m). Because the differences tend to be in the same direction, some effects can be attributed to propagation of downstream differences.

The results from these comparisons do not show which method is more accurate, they only show differences. In general, it is felt that the HEC-RAS default method is more commensurate with the Manning equation and the concept of separate flow elements. Further research, with observed water surface profiles, will be needed to make any conclusions about the accuracy of the two methods.

Composite Manning's n for the Main Channel

Flow in the **main channel** is not subdivided, except when the roughness coefficient is changed within the channel area. HEC-RAS tests the applicability of subdivision of roughness within the main channel portion of a cross section, and if it is not applicable, the program will compute a single composite n value for the entire main channel. The program determines if the main channel portion of the cross section can be subdivided or if a composite main channel n value will be utilized based on the following criterion: if a main channel side slope is steeper than 5H:1V and the main channel has more than one n -value, a composite roughness n_c will be computed [Equation 6-17, Chow, 1959]. The channel side slope used by HEC-RAS is defined as the horizontal distance between adjacent n -value stations within the main channel over the difference in elevation of these two stations (see S_L and S_R of Figure 2.4).

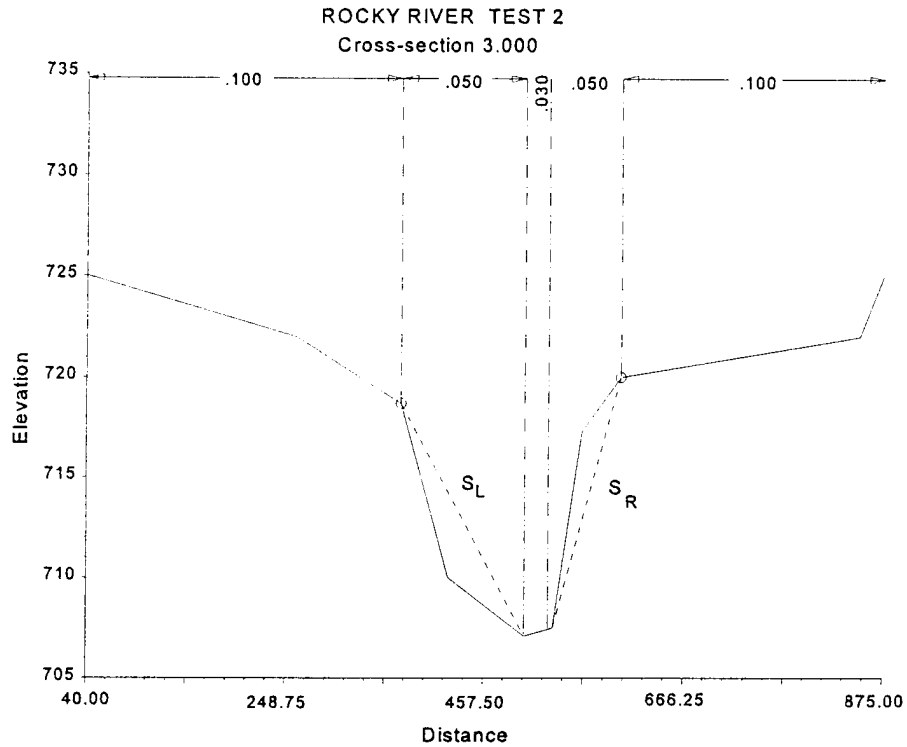

Figure 2.4 Definition of Bank Slope for Composite n_c Calculation

For the determination of n_c , the main channel is divided into N parts, each with a known wetted perimeter P_i and roughness coefficient n_i .

$$n_c = \left[\frac{\sum_{i=1}^N (P_i n_i^{1.5})}{P} \right]^{2/3} \quad (2-5)$$

- where: n_c = composite or equivalent coefficient of roughness
- P = wetted perimeter of entire main channel
- P_i = wetted perimeter of subdivision I
- n_i = coefficient of roughness for subdivision I

The computed composite n_c should be checked for reasonableness. The computed value is the composite main channel n value in the output and summary tables.

Velocity Coefficient Alpha

The velocity coefficient, α , is computed based on the conveyance in the three flow elements: left overbank, right overbank, and channel. It is obtained with the following equation:

$$\alpha = \frac{(A_t)^2 \left[\frac{(K_{lob})^3}{(A_{lob})^2} + \frac{(K_{ch})^3}{(A_{ch})^2} + \frac{(K_{rob})^3}{(A_{rob})^2} \right]}{(K_t)^3} \quad (2-6)$$

where: A_t = total flow area of cross section

A_{lob}, A_{ch}, A_{rob} = flow areas of left overbank, main channel and right overbank, respectively

K_t = total conveyance of cross section

K_{lob}, K_{ch}, K_{rob} = conveyances of left overbank, main channel and right overbank, respectively

Friction Loss Evaluation

Friction loss is evaluated in HEC-RAS as the product of \bar{S}_f and L (Equation 2-2), where \bar{S}_f is the representative friction slope for a reach and L is defined by Equation 2-3. The friction slope (slope of the energy gradeline) at each cross section is computed from Manning's equation as follows:

$$S_f = \left(\frac{Q}{K} \right)^2 \quad (2-7)$$

Alternative expressions for the representative reach friction slope (\bar{S}_f) in HEC-RAS are as follows:

Average Conveyance Equation

$$\bar{S}_f = \left(\frac{Q_1 + Q_2}{K_1 + K_2} \right)^2 \quad (2-8)$$

Average Friction Slope Equation

$$\bar{S}_f = \frac{S_{f_1} + S_{f_2}}{2} \quad (2-9)$$

Geometric Mean Friction Slope Equation

$$\bar{S}_f = \sqrt{S_{f_1} \cdot S_{f_2}} \quad (2-10)$$

Harmonic Mean Friction Slope Equation

$$\bar{S}_f = \frac{2 S_{f_1} \cdot S_{f_2}}{S_{f_1} + S_{f_2}} \quad (2-11)$$

Equation 2-8 is the 'default' equation used by the program; that is, it is used automatically unless a different equation is requested by input. The program also contains an option to select equations, depending on flow regime and profile type (e.g., S1, M1, etc.). Further discussion of the alternative methods for evaluating friction loss is contained in Chapter 4, "Overview of Optional Capabilities."

Contraction and Expansion Loss Evaluation

Contraction and expansion losses in HEC-RAS are evaluated by the following equation:

$$h_o = C \left| \alpha_1 \frac{V_1^2}{2g} - \alpha_2 \frac{V_2^2}{2g} \right| \quad (2-12)$$

Where: C = The contraction or expansion coefficient.

The program assumes that a contraction is occurring whenever the velocity head downstream is greater than the velocity head upstream. Likewise, when the velocity head upstream is greater than the velocity head downstream, the program assumes that a flow expansion is occurring. Typical "C" values can be found in Chapter 3, "Basic Data Requirements."

Computation Procedure

The unknown water surface elevation at a cross section is determined by an iterative solution of Equations 2-1 and 2-2. The computational procedure is as follows:

1. Assume a water surface elevation at the upstream cross section (or downstream cross section if a supercritical profile is being calculated).
2. Based on the assumed water surface elevation, determine the corresponding total conveyance and velocity head.
3. With values from step 2, compute \bar{S}_f and solve Equation 2-2 for h_c .
4. With values from steps 2 and 3, solve Equation 2-1 for WS_2 .
5. Compare the computed value of WS_2 with the value assumed in step 1; repeat steps 1 through 5 until the values agree to within .01 feet (.003 m), or the user-defined tolerance.

The criterion used to assume water surface elevations in the iterative procedure varies from trial to trial. The first trial water surface is based on projecting the previous cross section's water depth onto the current cross section. The second trial water surface elevation is set to the assumed water surface elevation plus 70% of the error from the first trial (computed W.S. - assumed W.S.). In other words, $W.S. \text{ new} = W.S. \text{ assumed} + 0.70 * (W.S. \text{ computed} - W.S. \text{ assumed})$. The third and subsequent trials are generally based on a "Secant" method of projecting the rate of change of the difference between computed and assumed elevations for the previous two trials. The equation for the secant method is as follows:

$$WS_1 = WS_{1,2} - Err_{1,2} * Err_Assum / Err_Diff \quad (2-13)$$

- where:
- WS_1 = the new assumed water surface.
 - $WS_{1,1}$ = the previous iteration's assumed water surface.
 - $WS_{1,2}$ = the assumed water surface from two trials previous.
 - $Err_{1,2}$ = the error from two trials previous (Computed water surface minus assumed from the I-2 iteration).
 - Err_Assum = the difference in assumed water surfaces from the

previous two trials. $Err_Assum = WS_{I,2} - WS_{I,1}$.

Err_Diff = the assumed water surface minus the calculated water surface from the previous iteration (I-1), plus the error from two trials previous ($Err_{I,2}$).
 $Err_Diff = WS_{I,1} - WS_{Calc_{I,1}} + Err_{I,2}$.

The change from one trial to the next is constrained to a maximum of ± 50 percent of the assumed depth from the previous trial. On occasion the secant method can fail if the value of Err_Diff becomes too small. If the Err_Diff is less than $1.0E-10$, then the secant method is not used. When this occurs, the program computes a new guess by taking the average of the assumed and computed water surfaces from the previous iteration.

The program is constrained by a *maximum number of iterations* (the default is 20) for balancing the water surface. While the program is iterating, it keeps track of the water surface that produces the minimum amount of error between the assumed and computed values. This water surface is called the *minimum error water surface*. If the maximum number of iterations is reached before a balanced water surface is achieved, the program will then calculate critical depth (if this has not already been done). The program then checks to see if the error associated with the *minimum error water surface* is within a predefined tolerance (the default is 0.3 ft or 0.1 m). If the minimum error water surface has an associated error less than the predefined tolerance, and this water surface is on the correct side of critical depth, then the program will use this water surface as the final answer and set a warning message that it has done so. If the minimum error water surface has an associated error that is greater than the predefined tolerance, or it is on the wrong side of critical depth, the program will use critical depth as the final answer for the cross section and set a warning message that it has done so. The rationale for using the minimum error water surface is that it is probably a better answer than critical depth, as long as the above criteria are met. Both the minimum error water surface and critical depth are only used in this situation to allow the program to continue the solution of the water surface profile. Neither of these two answers are considered to be valid solutions, and therefore warning messages are issued when either is used. In general, when the program can not balance the energy equation at a cross section, it is usually caused by an inadequate number of cross sections (cross sections spaced too far apart) or bad cross section data. Occasionally, this can occur because the program is attempting to calculate a subcritical water surface when the flow regime is actually supercritical.

When a “balanced” water surface elevation has been obtained for a cross section, checks are made to ascertain that the elevation is on the “right” side of the critical water surface elevation (e.g., above the critical elevation if a subcritical profile has been requested by the user). If the balanced elevation is on the “wrong” side of the critical water surface elevation, critical depth is

assumed for the cross section and a "warning" message to that effect is displayed by the program. The program user should be aware of critical depth assumptions and determine the reasons for their occurrence, because in many cases they result from reach lengths being too long or from misrepresentation of the effective flow areas of cross sections.

For a subcritical profile, a preliminary check for proper flow regime involves checking the Froude number. The program calculates the Froude number of the "balanced" water surface for both the main channel only and the entire cross section. If either of these two Froude numbers are greater than 0.94, then the program will check the flow regime by calculating a more accurate estimate of critical depth using the minimum specific energy method (this method is described in the next section). A Froude number of 0.94 is used instead of 1.0, because the calculation of Froude number in irregular channels is not accurate. Therefore, using a value of 0.94 is conservative, in that the program will calculate critical depth more often than it may need to.

For a supercritical profile, critical depth is automatically calculated for every cross section, which enables a direct comparison between balanced and critical elevations.

Critical Depth Determination

Critical depth for a cross section will be determined if any of the following conditions are satisfied:

- (1) The supercritical flow regime has been specified.
- (2) The calculation of critical depth has been requested by the user.
- (3) This is an external boundary cross section and critical depth must be determined to ensure the user entered boundary condition is in the correct flow regime.
- (4) The Froude number check for a subcritical profile indicates that critical depth needs to be determined to verify the flow regime associated with the balanced elevation.
- (5) The program could not balance the energy equation within the specified tolerance before reaching the maximum number of iterations.

The total energy head for a cross section is defined by:

$$H = WS + \frac{\alpha V^2}{2g} \quad (2-14)$$

where: H = total energy head
 WS = water surface elevation
 $\frac{\alpha V^2}{2g}$ = velocity head

The critical water surface elevation is the elevation for which the total energy head is a minimum (i.e. minimum specific energy for that cross section for the given flow). The critical elevation is determined with an iterative procedure whereby values of WS are assumed and corresponding values of H are determined with Equation 2-14 until a minimum value for H is reached.

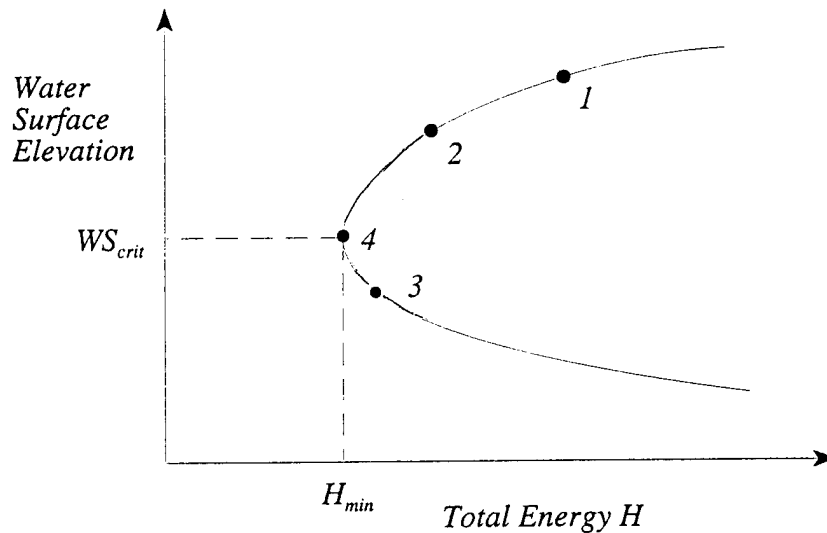

Figure 2.5 Energy vs Water surface elevation diagram

The HEC-RAS program has two methods for calculating critical depth: a "parabolic" method and a "secant" method. The parabolic method is computationally faster, but it is only able to locate a single minimum energy. For most cross sections there will only be one minimum on the total energy curve, therefore the parabolic method has been set as the default method (the default method can be changed from the user interface). If the parabolic method is tried and it does not converge, then the program will automatically try the secant method.

In certain situations it is possible to have more than one minimum on the total energy curve. Multiple minimums are often associated with cross sections that have breaks in the total energy curve. These breaks can occur do to very wide and flat overbanks, as well as cross sections with levees and ineffective

flow areas. When the parabolic method is used on a cross section that has multiple minimums on the total energy curve, the method will converge on the first minimum that it locates. This approach can lead to incorrect estimates of critical depth. If the user thinks that the program has incorrectly located critical depth, then the secant method should be selected and the model should be re-simulated.

The "parabolic" method involves determining values of H for three values of WS that are spaced at equal ΔWS intervals. The WS corresponding to the minimum value for H , defined by a parabola passing through the three points on the H versus WS plane, is used as the basis for the next assumption of a value for WS . It is presumed that critical depth has been obtained when there is less than a 0.01 ft. (0.003 m) change in water depth from one iteration to the next and provided the energy head has not either decreased or increased by more than .01 feet (0.003 m).

The "secant" method first creates a table of water surface versus energy by slicing the cross section into 30 intervals. If the maximum height of the cross section (highest point to lowest point) is less than 1.5 times the maximum height of the main channel (from the highest main channels bank station to the invert), then the program slices the entire cross section into 30 equal intervals. If this is not the case, the program uses 25 equal intervals from the invert to the highest main channel bank station, and then 5 equal intervals from the main channel to the top of the cross section. The program then searches this table for the location of local minimums. When a point in the table is encountered such that the energy for the water surface immediately above and immediately below are greater than the energy for the given water surface, then the general location of a local minimum has been found. The program will then search for the local minimum by using the secant slope projection method. The program will iterate for the local minimum either thirty times or until the critical depth has been bounded by the critical error tolerance. After the local minimum has been determined more precisely, the program will continue searching the table to see if there are any other local minimums. The program can locate up to three local minimums in the energy curve. If more than one local minimum is found, the program sets critical depth equal to the one with the minimum energy. If this local minimum is due to a break in the energy curve caused by overtopping a levee or and ineffective flow area, then the program will select the next lowest minimum on the energy curve. If all of the local minimums are occurring at breaks in the energy curve (caused by levees and ineffective flow areas), then the program will set critical depth to the one with the lowest energy. If no local minimums are found, then the program will use the water surface elevation with the least energy. If the critical depth that is found is at the top of the cross section, then this is probably not a real critical depth. Therefore, the program will double the height of the cross section and try again. Doubling the height of the cross section is accomplished by extending vertical walls at the first and last points of the section. The height of the cross section can be doubled five times before the program will quit searching.

Applications of the Momentum Equation

Whenever the water surface passes through critical depth, the energy equation is not considered to be applicable. The energy equation is only applicable to gradually varied flow situations, and the transition from subcritical to supercritical or supercritical to subcritical is a rapidly varying flow situation. There are several instances when the transition from subcritical to supercritical and supercritical to subcritical flow can occur. These include significant changes in channel slope, bridge constrictions, drop structures and weirs, and stream junctions. In some of these instances empirical equations can be used (such as at drop structures and weirs), while at others it is necessary to apply the momentum equation in order to obtain an answer.

Within HEC-RAS, the momentum equation can be applied for the following specific problems: the occurrence of a hydraulic jump; low flow hydraulics at bridges; and stream junctions. In order to understand how the momentum equation is being used to solve each of the three problems, a derivation of the momentum equation is shown here. The application of the momentum equation to hydraulic jumps and stream junctions is discussed in detail in chapter 4. Detailed discussions on applying the momentum equation to bridges is discussed in chapter 5.

The momentum equation is derived from Newton's second law of motion:

Force = Mass x Acceleration (change in momentum)

$$\sum F_x = ma \quad (2-15)$$

Applying Newton's second law of motion to a body of water enclosed by two cross sections at locations 1 and 2 (Figure 2.6), the following expression for the change in momentum over a unit time can be written:

$$P_1 - P_2 + W_x - F_f = Q\rho\Delta V_x \quad (2-16)$$

where: P = Hydrostatic pressure force at locations 1 and 2.
 W_x = Force due to the weight of water in the X direction.
 F_f = Force due to external friction losses from 1 to 2.
 Q = Discharge.
 ρ = Density of water
 ΔV_x = Change in velocity from 1 to 2, in the X direction.

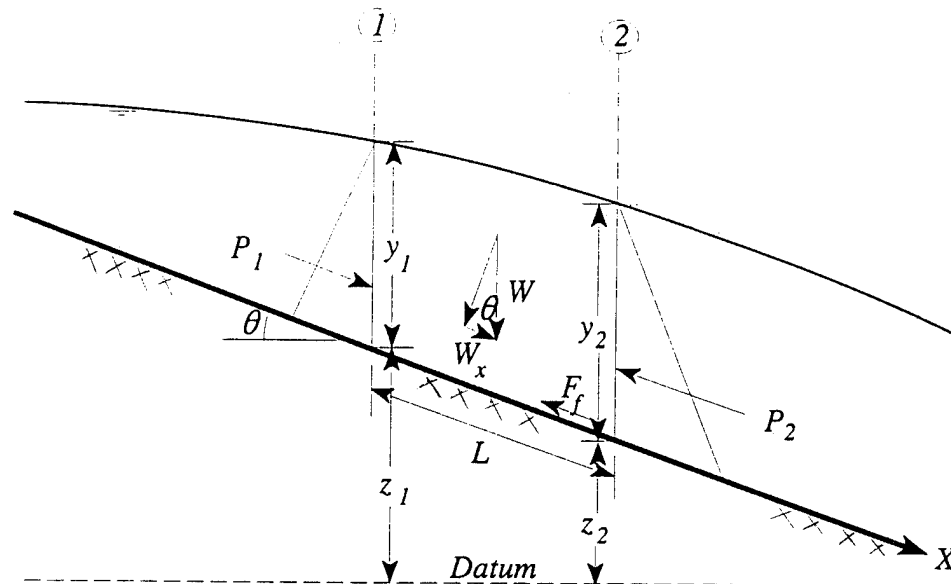

Figure 2.6 Application of the Momentum Principle

Hydrostatic Pressure Forces:

The force in the X direction due to hydrostatic pressure is:

$$P = \gamma A \bar{Y} \cos \theta \quad (2-17)$$

The assumption of a hydrostatic pressure distribution is only valid for slopes less than 1:10. The $\cos \theta$ for a slope of 1:10 (approximately 6 degrees) is equal to 0.995. Because the slope of ordinary channels is far less than 1:10, the $\cos \theta$ correction for depth can be set equal to 1.0 (Chow, 1959). Therefore, the equations for the hydrostatic pressure force at sections 1 and 2 are as follows:

$$P_1 = \gamma A_1 \bar{Y}_1 \quad (2-18)$$

$$P_2 = \gamma A_2 \bar{Y}_2 \quad (2-19)$$

where: γ = Unit weight of water
 A_i = Wetted area of the cross section at locations 1 and 2
 \bar{Y}_i = Depth measured from the water surface to the centroid of the cross sectional area at locations 1 and 2

Weight of Water Force:

Weight of water = (unit weight of water) x (volume of water)

$$W = \gamma \left(\frac{A_1 + A_2}{2} \right) L \quad (2-20)$$

$$W_x = W \times \sin\theta \quad (2-21)$$

$$\sin\theta = \frac{z_1 - z_2}{L} = S_o \quad (2-22)$$

$$W_x = \gamma \left(\frac{A_1 + A_2}{2} \right) L S_o \quad (2-23)$$

where: L = Distance between sections 1 and 2 along the X axis
 S_o = Slope of the channel, based on mean bed elevations
 z_i = Mean bed elevation at locations 1 and 2

Force of External Friction:

$$F_f = \tau \bar{P} L \quad (2-24)$$

where: τ = Shear stress
 \bar{P} = Average wetted perimeter between sections 1 and 2

$$\tau = \gamma \bar{R} \bar{S}_f \quad (2-25)$$

where: \bar{R} = Average hydraulic radius ($R = A/P$)
 \bar{S}_f = Slope of the energy grade line (friction slope)

$$F_f = \gamma \frac{\bar{A}}{\bar{P}} \bar{S}_f \bar{P} L \quad (2-26)$$

$$F_f = \gamma \left(\frac{A_1 + A_2}{2} \right) \bar{S}_f L \quad (2-27)$$

Mass times Acceleration:

$$ma = Q \rho \Delta V_x \quad (2-28)$$

$$\rho = \frac{\gamma}{g} \quad \text{and} \quad \Delta V_x = (\beta_2 V_2 - \beta_1 V_1)$$

$$ma = \frac{Q\gamma}{g} (\beta_2 V_2 - \beta_1 V_1) \quad (2-29)$$

where: β = momentum coefficient that accounts for a varying velocity distribution in irregular channels.

Substituting Back into Equation 2-16, and assuming Q can vary from 1 to 2:

$$\gamma A_1 \bar{Y}_1 - \gamma A_2 \bar{Y}_2 + \gamma \left(\frac{A_1 + A_2}{2} \right) L S_o - \gamma \left(\frac{A_1 + A_2}{2} \right) L \bar{S}_f = \frac{Q_2 \gamma}{g} \beta_2 V_2 - \frac{Q_1 \gamma}{g} \beta_1 V_1 \quad (2-30)$$

$$\frac{Q_1 \beta_1 V_1}{g} + A_1 \bar{Y}_1 + \left(\frac{A_1 + A_2}{2} \right) L S_o - \left(\frac{A_1 + A_2}{2} \right) L \bar{S}_f = \frac{Q_2 \beta_2 V_2}{g} + A_2 \bar{Y}_2 \quad (2-31)$$

$$\frac{Q_1^2 \beta_1}{g A_1} + A_1 \bar{Y}_1 + \left(\frac{A_1 + A_2}{2} \right) L S_o - \left(\frac{A_1 + A_2}{2} \right) L \bar{S}_f = \frac{Q_2^2 \beta_2}{g A_2} + A_2 \bar{Y}_2 \quad (2-32)$$

Equation 32 is the functional form of the momentum equation that is used in HEC-RAS. All applications of the momentum equation within HEC-RAS are derived from equation 32.

Program Limitations

The following assumptions are implicit in the analytical expressions used in the current version of the program:

- (1) Flow is steady,
- (2) Flow is gradually varied (except at hydraulic structures such as: bridges; culverts; and weirs. At these locations, where the flow can be rapidly varied, the momentum equation is used).
- (3) Flow is one dimensional (i.e., velocity components in directions other than the direction of flow are not accounted for),
- (4) River channels have "small" slopes, say less than 1:10.

Flow is assumed to be steady because time-dependent terms are not included in the energy equation (Equation 2-1). Flow is assumed to be gradually varied because Equation 2-1 is based on the premise that a hydrostatic pressure distribution exists at each cross section. At locations where the flow is rapidly varied, the program switches to the momentum equation or other empirical equations. Flow is assumed to be one-dimensional because Equation 2-4 is based on the premise that the total energy head is the same for all points in a cross section. Small channel slopes are assumed because the pressure head, which is a component of WS in Equation 2-1, is represented by the water depth measured vertically.

The program does not currently have the capability to deal with movable boundaries (i.e., sediment transport) and requires that energy losses be definable with the terms contained in Equation 2-2.

CHAPTER 3

Basic Data Requirements

This chapter describes the basic data requirements for performing the one-dimensional flow calculations within HEC-RAS. The basic data are defined and discussions of applicable ranges for parameters are provided.

Contents

- General
- Geometric Data
- Steady Flow Data

General

The main objective of the HEC-RAS program is quite simple - compute water surface elevations at all locations of interest for given flow values. The data needed to perform these computations are divided into the following categories: geometric data; steady flow data; unsteady flow data (not available yet); and sediment data (also not available yet). Geometric data are required for any of the analyses performed within HEC-RAS. The other data types are only required if you are going to do that specific type of analysis (i.e. steady flow data are required to perform a steady flow water surface profile computation). The current version of HEC-RAS is limited to steady flow computations, therefore, geometric data and steady flow data are the only available data categories.

Geometric Data

The basic geometric data consist of establishing the connectivity of the river system (River System Schematic); cross section data; reach lengths; energy loss coefficients (friction losses, contraction and expansion losses); and stream junction information. Hydraulic structure data (bridges, culverts, etc.), which are also considered geometric data, will be described in later chapters.

The River System Schematic

The river system schematic is required for any geometric data set within the HEC-RAS system. The schematic defines how the various river reaches are connected, as well as establishing a naming convention for referencing all the other data. The river system schematic is developed by drawing and connecting the various reaches of the system within the geometric data editor (see chapter 6 of the HEC-RAS user's manual for details on how to develop the schematic from within the user interface). The user is required to develop the river system schematic before any other data can be entered.

Each river reach on the schematic is given a unique identifier. As other data are entered, the data are referenced to a specific reach of the schematic. For example, each cross section must have a "reach" and "river station" identifier. The reach identifier defines which reach the cross section lives in, while the river station identifier defines where that cross section is located within the reach, with respect to the other cross sections for that reach.

The connectivity of reaches is very important in order for the model to understand how the computations should proceed from one reach to the next. The user is required to draw each reach from upstream to downstream, in what

is considered to be the positive flow direction. The connection of reaches are considered junctions. Junctions should only be established at locations where two or more streams come together or split apart. Junctions should not be established with a single reach flowing into another single reach. These two reaches should be combined and defined as one reach. An example river system schematic is shown in Figure 3.1.

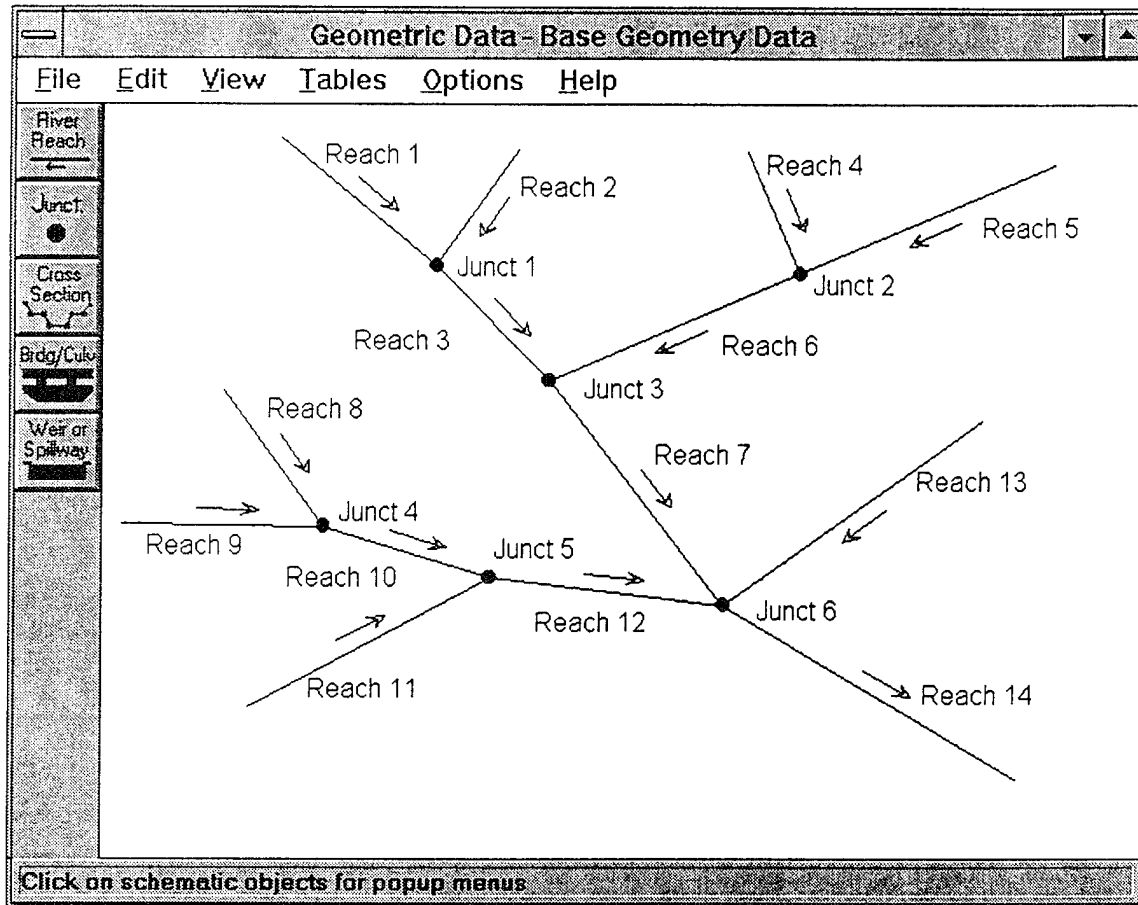

Figure 3.1 Example River System Schematic

The example schematic shown in Figure 3.1 is for a dendritic river system. Arrows are automatically drawn on the schematic in the assumed positive flow direction. Junctions, which are shown as red circles, are automatically formed as reaches are connected. As shown, the user is required to provide an identifier for each river reach, as well as each junction.

HEC-RAS has the ability to model river systems that range from simple single reach models to complicated networks. A "network" model is where river reaches split apart and then come back together, forming looped systems. An example schematic of a stream network is shown in Figure 3.2.

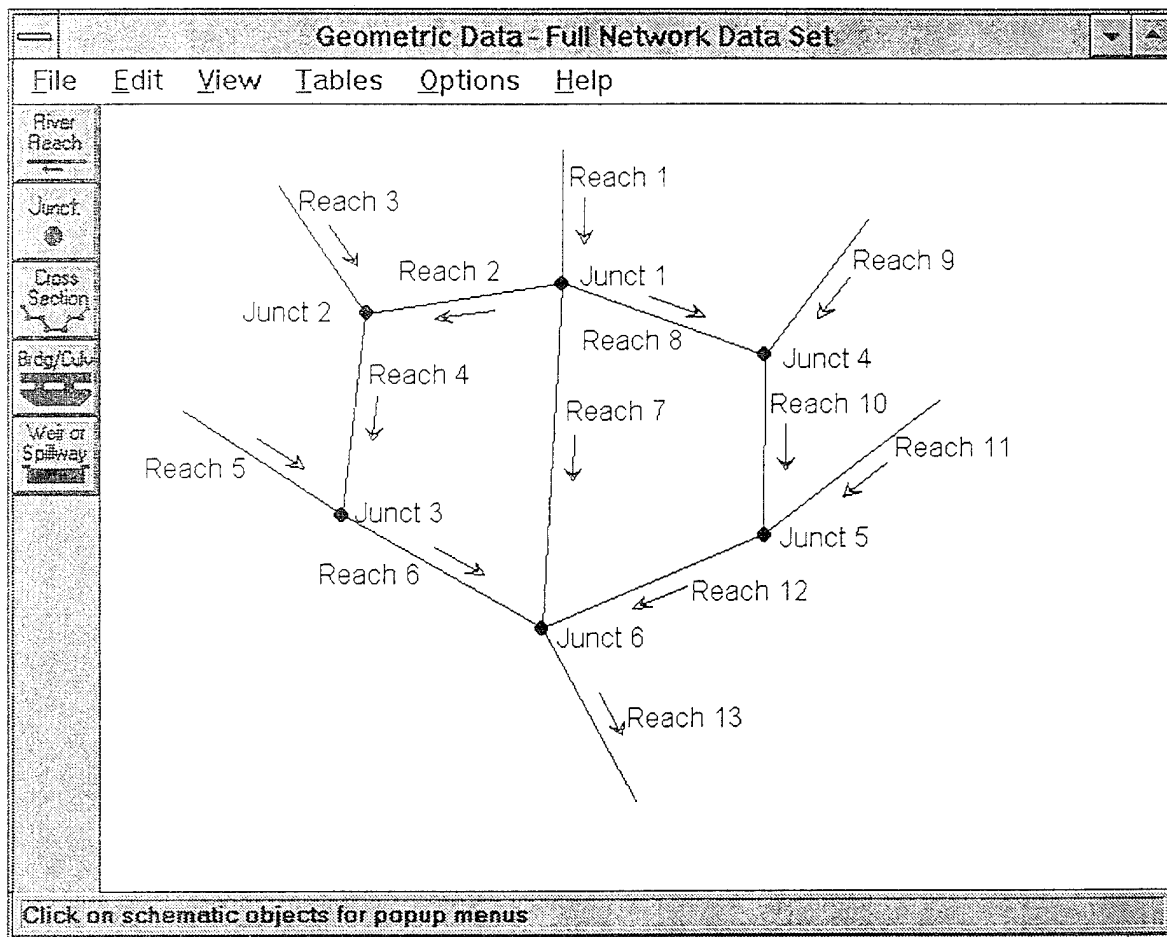

Figure 3.2 Example Schematic for a Looped Network of Reaches

The river system schematic shown in Figure 3.2 demonstrates the ability of HEC-RAS to model flow splits (Junct 1) as well as flow combinations. The current version of the steady flow model within HEC-RAS does not determine the amount of flow going to each reach at a flow split. It is currently up to the user to define the amount of flow in each reach. After a simulation is made, the user should adjust the flow in the reaches in order to obtain a balance in energy around the junction of a flow split.

Cross Section Geometry

Boundary geometry for the analysis of flow in natural streams is specified in terms of ground surface profiles (cross sections) and the measured distances between them (reach lengths). Cross sections are located at intervals along a stream to characterize the flow carrying capability of the stream and its adjacent floodplain. They should extend across the entire floodplain and should be perpendicular to the anticipated flow lines (approximately

perpendicular to the ground contour lines). Occasionally it is necessary to lay out cross sections in a curved or dog-leg alignment to meet this requirement. Every effort should be made to obtain cross sections that accurately represent the stream and floodplain geometry. However, ineffective flow areas of the floodplain, such as stream inlets, small ponds or indents in the valley floor, should generally not be included in the cross section geometry.

Cross sections are required at representative locations throughout a stream reach and at locations where changes occur in discharge, slope, shape, or roughness, at locations where levees begin or end and at bridges or control structures such as weirs. Where abrupt changes occur, several cross sections should be used to describe the change regardless of the distance. Cross section spacing is also a function of stream size, slope, and the uniformity of cross section shape. In general, large uniform rivers of flat slope normally require the fewest number of cross sections per mile. The purpose of the study also affects spacing of cross sections. For instance, navigation studies on large relatively flat streams may require closely spaced (e.g., 500 feet) cross sections to analyze the effect of local conditions on low flow depths, whereas cross sections for sedimentation studies, to determine deposition in reservoirs, may be spaced at intervals on the order of miles.

The choice of friction loss equation may also influence the spacing of cross sections. For instance, cross section spacing may be maximized when calculating an M1 profile (backwater profile) with the average friction slope equation or when the harmonic mean friction slope equation is used to compute M2 profiles (draw down profile). The HEC-RAS software provides the option to let the program select the averaging equation.

Each cross section in an HEC-RAS data set is identified by a Reach and River Station label. The cross section is described by entering the station and elevation (X-Y data) from left to right, with respect to looking in the downstream direction. The River Station identifier may correspond to stationing along the channel, mile points, or any fictitious numbering system. The numbering system must be consistent, in that the program assumes that higher numbers are upstream and lower numbers are downstream within a reach.

Each data point in the cross section is given a station number corresponding to the horizontal distance from a starting point on the left. Up to 500 data points may be used to describe each cross section. Cross section data are traditionally defined looking in the downstream direction. The program considers the left side of the stream to have the lowest station numbers and the right side to have the highest. Cross section data are allowed to have negative stationing values. Stationing must be entered from left to right in increasing order. However, more than one point can have the same stationing value. The left and right stations separating the main channel from the overbank areas must be specified on the cross section data editor. End points of a cross section that are too low (below the computed water surface elevation) will

automatically be extended vertically and a note indicating that the cross section had to be extended will show up in the output for that section. The program adds additional wetted perimeter for any water that comes into contact with the extended walls.

Other data that are required for each cross section consist of: downstream reach lengths; roughness coefficients; and contraction and expansion coefficients. These data will be discussed in detail later in this chapter.

Numerous program options are available to allow the user to easily add or modify cross section data. For example, when the user wishes to repeat a surveyed cross section, an option is available from the interface to make a copy of any cross section. Once a cross section is copied, other options are available to allow the user to modify the horizontal and vertical dimensions of the repeated cross section data. For a detailed explanation on how to use these cross section options, see chapter 6 of the HEC-RAS user's manual.

Optional Cross Section Properties

A series of program options are available to restrict flow to the effective flow areas of cross sections. Among these capabilities are options for: ineffective flow areas; levees; and blocked obstructions. All of these capabilities are available from the "Options" menu of the Cross Section Data editor.

Ineffective Flow Areas. This option allows the user to define areas of the cross section that will contain water that is not actively being conveyed (ineffective flow). Ineffective flow areas are often used to describe portions of a cross section in which water will pond, but the velocity of that water, in the downstream direction, is close to zero. This water is included in the storage calculations and other wetted cross section parameters, but it is not included as part of the active flow area. When using ineffective flow areas, no additional wetted perimeter is added to the active flow area. An example of an ineffective flow area is shown in Figure 3.3. The cross-hatched area on the left of the plot represents what is considered to be the ineffective flow area.

Two alternatives are available for setting ineffective flow areas. The first option allows the user to define a left station and elevation and a right station and elevation (normal ineffective areas). When this option is used, and if the water surface is below the established ineffective elevations, the areas to the left of the left station and to the right of the right station are considered ineffective. Once the water surface goes above either of the established elevations, then that specific area is no longer considered ineffective.

The second option allows for the establishment of blocked ineffective flow areas. Blocked ineffective flow areas require the user to enter an elevation, a left station, and a right station for each ineffective block. Up to five blocked ineffective flow areas can be entered at each cross section. Once the water

surface goes above the elevation of the blocked ineffective flow area, the blocked area is no longer considered ineffective.

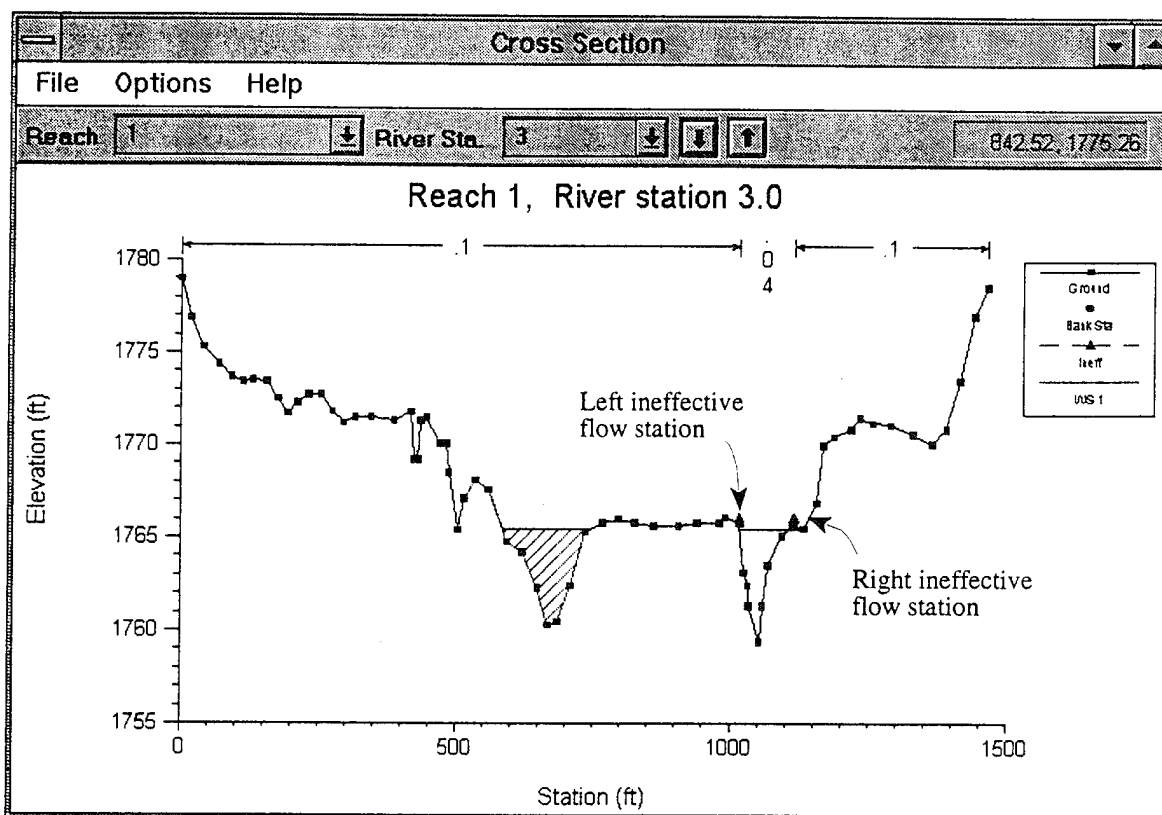

Figure 3.3 Cross section with ineffective flow areas

Levees. This option allows the user to establish a left and/or right levee station and elevation on any cross section. When levees are established, no water can go to the left of the left levee station or to the right of the right levee station until either of the levee elevations are exceeded. Levee stations must be defined explicitly, or the program assumes that water can go anywhere within the cross section. An example of a cross section with a levee on the left side is shown in Figure 3.4. In this example the levee station and elevation is associated with an existing point on the cross section.

The user may want to add levees into a data set in order to see what effect a levee will have on the water surface. A simple way to do this is to set a levee station and elevation that is above the existing ground. If a levee elevation is placed above the existing geometry of the cross section, then a vertical wall is placed at that station up to the established levee height. Additional wetted perimeter is included when water comes into contact with the levee wall. An example of this is shown in Figure 3.5.

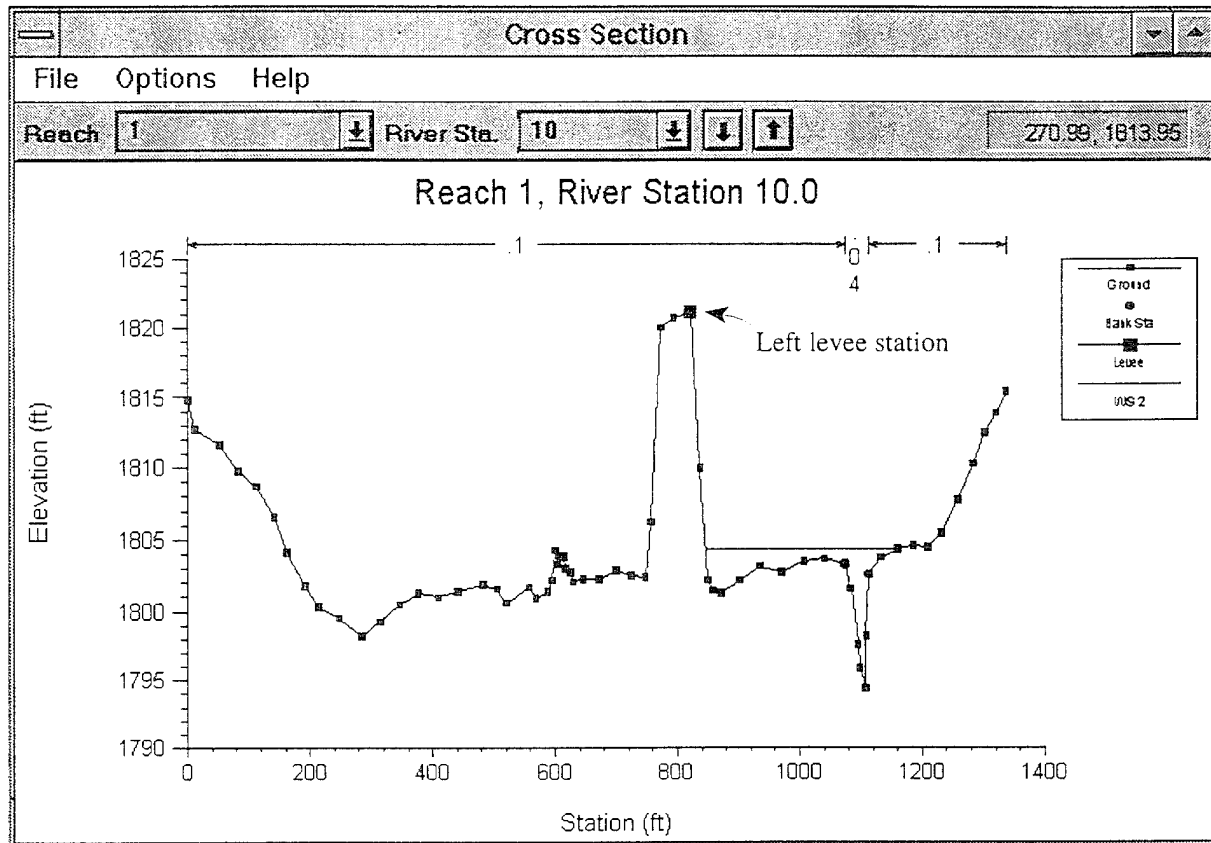

Figure 3. Example of the Levee Option

Blocked Obstructions. This option allows the user to define areas of the cross section that will be permanently blocked out. Blocked obstructions decrease flow area and add wetted perimeter when the water comes in contact with the obstruction. A blocked obstruction does not prevent water from going outside of the obstruction.

Two alternatives are available for entering blocked obstructions. The first option allows the user to define a left station and elevation and a right station and elevation (normal blocked areas). When this option is used, the area to the left of the left station and to the right of the right station will be completely blocked out. An example of this type of blocked obstruction is shown in Figure 3.6.

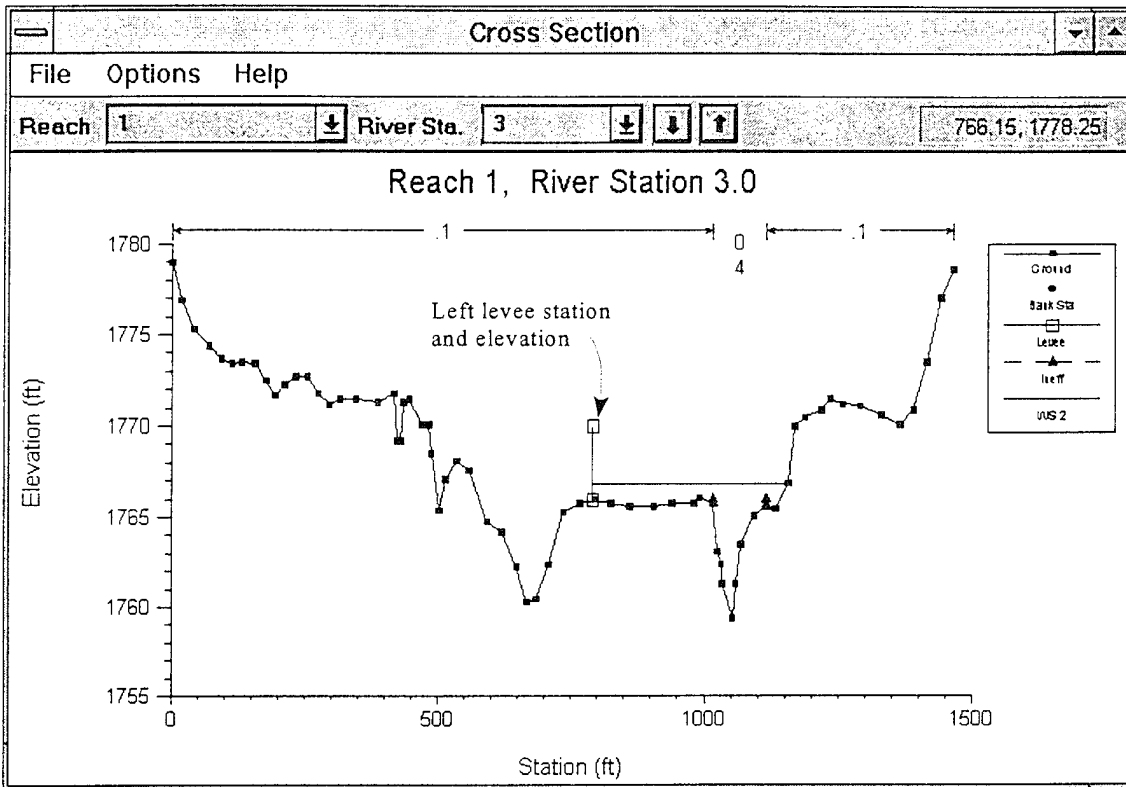

Figure 3.5 Example Levee Added to a Cross Section

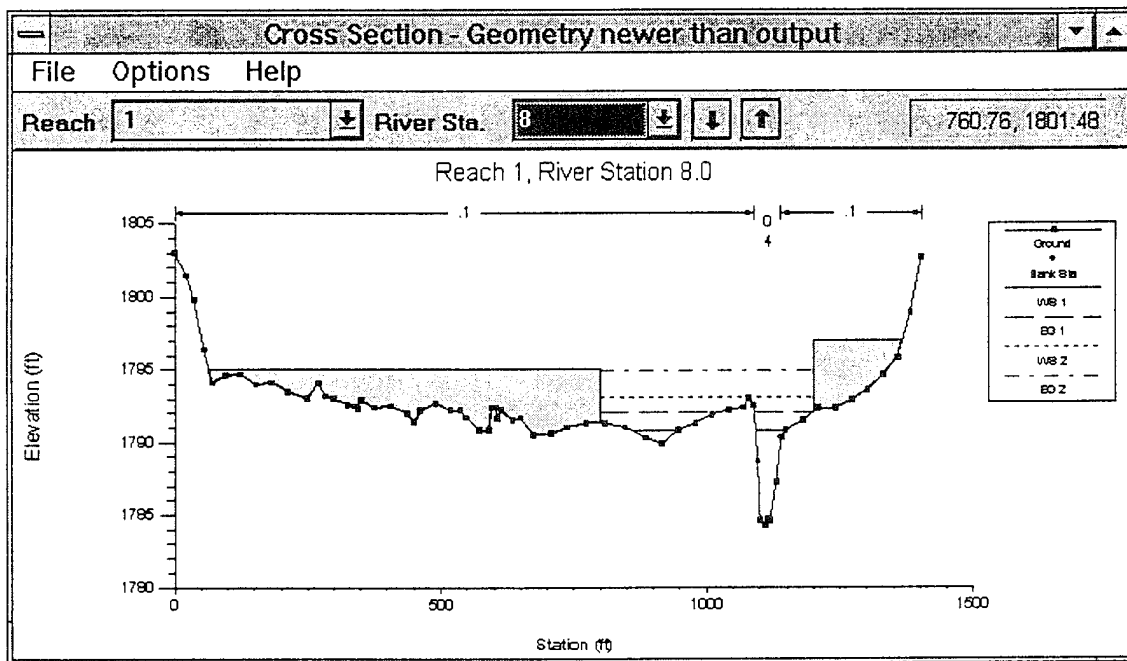

Figure 3.6 Example of Normal Blocked Obstructions

The second option, for blocked obstructions, allows the user to enter up to 20 individual blocks (Multiple Blocks). With this option the user enters a left station, a right station, and an elevation for each of the blocks. An example of a cross section with multiple blocked obstructions is shown in Figure 3.7.

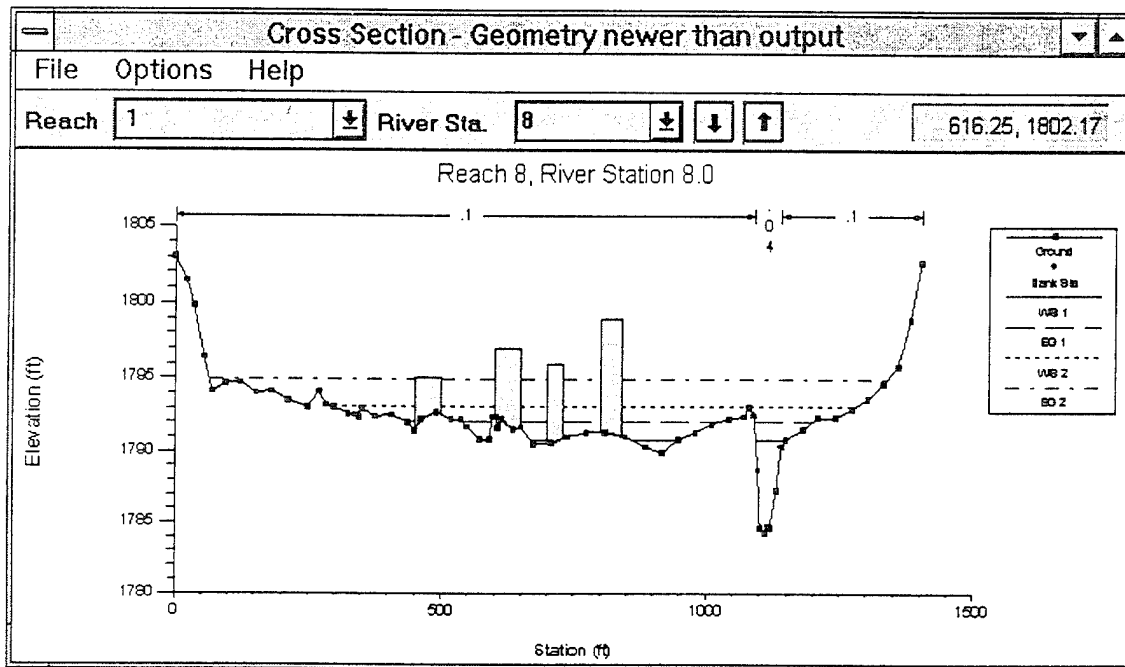

Figure 3.7 Example of a Cross Section With Blocked Obstructions

Reach Lengths

The measured distances between cross sections are referred to as reach lengths. The reach lengths for the left overbank, right overbank and channel are specified on the cross section data editor. Channel reach lengths are typically measured along the thalweg. Overbank reach lengths should be measured along the anticipated path of the center of mass of the overbank flow. Often, these three lengths will be of similar value. There are, however, conditions where they will differ significantly, such as at river bends, or where the channel meanders and the overbanks are straight. Where the distances between cross sections for channel and overbanks are different, a discharge-weighted reach length is determined based on the discharges in the main channel and left and right overbank segments of the reach (see Equation 2-3, of chapter 2).

Energy Loss Coefficients

Several types of loss coefficients are utilized by the program to evaluate energy losses: (1) Manning's n values for friction loss, (2) contraction and expansion coefficients to evaluate transition (shock) losses, and (3) bridge and culvert loss coefficients to evaluate losses related to weir shape, pier configuration, and pressure flow, and entrance and exit conditions. Energy loss coefficients associated with bridges and culverts will be discussed in chapters 5 and 6 of this manual.

Manning's n . Selection of an appropriate value for Manning's n is very significant to the accuracy of the computed water surface profiles. The value of Manning's n is highly variable and depends on a number of factors including: surface roughness; vegetation; channel irregularities; channel alignment; scour and deposition; obstructions; size and shape of the channel; stage and discharge; seasonal change; temperature; and suspended material and bedload.

In general, Manning's n values should be calibrated whenever observed water surface profile information (gaged data, as well as high water marks) is available. When gaged data are not available, values of n computed for similar stream conditions or values obtained from experimental data should be used as guides in selecting n values.

There are several references a user can access that show Manning's n values for typical channels. An extensive compilation of n values for streams and floodplains can be found in Chow's book "Open-Channel Hydraulics"[Chow, 1959]. Excerpts from Chow's book, for the most common types of channels, are shown in Table 3.1 below. Chow's book presents additional types of channels, as well as pictures of streams for which n values have been calibrated.

Table 3.1
Manning's 'n' Values

Type of Channel and Description	Minimum	Normal	Maximum
<i>A. Natural Streams</i>			
1. Main Channels			
a. Clean, straight, full, no rifts or deep pools	0.025	0.030	0.033
b. Same as above, but more stones and weeds	0.030	0.035	0.040
c. Clean, winding, some pools and shoals	0.033	0.040	0.045
d. Same as above, but some weeds and stones	0.035	0.045	0.050
e. Same as above, lower stages, more ineffective slopes and sections	0.040	0.048	0.055
f. Same as "d" but more stones	0.045	0.050	0.060
g. Sluggish reaches, weedy, deep pools	0.050	0.070	0.080
h. Very weedy reaches, deep pools, or floodways with heavy stands of timber and brush	0.070	0.100	0.150
2. Flood Plains			
a. Pasture no brush			
1. Short grass	0.025	0.030	0.035
2. High grass	0.030	0.035	0.050
b. Cultivated areas			
1. No crop	0.020	0.030	0.040
2. Mature row crops	0.025	0.035	0.045
3. Mature field crops	0.030	0.040	0.050
c. Brush			
1. Scattered brush, heavy weeds	0.035	0.050	0.070
2. Light brush and trees, in winter	0.035	0.050	0.060
3. Light brush and trees, in summer	0.040	0.060	0.080
4. Medium to dense brush, in winter	0.045	0.070	0.110
5. Medium to dense brush, in summer	0.070	0.100	0.160
d. Trees			
1. Cleared land with tree stumps, no sprouts	0.030	0.040	0.050
2. Same as above, but heavy sprouts	0.050	0.060	0.080
3. Heavy stand of timber, few down trees, little undergrowth, flow below branches	0.080	0.100	0.120
4. Same as above, but with flow into branches	0.100	0.120	0.160
5. Dense willows, summer, straight	0.110	0.150	0.200
3. Mountain Streams, no vegetation in channel, banks usually steep, with trees and brush on banks submerged			
a. Bottom: gravels, cobbles, and few boulders	0.030	0.040	0.050
b. Bottom: cobbles with large boulders	0.040	0.050	0.070

Table 3.1 (Continued)
Manning's 'n' Values

Type of Channel and Description	Minimum	Normal	Maximum
<i>B. Lined or Built-Up Channels</i>			
1. Concrete			
a. Trowel finish	0.011	0.013	0.015
b. Float Finish	0.013	0.015	0.016
c. Finished, with gravel bottom	0.015	0.017	0.020
d. Unfinished	0.014	0.017	0.020
e. Gunite, good section	0.016	0.019	0.023
f. Gunite, wavy section	0.018	0.022	0.025
g. On good excavated rock	0.017	0.020	
h. On irregular excavated rock	0.022	0.027	
2. Concrete bottom float finished with sides of:			
a. Dressed stone in mortar	0.015	0.017	0.020
b. Random stone in mortar	0.017	0.020	0.024
c. Cement rubble masonry, plastered	0.016	0.020	0.024
d. Cement rubble masonry	0.020	0.025	0.030
e. Dry rubble on riprap	0.020	0.030	0.035
3. Gravel bottom with sides of:			
a. Formed concrete	0.017	0.020	0.025
b. Random stone in mortar	0.020	0.023	0.026
c. Dry rubble or riprap	0.023	0.033	0.036
4. Brick			
a. Glazed	0.011	0.013	0.015
b. In cement mortar	0.012	0.015	0.018
5. Metal			
a. Smooth steel surfaces	0.011	0.012	0.014
b. Corrugated metal	0.021	0.025	0.030
6. Asphalt			
a. Smooth	0.013	0.013	
b. Rough	0.016	0.016	
7. Vegetal lining	0.030		0.500

Table 3.1 (Continued)
Manning's 'n' Values

Type of Channel and Description	Minimum	Normal	Maximum
<i>C. Excavated or Dredged Channels</i>			
1. Earth, straight and uniform			
a. Clean, recently completed	0.016	0.018	0.020
b. Clean, after weathering	0.018	0.022	0.025
c. Gravel, uniform section, clean	0.022	0.025	0.030
d. With short grass, few weeds	0.022	0.027	0.033
2. Earth, winding and sluggish			
a. No vegetation	0.023	0.025	0.030
b. Grass, some weeds	0.025	0.030	0.033
c. Dense weeds or aquatic plants in deep channels	0.030	0.035	0.040
d. Earth bottom and rubble side	0.028	0.030	0.035
e. Stony bottom and weedy banks	0.025	0.035	0.040
f. Cobble bottom and clean sides	0.030	0.040	0.050
3. Dragline-excavated or dredged			
a. No vegetation	0.025	0.028	0.033
b. Light brush on banks	0.035	0.050	0.060
4. Rock cuts			
a. Smooth and uniform	0.025	0.035	0.040
b. Jagged and irregular	0.035	0.040	0.050
5. Channels not maintained, weeds and brush			
a. Clean bottom, brush on sides	0.040	0.050	0.080
b. Same as above, highest stage of flow	0.045	0.070	0.110
c. Dense weeds, high as flow depth	0.050	0.080	0.120
d. Dense brush, high stage	0.080	0.100	0.140

Other sources that include pictures of selected streams as a guide to n value determination are available (Fasken, 1963; Barnes, 1987; and Hicks and Mason, 1991). In general, these references provide color photos with tables of calibrated n values for a range of flows.

Although there are many factors that affect the selection of the n value for the channel, some of the most important factors are the type and size of materials that compose the bed and banks of a channel, and the shape of the channel. Cowan (1956) developed a procedure for estimating the effects of these factors to determine the value of Manning's n of a channel. In Cowan's procedure, the value of n is computed by the following equation:

$$n = (n_b + n_1 + n_2 + n_3 + n_4) m \quad (3-1)$$

where: n_b	=	Base value of n for a straight uniform, smooth channel in natural materials
n_1	=	Value added to correct for surface irregularities
n_2	=	Value for variations in shape and size of the channel
n_3	=	Value for obstructions
n_4	=	Value for vegetation and flow conditions
m	=	Correction factor to account for meandering of the channel

A detailed description of Barnes' method can be found in "Guide for Selecting Manning's Roughness Coefficients for Natural Channels and Flood Plains" (FHWA, 1984). This report was developed by the U.S. Geological Survey (Arcement, 1989) for the Federal Highway Administration. The report also presents a method similar to Barnes' for developing Manning's n values for flood plains, as well as some additional methods for densely vegetated flood plains.

Limerinos (1970) related n values to hydraulic radius and bed particle size based on samples from 11 stream channels having bed materials ranging from small gravel to medium size boulders. The Limerinos equation is as follows:

$$n = \frac{(0.0926) R^{1/6}}{1.16 + 2.0 \log\left(\frac{R}{d_{84}}\right)} \quad (3-2)$$

where: R	=	Hydraulic radius, in feet (data range was 1.0 to 6.0 feet)
d_{84}	=	Particle diameter, in feet, that equals or exceeds that of 84 percent of the particles (data range was 1.5 mm to 250 mm)

The Limerinos equation (3-2) fit the data that he used very well, in that the coefficient of correlation $\bar{R}^2 = 0.88$ and the standard error of estimates for values of $n/R^{1/6} = 0.0087$.

Limerinos selected reaches that had a minimum amount of roughness, other than that caused by the bed material. The Limerinos equation provides a good estimate of the base n value. The base n value should then be increased to account for other factors, as shown above in Cowen's method.

Jarrett (1985) developed an equation for high gradient streams (slopes greater than 0.002). Jarrett performed a regression analysis on 75 data sets that were surveyed from 21 different streams. Jarrett's equation for Manning's n is as follows:

$$n = 0.39 S^{0.38} R^{-0.16} \quad (3-3)$$

where: S = The friction slope. The slope of the water surface can be used when the friction slope is unknown.

Jarrett (1985) states the following limitations for the use of his equation:

1. The equations are applicable to natural main channels having stable bed and bank materials (gravels, cobbles, and boulders) without backwater.
2. The equations can be used for slopes from 0.002 to 0.04 and for hydraulic radii from 0.5 to 7.0 feet (0.15 to 2.1 m). The upper limit on slope is due to a lack of verification data available for the slopes of high-gradient streams. Results of the regression analysis indicate that for hydraulic radius greater than 7.0 feet (2.1 m), n did not vary significantly with depth; thus extrapolating to larger flows should not be too much in error as long as the bed and bank material remain fairly stable.
3. During the analysis of the data, the energy loss coefficients for contraction and expansion were set to 0.0 and 0.5, respectively.
4. Hydraulic radius does not include the wetted perimeter of bed particles.
5. These equations are applicable to streams having relatively small amounts of suspended sediment.

Because Manning's n depends on many factors such as the type and amount of vegetation, channel configuration, stage, etc..., several options are available in HEC-RAS to vary n . When three n values are sufficient to

describe the channel and overbanks, the user can enter the three n values directly onto the cross section editor for each cross section. Any of the n values may be changed at any cross section. Often three values are not enough to adequately describe the lateral roughness variation in the cross section; in this case the "Horizontal Variation of n Value" should be selected from the "Options" menu of the cross section editor. If n values change within the channel, the criterion described in Chapter 2, under composite n values, is used to determine whether the n values should be converted to a composite value using Equation 2-5.

Contraction and Expansion Coefficients. Contraction or expansion of flow due to changes in the cross section is a common cause of energy losses within a reach (between two cross sections). Whenever this occurs, the loss is computed from the contraction and expansion coefficients specified on the cross section data editor. The coefficients, which are applied between cross sections, are specified as part of the data for the upstream cross section. The coefficients are multiplied by the absolute difference in velocity heads between the two cross sections, which gives the energy loss caused by the transition (Equation 2-2 of Chapter 2). Where the change in river cross section is small, coefficients contraction and expansion are typically on the order of 0.1 and 0.3, respectively. When the change in effective cross section area is abrupt such as at bridges, contraction and expansion coefficients of 0.3 and 0.5 are often used. On occasion, the coefficients of contraction and expansion around bridges and culverts may be as high as 0.6 and 0.8, respectively. These values may be changed at any cross section. For additional information concerning transition losses and for information on bridge loss coefficients, see chapter 5, Modeling Bridges. Typical values for contraction and expansion coefficients are shown in Table 3.2 below.

Table 3.2
Contraction and Expansion Coefficients

	Contraction	Expansion
No transition loss computed	0.0	0.0
Gradual transitions	0.1	0.3
Typical Bridge sections	0.3	0.5
Abrupt transitions	0.6	0.8

The maximum value for the contraction and expansion coefficient would be one (1.0).

Stream Junction Data

Stream junctions are defined as locations where two or more streams come together or split apart. Junction data consists of reach lengths across the junction and tributary angles (only if the momentum equation is selected). Reach lengths across the junction are entered in the Junction Data editor. This allows for the lengths across very complicated confluences (e.g. flow splits) to be accommodated. An example of this is shown in Figure 3.8.

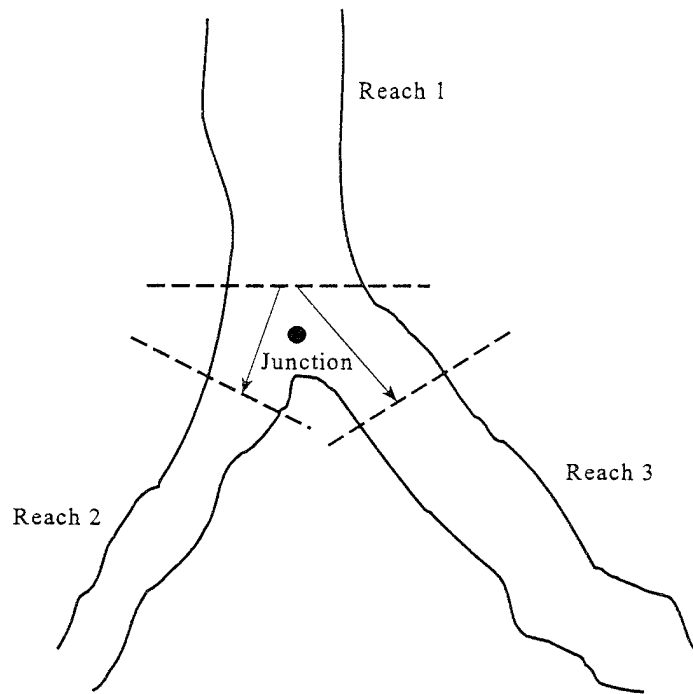

Figure 3.8 Example of a Stream Junction

As shown in Figure 3.8, using downstream reach lengths, for the last cross section in Reach 1, would not adequately describe the lengths across the junction. It is therefore necessary to describe lengths across junctions in the Junction Data editor. For the example shown in Figure 3.8, two lengths would be entered. These lengths should represent the average distance that the water will travel from the last cross section in Reach 1 to the first cross section of the respective reaches.

In general, the cross sections that bound a junction should be placed as close together as possible. This will minimize the error in the calculation of energy losses across the junction.

In HEC-RAS a junction can be modeled by either the energy equation (equation 2-1 of chapter 2) or the momentum equation. The energy equation does not take into account the angle of any tributary coming in or leaving the main stream, while the momentum equation does. In most cases, the amount of energy loss due to the angle of the tributary flow is not significant, and using the energy equation to model the junction is more than adequate. However, there are situations where the angle of the tributary can cause significant energy losses. In these situations it would be more appropriate to use the momentum approach. When the momentum approach is selected, an angle for all tributaries of the main stem must be entered. A detailed description of how junction calculations are made can be found in Chapter 4 of this manual.

Steady Flow Data

Steady flow data are required in order to perform a steady water surface profile calculation. Steady flow data consist of: flow regime; boundary conditions; and peak discharge information.

Flow Regime

Profile computations begin at a cross section with known or assumed starting conditions and proceed upstream for subcritical flow or downstream for supercritical flow. The flow regime (subcritical, supercritical, or mixed flow regime) is specified on the Steady Flow Analysis window of the user interface. Subcritical profiles computed by the program are constrained to critical depth or above, and supercritical profiles are constrained to critical depth or below. In cases where the flow regime will pass from subcritical to supercritical, or supercritical to subcritical, the program should be run in a mixed flow regime mode. For a detailed discussion of mixed flow regime calculations, see Chapter 4 of this manual.

Boundary Conditions

Boundary conditions are necessary to establish the starting water surface at the ends of the river system (upstream and downstream). A starting water surface is necessary in order for the program to begin the calculations. In a subcritical flow regime, boundary conditions are only necessary at the downstream ends of the river system. If a supercritical flow regime is going to be calculated, boundary conditions are only necessary at the upstream ends of the river system. If a mixed flow regime calculation is going to be made, then boundary conditions must be entered at all ends of the river system.

The boundary conditions editor contains a table listing every reach. Each reach has an upstream and a downstream boundary condition. Connections to junctions are considered internal boundary conditions. Internal boundary conditions are automatically listed in the table, based on how the river system was defined in the geometric data editor. The user is only required to enter the necessary external boundary conditions. There are four types of boundary conditions available to the user:

Known Water Surface Elevations - For this boundary condition the user must enter a known water surface elevation for each of the profiles to be computed.

Critical Depth - When this type of boundary condition is selected, the user is not required to enter any further information. The program will calculate critical depth for each of the profiles and use that as the boundary condition.

Normal Depth - For this type of boundary condition, the user is required to enter an energy slope that will be used in calculating normal depth (Manning's equation) at that location. A normal depth will be calculated for each profile based on the user entered slope. In general, the energy slope can be approximated by using the average slope of the channel or the average slope of the water surface in the vicinity of the cross section.

Rating Curve - When this type of boundary condition is selected, a popup window appears allowing the user to enter an elevation versus flow rating curve. For each profile, the elevation is interpolated from the rating curve given the flow.

Whenever the water surface elevations at the boundaries of the study are unknown; and a user defined water surface is required at the boundary to start the calculations; the user must either estimate the water surface, or select normal depth or critical depth. Using an estimated water surface will incorporate an error in the water surface profile in the vicinity of the boundary condition. If it is important to have accurate answers at cross sections near the boundary condition, additional cross sections should be added. If a subcritical profile is being computed, then additional cross sections need only be added below the downstream boundaries. If a supercritical profile is being computed, then additional cross sections should be added upstream of the relevant upstream boundaries. If a mixed flow regime profile is being computed, then cross sections should be added upstream and downstream of all the relevant boundaries. In order to test whether the added cross sections are sufficient for a particular boundary condition, the user should try several different starting elevations at the boundary condition, for the same discharge. If the water surface profile converges to the same answer, by the time the computations get to the cross sections that are in the study area, then enough sections have been added, and the boundary condition is not effecting the answers in the study area.

Discharge Information

Discharge information is required at each cross section in order to compute the water surface profile. Discharge data are entered from upstream to downstream for each reach. At least one flow value must be entered for each reach in the river system. Once a flow value is entered at the upstream end of a reach, it is assumed that the flow remains constant until another flow value is encountered with the same reach. The flow rate can be changed at any cross section within a reach. However, the flow rate can not be changed in the middle of a bridge, culvert, or stream junction. Flow data must be entered for the total number of profiles that are requested to be computed.

CHAPTER 4

Overview of Optional Capabilities

HEC-RAS has numerous optional capabilities that allow the user to model unique situations. These capabilities include: multiple profile analysis; multiple plan analysis; optional friction loss equations; cross section interpolation; mixed flow regime calculations; modeling stream junctions; and flow distribution calculations.

Contents

- Multiple Profile Analysis
- Multiple Plan Analysis
- Optional Friction Loss Equations
- Cross Section Interpolation
- Mixed Flow Regime Calculations
- Modeling Stream Junctions
- Flow Distribution Calculations

Multiple Profile Analysis

HEC-RAS can compute up to 15 profiles, for the same geometric data, within a single execution of the steady flow computations. The number of profiles to be computed is defined as part of the steady flow data. When more than one profile is requested, the user must ensure that flow data and boundary conditions are established for each profile. Once a multiple profile computation is made, the user can view output, in a graphical and tabular mode, for any single profile or combination of profiles.

Multiple Plan Analysis

The HEC-RAS system has the ability to compute a series of water surface profiles for a number of different characterizations (plans) of the river system. Modifications can be made to the geometry and/or flow data, and then saved in separate files. Plans are then formulated by selecting a particular geometry file and a particular flow file. The multiple plan option is useful when, for example, a comparison of existing conditions and future channel modifications are to be analyzed. Channel modifications can consist of any change in the geometric data, such as: the addition of a bridge or culvert; channel improvements; the addition of levees; changes in n values due to development or changes in vegetation; etc... The multiple plan option can also be used to perform a design of a specific geometric feature. For example, if you were sizing a bridge opening, a separate geometry file could be developed for a base condition (no bridge), and then separate geometry files could be developed for each possible bridge configuration. A plan would then consist of selecting a flow file and one of the geometry files. Computations are performed for each plan individually. Once the computations are performed for all the plans, the user can then view output in a graphical and tabular mode for any single plan or combination of plans.

Optional Friction Loss Equations

The friction loss between adjacent cross sections is computed as the product of the representative rate of friction loss (friction slope) and the weighted reach length. The program allows the user to select from the following previously defined friction loss equations:

- Average Conveyance (Equation 2-7)
- Average Friction Slope (Equation 2-8)
- Geometric Mean Friction Slope (Equation 2-9)
- Harmonic Mean Friction Slope (Equation 2-10)

Any of the above friction loss equations will produce satisfactory estimates

provided that reach lengths are not too long. The advantage sought in alternative friction loss formulations is to be able to maximize reach lengths without sacrificing profile accuracy.

Equation 2-7, the average conveyance equation, is the friction loss formulation that has been set as the default method within HEC-RAS. This equation is viewed as giving the best overall results for a range of profile types (M1, M2, etc). Research (Reed and Wolfkill, 1976) indicates that Equation 2-8 is the most suitable for M1 profiles. (Suitability as indicated by Reed and Wolfkill is the most accurate determination of a known profile with the least number of cross sections.) Equation 2-9 is the standard friction loss formulation used in the FHWA/USGS step-backwater program WSPRO (Sherman, 1990). Equation 2-10 has been shown by Reed and Wolfkill to be the most suitable for M2 profiles.

Another feature of this option is the capability of the program to select the most appropriate of the preceding four equations on a cross section by cross section basis depending on flow conditions (e.g., M1, S1, etc.) within the reach. At present, however, the criteria for this automated method (shown in Table 4.1), does not select the best equation for friction loss analysis in reaches with significant lateral expansion, such as the reach below a contracted bridge opening.

The selection of friction loss equations is accomplished from the Options menu on the Steady Flow Analysis window.

Table 4.1
Criteria Utilized to Select Friction Equation

Profile Type	Is friction slope at current cross section greater than friction slope at preceding cross section?	Equation Used
Subcritical (M1, S1)	Yes	Average Friction Slope (2-8)
Subcritical (M2)	No	Harmonic Mean (2-10)
Supercritical (S2)	Yes	Average Friction Slope (2-8)
Supercritical (M3, S3)	No	Geometric Mean (2-9)

Cross Section Interpolation

Occasionally it is necessary to supplement surveyed cross section data by interpolating cross sections in between two surveyed sections. Interpolated cross sections are often required when the change in velocity head is too large to accurately determine the change in the energy gradient. An adequate depiction of the change in energy gradient is necessary to accurately model friction losses as well as contraction and expansion losses. When cross sections are spaced too far apart, the program may end up defaulting to critical depth.

The HEC-RAS program has the ability to generate cross sections by interpolating the geometry between two user entered cross sections. The geometric interpolation routines in HEC-RAS are based on a string model, as shown in Figure 4.1

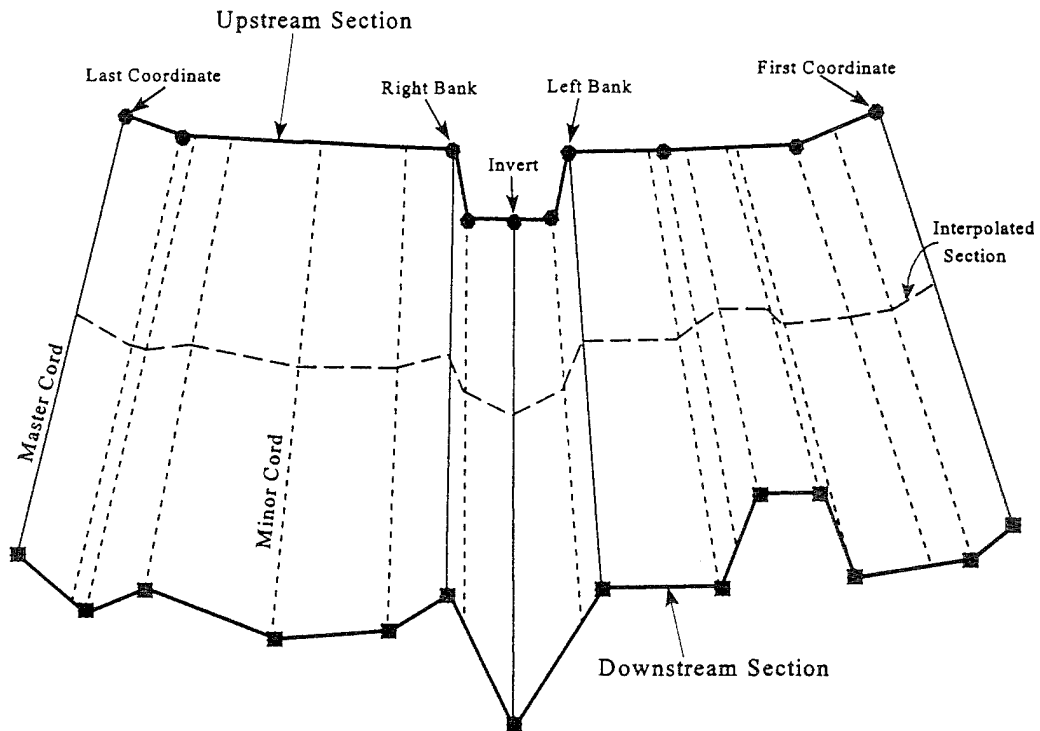

Figure 4.1 String Model for Geometric Cross Section Interpolation

The string model in HEC-RAS consists of cords that connect the coordinates of the upstream and downstream cross sections. The cords are classified as "Master Cords" and "Minor Cords". The master cords are defined explicitly as to the number and starting and ending location of each cord. The default number of master cords is five. The five default master cords are based on the following location criteria:

1. First coordinate of the cross section (May be equal to left bank).
2. Left bank of main channel (Required to be a master cord).
3. Minimum elevation point in the main channel.
4. Right bank of main channel (Required to be a master cord).
5. Last coordinate of the cross section (May be equal to right bank).

The interpolation routines are not restricted to a set number of master cords. At a minimum there must be two master cords, but there is no maximum. Additional master cords can be added by the user. This is explained in chapter 6 of the HEC-RAS user's manual, under cross section interpolation.

The minor cords are generated automatically by the interpolation routines. A minor cord is generated by taking an existing coordinate in either the upstream or downstream section and establishing a corresponding coordinate at the opposite cross section by either matching an existing coordinate or interpolating one. The station value at the opposite cross section is determined by computing the proportional distance that the known coordinate represents between master chords, and then applying the proportion to the distance between master cords of the opposite section. The number of minor cords will be equal to the sum of all the coordinates in the upstream and downstream sections minus the number of master cords.

Once all the minor cords are computed, the routines can then interpolate any number of sections between the two known cross sections. Interpolation is accomplished by linearly interpolating between the elevations at the ends of a cord. Interpolated points are generated at all of the minor and master cords. The elevation of a particular point is computed by distance weighting, which is based on how far the interpolated cross section is from the user known cross sections.

The interpolation routines will also interpolate roughness coefficients (Manning's n values). Interpolated cross section roughness is based on a string model similar to the one used for geometry. Cords are used to connect the breaks in roughness coefficients of the upstream and downstream sections. The cords are also classified as master and minor cords. The

default number of master cords is set to four, and are located based on the following criteria:

1. First coordinate of the cross section (may be equal to left bank).
2. Left bank of main channel.
3. Right bank of main channel.
4. Last coordinate of the cross section (may be equal to right bank).

When either of the two cross sections has more than three n values, additional minor cords are added at all other n value break points. Interpolation of roughness coefficients is then accomplished in the same manner as the geometry interpolation.

Cross section interpolation is accomplished from the user interface. To learn how to perform the interpolation, review the section on interpolating in chapter 6 of the HEC-RAS user's manual.

Mixed Flow Regime Calculations

The HEC-RAS software has the ability to perform subcritical, supercritical, or mixed flow regime calculations. The Specific Force equation is used in HEC-RAS to determine which flow regime is controlling, as well as locating any hydraulic jumps. The equation for Specific Force is derived from the momentum equation (Equation 2-29). When applying the momentum equation to a very short reach of river, the external force of friction and the force due to the weight of water are very small, and can be ignored. The momentum equation then reduces to the following equation:

$$\frac{Q^2 \beta_1}{g A_1} + A_1 \bar{Y}_1 = \frac{Q^2 \beta_2}{g A_2} + A_2 \bar{Y}_2 \quad (4-1)$$

where: Q = Discharge at each section
 β = Momentum coefficient (similar to alpha)
 A = Total flow area
 \bar{Y} = Depth from the water surface to centroid of the area
 g = Gravitational acceleration

The two sides of the equation are analogous, and may be expressed for any

channel section as a general function:

$$SF = \frac{Q^2\beta}{gA} + A\bar{Y} \quad (4-2)$$

The generalized function (equation 4-2) consists of two terms. The first term is the momentum of the flow passing through the channel cross section per unit time. This portion of the equation is considered the dynamic component. The second term represents the momentum of the static component, which is the force exerted by the hydrostatic pressure of the water. Both terms are essentially a force per unit weight of water. The sum of the two terms is called the Specific Force (Chow, 1959).

When the specific force equation is applied to natural channels, it is written in the following manner:

$$SF = \frac{Q^2\beta}{gA_m} + A_t\bar{Y} \quad (4-3)$$

where: A_m = Flow area in which there is motion
 A_t = Total flow area, including ineffective flow areas

The mixed flow regime calculations in HEC-RAS are performed as follows:

1. First, a subcritical water surface profile is computed starting from a known downstream boundary condition. During the subcritical calculations, all locations where the program defaults to critical depth are flagged for further analysis.
2. Next the program begins a supercritical profile calculation starting upstream. The program starts with a user specified upstream boundary condition. If the boundary condition is supercritical, the program checks to see if it has a greater specific force than the previously computed subcritical water surface at this location. If the supercritical boundary condition has a greater specific force, then it is assumed to control, and the program will begin calculating a supercritical profile from this section. If the subcritical answer has a greater specific force, then the program begins searching downstream to find a location where the program defaulted to critical depth in the subcritical run. When a critical depth is located, the program uses it as a boundary condition to begin a supercritical profile calculation.

3. The program calculates a supercritical profile in the downstream direction until it reaches a cross section that has both a valid subcritical and a supercritical answer. When this occurs, the program calculates the specific force of both computed water surface elevations. Whichever answer has the greater specific force is considered to be the correct solution. If the supercritical answer has a greater specific force, the program continues making supercritical calculations in the downstream direction and comparing the specific force of the two solutions. When the program reaches a cross section whose subcritical answer has a greater specific force than the supercritical answer, the program assumes that a hydraulic jump occurred between that section and the previous cross section.
4. The program then goes to the next downstream location that has a critical depth answer and continues the process.

An example mixed flow profile, from HEC-RAS, is shown in Figure 4.2. This example was adapted from problem 9-8, page 245, in Chow's "Open Channel Hydraulics" (Chow, 1959).

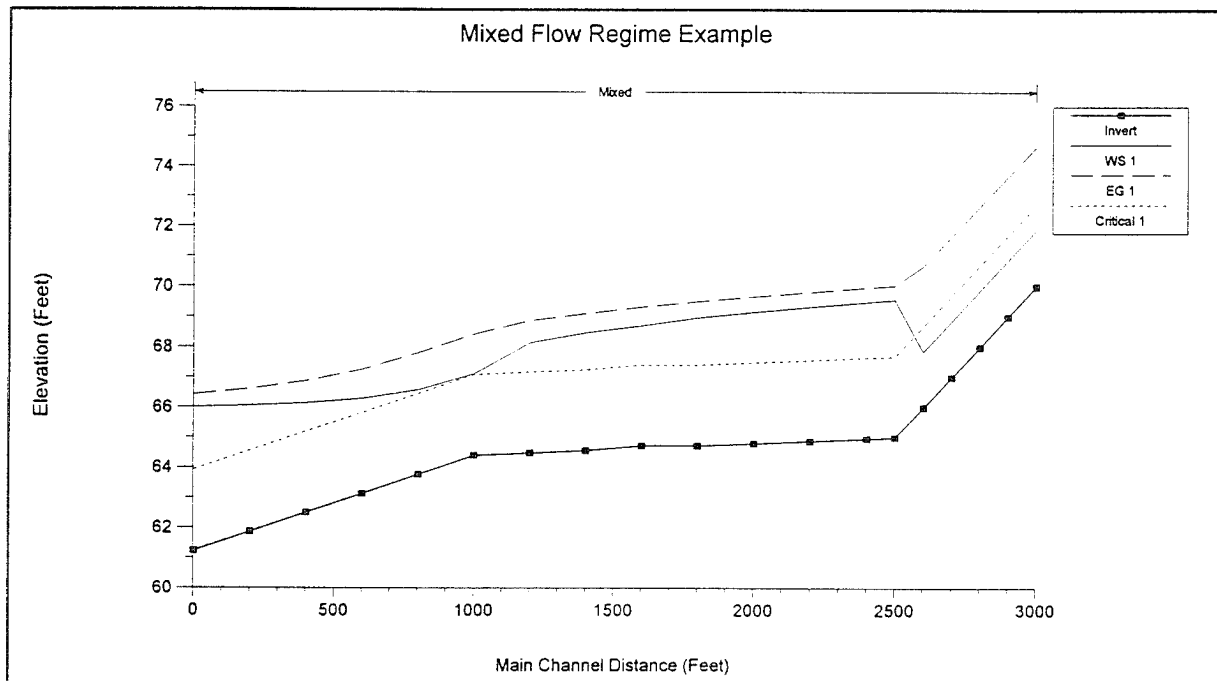

Figure 4.2 Example Mixed Flow Regime Profile from HEC-RAS

As shown in Figure 4.2, the flow regime transitions from supercritical to subcritical just before the first break in slope.

Modeling Stream Junctions

Stream junctions can be modeled in two different ways within HEC-RAS. The default method is an energy based solution. This method solves for water surfaces across the junction by performing standard step backwater and forewater calculations through the junction. The method does not account for the angle of any of the tributary flows. Because most streams are highly subcritical flow, the influence of the tributary flow angle is often insignificant. If the angle of the tributary plays an important role in influencing the water surface around the junction, then the user should switch to the alternative method available in HEC-RAS, which is a momentum based method. The momentum based method is a one dimensional formulation of the momentum equation, but the angles of the tributaries are used to evaluate the forces associated with the tributary flows. There are six possible flow conditions that HEC-RAS can handle at a junction:

1. Subcritical flow - flow combining
2. Subcritical flow - flow split
3. Supercritical flow - flow combining
4. Supercritical flow- flow split
5. Mixed flow regime - flow combining
6. Mixed flow regime - flow split

The most common situations are the subcritical flow cases (1) and (2). The following is a discussion of how the energy method and the momentum based method are applied to these six flow cases.

Energy Based Junction Method

The energy based method solves for water surfaces across the junction by performing standard step calculations with the one dimensional energy equation (equation 2-1). Each of the six cases are discussed individually.

Case 1: Subcritical Flow - Flow Combining.

An example junction with flow combining is shown in Figure 4.3. In this case, subcritical flow calculations are performed up to the most upstream section of reach 3. From here, backwater calculations are performed separately across the junction for each of the two upstream reaches. The water surface at reach 1, station 4.0 is calculated by performing a balance of energy from station 3.0 to 4.0. Friction losses are based on the length from station 4.0 to 3.0 and the average friction slope between the two sections. Contraction or expansion losses are also evaluated across the junction. The water surface for the downstream end of reach 2 is calculated in the same manner. The energy equation from station 3.0 to 4.0 is written as follows:

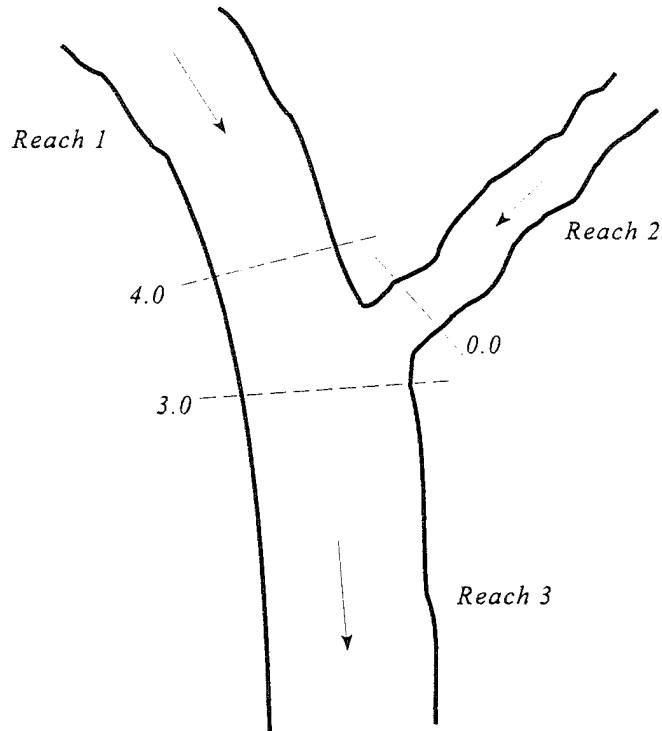

Figure 4.3 Example Junction with Flow Combining.

$$WS_4 + \frac{\alpha_4 V_4^2}{2g} = WS_3 + \frac{\alpha_3 V_3^2}{2g} + L_{4-3} \bar{S}_{f_{4-3}} + C \left| \frac{\alpha_4 V_4^2}{2g} - \frac{\alpha_3 V_3^2}{2g} \right| \quad (4-4)$$

Case 2: Subcritical Flow - Flow Split

For this case, a subcritical water surface profile is calculated for both reaches 2 and 3, up to river stations 2.0 and 3.0 (see Figure 4.4). The program then calculates the specific force (momentum) at the two locations. The cross section with the greater specific force is used as the downstream boundary for calculating the water surface across the junction at river station 4.0. For example, if cross section 3.0 had a greater specific force than section 2.0, the program will compute a backwater profile from station 3.0 to station 4.0 in order to get the water surface at 4.0.

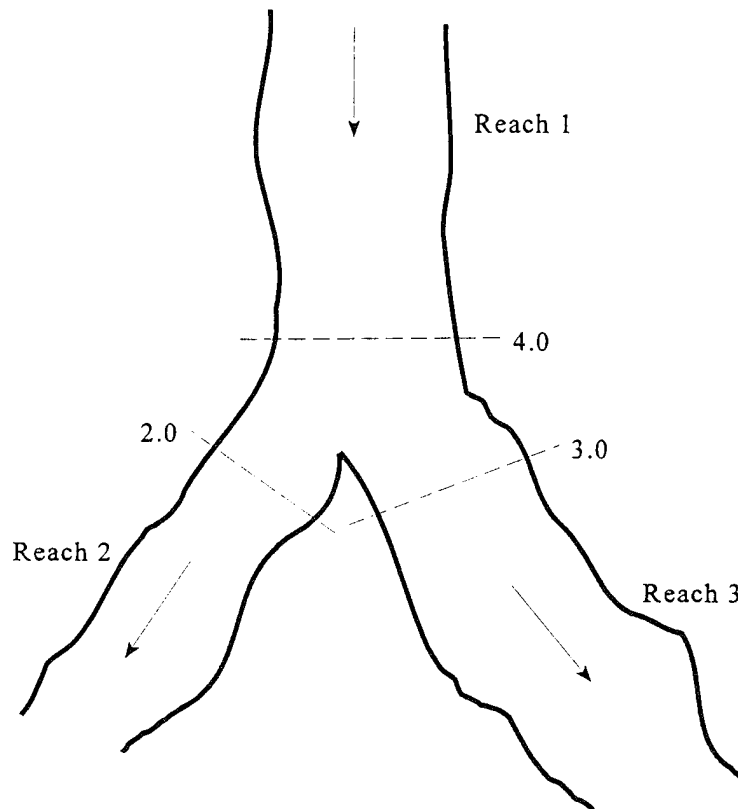

Figure 4.4 Example Flow Split at a Junction.

Currently the HEC-RAS program assumes that the user has entered the correct flow for each of the three reaches. In general, the amount of flow going to reach 2 and reach 3 is unknown. In order to obtain the correct flow distribution at the flow split, the user must perform a trial and error process. This procedure involves the following:

1. Assume an initial flow split at the junction.
2. Run the program in order to get energies and water surfaces at all the locations around the junction.
3. Compare the energy at stations 2.0 and 3.0. If they differ by a significant magnitude, then the flow distribution is incorrect. Re-distribute the flow by putting more flow into the reach that had the lower energy.
4. Run the program again and compare the energies. If the energy at stations 2.0 and 3.0 still differ significantly, then re-distribute the

flow again.

5. Keep doing this until the energies at stations 2.0 and 3.0 are within a reasonable tolerance.

Ideally it would be better to perform a backwater from station 2.0 to 4.0 and also from station 3.0 to 4.0, and then compare the two computed energies at the same location. Since the program only computes one energy at station 4.0, the user must compare the energies at the downstream cross sections. This procedure assumes that the cross sections around the junction are spaced closely together.

Case 3: Supercritical Flow - Flow Combining

In this case, a supercritical water surface profile is calculated for all of reach 1 and 2, down to stations 4.0 and 0.0 (see Figure 4.5). The program calculates the specific force at stations 4.0 and 0.0, and then takes the stream with the larger specific force as the controlling stream. A supercritical forewater calculation is made from the controlling upstream section down to station 3.0.

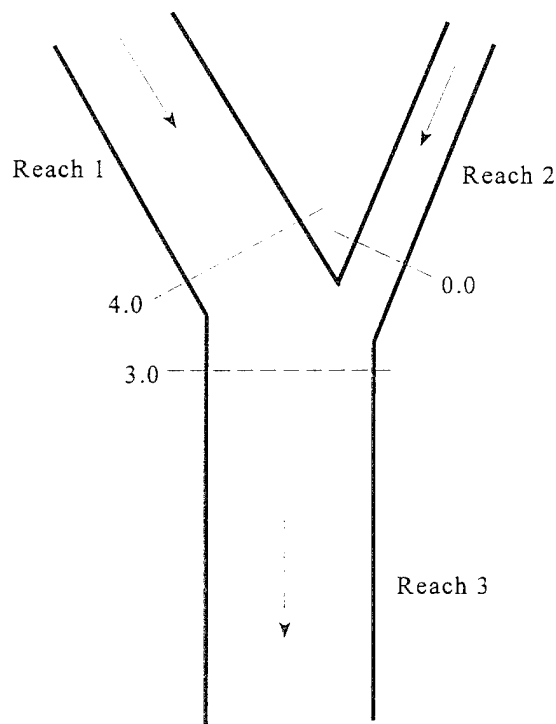

Figure 4.5 Example Supercritical Flow Combine

Case 4: Supercritical Flow - Flow Split

In this case a supercritical water surface profile is calculated down to station 4.0 of reach 1 (see Figure 4.6). The water surfaces at sections 3.0 and 2.0 are calculated by performing separate forewater calculations from station 4.0 to station 2.0, and then from station 4.0 to 3.0.

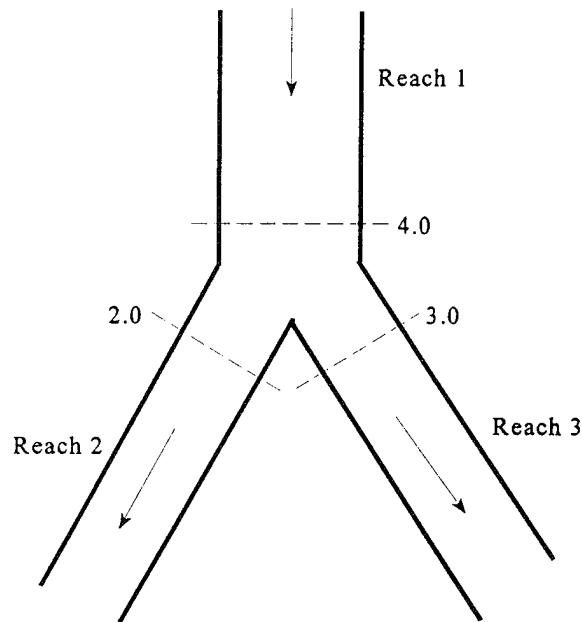

Figure 4.6 Example Supercritical Flow Split

Case 5: Mixed Flow Regime - Flow Combining

In the case of mixed flow, a subcritical profile calculation is made through the junction as described previously (see Figure 4.7). If the flow remains subcritical during the supercritical flow calculations, then the subcritical answers are assumed to be correct. If, however, the flow at either or both of the cross sections upstream of the junction is found to have supercritical flow controlling, then the junction must be re-calculated. When one or more of the upstream sections is supercritical, the program will calculate the specific force of all the upstream sections. If the supercritical sections have a greater specific force than the subcritical sections, then the program assumes that supercritical flow will control. The program then makes a forewater calculation from the upstream section with the greatest specific force (let's say section 4.0) to the downstream section (section 3.0).

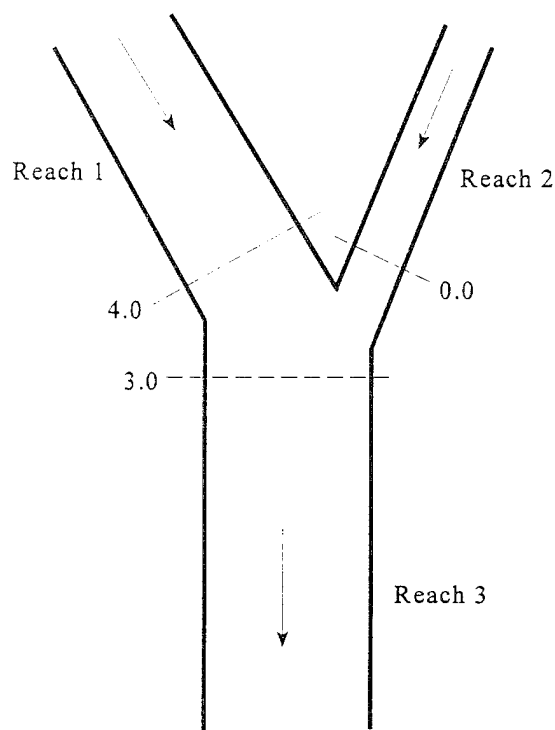

Figure 4.7 Example of Mixed Flow Regime at a Flow Combine

The program next computes the specific force of both the subcritical and supercritical answers at section 3.0. If the supercritical answer at section 3.0 has a lower specific force than the previously computed subcritical answer, then the program uses the subcritical answer and assumes that a hydraulic jump occurred at the junction. If the supercritical answer has a greater specific force, then the program continues downstream with forewater calculations until a hydraulic jump is encountered. Also, any upstream reach that is subcritical must be recomputed. For example, if reach two is subcritical, the water surface at section 0.0 was based on a backwater calculation from section 3.0 to 0.0. If section 3.0 is found to be supercritical, the water surface at section 0.0 is set to critical depth, and backwater calculations are performed again for reach 2. If there are any reaches above reach 2 that are affected by this change, then they are also recomputed.

Case 6: Mixed Flow Regime - Split Flow

Figure 4.8 Example of Mixed Flow Regime at a Flow Split

In this case, a subcritical profile through the junction is computed as described previously. If during the supercritical flow pass it is found that section 4.0 (Figure 4.8) is actually supercritical, the program will perform forewater calculations across the junction. The program will make a forewater calculation from section 4.0 to 2.0 and then from 4.0 to 3.0. The program will then calculate the specific force of the subcritical and supercritical answers at sections 2.0 and 3.0. Which ever answer has the greater specific force is assumed to be correct for each location. Normal mixed flow regime calculations continue on downstream from the junction.

Momentum Based Junction Method

The user can choose a momentum based method to solve the junction problem instead of the default energy based method. As described previously, there are six possible flow conditions at the junction. The momentum based method uses the same logic as the energy based method for solving the junction problem. The only difference is that the momentum

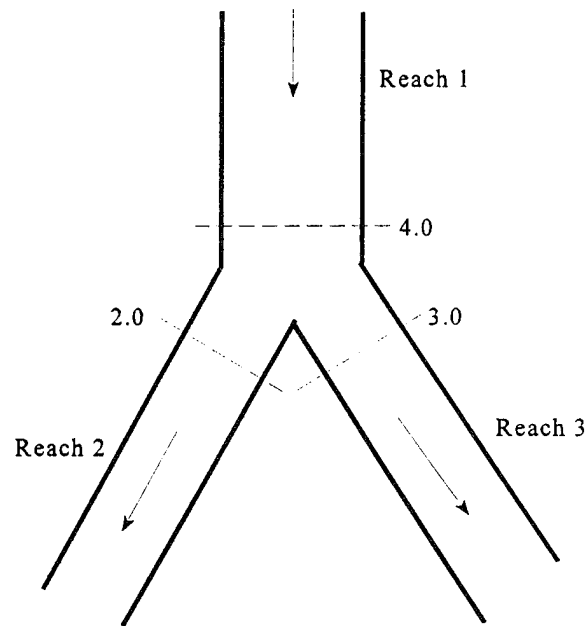
based method solves for the water surfaces across the junction with the momentum equation. Also, the momentum equation is formulated such that it can take into account the angles at which reaches are coming into or leaving the junction. To use the momentum based method, the user must supply the angle for any reach who's flow lines are not parallel to the main stem's flow lines. An example of a flow combining junction is shown below in Figure 4.9. In this example, angles for both reaches 1 and 2 could be entered. Each angle is taken from a line that is perpendicular to cross section 3.0 of reach 3.

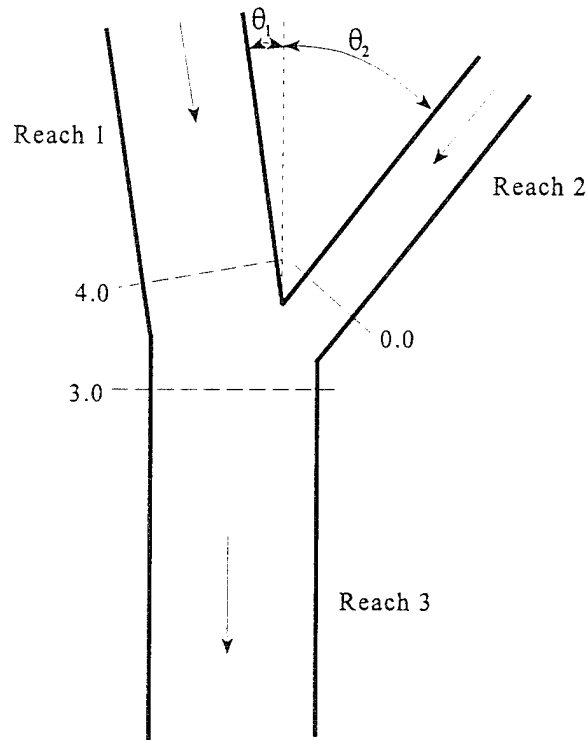

Figure 4.9 Example Geometry for Applying the Momentum Equation to a Flow Combining Junction

For subcritical flow, the water surface is computed up to section 3.0 of reach 3 by normal standard step backwater calculations. If the momentum equation is selected, the program solves for the water surfaces at sections 4.0 and 0.0 by performing a momentum balance across the junction. The momentum balance is written to only evaluate the forces in the X direction (the direction of flow based on cross section 3.0 of reach 3). For this example the equation is as follows:

$$SF_3 = SF_4 \cos(\theta_1) - F_{f_{4-3}} + W_{x_{4-3}} + SF_0 \cos(\theta_2) - F_{f_{0-3}} + W_{x_{0-3}} \quad (4-5)$$

where: SF = Specific Force (as define in Equation 4.3)

The frictional and the weight forces are computed in two segments. For example, the friction and weight forces between sections 4.0 and 3.0 are based on the assumption that the centroid of the junction is half the distance between the two sections, The first portion of the forces are computed from section 4.0 to the centroid of the junction, utilizing the area at cross section 4.0. The second portion of the forces are computed from the centroid of the junction to section 3.0, using a flow weighted area at section 3.0. The equations to compute the friction and weight forces for this example are as follows:

Forces due to friction:

$$F_{f_{4-3}} = \bar{S}_{f_{4-3}} \frac{L_{4-3}}{2} A_4 \cos(\theta_1) + \bar{S}_{f_{4-3}} \frac{L_{4-3}}{2} A_3 \frac{Q_4}{Q_3} \quad (4-6)$$

$$F_{f_{0-3}} = \bar{S}_{f_{0-3}} \frac{L_{0-3}}{2} A_0 \cos(\theta_2) + \bar{S}_{f_{0-3}} \frac{L_{0-3}}{2} A_3 \frac{Q_0}{Q_3} \quad (4-7)$$

Forces due to weight of water:

$$W_{x_{4-3}} = S_{o_{4-3}} \frac{L_{4-3}}{2} A_4 \cos(\theta_1) + S_{o_{4-3}} \frac{L_{4-3}}{2} A_3 \frac{Q_4}{Q_3} \quad (4-8)$$

$$W_{x_{0-3}} = S_{o_{0-3}} \frac{L_{0-3}}{2} A_0 \cos(\theta_2) + S_{o_{0-3}} \frac{L_{0-3}}{2} A_3 \frac{Q_0}{Q_3} \quad (4-9)$$

To solve the momentum balance equation (Equation 4-5) for this example, the following assumptions are made:

1. The water surface elevations at section 4.0 and 0.0 are solved simultaneously, and are assumed to be equal to each other. This is a rough approximation, but it is necessary in order to solve Equation 4-5. Because of this assumption, the cross sections around the junction

should be closely spaced in order to minimize the error associated with this assumption.

2. The area used at section 3.0 for friction and weight forces is distributed between the upper two reaches by using a flow weighting. This is necessary in order not to double account for the flow volume and frictional area.

When evaluating supercritical flow at this type of junction (Figure 4.9), the water surface elevations at sections 4.0 and 0.0 are computed from forewater calculations, and therefore the water surface elevations at section 3.0 can be solved directly from equation 4-5.

For mixed flow regime computations, the solution approach is the same as the energy based method, except the momentum equation is used to solve for the water surfaces across the junction.

An example of applying the momentum equation to a flow split is shown in Figure 4.10 below:

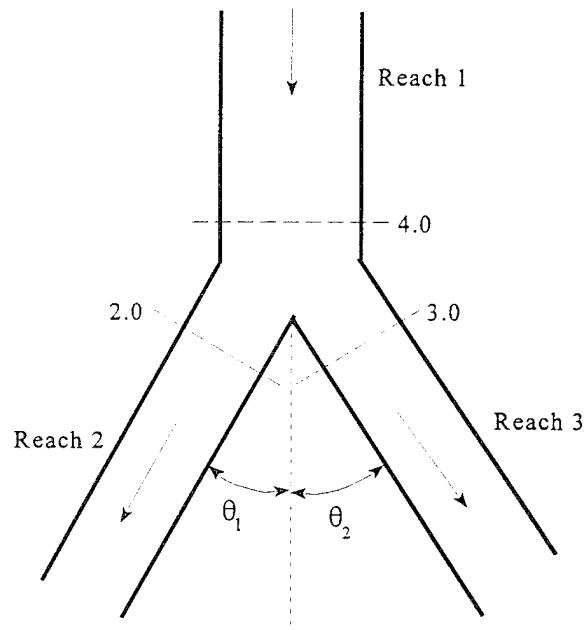

Figure 4.10 Example Geometry for Applying the Momentum Equation to a Flow Split Type of Junction

For the flow split shown in Figure 4.10, the momentum equation is written as follows:

$$SF_4 = SF_2 \cos(\theta_1) - F_{f_{4-2}} + W_{x_{4-2}} + SF_3 \cos(\theta_2) - F_{f_{4-3}} + W_{x_{4-3}} \quad (4-10)$$

For subcritical flow, the water surface elevation is known at sections 2.0 and 3.0, and the water surface elevation at section 4.0 can be found by solving Equation 4-10. For supercritical flow, the water surface is known at section 4.0 only, and, therefore, the water surface elevations at sections 3.0 and 2.0 must be solved simultaneously. In order to solve Equation 4-10 for supercritical flow, it is assumed that the water surface elevations at sections 2.0 and 3.0 are equal.

Mixed flow regime computations for a flow split are handled in the same manner as the energy based solution, except the momentum equation (Equation 4-10) is used to solve for the water surface elevations across the junction.

Flow Distribution Calculations

The general cross section output shows the distribution of flow in three subdivisions of the cross section: left overbank, main channel, and the right overbank. Additional output showing the distribution of flow for multiple subdivisions of the left and right overbanks, as well as the main channel, can be requested by the user.

The flow distribution output can be obtained by first defining the locations that the user would like to have this type of output. The user can either select specific locations or all locations in the model. Next, the number of slices for the flow distribution computations must be defined for the left overbank, main channel, and the right overbank. The user can define up to 45 total slices. Each flow element (left overbank, main channel, and right overbank) must have at least one slice. The user can change the number of slices used at each of the cross sections. The final step is to perform the normal profile calculations.

During the computations, at each cross section where flow distribution is requested, the program will calculate the percentage of flow, area, wetted perimeter, conveyance, and average velocity for each of the user defined slices.

For further details on how to request and view flow distribution output, see Chapters 7 and 8 of the HEC-RAS User's manual.

The computations for the flow distribution are performed after the program has calculated a water surface elevation and energy by the normal methodology described in chapter 2 of this manual. The flow distribution computations are performed as follows:

1. First, the water surface is computed in the normal manner of using the three flow subdivisions (left overbank, main channel, and right overbank), and balancing the energy equation.
2. Once a water surface elevation is computed, the program slices the cross section into the user defined flow distribution slices, and then computes an area, wetted perimeter, and hydraulic depth (area over top width) for each slice.
3. Using the originally computed energy slope (S_f), the cross section Manning's n values, the computed area and wetted perimeter for each slice, and Manning's equation, the program computes the conveyance and percentage of discharge for each of the slices.
4. The program sums up the computed conveyance for each of the slices. In general, the slice computed conveyance will not be the same as the originally computed conveyance (from the traditional methods for conveyance subdivision described in Chapter 2 of this manual). Normally, as a cross section is subdivided further and further, the computed conveyance, for a given water surface elevation, will increase.
5. In order to correct for the difference in computed conveyances, the program computes a ratio of the original total conveyance (from the normal calculations) divided by the total slice conveyance. This ration is then applied to each of the slices, in order to achieve the same conveyance as was originally computed.
6. The final step is to compute an average velocity for each slice. The average velocity is computed by taking the discharge and dividing by the area for each of the user defined slices.

An example of the flow distribution output is shown in Figure 4.11.

Flow Distribution Output							
File Type Options							
Reach	1	River Sta.	12	Profile	1		
HEC-RAS Plan: Existing Reach: 1 Riv Sta: 12 Profile: 1							
Left Sta	Right Sta	%Q	Area	W.P.	Conv.	Hydr D.	Velocity
(ft)	(ft)		(sq ft)	(ft)	(cfs)	(ft)	(ft/s)
0.00	144.00	13.21	423.48	122.48	14388.5	3.47	2.81
144.00	288.00	11.63	419.87	145.02	12673.8	2.92	2.49
288.00	432.00	14.76	484.57	145.17	16081.9	3.37	2.74
432.00	576.00	11.78	421.87	144.01	12834.1	2.93	2.51
576.00	720.00	10.00	382.47	144.11	10894.3	2.66	2.35
720.00	724.50	0.45	10.24	5.67	563.8	2.27	3.96
724.50	729.00	2.11	26.27	5.89	2645.5	5.84	7.24
729.00	733.50	4.98	41.87	5.22	6234.0	9.31	10.71
733.50	738.00	6.68	47.49	4.60	8364.4	10.55	12.67
Errors, Warnings and Notes							
Warning - The velocity head has changed by more than 0.5 ft (0.15 m). This may indicate the need for additional cross sections.							↑
Warning - The energy loss was greater than 1.0 ft (0.3 m) between the current and							↓

Figure 4.11 Example Output for the Flow Distribution Option

In general, the results of the flow distribution computations should be used cautiously. Specifically, the velocities and percentages of discharge are based on the results of a one-dimensional hydraulic model. A true velocity and flow distribution varies vertically as well as horizontally. To achieve such detail, the user would need to use a three-dimensional hydraulic model, or go out and measure the flow distribution in the field. While the results for the flow distribution, provided by HEC-RAS, are better than the standard three subdivisions (left overbank, main channel, and right overbank) provided by the model, the values are still based on average estimates of the one-dimensional results. Also, the results obtained from the flow distribution option can vary with the number of slices used for the computations. In general, it is better to use as few slices as possible.

CHAPTER 5

Modeling Bridges

HEC-RAS computes energy losses caused by structures such as bridges and culverts in three parts. One part consists of losses that occur in the reach immediately downstream from the structure, where an expansion of flow generally takes place. The second part is the losses at the structure itself, which can be modeled with several different methods. The third part consists of losses that occur in the reach immediately upstream of the structure, where the flow is generally contracting to get through the opening. This chapter discusses how bridges are modeled using HEC-RAS. Discussions include: general modeling guidelines; hydraulic computations through the bridge; selecting a bridge modeling approach; and unique bridge problems and suggested approaches.

Contents

- General Modeling Guidelines
- Hydraulic Computations Through the Bridge
- Selecting a Bridge Modeling Approach
- Unique Bridge Problems and Suggested Approaches

General Modeling Guidelines

Considerations for modeling the geometry of a reach of river in the vicinity of a bridge are essentially the same for any of the available bridge modeling approaches within HEC-RAS. Modeling guidelines are provided in this section for locating cross sections; defining ineffective flow areas; and evaluating contraction and expansion losses around bridges.

Cross Section Locations

The bridge routines utilize four user-defined cross sections in the computations of energy losses due to the structure. During the hydraulic computations, the program automatically formulates two additional cross sections inside of the bridge structure. A plan view of the basic cross section layout is shown in Figure 5.1.

Cross section 1 is located sufficiently downstream from the structure so that the flow is not affected by the structure (i.e. the flow has fully expanded). This distance should generally be determined by field investigation during high flows. If field investigation is not possible, then there are two sets of criteria for locating the downstream section. The USGS has established a criterion for locating cross section 1 a distance downstream from the bridge equal to one times the bridge opening width (the distance between points B and C on Figure 5.1). Traditionally, the Corps of Engineers criterion has been to locate the downstream cross section about four times the average length of the side constriction caused by the structure abutments (the average of the distance from A to B and C to D on Figure 5.1). The expansion distance will vary depending upon the degree of constriction, the shape of the constriction, the magnitude of the flow, and the velocity of the flow. Both criteria should be used as rough guidance for placing cross section 1. The user should not allow the distance between cross section 1 and 2 to become so great that friction losses will not be adequately modeled. If the modeler thinks that the expansion reach will require a long distance, then intermediate cross sections should be placed within the expansion reach in order to adequately model friction losses. The ineffective flow option can be used to limit the effective flow area of the intermediate cross sections in the expansion reach.

Cross section 2 is located immediately downstream from the bridge (i.e. within a few feet). This cross section should represent the effective flow area just outside the bridge.

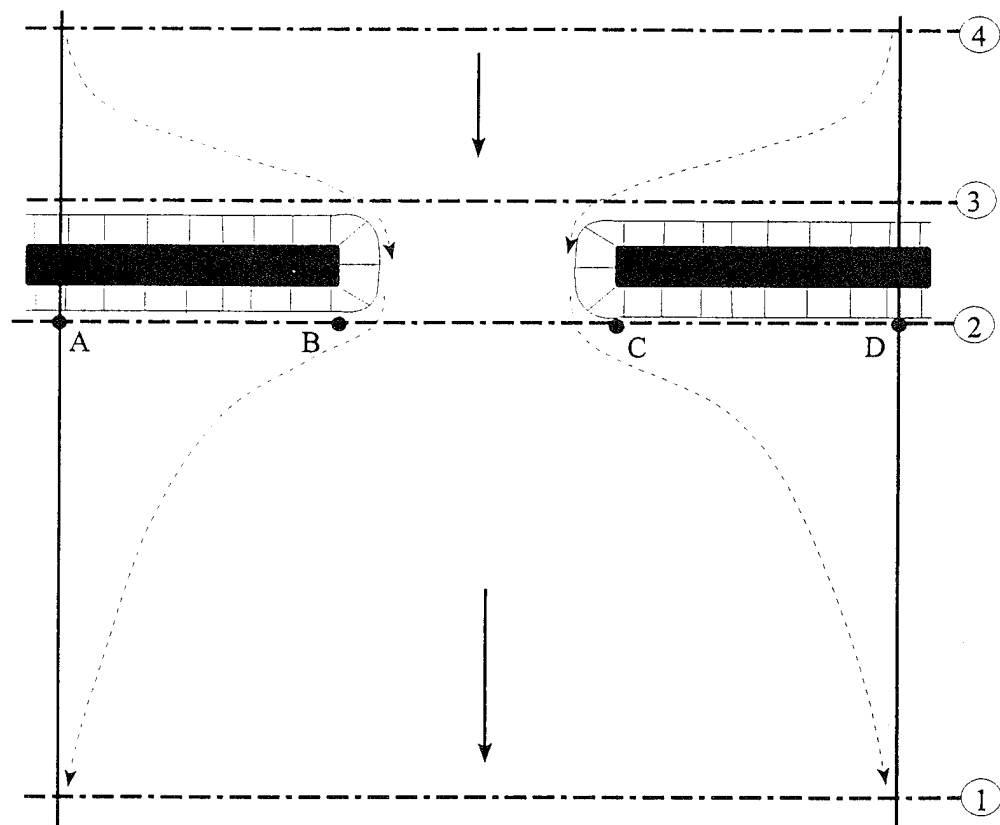

Figure 5.1 Cross Section Locations at a Bridge

Cross section 3 should be located just upstream from the bridge. The distance between cross section 3 and the bridge should be relatively short. This distance should only reflect the length required for the abrupt acceleration and contraction of the flow that occurs in the immediate area of the opening. Cross section 3 represents the effective flow area just upstream of the bridge. Both cross sections 2 and 3 will have ineffective flow areas to either side of the bridge opening during low flow and pressure flow profiles. In order to model only the effective flow areas at these two sections, the modeler should use the ineffective flow area option at both of these cross sections..

Cross section 4 is an upstream cross section where the flow lines are approximately parallel and the cross section is fully effective. Because flow contractions can occur over a shorter distance than flow expansions, the distance between cross section 3 and 4 should be roughly one times the

average width of the opening. However, this criteria for locating the upstream cross section may result in too short a reach length for situations where the width of the bridge opening is very small in comparison to the floodplain. An alternative criterion would be to locate the cross section a distance upstream equal to the average contraction width (the average of the distance from A to B and C to D on Figure 5.1).

During the hydraulic computations, the program automatically formulates two additional cross sections inside of the bridge structure. The geometry inside of the bridge is a combination of the bounding cross sections (sections 2 and 3) and the bridge geometry. The bridge geometry consists of the bridge deck and roadway, sloping abutments if necessary, and any piers that may exist. The user can specify different bridge geometry for the upstream and downstream sides of the structure if necessary. Cross section 2 and the structure information on the downstream side of the bridge are used as the geometry just inside the structure at the downstream end. Cross section 3 and the upstream structure information are used as the bridge geometry just inside the structure at the upstream end.

Defining Ineffective Flow Areas

A basic problem in setting up the bridge routines is the definition of ineffective flow areas near the bridge structure. Referring to Figure 5-1, the dashed lines represent the effective flow boundary for low flow and pressure flow conditions. Therefore, for cross sections 2 and 3, ineffective flow areas to either side of the bridge opening (along distance AB and CD) should not be included as part of the active flow area for low flow or pressure flow.

The bridge example shown in Figure 5-2 is a typical situation where the bridge spans the entire floodway and its abutments obstruct the natural floodway. This is the same situation as was shown in plan view in Figure 5-1. The cross section numbers and locations are the same as those discussed in the "Cross Section Locations" section of this chapter. The problem is to convert the natural ground profile at cross sections 2 and 3 from the cross section shown in part "B" to that shown in part "C" of Figure 5-2. The elimination of the ineffective overbank areas can be accomplished by redefining the geometry at cross sections 2 and 3 (as shown in part C of Figure 5-2) or by using the natural ground profile and requesting the program's ineffective area option to eliminate the use of the overbank area. Also, for high flows (flows over topping the bridge deck), the area outside of the main bridge opening will no longer be ineffective, and will need to be included as active flow area. By redefining the cross section, a fixed boundary is used at the sides of the cross section to contain the flow, when in fact a solid boundary is not physically there. The use of the ineffective area option does not add wetted perimeter to the flow boundary above the given ground profile.

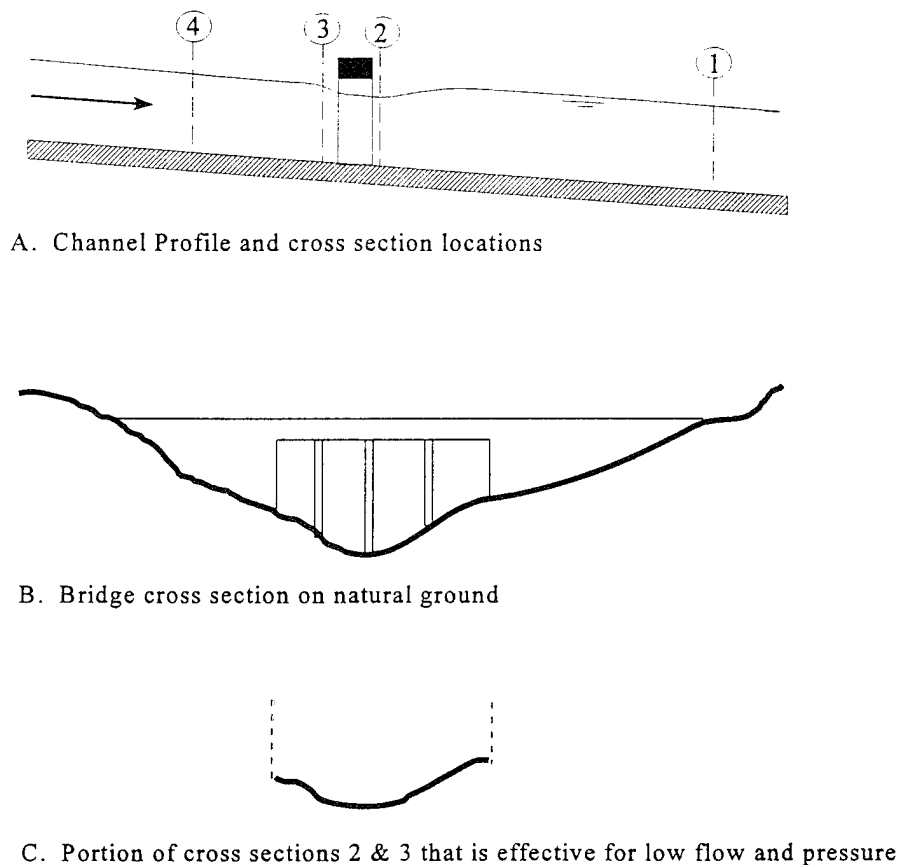

Figure 5.2 Cross Sections Near Bridges

The ineffective area option is used at sections 2 and 3 to keep all the flow in the area of the bridge opening until the elevations associated with the left and/or right ineffective flow areas are exceeded by the computed water surface elevation. The program allows the stations and controlling elevations of the left and right ineffective flow areas to be specified by the user. The default stations and elevations are set to the main channel bank stations when the option is turned on. If these stations and elevations are not what is desired, then the user can specify different values to be used. Also, the stations of the ineffective flow areas do not have to coincide with stations of the ground profile, the program will interpolate the ground station.

The elevations specified for ineffective flow should correspond to elevations where significant weir flow passes over the bridge. For the downstream cross section, the threshold water surface elevation for weir flow is not usually

known on the initial run, so an estimate must be made. An elevation near the minimum top-of-road elevation can be used as a first estimate. Some people use an average between the low chord and minimum top-of-road elevation as a first estimate.

Using the ineffective area option to define the ineffective flow areas allows the overbank areas to become effective as soon as the ineffective area elevations are exceeded. The assumption is that under weir flow conditions, the water can generally flow across the whole bridge length and the entire overbank in the vicinity of the bridge would be effectively carrying flow up to and over the bridge. If it is more reasonable to assume only part of the overbank is effective for carrying flow when the bridge is under weir flow, then the overbank n values can be increased to reduce the amount of conveyance in the overbank areas under weir flow conditions.

Cross section 3, just upstream from the bridge, is usually defined in the same manner as cross section 2. In many cases the cross sections are identical. The only difference generally is the elevations to use for the ineffective area option. For the upstream cross section, the elevation usually would be the low point of the top-of-road.

Using the ineffective area option in the manner just described for the two cross sections on either side of the bridge provides for a constricted section when all of the flow is going under the bridge. When the water surface is higher than the control elevations used, the entire cross section is used. The program user should check the computed solutions on either side of the bridge section to ensure they are consistent with the type of flow. That is, for low flow or pressure flow solutions, the output should show the effective area restricted to the main channel. When the bridge output indicates weir flow, the solution should show that the entire cross section is effective. During overflow situations, the modeler should ensure that the overbank flow around the bridge is consistent with the weir flow.

Contraction and Expansion Losses

Losses due to contraction and expansion of flow between cross sections are determined by standard step profile calculations. Manning's equation is used to calculate friction losses, and all other losses are described in terms of a coefficient times the absolute value of the change in velocity head between adjacent cross sections. When the velocity head increases in the downstream direction, a contraction coefficient is used; and when the velocity head decreases, an expansion coefficient is used.

As shown in Figure 5.1, the flow contraction occurs between cross sections 4 and 3, while the flow expansion occurs between sections 2 and 1. The contraction and expansion coefficients are used to compute energy losses

associated with changes in the shape of river cross sections (or effective flow areas). The loss due to expansion of flow is usually much larger than the contraction loss, and losses from short abrupt transitions are larger than losses from gradual transitions. Typical values for contraction and expansion coefficients are shown in Table 5.1 below:

Table 5.1
Contraction and Expansion Coefficients

	Contraction	Expansion
No transition loss computed	0.0	0.0
Gradual transitions	0.1	0.3
Typical Bridge sections	0.3	0.5
Abrupt transitions	0.6	0.8

The maximum value for the expansion coefficient would be one (1.0).

Hydraulic Computations Through the Bridge

The bridge routines in HEC-RAS allow the modeler to analyze a bridge with several different methods without changing the bridge geometry. The bridge routines have the ability to model low flow (Class A, B, and C), low flow and weir flow (with adjustments for submergence on the weir), pressure flow (orifice and sluice gate equations), pressure and weir flow, and highly submerged flows (the program will automatically switch to the energy equation when the flow over the road is highly submerged). This portion of the manual describes in detail how the program models each of these different flow types.

Low Flow Computations

Low flow exists when the flow going through the bridge opening is open channel flow (water surface below the highest point on the low chord of the bridge opening). For low flow computations, the program first uses the momentum equation to identify the class of flow. This is accomplished by first calculating the momentum at critical depth inside the bridge at the upstream and downstream ends. The end with the higher momentum (therefore most constricted section) will be the controlling section in the bridge. If the two sections are identical, the program selects the upstream bridge section as the controlling section. The momentum at critical depth in

the controlling section is then compared to the momentum of the flow downstream of the bridge when performing a subcritical profile (upstream of the bridge for a supercritical profile). If the momentum downstream is greater than the critical depth momentum inside the bridge, the class of flow is considered to be completely subcritical (i.e. class A low flow). If the momentum downstream is less than the momentum at critical depth, in the controlling bridge section, then it is assumed that the constriction will cause the flow to pass through critical depth and a hydraulic jump will occur at some distance downstream (i.e. class B low flow). If the profile is completely supercritical through the bridge, then this is considered class C low flow.

Class A low flow. Class A low flow exists when the water surface through the bridge is completely subcritical (i.e. above critical depth). Energy losses through the expansion (sections 2 to 1) are calculated as friction losses and expansion losses. Friction losses are based on a weighted friction slope times a weighted reach length between sections 1 and 2. The average friction slope is based on one of the four available alternatives in the HEC-RAS, with the average-conveyance method being the default. This option is user selectable. The average length used in the calculation is based on a discharge-weighted reach length. Energy losses through the contraction (sections 3 to 4) are calculated as friction losses and contraction losses. Friction and contraction losses between sections 3 and 4 are calculated in the same way as friction and expansion losses between sections 1 and 2.

There are four methods available for computing losses through the bridge (sections 2 to 3):

- Energy Equation (standard step method)
- Momentum Balance
- Yarnell Equation
- USGS Contracted Opening method

The user can select any or all of these methods in the computations. If more than one method is selected, the user must choose either a single method as the final solution or direct the program to use the method that computes the greatest energy loss through the bridge as the answer at section 3. This allows the modeler to compare the answers from several techniques all in a single execution of the program. Minimal results are available for all the methods computed, but detailed results are available for the method that is selected as the final answer. A detailed discussion of each method follows:

Energy Equation (standard step method):

The energy based method treats a bridge in the same manner as a natural river cross section, except the area of the bridge below the water surface is subtracted from the total area, and the wetted perimeter is increased where the water is in contact with the bridge structure. As described previously, the program formulates two cross sections inside the bridge by combining the ground information of sections 2 and 3 with the bridge geometry. As shown in Figure 5.3, for the purposes of discussion, these cross sections will be referred to as sections BD (Bridge downstream) and BU (Bridge Upstream).

The sequence of calculations starts with a standard step calculation from just downstream of the bridge (section 2) to just inside of the bridge (section BD) at the downstream end. The program then performs a standard step through the bridge (from section BD to section BU). The last calculation is to step out of the bridge (from section BU to section 3).

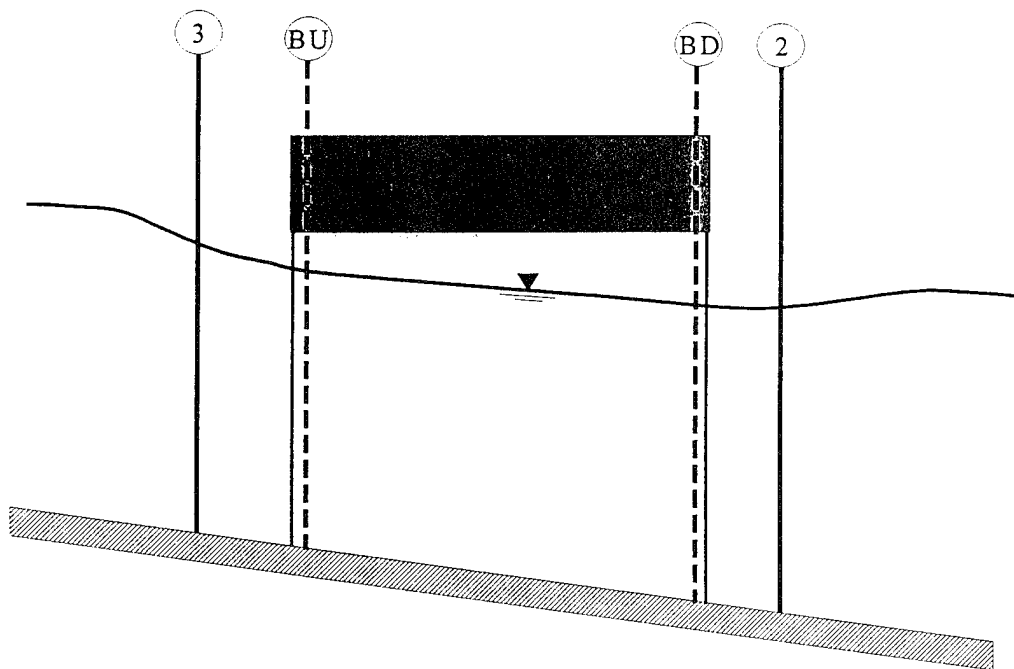

Figure 5.3 Cross Sections Near and Inside the Bridge

The energy based method requires Manning's n values for friction losses and contraction and expansion coefficients for transition losses. The estimate of Manning's n values is well documented in many hydraulics text books, as well as several research studies. Basic guidance for estimating roughness coefficients is provided in chapter 3 of this manual. Contraction and expansion coefficients are also provided in chapter 3, as well as in earlier sections of this chapter. Detailed output is available for cross sections inside the bridge (sections BD and BU) as well as the user entered cross sections (sections 2 and 3).

Momentum Balance Method:

The momentum method is based on performing a momentum balance from cross section 2 to cross section 3. The momentum balance is performed in three steps. The first step is to perform a momentum balance from cross section 2 to cross section BD inside the bridge. The equation for this momentum balance is as follows:

$$A_{BD} \bar{Y}_{BD} + \frac{\beta_{BD} Q_{BD}^2}{g A_{BD}} = A_2 \bar{Y}_2 - A_{p2} \bar{Y}_{p2} + \frac{\beta_2 Q_2^2}{g A_2} + F_f - W_x \quad (5-1)$$

- where: A_2, A_{BD} = Active flow area at section 2 and BD, respectively
- A_{p2} = Obstructed area of the pier on the downstream side
- \bar{Y}_2, \bar{Y}_{BD} = Vertical distance from water surface to center of gravity of flow area A_2 and A_{BD} , respectively
- \bar{Y}_{p2} = Vertical distance from water surface to center of gravity of wetted pier area on downstream side
- β_2, β_{BD} = Velocity weighting coefficients for momentum
- Q_2, Q_{BD} = Discharge
- g = Gravitational acceleration
- F_f = Force due to friction
- W_x = Force due to weight of water in the direction of flow

The second step is a momentum balance from section BD to BU (see Figure 5.3). The equation for this step is as follows:

$$A_{BU} \bar{Y}_{BU} + \frac{\beta_{BU} Q_{BU}^2}{g A_{BU}} = A_{BD} \bar{Y}_{BD} + \frac{\beta_{BD} Q_{BD}^2}{g A_{BD}} + F_f - W_x \quad (5-2)$$

The final step is a momentum balance from section BU to section 3 (see Figure 5.3). The equation for this step is as follows:

$$A_3 \bar{Y}_3 + \frac{\beta_3 Q_3^2}{g A_3} = A_{BU} \bar{Y}_{BU} + \frac{\beta_{BU} Q_{BU}^2}{g A_{BU}} + A_{p3} \bar{Y}_{p3} + \frac{1}{2} C_D \frac{A_{p3} Q_3^2}{g A_3^2} + F_f - W_x \quad (5-3)$$

where: C_D = Drag coefficient for flow going around the piers.
Guidance on selecting drag coefficients can be found under Table 5.2 below.

The momentum balance method requires the use of roughness coefficients for the estimation of the friction force and a drag coefficient for the force of drag on piers. As mentioned previously, roughness coefficients are described in chapter 3 of this manual. Drag coefficients are used to estimate the force due to the water moving around the piers, the separation of the flow, and the resulting wake that occurs downstream. Drag coefficients for various cylindrical shapes have been derived from experimental data (Lindsey, 1938). The following table shows some typical drag coefficients that can be used for piers:

Table 5.2
Typical drag coefficients for various pier shapes

Pier Shape	Drag Coefficient C_D
Circular pier	1.20
Elongated piers with semi-circular ends	1.33
Elliptical piers with 2:1 length to width	0.60
Elliptical piers with 4:1 length to width	0.32
Elliptical piers with 8:1 length to width	0.29
Square nose piers	2.00
Triangular nose with 30 degree angle	1.00
Triangular nose with 60 degree angle	1.39
Triangular nose with 90 degree angle	1.60
Triangular nose with 120 degree angle	1.72

The momentum method provides detailed output for the cross sections inside the bridge (BU and BD) as well as outside the bridge (2 and 3). The user has the option of turning the friction and weight force components off; the default is to include these two terms in the momentum balance. If the user

turns both the friction and weight forces off, the program performs the momentum balance in one step from section 2 to 3. Also, when this happens, no output is available inside the bridge at sections BU and BD.

Yarnell Equation:

The Yarnell equation is an empirical equation that is used to predict the change in water surface from just downstream of the bridge (section 2 of Figure 5.3) to just upstream of the bridge (section 3). The equation is based on approximately 2600 lab experiments in which the researchers varied the shape of the piers, the width, the length, the angle, and the flow rate. The Yarnell equation is as follows (Yarnell, 1934):

$$H_{3-2} = 2K(K + 10\omega - 0.6)(\alpha + 15\alpha^4) \frac{V_2^2}{2g} \quad (5-4)$$

- where: H_{3-2} = The drop in water surface from section 3 to 2.
- K = Yarnell's pier shape coefficient
- ω = Ratio of velocity head to depth at section 2
- α = Obstructed area of the piers divided by the total unobstructed area.
- V_2 = Velocity downstream at section 2

The computed upstream water surface elevation is simply the downstream water surface elevation plus H_{3-2} . With the upstream water surface known the program computes the corresponding velocity head and energy elevation for the upstream section (section 3). When the Yarnell method is used, hydraulic information is only provided at cross sections 2 and 3 (no information is provided for sections BU and BD).

The Yarnell equation is sensitive to the pier shape (K coefficient), the pier obstructed area, and the velocity of the water. The method is not sensitive to the shape of the bridge opening, the shape of the abutments, or the width of the bridge. Because of these limitations, the Yarnell method should only be used at bridges where the majority of the energy losses are associated with the piers.

When Yarnell's equation is used for computing the change in water surface through the bridge, the user must supply the Yarnell pier shape coefficient, K. The following table gives values for Yarnell's pier coefficient, K, for various pier shapes:

Table 5.3
Yarnell's pier coefficient, K, for various pier shapes

Pier Shape	Yarnell K Coefficient
Semi-circular nose and tail	0.90
Twin-cylinder piers with connecting diaphragm	0.95
Twin-cylinder piers without diaphragm	1.05
90 degree triangular nose and tail	1.05
Square nose and tail	1.25
Ten pile trestle bent	2.50

Contracted Opening Method:

The Contracted Opening method is currently not available in HEC-RAS. When the method becomes available, a detailed discussion of the procedure will be provided in this section.

Class B low flow. Class B low flow can exist for either subcritical or supercritical profiles. For either profile, class B flow occurs when the profile passes through critical depth in the bridge constriction. For a **subcritical profile**, the momentum equation or the energy equation can be used to compute an upstream water surface (section 3 of Figure 5.3) above critical depth and a downstream water surface (section 2) below critical depth. For a **supercritical profile**, the bridge is acting as a control and is causing the upstream water surface elevation to be above critical depth. Momentum or energy can be used to calculate an upstream water surface above critical depth and a downstream water surface below critical depth. If the user is running a mixed flow regime profile, the program will proceed with backwater calculations upstream, and later with forewater calculations downstream from the bridge.

Whenever class B flow is found to exist, the user should run the program in a mixed flow regime mode. The mixed flow regime mode is capable of calculating a subcritical profile upstream from the bridge and a supercritical profile downstream from the bridge. Also, any hydraulic jumps can be located if they exist.

Class C low flow. Class C low flow exists when the water surface through the bridge is completely supercritical. The program can use either the energy equation or the momentum equation to compute the water surface through the bridge for this class of flow.

High Flow Computations

The HEC-RAS program has the ability to compute high flows (flows that come into contact with the maximum low chord of the bridge deck) by either the Energy equation (standard step method) or by using separate hydraulic equations for pressure and/or weir flow. The two methodologies are explained below.

Energy Equation (standard step method):

The Energy based method is applied to high flows in the same manner as it is applied to low flows. Computations are based on balancing the energy equation in three steps through the bridge. Energy losses are based on friction and contraction and expansion losses. Output from this method is available at the cross sections inside the bridge as well as outside.

As mentioned previously, friction losses are based on the use on Manning's equation. Guidance for selecting Manning's n values is provided in chapter 3 of this manual. Contraction and expansion losses are based on a coefficient times the change in velocity head. Guidance on the selection of contraction and expansion coefficients has also been provided in chapter 3, as well as previous sections of this chapter.

The Energy based method performs all computations as though they are open channel flow. At the cross sections inside the bridge, the area obstructed by the bridge piers, abutments, and deck is subtracted from the flow area and additional wetted perimeter is added. Occasionally the resulting water surfaces inside the bridge (at sections BU and BD) can be computed at elevations that would be inside of the bridge deck. The water surfaces inside of the bridge reflect the hydraulic grade line elevations, not necessarily the actual water surface elevations.

Pressure and Weir Flow Method:

A second approach for the computation of high flows is to utilize separate hydraulic equations to compute the flow as pressure and/or weir flow. The two types of flow are presented below.

Pressure Flow Computations. Pressure flow occurs when the flow comes into contact with the low chord of the bridge. Once the flow comes into contact with the upstream side of the bridge, a backwater occurs and orifice flow is established. The program will handle two cases of orifice flow; the first is when only the upstream side of the bridge is in contact with the water; and the second is when the bridge constriction is flowing completely full. The HEC-RAS program will automatically select the appropriate equation, depending upon the flow situation. For the first case (see Figure 5.4), a sluice gate type of equation is used (FHWA, 1978):

$$Q = C_d A_{BU} \left[2g \left(Y_3 - \frac{Z}{2} + \frac{\alpha_3 V_3^2}{2g} \right) \right]^{\frac{1}{2}} \quad (5-5)$$

- where: Q = Total discharge through the bridge opening
- C_d = Coefficient of discharge for pressure flow
- A_{BU} = Net area of the bridge opening at section BU
- Y_3 = Hydraulic depth at section 3
- Z = Vertical distance from maximum bridge low chord to the mean river bed elevation at section BU

The discharge coefficient C_d , can vary depending upon the depth of water upstream. Values for C_d range from 0.35 to 0.5, with a typical value of 0.5 commonly used in practice. The user can enter a fixed value for this coefficient or the program will compute one based on the amount that the inlet is submerged. A diagram relating C_d to Y_3/Z is shown in Figure 5.5.

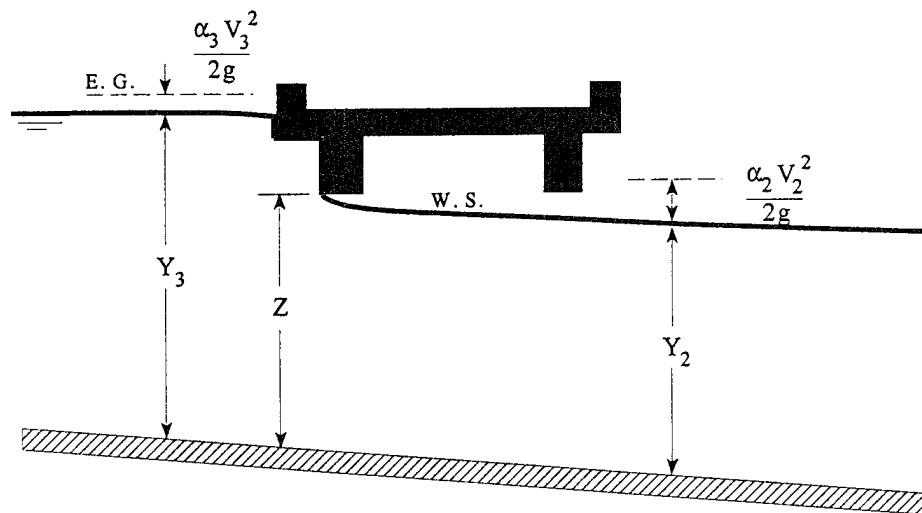

Figure 5.4 Example of a bridge under sluice gate type of pressure flow

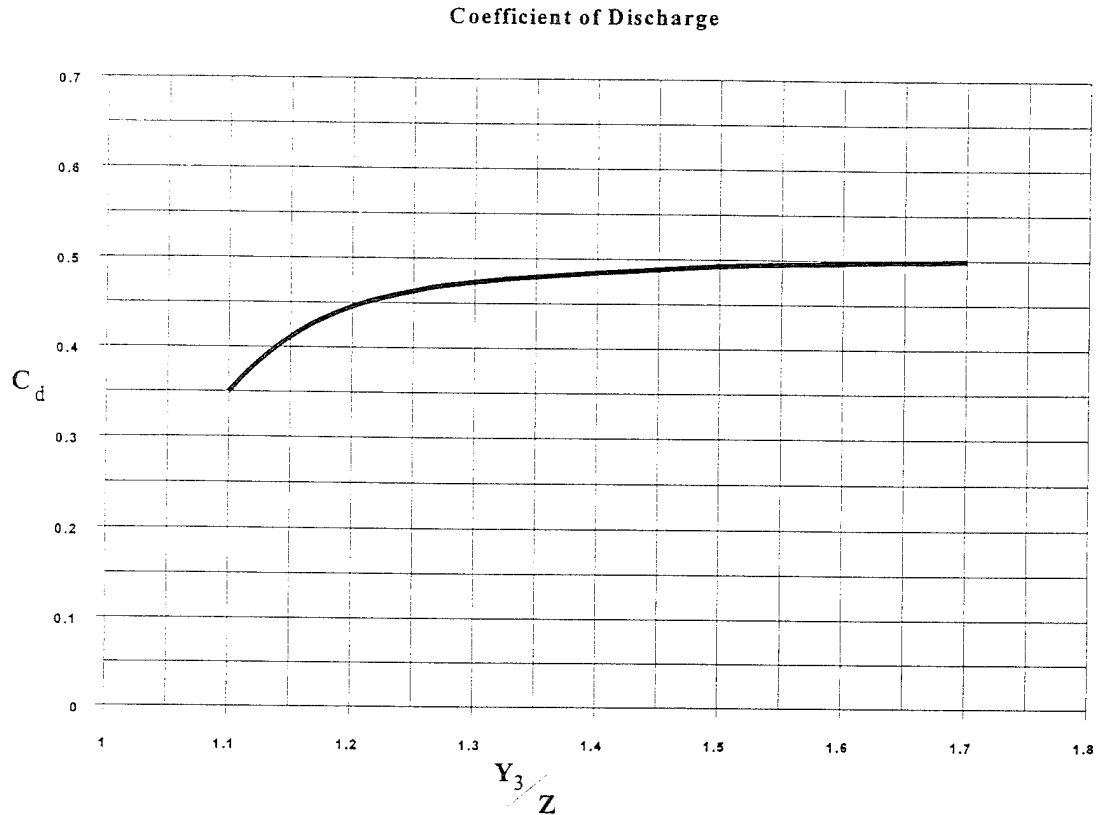

Figure 5.5 Coefficient of discharge for sluice gate type flow

As shown in Figure 5.5, the limiting value of Y_3/Z is 1.1. There is a transition zone somewhere between $Y_3/Z = 1.0$ and 1.1 where free surface flow changes to orifice flow. The type of flow in this range is unpredictable, and equation 5-5 is not applicable.

In the second case, when both the upstream and downstream side of the bridge are submerged, the standard full flowing orifice equation is used (see Figure 5.6). This equation is as follows:

$$Q = CA\sqrt{2gH} \quad (5-6)$$

where: C = Coefficient of discharge for fully submerged pressure flow. Typical value of C is 0.8.

H = The difference between the energy gradient elevation upstream and the water surface elevation downstream

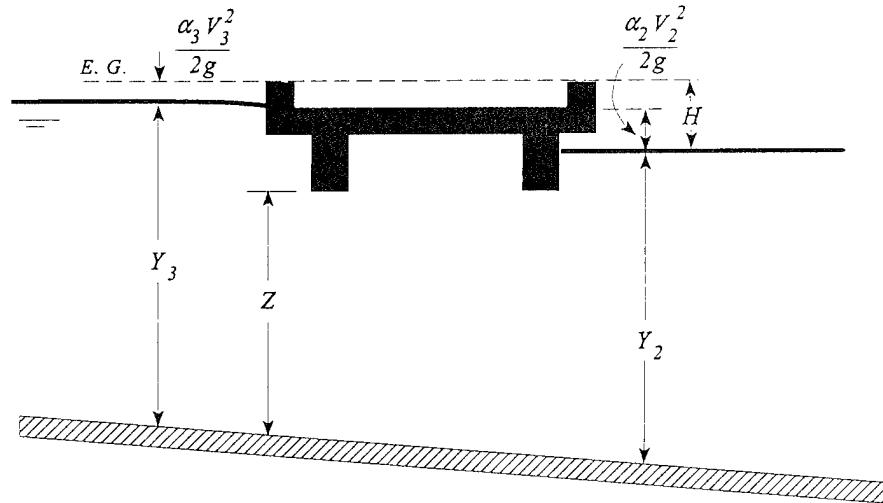

Figure 5.6 Example of a bridge under fully submerged pressure flow

Typical values for the discharge coefficient C range from 0.7 to 0.9, with a value of 0.8 commonly used for most bridges. The user must enter a value for C whenever the pressure flow method is selected. The discharge coefficient C can be related to the total loss coefficient, which comes from the form of the orifice equation that is used in the HEC-2 computer program (HEC, 1990):

$$Q = \sqrt{\frac{2gH}{K}} \quad (5-7)$$

where: K = Total loss coefficient

The conversion from K to C is as follows:

$$C = \sqrt{\frac{1}{K}} \quad (5-8)$$

The program will begin checking for the possibility of pressure flow when the computed low flow energy grade line is above the maximum low chord elevation at the upstream side of the bridge. Once pressure flow is computed, the pressure flow answer is compared to the low flow answer, the higher of the two is used. The user has the option to tell the program to use the water surface, instead of energy, to trigger the pressure flow calculation.

Weir Flow Computations. Flow over the bridge, and the roadway approaching the bridge, is calculated using the standard weir equation (see Figure 5.7):

$$Q = CLH^{3/2} \tag{5-9}$$

- where: Q = Total flow over the weir
 C = Coefficient of discharge for weir flow
 L = Effective length of the weir
 H = Difference between energy upstream and road crest

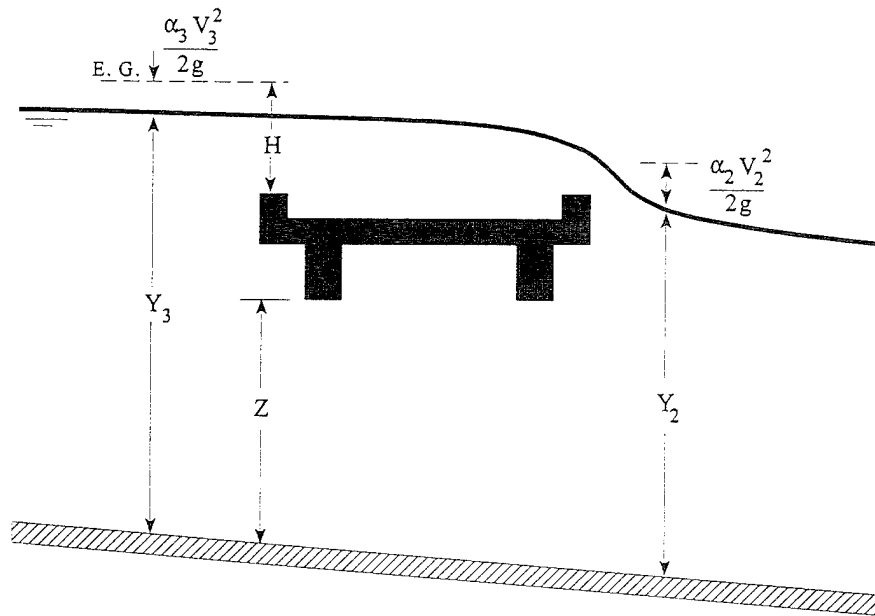

Figure 5.7 Example bridge with pressure and weir flow

The approach velocity is included by using the energy grade line elevation in lieu of the upstream water surface elevation for computing the head, H .

Under free flow conditions (discharge independent of tailwater) the coefficient of discharge C , ranges from 2.5 to 3.1 (1.38 - 1.71 metric) for broad-crested weirs depending primarily upon the gross head on the crest (C increases with head). Increased resistance to flow caused by obstructions such as trash on bridge railings, curbs, and other barriers would decrease the value of C .

Tables of weir coefficients C are given for broad-crested weirs in King's Handbook (King, 1963) with the value of C varying with measured head H and breadth of weir. For rectangular weirs with a breadth of 15 feet and a H of 1 foot or more, the given value is 2.63 (1.45 for metric). Trapezoidal shaped weirs generally have a larger coefficient with typical values ranging from 2.7 to 3.08 (1.49 to 1.70 for metric).

Hydraulics of Bridge Waterways [Bradley, 1978] provides a curve of C versus the head on the roadway. The roadway section is shown as a trapezoid and the coefficient rapidly changes from 2.9 for a very small H to 3.03 for $H = 0.6$ feet. From there, the curve levels off near a value of 3.05 (1.69 for metric)..

With very little prototype data available, it seems the assumption of a rectangular weir for flow over the bridge deck (assuming the bridge can withstand the forces) and a coefficient of 2.6 (1.44 for metric) would be reasonable. If the weir flow is over the roadway approaches to the bridge, a value of 3.0 (1.66 for metric) would be consistent with available data. If weir flow occurs a combination of bridge and roadway, an average coefficient (weighted by weir length) could be used.

For high tailwater elevations, the program will automatically reduce the amount of weir flow to account for submergence on the weir. This is accomplished by reducing the weir coefficient based on the amount of submergence. Submergence corrections are based on a trapezoidal weir shape or optionally an ogee spillway shape. The total weir flow is computed by subdividing the weir crest into segments, computing L , H , a submergence correction, and a Q for each section, then summing the incremental discharges. The submergence correction for a trapezoidal weir shape is from "Hydraulics of Bridge Waterways" [Bradley, 1978]. Figure 5.8 shows the relationship between the percentage of submergence and the flow reduction factor.

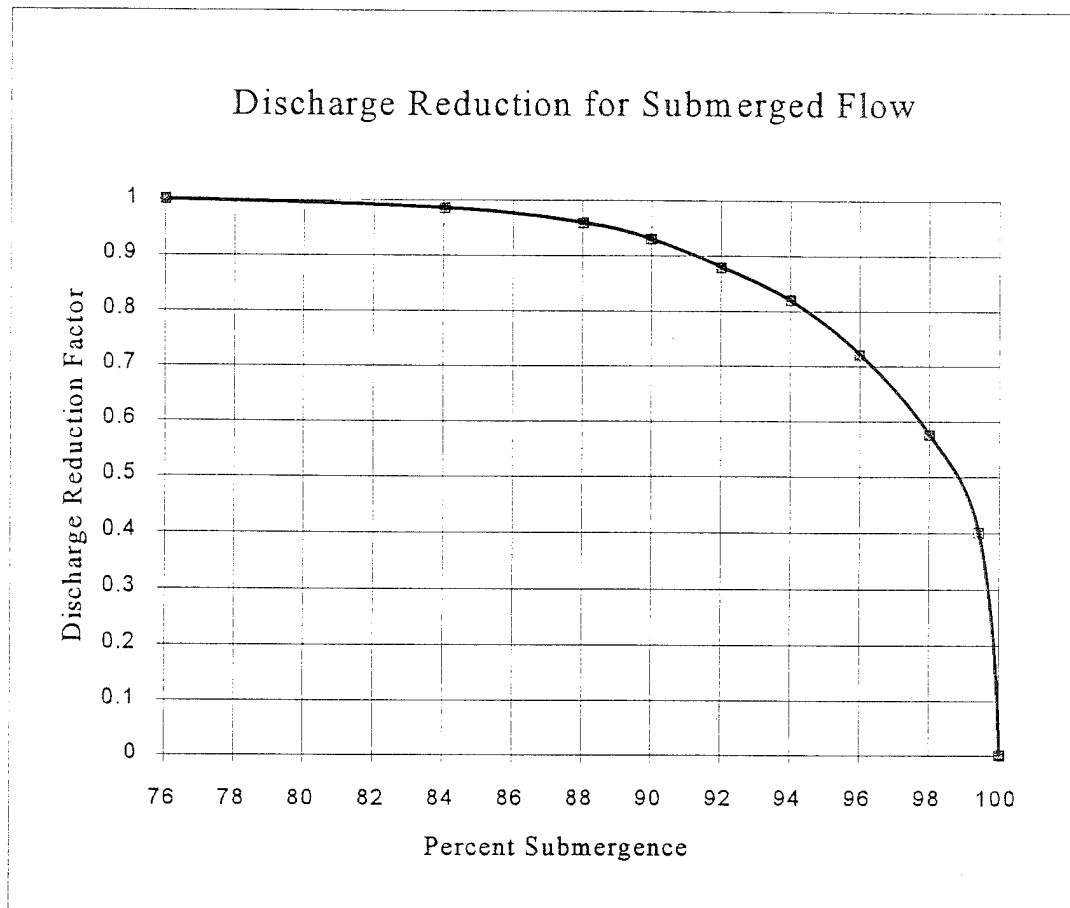

Figure 5.8 Factor for reducing weir flow for submergence

When the weir becomes highly submerged the program will automatically switch to calculating the upstream water surface by the energy equation (standard step backwater) instead of using the pressure and weir flow equations. The criteria for when the program switches to energy based calculations is user controllable. A default maximum submergence is set to 0.95 (95 percent).

Combination Flow.

Sometimes combinations of low flow or pressure flow occur with weir flow. In these cases, an iterative procedure is used to determine the amount of each type of flow. The program continues to iterate until both the low flow method (or pressure flow) and the weir flow method have the same energy (within a specified tolerance) upstream of the bridge (section 3). The combination of low flow and weir flow can be computed with any of the low flow methods mentioned previously, except the momentum based method.

Selecting a Bridge Modeling Approach

There are several choices available to the user when selecting methods for computing the water surface profile through a bridge. For low flow (water surface is below the maximum low chord of the bridge deck), the user can select any or all of the four available methods. For high flows, the user must choose between either the energy based method or the pressure and weir flow approach. Each method should be considered and the following discussion provides some basic guidelines.

Low Flow Methods

For low flow conditions (water surface below the highest point on the low chord of the bridge opening), the Energy and Momentum methods are the most physically based, and in general are applicable to the widest range of bridges and flow situations. Both methods account for friction losses and changes in geometry through the bridge. The energy method accounts for additional losses due to flow transitions and turbulence through the use of contraction and expansion losses. The momentum method can account for additional losses due to pier drag. Both the Yarnell equation and the contracted opening method are empirical formulas. When applying these two methods, the user should ensure that the problem is within the range of data that these methods were developed for. The following examples are some typical cases where the various low flow methods might be used:

1. In cases where the bridge piers are a small obstruction to the flow, and friction losses are the predominate consideration. The energy based method or the momentum method should give the best answers.
2. In cases where pier losses and friction losses are both predominant, the momentum method should be the most applicable. But any of the methods can be used.
3. Whenever the flow passes through critical depth within the vicinity of the bridge, both the momentum and energy methods are capable of modeling this type of flow transition. The Yarnell and Contracted opening methods are for subcritical flow only.
4. For supercritical flow, both the energy and the momentum method can be used. The momentum based method may be better at locations that have a substantial amount of pier impact and drag losses. The Yarnell equation and the Contracted Opening method are only applicable to subcritical flow situations.

5. For bridges in which the piers are the dominant contributor to energy losses and the change in water surface, either the momentum method or the Yarnell equation would be most applicable.
6. For long culverts under low flow conditions, the energy based standard step method is the most suitable approach. Several sections can be taken through the culvert to model changes in grade or shape or to model a very long culvert. This approach also has the benefit of providing detailed answers at several locations within the culvert, which is not possible with the culvert routines in HEC-RAS. However, if the culvert flows full, or if it is controlled by inlet conditions, the culvert routines would be the best approach. For a detailed discussion of the culvert routines within HEC-RAS, see chapter 6 of this manual.

High Flow Methods

For high flows (flows that come into contact with the maximum low chord of the bridge deck), the energy based method is applicable to the widest range of problems. The following examples are some typical cases where the various high flow methods might be used.

1. When the bridge deck is a small obstruction to the flow, and the bridge opening is not acting like an pressurized orifice, the energy based method should be used.
2. When the bridge deck is a large obstruction to the flow, and a backwater is created due to the bridge deck, the pressure and weir method should be used.
3. When the bridge is overtopped, and the water going over top of the bridge is not highly submerged by the downstream tailwater, the pressure and weir method should be used. The pressure and weir method will automatically switch to the energy method if the bridge becomes 95 percent submerged. The user can change the percent submergence at which the program will switch from the pressure and weir method to the energy method. This is accomplished from the Deck/Roadway editor in the Bridge/Culvert Data editor.
4. When the bridge is highly submerged, and flow over the road is not acting like weir flow, the energy based method should be used.

Unique Bridge Problems and Suggested Approaches

Many bridges are more complex than the simple examples presented in the previous sections. The following discussion is intended to show how HEC-RAS can be used to calculate profiles for more complex bridges crossings. The discussion here will be an extension of the previous discussions and will address only those aspects that have not been discussed previously.

Perched Bridges

A perched bridge is one for which the road approaching the bridge is at the floodplain ground level, and only in the immediate area of the bridge does the road rise above ground level to span the watercourse. A typical flood-flow situation with this type of bridge is low flow under the bridge and overbank flow around the bridge. Because the road approaching the bridge is usually not much higher than the surrounding ground, the assumption of weir flow is often not justified. A solution based on the energy method (standard step calculations) would be better than a solution based on weir flow with correction for submergence. Therefore, this type of bridge should generally be modeled using the energy based method, especially when a large percentage of the total discharge is in the overbank areas.

Low Water Bridges

A low water bridge is designed to carry only low flows under the bridge. Flood flows are carried over the bridge and road. When modeling this bridge for flood flows, the anticipated solution is a combination of pressure and weir flow. However, with most of the flow over the top of the bridge, the correction for submergence may introduce considerable error. If the tailwater is going to be high, it may be better to use the energy based method. In fact, if almost all the water is over the top, the bridge may be modeled as a cross section over the top of the bridge, ignoring the flow under the bridge.

Bridges on a Skew

Skewed bridge crossings are generally handled by making adjustments to the bridge dimensions to define an equivalent cross section perpendicular to the flow lines. In the current version of HEC-RAS, it is up to the user to make these adjustments. The cross sections that bound the bridge can be adjusted from the cross section editor. The bridge information (bridge deck/roadway, abutments, and Piers) should be adjusted before you enter the information. In a future version of HEC-RAS, the user will be able to enter a skew angle for

the bridge deck, piers, and abutments from the bridge and culvert editor of the user interface. The program will then multiply the dimensions of the bridge data by the cosine of the skew angle.

In the publication "Hydraulics of Bridge Waterways" [Bradley, 1978] the effect of skew on low flow is discussed. In model testing, skewed crossings with angles up to 20 degrees showed no objectionable flow patterns. For increasing angles, flow efficiency decreased. A graph illustrating the impact of skewness indicates that using the projected length is adequate for angles up to 30 degrees for small flow contractions.

Parallel Bridges

With the construction of divided highways, a common modeling problem involves parallel bridges. For new highways, these bridges are often identical structures. The hydraulic losses through the two structures has been shown to be between one and two times the loss for one bridge [Bradley, 1978]. The model results [Bradley, 1978] indicate the loss for two bridges ranging from 1.3 to 1.55 times the loss for one bridge crossing, over the range of bridge spacings tested. Presumably if the two bridges were far enough apart, the losses for the two bridges would equal twice the loss for one. If the parallel bridges are very close to each other, and the flow will not be able to expand between the bridges, they should be modeled as a single bridge. If there is enough distance between the bridge, in which the flow has room to expand and contract, the bridges should be modeled as two separate bridges. If both bridges are modeled, care should be exercised in depicting the expansion and contraction of flow between the bridges.

Multiple Bridge Opening

Many bridges have more than one opening for flood flow, especially over very wide floodplains. Multiple culverts, bridges with side relief openings, and separate bridges over a divided channel are all examples of multiple opening problems. With more than one bridge opening, and possible different control elevations, the problem can be very complicated. HEC-RAS can handle multiple bridge and/or culvert openings. Detailed discussions on how to model multiple bridge and/or culvert openings is covered under chapter 7 of this document.

CHAPTER 6

Modeling Culverts

HEC-RAS computes energy losses, caused by structures such as culverts, in three parts. The first part consists of losses that occur in the reach immediately downstream from the structure, where an expansion of flow takes place. The second part consists of losses that occur as flow travels into, through, and out of the culvert. The last part consists of losses that occur in the reach immediately upstream from the structure, where the flow is contracting towards the opening of the culvert.

HEC-RAS has the ability to model single culverts; multiple identical culverts; and multiple non-identical culverts.

This chapter discusses how culverts are modeled within HEC-RAS. Discussions include: general modeling guidelines; how the hydraulic computations through the culvert are performed; and what data are required and how to select the various coefficients.

Contents

- General Modeling Guidelines
- Culvert Hydraulics
- Culvert Data and Coefficients

General Modeling Guidelines

The culvert routines in HEC-RAS are similar to the bridge routines, except that the Federal Highway Administration's (FHWA, 1985) standard equations for culvert hydraulics are used to compute inlet control losses at the structure. Figure 6.1 illustrates a typical box culvert road crossing. As shown, the culvert is similar to a bridge in many ways. The walls and roof of the culvert correspond to the abutments and low chord of the bridge, respectively.

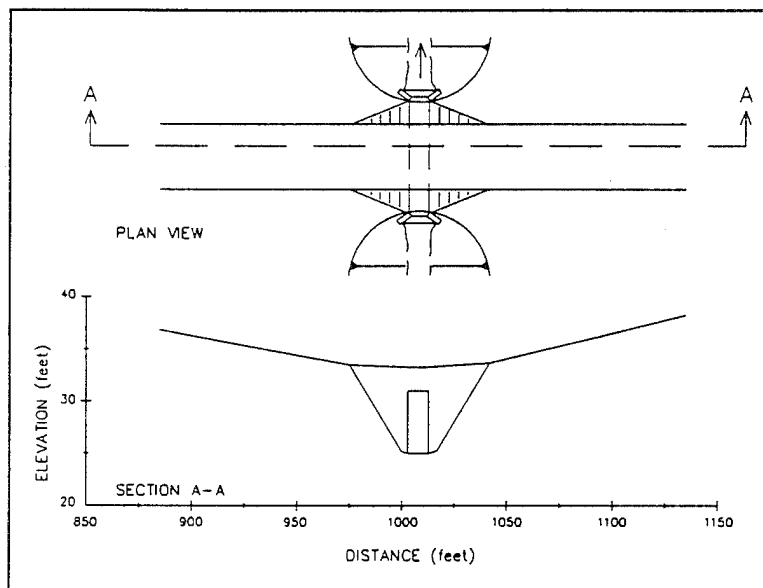

Figure 6.1 Typical Culvert Road Crossing

Because of the similarities between culverts and other types of bridges, culverts are modeled in a similar manner to bridges. The layout of cross sections, the use of the ineffective areas, the selection of loss coefficients, and most other aspects of bridge analysis apply to culverts as well.

Types of Culverts

HEC-RAS has the ability to model six of the most commonly used culvert shapes. These shapes include: circular; box (rectangular); arch; pipe arch; elliptical; and semi-circular culverts (Figure 6.2). The program has the ability to model up to ten different culvert types (any change in shape, slope, roughness, or chart and scale number requires the user to enter a new culvert type) at any given culvert crossing. For a given culvert type, the number of identical barrels is limited to 20.

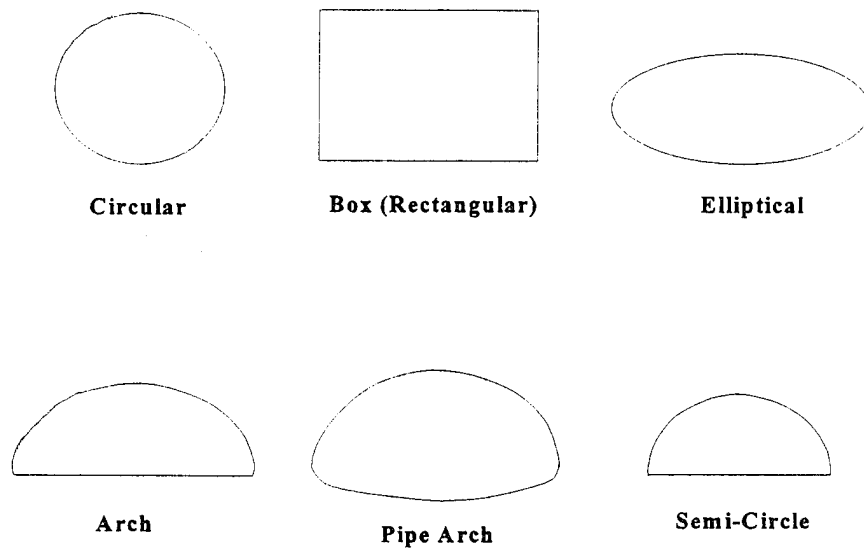

Figure 6.2 Commonly used culvert shapes

Cross Section Locations

The culvert routines in HEC-RAS require the same cross sections as the bridge routines. Four cross sections are required for a complete culvert model. This total includes one cross section sufficiently downstream from the culvert that flow is not affected by the culvert, one at the downstream end of the culvert, one at the upstream end of the culvert, and one cross section located far enough upstream that the culvert again has no effect on flow. Note, the cross sections at the two ends of the culvert represent the channel outside of the culvert. The separate culvert data will be used to create cross sections inside of the culvert. Figure 6.3 illustrates the cross sections required for a culvert model.

Cross Section 1 of Culvert Model. Cross section 1 for a culvert model should be located at a point where flow has fully expanded from its constricted top width caused by the culvert constriction. The cross section spacing downstream of the culvert can be based on the 1:1 or 4:1 criterion stated under the bridge modeling chapter (See chapter 5, "Modeling Bridges" for a more complete discussion of cross section locations). The entire area of cross section 1 is usually considered to be effective in conveying flow.

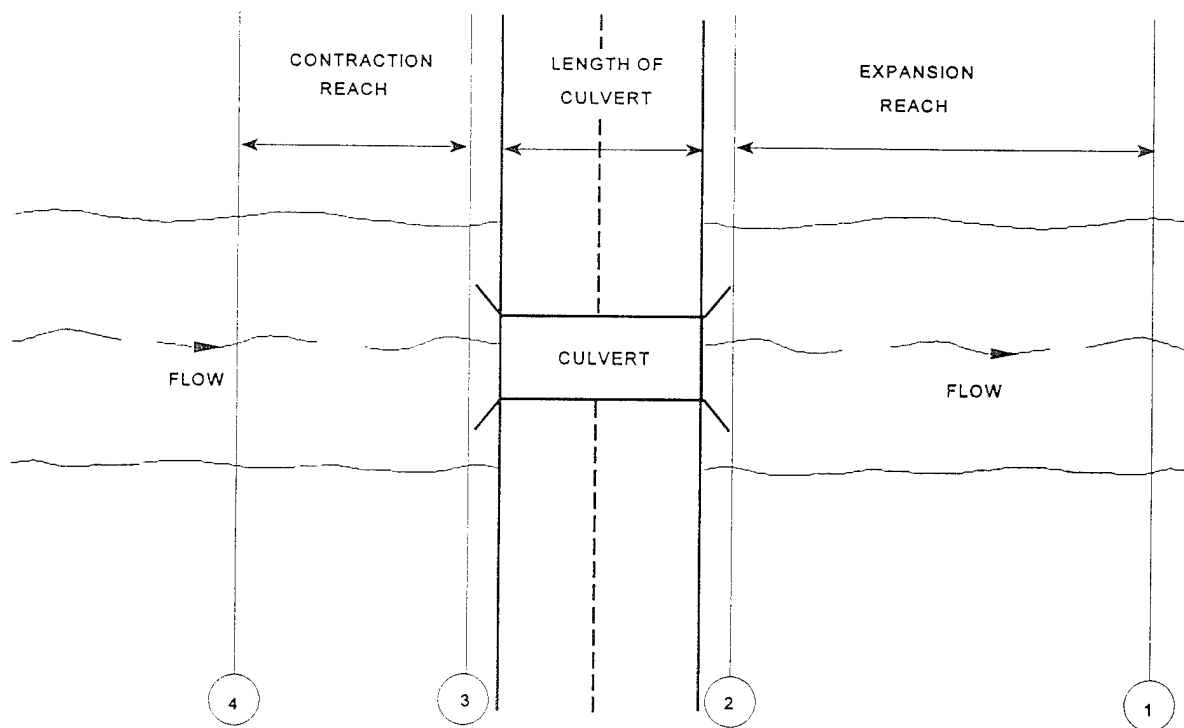

Figure 6.3 Cross Section Layout for Culvert Method

Cross Section 2 of Culvert Model. Cross section 2 of a culvert model is located at the downstream end of the culvert. It does not include any of the culvert structure or embankments, but represents the physical shape of the channel just downstream of the culvert. The shape and location of the culvert is entered separately from the Bridge and Culvert editor in the user interface.

The HEC-RAS ineffective area option is used to restrict the effective flow area of cross section 2 to the flow area around or near the edges of the culverts, until flow overtops the roadway. The ineffective flow areas are used to represent the correct amount of active flow area just downstream of the culvert. Figure 6.4 illustrates cross section 2 of a typical culvert model of a circular culvert. As indicated, the cross section data does not define the culvert shape for the culvert model. On Figure 6.4, the channel bank locations are indicated by small circles and the stations and elevations of the ineffective flow areas are indicated by triangles.

Cross sections 1 and 2 are located so as to create a channel reach downstream of the culvert in which the HEC-RAS program can accurately compute the friction losses and expansion losses downstream of the culvert.

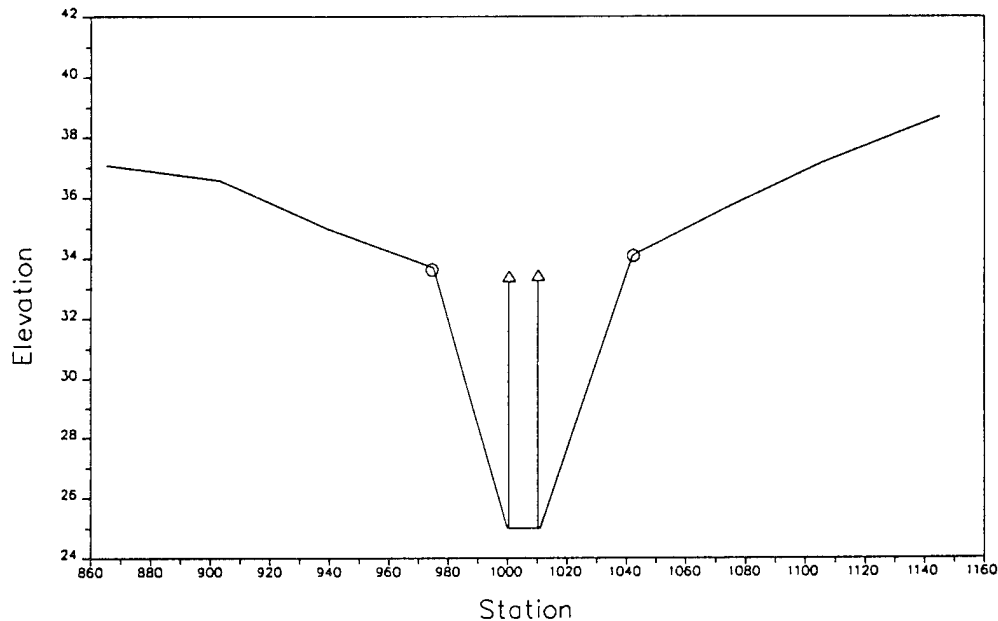

Figure 6.4 Cross Section 2 of Culvert Model

Cross Section 3 of Culvert Model. Cross section 3 of a culvert model is located just upstream of the culvert (a short distance), and represents the physical configuration of the channel immediately upstream of the culvert. The culvert method uses a combination of a bridge deck, cross sections 2 and 3, and culvert data, to describe the culvert or culverts and the roadway embankment. The culvert data describing the culvert crossing is located at a river station between cross section 2 and cross section 3.

The HEC-RAS ineffective area option is used to restrict the effective flow area of cross section 3 to the flow area around or near the edges of the culverts, until flow overtops the roadway. Figure 6.5 illustrates cross section 3 of a typical culvert model of a circular culvert, including the roadway profile defined by the bridge deck, and the culvert shape defined in the bridge and culvert editor. As indicated, the ground profile does not define the culvert shape for the culvert model. On Figure 6.5, the channel bank locations are indicated by small circles and the stations and elevations of ineffective area control are indicated by triangles.

Cross Section 4 of Culvert Model. The final cross section in the culvert model is located at a point where flow has not yet begun to contract from its unrestrained top width upstream of the culvert to its constricted top width near the culvert. This distance is normally determined assuming a one to one contraction of flow.

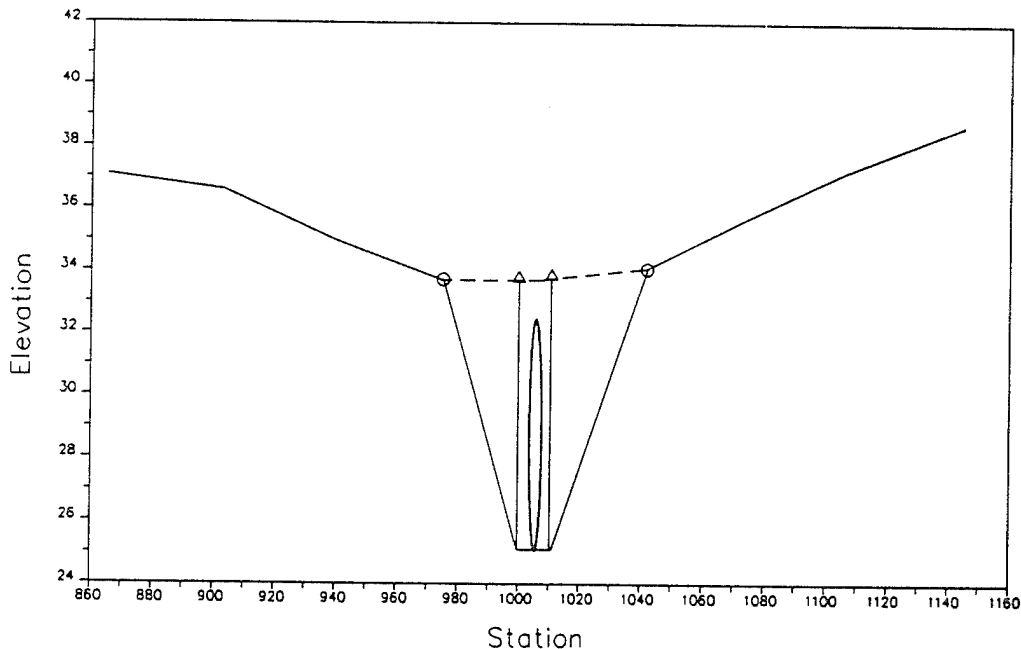

Figure 6.5 Cross Section 3 of the Culvert Model

In other words, the average rate at which flow can contract to pass through the culvert opening is assumed to be one foot laterally for every one foot traveled in the downstream direction. The entire area of cross section 4 is usually considered to be effective in conveying flow.

Expansion and Contraction Coefficients

User-defined coefficients are required to compute head losses due to the contraction and expansion of flows upstream and downstream of a culvert. These losses are computed by multiplying an expansion or contraction coefficient by the absolute difference in velocity head between two cross sections.

If the velocity head increases in the downstream direction, a contraction coefficient is applied. When the velocity head decreases in the downstream direction, an expansion coefficient is used. Recommended values for the expansion and contraction coefficients have been given in Chapter 3 of this manual (table 3.2). As indicated by the tabulated values, the expansion of flow causes more energy loss than the contraction. Also, energy losses increase with the abruptness of the transition. For culverts with abrupt flow transitions, the contraction and expansion loss coefficients should be increased to account for additional energy losses.

Limitations of the Culvert Routines in HEC-RAS

The HEC-RAS culvert routines are subject to the following limitations:

1. **Constant Cross Section:** The culvert shape, flow rate, bottom slope, and roughness are assumed to be constant throughout the length of each culvert.
2. **Positive or Horizontal Culvert Slope:** The culvert bottom slope is required to be positive or zero. That is, the upstream invert elevation of the culvert must be equal to or greater than the downstream invert elevation.
3. **No Supercritical Profiles Through the Culvert:** The current version of HEC-RAS does not have the ability to compute a supercritical water surface profile through a culvert. If the user requests a supercritical profile computation for a data set that has culverts, the program calculates the correct supercritical water surface upstream of the culvert, then skips the culvert calculation and sets a critical depth boundary condition at the downstream end of the culvert. Supercritical flow computations are then continued downstream of the culvert. The same procedure is used for a mixed flow regime profile, if it is found that supercritical flow will continue through the culvert. It is very rare to have supercritical flow continue through a culvert in a supercritical or mixed flow regime profile. However, if this should occur, the culvert crossing should be converted to a bridge model. The bridge routines can easily model a supercritical profile through the structure with either the energy or momentum based computational methods.

Culvert Hydraulics

This section introduces the basic concepts of culvert hydraulics which are used in the HEC-RAS culvert routines.

Introduction to Culvert Terminology

A **culvert** is a relatively short length of closed conduit which connects two open channel segments or bodies of water. Two of the most common types of culverts are: **circular pipe culverts**, which are circular in cross section, and **box culverts**, which are rectangular in cross section. Figure 6.6 shows an illustration of circular pipe and box culverts. In addition to box and pipe culverts, HEC-RAS has the ability to model arch; pipe arch; elliptical; and semi-circular culvert shapes.

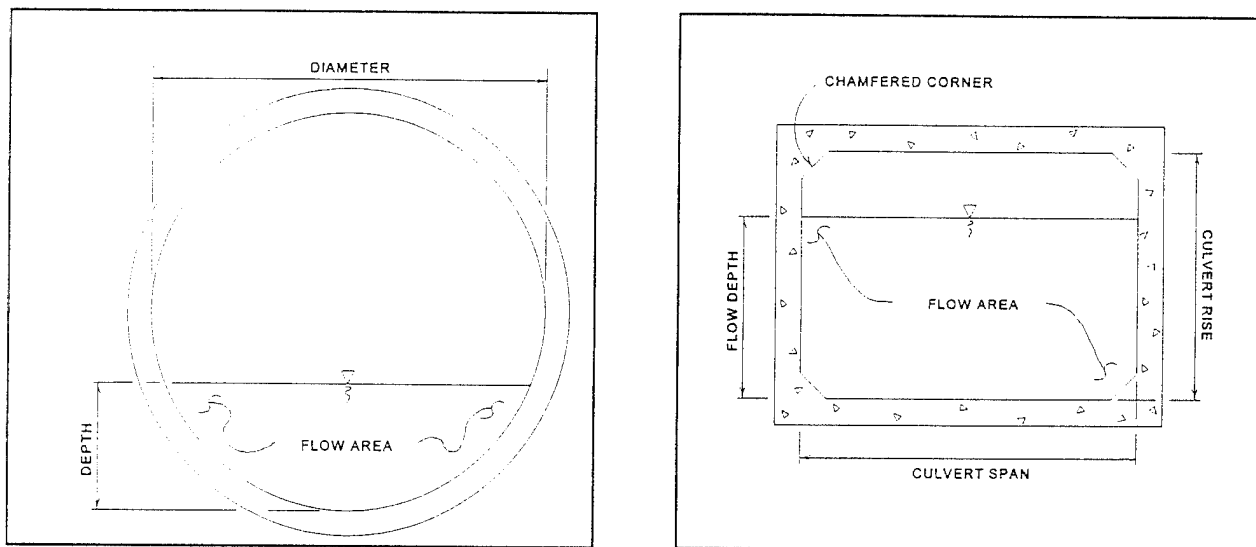

Figure 6.6 Cross section of a circular pipe and box culvert, respectively

Culverts are made up of an **entrance** where water flows into the culvert, a **barrel**, which is the closed conduit portion of the culvert, and an **exit**, where the water flows out of the culvert (see Figure 6.7). The total flow capacity of a culvert depends upon the characteristics of the entrance as well as the culvert barrel and exit.

The **Tailwater** at a culvert is the depth of water on the exit or downstream side of the culvert, as measured from the downstream invert of the culvert. The **invert** is the lowest point on the inside of the culvert at a particular cross section. The tailwater depth depends on the flow rate and hydraulic conditions downstream of the culvert.

The **Headwater** at a culvert is the depth of water on the entrance or upstream side of the culvert, as measured from the upstream invert of the culvert.

The **Specific Energy** at the upstream end of a culvert is equal to the headwater depth plus the upstream velocity head. Likewise, the specific energy at the downstream side of the culvert is equal to the tailwater depth plus the downstream velocity head.

The **Total Energy** at any location is equal to the elevation of the invert plus the specific energy (depth of water + velocity head) at that location. All of the culvert computations within HEC-RAS compute the total energy for the upstream end of the culvert. The upstream water surface (Headwater) is then obtained by placing that energy into the upstream cross section and computing the water surface that corresponds to that energy for the given flow rate.

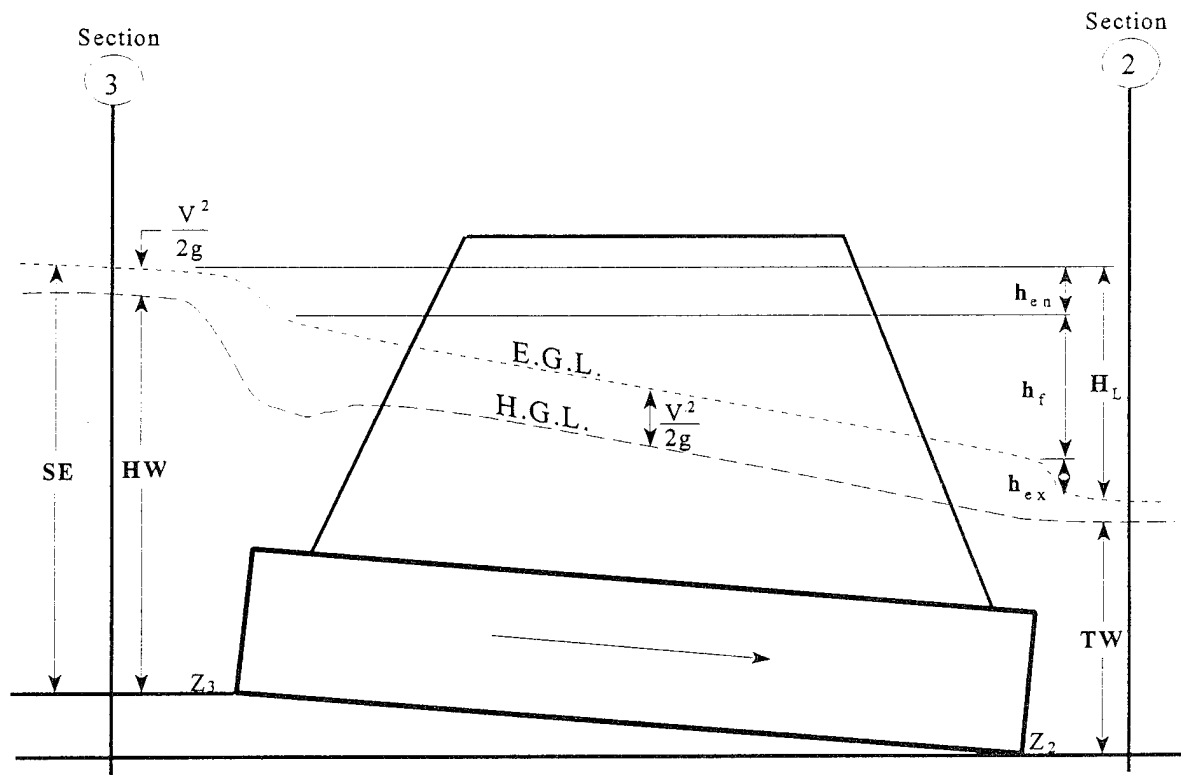

Figure 6.7 Full flowing culvert with energy and hydraulic grade lines

Flow Analysis for Culverts

The analysis of flow in culverts is quite complicated. It is common to use the concepts of "inlet control" and "outlet control" to simplify the analysis. **Inlet control** flow occurs when the flow capacity of the culvert entrance is less than the flow capacity of the culvert barrel. The control section of a culvert operating under inlet control is located just inside the entrance of the culvert. The water surface passes through critical depth at or near this location, and the flow regime immediately downstream is supercritical. **Outlet control** flow occurs when the culvert flow capacity is limited by downstream conditions (high tailwater) or by the flow carrying capacity of the culvert barrel. The HEC-RAS culvert routines compute the upstream energy required to produce a given flow rate through the culvert for inlet control conditions and for outlet control conditions. The higher upstream energy "controls" and determines the type of flow in the culvert for a given flow rate and tailwater condition.

For inlet control, the required upstream energy is computed by assuming that the culvert inlet acts as an orifice or as a weir. Therefore, the inlet control capacity depends primarily on the geometry of the culvert entrance.

For outlet control, the required upstream energy is computed by performing an energy balance from the downstream section to the upstream section. The HEC-RAS culvert routines considers the entrance losses, the friction loss in the culvert barrel, and the exit loss at the outlet in computing the outlet control headwater of the culvert.

Computing Inlet Control Headwater

For inlet control conditions, the capacity of the culvert is limited by the capacity of the culvert opening, rather than by conditions farther downstream. Extensive laboratory tests by the National Bureau of Standards, the Bureau of Public Roads, and other entities resulted in a series of equations which describe the inlet control headwater under various conditions. These equations form the basis of the FHWA inlet control nomographs shown in the "Hydraulic Design of Highway Culverts" publication [FHWA, 1985].

The FHWA inlet control equations are used by the HEC-RAS culvert routines in computing the upstream energy.

The nomographs in the FHWA report are considered to be accurate to within about 10 percent in determining the required inlet control headwater [FHWA, 1985]. The nomographs were computed assuming a culvert slope of 0.02 feet per foot (2 percent). For different culvert slopes, the nomographs are less accurate because inlet control headwater changes with slope. However, the culvert routines in HEC-RAS considers the slope in computing the inlet control energy. Therefore, the culvert routines in HEC-RAS should be more accurate than the nomographs, especially for slopes other than 0.02 feet per foot.

Computing Outlet Control Headwater

For outlet control flow, the required upstream energy to pass the given flow must be computed considering several conditions within the culvert and downstream of the culvert. Figure 6.8 illustrates the logic of the outlet control computations:

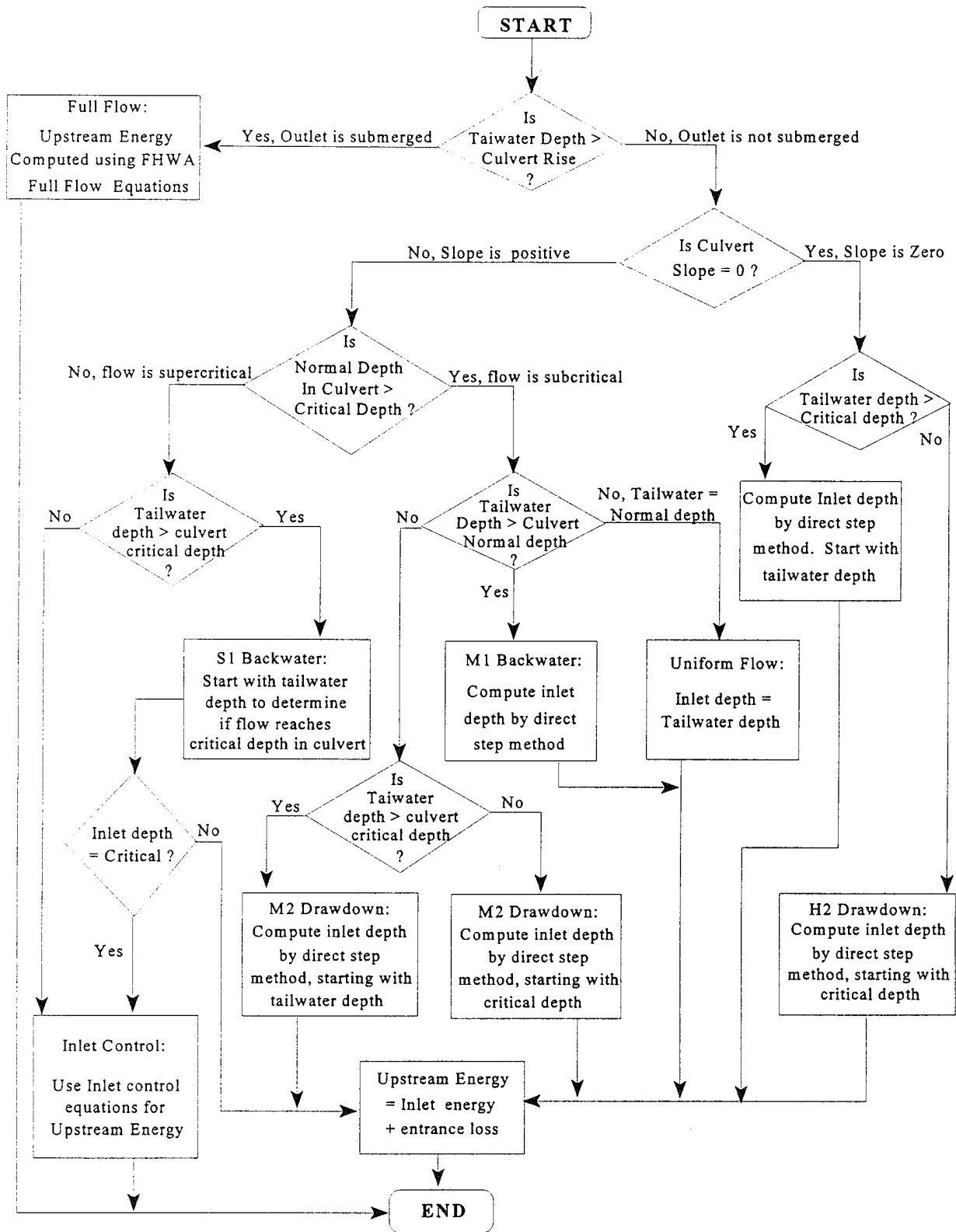

Figure 6.8 Flow Chart for Outlet Control Computations

FHWA Full Flow Equations

For culverts flowing full, the total **head loss**, or energy loss, through the culvert is measured in feet (or meters). The head loss, H_L , is computed using the following formula:

$$H_L = h_{en} + h_f + h_{ex} \quad (6-1)$$

where: h_{en} = entrance loss (feet or meters)

h_f = friction loss (feet or meters)

h_{ex} = exit loss (feet or meters)

The friction loss in the culvert is computed using Manning's formula, which is expressed as follows:

$$h_f = L \left(\frac{Qn}{1.486AR^{2/3}} \right)^2 \quad (6-2)$$

where: h_f = friction Loss (feet)

L = culvert length (feet)

Q = flow rate in the culvert (cfs)

n = Manning's roughness coefficient

A = area of flow (square feet)

R = hydraulic radius (feet)

The entrance energy losses is computed as a coefficient times the velocity head inside the culvert at the upstream end. The exit energy loss is computed as a coefficient times the change in velocity head from just inside the culvert, at the downstream end, to outside of the culvert, at the downstream end. The exit and entrance loss coefficients are described in the next section of this chapter.

Direct Step Water Surface Profile Computations

For culverts flowing partially full, the water surface profile in the culvert is computed using the direct step method. This method is very efficient, because no iterations are required to determine the flow depth for each step. The water surface profile is computed for small increments of depth (usually between 0.01 and 0.05 feet). If the flow depth equals the height of the culvert before the profile reaches the upstream end of the culvert, the friction loss through the remainder of the culvert is computed assuming full flow.

The first step in the direct step method is to compute the exit loss and establish a starting water surface inside the culvert. If the tailwater depth is below critical depth inside the culvert, then the starting condition inside the culvert is assumed to be critical depth. If the tailwater depth is greater than critical depth in the culvert, then a mini energy balance is performed from the downstream cross section to inside of the culvert. This energy balance evaluates the change in energy by the following equation.

$$Z_c + Y_c + \frac{V_c^2}{2g} = Z_2 + Y_2 + \frac{V_2^2}{2g} + h_{ex} \quad (6-3)$$

where: Z_c	=	Elevation of the culvert invert at the downstream end
Y_c	=	Depth of flow inside culvert at downstream end
V_c	=	Velocity inside culvert at downstream end
Z_2	=	Invert elevation of the cross section downstream of culvert (cross section 2 from figure 6.7)
Y_2	=	Depth of water at cross section 2
V_2	=	Average velocity of flow at section 2

Once a water surface is computed inside the culvert at the downstream end, the next step is to perform the direct step backwater calculations through the culvert. The direct step backwater calculations will continue until a water surface and energy are obtained inside the culvert at the upstream end. The final step is to add an entrance loss to the computed energy to obtain the upstream energy outside of the culvert at section 3 (Figure 6.7). The water surface outside the culvert is then obtained by computing the water surface at section 3 that corresponds to the calculated energy for the given flow rate.

Normal Depth of Flow in the Culvert

Normal depth is the depth at which uniform flow will occur in an open channel. In other words, for a uniform channel of infinite length, carrying a constant flow rate, flow in the channel would be at a constant depth at all points along the channel, and this would be the normal depth.

Normal depth often represents a good approximation of the actual depth of flow within a channel segment. For inlet control conditions, the depth of flow within the culvert is assumed to be equal to normal depth. This assumption is only valid if the culvert barrel is sufficiently long to allow the flow depth to stabilize at normal depth.

The program computes normal depth using an iterative approach to arrive at a value which satisfies Manning's equation:

$$Q = \frac{1.486}{n} AR^{2/3} S^{1/2} \quad (6-4)$$

where: Q	=	flow rate in the channel (cfs)
n	=	Manning's roughness coefficient
A	=	area of flow (square feet)
R	=	hydraulic radius (feet)
S	=	slope of energy grade line (feet per foot)

If the normal depth is greater than the culvert rise (from invert to top of the culvert), the program sets the normal depth equal to the culvert rise.

Critical Depth of Flow in the Culvert

Critical depth occurs when the flow in a channel has a minimum specific energy. **Specific energy** refers to the sum of the depth of flow and the velocity head. Critical depth depends only on the channel shape and flow rate.

The depth of flow at the culvert outlet is assumed to be equal to critical depth for culverts operating under outlet control with low tailwater. Critical depth may also influence the inlet control headwater for unsubmerged conditions.

The culvert routines compute critical depth in the culvert by an iterative

procedure, which arrives at a value satisfying the following equation:

$$\frac{Q^2}{g} = \frac{A^3}{T} \quad (6-5)$$

where: Q = flow rate in the channel (cfs)
 g = acceleration due to gravity (32.2 ft/sec²)
 A = cross-sectional area of flow (square feet)
 T = top width of flow (feet)

Critical depth for box culverts can be solved directly with the following equation [AISI, 1980]:

$$y_c = \sqrt[3]{\frac{q^2}{g}} \quad (6-6)$$

where: y_c = critical depth (ft)
 q = unit discharge per linear foot of width (cfs/ft)
 g = acceleration due to gravity (32.2 ft/sec²)

Horizontal Culvert Slope

The culvert routines also allow for horizontal culvert slopes. The primary difference is that normal depth is not computed for a horizontal culvert. Outlet control is either computed by the direct step method for an unsubmerged outlet or the full flow equation for a submerged outlet.

Weir Flow

The first solution through the culvert is under the assumption that all of the flow is going through the culvert barrels. Once a final upstream energy is obtained, the program checks to see if the energy elevation is greater than the minimum elevation for weir flow to occur. If the computed energy is less than the minimum elevation for weir flow, then the solution is final. If the computed energy is greater than the minimum elevation for weir flow, the program performs an iterative procedure to determine the amount of flow

over the weir and flow through the culverts. During this iterative procedure, the program recalculates both inlet and outlet control culvert solutions for each estimate of the culvert flow. The higher of the two is always used for the culvert portion of the solution. The program will continue to iterate until it finds a flow split that produces the same upstream energy (within the error tolerance) for both weir and culvert flow.

Supercritical Culvert Flow

The culvert routines allow supercritical flow in the culvert as a temporary condition in an otherwise subcritical stream profile. The simple assumptions shown in Figure 6.8 are used to compute the upstream energy for supercritical culvert flow. If the user is running a supercritical flow profile, the program will not calculate a supercritical water surface profile through the culvert. During a supercritical profile, the culvert is bypassed and the downstream cross section is set to critical depth. The program continues the supercritical profile from the critical depth boundary condition. In general, if you have culvert crossings that will maintain supercritical flow through the culvert, the crossing should be modeled as a bridge. The bridge routines are capable of modeling supercritical flow through the opening by either the energy or momentum based methods. Also, if you have a steep reach with a culvert crossings, it may be better to run the program in a mixed flow regime mode. This will allow the program to evaluate if the culvert crossing will cause a hydraulic jump and backwater to occur due to the constriction.

Culvert Data and Coefficients

This section describes the basic data that are required for each culvert. Discussions include how to estimate the various coefficients that are required in order to perform inlet control, outlet control, and weir flow analyses. The culvert data are entered on the Culvert Data Editor in the user interface. Discussions about the culvert data editor can be found in Chapter 6 of the HEC-RAS User's Manual.

Culvert Shape and Size

The shape of the culvert is defined by picking one of the five available shapes. These shapes include: circular; box (rectangular); arch; pipe arch; elliptical; and semi-circular. The size of the culvert is defined by entering a rise and span. The rise refers to the maximum inside height of the culvert, while the span represents the maximum inside width. Both the circular and semi-circular culverts are defined by entering a diameter.

The inside height (rise) of a culvert opening is important not only in determining the total flow area of the culvert, but also in determining whether the headwater and tailwater elevations are adequate to submerge the inlet or outlet of the culvert.

Most box culverts have **chamfered** corners on the inside, as indicated in Figure 6.1. The chamfers are ignored by the culvert routines in computing the cross-sectional area of the culvert opening. Some manufacturers' literature contains the true cross-sectional area for each size of box culvert, considering the reduction in area caused by the chamfered corners. If you wish to consider the loss in area due to the chamfers, then you should reduce the span of the culvert. You should not reduce the rise of the culvert, because the program uses the culvert rise to determine the submergence of the culvert entrance and outlet.

Culvert Length

The culvert length is measured in feet (or meters) along the center-line of the culvert. The culvert length is used to determine the friction loss in the culvert barrel and the slope of the culvert.

Number of Identical Barrels

The user can specify up to 25 identical barrels. To use the identical barrel option, all of the culverts must be identical; they must have the same cross-sectional shape, upstream and downstream invert elevations, roughness coefficients, and inlet shapes. If more than one barrel is specified, the program automatically divides the flow rate equally among the culvert barrels and then analyzes only a single culvert barrel. The hydraulics of each barrel is assumed to be exactly the same as the one analyzed.

Manning's Roughness Coefficient

The Manning's roughness coefficient must be entered for each culvert type. HEC-RAS uses Manning's equation to compute friction losses in the culvert barrel, as described in the section entitled "Culvert Hydraulics" of this chapter. Suggested values for Manning's n-value are listed in Table 6.1 and Table 6.2, and in many hydraulics reference books. Roughness coefficients should be adjusted according to individual judgment of the culvert condition.

Table 6.1
Manning's 'n' for Closed Conduits Flowing Partly Full

Type of Channel and Description	Minimum	Normal	Maximum
Brass, smooth:	0.009	0.010	0.013
Steel:			
Lockbar and welded	0.010	0.012	0.014
Riveted and spiral	0.013	0.016	0.017
Cast Iron:			
Coated	0.010	0.013	0.014
Uncoated	0.011	0.014	0.016
Wrought Iron:			
Black	0.012	0.014	0.015
Galvanized	0.013	0.016	0.017
Corrugated Metal:			
Subdrain	0.017	0.019	0.021
Storm Drain	0.021	0.024	0.030
Lucite:	0.008	0.009	0.010
Glass:	0.009	0.010	0.013
Cement:			
Neat, surface	0.010	0.011	0.013
Mortar	0.011	0.013	0.015
Concrete:			
Culvert, straight and free of debris	0.010	0.011	0.013
Culvert with bends, connections, and some debris	0.011	0.013	0.014
Finished	0.011	0.012	0.014
Sewer with manholes, inlet, etc., straight	0.013	0.015	0.017
Unfinished, steel form	0.012	0.013	0.014
Unfinished, smooth wood form	0.012	0.014	0.016
Unfinished, rough wood form	0.015	0.017	0.020
Wood:			
Stave	0.010	0.012	0.014
Laminated, treated	0.015	0.017	0.020
Clay:			
Common drainage tile	0.011	0.013	0.017
Vitrified sewer	0.011	0.014	0.017
Vitrified sewer with manholes, inlet, etc.	0.013	0.015	0.017
Vitrified Subdrain with open joint	0.014	0.016	0.018
Brickwork:			
Glazed	0.011	0.013	0.015
Lined with cement mortar	0.012	0.015	0.017
Sanitary sewers coated with sewage slime with bends and connections	0.012	0.013	0.016
Paved invert, sewer, smooth bottom	0.016	0.019	0.020
Rubble masonry, cemented	0.018	0.025	0.030

[Chow, 1959]

Table 6.2
Manning's 'n' for Corrugated Metal Pipe

Type of Pipe and Diameter	Unpaved	25% Paved	Fully Paved
Annular 2.67 x ½ in. (all diameters)	0.024	0.021	0.021
Helical 1.50 x 1/4 in.:			
8 inch diameter	0.012		
10 inch diameter	0.014		
Helical 2.67 x ½ inc.:			
12 inch diameter	0.011		
18 inch diameter	0.014		
24 inch diameter	0.016	0.015	0.012
36 inch diameter	0.019	0.017	0.012
48 inch diameter	0.020	0.020	0.012
60 inch diameter	0.021	0.019	0.012
Annular 3 x 1 in. (all diameters)	0.027	0.023	0.012
Helical 3 x 1 in.:			
48 inch diameter	0.023	0.020	0.012
54 inch diameter	0.023	0.020	0.012
60 inch diameter	0.024	0.021	0.012
66 inch diameter	0.025	0.022	0.012
72 inch diameter	0.026	0.022	0.012
78 inch & larger	0.027	0.023	0.012
Corrugations 6 x 2 in.:			
60 inch diameter	0.033	0.028	
72 inch diameter	0.032	0.027	
120 inch diameter	0.030	0.026	
180 inch diameter	0.028	0.024	

[AISI, 1980]

Entrance Loss Coefficient

Entrance losses are computed as a function of the **velocity head** inside the culvert at the upstream end. The entrance loss for the culvert is computed as:

$$h_{en} = k_{en} \frac{V_{en}^2}{2g} \quad (6-7)$$

where: h_{en} = Energy loss due to the entrance

k_{en} = Entrance loss coefficient

V_{en} = Flow velocity inside the culvert at the entrance

g = Acceleration due to gravity

The velocity head is multiplied by the **entrance loss coefficient** to estimate the amount of energy lost as flow enters the culvert. A higher value for the coefficient gives a higher head loss. Entrance loss coefficients are shown in Tables 6.3 and 6.4. These coefficients were taken from the Federal Highway Administrations "Hydraulic Design of Highway Culverts" manual (FHWA, 1985). Table 6.3 indicates that values of the entrance loss coefficient range from 0.2 to about 0.9 for pipe-arch and pipe culverts. As shown in Table 6.4, entrance losses can vary from about 0.2 to about 0.7 times the velocity head for box culverts. For a sharp-edged culvert entrance with no rounding, 0.5 is recommended. For a well-rounded entrance, 0.2 is appropriate.

Table 6.3
Entrance Loss Coefficient for Pipe Culverts

Type of Structure and Design of Entrance	Coefficient
Concrete Pipe Projecting from Fill (no headwall):	
Socket end of pipe	0.20
Square cut end of pipe	0.50
Concrete Pipe with Headwall or Headwall and Wingwalls:	
Socket end of pipe (grooved end)	0.20
Square cut end of pipe	0.50
Rounded entrance, with rounding radius = 1/12 of diameter	0.20
Concrete Pipe:	
Mitered to conform to fill slope	0.7
End section conformed to fill slope	0.5
Beveled edges, 33.7 or 45 degree bevels	0.2
Side slope tapered inlet	0.2
Corrugated Metal Pipe or Pipe-Arch:	
Projected from fill (no headwall)	0.9
Headwall or headwall and wingwalls square edge	0.5
Mitered to conform to fill slope	0.7
End section conformed to fill slope	0.5
Beveled edges, 33.7 or 45 degree bevels	0.2
Side slope tapered inlet	0.2

Table 6.4
Entrance Loss Coefficient for Reinforced Concrete Box Culverts

Type of Structure and Design of Entrance	Coefficient
Headwall Parallel to Embankment (no wingwalls):	
Square-edged on three edges	0.50
Three edges rounded to radius of 1/12 barrel dimension	0.20
Wingwalls at 30 to 75 degrees to Barrel:	
Square-edge at crown	0.40
Top corner rounded to radius of 1/12 barrel dimension	0.20
Wingwalls at 10 to 25 degrees to Barrel:	
Square-edge at crown	0.5
Wingwalls parallel (extension of sides):	
Square-edge at crown	0.7
Side or slope tapered inlet	0.2

Exit Loss Coefficient

Exit losses are computed as a coefficient times the change in velocity head from just inside the culvert, at the downstream end, to the cross section just downstream of the culvert. The equation for computing exit losses is as follows:

$$h_{ex} = k_{ex} \left(\frac{V_{ex}^2}{2g} - \frac{V_2^2}{2g} \right) \quad (6-8)$$

where: h_{ex} = Energy loss due to exit

k_{ex} = Exit loss coefficient

V_{ex} = Velocity inside of culvert at exit

V_2 = Velocity outside of culvert at downstream cross section

For a sudden expansion of flow, such as in a typical culvert, the exit loss coefficient (k_{ex}) is normally set to 1.0 (FHWA, 1985). In general, exit loss coefficients can vary between 0.3 and 1.0. The exit loss coefficient should be reduced as the transition becomes less abrupt.

FHWA Chart and Scale Numbers

The FHWA chart and scale numbers are required input data. The FHWA chart number and scale number refer to a series of nomographs published by the Bureau of Public Roads (now called the Federal Highway Administration) in 1965 [BPR, 1965], which allowed the inlet control headwater to be computed for different types of culverts operating under a wide range of flow conditions. These nomographs and others constructed using the original methods were republished [FHWA, 1985]. The tables in this chapter are copies of the information from the 1985 FHWA publication.

Each of the FHWA charts has from two to four separate scales representing different culvert entrance designs. The appropriate FHWA chart number and scale number should be chosen according to the type of culvert and culvert entrance. Tables 6.5 may be used for guidance in selecting the FHWA chart number and scale number.

Chart numbers 1, 2, and 3 apply only to pipe culverts. Similarly, chart number 8, 9, 10, 11, 12, and 13 apply only to box culverts. The HEC-RAS program checks the chart number to assure that it is appropriate for the type of culvert being analyzed. HEC-RAS also checks the value of the Scale Number to assure that it is available for the given chart number. For example, a scale number of 4 would be available for chart 11, but not for chart 12.

Figures 6.9 through 6.18 can be used as guidance in determining which chart and scale numbers to select for various types of culvert inlets.

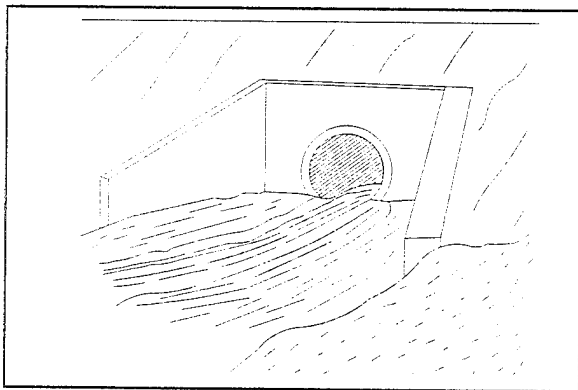

Figure 6.9
Culvert Inlet with Headwall and Wingwalls

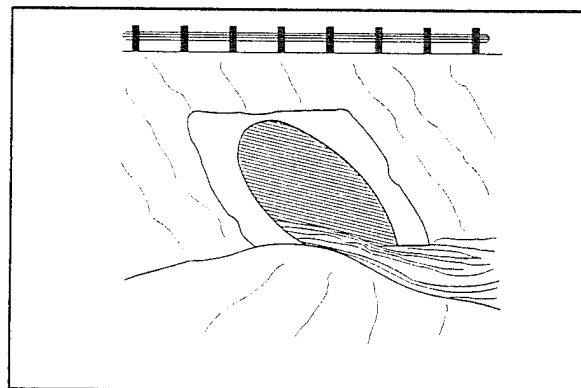

Figure 6.10
Culvert Inlet Mitered to Conform to Slope

Table 6.5
FHWA Chart and Scale Numbers for Culverts

Chart Number	Scale Number	Description
1		Concrete Pipe Culvert
	1	Square edge entrance with headwall (See Figure 6.9)
	2	Groove end entrance with headwall (See Figure 6.9)
2	3	Groove end entrance, pipe projecting from fill (See Figure 6.11)
		Corrugated Metal Pipe Culvert
	1	Headwall (See Figure 6.9)
3	2	Mitered to conform to slope (See Figure 6.10)
	3	Pipe projecting from fill (See Figure 6.11)
		Concrete Pipe Culvert; Beveled Ring Entrance (See Figure 6.12)
8	1(A)	Small bevel: $b/D = 0.042$; $a/D = 0.063$; $c/D = 0.042$; $d/D = 0.083$
	2(B)	Large bevel; $b/D = 0.083$; $a/D = 0.125$; $c/D = 0.042$; $d/D = 0.125$
9		Box Culvert with Flared Wingwalls (See Figure 6.13)
	1	Wingwalls flared 30 to 75 degrees
	2	Wingwalls flared 90 or 15 degrees
10	3	Wingwalls flared 0 degrees (sides extended straight)
		Box Culvert with Flared Wingwalls and Inlet Top Edge Bevel (See Figure 6.14)
	1	Wingwall flared 45 degrees; inlet top edge bevel = $0.43D$
11	2	Wingwall flared 18 to 33.7 degrees; inlet top edge bevel = $0.083D$
		Box Culvert; 90-degree Headwall; Chamfered or Beveled Inlet Edges (See Figure 6.15)
	1	Inlet edges chamfered 3/4-inch
12	2	Inlet edges beveled 1/2-in/ft at 45 degrees (1:1)
	3	Inlet edges beveled 1-in/ft at 33.7 degrees (1:1.5)
		Box Culvert; Skewed Headwall; Chamfered or Beveled Inlet Edges (See Figure 6.16)
13	1	Headwall skewed 45 degrees; inlet edges chamfered 3/4-inch
	2	Headwall skewed 30 degrees; inlet edges chamfered 3/4-inch
	3	Headwall skewed 15 degrees; inlet edges chamfered 3/4-inch
	4	Headwall skewed 10 to 45 degrees; inlet edges beveled
16-19		Box Culvert; Non-Offset Flared Wingwalls; 3/4-inch Chamfer at Top of Inlet (See Figure 6.17)
	1	Wingwalls flared 45 degrees (1:1); inlet not skewed
	2	Wingwalls flared 18.4 degrees (3:1); inlet not skewed
29	3	Wingwalls flared 18.4 degrees (3:1); inlet skewed 30 degrees
		Box Culvert; Offset Flared Wingwalls; Beveled Edge at Top of Inlet (See Figure 6.18)
	1	Wingwalls flared 45 degrees (1:1); inlet top edge bevel = $0.042D$
30	2	Wingwalls flared 33.7 degrees (1.5:1); inlet top edge bevel = $0.083D$
	3	Wingwalls flared 18.4 degrees (3:1); inlet top edge bevel = $0.083D$
34		Corrugated Metal Box Culvert
	1	90 degree headwall
	2	Thick wall Projecting
29	3	Thin wall projecting
		Horizontal Ellipse; Concrete
	1	Square edge with headwall
30	2	Grooved end with headwall
	3	Grooved end projecting
		Vertical Ellipse; Concrete
34	1	Square edge with headwall
	2	Grooved end with headwall
	3	Grooved end projecting
34		Pipe Arch; 18" Corner Radius; Corrugated Metal
	1	90 Degree headwall
	2	Mitered to slope
34	3	Projecting

Table 6.5 (Continued)
FHWA Chart and Scale Numbers for Culverts

Chart Number	Scale Number	Description
35	1	Projecting
	2	No bevels
	3	33.7 degree bevels
36	1	Projecting
	2	No bevels
	3	33.7 degree bevels
41-43	1	90 degree headwall
	2	Mitered to slope
	3	Thin wall projecting
55	1	Smooth tapered inlet throat
	2	Rough tapered inlet throat
56	1	Tapered inlet; Beveled edges
	2	Tapered inlet; Square edges
	3	Tapered inlet; Thin edge projecting
57	1	Tapered inlet throat
58	1	Side tapered; Less favorable edges
	2	Side tapered; More favorable edges
59	1	Slope tapered; Less favorable edges
	2	Slope tapered; More favorable edges

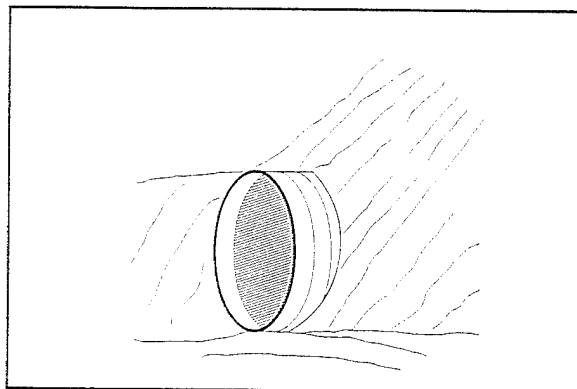

Figure 6.11
Culvert Inlet Projecting from Fill

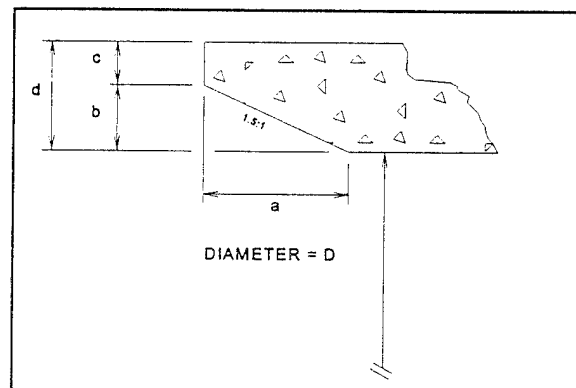

Figure 6.12
Culvert Inlet with Beveled Ring Entrance

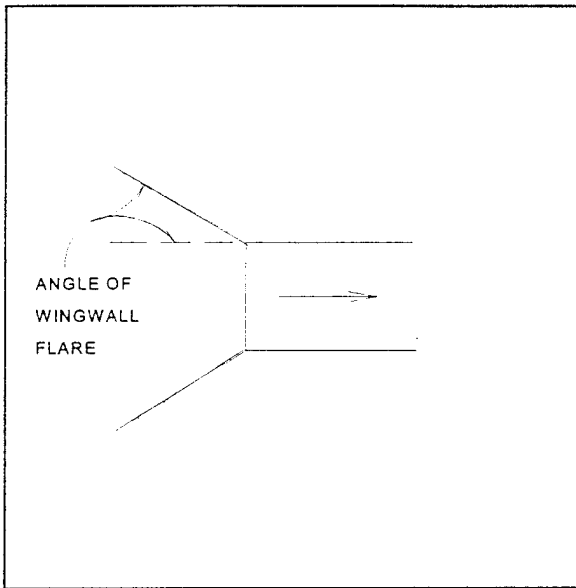

Figure 6.13
Flared Wingwalls (Chart 8)

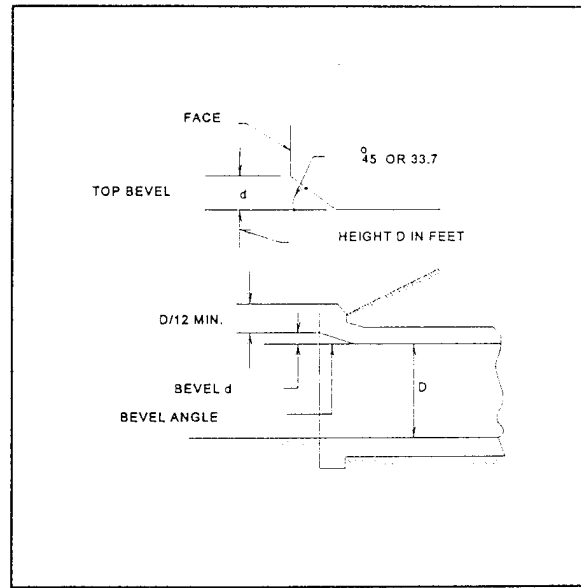

Figure 6.14
Inlet Top Edge Bevel (Chart 9)

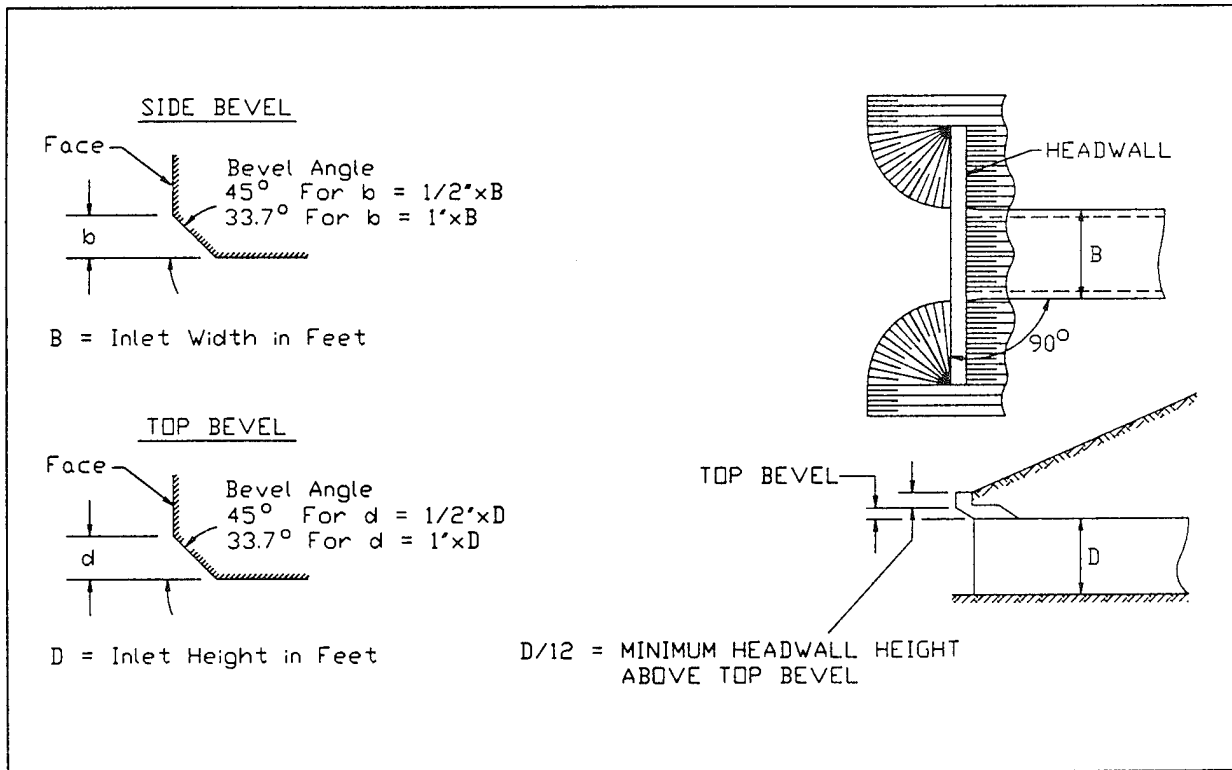

Figure 6.15
Inlet Side and Top Edge Bevel with Ninety Degree Headwall (Chart 10)

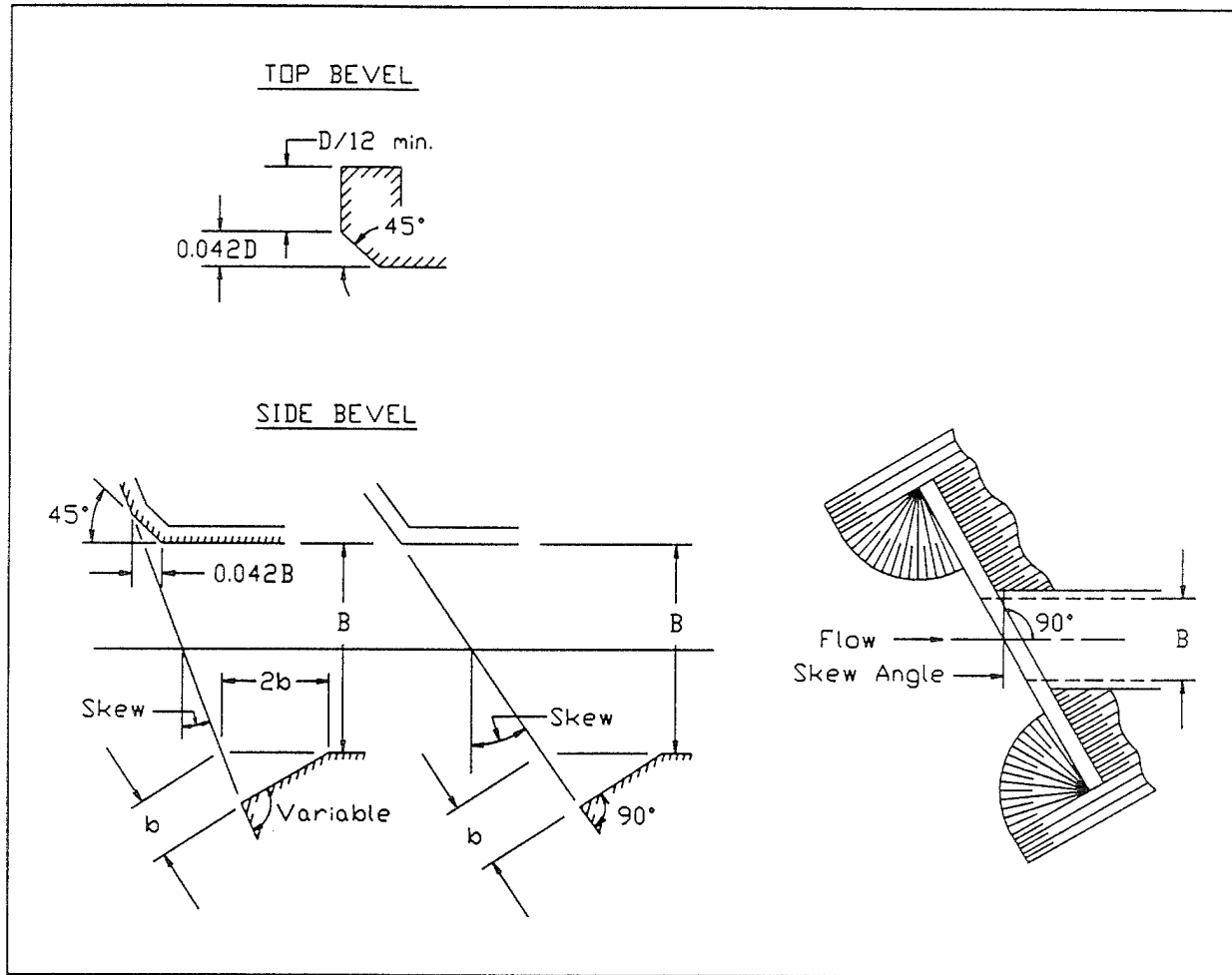

Figure 6.16
Inlet Side and Top Edge Bevel with Skewed Headwall (Chart 11)

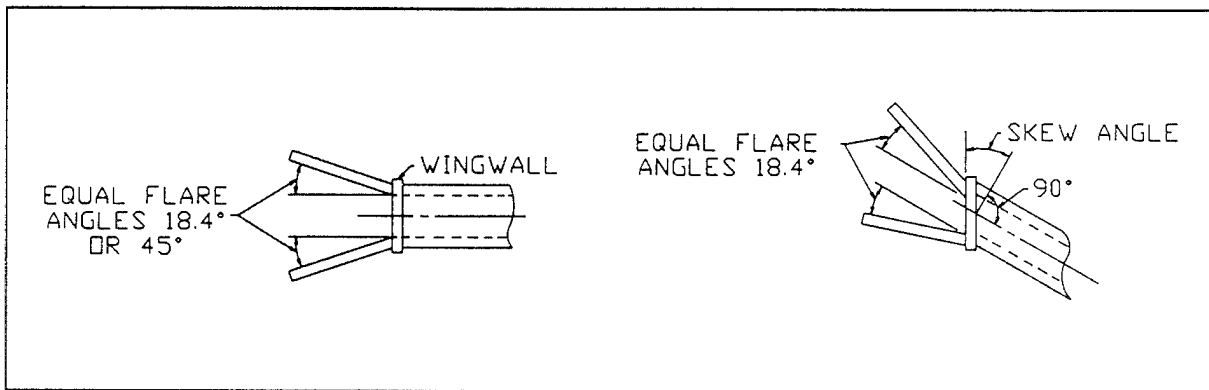

Figure 6.17
Non-Offset Flared Wingwalls (Chart 12)

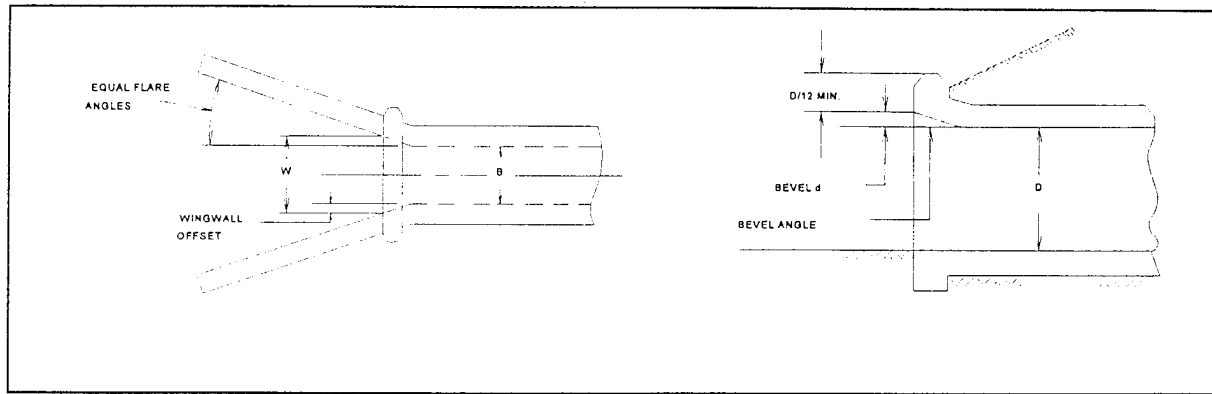

Figure 6.18
Offset Flared Wingwalls (Chart 13)

Culvert Invert Elevations

The culvert flow-line slope is the average drop in elevation per foot of length along the culvert. For example, if the culvert flow-line drops 1 foot in a length of 100 feet, then the culvert flow-line slope is 0.01 feet per foot. Culvert flow-line slopes are sometimes expressed in percent. A slope of 0.01 feet per foot is the same as a one percent slope.

The culvert slope is computed from the upstream invert elevation, the downstream invert elevation, and the culvert length. The following equation is used to compute the culvert slope:

$$S = \frac{ELCHU - ELCHD}{\sqrt{CULVLN^2 - (ELCHU - ELCHD)^2}} \quad (6-9)$$

where: $ELCHU$ = Elevation of the culvert invert upstream

$ELCHD$ = Elevation of the culvert invert downstream

$CULVLN$ = Length of the culvert

As already noted, HEC-RAS cannot analyze culverts with adverse (negative) slopes. Most culverts are installed with some "positive slope"; that is, the invert of the culvert is slightly lower on the downstream end than the upstream end, so that some flow velocity can be maintained in the culvert even under low flow conditions. A sufficient slope to maintain a minimum flow velocity of 3 feet per second is often required in order to prevent sediment accumulation in the culvert.

The slope of the culvert is used by the program to compute the drop in invert between the upstream and downstream ends of the culvert. It is also used to compute the normal depth of flow in the culvert under outlet control conditions.

Weir Flow Coefficient

Weir flow over a roadway is computed in the culvert routines using exactly the same methods used in the HEC-RAS bridge routines. The standard weir equation is used:

$$Q = CLH^{1.5} \quad (6-10)$$

where: Q = flow rate

C = weir flow coefficient

L = weir length

H = weir energy head

For flow over a typical bridge deck, a weir coefficient of 2.6 is recommended. A weir coefficient of 3.0 is recommended for flow over elevated roadway approach embankments. More detailed information on weir discharge coefficients and how weirs are modeled in HEC-RAS may be found in chapter 5 of this manual, "Modeling Bridges". Also, information on how to enter a bridge deck and weir coefficients can be found in chapter 6 of the HEC-RAS user's manual, "Editing and Entering Geometric Data".

CHAPTER 7

Modeling Multiple Bridge and/or Culvert Openings

The HEC-RAS program has the ability to model multiple bridge and/or culvert openings at a single location. A common example of this type of situation is a bridge opening over the main stream and a relief bridge (or group of culverts) in the overbank area. The HEC-RAS program is capable of modeling up to seven openings at any one location.

Contents

- General Modeling Guidelines
- Multiple Opening Approach
- Divided Flow Approach

General Modeling Guidelines

Occasionally you may need to model a river crossing that cannot be modeled adequately as a single bridge opening or culvert group. This often occurs in wide floodplain areas where there is a bridge opening over the main river channel, and a relief bridge or group of culverts in the overbank areas. There are two ways you could model this type of problem within HEC-RAS. The preferred method would be to use the multiple opening capability in HEC-RAS, which is discussed in detail in the following section. A second method would be to model the two openings as divided flow. This method would require the user to define the flow path for each opening as a separate reach. This option is discussed in the last section of this chapter.

Multiple Opening Approach

The multiple opening features in HEC-RAS allow users to model complex bridge and/or culvert crossings within a one dimensional flow framework. HEC-RAS has the ability to model three types of openings: Bridges; Culvert Groups (a group of culverts is considered to be a single opening); and Conveyance Areas (an area where water will flow as open channel flow, other than a bridge or culvert opening). Up to seven openings can be defined at any one river crossing. The HEC-RAS multiple opening methodology is limited to subcritical flow profiles. The program can also be run in mixed flow regime mode, but only a subcritical profile will be calculated in the area of the multiple opening. An example of a multiple opening is shown in Figure 7.

As shown in Figure 7.1, the example river crossing has been defined as three openings, labeled as #1, #2, and #3. Opening #1 represents a Conveyance Area, opening #2 is a Bridge opening, and opening #3 is a Culvert Group.

The approach used in HEC-RAS is to evaluate each opening as a separate entity. An iterative solution is applied, in which an initial flow distribution between openings is assumed. The water surface profile and energy gradient are calculated through each opening. The computed upstream energies for each opening are compared to see if they are within a specified tolerance (the difference between the opening with the highest energy and the opening with the lowest energy must be less than the tolerance). If the difference in energies is not less than the tolerance, the program makes a new estimate of the flow distribution through the openings and repeats the process. This iterative technique continues until either a solution that is within the tolerance is achieved, or a predefined maximum number of iterations is reached (the default maximum is 30).

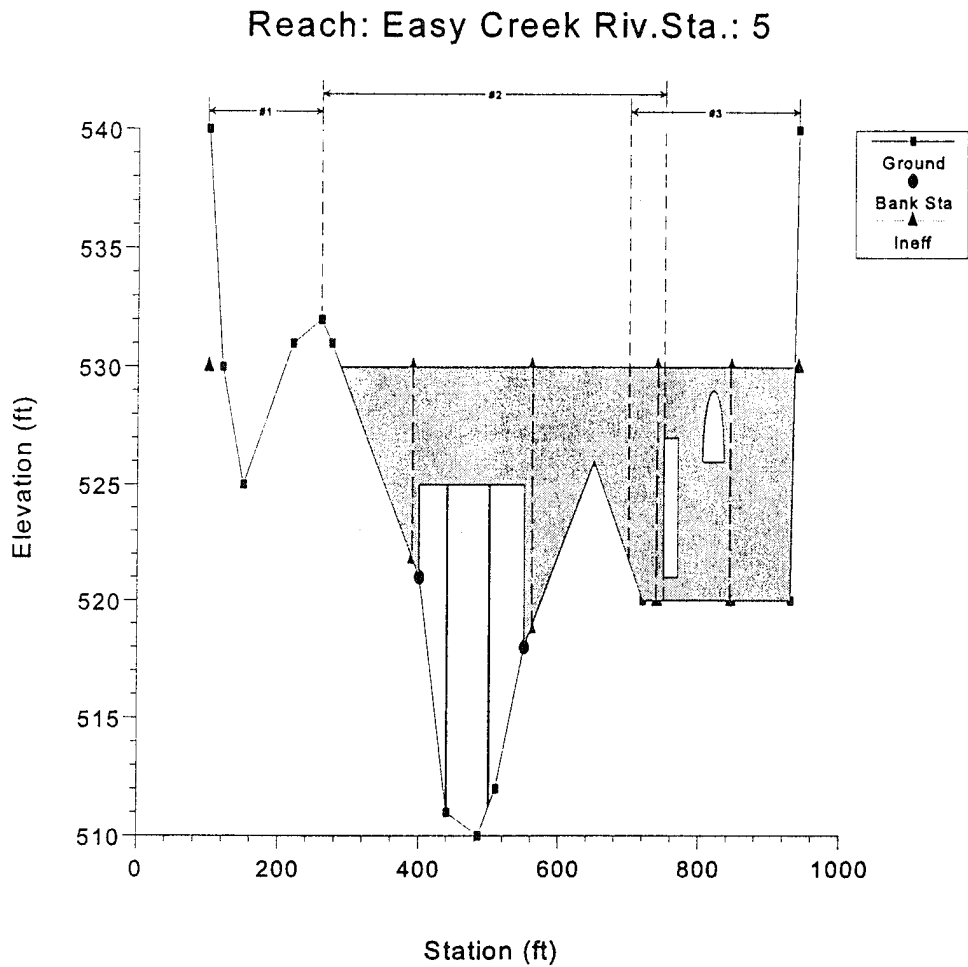

Figure 7.1 Example Multiple Opening River Crossing

The distribution of flow requires the establishment of flow boundaries both upstream and downstream of the openings. The flow boundaries represent the point at which flow separates between openings. These flow boundaries are referred to as "Stagnation Points" (the term "stagnation points" will be used from this point on when referring to the flow separation boundaries). A plan view of a multiple opening is shown in Figure 7.2.

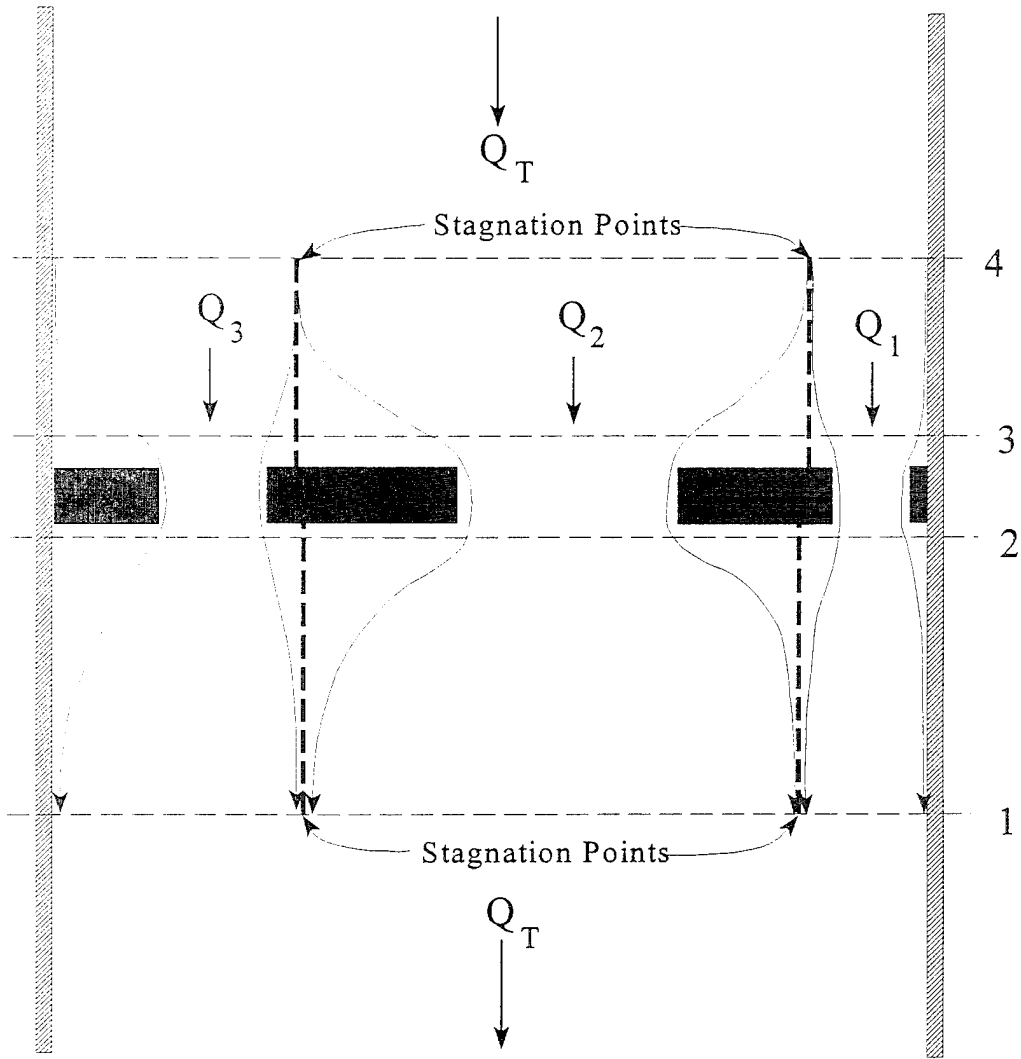

Figure 7.2 Plan view of a Multiple Opening Problem

Locating the Stagnation Points

The user has the option of fixing the stagnation point locations or allowing the program to solve for them within user defined limits. In general, it is better to let the program solve for the stagnation points, because it provides the best flow distribution and computed water surfaces. Also, allowing the stagnation points to migrate can be important when evaluating several different flow profiles in the same model. Conversely though, if the range in which the stagnation points are allowed to migrate is vary large, the program may have difficulties in converging to a solution. Whenever this occurs, the user should either reduce the range that the stagnation points can migrate or fix their location.

Within HEC-RAS, stagnation points are allowed to migrate between any bridge openings and/or culvert groups. However, if the user defines a conveyance area opening, the stagnation point between this type of opening and any other must be a fixed location. Also, conveyance area openings are limited to the left and right ends of the cross section.

Computational Procedure for Multiple Openings

HEC-RAS uses an iterative procedure for solving the multiple opening problem. The following approach is used when performing a multiple opening computation:

1. The program makes a first guess at the upstream water surface by setting it equal to the computed energy on the downstream side of the river crossing.
2. The assumed water surface is projected onto the upstream side of the bridge. A flow distribution is computed based on the percent of flow area in each opening.
3. Once a flow distribution is estimated, the stagnation points are calculated based on the upstream cross section. The assumed water surface is put into the upstream section. The hydraulic properties are calculated based on the assumed water surface and flow distribution. Stagnation points are located by apportioning the conveyance in the upstream cross section, so that the percentage of conveyance for each section is equal to the percentage of flow in each opening.
4. The stagnation points in the downstream cross section (section just downstream of the river crossing) are located in the same manner.
5. Once a flow distribution is assumed, and the upstream and downstream stagnation points are set, the program calculates the water surface and energy profiles through each opening, using the assumed flow.
6. After the program has computed the upstream energy for each opening, a comparison is made between the energies to see if a balance has been achieved (i.e. the difference between the highest and lowest computed energy is less than a predefined tolerance). If the energies are not within the tolerance, the program computes an average energy by using a flow weighting for each opening.
7. The average energy computed in step 6 is used to estimate the new flow distribution. This estimate of the flow distribution is based on adjusting the flow in each opening proportional to the percentage that

the computed energy for that opening is from the weighted average energy. An opening with a computed energy higher than the weighted mean will have its flow reduced, while an opening with a computed energy that is lower than the weighted mean will have its flow increased. Once the flow for all the openings is adjusted, a continuity check is made to ensure that the sum of the flows in all the openings is equal to the total flow. If this is not true, the flow in each opening is adjusted to ensure that the sum of flows is equal to the total flow.

8. Steps 3 through 7 continue until either a balance in energy is reached or the program gets to the fifth iteration. If the program gets to the fifth iteration, then the program switches to a different iterating method. In the second iteration method, the program formulates a flow versus upstream energy for each opening. The rating curve is based on the first four iterations. The rating curves are combined to get a total flow versus energy curve for the entire crossing. A new upstream energy guess is based on entering this curve with the total flow and interpolating an energy. Once a new energy is estimated, the program goes back to the individual opening curves with this energy and interpolates a flow for each opening. With this new flow distribution the program computes the water surface and energy profiles for each opening. If all the energies are within the tolerance, the program is finished. If it is not within the tolerance the rating curves are updated with the new computed points, and the process continues. This iteration procedure continues until either a solution within the tolerance is achieved, or the program reaches the maximum number of iterations. The tolerance for balancing the energies between openings is 5 times the normal cross section water surface tolerance (0.05 feet or 0.015 meters). The default number of iterations for the multiple opening solutions scheme is 1.5 times the normal cross section maximum (the default is 30).
9. Once a solution is achieved, the program places the mean computed energy into the upstream cross section and computes the corresponding water surface for the entire cross section. In general, this water surface will differ from the water surfaces computed from the individual openings. This mean energy and water surface are reported as the final solution at the upstream section.

Limitations of the Multiple Opening Approach

The multiple opening method within HEC-RAS is a one-dimensional flow approach to a complex hydraulic problem. The methodology has the following limitations: the energy grade line is assumed to be constant upstream and downstream of the multiple opening crossing; the stagnation

points are not allowed to migrate past the edge of an adjacent opening; and the stagnation points between a conveyance area and any other type of opening must be fixed (i.e. can not float). Given these limitations, if you have a multiple opening crossing in which the water surface and energy vary significantly between openings, then this methodology may not be the most appropriate approach. An alternative to the multiple opening approach is the split flow approach. This method is discussed below.

Divided Flow Approach

An alternative approach for solving a multiple opening problem is to model the flow paths of each opening as a separate river reach. This approach is more time consuming, and requires the user to have a greater understanding of how the flow will separate between openings. The benefit of using this approach is that varying water surfaces and energies can be obtained between openings. An example of a divided flow application is shown in Figure 7.3.

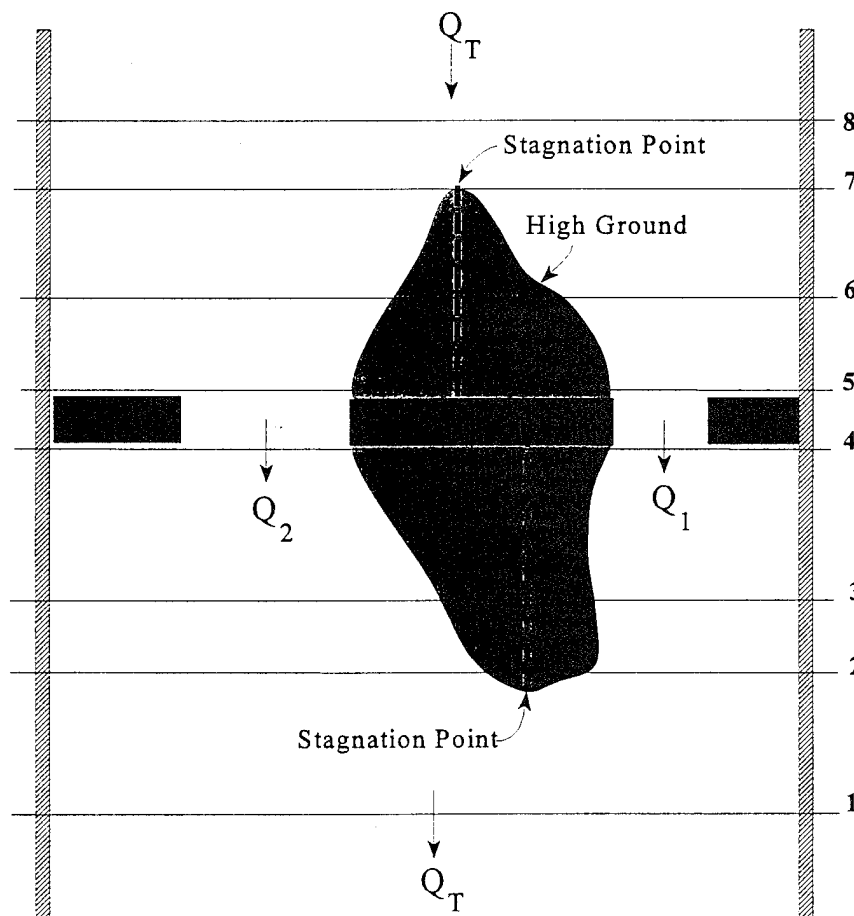

Figure 7.3 Example of a Divided Flow Problem

In the example shown in Figure 7.3, high ground exist between the two openings (both upstream and downstream). Under low flow conditions, there are two separate and distinct channels. Under high flow conditions the ground between the openings may be submerged, and the water surface continuous across both openings. To model this as a divided flow the user must create two separate river reaches around the high ground and through the openings. Cross sections 2 through 8 must be divided at what the user believes is the appropriate stagnation points for each cross section. This can be accomplished in several ways. The cross sections could be physically split into two, or the user could use the same cross sections in both reaches. If the same cross sections are used, the user must block out the area of each cross section (using the ineffective flow option) that is not part of the flow path for that particular reach. In other words, if you were modeling the left flow path, you would block out everything to the right of the stagnation points. For the reach that represents the right flow path, everything to the left of the stagnation points would be blocked out.

When modeling a divided flow, you must define how much flow is going through each reach. The current version of HEC-RAS does not optimize flow splits (this will be added in later versions). The user makes a first guess at the flow distribution, and then runs the model. The results at cross section 8 are compared. If one branch has a higher energy than the other one at section 8, then that branches flow should be reduced and the other increased by the same amount. The user should continue to do this until the energies from both branches at section 8 are within a reasonable tolerance.

CHAPTER 8

Floodway Encroachment Calculations

The evaluation of the impact of floodplain encroachments on water surface profiles can be of substantial interest to planners, land developers, and engineers. It is also a significant aspect of flood insurance studies. HEC-RAS contains five optional methods for specifying floodplain encroachments. This chapter describes the computational detail of each of the five encroachment methods, as well as special considerations for encroachments at bridges, culverts, and multiple openings. Discussions are also provided on a general modeling approach for performing an encroachment analysis.

For information on how to enter encroachment data, how to perform the encroachment calculations, and viewing encroachment results, see Chapter 9 of the HEC-RAS user's manual.

Contents

- Introduction
- Encroachment Methods
- Bridge, Culvert, and Multiple Opening Encroachments
- General Modeling Guidelines

Introduction

The HEC-RAS floodway procedure is based on calculating a natural profile (existing conditions geometry) as the first profile in a multiple profile run. Other profiles, in a run, are calculated using various encroachment options, as desired. Before performing an encroachment analysis, the user should have developed a model of the existing river system. This model should be calibrated to the fullest extent that is possible. Verification that the model is adequately modeling the river system is an extremely important step before attempting to perform an encroachment analysis.

Encroachment Methods

HEC-RAS contains five optional methods for specifying floodway encroachments. Each method is illustrated in the following paragraphs.

Encroachment Method 1

With encroachment method 1 the user specifies the exact locations of the encroachment stations for each individual cross section. The encroachment stations can also be specified differently for each profile. An example of encroachment method 1 is shown in Figure 8.1.

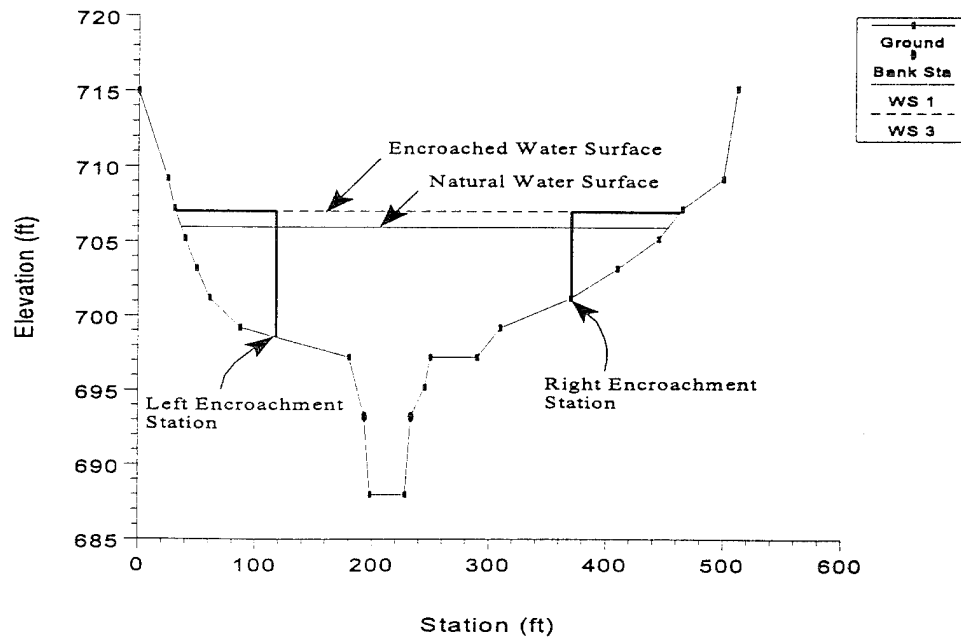

Figure 8.1 Example of Encroachment Method 1

Encroachment Method 2

Method 2 utilizes a fixed top width. The top width can be specified separately for each cross section. The left and right encroachment stations are made equal distance from the centerline of the channel, which is halfway between the left and right bank stations. If the user specified top width would end up with an encroachment inside the channel, the program sets that encroachment (left and/or right) to the channel bank station. An example of encroachment method 2 is shown in Figure 8.2.

HEC-RAS also allows the user to establish a left and right offset. The left and right offset is used to establish a buffer zone around the main channel for further limiting the amount of the encroachments. For example, if a user established a right offset of 5 feet and a left offset of 10 feet, the model will limit all encroachments to 5 feet from the left bank station and 10 feet from the right bank station. If a user entered top width would end up inside of an offset, the program will set the encroachment at the offset stationing.

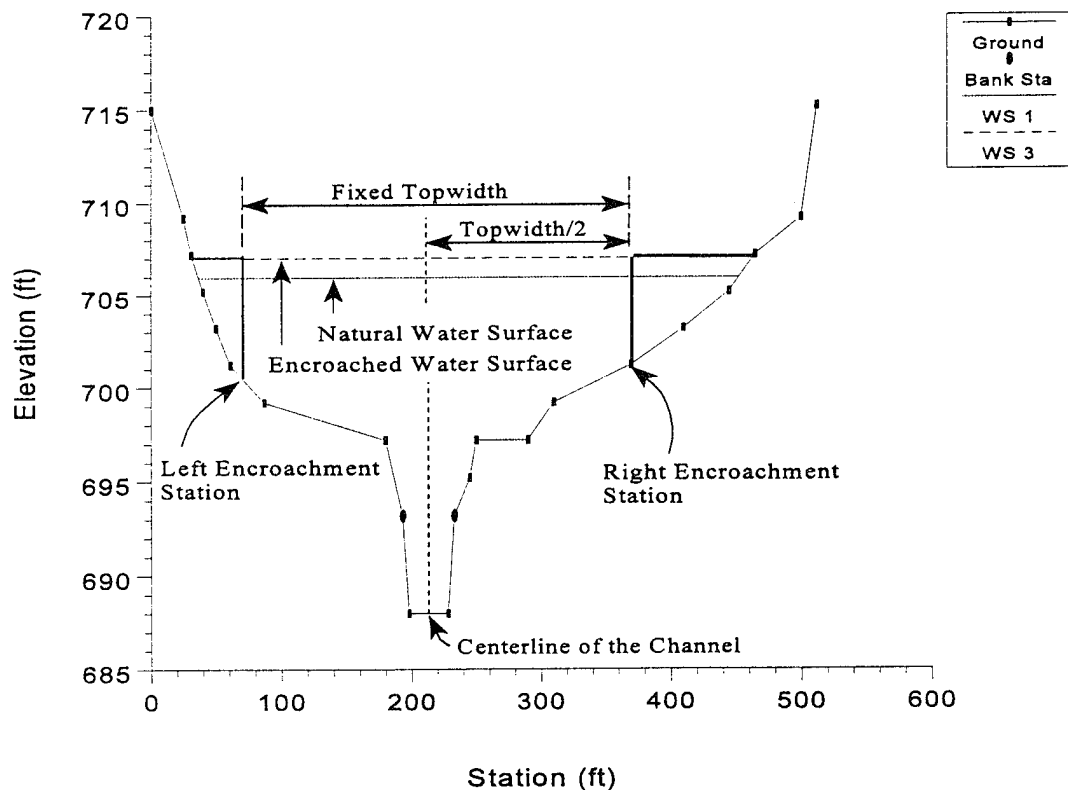

Figure 8.2 Example of Encroachment Method 2

Encroachment Method 3

Method 3 calculates encroachment stations for a specified percent reduction in the conveyance (%K Reduction) of the natural profile for each cross section. One-half of the conveyance is eliminated on each side of the cross section (if possible). The computed encroachments can not infringe on the main channel or any user specified encroachment offsets. If one-half of the conveyance exceeds either overbank conveyance, the program will attempt to make up the difference on the other side. If the percent reduction in cross section conveyance cannot be accommodated by both overbank areas combined, the encroachment stations are made equal to the stations of left and right channel banks (or the offset stations, if specified). An example of encroachment method 3 is shown in Figure 8.3.

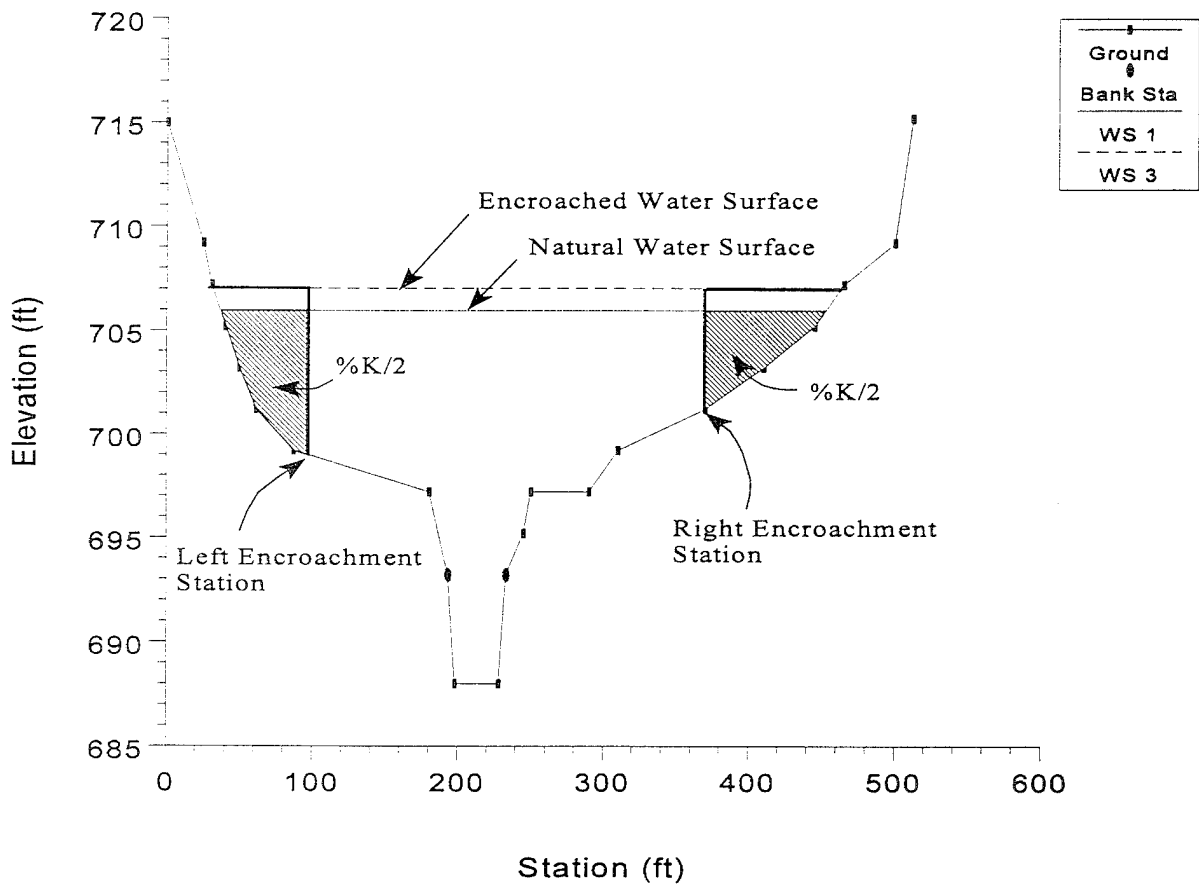

Figure 8.3 Example of Encroachment method 3

Encroachment method 3 requires that the first profile (of a multiple profile run) must be a natural (unencroached) profile. Subsequent profiles (profiles 2-15) of a multiple profile run may be utilized for Method 3 encroachments. The percentage of reduction in conveyance can be changed for any cross section. A value of 10 percent for the second profile would indicate that 10 percent of the conveyance based on the natural profile (first profile) will be eliminated - 5 percent from each overbank. Equal conveyance reduction is the default.

An alternate scheme to **equal** conveyance reduction is conveyance reduction in **proportion** to the distribution of natural overbank conveyance. For instance, if the natural cross section had twice as much conveyance in the left overbank as in the right overbank, a 10 percent conveyance reduction value would reduce 6.7 percent from the left overbank and 3.3 percent from the right overbank.

Encroachment Method 4

Method 4 computes encroachment stations so that conveyance within the encroached cross section (at some higher elevation) is equal to the conveyance of the natural cross section at the natural water level. This higher elevation is specified as a fixed amount (target increase) above the natural (e.g., 100 year) profile. The encroachment stations are determined so that an equal loss of conveyance (at the higher elevation) occurs on each overbank, if possible. If half of the loss cannot be obtained in one overbank, the difference will be made up, if possible, in the other overbank, except that encroachments will not be allowed to fall within the main channel.

A target increase of 1.0 indicates that a 1 foot rise will be used to determine the encroachments based on equal conveyance. An alternate scheme to **equal** conveyance reduction is to reduce conveyance in **proportion** to the distribution of natural overbank conveyance. See Method 3 for an explanation of this. A key difference between method 4 and method 3 is that the reduction in conveyance is based on the higher water surface (target water surface) for method 4, while method 3 uses the lower water surface (natural water surface). An example of a method 4 encroachment is shown in Figure 8.4.

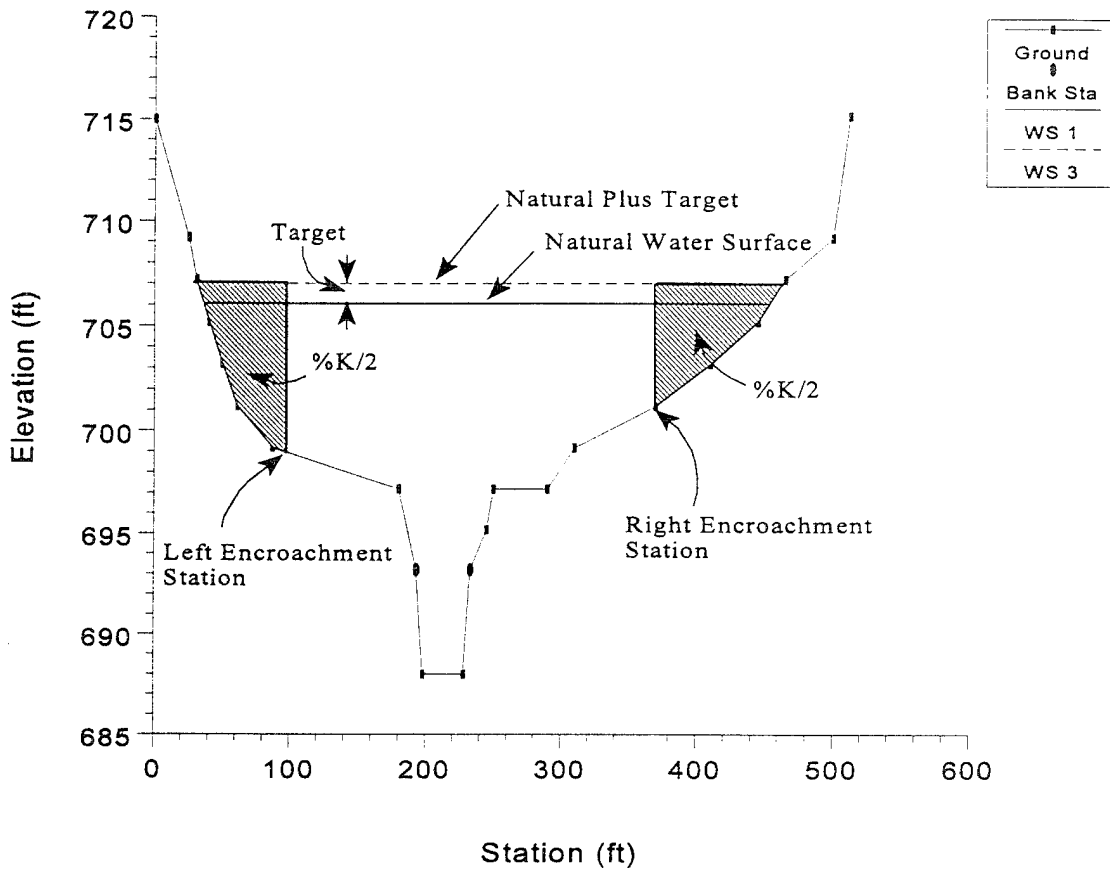

Figure 8.4 Example of Encroachment Method 4

Encroachment Method 5

Method 5 operates much like Method 4 except that an optimization scheme is used to obtain the target difference in water surface elevation between natural and encroached conditions. A maximum of 20 trials is allowed in attempting a solution. Equal conveyance reduction is attempted in each overbank, unless this is not possible (i.e. the encroachment goes all the way into the bank station before the target is met). The input data for method 5 consists of a target water surface increase and a target energy increase. The program objective is to match the target water surface without exceeding the target energy. If this is not possible, the program will then try to find the encroachments that match the target energy. If no target energy is entered, the program will keep encroaching until the water surface target is met. If only a target energy is entered, the program will keep encroaching until the target energy is met. If neither of the criteria is met after 20 trials, the program will take the best answer from all the trials and use it as the final result. The target

water surface and energy can be changed at any cross section, like Methods 1 through 4. An example of method 5 is shown in Figure 8.5.

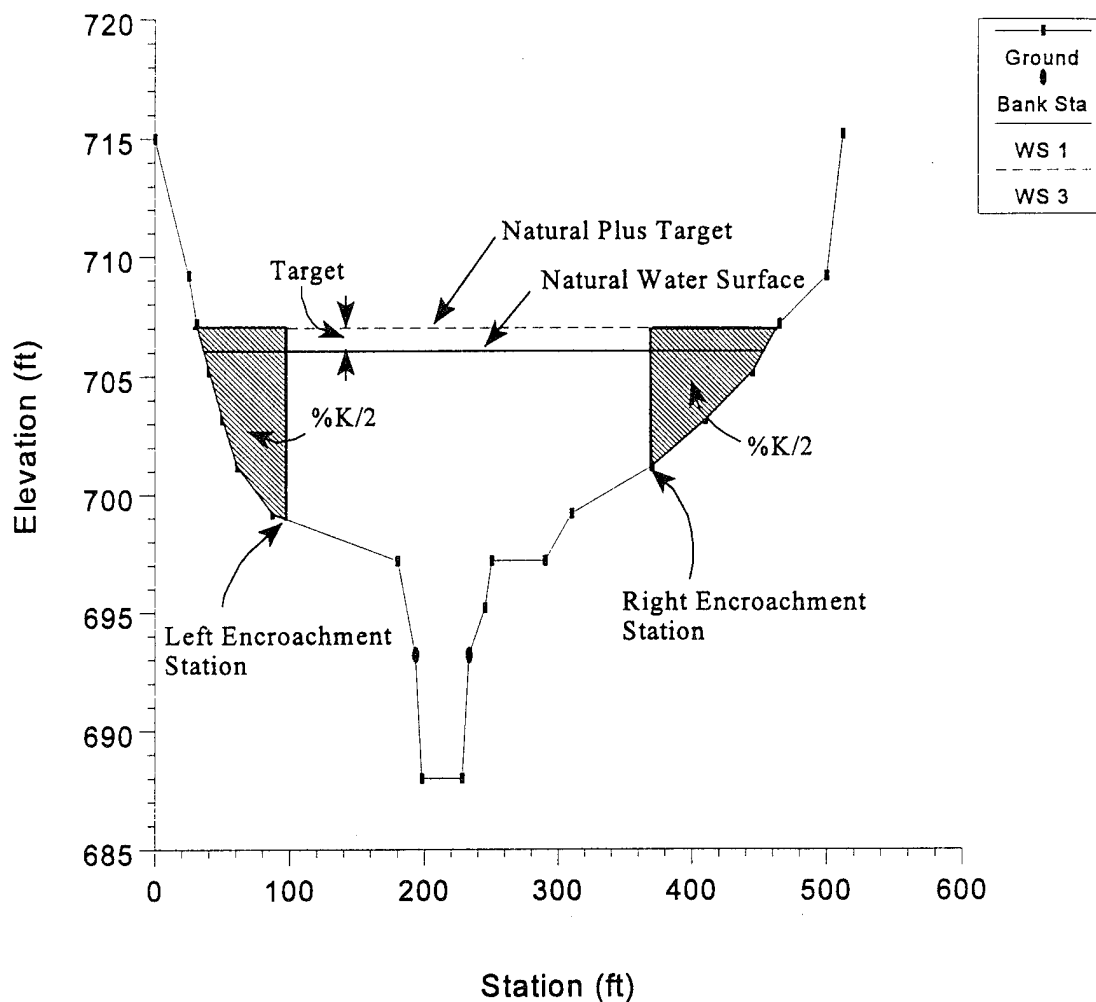

Figure 8.5 Example of Encroachment Method 5

Bridge, Culvert, and Multiple Opening Encroachments

In general, the default methodology for encroachments at bridges, culverts, and multiple openings, is to use the downstream computed encroachments through the structure, and at the cross section just upstream of the structure (the program does this automatically). There are a few exceptions to this rule.

First, when using method 1, the user can enter separate encroachment stations downstream of the structure, inside the structure, and upstream of the structure. Only one set of encroachments can be entered for inside of the structure.

Second, for encroachment methods 2 through 5, the program will allow for separate encroachment calculations at a bridge, when using the energy based bridge computation method. For all other bridge computation methods (Momentum, Yarnell, Contracted Opening, Pressure Flow, Pressure and Weir Flow, and Low Flow and Weir Flow) the program will use the computed downstream encroachments through the bridge and at the cross section just upstream.

At a culvert crossing or a multiple opening, when using encroachment methods 2 through five, the program will always use the computed downstream encroachments through the structure and just upstream of the structure. The only way to override this is to use method 1 encroachments.

Also, encroachments can be turned off at any bridge, culvert, or multiple opening.

General Modeling Guidelines

The HEC-RAS floodway procedure is based on calculating a natural profile (no encroachments) as the first profile of a multiple profile run. Subsequent profiles are calculated with the various encroachment options available in the program.

In general, when performing a floodway analysis, encroachment methods 4 and 5 are normally used too get a first cut at the encroachment stations. Recognizing that the initial floodway computations may provide changes in water surface elevations greater, or less, than the “target” increase, initial computer runs are usually made with several “target” values. The initial computer results should then be analyzed for increases in water surface elevations, changes in velocities, changes in top width, and other parameters. Also, plotting the results with the X-Y-Z perspective plot, or onto a topographic map, is recommended. From these initial results, new estimates can be made and tried.

The increase in water surface elevation will frequently exceed the “target” used to compute the conveyance reduction and encroachment stations for the section. That is why several target increase values are generally used in the initial floodway computations.

After a few initial runs, the encroachment stations should become more defined. Because portions of several computed profiles may be used, the final computer runs are usually made with encroachment Method 1 defining the

specific encroachment stations at each cross section. Additional runs are often made with Method 1, allowing the user to adjust encroachment stations at specific cross sections to further define the floodway.

While the floodway analysis generally focuses on the change in water surface elevation, it is important to remember that the floodway must be consistent with local development plans and provide reasonable hydraulic transitions through the study reach. Sometimes the computed floodway solution, that provides computed water surfaces at or near the target maximum, may be unreasonable when transferred to the map of the actual study reach. If this occurs, the user may need to change some of the encroachment stations, based on the visual inspection of the topographic map. The floodway computations should be re-run with the new encroachment stations to ensure that the target maximum is not exceeded.

Appendix A References

- American Iron and Steel Institute (AISI), 1980. *Modern Sewer Design*, Washington D.C.
- Arcement, G. J., Jr., and V. R. Schneider, 1989. "Guide for Selecting Manning's Roughness Coefficient for Natural Channels and Floodplains," U.S. Geological Survey, Water Supply Paper 2339, 38 p., Washington D.C..
- Barkau, Robert L., 1992. *UNET, One-Dimensional Unsteady Flow Through a Full Network of Open Channels*, Computer Program, St. Louis, MO.
- Barnes, Harry H., Jr., 1967. "Roughness Characteristics of Natural Channels", U.S. Geological Survey, Water Supply Paper 1849, Washington D.C.
- Bradley, J.N., 1978. *Hydraulics of Bridge Waterways*, Hydraulic Design Series No. 1, Federal Highway Administration, U.S. Department of Transportation, Second Edition, revised March 1978, Washington D.C.
- Bureau of Public Roads (BPR), 1965. *Hydraulic Charts for the Selection of Highway Culverts*, Hydraulic Engineering Circular No. 5, U.S. Department of Commerce.
- Chow, Ven Te, *Open Channel Flow*, McGraw - Hill Book Company, 1959
- Cowan, W.L., 1956. "Estimating Hydraulic Roughness Coefficients", *Agricultural Engineering*, Vol. 37, No. 7, pp 473-475.
- Fasken, G.B., 1963. "Guide for Selecting Roughness Coefficient n Values for Channels", Soil Conservation Service, US department of Agriculture, 45 p.
- Federal Highway Administration, 1984. *Guide for Selecting Manning's Roughness Coefficients for Natural Channels and Flood Plains*", Report No. FHWA-TS-84-204, McLean, Virginia.
- Federal Highway Administration, 1985. *Hydraulic Design of Highway Culverts*, Hydraulic Design Series No. 5, U.S. Department of Transportation, September 1985, Washington D.C..
- Hicks, D.M. and P.D. Mason, 1991. *Roughness Characteristics of New Zealand Rivers*, Water Resources Survey, DSIR Marine and Freshwater, New Zealand, June 1991.
- Hydrologic Engineering Center, 1986. "Accuracy of Computed Water Surface Profiles", Research Document 26, U.S. Army Corps of Engineers, Davis CA.
- Hydrologic Engineering Center, 1991. *HEC-2, Water Surface Profiles*, User's Manual, U.S. Army Corps of Engineers, Davis CA.

References

Hydrologic Engineering Center, 1993. *UNET, One-Dimensional Unsteady Flow Through a Full Network of Open Channels*, User's Manual, U.S. Army Corps of Engineers, Davis, CA.

Hydrologic Engineering Center, 1994. *HECDSS, User's Guide and Utility Programs Manual*, U.S. Army Corps of Engineers, Davis CA.

Jarrett, R.D., 1984. "Hydraulics of High Gradient Streams", A.S.C.E. Journal of Hydraulic Engineering, Vol. 110, No. 11, November 1984.

King, H.W. and E.F. Brater 1963. *Handbook of Hydraulics*, Fifth Edition, McGraw Hill Book Company, New York.

Lindsey, W.F., 1938. "Typical Drag Coefficients for Various Cylinders in Two Dimensional Flow", NACA Technical Report 619.

Limerinos, J.T., 1970. "Determination of the Manning Coefficient from Measured Bed Roughness in Natural Channels", U.S. Geological Survey, Water Supply Paper 1898-B, Washington D.C.

Microsoft Corporation, 1992. *Microsoft Windows 3.1*, User's Manual, Redmond WA.

Reed, J.R. and A.J. Wolfkill, 1976. "Evaluation of Friction Slope Models", River 76, Symposium on Inland Waterways for Navigation Flood Control and Water Diversions, Colorado State University, CO.

Shearman, J. O., 1990. User's Manual for WSPRO - A computer model for water surface profile computations, Federal Highway Administration, Publication No. FHWA-IP-89-027, 177 p.

U.S. Army Corps of Engineers, 1965. *Hydraulic Design of Spillways*, EM 1110-2-1603, Plate 33.

Yarnell, D.L., 1934. "Bridge Piers as Channel Obstructions", Technical Bulletin 442, U.S. Department of Agriculture, Washington D.C.