

HEEGAARD SURFACES FOR CERTAIN GRAPHS IN COMPRESSIONBODIES

SCOTT A. TAYLOR AND MAGGY TOMOVA

ABSTRACT. Let M be a compressionbody containing a properly embedded graph T (with at least one edge) such that $\partial_+M - T$ is parallel to the frontier of $T \cup \partial_-M$ in M . We extend methods of Hayashi and Shimokawa to show that if H is a bridge surface for T then one of the following occurs:

- H is stabilized, boundary stabilized, or perturbed
- T contains a removable path
- M is a trivial compressionbody and $H - T$ is properly isotopic in $M - T$ to $\partial_+M - T$.

The results of this paper are used in later work to show that if a bridge surface for a graph in a 3-manifold is c -weakly reducible then either a degenerate situation occurs or the exterior of the graph contains an essential meridional surface.

1. INTRODUCTION

Hayashi and Shimokawa [HS3] created a version of thin position that combines the notion of thin position for a knot or link in S^3 [G] with thin position for a 3-manifold [ST3]. They prove an analogue of a famous theorem of Casson and Gordon [CG] for their version of thin position. Informally: if a bridge surface for a link in a 3-manifold can be untelescoped then either the bridge position was not “minimal” or there is an essential closed or meridional surface in the exterior of the link. The arguments in [HS3] rely heavily on other work [HS1, HS2] which classifies Heegaard splittings of certain 1-manifolds in certain 3-manifolds. These classification theorems are used to understand what happens if every component of a thin surface is boundary parallel in the exterior of the 1-manifold.

In [ST2], Scharlemann and Thompson defined thin position for a graph in the 3-sphere (see also [GST, S]). Applications have included a new proof of the classification of Heegaard splittings of S^3 and a theorem about levelling

Date: November 24, 2010.

The second author was supported by a grant from the National Science Foundation during this research.

unknotting tunnels of tunnel number one knots and links. Li [L] used thin position for graphs to show that if for a graph in the 3–sphere thin position is not equal to bridge position then there is an essential meridional or almost meridional planar surface in its exterior.

Although Scharlemann and Thompson’s definition for thin position of a graph in S^3 can be easily adapted to define thin position for a graph in any 3–manifold, this definition has not been very productive. Instead, in [TT], we extend Hayashi and Shimokawa’s definition of thin position for a link in a 3–manifold to graphs in a 3–manifold. We use this definition to prove a Casson-Gordon type theorem which says (informally) that either thin position for a graph in a 3–manifold is bridge position, or there exists an essential meridional or closed surface in its complement, or one or more various degenerate situations occur. This theorem generalizes both [HS3] and [T]. In [TT], we use this new type of thin position to prove a theorem about leveling edges of Heegaard spines in an arbitrary closed orientable 3–manifold, a theorem somewhat analogous to [GST].

Just as Hayashi and Shimokawa’s work in [HS3] rests on the classification results in [HS1, HS2], all of which are quite technical, so our result in [TT] rests on the classification results of this paper. Our methods are inspired by the work of Hayashi and Shimokawa but because we work in far greater generality, numerous complications must be overcome. An understanding of Hayashi and Shimokawa’s techniques in [HS1, HS2] will be very beneficial in reading our paper.

In Section 2 we give the definitions needed to state our theorem which we do in Section 3. Section 4 gives an outline of the proof and the rest of the paper is devoted to the details of this proof.

2. DEFINITIONS

2.1. Trivially embedded graphs in compressionbodies. Suppose that T is a finite graph. We will usually assume that there are no vertices of valence 2; exceptions will be explicitly mentioned. We allow T to contain components homeomorphic to S^1 . Let ∂T denote the vertices of valence 1. The vertices of T which are not in ∂T are called the **interior vertices** of T . We say that T is **properly embedded** in a 3–manifold M if $T \cap \partial M = \partial T$. A **pod** is a finite tree having at least 3 edges, 0 or 1 of which is a distinguished edge called a **handle**. The edges of the pod which are not the handle are called the **legs** of the pod. If $T' \subset T$ is a subgraph of a graph T , then we say that $\text{cl}(T - T')$ is obtained by **removing** T' from T .

Let $I = [0, 1]$. Let F be a closed, possibly disconnected, surface and let T be the disjoint union of finitely many edges and pods properly embedded in $F \times I$. An edge e of T is **vertical** if it is isotopic to $\{\text{point}\} \times I$. An edge e of T is a **bridge edge** if there exists an embedded disc D so that ∂D is the endpoint union of e and an arc in $F \times \{1\}$. The disc D is called a **bridge disc** for the edge e . A pod p of T is a **bridge pod** if p has no handle and is contained in a disc D such that $\partial D \subset F \times \{1\}$. The disc D is called a **pod disc**. The closures of the components of $D - p$ are **bridge discs** for p . More generally a disc E such that ∂E is the endpoint union of an arc traversing exactly two edges of p and an arc in $F \times \{1\}$ is a **bridge disc** for p . It is not difficult to see that if every pair of edges of p has a bridge disc then there exists a pod disc for p . Finally, suppose that p is a pod with handle h . Assume that there is a pod disc for $p - h$. Notice that compressing $F \times I$ along the boundary of a regular neighborhood of a pod disc creates a 3-manifold with one component homeomorphic to $F \times I$. The pod p is a **vertical pod** if h is a vertical edge in that component.

Suppose that T is the disjoint union of vertical edges, bridge edges, bridge pods, and vertical pods such that the bridge edges, bridge pods, and vertical pods have pairwise disjoint bridge discs and pod discs. Suppose also that these bridge discs and pod discs are disjoint, except at the endpoints of the handles, from the vertical edges and handles. Assume also that the vertical edges and handles can all be simultaneously isotoped to be $\{\text{points}\} \times I$ in $F \times I$. Then T is **trivially embedded** in $F \times I$. If T is properly embedded in a 3-ball B^3 , T is **trivially embedded** if it is the disjoint union of bridge edges and bridge pods which have pairwise disjoint bridge discs and pod discs.

A **compressionbody** C is formed from $F \times I$ by attaching a finite number of 1-handles to $F \times \{1\}$. Let $\partial_- C = F \times \{0\}$ and let $\partial_+ C = \partial C - \partial_- C$. A collection of compressing discs Δ for $\partial_+ C$ is a **complete collection** if boundary-reducing C using Δ produces a manifold homeomorphic to $\partial_- C \times I$. We consider a handlebody to be a compressionbody with $\partial_- C = \emptyset$. In this case, a complete collection of discs is a collection of compressing discs for $\partial_+ C = \partial C$ which cut C into a 3-ball. We require compressionbodies to be connected and nonempty.

Let T be a finite graph properly embedded in a compressionbody C . We say that T is **trivially embedded** in C if there exists a complete collection of discs Δ for C disjoint from T such that if C' is a component of C reduced by Δ , then $T \cap C'$ is trivially embedded in C' . Figure 1 is a schematic depiction

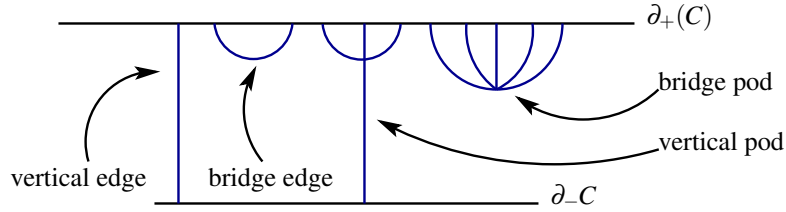

FIGURE 1. A trivially embedded graph in a compressionbody

of a trivially embedded graph in a compressionbody. Let \tilde{C} denote the compressionbody obtained from C by capping off with 3-balls any 2-sphere components of ∂_-C which are disjoint from T .

Remark. Because we allow a trivially embedded graph in a compressionbody to contain pods with handles, our definition of “trivially embedded” is more general than that of Hayashi and Shimokawa [HS1]. (Allowing pod handles is advantageous if a Heegaard surface for a graph in a 3-manifold is perturbed and you wish to unperturb it. See below for the definition of “perturbed”. See [TT] for details on unperturbing Heegaard splittings.)

A **spine** for a compressionbody C with trivially embedded graph T is a 2 or less dimensional complex Q embedded in C so that:

- (1) $\partial_+C \cap Q = \emptyset$.
- (2) $\partial_-C \cap Q$ is contained in the valence 1 vertices of Q not contained in a 2-cell of Q .
- (3) Every bridge edge of T intersects Q at precisely one vertex of Q .
- (4) If τ is a bridge pod, then $\tau \cap Q$ is a vertex of both Q and τ .
- (5) If τ is a vertical pod, then $\tau \cap Q$ is the handle of τ .
- (6) All vertical arcs of T are disjoint from Q .
- (7) All valence one vertices of Q lie in $T \cup \partial_-C$.
- (8) C collapses to $\partial_-C \cup Q \cup T$.

We let ∂_1Q denote those vertices of Q which lie on T . Let Q^2 be the union of the 2-simplices of Q and let Q^1 be the union of 1-simplices of Q not contained in Q^2 . If $Q = Q^1$, then we say that the spine Q is **elementary**. In the arguments which involve a spine Q , we will always begin by assuming that Q is elementary, but deformations in the course of the argument may convert Q into a non-elementary spine. If C is a handlebody, we will never convert Q into a non-elementary spine.

If $C = B^3$ and $T = \emptyset$, then a single point in the interior of C is a spine for C . If $C = \partial_- M \times I$ and every arc of T is a vertical arc, then \emptyset is a spine for M .

In general, for a graph T trivially embedded in C , it is straightforward to construct a spine for (C, T) . Figure 2 depicts a spine for a genus 2 handlebody containing a bridge edge and a bridge pod.

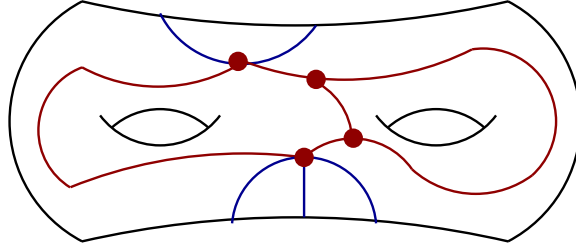

FIGURE 2. A spine for a genus 2 handlebody with a bridge edge and a bridge pod

2.2. Heegaard surfaces and compressions. Let M be a compact connected orientable 3-manifold. A **Heegaard surface** $H \subset M$ is an orientable surface such that $\text{cl}(M - H)$ consists of two distinct compressionbodies C_1 and C_2 with $H = \partial_+ C_1 = \partial_+ C_2$. We will be studying Heegaard surfaces in a compressionbody M . (We choose the notation M to emphasize the fact that it is the ambient 3-manifold and two avoid confusion with the compressionbodies on either side of a Heegaard surface in M .) We always assume that $\partial_+ M \subset C_2$. Note the possibly confusing notation: $\partial_+ M$ is a component of $\partial_- C_2$.

Suppose that $T \subset M$ is a properly embedded finite graph. We say that H is a **Heegaard surface** for (M, T) if $T_i = T \cap C_i$ is trivially embedded in C_i for $i \in \{1, 2\}$. We also will say that T is in **bridge position** with respect to H and that H is a **splitting** of (M, T) . Notice that this definition of bridge position generalizes that in [HS1] since we allow vertical pods in a compressionbody.

Suppose that $F \subset M$ is a surface such that $\partial F \subset (\partial M \cup T)$. Then F is **T -compressible**, if there exists a compressing disc for $F - T$ in $M - T$. If F is not T -compressible, it is **T -incompressible**. F is **T - ∂ -compressible** if there exists a disc $D \subset M - T$ with interior disjoint from F such that ∂D is the endpoint union of an arc γ in F and an arc δ in ∂M . We require that γ not be parallel in $F - T$ to an arc of $\partial F - T$. If F is not T - ∂ -compressible, it is **T - ∂ -incompressible**.

2.3. Stabilization, Cancellation, Perturbation, and Removable Edges.

A Heegaard surface H for (M, T) is **stabilized** if there exist discs $D_1 \subset C_1$ and $D_2 \subset C_2$ which are T -compressing discs for H and have boundaries intersecting transversally in a single point. If a Heegaard surface H is stabilized, there is another Heegaard surface H' with $\text{genus}(H') = \text{genus}(H) - 1$ and with $|T \cap H| = |T \cap H'|$.

Suppose that $D_1 \subset C_1$ and $D_2 \subset C_2$ are bridge discs for T_1 and T_2 respectively such that the arcs $\partial D_1 \cap H$ and $\partial D_2 \cap H$ have disjoint interiors but share at least one endpoint. If such discs exist, H is **cancellable**. If, in addition, $\partial D_1 \cap H$ and $\partial D_2 \cap H$ share only a single endpoint then H is **perturbed**. Hayashi and Shimokawa's notion of "strongly cancellable" is the same as perturbed. The discs $\{D_1, D_2\}$ will be known as either a **cancelling pair** or **perturbing pair** of discs. If $\partial D_1 \cup \partial D_2$ does not contain a vertex of T then $(\partial D_1 \cup \partial D_2) \cap T$ lies in a single edge e of T . We say that the edge e is **cancellable** or **perturbed** (corresponding to whether $\{D_1, D_2\}$ is a cancelling or perturbing pair of discs). See [TT] for situations where a splitting can be unperturbed.

Suppose that F is a closed connected surface and that $V = F \times I$. A **type I** Heegaard surface for V is a Heegaard surface which separates the components of ∂V . A **type II** Heegaard surface is a Heegaard surface for V which does not separate the components of ∂V . Type I and Type II Heegaard splittings were classified in [ST1].

Let F be a component of $\partial_- C_1 \subset \partial M$ and let T' be a collection of vertical arcs in $F \times [-1, 0]$. Let H' be a minimal genus type II Heegaard surface for $F \times [-1, 0]$ which intersects each arc in T' exactly twice. H' can be formed by tubing two parallel copies of F along a vertical arc not in T' . Assume that $T' \cap (F \times \{0\}) = T \cap F$. (Recall that $F \times [0, 1] \subset M$.) We can form a Heegaard surface H'' for $M \cup (F \times [-1, 0])$ by **amalgamating** H and H' . This is simply the usual notion of amalgamation of Heegaard splittings (see [S]). In fact, H'' is a Heegaard surface for $(M \cup (F \times [-1, 0]), T \cup T')$. Since $(M \cup (F \times [-1, 0]), T \cup T')$ is homeomorphic to (M, T) , we may consider H'' to be a Heegaard surface for (M, T) . H'' is called a **boundary stabilization** of H . See Figure 3.

Suppose that $\zeta \subset T$ is a 1-manifold which is the union of edges in T (possibly a closed loop containing zero or one vertices of T). We say that ζ is a **removable path** if the following hold:

(RP 1) Either the endpoints of ζ lie in ∂M or ζ is a cycle in T .

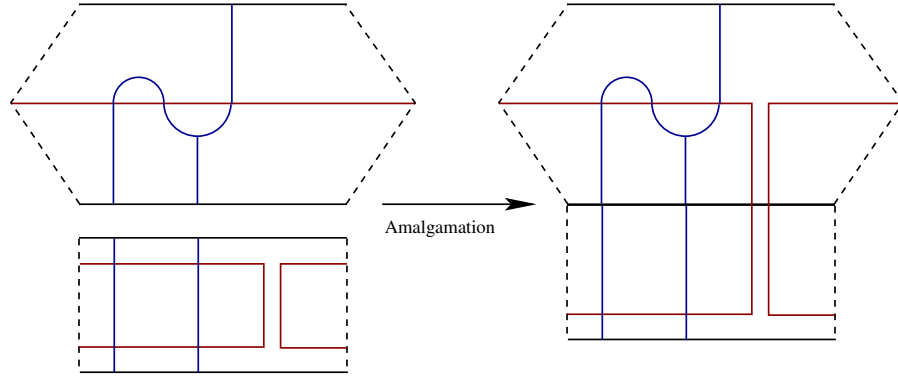

FIGURE 3. Boundary stabilizing a Heegaard surface

- (RP 2) ζ intersects H exactly twice
- (RP 3) If ζ is a cycle, there exist a cancelling pair of discs $\{D_1, D_2\}$ for ζ with $D_j \subset C_j$. Furthermore there exists a compressing disc E for H such that $|E \cap T| = 1$ and if $E \subset C_j$ then $|\partial E \cap \partial D_{j+1}| = 1$ (indices run mod 2) and E is otherwise disjoint from a complete collection of bridge discs for $T - H$ containing $D_1 \cup D_2$.
- (RP4) If the endpoints of ζ lie on ∂M , there exists a bridge disc D for the bridge arc component of $\zeta - H$ such that $D - T$ is disjoint from a complete collection of bridge discs Δ for $T - H$. Furthermore, there exists a compressing disc E for H on the opposite side of H from T such that $|E \cap D| = 1$ and E is disjoint from Δ .

If ζ is a removable path, then a slight isotopy of ζ which does not move the rest of T , moves ζ to be a subset of a spine of one of the compressionbodies $M - H$. (See [ST4, Lemma 3.3].) Also, note that by (RP2), ζ can contain at most 3 vertices of T (and that only if it contains two pod handles). See Figure 4 for an example of a removable path that is an edge with both endpoints on ∂M .

3. THE MAIN RESULT

Theorem 3.1 (Main Theorem). *Let T be a properly embedded graph in a compressionbody M , such that $\partial_+ M - \mathring{\eta}(T)$ is isotopic to the frontier of a regular neighborhood of $\partial_- M \cup T$. Let H be a Heegaard surface for (M, T) . Assume that T contains an edge. Then one of the following occurs:*

- (1) H is stabilized

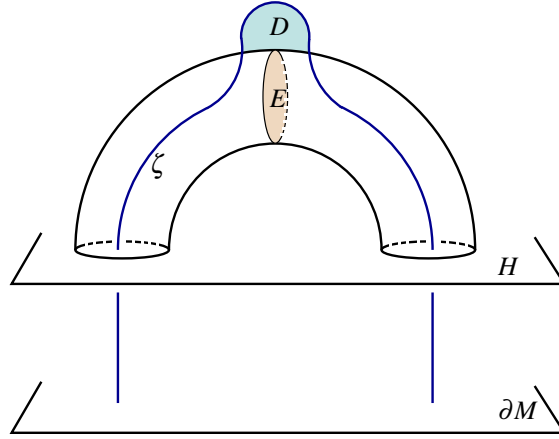

FIGURE 4. The edge ζ is a removable path with both endpoints on ∂M .

- (2) H is boundary stabilized
- (3) H is perturbed
- (4) T contains a removable path disjoint from $\partial_+ M$.
- (5) M is a 3-ball. T is a tree with a single interior vertex. $H - \mathring{\eta}(T)$ is parallel to $\partial M - \mathring{\eta}(T)$ in $M - \mathring{\eta}(T)$.
- (6) $M = \partial_- M \times I$ and $H - \mathring{\eta}(T)$ is isotopic in $M - \mathring{\eta}(T)$ to $\partial_+ M - \mathring{\eta}(T)$.

If we define a **trivial compressionbody** to be either the product of a closed surface with an interval or a 3-ball, the last two conclusions could be grouped into the single statement that M is trivial and that $H - \mathring{\eta}(T)$ is isotopic in $M - \mathring{\eta}(T)$ to $\partial_+ M - \mathring{\eta}(T)$. However, in the proof of Theorem 3.1 we often need to treat these two trivial compressionbodies differently.

Remark. The proof of Theorem 3.1 shows, in fact, that conclusion (2) can be replaced with the stronger statement that H is boundary stabilized along a component of $\partial_- M$. In [TT, Theorem 3.6], we prove directly that Theorem 3.1 as stated above implies this stronger version.

4. AN OUTLINE OF THE PROOF

The pairs (M, T) we are studying consist of a compressionbody M and a graph T so that $\partial_+ M - \mathring{\eta}(T)$ is isotopic to the frontier of a regular neighborhood of $\partial_- M \cup T$. Let H be a Heegaard surface for this pair.

In Section 5 we prove a number of preliminary results that allow us to make various simplifying assumptions throughout the proof of Theorem 3.1. For example, we show that we can always assume that no component of $T - H$

contains a pod handle adjacent to ∂_-M . This is called the **NPH** condition. We also completely classify all surfaces that are in a certain sense incompressible (called T -incompressible and ∂ - T -incompressible surfaces) in a compression body containing a trivially embedded graph.

The compressing discs for ∂_+M together with the discs that arise from the isotopy between $\partial_+M - \mathring{\eta}(T)$ and the frontier of a regular neighborhood of $\partial_-M \cup T$ can be used to create a complex R , defined in Section 6. The main property of this complex is that cutting M along R produces a collection of 3-balls and T is contained in the boundary of these balls. Also R is the union of T -incompressible and ∂ - T -incompressible surfaces. Although much more complicated, R plays the role of a “complete collection of compressing discs” often used when one studies compressionbodies without an embedded graph. Our complex generalizes similar complexes defined in [HS1] and [HS2]

Proposition 7.1 in section 7 is an important special case of Theorem 3.1 and this section is devoted to its proof. Because the proof of Theorem 3.1 in the general situation relies on the proof of this special case, under the hypotheses of the special case we prove a result that is slightly stronger than Theorem 3.1. The essence of this stronger result is that not only is Theorem 3.1 true in this special case, but it remains true if we remove certain edges from the graph T . The main tool for this proof is to consider how the complex R intersects each of the compressionbodies C_1 and C_2 of a Heegaard splitting H of (M, T) .

The proof of Proposition 7.1 is structured as follows: First we show that we may assume that $R \cap C_1$ is T -incompressible and ∂ - T -incompressible and that $R \cap C_2$ is T -incompressible. We then consider 2 cases:

- In Case 1 we assume that $R \cap C_2$ is ∂ - T -incompressible. In Lemma 7.5 we show that in this case M is either the three-ball or it is homeomorphic to surface cross an interval. These two situations are considered separately to conclude that in either situation we contradict the hypothesis of the proposition.
- In Case 2 we assume that $R \cap C_2$ is ∂ - T -compressible. This case is significantly more complicated and takes up the rest of this section. The proof is done via combinatorial arguments analysing the intersection of H and R .

In Section 8 we prove the theorem in complete generality. The proof is by induction on $-\chi(\partial_+M)$. We show that either the inductive hypothesis can be applied or that we can reduce the general situation to the special case addressed in Section 7 by adding edges to the graph T . This is in the spirit

of [HS1] where Heegaard splittings for a (3–manifold, graph) pair are first defined.

5. PRELIMINARY LEMMAS

5.1. Resolving pod handles. Suppose that τ is a trivially embedded graph in a compressionbody C . Although we allow τ to contain pod handles, we begin by showing that, for the purposes of proving the theorem, certain pod handles can be eliminated.

Suppose that h is the handle of a pod p . Let ρ be a regular neighborhood of h in C and notice that $\partial\rho$ intersects each pod leg of p once. For each pod leg, λ , choose a path $h_\lambda \subset \partial\rho$ from $\lambda \cap \partial\rho$ to ∂_-C so that h_λ is parallel to h and so that the collection $\{h_\lambda\}$ for legs λ of p is pairwise disjoint. Let τ' be the result of removing $\tau \cap \rho$ from τ and adding the union of the h_λ . Notice that τ' is trivially embedded in C . We say that (C, τ') is obtained by **resolving** the pod handle h . See Figure 5.

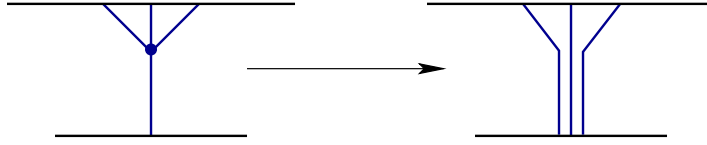

FIGURE 5. Resolving a pod handle in a compressionbody.

If T is a graph properly embedded in M and if H is a Heegaard surface for (M, T) , then we can obtain a new graph $T' \subset M$ in M by resolving one or more of the pod handles in either or both compressionbodies of $\text{cl}(M - H)$. H is still a Heegaard surface for (M, T') .

Lemma 5.1. *Suppose that (M, T') is obtained from (M, T) by resolving a pod handle of T in $M - H$ which is adjacent to ∂_-M . If (M, T) satisfies the hypotheses of Theorem 3.1, then so does (M, T') . Furthermore, if (M, T') satisfies the conclusion of Theorem 3.1, then so does (M, T) .*

Proof. It is not hard to see that if (M, T) satisfies the hypotheses of Theorem 3.1, then so does (M, T') . We, therefore, limit ourselves to showing that if (M, T') satisfies the conclusion of Theorem 3.1, then so does (M, T) .

Let h be the handle of the pod $\tau \subset T$ which is resolved. Suppose that (M, T) satisfies the hypotheses of Theorem 3.1, and that (M, T') satisfies

the conclusion of Theorem 3.1. Let $\rho = \eta(h)$ and let h_λ be the arcs from the definition of handle resolution.

- (1) Suppose that H is stabilized as a splitting of (M, T') . Let S be a sphere in M disjoint from T' intersecting H in a single simple closed curve. Out of all such spheres, we may assume that S has been chosen to minimize $|S \cap \partial\rho|$. Since $\partial\rho - \cup h_\lambda$ is a disc, an innermost disc argument shows that S is disjoint from ρ . Hence, H is stabilized as a splitting of (M, T) .
- (2) Suppose that H is boundary-stabilized as a splitting of (M, T') . If the boundary stabilization is along a component of ∂_-M not adjacent to a resolved pod handle, then the splitting of (M, T) is boundary stabilized.

Suppose, therefore, that h is adjacent to the component F of ∂_-M along which H is boundary stabilized as a splitting of (M, T') . Let ψ be the vertical arc (not in T) along which the boundary stabilization was performed. An innermost disc/outermost arc argument shows that the compressing disc for H which is a meridian of $\eta(\psi)$ can be chosen to be disjoint from $\rho = \eta(h)$. Thus, ψ is disjoint from ρ .

Consider a square V in M , with one edge of its boundary on F , one edge on H , one edge on $\partial\eta(\psi)$, and one edge on an edge e of T' containing an h_λ . We may arrange for the interior of V to intersect H in a single arc and for V to contain an edge $e' \neq e$ which contains an $h_{\lambda'}$. To reconstruct τ from e , e' , and possibly other vertical arcs, h_λ and $h_{\lambda'}$ (and possibly other arcs) are merged into a single arc. We may perform this merger within V . Suppose that C_i contains F and that C_j is the other compressionbody of $M - H$. The intersection of the component of $V - T'$ with C_j is a bridge disc for a component of $e' \cap C_j$. This bridge disc intersects a bridge disc for the pod τ in V in a single point, showing that H is perturbed as a splitting of (M, T) . See Figure 6.

- (3) Suppose that H is perturbed as a splitting of (M, T') . An argument similar to the case when H is stabilized as a splitting of (M, T') shows that H is also perturbed as a splitting of (M, T) .
- (4) Suppose that T' contains a removable path ζ disjoint from ∂_+M . If the endpoints of ζ are identified in T' , ζ is also a removable path in T . Suppose, therefore, that the endpoints of ζ lie on ∂_-M .

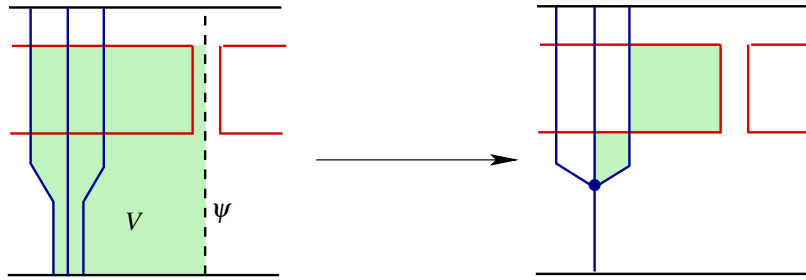

FIGURE 6. Undoing a handle resolution may result in a perturbation.

If ζ is disjoint from ρ , then ζ continues to be a removable path in T . Assume that ζ is not disjoint from ρ . Resolving h results in a collection of vertical edges. At most two of these vertical edges lie in ζ .

If exactly one edge h_λ lies in ρ , then T is perturbed as in Case (2). Suppose, therefore, that $h_\lambda \neq h_{\lambda'}$ both lie in $\zeta \cap \rho$. Then the component of T containing h consists of a loop γ and the edge h . There are cancelling discs $\{D_1, D_2\}$ for γ such that D_1 is a bridge disc for the bridge arc component of $\zeta - H$. The disc D_2 is disjoint from the disc E in (RP 4). See Figure 7.

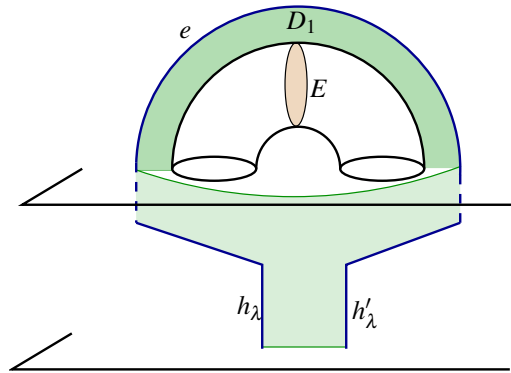

FIGURE 7. Undoing a handle resolution causes removable paths to persist. A portion of the lower green disc becomes a bridge disc after undoing the pod resolution.

- (5) If M is a 3-ball, then $\partial_- M = \emptyset$ and $T = T'$.
- (6) Suppose that $M = \partial_- M \times I$, that H is isotopic in $M - \mathring{\eta}(T')$ to $\partial_+ M - \mathring{\eta}(T')$ and that each edge of T' intersects H no more than

one time. Since H is parallel to ∂_+M , H separates ∂_+M from ∂_-M . Thus, $(C_2, T'_2) = (\partial_+M \times I, \text{points} \times I)$. Since $h \subset C_1$, we have $(C_2, T_2) = (C_2, T'_2)$. Thus, conclusion (6) holds for (M, T) .

□

As a result of this lemma, we will frequently assume that if (M, T) satisfies the hypotheses of Theorem 3.1 and if H is a Heegaard surface for (M, T) , then

(NPH) No component of $T - H$ contains a pod handle adjacent to ∂_-M .

5.2. Puncturing Interior Monotonic Edges. Suppose that (M, T) satisfies the hypotheses of Theorem 3.1 and that H is a Heegaard surface for (M, T) dividing M into compressionbodies C_1 and C_2 with $\partial_+M \subset C_2$. A **monotonic interior edge** is an edge e of T with no endpoint on ∂M and which intersects H in a single point.

If e is an interior monotonic edge of $T \subset M$, then one endpoint v of e is in C_1 . Let $M' = M - \mathring{\eta}(v)$ and $T' = T \cap M'$. If there are no pod handles adjacent to ∂_-M , then since $v \in C_1$, H' is a Heegaard surface for (M', T') . It is clear that (M', T') satisfies the hypotheses of Theorem 3.1.

Lemma 5.2. *Suppose that no pod handles of T are adjacent to ∂_-M . If H as a splitting of (M', T') satisfies the conclusion of Theorem 3.1, then it also does so as a splitting of (M, T) .*

Proof. Let C'_i for $i = 1, 2$ denote the compressionbodies into which H splits M' . If H is stabilized or perturbed as a splitting of (M', T') then it is stabilized or perturbed as a splitting of (M, T) since any disc which is essential in C'_i is also essential in C_i .

Suppose that H is boundary-stabilized as a splitting of (M', T') and let F be the component of ∂_-M' along which the boundary-stabilization was performed. If $F \neq \partial\eta(v)$, then H is boundary-stabilized as a splitting of (M, T) . If $F = \partial\eta(v)$, then an argument similar to that of Lemma 5.1 shows that H is perturbed as a splitting of (M, T) .

Suppose that ζ is a removable path in T' . If ζ is disjoint from $\partial\eta(v)$, then ζ remains a removable path in T . Suppose, therefore, that ζ has both endpoints on $\partial\eta(v)$. Let D, Δ , and E be the discs from (RP 4). Choose a vertical disc V in C_1 which is disjoint from $\Delta \cup E$ and which contains the edges $\zeta \cap C_1$. Let $V' \subset \eta(v)$ be a bridge disc for $T \cap \eta(v)$ such that $V \cap \partial\eta(v) = V' \cap \partial\eta(v)$. Let $D_1 = D$ and $D_2 = V \cup V'$. Let ζ_T be the loop in T containing ζ . The pair $\{D_1, D_2\}$ is a cancelling pair for ζ_T which is disjoint

from Δ and which intersects E exactly once. Thus, ζ_T is a removable loop in T .

It is impossible for M' to equal B^3 . If $M' = \partial_- M' \times I$, then $M' = S^2 \times I$ since $\partial \eta(v) \subset \partial_- M'$. If $H - \dot{\eta}(T')$ is isotopic in $M - \dot{\eta}(T')$ to $\partial_+ M' - \dot{\eta}(T')$, then both endpoints of $e \cap M'$ lie on $\partial M'$. This contradicts the fact that e is an interior monotonic edge. \square

We say that (M', T') is obtained by **puncturing** an interior monotonic edge of (M, T) .

5.3. Essential Surfaces in (Compressionbody, Trivial Graph). In [HS1, Lemma 2.4], Hayashi and Shimokawa classify compact T -incompressible and T - ∂ -incompressible surfaces in a compressionbody with a trivially embedded graph. We need a version of their theorem that allows for trivially embedded graphs to have pod handles.

Proposition 5.3. *Let T be a graph trivially embedded in a compressionbody C . Suppose that F is a compact embedded surface in C such that $F - T$ is connected. Suppose also that $\partial F \subset (\partial C \cup T)$, $(F \cap \partial C) \subset \partial F$, and $F \cap T$ is the union of edges of T . If F is T -incompressible and T - ∂ -incompressible, then F is one of the following:*

- (1) a sphere disjoint from T
- (2) a properly embedded disc $D \subset C$ which is disjoint from T
- (3) a properly embedded disc D such that $\partial D \subset \partial_+ C$ and $D \cap T$ is a single pod leg
- (4) a properly embedded disc D such that $\partial D \subset \partial_- C$ such that $D \cap T$ is a single pod handle
- (5) a bridge disc
- (6) a vertical disc D such that $\partial D \cap T$ has two components. Each component is either a vertical edge or a pod leg and an adjacent pod handle
- (7) a vertical annulus A such that $A \cap T$ is either empty, consists of a vertical edge, or consists of a pod handle and one or two pod legs.
- (8) one of types (6) or (7) that also contains some number of pod handles but none of their adjacent pod legs
- (9) a closed surface parallel to $\partial_- \tilde{C}$.

Figure 8 shows a schematic representation of surfaces of type (7) and (8).

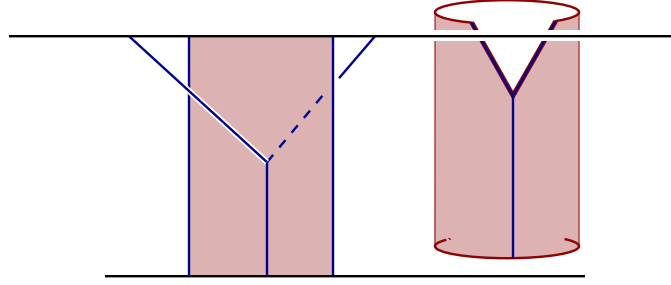

FIGURE 8. A disc of type (8) and an annulus of type (7) which contains a handle and two adjacent pod legs.

Proof. Let F be a surface satisfying the hypotheses of the proposition and suppose that F is not of type (3), (4), or (5).

Claim 1: $F \cap T$ contains a pod leg in its interior only if it also contains an adjacent pod handle.

Let e be a pod leg of a pod $\tau \subset T$ such that $e \subset F$ and F does not contain a handle for τ . Let D be a pod disc for τ minimizing $|D \cap F|$. The frontier δ of a small regular neighborhood of D is a disc which intersects a handle for τ once. Either F divides δ into two discs or $F \cap \delta = \emptyset$. In the latter case, F is parallel to D and so F is a bridge disc. In the former case, let δ' be the disc which is the closure of a component of $\delta - F$ not intersecting the handle for τ . The disc δ' is a T - ∂ -compressing for F , unless F is of type (3). \square (Claim 1)

Claim 2: If $F \cap T$ contains a valence 1 vertex in its interior then there is a graph T' in C such that C , T' , and each component of $F - T'$ satisfy the hypotheses of the theorem. The graph T' is obtained by introducing additional pod legs to T which lie in F . $F \cap T'$ has no valence 1 vertices in the interior of F .

Any valence one vertex of $T \cap F$, by Claim 1, must be an endpoint of a pod handle in F . Let h be the pod handle and τ be the pod containing h . Let ρ be a regular neighborhood of h in C and consider the punctured disc $Q = \partial\rho - \tau$. The boundary of Q lies in ∂_-C and has one puncture for each leg of the pod τ . The intersection $Q \cap F$ consists of a single essential arc on Q .

Let p_1 and p_2 be punctures in Q on opposite sides of the arc $Q \cap F$. Let e_1 and e_2 be the pod legs of τ associated to p_1 and p_2 . Let δ be the bridge disc containing them. An innermost disc/outermost arc argument shows that we may assume that $F \cap \delta$ consists of a single arc which has one endpoint at the pod vertex and the other at ∂_+C .

Add the edge $F \cap \delta$ to τ creating a pod τ' with an additional pod leg. The discs $\delta - F$ are bridge discs for τ' , showing that τ' is trivially embedded. Do this for each such τ to create the graph T' . It is easy to see that F is T' -incompressible and T' - ∂ -incompressible. Hence, C , T' , and each component of $\text{cl}(F - T')$ satisfy the hypotheses of the proposition. \square (Claim 2)

Let F' be a component of the closure of $F - T'$, where T' is the graph provided by Claim 2. Notice that, by Claims 1 and 2, each vertex of $F' \cap T'$ in the interior of F' has valence at least 2. Let T'' be the graph created from T' by resolving all the pod handles of T' . Since $F' - T$ is connected, after a small isotopy of F' to intersect a new vertical arc, rather than a pod handle, resolving the pod handles does not have any effect on F' and the intersection between F' and T' is the same as between F' and T'' .

Suppose that τ is a pod of T having a handle h . Let e_1, \dots, e_n be the vertical arcs in C created by resolving h . We think of the e_i as lying in $\partial\eta(\tau)$. Let D be a pod disc for τ . Let $\delta_1, \dots, \delta_n$ be the vertical discs contained in $\partial\eta(\tau \cup D)$ so that δ_i contains e_i and e_{i+1} (with indices mod n) in its boundary. By construction, F'' is disjoint from the interior of each δ_i . The boundary of F'' may intersect $\partial\delta_i$ along e_i and e_{i+1} .

Suppose that D is a T'' -compressing or ∂ -compressing disc for F' . A standard innermost disc/outermost arc argument shows that we may assume that $D \cap \delta_i = \emptyset$ for all i . Then D is a T' -compressing disc or ∂ -compressing disc for F' , a contradiction. Hence, F' is T'' incompressible and T'' - ∂ -incompressible.

Since $F' - T''$ is connected and not of type (3) or (5), by [HS1, Lemma 2.4], $\text{cl}(F' - T'')$ is one of the following:

- (A.) a sphere disjoint from T''
- (B.) a properly embedded disc disjoint from T''
- (C.) a bridge disc for T''
- (D.) a vertical disc such that $\partial F' \cap T''$ contains two vertical arc components
- (E.) a vertical annulus A such that $A \cap T''$ is either empty or contains a vertical arc
- (F.) a closed component parallel in \tilde{C} to $\partial_- C$.

If $F' - T''$ is of type (A.) or (B.), $F' - T'$ is a sphere or disc disjoint from T' and, thus, F is a sphere or disc disjoint from T .

If $F' - T''$ is of type (C.), then $F' - T'$ is a bridge disc for T' , since F' does not contain a pod handle of T' . For the same reason, $F - T$ is a bridge disc for T .

If $F' - T''$ is of type (E.), then $T' \cap F'$ consists of at most one vertical arc and so either F is of type (7) or (8). In the latter case, it contains exactly one pod handle.

If $F' - T''$ is of type (D.), then $F' - T'$, if it not the same as $F' - T''$, is obtained from $F' - T''$ by gluing together two copies of a pod handle in $\partial F'$. Thus, $F' - T'$ is either a vertical disc or is a vertical annulus of type (7) which contains two pod legs. T' was created from T by attaching pod legs to pod handles in the interior of F which were not adjacent to pod handles in F . If F' is a vertical annulus containing a pod handle, the pod handle is adjacent to two pod legs in F' and so if F' is a vertical annulus, then F is of type (7).

By the previous observations, we may assume that each component of $F - T'$ is a vertical disc with interior disjoint from T' . The closure of $(F - T)$ is obtained by removing a pod leg of $T' \cap F$ which is the only pod leg in F attached to a particular pod handle in F . Thus, F is of type (6), (7), or (8). \square

5.4. Frohman's Trick. We will frequently use a technique due to Frohman [F] for determining if a Heegaard splitting is stabilized. Informally, if a spine for the compressionbody on one side of a Heegaard surface for (M, T) contains a cycle which is contained in a 3-ball in $M - T$, then the Heegaard surface is stabilized. The version we will most often use is [HS1, Lemma 4.1]. We refer the reader to that Lemma for a precise description of how the trick works in our context.

6. THE COMPLEX R

6.1. The subgraphs of T . Suppose M is a compressionbody and T is a properly embedded graph so that $\partial_+ M - \mathring{\eta}(T)$ is isotopic to the frontier of a regular neighborhood of $\partial_- M \cup T$.

We divide T into the union of 3 subgraphs: T_0 , T_v , and T_s as follows: Since $\partial_+ M - \mathring{\eta}(T)$ is parallel to $\partial_- M \cup \partial \eta(T)$, T contains an elementary spine T_0 for M . Let T_v denote the components of $T - T_0$ that join $\partial_- M$ to $\partial_+ M$. Each component of T_v is a tree with one valence one vertex on $\partial_- M$. Let T_s denote $T - (T_v \cup T_0)$. Each component of T_s is a tree which joins T_0 to $\partial_+ M$. A component of T_s is called a **spoke**. (Informally, T_0 is a spine for M , T_v are vertical components, and T_s consists of "spokes".)

Notice that if $M = B^3$, then $T = T_s$ is a tree. In this case, we let T_0 be a vertex of T , or if T is a single edge, a vertex of valence 2 in the interior of the edge.

Figure 9 shows an example with T_0 a θ -graph in a genus two handlebody and every spoke a single edge. The graph T_0 is drawn with a thicker line.

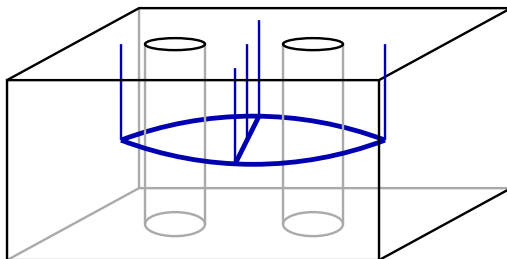

FIGURE 9. An example of the graph T in a genus two handlebody

Figure 10 schematically depicts two copies of a compressionbody M with ∂_-M a torus and ∂_+M a genus 2 surface. (In the picture, opposite sides of the cubes should be glued together.) On the left, T_0 consists of a single edge with both endpoints on ∂_-M . T_s is a single edge joining T_0 to ∂_+M and T_v consists of a tree with four interior vertices. It shows up twice in the diagram, since $T^2 \times I$ has been cut open into a square $\times I$. On the right, T_0 consists of two edges, one of which has a single endpoint on ∂_-M . T_s consists of two edges. One edge joins the interior vertex of T_0 to ∂_+M and the other joins the interior of the edge which forms the loop in T_0 to ∂_+M . T_v is the same as on the left.

6.2. **The complex R .** Suppose T satisfies the following conditions:

- (A) Each edge of T_0 with zero or two endpoints on ∂_-M has at least one spoke attached to its interior.
- (B) Each vertex of $T_0 - \partial T_0$ has a spoke attached to it.
- (C) Each component of ∂_-M is adjacent to at least one component of T_v .

In this case we can construct a complex R which has many useful properties, in particular $T \subset R$ and cutting M along R produces a collection of 3-balls. Our complex R generalizes the surface R in [HS1] and the surface \mathcal{R} in [HS2]. Our R is considerably more complicated than either of those

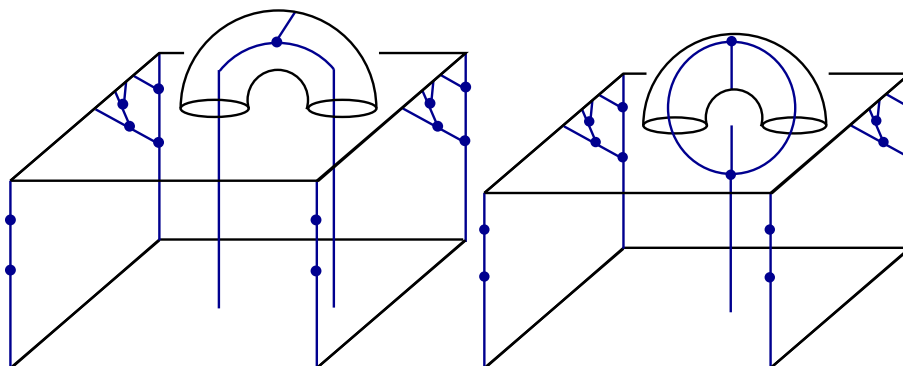

FIGURE 10. Two examples of a graph T in a compression-body M with ∂_-M a torus and ∂_+M a genus two surface. The vertical sides of each cube should have opposite faces identified.

surfaces, so it is recommended that the reader understand the constructions in [HS1] and [HS2] before tackling this construction. The case when M is a handlebody is also easier than when $\partial_-M \neq \emptyset$. The first time reader may want to concentrate on that situation. The figures below often (but not always) depict the situation when each spoke has a single edge. The situation when spokes have multiple edges is not significantly more complicated, so we avoid cluttering the figures with unnecessary detail. In describing the construction we will often isotope T . The isotopies described are always ambient isotopies which never move T through H .

Recall that if $M = B^3$, then $T = T_S$. In this case, let D be a properly embedded disc in M , containing T and let $R = D$.

If $M \neq B^3$, for each edge of T_0 with zero or two endpoints on ∂_-M and for each spoke adjacent to the interior of the edge choose a disc which intersects the edge in exactly one point, contains a spoke adjacent to the interior of the edge, and is otherwise disjoint from T . See Figure 11. Let D be the union of these discs. For each disc D' in D , choose a minimal path in $T_S \cap D'$ from $D' \cap T_0$ to $\partial D'$. Call this path the **distinguished path**.

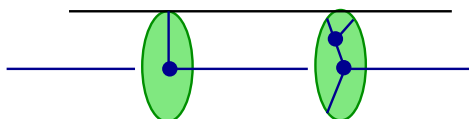

FIGURE 11. Two discs in D adjacent to a single edge of T_0 . Each contains a spoke. One spoke is a single edge and the other is a tree with four edges.

If $M \neq B^3$, boundary reducing M using D creates a 3-manifold which is the union of $M_0 = \partial_- M \times I$ and a collection of 3-balls. Let $\partial_+ M_0 = \partial_- M \times \{1\}$ and $\partial_- M_0 = \partial_- M \times \{0\}$. For a component M'_0 of M_0 , let $\partial_+ M'_0 = \partial M'_0 \cap \partial_+ M_0$ and let $\partial_- M'_0 = \partial M'_0 \cap \partial_- M_0$. Let D_+ denote the discs in D which are contained in $\partial_+ M_0$.

Each component of $T_0 \cap M_0$ is a tree with a single edge having an endpoint on $\partial_- M$. Let τ be a component of $T_0 \cap M_0$ and let h be the edge of τ with an endpoint on $\partial_- M$. Since $\partial_+ M_0$ is parallel to $\partial_- M \cup (T_0 \cap M_0)$, there is a properly embedded disc $E(\tau)$ with boundary in $\partial_+ M$ which is inessential in M_0 such that $E(\tau) \cap T = E(\tau) \cap h$ is a single point that separates the point $\partial h - \partial_- M$ from all other vertices of T on h . See Figure 12.

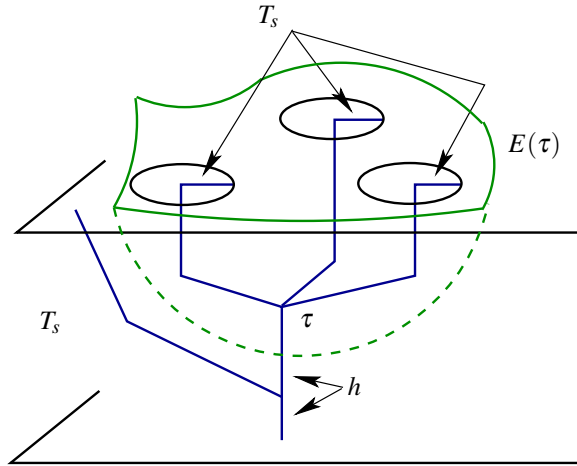

FIGURE 12. An example of the disc $E(\tau)$.

If M is a handlebody, let $\mathbf{E} = \emptyset$. Otherwise, let $\mathbf{E} = \bigcup_{\tau} E(\tau)$. Boundary reducing M using \mathbf{E} cuts off handlebodies U which are disjoint from $\partial_- M$. (If M is a handlebody, then $U = M$.) $T_0 \cap U$ is a graph which is isotopic into ∂U . Let A' be an embedded 2-complex which is the union of squares in U . A square of $A' - T$ has two edges in T and in most cases is a square of the form

$$\left(\text{edge of } (T_0 - T_s) \right) \times I.$$

The one exception is a square adjacent to some h . Such a square consists only of a (portion of h) $\times I$. We may isotope A' so that for each disc D' in D , $A' \cap D'$ is the distinguished path of $T_s \cap D'$. Each vertex of T_0 is adjacent to

a spoke. Isotope each of these spokes to lie in A' so that there is a minimal path in the spoke which is $(\text{vertex} \times I)$. Then $A' - T$ is the union of pairwise disjoint discs which meet in unions of edges of T . If $\partial_- M = \emptyset$ (i.e. if M is a handlebody) we let $A = A'$ and $R = A \cup D$. Notice that in this case, there is no edge h .

Recall that each square of $A' \subset U$ is of the form

$$\left(\text{edge of } (T_0 - T_s) \right) \times I.$$

Suppose that \tilde{A} is such a square that is not adjacent to an edge h of T_0 having one endpoint on $\partial_- M$. Then one edge of $\partial \tilde{A}$ lies on an edge of T_0 , two edges of $\partial \tilde{A}$ lie on distinct components of T_s , and one edge of $\partial \tilde{A}$ lies on $\partial_+ M$. \tilde{A} may contain edges of T_s in its interior. No edge of T_s interior to \tilde{A} has an endpoint interior to $T_0 \cap \partial \tilde{A}$.

Figure 13 depicts the complex R when M is a genus 2 handlebody and T_0 is a θ -graph.

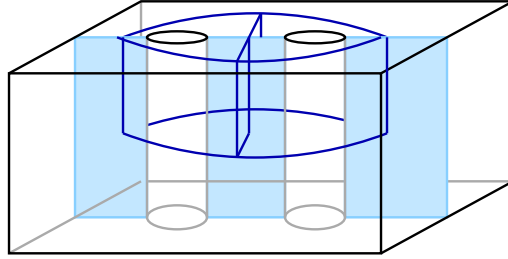

FIGURE 13. An example of the complex R in a genus 2 handlebody. The discs D are shaded. The complex A is outlined.

If $\partial_- M \neq \emptyset$ we still need to extend the squares of A' adjacent to an edge h of T_0 having an endpoint on $\partial_- M$ to a surface with boundary on $\partial M \cup T$. To that end, suppose that $\partial_- M \neq \emptyset$. Let M'_0 be a component of M_0 and let $g = \text{genus}(\partial_+ M'_0)$. Since M is a compressionbody, by construction, the complex $(A' \cup D) \cap \partial_+ M'_0$ is contained in a disc in $\partial_+ M'_0$. In M'_0 there exists, by assumption (C), a component of T_v . Choose a distinguished path p in this component from $\partial_- M'_0$ to $\partial_+ M'_0$ and perform an isotopy so that p is equal to $\{\text{point}\} \times I$ in M'_0 . Choose loops γ in $\partial_+ M'_0$ based at $p \cap \partial_+ M'_0$. If $\partial_+ M'_0 = S^2$, then γ should be a single loop cutting $\partial_+ M_0$ into two discs. If $\partial_+ M'_0 \neq S^2$, γ should cut $\partial_+ M'_0$ into a $4g$ -gon. There is a collection of vertical annuli P'_0 in M'_0 so that $P'_0 \cap \partial_+ M'_0 = \gamma$. The annuli intersect on p . Choose the curves γ and the annuli P'_0 to be disjoint from the remnants of

D_+ and \mathbf{E} . Also isotope P'_0 so that $P'_0 \cap T = T_v$ with the intersection of the annuli still p . Cutting M'_0 along P'_0 creates G which is a $(4g - \text{gon}) \times I$ if $\partial_+ M'_0 \neq S^2$ and otherwise is the disjoint union of two copies of $D^2 \times I$. Let $Z_{\pm} = G \cap \partial_{\pm} M'_0$. Thus, Z_- and Z_+ are each a $4g$ -gon. The polygon Z_+ contains $(A' \cup D) \cap \partial_+ M'_0$. See Figure 14 for an example with $g = 1$. Let P be the union of the P'_0 over all components M'_0 .

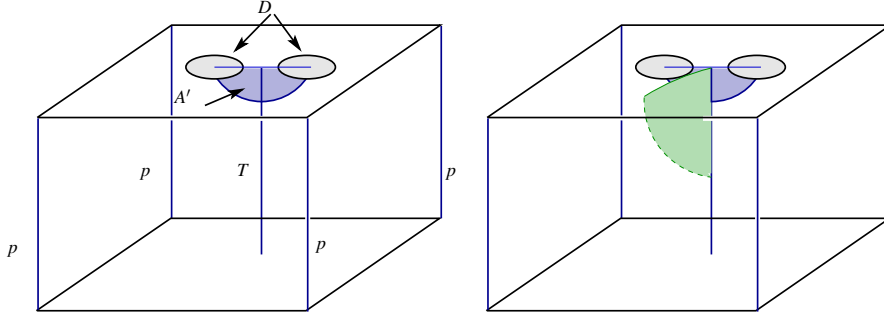

FIGURE 14. An example with $g = 1$. The first picture does not show the portion of $A' \cap G$ adjacent to h . The disc E is not pictured.

The complex A' contains portions of the edges of T_0 which have an endpoint on $\partial_- M$. We now extend A' to a complex which we write as $A \cup B$, so that T is contained in $A \cup B \cup D \cup P$. Let p_+ be a vertex of the polygon $Z_+ \subset M'_0$. Of course, p_+ is identified with $p \cap \partial_+ M'_0$ after gluing the $4g$ -gon together to obtain $\partial_+ M'_0$. Let p_- be the vertex of $p \cap Z_-$ so that in G there is a copy of p joining p_- to p_+ .

Consider an edge h of $T_0 \cap M'_0$ having an endpoint on $\partial_- M'_0$. In A' , there is one square having one side on a portion of h , one side on a spoke σ adjacent to the vertex $\partial h - \partial_- M$, and one side on $\partial_+ G'_0$. The fourth side of the square does not lie on either T or ∂G , but does lie in E . For such a square S , choose a path $\beta(S)$ joining the point $\partial \sigma \cap \partial_+ G'_0$ to p_+ , which contains the edge $S \cap \partial_+ G'_0$ and which is otherwise disjoint from A' . Let $B(h) = \beta(S) \times I \subset G'_0$ and let B be the union of the $B(h)$ for all $h \in T_0$.

Figure 15 shows an example of $G'_0 \cap (A \cup B)$ for a component G'_0 which is a square $\times I$. In this example, T_0 has an edge with a single endpoint on $\partial_- G'_0$.

Figure 16 shows an example of the surface B in a compressionbody M with $\partial_- M$ a torus and $\partial_+ M$ a genus 2 surface. In the picture, M has been cut

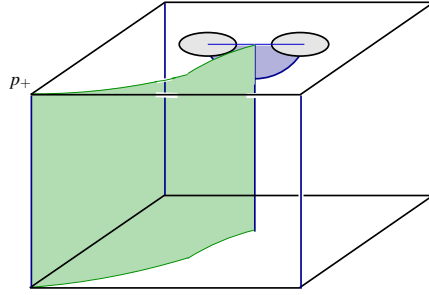

FIGURE 15. An example with $g = 1$. The blue surface is a portion of A , the green surface is a component of B .

open along P . In this example, T_0 is a single edge with both endpoints on $\partial_- M$.

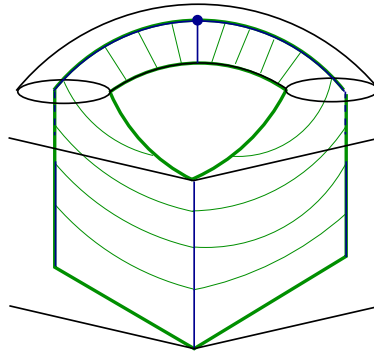

FIGURE 16. An example of the surface B when T_0 has an edge with both endpoints on $\partial_- M$.

Isotope any spokes adjacent to h so that they lie in B . Let $A = \text{cl}(A' - B)$ so that we may think of A as the union of squares each with three edges on T and one edge on $\partial_+ M$. These squares may contain edges of T_s in their interior. Let $R = A \cup B \cup D \cup P$.

Lemma 6.1. *The complex R has the following properties:*

- (1) $T \subset R$.
- (2) Each component of $R - T$ is a disc with boundary lying on $\partial M \cup T$.
- (3) $G = \text{cl}(M - R)$ is a collection of 3-balls containing copies of portions of R in their boundary.
- (4) R is T -incompressible and T - ∂ -incompressible.
- (5) No component of R is disjoint from T .

Proof. To see that the first claim is true, notice that each component of T_v is contained in some component of P , T_0 is contained in $A \cup B$, and the spokes in T_s were all isotoped to lie in $A \cup B \cup D$ depending on which edges or vertices of T_0 they were adjacent to.

The second observation is equally easy to see. Notice that each component of $R - T$ is a component of $A - T$, $D - T$, $B - T$, or $P - T$. We have already observed that the first statement is true for components of $A - T$. The statement is obviously true for components of $P - T$ since P is the union of annuli containing components of T_v . Each component of D and B is a disc and so the statement is also true for components of $D - T$ and $B - T$. See Figure 17 for a picture of $R \subset \partial G$ when M and T are the 3-manifold and graph from Figure 16. See Figure 18 for a picture of $R \subset \partial G$ when M and T are the 3-manifold and graph from Figure 15.

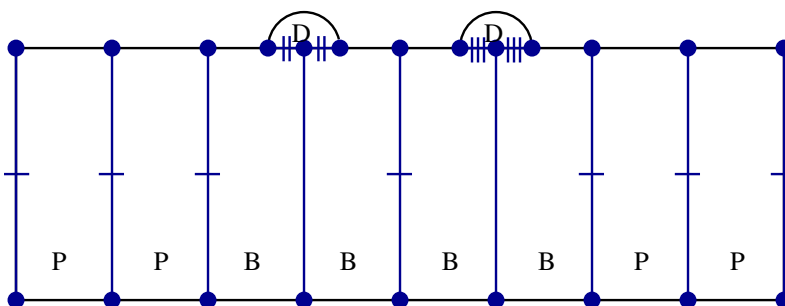

FIGURE 17. The complex R in ∂G when M is a compressionbody with $\partial_- M$ a torus and $\partial_+ M$ a genus 2 surface. The graph T_0 is a single edge with both vertices on $\partial_- M$. The left and right edges should be glued together so that $P \cup B$ is an annulus in ∂G . Edges with the same positive number of hash marks are identified in M . The edge with a single hash mark is the sole edge of T_v . The edges with two and three hash marks belong to T_s . Non-horizontal edges without hash marks are not glued to any other edges.

To see the third statement recall that a component of $M - (D \cup P)$ adjacent to $\partial_- M$ is a ball of the form $G'_0 = (4g - \text{gon}) \times I$. Each component of $(A \cap G'_0)$ is a disc with boundary on $\partial_+ G'_0 \cup T$. Each component of $A \cap G'_0$ is joined to a single (vertex $\times I$) by a square in B . Thus, $G'_0 - (A \cup B)$ is simply connected and so is a 3-ball containing portions of R in its boundary.

endpoints on ∂_-M . If $M = B^3$, we require that $\mathbf{I} = \emptyset$. Let $\mathbf{T} = T - \mathbf{I}$. Notice that H is a Heegaard surface for (M, \mathbf{T}) .

Proposition 7.1. *Suppose M does not have a vertical cut disc and suppose that H as a splitting of (M, \mathbf{T}) does not satisfy conclusions (1), (2), (5), or (6) of Theorem 3.1. Suppose also that no edge of T is perturbed and T satisfies conditions (A)-(C) in Section 6 and condition (NPH). Then one of the following occurs:*

- H is perturbed as a splitting of both (M, T) and of (M, \mathbf{T}) ; or
- T has a removable cycle.

Proof. Consider the complex R constructed in Section 6. Because R is T -incompressible and T - ∂ -incompressible, a T -compression or T -boundary compression of $R \cap C_1$ may be accomplished by an isotopy of R . We may, therefore, isotope R (fixing T and H) so that $R \cap C_1$ consists of surfaces of type (2) - (9) in the statement of Proposition 5.3. Out of all such isotopies of R , assume that R has been isotoped so as to minimize $|R \cap H|$. Notice that $R \cap C_1$ is T_1 -incompressible and T_1 - ∂ -incompressible. $R \cap C_2$ is T_2 -incompressible, but may be T_2 - ∂ -compressible.

The following sequence of lemmas will complete the proof.

Lemma 7.2. *If $R \cap C_1$ has a disc of type (2), then there exists a vertical cut disc for M . Furthermore, $R \cap C_2$ does not have a disc of type (2).*

Proof. Suppose that $R \cap C_1$ has a disc of type (2).

Case A: $R \cap C_2$ is T_2 - ∂ -compressible.

Because $R - T$ is the union of discs, the proofs of [HS1, Proposition 3.3] and [HS2, Proposition 3.3] show that $R \cap C_1$ does not have a disc of type (2). □(Case A)

Case B: $R \cap C_2$ is T_2 - ∂ -incompressible.

Let E_1 be the component of $R \cap C_1$ which is a disc of type (2). Let E_2 be the component of $(R \cap C_2) - T_2$ which contains ∂E_1 . Since E_2 is T_2 -incompressible and T_2 - ∂ -incompressible and since ∂E_1 is disjoint from T , E_2 is a surface of type (2), (7), or (8) from the statement of Proposition 5.3. Let $E = E_1 \cup E_2$. E is one of the following:

- (a) a sphere disjoint from T ,
- (b) a disc disjoint from T which intersects H in a single simple closed curve, or

- (c) a disc intersecting H in a single simple closed curve and which contains some number of pod handles in C_2 .

Since E is a component of $R - T$, it cannot be of type (a). Similarly, since T contains a spine for M and no component of R is disjoint from T , E cannot be of type (b). Therefore, E is of type (c). The only components of $R - T$ whose closures have all of their boundary contained in $\partial_+ M$ are discs in D . Thus, $E \subset D$. Each disc in D contains a single spoke, and therefore $D \cap T_0$ consists of a single point. A slight isotopy of D produces a vertical cut disc. \square (Case B)

Suppose that $R \cap C_2$ has a disc of type (2). Since $R \cap C_1$ is T_1 - ∂ -incompressible, an argument symmetric to that of Case B above produces a compressing disc for $\partial_- M$ in M . Since M is a compressionbody, this is impossible. \square

As M has no vertical cut-discs, we conclude that $R \cap C_1$ has no disc of type (2).

Let Q be an elementary spine of (C_1, T_1) . In Case 2 below, we will be deforming Q into a spine which may not be elementary. After such a deformation, we consider $Q = Q^1 \cup Q^2$ with Q^1 a graph and Q^2 the union of discs.

Think of C_1 as being a very small regular neighborhood of $Q \cup (\partial_- M \cap C_1)$. By hypothesis (NPH), Q does not contain any edges of T (i.e. pod handles). Since $R \cap C_1$ does not have a disc of type (2), $Q \cap R = \partial_1 Q \subset T$.

The next lemma will be useful at several points in upcoming arguments.

Lemma 7.3. *Let D' be a disc in D and suppose that $D' \cap C_2$ is T_2 - ∂ -incompressible. Let $x = D' \cap T_0$. The point x may be a vertex of T_s of valence 2 or more. Then $Q \cap D' \subset \partial_1 Q$ is a single point and one of the following occurs:*

- *the component of T_s contained in D' consists of a single edge and $\partial_1 Q \cap D' = x$.*
- *$T_s \cap D'$ has a single vertex not on $\partial D'$ and that vertex is x which has valence at least 3. Furthermore, $\partial_1 Q \cap D' = x$.*
- *$T_s \cap D'$ has two vertices not on $\partial D'$. One of those vertices is x and x has valence 2. The other vertex is the sole point of $\partial_1 Q \cap D'$.*

Proof. Let \tilde{D} be the closure of a component of $D' - T$. The surface $\tilde{D} \cap C_2$ has a portion of its boundary on $\partial_+ M \subset \partial_- C_2$ and also intersects T . It must, therefore, be a surface of type (4), (6), (7) or (8).

If $\tilde{D} \cap C_2$ is of type (4), then $D' = \tilde{D}$. Furthermore, $T_s \cap D'$ is a single edge which is disjoint from $\partial_1 Q$ except at the endpoint of $T_s \cap D'$ in the interior of D' . Hence, the first conclusion holds.

We may, therefore, assume that $\tilde{D} \cap C_2$ is a surface of type (6), (7), or (8). Suppose that $\tilde{D} \cap C_2$ is an annulus of type (7) or (8). In this case $\tilde{D} = D'$. Since $\tilde{D} \cap C_2$, in this case, has one circular boundary component on H and the other on $\partial_+ M$, $|\partial_1 Q \cap D'| = 1$. Furthermore, because there is exactly one component of $T_2 \cap (\tilde{D} \cap C_2)$ with an endpoint on H , and that component spans $\tilde{D} \cap C_2$, the point x is equal to $\partial_1 Q \cap D'$. Since $\tilde{D} = D'$, we conclude that $T_s \cap D'$ consists of a single edge and $\partial_1 Q \cap D' = x$.

Henceforth, we assume that for each disc $\tilde{D} \subset \text{cl}(D' - T)$, $\tilde{D} \cap C_2$ is a disc of type (6) or (8). Since $D' \cap T_0$ is a single point, x is the only valence one vertex of $D' \cap T_s$. Furthermore, since $T_s \cap D'$ is a tree, it is connected. Thus, $\tilde{D} \cap C_2$ is a disc of type (6) and not of type (8). This implies that no point of $T_s \cap D'$ is a vertex of valence one on the interior of D' . Also, if \tilde{D} is the closure of a component of $D' - T$, \tilde{D} is adjacent to exactly one point of $\partial_1 Q$. Since no edge of T with neither endpoint on ∂M lies entirely in C_2 , each edge of $T_s \cap D'$ with neither endpoint on $\partial D'$ contains at least one point of $\partial_1 Q$. Similarly, if e_1 and e_2 are edges in $T_s \cap D'$ sharing one endpoint and having their other endpoints on $\partial D'$, then there must be a point of $\partial_1 Q$ in $e_1 \cup e_2$. If x is a vertex of valence 2, for the moment cease considering it as a vertex of $T_s \cap D'$. Then, the hypotheses of Lemma A.1 (in the appendix) are satisfied with $T' = T_s \cap D'$ and $\mathcal{P} = \partial_1 Q$. Hence, $|\partial_1 Q \cap D'| = 1$ and $T_s \cap D'$ has at most a single vertex y not on $\partial D'$. Furthermore, if y exists, it is the sole point of $\partial_1 Q \cap D'$.

If x has valence 3 or more, then $y = x$, since y is the sole vertex of valence 3 or more on the interior of D' . \square

Corollary 7.4. *Suppose that $M \neq B^3$ and that D' is a disc in D such that $D' \cap C_2$ is T_2 - ∂ -incompressible. Then there exists a vertical cut disc, contrary to the hypotheses.*

Proof. By Lemma 7.3, D' intersects Q exactly once. Since $M \neq B^3$, the disc D' is an essential disc in M . By construction, $\partial D'$ lies on $\partial_+ M$ and D' intersects T_0 exactly once in the interior of an edge e of T_0 . A slight isotopy of D' off T_s produces a disc which is disjoint from T_s , intersects T_0 in a single point and intersects $H = \partial \eta(Q \cup \partial_- C_1)$ in a single simple closed curve. \square

We now consider two cases. The first is when $R \cap C_2$ is T_2 - ∂ -incompressible and the second is when $R \cap C_2$ is T_2 - ∂ -compressible.

Case 1: $R \cap C_2$ is T_2 - ∂ -incompressible.

In this case the closure of each component of $(R \cap C_2) - T_2$ is a surface of type (2) - (8). By Lemma 7.2 each component of $(R \cap C_2) - T_2$ is, in fact, a surface of type (3) - (8).

Lemma 7.5. *Either $M = B^3$ or $M = \partial_- M \times I$.*

Proof. If $D \neq \emptyset$, then for any disc D' in D , $D' \cap C_2$ is T_2 - ∂ -incompressible. If T_0 contains an edge, then (by construction of T_0 and R), there exists a disc D' in D with $\partial D'$ essential in $\partial_+ M$. Then by Corollary 7.4, there exists a vertical cut disc, contrary to the hypotheses of the Proposition. Thus, if $D \neq \emptyset$, T_0 is a single point. In which case, $M = B^3$, $T_s = T$, and $R = D$ is a single disc containing T_s . If $D = \emptyset$, then $M = \partial_- M \times I$. \square

Lemma 7.6. *If $M = B^3$, then either H is stabilized or $H - T$ is properly isotopic in $M - T$ to $\partial M - T$.*

Proof. If $M = B^3$ then T_0 is a single point x and $T = T_s$. $R = D$ is a single disc which contains T . By Lemma 7.3, $Q \cap R$ is a single point. G , which is the closure of $M - R$, consists of two 3-balls, each with a copy of T in its boundary. If Q has an edge, then there must be a cycle in $Q \cap G$. By Frohman's trick [HS1, Lemma 4.1], H is stabilized. Thus we may assume that Q is a single point. If T contains more than one edge, Q is the sole interior vertex of T . Whether or not T has more than one edge, $H - T$ is parallel in $M - T$ to $\partial M - T$. \square

We now turn our attention to the case when $M = \partial_- M \times I$. In this case, $T = T_v$.

Lemma 7.7. *Suppose that \tilde{P} is the closure of a component of $P - T$ adjacent to $\partial_- M$. Then $\tilde{P} \cap Q = \emptyset$.*

Proof. We may think of \tilde{P} as a square with two opposite sides on T , one side on $\partial_+ M$, and one side on $\partial_- M$. Suppose that $Q \cap \tilde{P} \neq \emptyset$.

If $\partial_- M \subset C_2$, then $\tilde{P} \cap C_2$ is a disc having at least three disjoint sub-arcs of its boundary on T and two subarcs on $\partial_- C_2$. However, no surface of type (2)-(8) has this property. (The surfaces of type (8) contain pod handles in their interior, not on their boundary.) Thus, $\partial_- M \subset C_1$.

If $\partial_-M \subset C_1$, then $\tilde{P} \cap C_2$ is a disc having at least two subarcs of its boundary on H , one subarc on $\partial_+M \subset \partial_-C_2$, and at least three subarcs on T . No such surface appears in the list from Lemma 5.3. \square

Corollary 7.8. *H separates ∂_-M from ∂_+M .*

Proof. Suppose to the contrary that $\partial_-M \subset C_2$. Let \tilde{P} be the closure of a component of $P - T$ adjacent to ∂_-M . By Lemma 7.7, $\tilde{P} \cap Q = \emptyset$. A path from ∂_+M to ∂_-M lying in $\partial\tilde{P} \cap T$ is a path in T_2 joining ∂_-C_2 to itself. This is an impossibility since T_2 is trivially embedded in C_2 . \square

Corollary 7.9. *$T_v = T$ is disjoint from Q and each component of T_v is an edge.*

Proof. Let ϕ be a path in T_v joining ∂_-M to ∂_+M which contains a vertex of T . If such a path exists, it is possible to choose ϕ so that it is contained in the boundary of \tilde{P} , the closure of a component of $P - T$ adjacent to ∂_-M . By Lemma 7.7, the edge of ϕ adjacent to ∂_-M is disjoint from ∂_1Q and is, therefore, a pod handle in C_2 . This is impossible by assumption (NPH). Thus, T_v contains no vertices.

Since component of T_v is an edge, each component is contained in the closure of a component of $P - T$ adjacent to ∂_-M ; by Lemma 7.7, each edge of T_v is disjoint from Q . \square

We now put the previous results together to obtain:

Corollary 7.10. *$H - T$ is properly isotopic in $M - T$ to $\partial_+M - T$.*

Proof. Recall that, by hypothesis, H is not stabilized. Since $Q \cap P = \emptyset$, an application of Frohman's trick shows that Q_G is either empty or is a tree with at most one endpoint on ∂_-M . By Corollary 7.9, T is disjoint from Q and so $Q = \emptyset$. Also, Corollary 7.9 shows that each component of $T_v = T$ is a vertical edge. Thus, $C_1 = \eta(\partial_-M)$. Since $M = \partial_-M \times I$, this implies that $H - T$ is properly isotopic to $\partial_+M - T$ in $M - T$. \square

We have shown, therefore, that the hypotheses of Case 1 imply that one of Conclusions (1), (5), or (6) of Theorem 3.1 occurs, contrary to the hypotheses of Proposition 7.1. This concludes Case 1.

Case 2: $R \cap C_2$ is T_2 - ∂ -compressible.

This case requires the all the technology of the proofs of the main results in [HS1] and [HS2].

Let D_1, D_2, \dots, D_n be the sequence of T_2 - ∂ compressions which convert $R \cap C_2$ into a T_2 - ∂ -incompressible surface. These T_2 - ∂ compressions may be accomplished by isotopies of R . Let R_i be the result of boundary-compressing R_{i-1} using the disc D_i beginning with $R_0 = R$. The boundary of each disc D_i is the endpoint union of two arcs α_i and δ_i with $\alpha_i \subset R_{i-1}$ and $\delta_i \subset H$. We may isotope each disc D_i so that each $\alpha_i \subset R$ and we may extend each D_i so that δ_i is a, possibly non-embedded, path in $\partial_- C_1 \cup Q$. Let Γ_i be the graph with vertices $\partial_1 Q$ and edges $\alpha_1, \dots, \alpha_i$.

Recall that G is the closure of $M - R$. G consists of 3-balls containing copies of R in their boundary. Let $\tilde{\Gamma}_i$ be the intersection of Γ_i with ∂G , so that $\tilde{\Gamma}_i$ contains two copies of each edge of Γ_i .

Suppose that G' is a component of G which is adjacent to $\partial_- M$. A **horizontal disc** in G' is a properly embedded disc E in G' with the following properties:

- if \tilde{P} is a copy in $\partial G'$ of the closure of a component of $(P \cup B) - T$ adjacent to $\partial_- G'$ then $E \cap \tilde{P}$ is a single edge joining distinct components of $\tilde{P} \cap T$.
- $D \cup A$ does not contain any edges of ∂E .
- If \tilde{B} is a copy in $\partial G'$ of a component of $B - T$, then $\partial E \cap \tilde{B}$ is connected and is the union of at most two edges. If $\partial E \cap \tilde{B}$ is a single edge, it joins $T_v \cap \tilde{B}$ to $T_0 \cap \tilde{B}$. If it is the union of two edges, one edge joins $T_v \cap \tilde{B}$ to $T_s \cap \tilde{B}$ and the second edge joins $T_s \cap \tilde{B}$ to $T_0 \cap \tilde{B}$.

Figure 19 depicts a horizontal disc in the case when $M = T^2 \times I$ and $T = T_v$ is a single vertical edge. If E is a horizontal disc such that there exists a component \tilde{B} of $B - T \subset \partial G'$ such that $E \cap \tilde{B}$ is the union of two edges, then we call E a **crooked** horizontal disc. Figure 20 depicts the two possible arcs in the boundary of a crooked horizontal disc.

We will soon be describing a sequence of deformations of the spine Q . Let Q_i denote the spine just after the i th deformation. The deformations will be designed so that, for small enough i , $Q_i \cap R = \Gamma_i$. Before any deformations, Q is an elementary spine and so contains no horizontal discs. The spine Q_i for $i \geq 1$, may not be an elementary spine. It will, however, be the union of

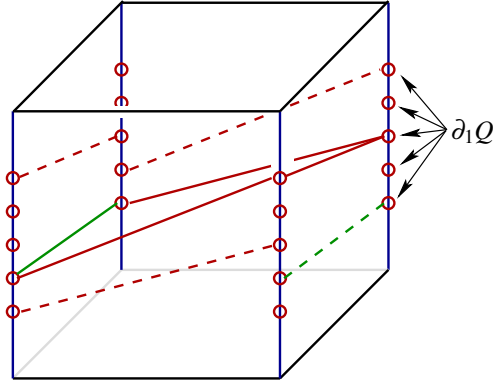

FIGURE 19. The solid edges outline a horizontal disc in G which is obtained from $M = T^2 \times I$. The graph $T = T_v$ is a single vertical edge. Since every edge of Γ_i appears twice in $\tilde{\Gamma}_i$, if the boundary of the horizontal disc lies in Γ_i , both solid and dashed edges will appear in $\tilde{\Gamma}_i$. If j is the smallest number such that $\tilde{\Gamma}_j$ contains the cycle which is the boundary of the horizontal disc, the green edge is α_j and is known as the last edge of the cycle.

horizontal discs Q_i^2 and a graph Q_i^1 . Let $Q_{Gi} = Q_i \cap G$, $Q_{Gi}^1 = Q_i^1 \cap G$, and $Q_{Gi}^2 = Q_i^2 \cap G$. The graph Q_{Gi}^1 contains two copies of each edge of Γ_i .

Define a boundary compressing disc D_i to be a **splendisc** (short for “splendid disc”) if:

- either $i = 1$ or D_{i-1} is a splendisc;
- we can slide the edges of $Q_{Gi}^1 - \Gamma_{i-1}$ and isotope D_i so that δ_i does not meet an edge of Q_{Gi} more than once; and
- if after performing the previous operations, δ_i is disjoint from $Q_{Gi}^1 - \Gamma_{i-1}$ then D_i is a horizontal disc.

If D_i is a splendisc, we always assume that the sliding and isotoping in the definition of “splendisc” have been performed. Let k be the largest number such that D_k is a splendisc.

We perform the i th deformation of Q along D_i for $i \leq k$ as follows:

- When δ_i meets an edge e of $Q - \tilde{\Gamma}_{i-1}$, we slide the edge e along the arcs $\delta_i - e$ and isotope along the disc D_i to push e in R . Then e is in place of α_i . We call this a **type (i)** deformation.
- If D_i is a horizontal disc, we extend Q along the disc D_i . We call α_i the **last edge** of D_i . This is a **type (ii)** deformation. See Figure 19.

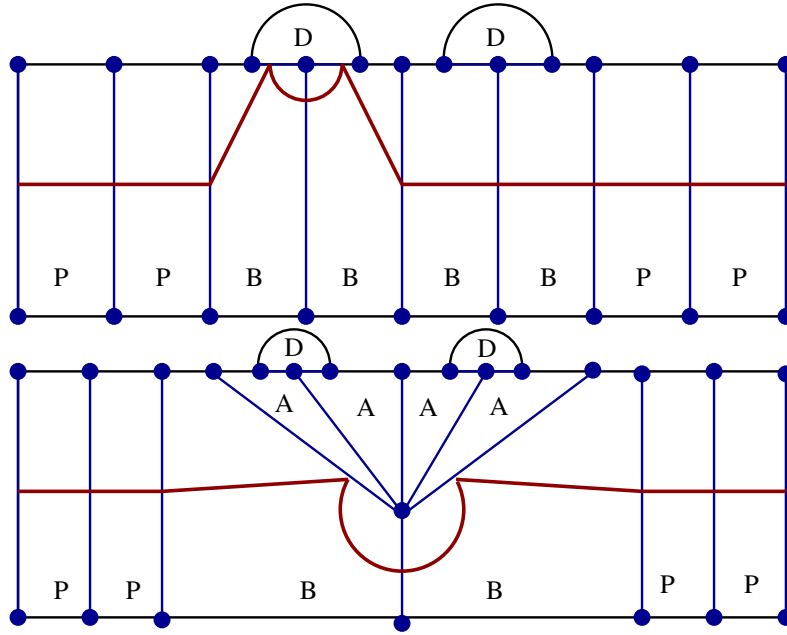

FIGURE 20. Two possible arcs in the boundary of a crooked horizontal disc.

Remark. We now embark on a study of the graphs $\tilde{\Gamma}_i$ for $i \leq k$. We will eventually conclude that all of the discs D_i are splendiscs (that is, that $k = n$.) A little more work will then show that Proposition 7.1 holds.

We begin with two definitions.

Suppose that τ is a component of $T_s \cap D$ embedded in a disc D' of D . Recall that τ is a tree and that $\partial D' \cap \tau \subset \partial \tau$ and at most one point of $\partial \tau$ is in the interior of D' . Let α be an arc in D' joining distinct points of τ with interior disjoint from τ . We say that α joins **opposite sides** of τ if the interior of the disc in D' bounded by α and a minimal path in τ contains the valence 1 vertex of τ in the interior of D' . If α does not join opposite sides of τ , we say that α joins **the same side** of τ . See Figure 21.

Suppose that in $R \subset \partial G$ there is an embedded disc E such that

- $\partial E \cap T$ consists of a single arc t and, possibly, isolated points
- the arc $\partial E - t$ in $R \subset M$ does not join opposite sides of a component of $T_s \cap D$
- $\partial E - t \subset (\Gamma_i \cup F)$ for some component F of $\partial_- C_1$

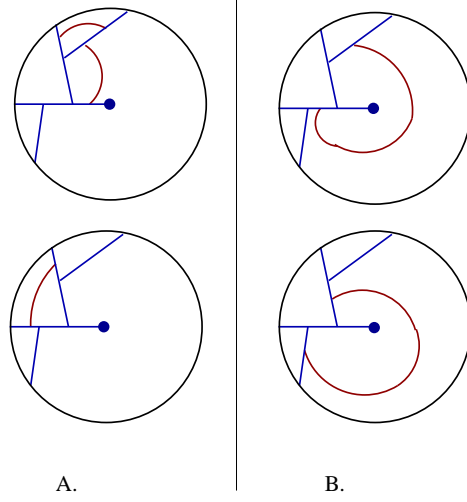

FIGURE 21. Examples of arcs in a disc of D . Figure A depicts arcs joining the same side of T and Figure B depicts arcs joining opposite sides of T .

- the interior of E is disjoint from $T \cup \Gamma_i$.

We call such a disc E , a **container disc** in Γ_i . Figure 22 shows some container discs which we will make use of later.

Lemma 7.11. *Suppose that, for some $i \leq k$, there exists a container disc E in Γ_i . Then $E_2 = E \cap C_2$ is a bridge disc for T_2 and there exists a disc $E_v \subset \eta(v)$ where $v \in \partial_1 Q$ lies on T_0 such that one of the following occurs:*

- $\{E_2, E_v\}$ is a perturbing pair for (M, T) . The interior of the arc $\partial E \cap T$ contains a vertex of $\mathbf{I} \cap T_0$.
- $\{E_2, E_v\}$ is a cancelling pair for (M, T) . T_0 consists of a single loop, T_s is connected, and M is a solid torus. The disc E is a subset of A .

Proof. Let v and w be the endpoints of t .

Case α : The arc t does not contain any vertices of $\partial_1 Q$ on its interior.

In this case, the disc E_2 is a bridge disc for $t \cap C_2$. There are discs $E_v \subset \eta(v) \subset C_1$ and $E_w \subset \eta(w) \subset C_1$ so that the pairs $\{E, E_v\}$ and $\{E, E_w\}$ are cancelling pairs for H as a splitting of (M, T) . See Figure 23.

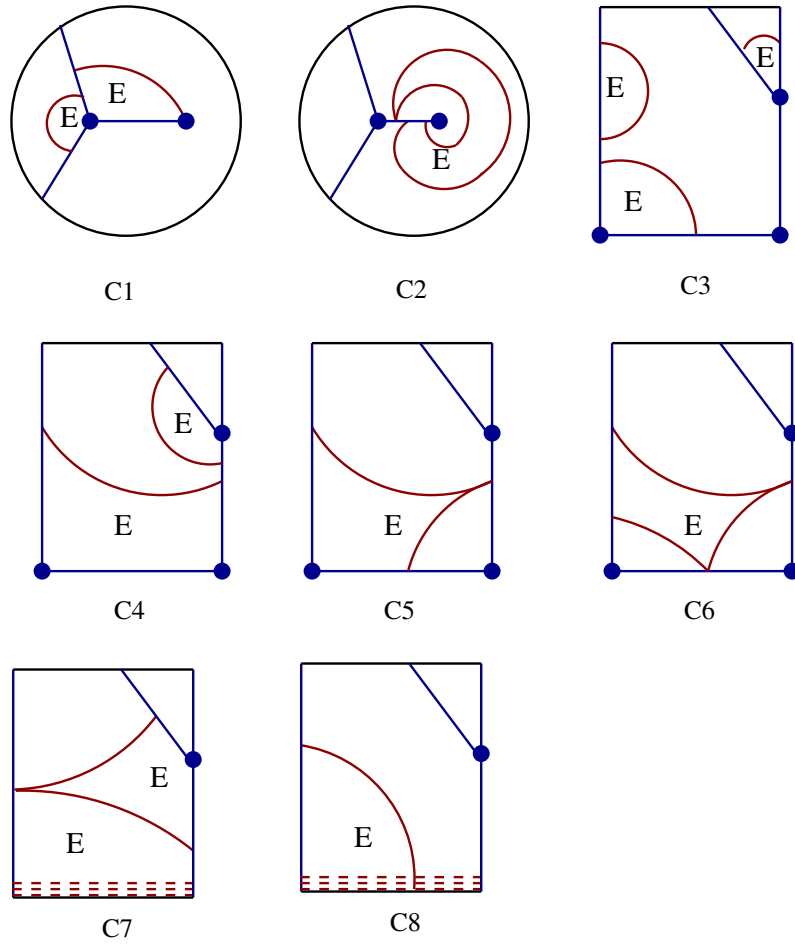

FIGURE 22. Each example of a container disc is labelled E . Diagrams C1 and C2 are in D . Diagrams C3 - C6 are in A . Diagrams C7 and C8 are in B or P . In diagrams C7 and C8, the dashed red lines mean that the component of $\partial_- M$ is in C_1 . This list of container discs is by no means exhaustive.

Suppose first that v and w are identified in M , so that $E_v = E_w$ and $\{E_2, E_v\}$ is not a perturbing pair for H as a splitting of (M, T) . This implies that $\partial E - t$ is not in D since then $\partial E - t$ would join opposite sides of a component of $T_s \cap D$. Since v and w are in the same component of the closure of $R - T \subset \partial G$, $\partial E - t$ lies in A , and v and w lie on a component of $T_s \cap A$ which appears twice in the same component of $A \subset \partial G$. By hypothesis (A) and (B) this implies that T_0 consists of a single loop and T_s is connected. This implies that M is a solid torus.

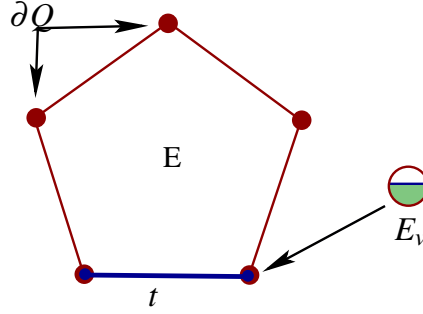

FIGURE 23. The disc E and the disc E_v are a cancelling pair of discs.

Assume that this does not occur. Hence, v is not identified with w in M and so both $\{E_2, E_v\}$ and $\{E_2, E_w\}$ are perturbing pairs for H as a splitting of (M, T) .

Suppose that neither v nor w lie on T_0 . Then either $t \subset T_s$, $t \subset T_v$, or an entire edge of $T_0 - T_s$ (and hence an entire edge of T) lies in t . This latter possibility cannot occur since an edge of T with neither endpoint on ∂M must intersect $\partial_1 Q$, and in Case α , we assume that t does not have any vertices of $\partial_1 Q$ in its interior. If $t \subset T_v$, then both v and w lie on T_v and $\{E, E_v\}$ and $\{E, E_w\}$ are perturbing pairs for (M, \mathbf{T}) . Likewise, if $t \subset T_s$, then either an edge of \mathbf{I} is perturbed, or H is perturbed as a splitting of (M, \mathbf{T}) . Thus, either v or w lies on T_0 and the interior of t intersects the interior of some edge e of T_0 . Without loss of generality, suppose $v \in e$. If v is an endpoint of e , choose E_v so that it is a bridge disc for $T_0 \cap C_1$.

If w lies on e , then $\{E_2, E_v\}$ is a perturbing pair for (M, \mathbf{T}) , contrary to the hypothesis. Thus, w lies on a component τ of T_s . If $\tau \notin \mathbf{I}$, then $\{E_2, E_w\}$ is a perturbing pair for (M, \mathbf{T}) , contrary to the hypothesis. Thus, $\tau \in \mathbf{I}$. Since $w \notin e$, t contains the vertex $\tau \cap T_0$ in its interior, as desired.

Case β : The arc t contains vertices of $\partial_1 Q$ in its interior.

This case should be compared to [HS1, Lemma 4.4] and [HS2, Lemma 4.6].

Let $v = v_0, v_1, \dots, v_m = w$ be the vertices of $\partial_1 Q$ lying in order on t . Let t_j be the arc between v_{j-1} and v_j , for $1 \leq j \leq m$. Notice that each $t_j \cap T_2$ is either a bridge edge or a bridge arc lying in a (possibly vertical) pod of T_2 . For the former, choose a bridge disc E'_j . For the latter, choose a pod disc E'_j containing t_j . Choose the set $\{E'_j\}$ so that the discs are pairwise disjoint and so that $\mathcal{E} = \bigcup_j E'_j$ intersects E in properly embedded arcs joining vertices of $\partial_1 Q$.

Isotope \mathcal{E} along edges of $\Gamma_i \cap \partial E$ so that no edge of $\mathcal{E} \cap E$ has an endpoint at a vertex of $\partial_1 Q \cap \partial E$ which is not on t . (See Figures 4.6 and 4.7 of [HS1, Lemma 4.4].)

Out of all such collections of discs, choose \mathcal{E} so that the number of edges $|\mathcal{E} \cap E|$ is minimal.

Suppose that there is an edge of $\mathcal{E} \cap E$ with both endpoints at the same vertex v_j . Let ρ be an outermost such edge. Let E' be the disc cut off from E by ρ which is disjoint from all vertices $v_{j'} \neq v_j$. Perform a surgery on \mathcal{E} along the disc E' and discard the component disjoint from T_2 . This reduces the number $|\mathcal{E} \cap E|$, contradicting the hypothesis that the number of edges of $\mathcal{E} \cap E$ was minimal. Thus, no edge of $\mathcal{E} \cap E$ has both endpoints at the same vertex.

Define an edge of $\mathcal{E} \cap E$ to be **good** if it joins adjacent vertices. Define a vertex v_j to be **good** if all edges adjacent to it are good.

Claim 1: No edge of $\mathcal{E} \cap E$ is a good edge.

Suppose that such an edge exists and let μ be an outermost good edge joining vertices v_{j-1} and v_j . Let E'_l be the disc in \mathcal{E} containing μ . Let ε_1 be the outermost disc in E which is bounded by μ . The arc μ divides E'_l into two discs, one of which, ε_2 , contains t_l . Then a slight isotopy of $\varepsilon_1 \cup \varepsilon_2$ produces a bridge disc for t_l which intersects E in fewer arcs than does E'_l . Notice that the disc E'_l is disjoint from all other discs in \mathcal{E} . Thus, $(\mathcal{E} \cup E'_l) - E'_l$ is a collection of bridge discs which contradicts the choice of \mathcal{E} . \square (Claim 1)

Claim 1 implies that a vertex is good if and only if there are no adjacent edges of $\mathcal{E} \cap E$.

Claim 2: There exists a good vertex of $\partial_1 Q$ on t which is not an endpoint of t . Furthermore, we can arrange that one of v or w , whichever we wish, is also a good vertex.

If $\mathcal{E} \cap E$ has no edges, every vertex of $\partial_1 Q$ on t is a good vertex. If such is the case, then since v and w are not adjacent vertices of $\partial_1 Q$, there exists a good vertex interior to t . Also, both v and w are good vertices. Suppose, therefore, that $\mathcal{E} \cap E$ contains edges.

Choose an outermost edge μ of $\mathcal{E} \cap E$ on E and let t' be the subarc of t which cobounds with μ an outermost disc E' . Think of E' as being a polygon with edges consisting of μ and those t_j which lie on t' . Since no edge of $\mathcal{E} \cap E$ joins adjacent vertices, E' has at least one vertex v_j which is not an endpoint of μ . Such a vertex is a good vertex and cannot be an endpoint of t .

Suppose, now, that we also wish for v , say, to be a good vertex. If e is an edge of $\mathcal{E} \cap E$ adjacent to v , we can push the end of e on v across the arc $\partial E - t$, to be an endpoint at w . After moving the endpoints at v of all edges of $\mathcal{E} \cap E$ over to w , v is a good vertex. This manœuvre does not change the fact that no edges are adjacent to v_j and so v_j is still a good vertex. \square (Claim 2).

Let v_j be a good vertex which is not an endpoint of t . Let D'_j be the disc $E \cap \eta(v_j)$. The pairs $\{E'_j, D'_j\}$ and $\{E'_{j+1}, D'_j\}$ are both perturbing pairs for H as a splitting of (M, T) .

Suppose that t lies in a component τ of T_s . If $\tau \notin \mathbf{I}$, then $\{E'_j, D'_j\}$ and $\{E'_{j+1}, D'_j\}$ are both perturbing pairs for (M, \mathbf{T}) . Suppose, therefore, that $\tau \subset \mathbf{I}$. If the point $\tau \cap T_0$ lies on t it must be an endpoint of t . Thus, v_j is not the point $\tau \cap T_0$. At least one of E'_j or E'_{j+1} does not contain the point $\tau \cap T_0$ in its boundary. Suppose, without loss of generality, that it is E'_j . Then $\{E'_j, D'_j\}$ is a perturbing pair for the edge τ . This also is a contradiction. Hence t does not lie in T_s .

A similar argument shows that t does not lie in T_v . Hence, the interior of t is not disjoint from T_0 . Let e be the edge of $T_0 - T_s$ which has interior not disjoint from t . If v_j does not lie on e , then one of t_{j-1} or t_j is entirely disjoint from e . Consequently, one of $\{E'_j, D'_j\}$ or $\{E'_{j+1}, D'_j\}$ is a perturbing pair for either an edge of \mathbf{I} or H as a splitting of (M, \mathbf{T}) . (Which it is depends on whether or not the component of T_s on which t_j or t_{j+1} lies is or is not in \mathbf{I} .) Both possibilities contradict our hypotheses. Thus, $v_j \in e$.

If v_j is an endpoint of e , then one of t_1 or t_m lies on T_s . Without loss of generality, suppose it is t_1 . Then v is a point on T_s which is not also on T_0 . By Claim 2, we may arrange for v to be a good vertex. Let $D'_v = E \cap \eta(v)$. Then $\{E'_1, D'_v\}$ is a perturbing pair for H as a splitting of (M, T) . Since t_1 is completely contained in T_s and since v does not lie on T_0 , $\{E'_1, D'_v\}$ is a perturbing pair for an edge of \mathbf{I} , if the component of T_s containing t_1 is contained in \mathbf{I} ; otherwise, $\{E'_1, D'_v\}$ is a perturbing pair for H as a splitting of (M, \mathbf{T}) . Thus, v_j is not an endpoint of e .

Since t does not lie in $T_v \cup T_s$, E must lie in either A or B . Suppose that v_{j-1} or v_{j+1} lies on T_0 . If v_{j-1} lies on T_0 , then $t_j \subset T_0$; and if v_{j+1} lies on T_0 , then $t_{j+1} \subset T_0$. In the former case, $\{E'_j, D'_j\}$ is a perturbing pair for H as a splitting of (M, \mathbf{T}) . In the latter case, $\{E'_{j+1}, D'_j\}$ is a perturbing pair for H as a splitting of (M, \mathbf{T}) . Thus, neither t_{j-1} nor t_j lies on T_0 , but v_j does lie on T_0 . This implies that E must lie in A , as every edge of $T_0 \cap B$ has an endpoint on $\partial_- M$.

The arc $\partial E'_j \cap T$ contains a vertex v' of $T_s \cap T_0$, since v_j is interior to e and v_{j+1} lies on T_s . The disc E'_j is a pod disc with at least two of the edges of $T_2 \cap E'_j$ incident to v' belonging to T_0 . Let E''_j be the closure of the component of $E'_j - T_2$ containing those two edges. Then E''_j is a bridge disc for a component of $T_0 \cap C_2$. Thus, $\{E''_j, D'_j\}$ is a perturbing pair for H as a splitting of (M, \mathbf{T}) . This contradicts our hypotheses. Thus, Case β cannot occur. \square

We next present a sequence of lemmas, applying Lemma 7.11 to the graphs $\tilde{\Gamma}_i$ in D, A, B , and P .

Lemma 7.12. *For $i \leq k$, any component of the intersection between $\tilde{\Gamma}_i$ and D is either a single point or a single edge joining distinct points on opposite sides of $T_s \cap D$.*

Proof. Suppose that the lemma is not true and let i be the smallest number for which the lemma fails. If $\tilde{\Gamma}_i$ contains an edge joining a point of $\partial_1 Q$ to itself, then since $\tilde{\Gamma}_i$ can be achieved by deformations of Q of types (i) and (ii), by Frohman's trick, H would be stabilized. Similarly, $\tilde{\Gamma}_i \cap D$ does not contain a closed loop.

Consider the following two possible configurations in Γ_i . (See Figure 22.)

- (C1) An edge of $\tilde{\Gamma}_i$ in a disc D' of D joins two vertices on the same side of $T_s \cap D'$.
- (C2) There are two edges e_1 and e_2 of $\tilde{\Gamma}_i$ sharing an endpoint and joining distinct points on opposite sides of $T_s \cap D'$.

One of these two configurations can be achieved by deformations of type (i) and (ii). In each configuration, there is an obvious container disc (labeled E in the figure). By Lemma 7.11, the arc component of $\partial E \cap T$ contains a vertex of $\mathbf{I} \cap T_0$. But in neither configuration is this the case. \square

Similarly,

Lemma 7.13. *Suppose that M is not a solid torus with T a core loop and single spoke. For $i \leq k_2$, any component of the intersection between $\tilde{\Gamma}_i$ and A containing an edge of $\tilde{\Gamma}_i$ lies in the closure \tilde{A} of a component of $A - T$ which is adjacent to the interior of an edge of T_0 and is one of the following:*

- (1) A single edge joining the edge $T_0 \cap \tilde{A}$ to a component of $\mathbf{I} \cap \tilde{A}$.
- (2) An edge joining distinct components of $T_s \cap \tilde{A}$. At least one of the components of $T_s \cap \tilde{A}$ is in \mathbf{I} .

- (3) *The union of two edges of type (1). The edges have their endpoints on T_0 in common, and this point is on the interior of the edge $T_0 \cap \tilde{A}$. The edges have their other endpoints on distinct components of $\mathbf{I} \cap \tilde{A}$.*
- (4) *The union of two edges. One of the edges is of type (1) and the other is of type (2). Both components of $T_s \cap \tilde{A}$ belong to \mathbf{I} .*

Proof. Suppose that the lemma is not true and let i be the smallest number for which it is not true. Let e be an edge of $\tilde{\Gamma}_i$ which lies in the closure \tilde{A} of a component of $A - T$. Let v and w be its endpoints.

Suppose, first, that \tilde{A} is not adjacent to the interior of an edge of T_0 . This could only happen if edges from T_s lie in the interior of a square of A . In fact, the endpoints of e must be contained on a component τ of T_s not in \mathbf{I} . The disc \tilde{A} has one arc of its boundary on $\partial_+ M$ and the complementary arc lies in τ . In the disc \tilde{A} , e cuts off a subdisc E which is disjoint $\partial_+ M$. By our choice of i , E is a container disc for Γ_i . By Lemma 7.11, $E \cap C_2$ is a bridge disc for a component of T_2 and the interior of $\partial E \cap \tau$ contains a vertex of $\mathbf{I} \cap T_0$. \tilde{A} contains at most one vertex x of $T_s \cap T_0$. Since $x \in \mathbf{I}$, the square of A containing \tilde{A} cannot have an edge of T_s interior to the square with endpoint x . Consequently, \tilde{A} must be adjacent to the interior of an edge of T_0 .

We think of the disc \tilde{A} as being a square with two edges lying in components of T_s , one edge on $\partial_+ M$, and one on T_0 . Let τ_1 and τ_2 be the components of $T_s \cap \tilde{A}$. The only way in which $\tau_1 = \tau_2$ is if M is a solid torus, and T is a core loop with a single spoke. Thus, we assume that $\tau_1 \neq \tau_2$.

The edge e cuts off a disc $E \subset \tilde{A}$ with boundary disjoint from $\partial_+ M$. If the disc E is a container disc for Γ_i , by Lemma 7.11, e is an edge of type (1). If E is not a container disc, it contains other edges. If e' is an edge of $\tilde{\Gamma}_i \cap E$ cutting off from E a disc E' disjoint from e , the disc E' is a container disc and so e' is an edge of type (1). One endpoint of e must be on the same component of $T_s \cap \tilde{A}$ as an endpoint of e' . This implies that one endpoint of e lies on \mathbf{I} and that e is of type (1) or (2). See (C3) and (C4) of Figure 22.

Suppose that $\tilde{\Gamma}_i \cap \tilde{A}$ has two edges e_1 and e_2 which share at least one endpoint. If these edges share both endpoints, then H is stabilized, a contradiction. Suppose that e_1 and e_2 share one endpoint v and that the other endpoints, w_1 and w_2 , respectively, are distinct. By the previous paragraph, both e_1 and e_2 are of type (1) or (2).

Suppose that they are both of type (1), but that $e_1 \cup e_2$ is not of type (3). Then v lies on a component of T_s . The edges $e_1 \cup e_2$ cut off a disc E from \tilde{A}

with $\partial E \cap T \subset T_0$. Since i is the smallest number for which the lemma fails, E is a container disc. This contradicts Lemma 7.11. Thus, if e_1 and e_2 are both of type (1), $e_1 \cup e_2$ is of type (3). See (C5) of Figure 22.

Suppose that e_1 , say, is of type (1) and e_2 is of type (2). The disc cut off from E by $e_1 \cup e_2$ which has boundary containing $e_1 \cup e_2$ is either a container disc or contains an edge e_3 of $\tilde{\Gamma}_i \cap \tilde{A}$ of type (1) with an endpoint on the component of $T_s \cap \tilde{A}$ containing w_2 . Thus, both components of $T_s \cap \tilde{A}$ belong to **I**. This implies that $e_1 \cup e_2$ is of type (4).

Suppose that both e_1 and e_2 are of type (2). Then, by our choice of i , they cut off from \tilde{A} a container disc E having $\partial E \subset T_s$. This contradicts Lemma 7.11.

Thus, the union of two edges sharing an endpoint is either of type (3) or (4).

Finally, suppose that a component contains three edges, e_1 , e_2 , and e_3 . Let $E \subset \tilde{A}$ be a disc cut off by $e_1 \cup e_2 \cup e_3$ which is disjoint from $\partial_+ M$ and which contains at least two of $\{e_1, e_2, e_3\}$. If e_1 , e_2 , and e_3 form a closed loop in \tilde{A} , then since these are all distinct edges in Γ_i , a meridian for any of these edges intersects ∂E in a single point, showing that H is stabilized. Thus, E is a container disc for Γ_i . However, the arc component of $\partial E \cap T$ lies solely in T_0 or T_s . This contradicts Lemma 7.11. See (C6) of Figure 22. \square

Lemma 7.14. *Suppose that $\tilde{A} \subset A$ is in a component of G adjacent to $\partial_- M$. Suppose that $\tilde{\Gamma}_i \cap \tilde{A}$ has a component which is either an edge of type (1) with neither endpoint in D , or of type (4), with neither endpoint in D . Then there exist bridge discs $E_1 \subset \tilde{A}$ and $E_2 \subset \eta(v)$ which form a perturbing pair for H as a splitting of (M, T) . The vertex v of $\partial_1 Q$ lies on T_0 . The interior of the arc $\partial E_1 \cap T$ contains a vertex of **I** $\cap T_0$.*

Proof. This follows directly from Lemma 7.11 and Lemma 7.13. \square

The proof of the next lemma is similar to the proof of Lemma 7.13 and so we omit it. The configurations (C7) and (C8) of Figure 22 are relevant for its proof.

Lemma 7.15. *For $i \leq k_2$, any component of the intersection between $\tilde{\Gamma}_i$ and B lies in the closure \tilde{B} of a component of $B - T$ adjacent to $\partial_- M$ and is one of the following:*

- (1) an edge joining distinct components of $T \cap \tilde{B}$
- (2) an edge joining the edge **I** $\cap \tilde{B}$ to the adjacent edge of T_0 .
- (3) the union of two edges, one of each of the above types.

Finally we turn to P . Again the proof is similar to the proof of Lemma 7.13 and so we omit it. As in the previous lemma, configurations (C7) and (C8) of Figure 22 are relevant for its proof.

Lemma 7.16. *For $i \leq k_2$, any component of the intersection between $\tilde{\Gamma}_i$ and P lies in the closure \tilde{P} of a component of $P - T$ adjacent to $\partial_- M$ and is an edge joining distinct components of $T_v \cap \tilde{P}$.*

We assemble the previous results to produce:

Lemma 7.17. *For $i \leq k$, if σ is a cycle in $\tilde{\Gamma}_i$ then either:*

- σ bounds a horizontal disc in G , or
- M is a solid torus, T consists of a core loop T_0 and a single spoke T_s , and σ consists of a single edge in A joining the vertex of T to itself.

Proof. Suppose, first, that M is a solid torus, and T consists of a core loop and a single spoke. Let j be the smallest such number such that $\tilde{\Gamma}_j$ contains a container disc. The existence of an edge in A is enough to guarantee that there exists a container disc. By Lemma 7.12, the container disc E is contained in A . By Lemma 7.11, $\partial E - T$ is an edge joining the vertex of T to itself. This edge appears twice in ∂G , and so $j = i$ and σ is the union of both copies of this edge. Henceforth, we assume that this does not occur.

Let G' be the component of G containing σ . Let E be a disc in G' with boundary σ . By sliding and isotoping Q , we may assume that Q is disjoint from the interior of E . (See the proof of the Claim in [HS2, Lemma 4.3].) Suppose that in Γ_i , σ runs across an edge e exactly once. Then E and a meridian of the arc e form a stabilizing pair for H . Since we are assuming that H is not stabilized, σ cannot run across any edge of Γ_i exactly once.

Suppose that at least one edge of σ lies in D . By Lemma 7.12, each such edge joins distinct points on opposite sides of $T_s \cap D$ and no two edges have endpoints in common. Choose e_0 to be an edge of σ lying in a component D' of D , chosen so that among all such edges e_0 is outermost. Let v and w be the endpoints of e_0 . Since no component of $\tilde{\Gamma}_i \cap D$ has more than one edge, there exist edges e_{-1} and e_{+1} in $A \cup B$ so that $v \in \partial e_{-1}$, $w \in \partial e_{+1}$, and $e_{-1} \cup e_0 \cup e_{+1}$ lies in σ . Since $v \neq w$ in Γ_i , the edges e_{-1} and e_{+1} are distinct in Γ_i . Furthermore, the components \tilde{A}_1 and \tilde{A}_2 of $(A \cup B) - T$ containing e_{-1} and e_{+1} are identified in M . Each component of $(A \cup B) - T$ appears exactly twice in ∂G . Let $e_j \in \{e_{-1}, e_{+1}\}$ be the edge which is closest to the edge $\tilde{A}_1 \cap \tilde{A}_2$. The cycle σ runs exactly once across e_j in M . Thus, E and a

meridian of e_j form a stabilizing pair of discs for H , a contradiction. Thus, D contains no edge of σ .

Suppose that A contains an edge of σ . Since D contains no edge of σ , σ must be contained in a component of G' adjacent to $\partial_- M$. The cycle σ has a subpath ρ contained in two adjacent components \tilde{A} and \tilde{A}' of $A - T \subset \partial G$ which are not identified in M . Thus, $\rho \cap \tilde{A}$ and $\rho \cap \tilde{A}'$ are components of $\tilde{\Gamma}_i \cap A$ satisfying the hypothesis of Lemma 7.14. Let $\{E_1, E_2\}$ and $\{E'_1, E'_2\}$ be the bridge discs in \tilde{A} and \tilde{A}' respectively provided by Lemma 7.14. See Figure 24. Notice that since $E'_1 \subset \tilde{A}'$, $\partial E'_1$ is disjoint from E_2 . Let $E = E_1 \cup E'_1$ and push E slightly off \mathbf{I} , so that E is a bridge disc for $T_0 \cap C_2$. Then $\{E, E_2\}$ is a perturbing pair of discs for (M, \mathbf{T}) , contrary to our hypothesis.

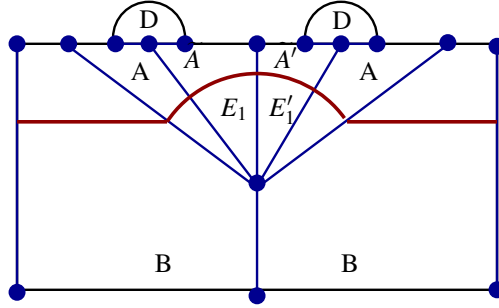

FIGURE 24. The bridge discs E_1 and E'_1 . The arc ρ is in red.

Thus, no edge of σ is contained in $A \cup D$. Suppose that $B \subset \partial G$ contains an edge of σ . Let $\rho \subset \sigma$ be a path in some component \tilde{B} of $B - T$. By Lemma 7.15, ρ appears as in Figure 19 or Figure 20. By Lemma 7.16, σ bounds a horizontal disc in G . \square

The next lemma is a slightly rephrased version of an amalgamation of Theorems 1.1 and 3.1 of [HS1, Theorems 1.1 and 3.1]. Its proof (in the spirit of [HS1]) follows easily from the technology developed so far.

Lemma 7.18. *If M is a solid torus and T is a core loop with a single spoke, then either H is perturbed as a splitting of (M, \mathbf{T}) or \mathbf{T} has a removable cycle.*

Henceforth we assume that if M is a solid torus, T is not a core loop with a single spoke.

Lemma 7.19. *For $i \leq k$, if σ is a cycle in $\tilde{\Gamma}_i$ then σ bounds a horizontal disc of Q_{G_i} .*

This proof of this lemma should be compared to [HS2, Lemma 4.3]. (Note the typographical error in the statement of that lemma: “vertical” should be “horizontal”.) In particular, we refer the reader to that lemma for some of the details of the argument.

Proof. By the proof of Lemma 7.17, σ bounds a horizontal disc E in G' which has interior disjoint from Q_G^1 . Since H is not stabilized, σ does not run across any edge of Γ_i exactly once. Let F be the component of $\partial_- M$ adjacent to the component of G containing E . If $F \neq S^2$, in M , E glues up to be a surface F^* parallel to F . If $F = S^2$, then in another component of G , there is a horizontal disc E' such that $E \cup E'$ is a 2-sphere F^* in M parallel to F . Let M' be the closure of the component of $M - F^*$ containing F . Notice that M' is homeomorphic to $F \times I$. If E is not a crooked horizontal disc, then $T \cap M'$ consists of vertical edges which are subsets of T_v . If E is a crooked horizontal disc, then $T \cap M'$ is the union of vertical edges and bridge edges. Each bridge edge is a subset of $\mathbf{I} \subset T$.

Perform surgery on H , using E . This cuts H into two surfaces. One of these surfaces H' lies in M' and is a Heegaard splitting for $(M', T \cap M')$. If E is not a crooked horizontal disc, then by [HS2], H' is either stabilized or trivial. If E is a crooked horizontal disc, then by [HS2], H' is either stabilized or trivial as a splitting of $(M', \mathbf{T} \cap M')$.

If H' is stabilized as a splitting of $(M', T \cap M')$ or $(M', \mathbf{T} \cap M')$ then H is stabilized as a splitting of (M, T) or (M, \mathbf{T}) . If H' is trivial of type II as a splitting of $(M', T \cap M')$ or $(M', \mathbf{T} \cap M')$, then H is stabilized as a splitting of (M, T) or (M, \mathbf{T}) . If H' is trivial of type I as a splitting of $(M', T \cap M')$ or $(M', \mathbf{T} \cap M')$ then H is boundary stabilized as a splitting of (M, T) or (M, \mathbf{T}) . Each of these possibilities contradicts our hypotheses. \square

Corollary 7.20. *$k = n$. That is, every disc D_i is a splendisc.*

Proof. Suppose that $k < n$ so that D_{k+1} is not a splendisc. Then δ_{k+1} contains an arc σ such that σ is a cycle in Q . By an isotopy of δ_{k+1} , we can assume that σ does not bound a horizontal disc or crooked horizontal disc in Q_G^2 . Thus, by Lemma 7.19, the cycle σ must contain an edge e of Q_G^1 . Then, by the proof of [HS1, Lemma 4.2], H is stabilized. \square

For the remainder, we assume that the n th deformation of Q has been performed, so that $R \cap C_2$ is T_2 - ∂ -incompressible.

Lemma 7.21. *D contains no edges of Γ_n .*

Proof. Let D' be a disc in D and let $x = D' \cap T_0$. Let $\tau = T_s \cap D'$. By Lemma 7.12, each edge of Γ_n joins distinct points on opposite sides of τ . If x is not of valence 1 in τ , then no edge in D joins opposite sides of τ . Thus, we may assume that x is a vertex of valence 1 in τ .

Case α : Suppose that $x \notin \partial_1 Q$.

If τ is not disjoint from $\partial_1 Q$, then the component of $\tau - \Gamma_n$ which contains x must be a pod leg in C_2 . This implies that the component of $\tau - \Gamma_n$ which contains x is a single edge of T_2 . Hence, the component of $D' \cap C_2$ containing x does not contain an adjacent pod handle. Thus, by Proposition 5.3, the component is a surface of type (3). This implies that there is an edge of Γ_n in D' joining one point to itself. This, however, contradicts Lemma 7.12. Thus, τ and D' are disjoint from $\partial_1 Q$. But D' is an essential disc in M and Q is a spine for M and so this is also an impossibility.

Case β : Suppose that $x \in \partial_1 Q$.

If D' contains an edge e of Γ_n , such an edge joins distinct points of τ . Choose e so that no point of $\partial_1 Q$ on τ which is an endpoint of an edge of Γ_n in D' is closer to x than an endpoint of e . Let $q \neq x$ be a point of $\partial_1 Q$ which can be joined by a minimal path $\rho \subset \tau$ to x with interior disjoint from $\partial_1 Q$. Let D'' be the closure of the component of $D' - (T \cup \Gamma_n)$ which contains ρ . The surface $D'' \cap C_2$ has at least one boundary component $(\partial\eta(x))$ lying completely on H . The other boundary component has one arc on T_2 and one arc on H . Such a surface does not appear in the conclusion to Proposition 5.3, and so D' does not contain an edge of Γ_n . \square

We are now in a position to conclude the proof of Proposition 7.1.

By Lemma 7.21, D contains no edges of Γ_n . Hence, before any deformations of Q , $D \cap C_2$ is T_2 - ∂ -incompressible. If T_0 has an edge, D contains a disc D' with boundary essential on $\partial_+ M$. By Corollary 7.4, D' is a vertical cut disc. This contradicts the hypotheses of the Proposition. Thus, T_0 has no edges and so either $M = B^3$ or $M = \partial_- M \times I$. If $M = B^3$, then $R = D$ and so we are not in Case 2, but rather Case 1 which has already been completed. Hence, $M = \partial_- M \times I$, $T = T_v$ and $R = P$.

Let \tilde{P} be the closure of a component of $P - T_v$. By Lemma 7.16, each component of $\tilde{P} \cap \Gamma_n$ containing an edge is a single edge joining distinct components of $T_v \cap \tilde{P}$. Suppose that e is such an edge, chosen so that out of all such edges it is the closest to $\partial_- M$. Let \tilde{P}_0 be the component of $\tilde{P} - \Gamma_n$ between e and $\partial_- M$. Consider, $\tilde{P}_0 \cap C_2$. If $\partial_- M \subset C_1$, $\tilde{P}_0 \cap C_2$ is a surface

which we can think of as a square having two edges on T_v and two edges on H . This surface is supposed to be T_2 - ∂ -incompressible, but it does not appear in the conclusion of Proposition 5.3. Thus, if $\partial_-M \subset C_1$, P contains no edges of Γ_n and so before any deformations of Q , $P \cap C_2 = R \cap C_2$ is T_2 - ∂ -incompressible. This was Case 1, which has already been completed. Consequently, we may assume that $\partial_-M \subset C_2$.

Suppose that \tilde{P} has a portion of its boundary on ∂_+M . Since $\partial_+M \cup \partial_-M \subset C_2$, by Proposition 5.3, \tilde{P} must contain an edge of Γ_n . In fact, the argument of the previous paragraph applied to a component \tilde{P}_0 between two adjacent edges in \tilde{P} shows that \tilde{P} contains exactly one edge of Γ_n . Examining the surfaces in the conclusion of Proposition 5.3, shows that, in fact, $\Gamma_n \cap \tilde{P}$ is that unique edge. (In other words, apart from the endpoints of the edge, there are no other vertices of ∂_1Q on \tilde{P} .)

We will now show that $\tilde{\Gamma}_n$ is a cycle in P if $\partial_-M \neq S^2$ and two cycles in P (one in each component of $P \subset \partial G$) if $\partial_-M = S^2$.

Suppose that a component τ of T_v has a vertex. Let v be a vertex of τ adjacent to the closure \tilde{P} of a component of $P - T$ with boundary on ∂_+M . Since \tilde{P} contains a single edge of Γ_n , and since every edge of T_2 has at least one vertex on ∂C_2 , v is the unique vertex of $\tau \cap \tilde{P}$. Let h be the edge of T_v with one endpoint on ∂_-M and the other endpoint at v . Let e be the edge $\Gamma_n \cap \tilde{P}$.

By assumption (NPH), h is not a pod handle of T_2 . Thus, h must contain a vertex of ∂_1Q . Since $h \subset \partial \tilde{P}$, h contains an endpoint of e . This implies that if $P' \neq \tilde{P}$ is the closure of a component of $P - T$ containing h , then the edge $\Gamma_n \cap P'$ and the edge $e \subset \tilde{P}$ share an endpoint. Notice also that if two components of $P - T$ are adjacent along a vertical edge of T_v , then the edges of Γ_n in those two components must also share an endpoint. Hence, Γ_n consists of a cycle and, possibly, vertices of ∂_1Q which lie in the boundaries of components of $P - T$ not adjacent to ∂_-M .

We return to the consideration of the vertex $v \in \tilde{P}$. Let P' be the closure of a component of $P - T$ containing v which is not adjacent to ∂_-M . P' cannot contain an edge of Γ_n and $P' \cap C_2$ must appear in the conclusion of Proposition 5.3. Thus, $\partial P'$ contains a single point of ∂_1Q . Choosing P' so that it is adjacent to \tilde{P} shows that that point must be v .

Let $D' \subset P$ be a disc such that $\partial D'$ is the union of an arc in ∂_+M and an arc in P which intersects h once and is otherwise disjoint from T . Construct D' so $T \cap D' \subset \tau$. Then $T' = \tau \cap D'$ satisfies the hypotheses of Lemma A.1 (in

the appendix), with $\mathcal{P} = \partial_1 Q$. Thus, by Lemma A.1, $\partial_1 Q \cap \tau = v$. Thus, $\tilde{\Gamma}_n \cap P$ is a single cycle if $\partial_- M \neq S^2$ and two cycles if $\partial_- M = S^2$.

By Lemma 7.19, each cycle of $\tilde{\Gamma}_n$ bounds a non-crooked horizontal disc in G . Since $\partial_- M \subset C_2$, C_1 is the regular neighborhood of a surface parallel to $\partial_- M$. This implies that H is not connected. This is not possible since H is a Heegaard surface. Thus, $M \neq \partial_- M \times I$. \square

8. THE PROOF OF THEOREM 3.1

Proof of Theorem 3.1 By Lemma 5.1, we can continue to assume that condition (NPH) is satisfied. The proof is by induction on $-\chi(\partial_+ M)$.

Case 1: M does not have a vertical cut disc.

If T satisfies (A)-(C) in Section 6, then the result follows from Proposition 7.1 by letting $\mathbf{I} = \emptyset$. Suppose, therefore, that T does not satisfy at least one of (A)-(C).

Let \mathcal{F} be the union of the components of $\partial_- M$ which are disjoint from T_v . Let \mathcal{V} be the union of vertices of T_0 which are disjoint from T_s . Let \mathcal{E} be the union of edges of T_0 with zero or two endpoints on $\partial_- M$ which are disjoint from T_s .

Lemma 8.1. *Either it is possible to form a new graph \hat{T} by adding disjoint edges to T so that (M, \hat{T}) satisfies the hypotheses of Theorem 3.1 and also assumptions (NPH) and (A) - (C), or T has a monotonic interior edge.*

Proof. For each component F of \mathcal{F} , let e_F be a vertical arc joining F to $\partial_+ M$. For each edge ε of \mathcal{E} let e_ε be an edge joining ε to $\partial_+ M$ which is vertical in the product structure on $M - \hat{\eta}(T)$. For each vertex v of \mathcal{V} , let e_v be an edge joining v to $\partial_+ M$ which is vertical in the product structure on $M - \hat{\eta}(T)$. Let T' be the union of all the e_F, e_ε , and e_v and let $\hat{T} = T \cup T'$. We need to show that T' can be chosen so that T' can be isotoped in the complement of T so that (M, \hat{T}) is in bridge position with respect to H . The isotopy is not allowed to move T .

The ‘‘Proof of Theorem 1.1 given Theorem 3.1’’ from [HS1], shows that this is possible for the edges e_F and e_v (with $F \subset \mathcal{F}$ and $v \subset \mathcal{V}$). Suppose, therefore, that ε is an edge in \mathcal{E} . If $\varepsilon \cap C_1$ or $\varepsilon \cap C_2$ contains a bridge arc, then attach e_ε to a bridge arc so that e_ε is not a perturbed edge. The arc e_ε can then be isotoped to be in bridge position. If ε does not contain a bridge arc, then it must be a monotonic interior edge. All the edges of \mathcal{E} belong to

T_0 , so the edge ε is an edge of T_0 with distinct endpoints and with neither endpoint on ∂M .

If \widehat{T} is defined, it is obvious that the hypotheses of Theorem 3.1 and assumptions (A) - (C) hold. Assumption (NPH) also holds, since no edge of $\widehat{T} - T$ has an endpoint on $\partial_- M$. \square

We also need to know that adding edges does not create any new vertical cut discs.

Lemma 8.2. *Let \widehat{T} be the graph formed from T by Lemma 8.1. If (M, \widehat{T}) has a vertical cut disc, then so does (M, T) .*

Proof. Suppose that D is a vertical cut disc for (M, \widehat{T}) . Let \mathbf{I} be the edges of \widehat{T} which are not subsets of T . If D intersects an edge of T , then D is a vertical cut disc for (M, T) . If D intersects an edge of \mathbf{I} , then D is a compressing disc for $\partial_+ M$, intersecting H in a single simple closed curve, which is disjoint from T . However, T contains a spine T_0 for M , and so T is not disjoint from any boundary compressing disc for $\partial_+ M$. \square

Let (M', T') be obtained from (M, T) by puncturing all interior monotonic edges. (See Section 5.2.) It is obvious that M' does not have any vertical cut discs, since M had no vertical cut discs. It is equally easy to see that since (M, T) satisfies (NPH), (M', T') does as well. Since T' has no interior monotonic edges, the graph \widehat{T} from Lemma 8.1 is defined. Assume that (M, \widehat{T}) is in bridge position with respect to H . Assume also that no edge of $\widehat{T} - T'$ is perturbed and that (M, \widehat{T}) satisfies the hypotheses (A)-(C) in Section 6. Applying Proposition 7.1 with $\mathbf{I} = \widehat{T} - T'$, \widehat{T} in place of T , and T' in place of \mathbf{T} , we conclude that Theorem 3.1 holds for H as a splitting of (M', T') . Hence, by Lemma 5.2, Theorem 3.1 holds for H as a splitting of (M, T) .

This concludes Case 1. In the next case we will apply the inductive hypothesis.

Case 2: There exists a vertical cut disc for $\partial_+ M$.

Let Δ be a vertical cut disc for $\partial_+ M$. Let M' be obtained from M by boundary-reducing using Δ . Let $T' = T \cap M'$ and notice that $|T' \cap \partial_+ M'| = |T \cap \partial_+ M| + 2$. Let H' be obtained from H by compressing along $\Delta \cap C_1$ and a slight isotopy to make it properly embedded.

Lemma 8.3. *There exists a vertical cut disc Δ such that H' is a Heegaard surface for (M', T') and assumption (NPH) is satisfied. Furthermore the disc component of $\Delta - H$ intersects T .*

Proof. Let $\Delta_i = \Delta \cap C_i$ for $i = 1, 2$ so that Δ_2 is an annulus and Δ_1 is a disc. Let $C'_i = C_i \cap M'$ for $i = 1, 2$. It is well-known that C'_i is a (possibly disconnected) compressionbody for $i = 1, 2$.

Claim: We may assume that $\Delta_1 \cap T \neq \emptyset$.

Suppose that $\Delta_2 \cap T \neq \emptyset$. Let τ_e be the edge of T_2 which intersects Δ_2 . Let τ be the component of T_2 containing τ_e .

Case (a): τ is a bridge edge, bridge pod, or vertical pod and τ_e is not a pod handle.

In this case, let E be a bridge disc containing τ_e in its boundary. Choose E so that out of all such bridge discs, $|E \cap \Delta|$ is minimal. An easy innermost disc/outermost arc argument shows that $\Delta_2 \cap E$ consists of a single arc γ joining the puncture $\tau_e \cap \Delta_2$ to $\Delta \cap H$. Let E' be a subdisc of E cut off by γ . If τ is a pod, choose E' so that it does not contain the vertex of the pod handle in its boundary. An isotopy of Δ across E' carries Δ to a disc Δ' intersecting H in a single simple closed curve. Furthermore, Δ' intersects T exactly once, in a point contained in C_1 .

Case (b): Either τ is a vertical edge or τ is a vertical pod, τ_e is the handle, and τ_e is adjacent to $\partial_+ M$.

In this case, Δ is a compressing disc for $\partial_+ M$ which is disjoint from the spine T_0 of M , an impossibility.

Thus, if $\Delta_2 \cap T \neq \emptyset$ then Δ_2 intersects a pod handle of T_2 adjacent to $\partial_- M$. This contradicts assumption (NPH). \square (Claim)

By the claim, $\Delta_1 \cap T \neq \emptyset$. Let C'_i be the compressionbodies into which H' separates M' . Since T'_2 is disjoint from Δ_2 it is not hard to see that T'_2 is trivially embedded in C'_2 . We show, therefore, that T'_1 is trivially embedded in C'_1 .

Let \mathcal{D} be a complete collection of bridge discs and pod discs in C_1 , chosen so as to minimize $|\mathcal{D} \cap \Delta_1|$. It is not hard to see that if D is a bridge disc in \mathcal{D} then either $D \cap \Delta_1 = \emptyset$, or D runs along the edge τ_e of T_1 intersecting Δ_1 . In this latter case, $D \cap \Delta_1$ consists of a single arc and $D - \Delta_1$ consists of two discs, each a bridge disc for an arc in T'_1 . Thus, each arc in T'_1 with both endpoints on H' has a bridge disc. A similar argument using vertical discs in C_1 in place of \mathcal{D} shows that if τ is the component in T_1 intersecting Δ_1 then Δ_1 cuts τ into two components, one of which is a vertical arc and one of which is a bridge edge or bridge pod. Any vertical edge or vertical pod disjoint from Δ_1 remains a vertical edge or vertical pod in C'_1 . Hence, T'_1 is trivially embedded in C'_1 .

Finally, we need to show that (M', T') satisfies (NPH). Consider an edge e of T_1 or T_2 adjacent to $\partial_- M$. Such an edge is not a pod handle of T since (M, T) satisfies (NPH). Every non-boundary vertex of T' is a vertex of T , and so if a component of e_- of $T \cap M'$ is a pod handle, e_- contains a vertex of T , implying that e_- is a pod handle of T' , a contradiction. Suppose, therefore, that e_- is an edge of T_1 or T_2 with an endpoint on H . If e is disjoint from Δ , then e does not become a pod handle in T' . If e intersects Δ , each component of $e - H'$ has an endpoint on H' and so no new pod handles are introduced. \square

Notice that if M'_0 is a component of M' , then (M'_0, T'_0) satisfies the hypotheses of Theorem 3.1 and $-\chi(\partial_+ M'_0) < -\chi(\partial_+ M)$. By the inductive hypothesis, since $-\chi(\partial_+ M'_0) < -\chi(\partial_+ M)$, we may assume that (M'_0, T'_0) satisfies one of Conclusions (1) - (6) of Theorem 3.1. Without loss of much generality, from now on we assume that M' is connected and consider H' to be a splitting of (M', T') . H can be reconstructed from H' by attaching a tube to the ends of two vertical arcs ψ_1 and ψ_2 in C'_2 .

Lemma 8.4. *If H' is stabilized or boundary-stabilized, then H is stabilized or boundary-stabilized.*

Proof. This is obvious from the construction. \square

Lemma 8.5. *Either T has a removable path disjoint from $\partial_+ M$ or, if H is not perturbed, it is possible to rechoose Δ so that H' is not perturbed.*

Proof. Let $\{D_1, D_2\}$ be perturbing discs with $D_1 \subset C'_1$ and $D_2 \subset C'_2$. Let ψ_1 and ψ_2 be the arcs in $T \cap C'_2$ which are glued together in M . Let τ_j be the component of $T \cap C'_1$ adjacent to ψ_j for $j = 1, 2$.

If D_1 is disjoint from $\psi_1 \cup \psi_2$ then H is perturbed. Assume, therefore that $\partial D_1 \cap H$ has one endpoint at $\psi_1 \cap H$. Notice that at least one of τ_1 or τ_2 must not contain a vertex of T as otherwise, an interior of edge of T would be disjoint from H , contradicting bridge position.

Claim (a): Suppose that τ_2 is a bridge edge or pod. Furthermore, suppose that there is a bridge disc D containing the edge of τ_2 adjacent to ψ_2 such that $\partial D \cap H$ has disjoint interior from $\partial D_2 \cap H$. Then either H is perturbed or T has a removable cycle.

In this case, the union of D with D_1 in M is a bridge disc for T_2 which intersects D_2 only at points of $T \cap H$. Thus, H is cancellable. In fact, if H is not perturbed, then the loop which is the closure of the union of $(\partial D \cup \partial D_1 \cup \partial D_2) - H$ is a removable cycle with the disc Δ playing the role of E in (RP3). \square (Claim (a)).

Claim (b): If τ_2 is a bridge edge or pod and if τ_1 is a bridge edge, then the hypotheses of Claim (a) hold.

By the proof of [ST4, Lemma 3.1] (cf. [TT, Lemma 8.6]) there exists a pod disc for τ_2 which is disjoint from $D_2 - T$. \square (Claim (b))

Claim (c): If τ_2 is a bridge edge or pod then either H is perturbed, or T has a removable cycle, or there exists a vertical cut disc Δ such that H' is not perturbed.

Suppose that H is not perturbed and that no cycle of T is removable. Suppose that E is a bridge disc containing e in C_2 . Isotope E so that it intersects Δ minimally. Then $E \cap \Delta$ consists of a single arc. Since H is not perturbed and since no cycle of T is removable, the interiors of the arcs $\partial E \cap H$ and $\partial D_2 \cap H$ intersect. Assume that E has been chosen so as to minimize the number of intersection points. The process of converting M to M' cuts E into two bridge discs, one of which is D_1 . Call the other one D . Assume that $\{D_1, D_2\}$ are a perturbing pair for H' .

Isotope Δ along the edge $D \cap H$ so that $\partial \Delta$ is moved past one intersection point of the interior of $D \cap H$ with the interior of $D_2 \cap H$. See Figure 25. Then after using this new Δ' to create M' , the pair $\{D_1, D_2\}$ is no longer a perturbing pair for H' . By the choice of E to minimize $|\partial E \cap \partial D_1|$, we are done unless $\{D, D_2\}$ is now a perturbing pair. This can only happen if the closure of $(\partial D_2 \cup \partial E) - H$ is a cycle. Since by Claims (a) and (b), τ_1 contains a vertex of T , τ_2 does not contain a vertex. Then applying Claims (a) and (b) with τ_1 and τ_2 reversed completes the proof of Claim (c). \square (Claim (c))

Thus, we may assume that τ_2 is not a bridge edge or pod. That is, τ_2 is a vertical edge.

Claim (d): Either H is perturbed or the component σ of T_2 adjacent to the point $\partial D_2 \cap H \cap T - \partial D_1$ is a vertical edge.

First, notice that τ_1 cannot contain a vertex of T , since then e would be a pod handle for T_2 adjacent to $\partial_- M$, contradicting assumption (NPH). Thus, τ_1 is a bridge edge. Suppose that σ is a pod or bridge edge. Then by the proof of Claim (b), there is a bridge disc E for σ such that $\{D_2, E\}$ is a perturbing pair for H' . Since E is disjoint from ψ_2 , $\{D_2, E\}$ is also a perturbing pair for H . Thus, σ must be a vertical edge. \square (Claim (d))

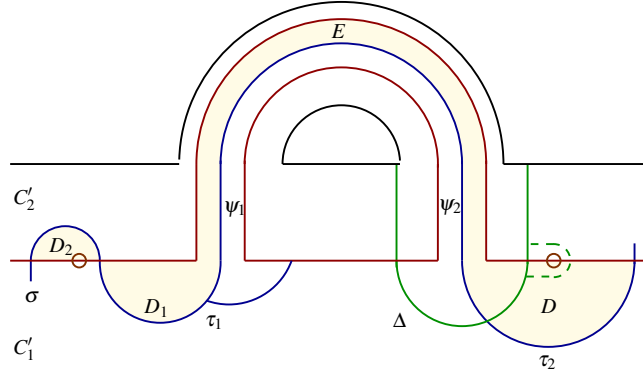

FIGURE 25. Isotope the disc Δ so that it envelopes one of the intersections between $\partial D \cap H$ and $\partial D_2 \cap H$. The intersection point is the hollow circle and the disc Δ' is formed from Δ by the dashed green isotopy.

We conclude by noticing that if H is not perturbed then $\zeta = e \cup \sigma \cup (\partial D_2 - H)$ is a removable edge. Since ψ_1 and ψ_2 lie in C'_2 , σ and τ_2 lie in C'_1 . In particular, the endpoints of ζ lie on $\partial_- M$ and so ζ is disjoint from $\partial_+ M$, as desired. \square

Lemma 8.6. *If T' contains a removable path, then that path is also removable in T .*

Proof. By the definition of removable path, the path is disjoint from $\psi_1 \cup \psi_2$. Therefore, it continues to be a removable path in T . \square

Lemma 8.7. *(M', T') and H' do not satisfy conclusions (5) or (6) of Theorem 3.1.*

Proof. Case a: M' is a 3-ball, T' is a connected graph with at most one vertex, and H' is the boundary of a regular neighborhood of that vertex.

In this case, a cycle of T would be disjoint from H , contradicting the definition of bridge position. \square (Case a)

Case b: $M' = \partial_- M' \times I$, and $H - \hat{\eta}(T)$ is isotopic in $M - \hat{\eta}(T)$ to $\partial_+ M - \hat{\eta}(T)$.

In this case, there would be a non-backtracking path in T starting and ending at $\partial_- M$ and remaining entirely inside C_1 . This contradicts the definition of bridge position. \square (Case b) \square

Combining the two previous lemmas we immediately obtain:

Corollary 8.8. *If (M, T) contains a vertical cut disc, then H and (M, T) satisfy one of conclusions (1) - (4) of Theorem 3.1.*

APPENDIX A. COMBINATORIAL LEMMA

Lemma A.1. *Suppose that T' is a finite tree containing at least one edge that is properly embedded in a disc D' . Suppose that \mathcal{P} is a finite nonempty collection of points on $T' - \partial T'$ such that the following conditions hold:*

- *If \tilde{D} is the closure of a component of $D' - T'$ then \tilde{D} contains exactly one point of \mathcal{P} in its boundary.*
- *Each edge of T' without an endpoint on $\partial D'$ contains at least one point of \mathcal{P} , possibly at one or both of its endpoints.*
- *If e_1 and e_2 are edges in T' , each with a single endpoint on $\partial D'$ and which share the other endpoint, then $e_1 \cup e_2$ contains at least one point of \mathcal{P} .*

Then $|\mathcal{P}| = 1$ and T' is either a single edge or has a single vertex not in $\partial T'$. Furthermore, in the latter case, the point in \mathcal{P} is the single vertex of $T' - \partial T'$.

Proof. We induct on $|\partial T'|$. If $|\partial T'| = 2$, then T' is a single edge and the lemma is obvious. We suppose, therefore, that $|\partial T'| \geq 3$. We will use the term **face** to denote the closure of a component of $D' - T'$. We begin with a

Key Observation: Suppose that p_1 and p_2 are distinct points in \mathcal{P} and that $\beta \subset T'$ is a path with interior disjoint from \mathcal{P} joining them. Then, since every edge of T' with neither endpoint on $\partial D'$ contains a point of \mathcal{P} , the interior of β can contain at most one vertex of \mathcal{P} .

Since $|\partial T'| \geq 3$, there are at least 3 distinct edges of T' with an endpoint on $\partial D'$ and no edge of T' has both endpoints on $\partial D'$. Consequently, every face of T' contains in its boundary at least two edges of T' having an endpoint on $\partial D'$. Since each face contains exactly one point of \mathcal{P} in its boundary, there must be an edge α of T' that has one endpoint on $\partial D'$ and that does not contain a point of \mathcal{P} in its interior. Let $\partial_0 \alpha$ be the endpoint of α not on $\partial D'$.

Claim: The point $\partial_0 \alpha$ is in \mathcal{P} .

Suppose not. Let \tilde{D}_1 and \tilde{D}_2 be the two faces of $D' - T'$ adjacent to α . Since T' is properly embedded in D' , $\tilde{D}_1 \neq \tilde{D}_2$. Let p_1 and p_2 be the points of \mathcal{P} contained in the boundaries of \tilde{D}_1 and \tilde{D}_2 respectively. These are distinct points. Let β be the path in T' joining them and notice that the interior of

β is disjoint from \mathcal{P} . By the key observation, $\partial_0\alpha$ is the sole vertex of T' contained in the interior of β . Push the interior of β off T' away from α to create a path β' . If the interior of β' is disjoint from T' then we have contradicted the hypothesis that each face of $D' - T'$ is adjacent to exactly one point of \mathcal{P} . Thus the interior of β' must intersect T' . As we travel from p_1 to p_2 along β' , let e be the first edge of T we encounter on the interior of β' . Notice that e has an endpoint at $\partial_0\alpha$ but that $e \neq \alpha$. See Figure 26.

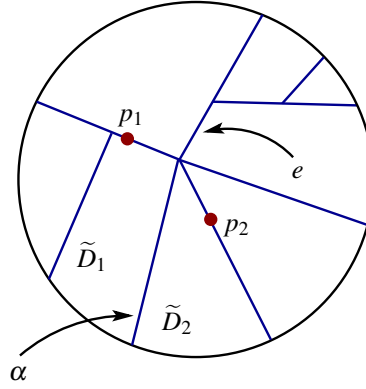

FIGURE 26. The edge e .

One face \tilde{D}_3 of $D' - T'$ contains both p_1 and e . Since p_1 is not in e and since \tilde{D}_3 contains exactly one point of \mathcal{P} , e does not contain a point of \mathcal{P} . Thus, e has one endpoint on $\partial D'$ and the other at $\partial_0\alpha$. Since α is disjoint from \mathcal{P} , $\alpha \cup e$ contradicts our assumption about \mathcal{P} . This contradiction shows that $\partial_0\alpha \in \mathcal{P}$. □(Claim)

Let T'' be the result of removing α from T' . If $\partial_0\alpha$ is a trivalent vertex of T' , it is no longer a vertex of T'' . T'' is a tree with $|\partial T''| < |\partial T'|$ since one endpoint of α is on $\partial D'$. By the claim, T'' and \mathcal{P} satisfy the hypotheses of the lemma. Hence, by induction, $|\mathcal{P}| = 1$ and T'' is either a single edge or T'' has a single interior vertex and that vertex is the sole point in \mathcal{P} . Since $\partial_0\alpha \in \mathcal{P}$, reattaching α to produce T' shows that T' also satisfies the conclusions of the lemma. □

REFERENCES

- [CG] A. J. Casson and C. McA. Gordon, *Reducing Heegaard splittings*, *Topology Appl.* **27** (1987), no. 3, 275–283, DOI 10.1016/0166-8641(87)90092-7. MR **918537** (89c:57020)
- [F] C. Frohman, *The topological uniqueness of triply periodic minimal surfaces in \mathbf{R}^3* , *J. Differential Geom.* **31** (1990), no. 1, 277–283. MR **1030674** (92e:53008)
- [G] D. Gabai, *Foliations and the topology of 3-manifolds. III*, *J. Differential Geom.* **26** (1987), no. 3, 479–536. MR **910018** (89a:57014b)
- [GST] H. Goda, M. Scharlemann, and A. Thompson, *Levelling an unknotting tunnel*, *Geom. Topol.* **4** (2000), 243–275 (electronic), DOI 10.2140/gt.2000.4.243. MR **1778174** (2002h:57011)
- [HS1] C. Hayashi and K. Shimokawa, *Heegaard splittings of the pair of the solid torus and the core loop*, *Rev. Mat. Complut.* **14** (2001), no. 2, 479–501. MR **1871309** (2003a:57038)
- [HS2] ———, *Heegaard splittings of trivial arcs in compression bodies*, *J. Knot Theory Ramifications* **10** (2001), no. 1, 71–87, DOI 10.1142/S021821650100069X. MR **1822141** (2002b:57019)
- [HS3] ———, *Thin position of a pair (3-manifold, 1-submanifold)*, *Pacific J. Math.* **197** (2001), no. 2, 301–324. MR **1815259** (2002b:57020)
- [L] T. Li, *Thin position and planar surfaces for graphs in the 3-sphere*, *Proc. Amer. Math. Soc.* **138** (2010), no. 1, 333–340, DOI 10.1090/S0002-9939-2010-10431-8. MR 2550199
- [S] M. Scharlemann, *Thin position in the theory of classical knots*, *Handbook of knot theory*, Elsevier B. V., Amsterdam, 2005, pp. 429–459, DOI 10.1016/B978-044451452-3/50010-1, (to appear in print). MR **2179267** (2006j:57022)
- [ST1] M. Scharlemann and A. Thompson, *Heegaard splittings of (surface) $\times I$ are standard*, *Math. Ann.* **295** (1993), no. 3, 549–564, DOI 10.1007/BF01444902. MR **1204837** (94b:57020)
- [ST2] ———, *Thin position and Heegaard splittings of the 3-sphere*, *J. Differential Geom.* **39** (1994), no. 2, 343–357. MR **1267894** (95a:57026)
- [ST3] ———, *Thin position for 3-manifolds*, *Geometric topology (Haifa, 1992)*, *Contemp. Math.*, vol. 164, Amer. Math. Soc., Providence, RI, 1994, pp. 231–238. MR **1282766** (95e:57032)
- [ST4] M. Scharlemann and M. Tomova, *Uniqueness of bridge surfaces for 2-bridge knots*, *Math. Proc. Cambridge Philos. Soc.* **144** (2008), no. 3, 639–650, DOI 10.1017/S0305004107000977. MR **2418708** (2009c:57020)
- [S] J. Schultens, *The classification of Heegaard splittings for (compact orientable surface) $\times S^1$* , *Proc. London Math. Soc. (3)* **67** (1993), no. 2, 425–448, DOI 10.1112/plms/s3-67.2.425. MR **1226608** (94d:57043)
- [TT] S. Taylor and M. Tomova, *Essential surfaces in (3-manifold, graph) pairs and levelling edges of Heegaard spints*, available at [arxiv:0910.3251](https://arxiv.org/abs/0910.3251).
- [T] M. Tomova, *Thin position for knots in a 3-manifold*, *J. Lond. Math. Soc. (2)* **80** (2009), no. 1, 85–98, DOI 10.1112/jlms/jdp009. MR **2520379** (2010g:57007)