

# High Renewable Energy Penetration Diesel Generator Systems

Professor Chemmangot V. Nayar  
*Curtin University of Technology*  
*Australia*

## 1. Introduction

Most small Island and remote communities around the world today are dependent on imported fossil fuels for most of their energy requirements. These communities are exposed to diesel fuel price volatility, frequent fuel spills and high operation and maintenance costs including fuel transportation and bulk storage. In addition to remote area power systems, commercial and residential customers in urban areas are also seeking new sources of backup power located on their premises. Diesel generators are a major source of backup power due to ease of transportation, installation and removal, as well as the mature and stable nature of the diesel industry with reliable suppliers. Having said this however, in the past decade, diesel prices have more than doubled. High fuel costs have translated into tremendous increases in the cost of energy generation. Diesel generators also a major source of pollution.

Renewable energy sources such solar photovoltaic (PV) and wind power are clean, affordable, readily available, and sustainable and can supplement generators in both grid connected and off-grid residential and commercial applications. Hybrid energy systems integrate these renewable energy technologies with diesel generators, inverters and batteries to provide grid quality power in remote areas not connected to a utility grid. Such an isolated grid is known as a Stand-alone Micro-Grid and is widely recognised as the remote area electrification technology for the 21<sup>st</sup> century.

The author has been involved in the development of off-grid remote area power systems over the past two decades. This paper presents case studies of micro-grid distributed generation systems using wind turbines, photovoltaic modules and details how an innovative variable speed diesel/ bio-diesel generator (HybridGen™) can be integrated into such systems.

## 2. Remote area power supply options

There are two general methods of supplying electricity to remote areas: grid extension and the use of diesel generators. Grid extension can be very expensive in many locations. Diesel generators are therefore the only viable option for remote area electrification. However, remote areas with relatively small communities generally show significant variation between the daytime peak loads and the minimum night-time loads. A typical example of a load profile of a remote community in Western Australia is shown below in Figure 1.

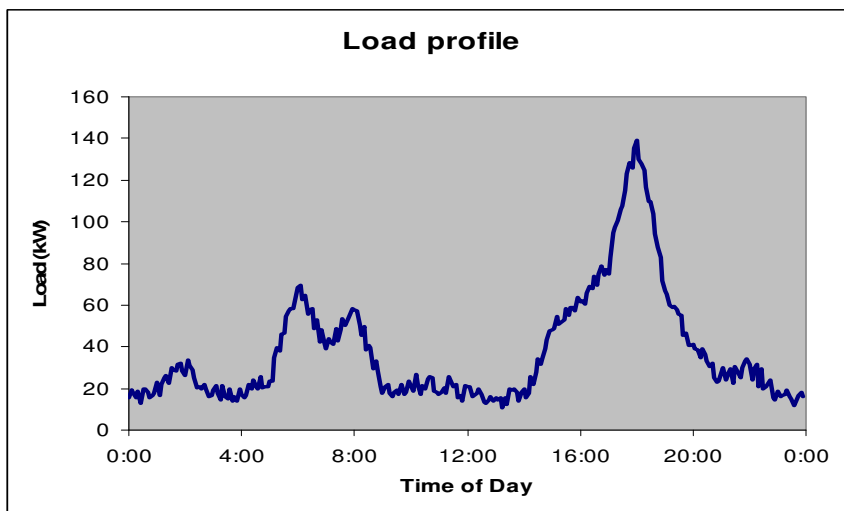

Fig. 1. Typical load profile of a remote community

Diesel-powered electric generators are typically sized to meet the peak demand during the evening but must run at very low loads during “off-peak” hours during the day and night. This low-load operation results in poor fuel efficiency and increased maintenance. The main problems of remote area power generation using diesel generators are:

- High cost of electricity due to increasing fuel and transportation cost.
- Air and noise pollution.
- Loss in diesel fuel efficiency and increased operation and maintenance cost due to incomplete combustion of fuel during light loads

The typical fuel consumption characteristic of a 50kVA diesel generator is shown in Fig. 2:

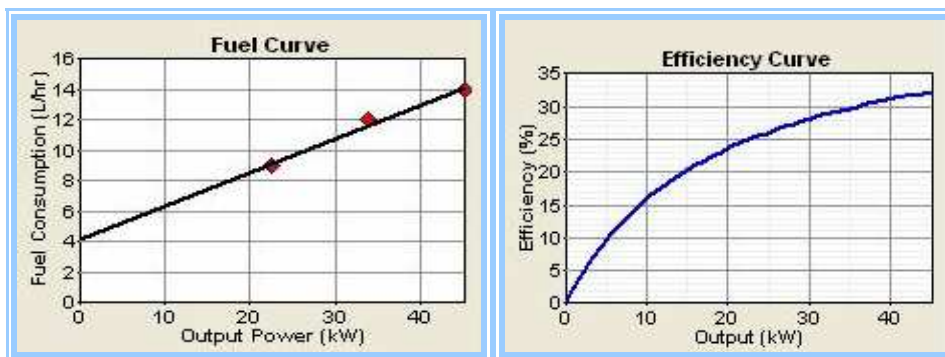

Fig. 2. Typical fuel consumption characteristics of diesel generator

In some remote locations, a dual diesel generator system is employed. When the load is light, the smaller generator is used; as the load increased, the manual switch is transferred to the larger generator. This approach results in some fuel savings, however managing this dual system is time consuming and impractical.

Another solution proposed and implemented in many parts of the world involves a battery/ diesel/ inverter hybrid system as shown in Figure 3. This hybrid system configuration allows all energy sources to supply the load separately at low or medium load demand, as well as supplying peak loads from combined sources by synchronising the inverter with the constant speed driven alternator output waveform. The bi-directional inverter can charge the battery bank (rectifier operation) when excess energy is available from the diesel generator, as well as acting as a DC-AC converter (inverter operation) when the diesel generator is switched off. The inverter may provide 'peak shaving' as part of a control strategy when the load demand exceeds the supply capacity of the diesel generator.

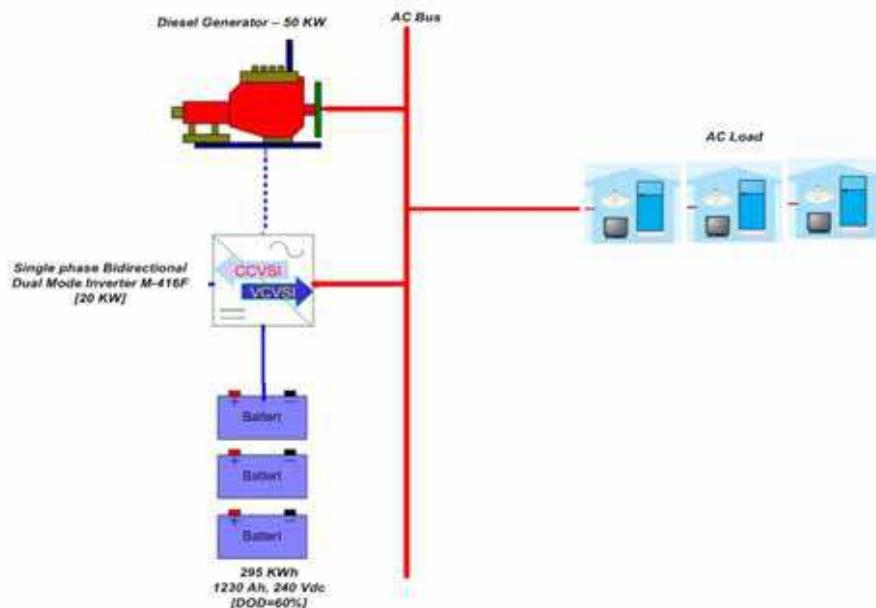

Fig. 3. Battery/ Inverter/ Diesel Generator hybrid system

The author was involved in the design and implementation of hybrid energy systems in many parts of the world. Two such case study examples are summarised in the following sections.

### 3. Case studies of Micro-Grid Systems

#### 3.1 Case Study 1: Wind/PV/Diesel Micro Grid System implemented in remote islands in the Republic of Maldives

The Republic of Maldives is an island nation consisting of 1,192 islands with a land area of about 300 km<sup>2</sup>, formed on a chain of 26 coral reef atolls in the Indian Ocean. The exact location of the country is to the west of Sri Lanka and south-west of India between latitudes 7° 06' 35" North to 00° 42' 24" South and longitudes 72° 33' 19" East to 73° 46' 13" East. The size of the archipelago is 753.6 km length and 118.2 km width of total area 999,702 km<sup>2</sup> including territorial sea. There are only 199 inhabited islands. Of the inhabited islands, 78 have populations less than 1,000 and 118 have populations between 1,000 and 4,000. Only four islands have populations in excess of 4,000. Around 80 percent of the total landmass of

the Maldives is less than 1 meter above sea level. Out of the 199 inhabited islands, just 24 islands including Male' have 24-hour, reliable and continuous power supply which is provided by the Government owned, State Electric Company (STELCO). On 26 December 2004 the Maldives experienced the worst natural disaster in the nation's history, when the disaster in the form of tsunami washed over the entire country claiming 82 lives and leaving 26 people missing and 15,000 homeless and displaced. The recovery and reconstruction work with the kind assistance of various donor agencies is being carried out by the Government of Maldives. After the tsunami, the state of electricity supply has changed because many power houses and generators were among the destroyed infrastructure. Some islands with 24-hour supply before tsunami are now supplying only for 12 hours from 6.00PM to 6.00AM.

The electricity in the Maldives is exclusively produced by diesel generators run on every inhabited island. With the rising price of fuel, the production of electricity has become prohibitively expensive; making the renewable energy sources an appropriate alternative for the authorities to reduce the dependency on fossil energy as they are also concerned about global warming impact on sea level. Trade winds and abundant sun are two energy sources on which Maldivian authorities are focusing for electricity production in the islands. A renewable energy power plan was proposed to implement through a program of deployment of solar and wind systems in stand-alone systems and with mini-grid distribution village power for the islands in the Republic of Maldives. The Plan will cover approximately 120 islands in the Northern and Central atolls, servicing a total of around 100,000 persons. The systems will augment diesel AC distribution grids with wind energy of approximately 80% energy offset for village power. Off-grid systems will provide electricity to individual homes supplying them with 100% of their electricity needs and the entire program will roll out over about a 7 year period.

The author led a feasibility study in 2007. to examine the technical, socioeconomic and financial factors concerning island electrification, in accordance with the objectives of the Maldives Renewable Energy Power Plan, by concentrating initially on 3 islands. The scope of work of the feasibility included:

- To assess and map the available renewable energy resources (wind and solar) and evaluate their potential as options for remote island electrification in Maldives.
- Undertake a technical study
- to confirm power and energy requirements
- determine sites for the wind turbines
- Specify equipment requirements.
- determine how the small wind power generators could be integrated to the grids
- determine the foundation aspects of the wind turbines
- determine the voltage and frequency window of the power electronic interface of the wind generators and any impact of voltage and frequency fluctuations on the stability of the system
- how the surplus power could be utilised
- height and size or approximate quantity of turbines needed
- where batteries and the mini grid to be located on the island
- likely capital, and operation and maintenance costs
- life cycle cost of the hybrid system versus diesel power
- technical personnel required to operate and maintain the system

- Investigate Demand Side Management options (use of energy saving devices, load limiting devices and consumer education so that energy inputs are minimized and cost savings maximized. This can be carried out with sensitivity to the consumer needs whilst preventing energy wastage and excess consumption.
- Design and predict performance of the proposed combined small wind generator, photovoltaic , battery, diesel hybrid system
- Prepare detailed specifications including remote monitoring and communication
- To conduct feasibility studies in three selected islands considering the technical, economic and financial, social and environmental impacts of solar/ wind based hybrid electrification systems in order to undertake successful implementation of a sustainable energy rollout plan covering a number of islands.

The three islands selected for the preliminary study were:

Location	Atoll	Latitude	Longitude
Uligam Island	HA Uligam	7° 05' N	72° 55' W
Raimandhoo Island	S. Meemu Atoll	3° 05' N	73° 40' W
Kondey Island	South Huvadhoo Atoll	0° 40' N	73° 50' W

A standard approach was made at each site for the collection of the necessary data to assess what was possible at each of the sites. The methodology use is listed below.

- Meet with the island chief and community leaders, discuss island issues, development plans and other aspects relevant to the energy consumption of the island
- Undertake power quality measurement at the power house to measure voltage, frequency and harmonics over a period of time
- Measure the instantaneous load to identify any problematic loads with high starting currents or large demands
- Survey buildings for the potential of supporting PV arrays on the roof. This includes checking orientation, slope and potential shading issues.
- Survey the island for locations of the wind turbines taking into account the most prevalent wind direction onto the island, the distance from the power house, and the height of vegetation around the turbines.
- Undertake renewable energy system planning using the software tool HOMER and to analyse the various options paying particular attention to the cost per unit of electricity consumed, fuel saved and initial capital requirements.

Based on the above study, it was decided to implement a micro-grid hybrid distributed generation system combining several small scale wind generators, solar photovoltaic panels, battery storage, advanced power electronics equipment and existing diesel generators. The system architecture employed in the hybrid micro-grid system is “AC Coupled” whereby the renewable energy sources and the conventional diesel generators all feed into the AC side of the network as shown in Figure 4.

Figure 5 shows an aerial view of the northern island known as Uligam. The wind resource information was sourced from a report prepared by the National Renewable Energy Laboratories (NREL) in the USA which gives various maps of the Maldives showing the wind resource potential [4]. Figure 6 shows the wind resource map of the three locations selected for the pilot installation in the country. The wind map shows the highest resource in the north-central part of the Maldives just north of the capital of Male, from 4.5° north

latitude to  $6.5^\circ$  north latitude. The level of resource in these areas is considered good for small-scale village applications. The wind resource gradually decreases from Male southwards with the lowest resource found on the atolls south of  $1^\circ$  north latitude. Figure 7a gives an overview of the wind resource at the three locations. The solar resource for this study is obtained from NREL and NASA data and is shown in Figure 7b.

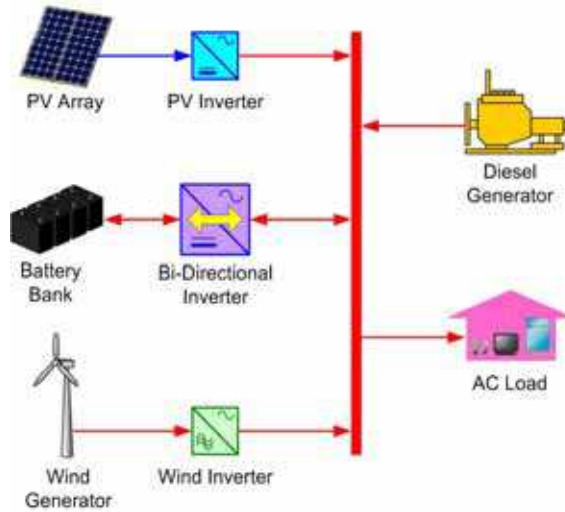

Fig. 4. Hybrid system schematic diagram showing renewable energy sources coupled to the ac side



Fig. 5. Aerial view of the Uligama island

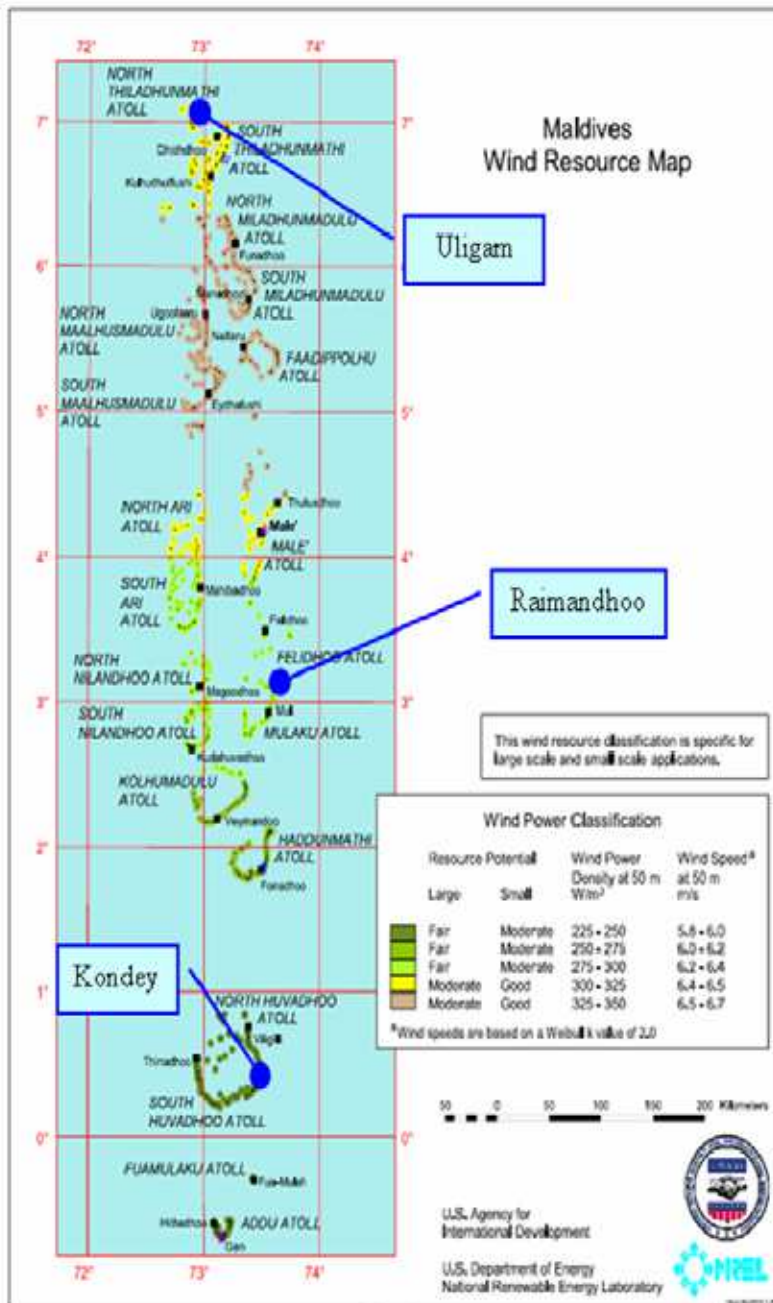

Figure 6-1

Fig. 6. Wind power resource and the selected islands

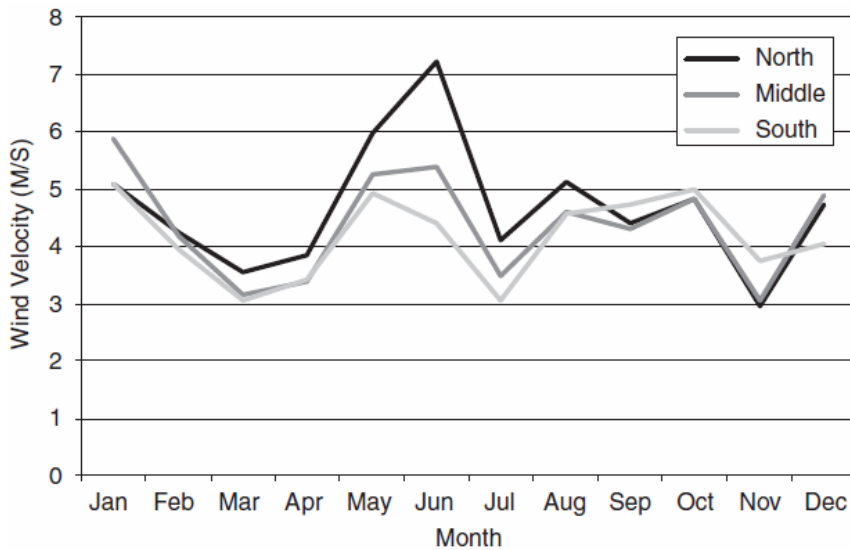

Fig. 7.a Wind resource map for selected locations for pilot installations in Maldives

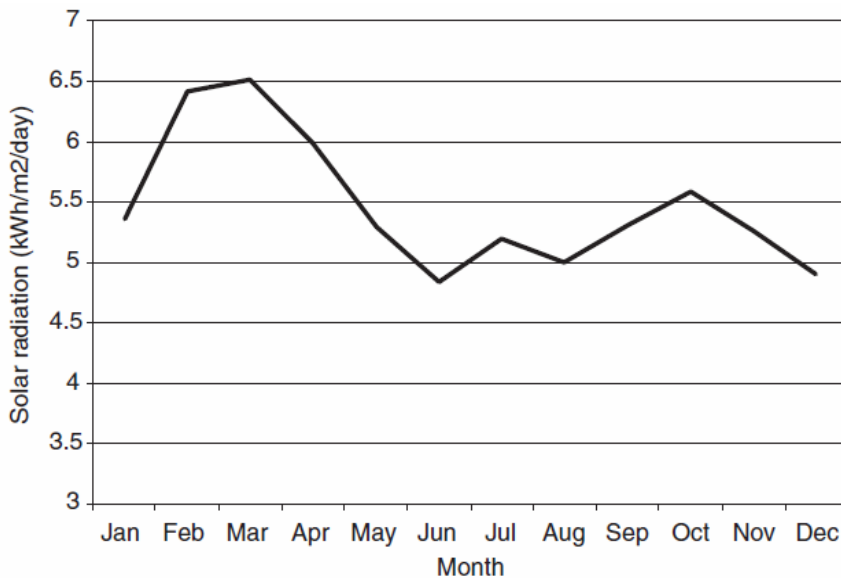

Fig. 7.b Solar radiation levels for locations of pilot installations in Maldives

The existing electricity power generation using diesel generators in every island was reviewed. The intention was to establish how much if any upgrade to the local island power station or its distribution system would be required for the implementation of a renewable energy system on the island. Fig. 8 shows photographs of the diesel power stations in two of the islands.





Fig. 8.a - Uligam power house



Fig. 8.b - Raimandhoo power house

Detailed power quality monitoring was carried out using Fluke Power Quality Analyser and storing the data in a computer. The system voltage and frequency variation were

determined as well as any peak demand requirement that may highlight problematic loads. The results show that the power system is typical of small diesel generated electricity supplies with voltage variations at the main bus of +10% to -12% and frequency variations of as much as  $\pm 3$ Hz. Figure 9a shows the voltage and line current of the diesel generator measured by the power quality meter. Figure 9b and c shows the variation of frequency and voltage .

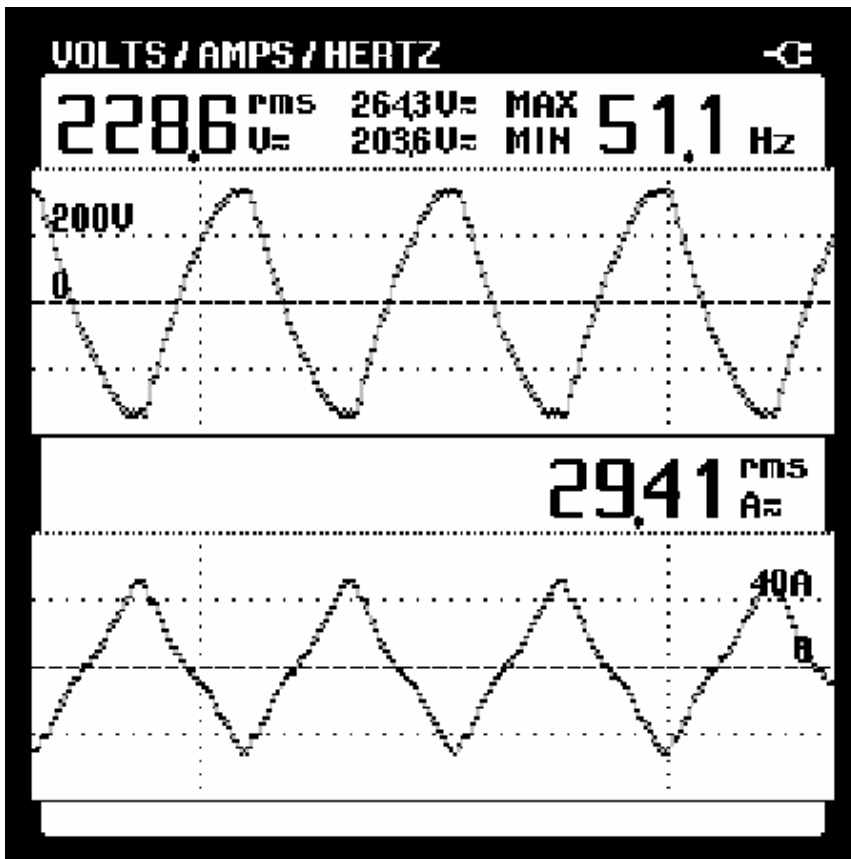

Fig. 9.a - Typical voltage and current waveforms

Most of the islands in the Maldives have basic infrastructure such as a school, health clinic, island administration office and mobile phone communication tower. The three selected islands have 24 hour power supply using diesel generators. The electrical loads in the islands were classified as: residential, govt .buildings (such as the island office, school, health centre etc), street lighting and commercial (such as mobile telephone towers etc). Electrical load profiles were developed for each island using assembled data and other information (electricity metering bills for different consumers). For the pilot phase three load profiles baseline (existing), conservative growth and higher growth scenarios were developed and used as inputs for the Homer simulation software. The “Baseline” scenario was estimated from the existing use of electricity, and a long term demand function model,

which takes into account socio-economic circumstances such as population growth, personal income growth, electricity price and intensity of use. The growth scenario assumes increased consumption due to increased use of appliances and takes into account economic factors such as population growth, personal income, intensity of use, and tariff. Possibility of load growth due to the construction additional infrastructure such as health centre with air conditioning load, and income generation activities were also evaluated. The load demand profiles of most of the outer islands (excluding the capital, Male) have a similar profile with peak load occurring in the night, as shown in Figure 8 [8].

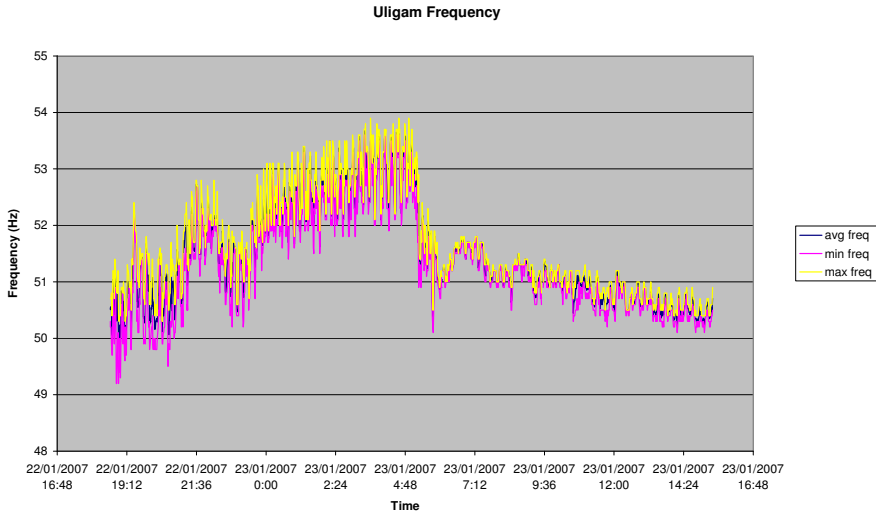

Fig. 9.b - Typical frequency data

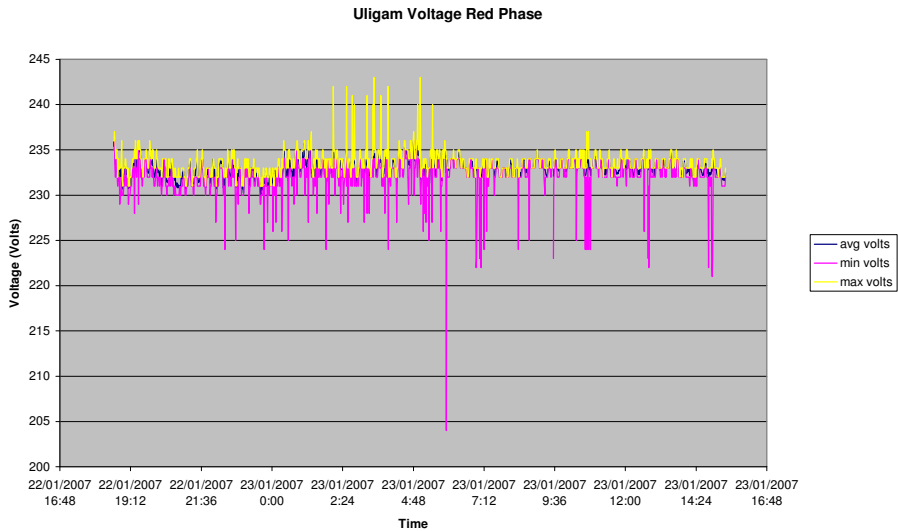

Fig. 9.c- Typical voltage data

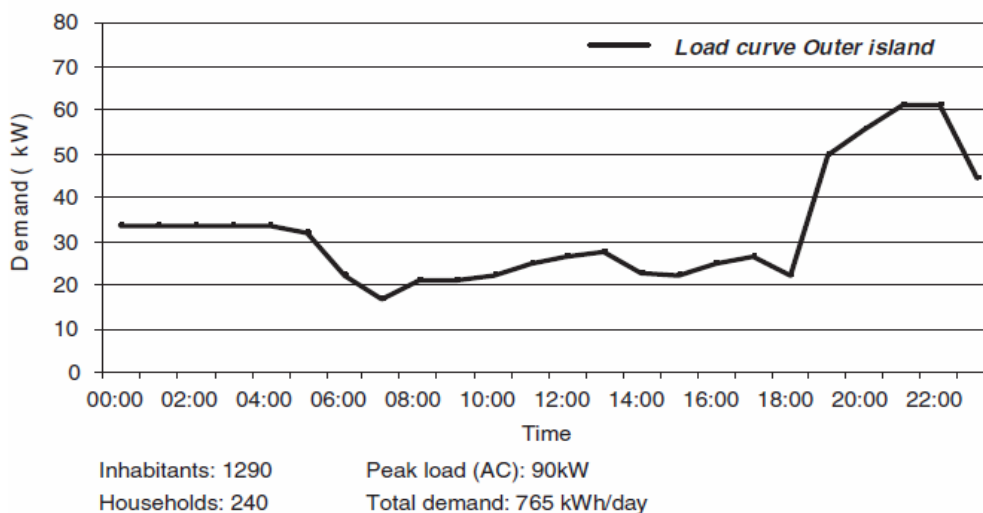

Fig. 10. Typical daily load profile

In this pilot study, the consultants investigated the possibility of siting the optimum number of the Skystream 3.7 manufactured by Southwest wind turbines, USA. Skystream is a new generation all-inclusive wind generator (with controls and inverter built in) designed to provide quiet, clean electricity in very low winds. The rated capacity is 1.8kW and the estimated energy production is 400 KWh per month at 5.4 m/ sec. Having surveyed the various islands, the consultants feel that this turbine is ideally suited for the conditions in Maldives due to its ease of erection, ease of integration and suitable low wind regime power curve.

Methodology involved in selecting the number of wind turbines include:

- The prevailing wind resource ( wind speed and direction)
- Land area available
- Obstructions such as trees
- Distance from the power station

Figure 11 – Typical layout of the proposed systems, shows the proposed structure of the power system.

A wide range of possible combinations of diesel generators, number of skystream wind turbines , photovoltaics (PV), batteries and inverters have been studied for the existing load profile, conservative growth and high growth scenarios. The computer program “HOMER” ranks the combinations according to long term cost per kWh. At these same points the key input parameter of diesel fuel price was varied around a base value, to give a sensitivity analysis. Fig. 12 shows a screen shot of the Homer output. Using the highest ranked plant combinations for the probable load forecast, a low cost, logical plant augmentation program was developed for each island, for the 20 year study period. This program included plant replacement (replacement of the batteries and diesel generators) and the capacity upgrades necessary to best meet the load.

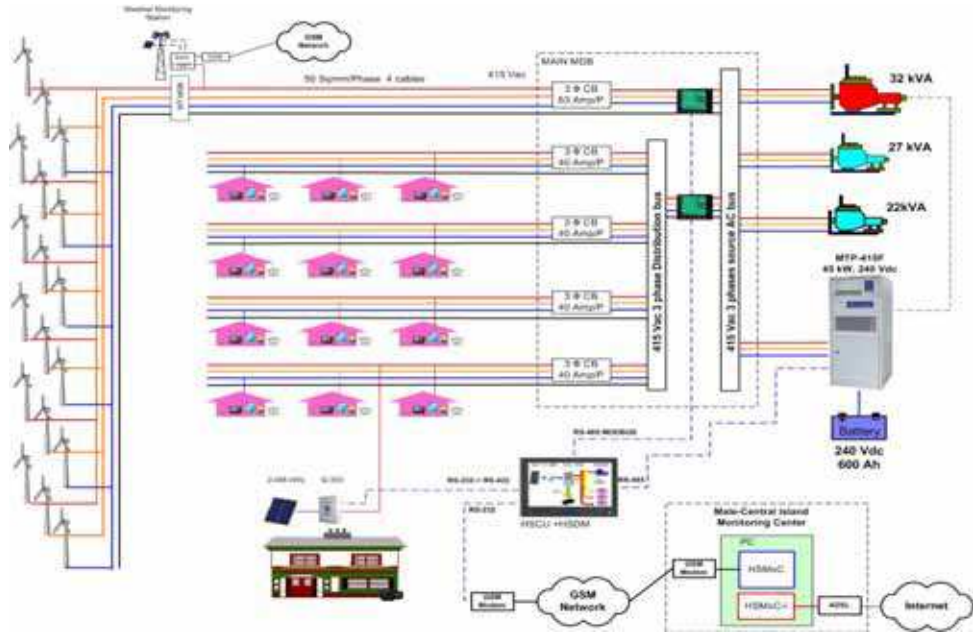

Fig. 11. Typical layout of the hybrid system

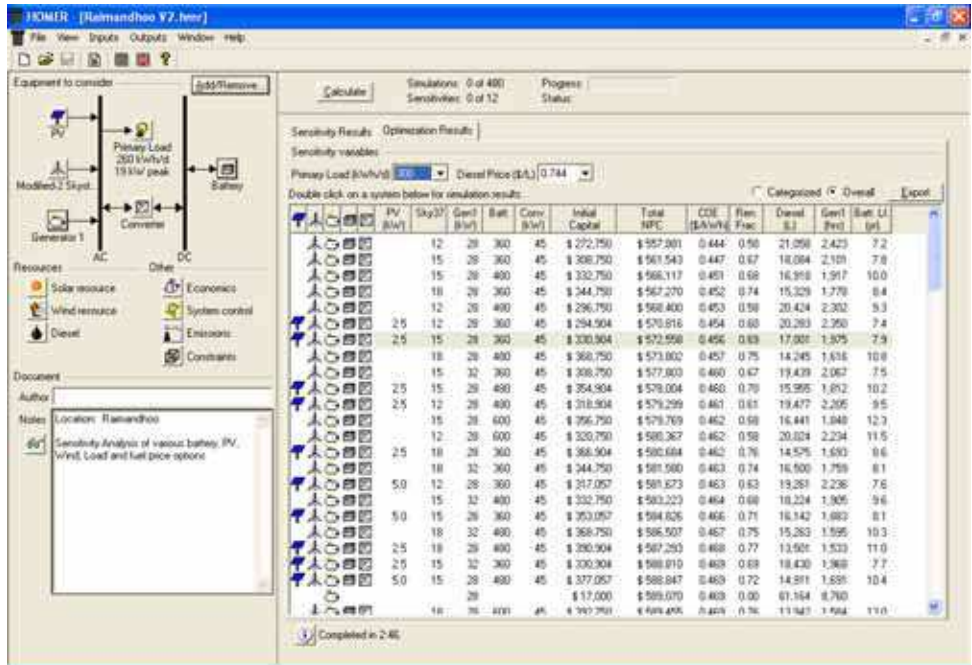

Fig. 12. Homer program output

The economic analysis was done using HOMER. HOMER takes inputs regarding system component sizes and costs, fuel prices, load data and produces cost and fuel estimates for the various scenarios. Table 3 summarise the input data for each system.

Load Profile Data File	Uligam	Raimandhoo.	Kondey
Average Energy Consumption 2006 (kWh/ day)	215	200	127
December 2006 consumption (kWh/ day)	250	214	141
Medium Growth (kWh/ day)	300	260	170
Fast Growth (kWh/ day)	450	400	260

Table 3. Load data scenarios

	Uligam	Raimandhoo.	Kondey
Cost of Diesel Fuel per litre	\$1.11	\$1.22	\$1.11

Table 4. Diesel fuel price scenarios

The output from Homer includes financial and technical information. The key parameters reviewed in the feasibility of a system were:

- Cost per unit of electricity – This was examined to see at what point there was a significant change in price for a change of system. In many cases the PV/ Wind/ Diesel combination was more expensive than just Wind/ Diesel, but the difference was very small so as part of the pilot study it has been included for completeness.
- Fuel Saved – In the cases mentioned above, for a small increase in price, there was significant reduction in fuel used. This was considered a valuable result beyond the small increase in cost.
- Capital cost – the project does have financial constraints and these were considered in the final selection
- Battery Life – The target life was greater than 7 years.

	Diesel Generator	Wind Turbines	Solar	Battery	Inverter
		1.8kW units	kW	kWh (400Ah)	kVA
Uligam	32kVA+32kVA+60kVA proposed	24	2.5	96	45
Raimandhoo	22kVA+27kVA	18	2.5	192	45
Kondey	17kVA+32kVA	6	5	96	25

Table 5. Optimised equipment selection

Hybrid systems consisting of a cluster of small wind turbines, photovoltaic modules, a bi-directional grid forming mini grid inverter (which can also work as a battery charger), battery storage and the existing diesel generators were installed and commissioned in the three islands in July/ August 2007. Figure 13 shows a photograph of the micro-wind farm and solar panels installed on the Uligam Island.



Fig. 13. Micro-wind farm and photovoltaic panels as installed in the Uligam island

Performance data of this system in each island can be accessed through a remote monitoring system. Figure 14 shows real-time captured information of the system on 29<sup>th</sup> October 2007. It can be seen that the combined of the output of the wind farm on the morning of the day is around 34.2 kW, out of which 15.3 kW goes into the island load and 19.3 kW goes into the battery. The grid is provided by the bi-directional inverter when the diesel generator is not running.

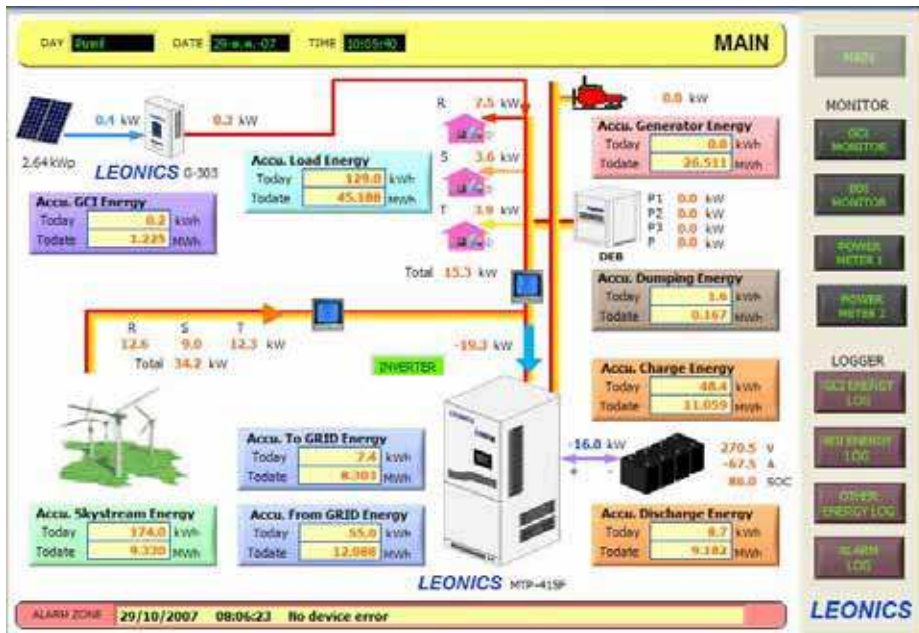

Fig. 14. Real time monitoring of Uligam Island power system.



Figure 15 shows measurements of the power contribution from solar, wind and diesel generator over a four day period.

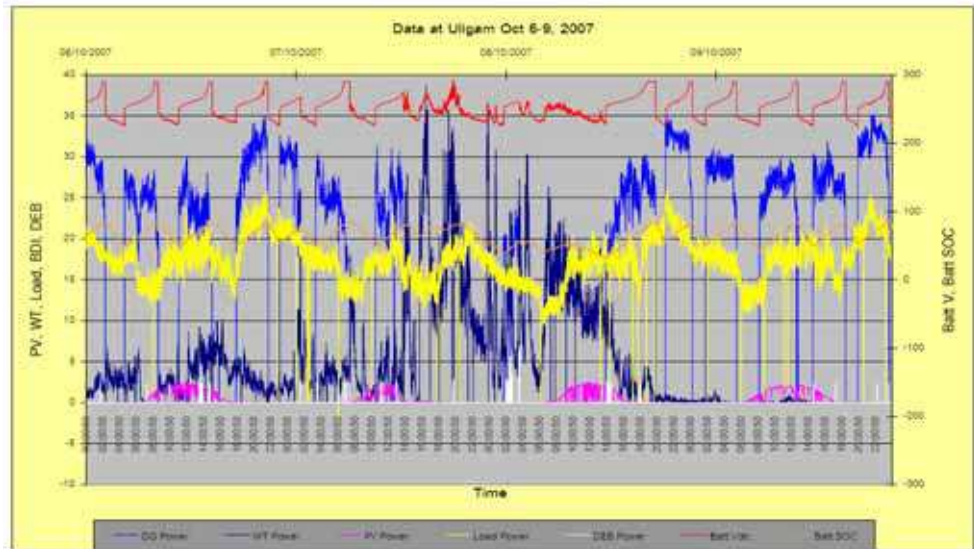

Fig. 15. Recording of the power contribution from solar, wind and diesel generator.

### 3.2 Case Study 2: PV/Diesel Micro Grid System implemented in a remote tourist resort in Western Australia

The Eco Beach Wilderness Retreat is located amongst a pristine, untouched environment about 2000 km north of Perth, the capital of Western Australia. An aerial view of the resort is shown in Figure 16. Western Australia (WA) is blessed with ample solar radiation and wind resources as shown in Figure 17.



Fig. 16. Aerial view of the Eco Beach Resort



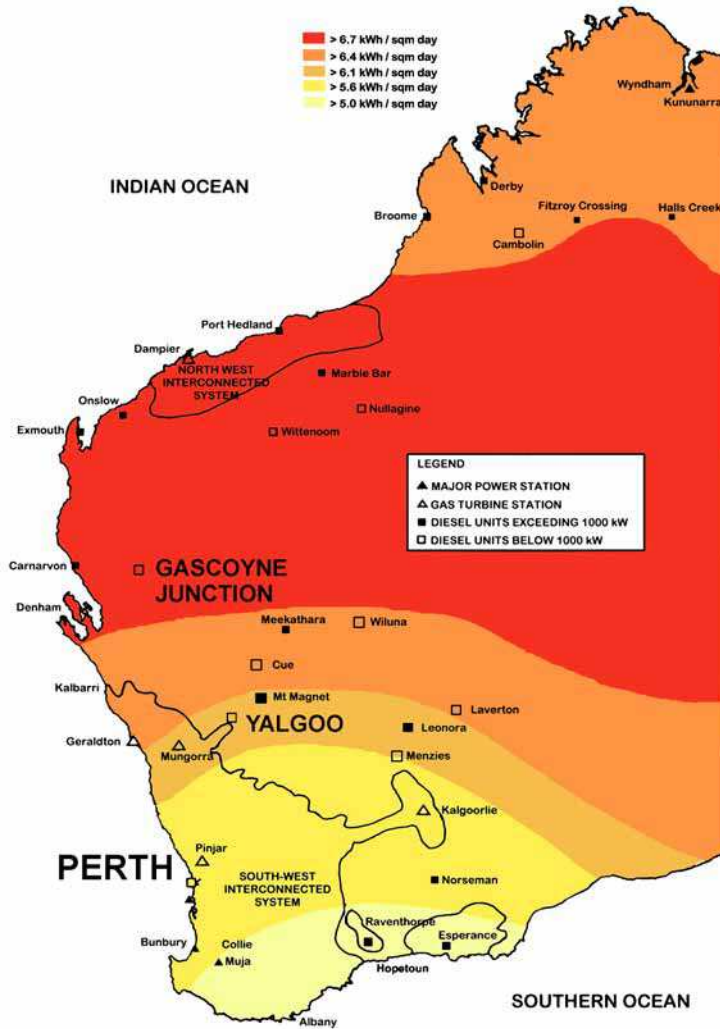

Fig. 17. Annual solar radiation in Western Australia

The author was approached in June 2008 to undertake a feasibility study to implement a renewable energy based hybrid power system for the Eco Beach Wilderness resort in Broome, WA. As the resort was under construction during the project inception stage, the power and energy requirements were unknown. Hence, a detailed energy audit was carried out, and the system loads were predicted. From this analysis, a peak load of 120kW and a daily energy consumption of 600kWh were predicted. The resort occupancy was factored to create seasonal and monthly load profiles.

The entire project including installation, testing and commissioning was carried out within a period six months and the resort was operational by May 2009. The system installed consists of 24 x 2kW PV arrays, a 120kW central bi-directional inverter with a 360V, 1500Ahr battery

bank and 4 x 50kW diesel generators. Each villa had a power monitoring device installed which tracks the renewable energy generated and the actual energy used in the villa. This allows energy conscious guests to audit their usage during occupancy. Each villa has a 2kW PV array installed on its north-facing side of the roof, as shown in Figure 18.



Fig. 18. Eco resort villas with photovoltaic panel installation

Two main considerations were adhered to while designing the system. One was to minimize the use of diesel fuel, as it was an eco resort and the second was the need to switch off the generators at night, so that the ‘sounds of nature’ could be heard. In addition to the capability to monitor the entire resort, the performance of each villa with solar PV on the roof, can also be individually monitored.



Fig. 19. Diesel Room at Eco Beach Resort

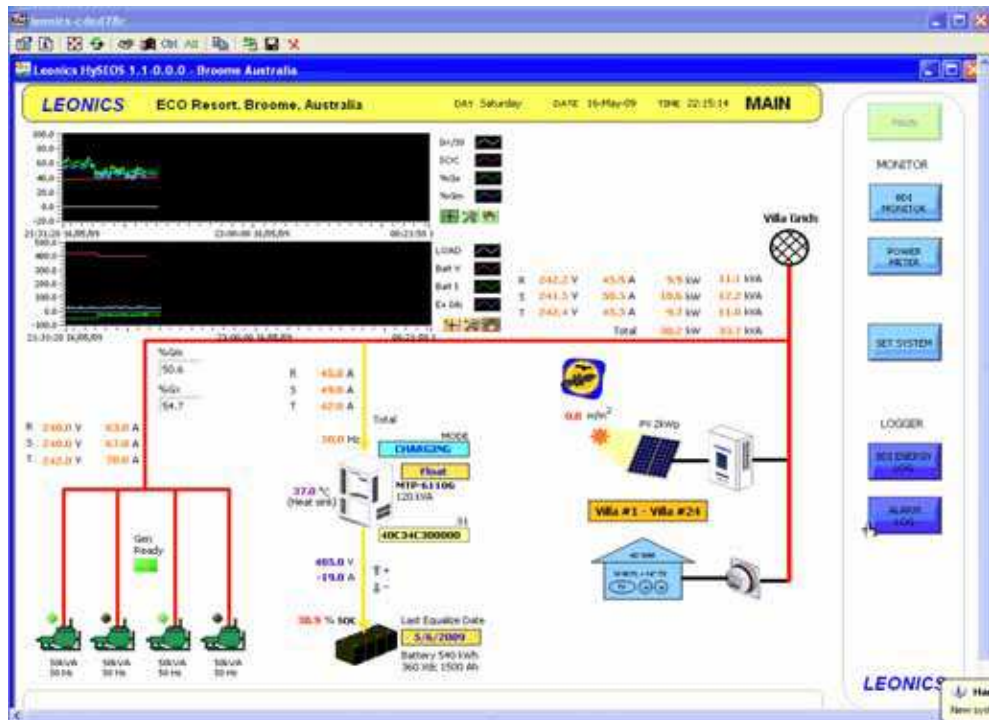

Fig. 20. Remote monitoring display

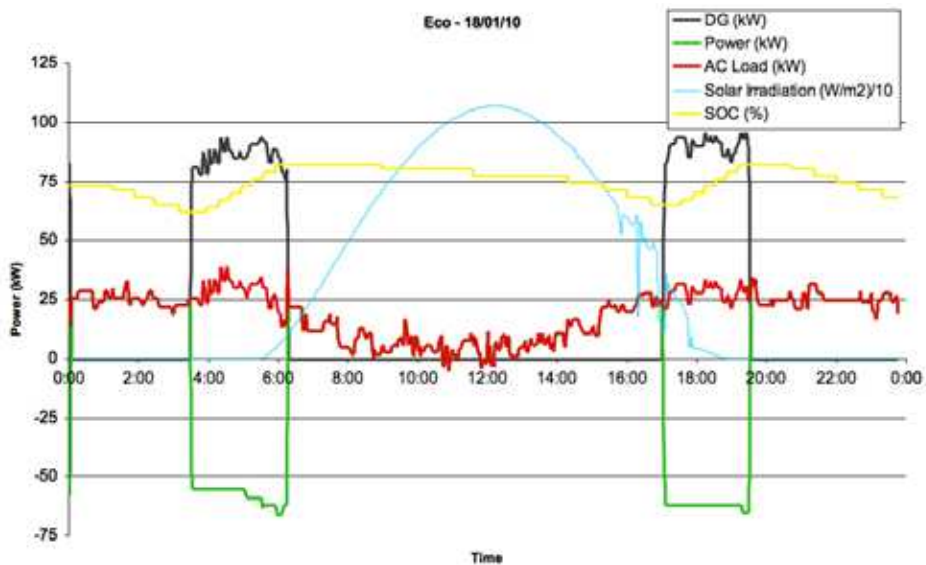

Fig. 21. System operation on a clear sunny day

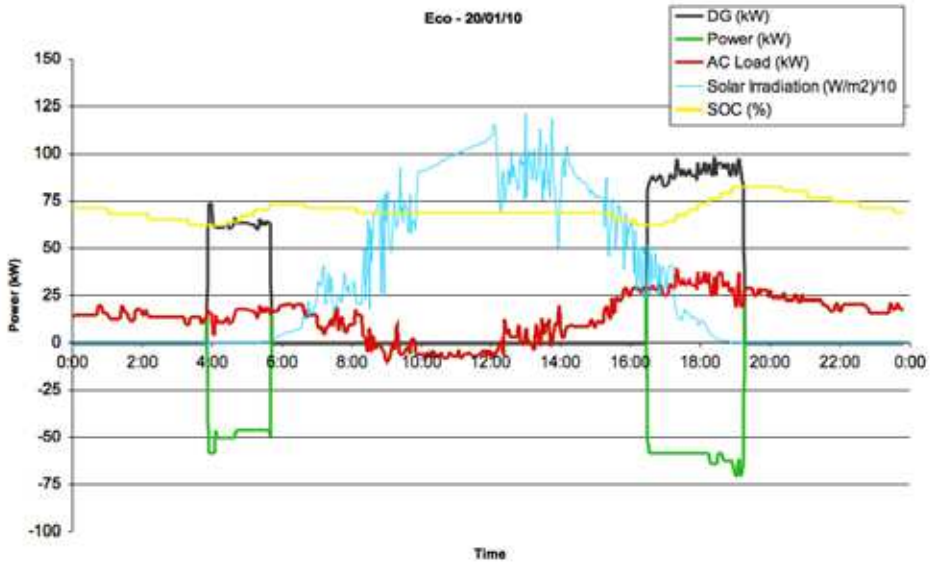

Fig. 22. System operation on a cloudy day



Fig. 23. Monitoring of energy generation and consumption in villas

#### 4. Variable speed operation of a diesel generator

A conventional diesel generator consists of an engine connected directly to a synchronous alternator to produce electricity. Since the electricity produced must be at a fixed frequency, normally 50Hz or 60Hz, the engine must rotate at a constant speed (typically 1500 rpm for 50Hz or 1800 rpm for 60Hz), regardless of the power demand. One solution to save fuel in a diesel generator is to enable the engine to operate at variable speeds in direct relation to the electrical load demand.

There are a number of applications for which the power demand varies greatly that can benefit from this technology which include:

- Staff accommodation on oil, gas and mineral exploration sites
- Construction sites where electrical demand fluctuates day and night
- Remote villages, islands, houses, cabins
- Telecom towers with air conditioning units that start and stop

The use of a variable speed generator has many advantages compared to a standard diesel generator, as outlined below.

##### 4.1 Fuel savings

A variable speed generator can save fuel in two ways. First, running the engine at its most efficient speed for a given power demand allows for considerable fuel savings. A comparison of the fuel efficiency of a constant speed diesel generator and a variable speed generator is shown in Figure 24. Estimation of the real saving in fuel consumption would depend on the load curve in a particular application.

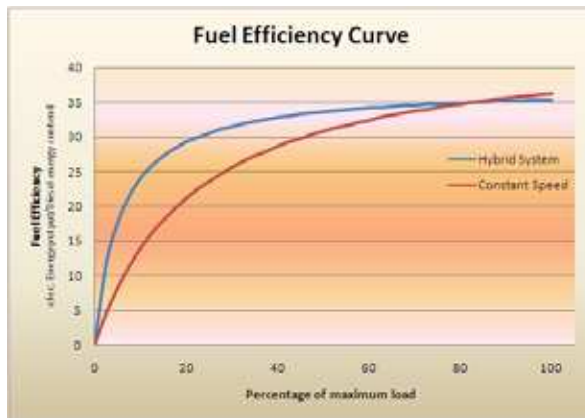

Fig. 24. Typical Fuel Efficiency curve of a diesel engine in Variable Speed (HybridGen) and constant speed genset

Fuel savings can also be achieved, as a variable speed genset requires smaller engine compared to a fixed speed generator of the same power rating. A standard engine power curve (shown in Figure 25) illustrates why the engine on a variable speed generator can be smaller. On a standard fixed speed generator, the engine can only operate at 1500 rpm. This means all the power above the nominal rated speed (Figure 25 - red area) is unavailable. A variable speed generator can use the engine over its full speed range, allowing a smaller engine to be used as compared to a fixed speed generator of the same power rating. Depending on the engine, its application, normally 50Hz, and its power curve, a variable



speed generator can extract up to 30% more power from the engine. It is worth noting that since generators rarely run at their rated capacity full time, the average operating speed of the engine will be below 1500 RPM.

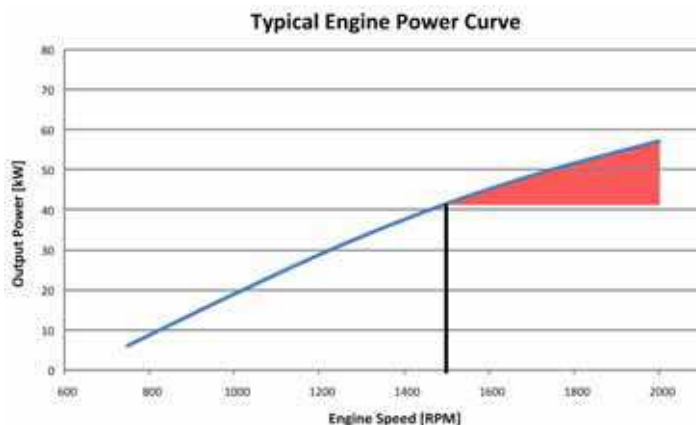

Fig. 25. Typical Diesel Engine Power Curve (Red Area: Engine power available above 1500 RPM)

#### 4.2 Reduced noise

Almost all the noise produced by a generator is due to the engine and the speed of revolution. When the engine speed is reduced, noise is also greatly reduced, which means that in power saving mode, when the engine is at a low speed, a variable speed generator is much quieter.

#### 4.3 Prolonged engine life

Variable speed generator in remote area applications will mostly run at lower speeds. This can prolong engine life. The moving parts in an engine are subjected to a “load cycle” every time the engine rotates. A reduction in speed results in a reduction of the number of load cycles resulting in extended engine life.

The second advantage is the elimination of a common problem in engines called cylinder glazing or wet stacking. Cylinder glazing usually occurs when an engine runs too cold and combustion is inefficient. This happens in fixed speed diesel engines when operating at low load. At low loads, the engine runs colder, which results in deposits on the cylinder walls of the combustion chamber. When the engine is continuously at its most efficient point, it remains hot and bore glazing is greatly reduced and/ or eliminated, resulting in prolonged engine life.

#### 4.4 Reduced emissions

Results from testing variable speed generators indicate that emissions are reduced proportionally to the fuel economy generated by the variable speed generating system.

### 5. HybridGen™ - An innovative variable speed generator

HybridGen is based on a Doubly Fed Induction Generator (DFIG) system which uses a wound rotor induction machine with the rotor's voltage controlled by two converters in a back to back configuration [9]. The basic system topology for a DFIG is shown in Figure 26.

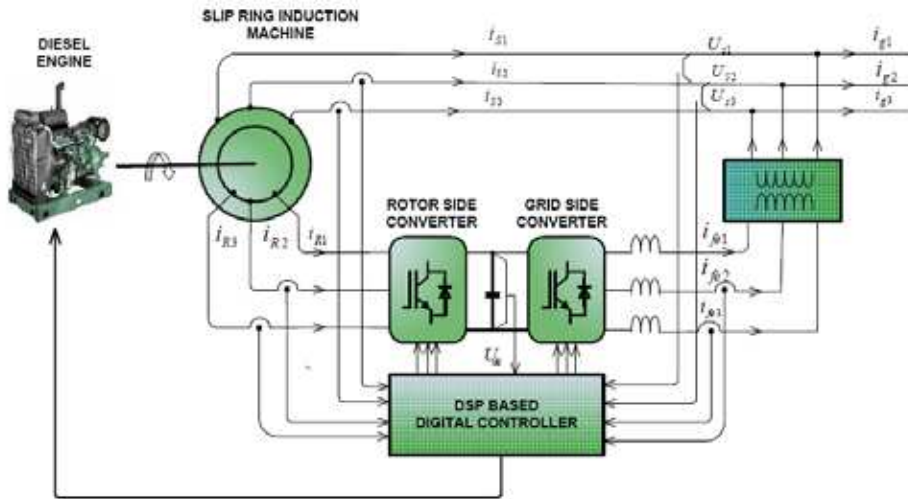

Fig. 26. Diesel powered Variable speed Doubly Fed Induction Generator

In this scheme, the Rotor Side Converter produces variable voltage at rotor frequency. Grid Side Converter controls the DC-link voltage and provides independent control of active and reactive power. In order to control the machine, the voltage impressed on the rotor must be capable of varying its voltage magnitude, phase shift, frequency and phase sequence. A voltage source for the rotor that is capable of meeting these requirements is created by connecting two PWM converters back to back. One of the inverters in the configuration is connected to the stator which is ultimately connected to the grid. This inverter is known as the stator side converter. The other inverter in the configuration is connected to the rotor's slip rings; this inverter is known as the rotor side converter. A DC bus is formed where the stator side converter connects to the rotor side converter. The stator and rotor side converters work together to create a frequency changing circuit. On the grid-side the frequency is fixed normally at 50Hz, and on the rotor side the frequency will vary depending on the rotor speed. HybridGen is designed for maintaining rated output voltage and output frequency of the wound rotor generator irrespective of the engine shaft speed. Diesel engines will be operated at the optimum speed depends on the load to reduce the fuel consumption. By utilising state of the art technology a high efficient, easy to use, variable speed generator has been designed with good dynamic performance.

Salient features are:

- Constant voltage/ constant frequency output irrespective of the prime-mover speed
- Programmable voltage and frequency
- Engine to operate at optimum efficiency at different to load conditions
- Capable of producing higher power output (more than the rated power) at higher speeds to meet the higher load demand without overloading the system
- Less maintenance cost/ down time of prime mover
- Ease of synchronizing with grid without additional synchronising relay
- Wide operating range (750 RPM to 2000 RPM)
- Programmable PI controllers for optimum transient response and steady state regulation

- Sophisticated PLC based supervisory control
- Advanced DSP based digital control and IGBT based inverter
- Flexible operating modes either as a stand- alone or grid connected generator
- Programmable output power at grid connected mode
- Programmable operating power factor
- Multi-data display: displays voltage, current power, and power factor
- Advanced protection systems to limit over voltage, short circuit and, over current



27.a



27.b

Fig. 27.a A HybridGen (40kVA) consisting of diesel engine, generator and electronic fuel regulator

Fig. 27.b Power conditioning unit

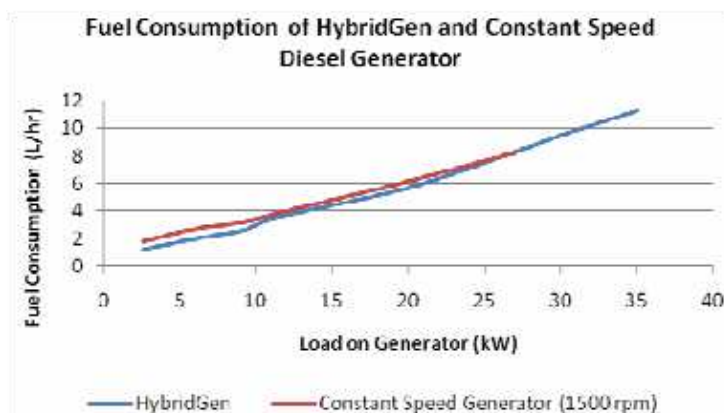

Fig. 28. Fuel consumption of a constant speed generator and HybridGen.

Figure 29 shows a schematic diagram showing multiple variable speed diesel generators with AC-coupled wind generators and photovoltaic generators. Future hybrid energy systems will be using variable speed generators instead of conventional constant speed diesel generators.



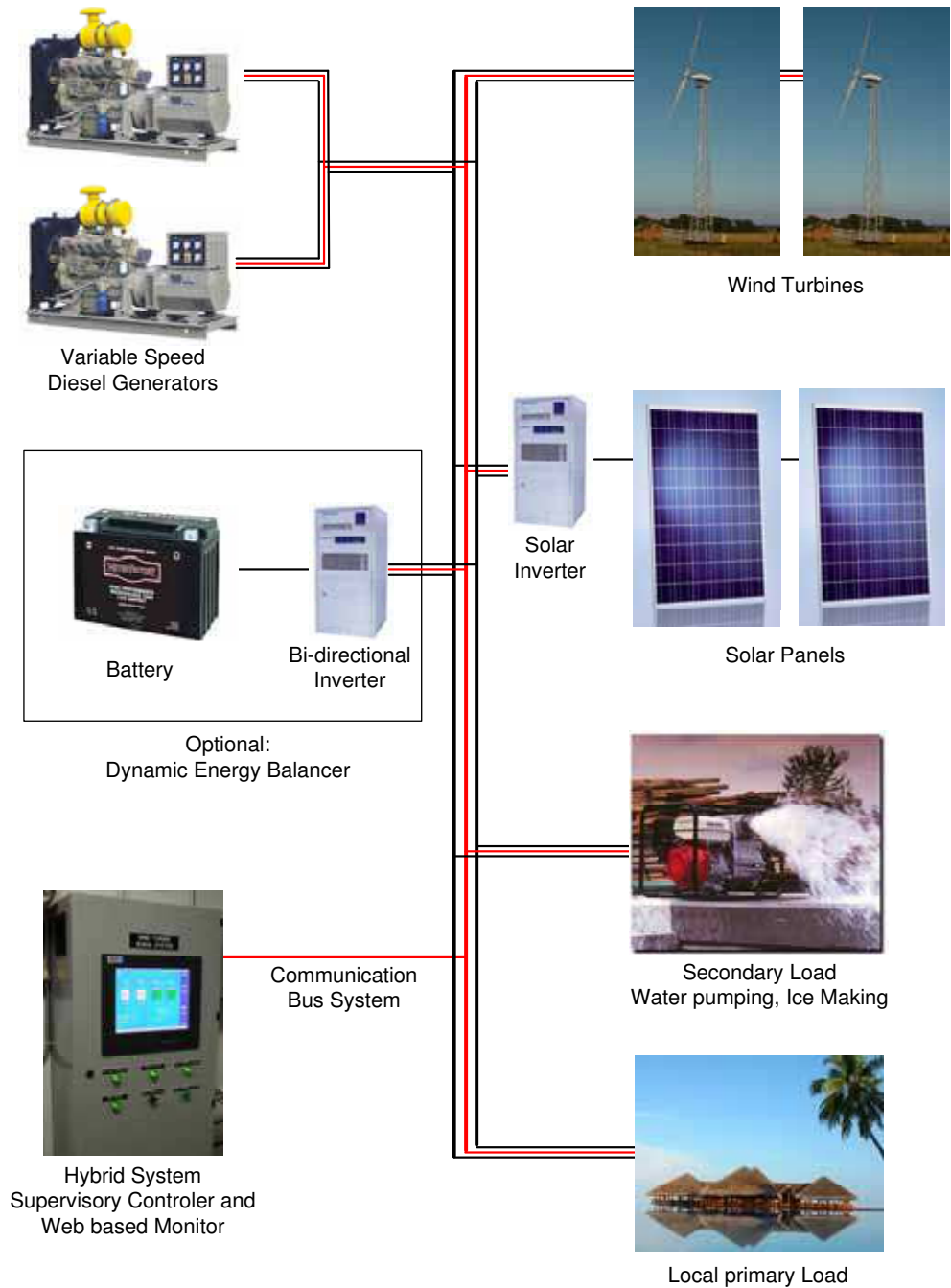

Fig. 29. Multiple variable speed generators with AC-coupled wind turbines and solar panels

## 6. Conclusion

Islands and remote communities represent a big niche market for the application of renewable energy technologies and are very important when it comes to the promotion of renewable energy worldwide. From the experience learned from the implementation of several remote area power systems, it is clearly evident that hybrid, renewable micro grids are a reality and the right step towards making resorts and remote islands self sufficient. It also opens up the potential for tourism, apart from making the earth a cleaner place to live. The newly developed variable speed diesel generator system is expected to provide very good opportunities to showcase high penetration of renewable energies using state-of-the-art wind turbines and photovoltaic modules. The new hybrid system configuration offers several advantages such as maximised diesel efficiency, minimised maintenance of diesel generators and a reduction in the required capacities of diesel fuel and battery storage.

## 7. References

- Alphen, Klann van et al (2007) *Renewable energy technologies in the Maldives—determining the potential*, *Renewable and Sustainable Energy Reviews*, Vol 11, 1650–1674.
- Bull, S.R. (August 2001) *Renewable Energy Today and Tomorrow*, Proceedings of the IEEE, Vol. 89, No. 8.
- Burges, K., Hemert, B. Van (2000) “Market Introduction of Hybrid Power Supply Systems,” Paper for PV Hybrid Power Systems conference, Aix en Provence, pp. 1-4.
- Darbyshire, J. (unpublished) *Multi-Function Power Electronic Interface for Hybrid Mini-Grid Systems*, PhD Thesis.
- Datta, M., Senjyu, T., Yona, A. & Funabashi, T. (2009) *A Frequency Control Method for Isolated Photovoltaic-diesel Hybrid Power System with Use of Full Renewable Energy*, PEDS, pp. 1.
- Lowe, D. & Lloyd, C.R. (February 1999) *Renewable energy systems for remote areas in Australia*, Paper for the World Renewable Energy Congress, Murdoch University, pp. 1-4.
- Luiz, R., Osvaldo, S. L., Shigeaki & Jose, D. (November 2009) *Isolated Micro-Grid with Renewable Hybrid Generation*, IEEE Transactions on Sustainable Energy, pp. 1-2.
- Nayar, C. (Nov. 2008) *Remote area micro-grid system using diesel driven doubly fed induction generators, photovoltaics and wind generators*, *Sustainable Energy Technologies*, 2008. ICSET 2008. IEEE International Conference, 1081 – 1086, 24-27.
- Nayar, C.; Tang, M.; & Suponthana, W. (December 2007) *An AC Coupled PV/Wind/Diesel Microgrid System Implemented in a Remote Island in The Republic Of Maldives*, AUPEC Conference proceedings, pp. 1-4.
- Nayar, C., et al July 2006) *Power Conversion System and Method of Converting Power*, US Patent US7,072,194B2.



## **Paths to Sustainable Energy**

Edited by Dr Artie Ng

ISBN 978-953-307-401-6

Hard cover, 664 pages

**Publisher** InTech

**Published online** 30, November, 2010

**Published in print edition** November, 2010

The world's reliance on existing sources of energy and their associated detrimental impacts on the environment- whether related to poor air or water quality or scarcity, impacts on sensitive ecosystems and forests and land use - have been well documented and articulated over the last three decades. What is needed by the world is a set of credible energy solutions that would lead us to a balance between economic growth and a sustainable environment. This book provides an open platform to establish and share knowledge developed by scholars, scientists and engineers from all over the world about various viable paths to a future of sustainable energy. It has collected a number of intellectually stimulating articles that address issues ranging from public policy formulation to technological innovations for enhancing the development of sustainable energy systems. It will appeal to stakeholders seeking guidance to pursue the paths to sustainable energy.

### **How to reference**

In order to correctly reference this scholarly work, feel free to copy and paste the following:

Chemmanogot V. Nayar (2010). High Renewable Energy Penetration Diesel Generator Systems, Paths to Sustainable Energy, Dr Artie Ng (Ed.), ISBN: 978-953-307-401-6, InTech, Available from:  
<http://www.intechopen.com/books/paths-to-sustainable-energy/high-renewable-energy-penetration-diesel-generator-systems->

**INTECH**  
open science | open minds

### **InTech Europe**

University Campus STeP Ri  
Slavka Krautzeka 83/A  
51000 Rijeka, Croatia  
Phone: +385 (51) 770 447  
Fax: +385 (51) 686 166  
[www.intechopen.com](http://www.intechopen.com)

### **InTech China**

Unit 405, Office Block, Hotel Equatorial Shanghai  
No.65, Yan An Road (West), Shanghai, 200040, China  
中国上海市延安西路65号上海国际贵都大饭店办公楼405单元  
Phone: +86-21-62489820  
Fax: +86-21-62489821

© 2010 The Author(s). Licensee IntechOpen. This chapter is distributed under the terms of the [Creative Commons Attribution-NonCommercial-ShareAlike-3.0 License](#), which permits use, distribution and reproduction for non-commercial purposes, provided the original is properly cited and derivative works building on this content are distributed under the same license.