

High velocity ring shear tests on sand

O. HUNGR* and N. R. MORGENSTERN†

Ring shear tests on sand materials have been carried out to show whether there is a change in the behaviour of these materials at high shearing rates and normal stresses. This question is relevant to the problem of the mobility of large rock avalanches (stürzstroms), but is also of more general academic interest. A ring shear apparatus of unusual, although simple, design has been constructed, capable of achieving circumferential velocities of 2 m/s at normal stresses of up to 200 kPa. Tests were carried out on two types of coarse sand, wet or dry, sand-rock flour mixtures and polystyrene beads. Perfect frictional behaviour was observed in all the tests, uninfluenced by either velocity or normal stress over the entire range of these variables. Change in frictional behaviour due to high rate of shearing therefore cannot be used to explain the high observed mobility of stürzstroms.

Des essais de cisaillement circulaire par torsion ont été effectués afin de découvrir si un changement ait lieu dans le comportement de ces matériaux sous des contraintes normales élevées. Cette question est en rapport aussi avec le problème de la mobilité des grandes avalanches de rochers (Sturzströme), mais elle possède également un intérêt théorique plus général. Un appareil de cisaillement circulaire par torsion de nature exceptionnelle mais simple a été construit qui peut atteindre des vitesses de 2 m/s sous des contraintes normales jusqu'à 200 kPa. Des essais ont été effectués sur deux types de sable grossier, humide ou sec, des mélanges de farines de sable et de rochers et des perles de polystyrène. Dans tous ces essais on a observé un comportement de frottement parfait qui n'était influencé ni par vitesse ni par la contrainte normale sur la gamme entière de ces variables. Il est par conséquent impossible de considérer que le changement dans le comportement de frottement dû à un taux élevé de cisaillement peut expliquer la haute mobilité qu'on a observé dans les avalanches de rochers (Sturzströme).

INTRODUCTION

Large, rapidly moving masses of broken rock during rock avalanches (stürzstroms) exhibit a degree of mobility greater than would be predicted by describing their motion as constant-volume shearing of dry granular material (Scheidegger, 1973). Several diverse explana-

tions of this phenomenon have been suggested (e.g. Heim, 1932; Shreve, 1968; Kent, 1966; Habib, 1975; Erismann, 1979), although none has so far been proven to represent the chief cause of the observed behaviour.

An explanation favoured by a number of recent authors (Howard, 1973; Scheidegger, 1975; Hsü, 1975; Körner, 1977; McSaveney, 1978) proposed that the nature of shearing in granular materials changes at extremely high rates, because of a different type of particle contact. This has been assumed to lead to a reduction in the apparent friction coefficient of the shearing mass, and increased mobility, allowing rock avalanches to travel with steady velocities over flat slopes. The phenomenon has been termed mechanical fluidization (McSaveney, 1978).

The results of recent flume experiments showed that granular material retains its frictional character under very high rates of shearing (Hung & Morgenstern, 1984). But a question remains whether this would also be the case when normal stress is high. Dimensional analysis showed that the main deficiency in a comparison between the flume tests and rock avalanches was the low stress level employed in the former. The apparent coefficient of friction of rock avalanches decreases with the volume of the event (e.g. Scheidegger, 1973) and therefore presumably also with increasing levels of normal stress at the base of the flow. Finally, the high velocity ring shear experiments by Bridgwater (1972) seem to indicate the beginnings of a rate effect in tests of glass beads at velocities of approximately 50 cm/s and normal stresses exceeding 25 kPa.

In order to decide conclusively whether or not such a phenomenon actually exists, it was necessary to conduct ring shear tests that would subject a sample of granular material to a combination of both high shear rate and relatively high normal stress (Hung, 1981). Besides uniform sands, mixtures of sand and fine rock flour were also tested, to examine the hypothesis of Hsü (1975) concerning liquefaction of rock debris avalanches by dust dispersions. Tests were also carried out in a water bath.

The experimental apparatus was designed to increase substantially the power input per unit

Discussion on this Paper closes on 1 January 1985
For further details see inside back cover.

* Thurber Consultants Ltd, Vancouver.

† University of Alberta.

Table 1. Parameters of previous ring shear tests on granular materials

Author	Materials tested	Sample volume: cm ³	Maximum velocity: m/s	Maximum stress: kPa	Sample height: cm	Power per cm: kW/cm ³	Rate effect
Healy (1963)	Ottawa sand	20	0.03	63	0.28	6.8	Slight
Novosad (1964)	Glass beads	254	0.5	2	3.0	0.3	None
Scarlett & Todd (1969)	Sand	1200	0.03	6	4.0	0.5	None
Bridgwater (1972)	Glass beads and plastics	940	2.0	25	4.0	12.5	Yes
This research	Coarse sand, sand and rock flour, sand and water	660	1.0	200	2.0	100	None

volume of tested material* achieved by previous investigators. At the same time, a relatively large sample was used to minimize possible boundary effects. A comparison with previous ring shear tests on granular materials is given in Table 1. The present tests use normal stress levels only slightly less than those at the base of a typical stürzstrom, while achieving very high shear strain rates.

APPARATUS DESIGN

The main dimensions and capacities of the apparatus were determined by the considerations described in the previous section. It was decided to adopt the test configuration of Hvorslev (1939), which forces the sample to begin shearing at mid-height, where the upper and lower annular boxes are separated by a set gap. A schematic cross-section of the apparatus is shown in Fig. 1.

The normal pressure is generated by an annular (doughnut shaped) inflated rubber membrane, which bears against the back wall of the upper box. The upper box can then be rigidly enclosed and kept a fixed distance from the lower one, the volume changes of the material being accommodated by the flexibility of the membrane. The vertical retention of the upper box is achieved through a stiff load cell which then measures the total normal load, i.e. both

the loading platen load and the side friction. This arrangement achieves reliable control of the total normal load, while being mechanically simple.

The lower box rotates on a fixed vertical shaft.

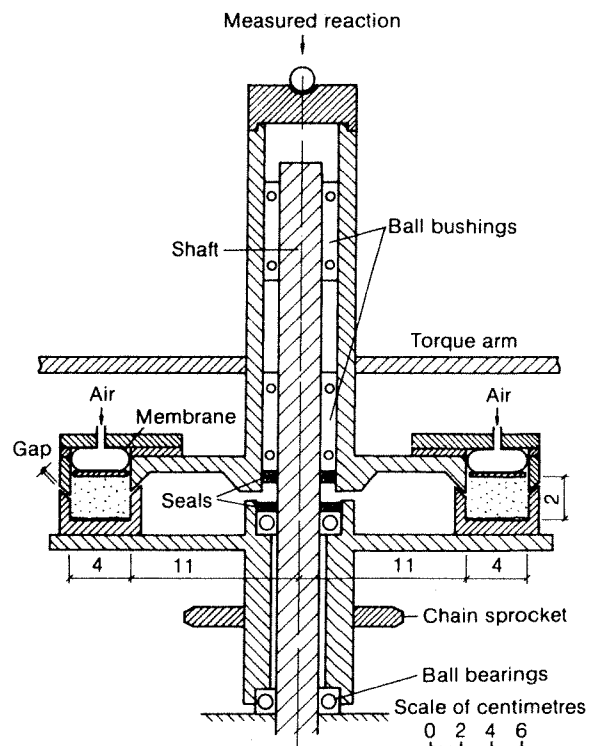

Fig. 1. Vertical section of the ring shear boxes (dimensions in centimetres). Lower box rotating, upper box fixed

* Defined as the maximum shear strain rate times the maximum normal stress. This definition is meaningful only for frictional materials, such as those tested.

The upper box is mounted on the same shaft by means of two linear ball bushings, which allow free vertical motion as well as rotation. The box can be disassembled by lifting the back wall

with the membrane and pressure platen, to gain access to the interior of the space occupied by the sample (Fig. 2(c)). During the test, the box is bolted together.



(a)

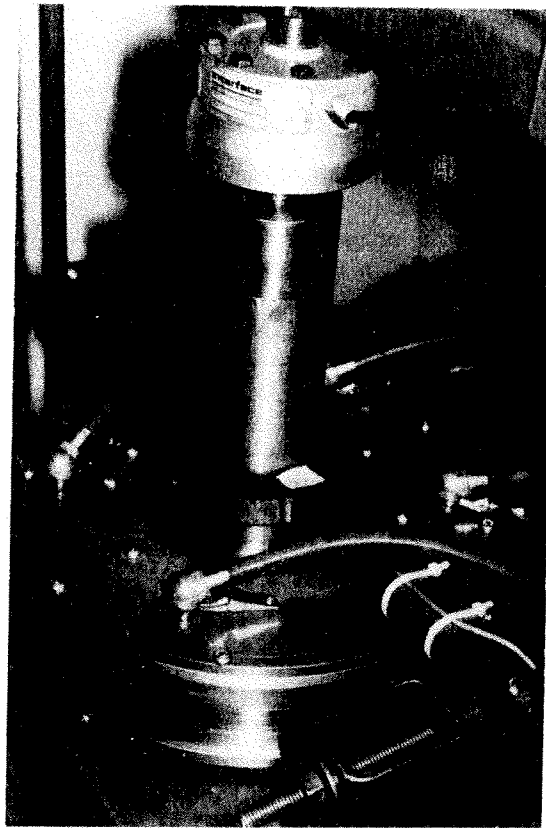

(b)

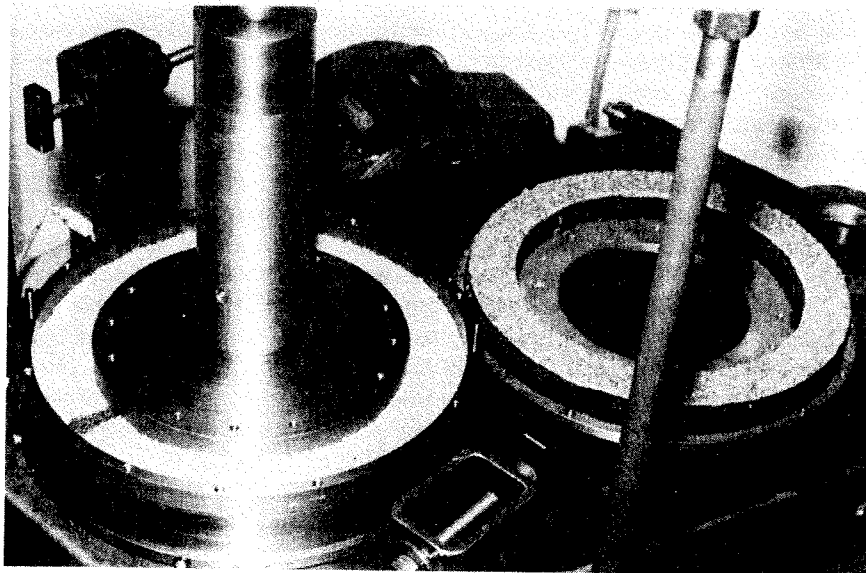

(c)

Fig. 2. Ring shear apparatus: (a) overall view; (b) detail of upper box with torque arm, load cell and air inlets; (c) sample in place, loading platen and membrane (right)

A strain gauge instrumented double arm, attached to the hub of the upper box by screws, restrains rotation of this box and measures the torque (Fig. 2(b)). The vertical loading yoke is adjustable, to allow setting of the gap between the boxes to a specified opening.

The compressed air membrane is made from 1.5 mm thick vulcanized rubber, reinforced by unidirectional fibre strands. The strands are laid so that in any side view of the membrane they would always appear dipping at 45° in the direction of shearing. This orientation of the reinforcement enables the membrane to sustain the shear load which it must transmit from the back wall of the box to the loading platen. At the same time, the flexibility of the rubber in the direction perpendicular to the strands permits membrane expansion. The membrane is permanently glued both to the box cover and to the platen. It has four air inlets, to ensure fast response and uniform pressure distribution. Rough surfaces of glued down coarse sand cover both the bottom of the lower box and the pressure platen, to prevent slip at the horizontal boundaries of the sample.

The tests were driven by a 7 hp three-phase electric motor, connected to the lower box by a two-speed heavy duty chain drive. The speeds of rotation were 11.8 and 72.2 rev/min, corresponding to mean circumferential velocities of 16.0 and 98.2 cm/s at the mean radius of the sample.

The total normal force, torque and displacement were all monitored continuously during each test. The normal force was measured as the reaction between the hub of the upper box and the restraining yoke, using a standard compression load cell. The weight of the upper box was added. The torque was registered in the form of bending strain in the torque arm which was restrained against stiff columns projecting from the main frame. Circumferential displacement was monitored by a trip switch, contacting the lower box six times per revolution in the slower tests or once in the faster ones. All three measurements were registered simultaneously by a Honeywell six-channel chart recorder, whose chart velocity also served to monitor the time.

TEST PROCEDURE

All the tests were run as multi-stage tests, yielding results in series of up to three levels of normal pressure from each sample. The staging direction was periodically reversed in order to be able to identify possible effects of sample degradation. In one series of tests the normal pressure was progressively increased and in the

next series decreased. But this was found to have no measurable effect on the results. Since the main purpose of the tests was to study rate effects, a new sample of fresh sand was placed at every change of speed.

Tests were carried out at the two speeds of the apparatus and also at a very slow rate, when the drive train was rotated slowly by hand. The circumferential velocity of this last testing method varied between 0.025 and 0.1 cm/s.

The normal load applied before the start of each test usually changed within the first second, usually dropping by 0 to 30% but sometimes increasing. This was the result of side friction. Bishop, Green, Garga, Andresen & Brown (1971) commented that it is both difficult and unnecessary to keep the normal load constant, as long as its magnitude is reliably monitored. This is even more strongly true of the present experiments, in which rapid gains in velocity probably resulted in very significant volume changes in the granular material. This does not affect the precision of the results, however, since the changing normal load is continually measured as the reaction against the loading frame.

The gap between the boxes was maintained in general at 0.5 mm or approximately one-third of the minimum grain size of the coarse sand tested. No grains were observed to enter the gap. An exception was the rock flour which in tests of flour-coarse sand mixtures escaped through the gap in small amounts. The grain size of this material was, however, so much smaller than the gap opening that it could not cause any significant friction there. The absence of friction in the gap was checked by conducting several tests with greater and smaller gap openings (0.3–1.0 mm), without a change in results. Also, two tests were run with continuous changes in air pressure in the membrane up and down for several cycles, without intermediate readjustments of the gap. The normal and vertical stresses registered throughout these tests remained always on the linear strength envelope. If there had been a gap friction, this could not be the case, but the apparent strength curve would necessarily have to show curvature. This is because, unlike the sample frictional strength, the gap friction would not be affected by the membrane pressure.

A simple analysis of the results was used, assuming that both the normal and tangential stresses are uniformly distributed over the sample area. This would be exactly correct if the residual friction coefficient of the material could be assumed to be constant with both displacement and velocity, which indeed turned out to be the case.

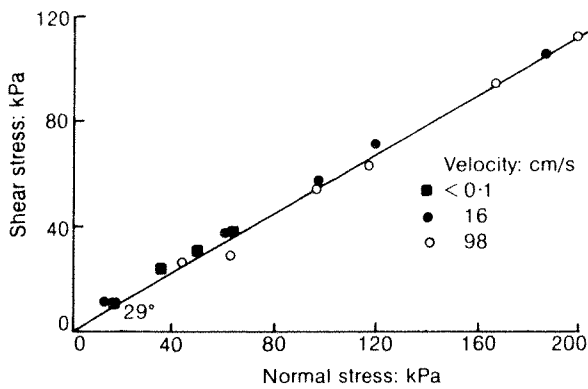

Fig. 3. Strength envelopes of the dry 10-14 sand

RESULTS

Tests were carried out on several kinds of material including two sizes of relatively coarse sand, mixtures of sand and rock flour, polystyrene beads and sand in water. All these materials were tested under varied velocities and normal stresses. All exhibited straight linear residual strength envelopes with zero cohesion and unique angles of residual friction, practically unaffected by the speed of the test.

The main test material was a medium uniform quartz sand with rounded grains, obtained as the fraction between US Standard sieve sizes 10 and 14 (grain diameter 1.5 to 2.0 mm). This was selected over Ottawa sand, since this coarser material could be more easily kept from entering the gap between the boxes. The resulting strength envelope for this material in the air-dry state is shown in Fig. 3 and that for the sand submerged in water in Fig. 4. The last figure also shows an example of the continuous test previously described, in which the membrane air pressure was varied cyclically up and down.

No velocity or normal stress effect can be observed within the range of test conditions in either of the two materials. The residual friction angle of 29° is about 4° less than the lower limit

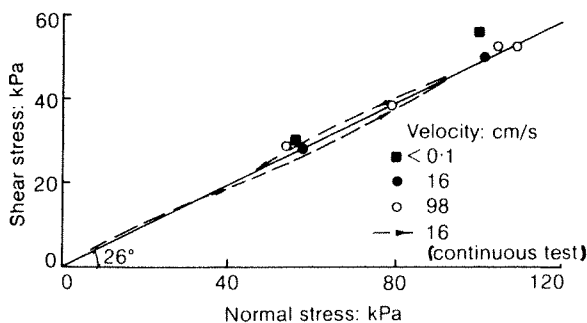

Fig. 4. Strength envelopes of the 10-14 sand submerged in water

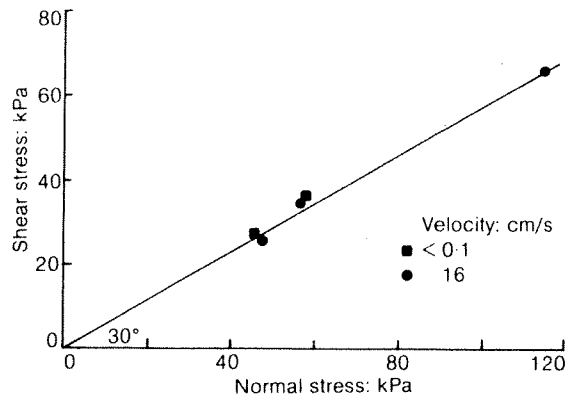

Fig. 5. Strength envelopes of the dry 8-10 sand (coarse)

angle of repose. The friction angle in water is 26°.

Figures 5 and 6 show the results of tests on coarse rounded sand (fraction between sieves 8 and 10, or particle diameter of 2-3 mm) and smooth spherical polystyrene beads similar to those used in some of the flume experiments. Only one series of tests was carried out on each of these materials, comprising very slow and slow velocities. No rate effects can again be observed. In the case of the polystyrene beads, very strong stick-slip vibration was observed at normal stresses exceeding 70 kPa and with the slow velocity. This is probably a phenomenon connected with the fundamental frictional properties of this material. Consequently, no fast tests have been conducted, for fear of damaging the apparatus.

Two mixtures of rock flour and the 10-14 sand were prepared. The rock flour was crushed pure quartz with a mean grain diameter of 0.044 mm. At first, 25% by weight of this was added, so that the flour would just fill the void space of the sand in loose static piling. This is the only case (Fig. 7) where a slight rate effect could be discovered. The slow and very slow tests yielded a friction angle similar to that obtained in the tests with greater proportion of rock flour. The fast tests, on the other hand, were comparable to those of the sand alone. A possible interpretation of this is that the more

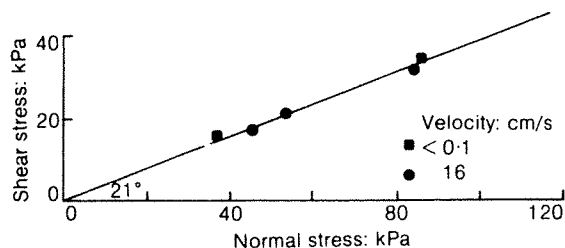

Fig. 6. Strength envelopes of the polystyrene beads

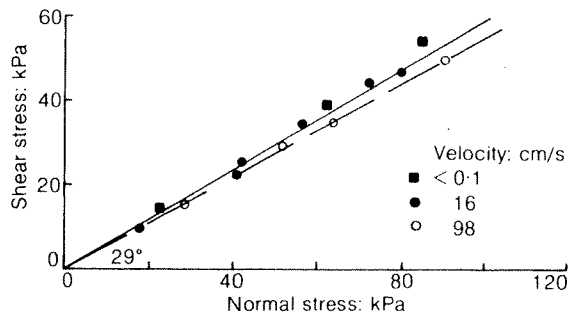

Fig. 7. Strength envelopes of the 4:1 sand and rock flour mixture

angular rock flour controls the friction angle at low rates, while the more rounded large particles dominate at high velocity, perhaps by virtue of their greater dispersive pressure.

Another mixture was formed by adding 50% of rock flour to a unit of sand, i.e. twice as much as was needed to fill the void space loosely. The sand grains would thus be expected to 'float' in the powder in this mixture. No velocity or normal stress effects were found (Fig. 8).

CONCLUSION

Table 2 contains a summary of all the measured residual friction angles, together with a few other results for comparison. It will be seen that the observed angles of friction agree well with typical values and show little scatter. The polystyrene beads result agrees remarkably well with that obtained in the flume tests at comparable

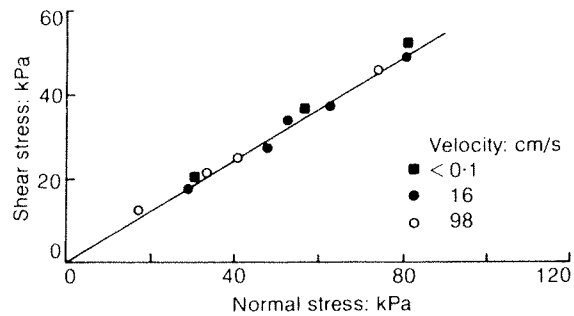

Fig. 8. Strength envelopes of the 4:2 sand and rock flour mixture

velocities. The comparison of the flume test and ring shear test results for sand reflects the greater degree of roundness of the Ottawa sand used in the former.

These results indicate an absence of a rate and normal stress effects over a range of conditions and material characteristics that do not leave much room for exceptions.

Their significance is simple: the hypothesis of mechanical fluidization, postulating a breakdown of the Coulomb relationship at high velocities, although intuitively attractive, is not correct.

ACKNOWLEDGEMENTS

This research has been supported in part by a grant from the National Science and Engineering Research Council of Canada.

Table 2. Summary of residual friction angles measured in the ring shear tests

Material	Residual friction angle: degrees		
	Very slow: 0.1 cm/s	Slow: 16 cm/s	Fast: 98 cm/s
10-14 sand, dry	29	29	29
10-14 sand in water	26	26	26
4:1 sand-flour mixture	31	31	29
4:2 sand-flour mixture	31	31	31
8-10 sand, dry	30	30	-
Polystyrene beads	21	21	Stick slip
Ottawa sand in flume tests		25.5	
Polystyrene beads in flume tests		21.8 25	(2 m/s) (2 m/s)
Non-plastic silt*		26-30	
Uniform fine-medium* sand		26-30	

* Typical range of low velocity constant volume friction angles (Lambe & Whitman, 1979).

REFERENCES

- Bishop, A. W., Green, G. E., Garga, V. K., Andresen, A. & Brown, J. D. (1971). A new ring shear apparatus. *Géotechnique* **21**, 273-328.
- Bridgwater, J. (1972). *Stress-velocity relationships for particulate solids*. ASME Paper No. 72-MH-21. New York: American Society of Mechanical Engineers.
- Erismann, T. H. (1979). Mechanism of large landslides. *Rock Mech.* **12**, 15-46.
- Habib, P. (1975). Production of gaseous pore pressure during rockslides. *Rock Mech.* **7**, 193-197.
- Healy, K. A. (1963). *The dependence of dilation in sand on rate of shear strain*. PhD thesis, Massachusetts Institute of Technology.
- Heim, A. (1932). *Bergsturz und Menschenleben*. Zurich, *Vierteljahrsschrift* **77**, No. 20, Beiblatt. pp. 218.
- Howard, K. (1973). Avalanche mode of motion: implication from lunar examples. *Science* **180**, 1052-1055.
- Hsü, K. H. (1975). Catastrophic debris streams (stürzstroms) generated by rockfalls. *Bull. Geol. Soc. Am.* **86**, 129-140.
- Hungr, O. (1981). *Dynamics of rock avalanches and other types of slope movements*. PhD thesis, University of Alberta.
- Hungr, O. & Morgenstern, N. R. (1984). Experiments on the flow behaviour of granular materials at high velocity in an open channel. *Géotechnique* **34**, No. 3, 405-413.
- Hvorslev, M. J. (1939). Torsion shear tests and their place in the determination of the shearing resistance of soils. *Proc. Am. Soc. Test. Mater.* **39**, 999-1022.
- Kent, P. E. (1966). The transport mechanism in catastrophic rock falls. *J. Geol.* **74**, 79-83.
- Körner, H. J. (1977). Flow mechanisms and resistances in the debris streams of rock slides. *Bull. Int. Assoc. Engng Geol.* No. 16, 101-104.
- Lambe, T. W. & Whitman, R. V. (1979). *Soil mechanics, SI version*. New York: Wiley.
- McSaveney, M. J. (1978). Sherman Glacier rock avalanche, Alaska. In *Rockslides and Avalanches* (Voight, B., (ed.)) **1**, 197-258. Amsterdam: Elsevier.
- Novosad, J. (1964). Studies on granular materials II. *Collection Czech. Chem. Commun.* **29**, 2697.
- Scarlett, B. & Todd, A. C. (1969). The critical porosity of free-flowing solids. *J. Engng Ind. Ser. A*, **91**, Part 1, 478-488.
- Sheidegger, A. E. (1973). On the prediction of the reach and velocity of catastrophic landslides. *Rock Mech.* **5**, 231-236.
- Scheidegger, A. E. (1975). *Physical aspects of natural catastrophes*. New York: Elsevier.
- Shreve, R. L. (1968). The Blackhawk landslide. Memoir 108. Geological Society of America.

