

Higher order intersection numbers of 2-spheres in 4-manifolds

ROB SCHNEIDERMAN

PETER TEICHNER

Abstract

This is the beginning of an obstruction theory for deciding whether a map $f : S^2 \rightarrow X^4$ is homotopic to a topologically flat embedding, in the presence of fundamental group and in the absence of dual spheres. The first obstruction is Wall's self-intersection number $\mu(f)$ which tells the whole story in higher dimensions. Our second order obstruction $\tau(f)$ is defined if $\mu(f)$ vanishes and has formally very similar properties, except that it lies in a quotient of the group ring of two copies of $\pi_1 X$ modulo \mathcal{S}_3 -symmetry (rather than just one copy modulo \mathcal{S}_2 -symmetry). It generalizes to the non-simply connected setting the Kervaire-Milnor invariant defined in [2] and [12] which corresponds to the Arf-invariant of knots in 3-space.

We also give necessary and sufficient conditions for moving three maps $f_1, f_2, f_3 : S^2 \rightarrow X^4$ to a position in which they have *disjoint* images. Again the obstruction $\lambda(f_1, f_2, f_3)$ generalizes Wall's intersection number $\lambda(f_1, f_2)$ which answers the same question for two spheres but is not sufficient (in dimension 4) for three spheres. In the same way as intersection numbers correspond to linking numbers in dimension 3, our new invariant corresponds to the Milnor invariant $\mu(1, 2, 3)$, generalizing the Matsumoto triple [10] to the non simply-connected setting.

AMS Classification 57N13; 57N35

Keywords Intersection number, 4-manifold, Whitney disk, immersed 2-sphere, cubic form

1 Introduction

One of the keys to the success of high-dimensional surgery theory is the following beautiful fact, due to Whitney and Wall [14], [15]: A smooth map $f : S^n \rightarrow X^{2n}$, $n > 2$, is homotopic to an embedding if and only if a single obstruction $\mu(f)$ vanishes. This *self-intersection invariant* takes values in a quotient of

the group ring $\mathbb{Z}[\pi_1 X]$ by simple relations. It is defined by observing that generically f has only transverse double points and then counting them with signs and fundamental group elements. The relations are given by an \mathcal{S}_2 -action (from changing the order of the two sheets at a double point) and a framing indeterminacy (from a cusp homotopy introducing a local kink). Here \mathcal{S}_k denotes the symmetric group on k symbols.

It is well-known that the case $n = 2$, $f : S^2 \rightarrow X^4$, is very different [7], [11], [6]. Even though $\mu(f)$ is still defined, it only implies that the self-intersections of f can be paired up by Whitney disks. However, the Whitney moves, used in higher dimensions to geometrically remove pairs of double points, cannot be done out of three different reasons: The Whitney disks might not be represented by embeddings, they might not be correctly framed, and they might intersect f . Well known maneuvers on the Whitney disks show however, that the first two conditions may always be attained (by pushing down intersections and twisting the boundary).

In this paper we describe the next step in an obstruction theory for finding an embedding homotopic to $f : S^2 \rightarrow X^4$ by measuring its intersections with Whitney disks. Our main results are as follows, assuming that X is an oriented 4-manifold.

Theorem 1 *If $f : S^2 \rightarrow X^4$ satisfies $\mu(f) = 0$ then there is a well-defined (secondary) invariant $\tau(f)$ which depends only on the homotopy class of f . It takes values in the quotient of $\mathbb{Z}[\pi_1 X \times \pi_1 X]$ by relations additively generated by*

$$\begin{aligned} \text{(BC)} \quad & (a, b) = -(b, a) \\ \text{(SC)} \quad & (a, b) = -(a^{-1}, ba^{-1}) \\ \text{(FR)} \quad & (a, 1) = (a, a) \\ \text{(INT)} \quad & (a, \lambda(f, A)) = (a, \omega_2(A) \cdot 1). \end{aligned}$$

where $a, b \in \pi_1 X$ and A represents an immersed S^2 or $\mathbb{R}\mathbb{P}^2$ in X . In the latter case, the group element a is the image of the nontrivial element in $\pi_1(\mathbb{R}\mathbb{P}^2)$.

If one takes the obstruction theoretic point of view seriously then one should assume in Theorem 1 that in addition to $\mu(f) = 0$ all intersection numbers $\lambda(f, A) \in \mathbb{Z}[\pi_1 X]$ vanish. With these additional assumptions, $\tau(f)$ is defined in a quotient of $\mathbb{Z}[\pi_1 X \times \pi_1 X]$ by \mathcal{S}_3 -and framing indeterminacies. This is in complete analogy with $\mu(f)$!

To define $\tau(f)$, we pick framed Whitney disks for all double points of f , using that $\mu(f) = 0$. Then we sum up all intersections between f and the Whitney

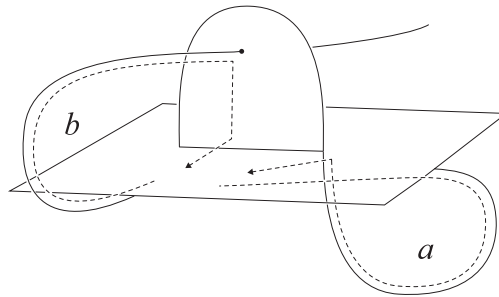

Figure 1

disks, recording for each such intersection point a sign and a pair $(a, b) \in \pi_1 X \times \pi_1 X$. Here a measures the primary group element of a double point of f and b is the secondary group element, see Figure 1. After introducing sign conventions, the \mathcal{S}_2 -action already present in $\mu(f)$ is easily seen to become the “sheet change” relation SC. The beauty of our new invariant now arises from the fact that the other relation, which is forced on us by being able to push around the intersections points, is of the surprisingly simple form BC (which stands for “boundary crossing” of Whitney arcs, as explained in Section 3). In particular, this means that the notion of *primary* and *secondary* group elements is not at all appropriate. Moreover, one easily checks that the two relations BC and SC together generate an \mathcal{S}_3 -symmetry on $\mathbb{Z}[\pi \times \pi]$, for any group π . We will give a very satisfying explanation of this symmetry after Definition 8, in terms of choosing one of three sheets that interact at a Whitney disk. The framing indeterminacy FR comes from the being able to twist the boundary of a Whitney disk, and the intersection relation INT must be taken into account since one can sum a 2-sphere into any Whitney disk. Finally, intersections with $\mathbb{R}P^2$'s come in because of an indeterminacy in the pairing of inverse images of double points whose primary group elements have order two, as discovered by Stong [12].

The geometric meaning of $\tau(f)$ is given by the following theorem, see Section 6 for the proof.

Theorem 2 $\tau(f) = 0$ if and only if f is homotopic to f' such that the self-intersections of f' can be paired up by framed immersed Whitney disks with interiors disjoint from f' . In particular, $\tau(f) = 0$ if f is homotopic to an embedding.

The Whitney disks given by Theorem 2 may intersect each other and also self-intersect. Trying to push down intersections re-introduces intersections with

f . Hence one expects third (and higher) order obstructions which measure intersections among the Whitney disks, pairing them up by secondary Whitney disks etc. These obstructions indeed exist in different flavors, one has been applied in [1] to classical knot concordance. In a future paper we will describe obstructions living in a quotient of the group ring of $\pi_1 X \times \cdots \times \pi_1 X$, where the number of factors reflects exactly the order of the obstruction. The obstructions will be labeled by the same uni-trivalent graphs that occur in the theory of finite type invariants of links in 3-manifolds. They satisfy the same antisymmetry and Jacobi-relations as in the 3-dimensional setting. The reason behind this is that invariants for the *uniqueness* of embeddings of 1-manifolds into 3-manifolds should translate into invariants for the *existence* of embeddings of 2-manifolds into 4-manifolds. Note that our $\tau(f)$ corresponds the letter Y-graph and antisymmetry is exactly our BC relation.

Remark 1 It is important to note that the relation INT implies that $\tau(f)$ vanishes in the presence of a framed dual sphere A . This implies that $\tau(f)$ is not relevant in the settings of the surgery sequence and the s-cobordism theorem. However, there are many other settings in which dual spheres don't exist, for example in questions concerning link concordance. The invariant τ therefore gives a new algebraic structure on $\pi_2(X)$ which has to be taken into account when trying to define the correct concept of homology surgery and Γ -groups in low dimensions.

There are many examples where μ and λ vanish but τ is nontrivial. For infinite fundamental groups, $\tau(f)$ can take values in an infinitely generated group, see the example in Section 4. If X is simply-connected then $\tau(f)$ takes values in $\mathbb{Z}/2$ or 0, depending on whether f is spherically characteristic or not. In the former case, $\tau(f)$ equals the spherical Kervaire-Milnor invariant introduced by Freedman-Quinn [2, Def.10.8]. If X is closed and simply connected then f has a dual sphere if and only if it represents an indivisible class in $H_2 X$. In this case f is represented by a topologically flat embedding if and only if $\tau(f) = 0$, see [2, Thm.10.3]. This result was extended independently by Hambleton-Kreck [5] and Lee-Wilczynski [8] to divisible classes f . They study *simple* embeddings, where the fundamental group of the complement of f is abelian (and $\pi_1(X) = 1$). Then there is an additional Rohlin obstruction [11] from the signature of a certain branched cover. Moreover, these authors show that f is represented by a simple embedding if and only if $\tau(f)$ and the Rohlin obstruction vanish. Gui-Song Li also studied the invariant τ in a special setting [9] which actually motivated our discussion.

The \mathcal{S}_3 -symmetry of τ comes from the fact that we cannot distinguish the three sheets interacting at a Whitney disk. It is therefore not surprising that there is a simpler version of this invariant, defined for three maps $f_1, f_2, f_3 : S^2 \rightarrow X^4$. It can be best formulated by first identifying $\pi \times \pi$ with the quotient $(\pi \times \pi \times \pi)/\Delta(\pi)$, where Δ denotes the diagonal *right* action of π . Let $\Lambda := \mathbb{Z}[(\pi \times \pi \times \pi)/\Delta(\pi)]$ which is a $\mathbb{Z}[\pi \times \pi \times \pi]$ -module via left multiplication. It also has an obvious \mathcal{S}_3 -action by permuting the three factors. This action agrees with the action generated by BC and SC if we make the correct identification of Λ with $\mathbb{Z}[\pi \times \pi]$.

Now define \mathcal{R} to be the $\mathbb{Z}[\pi \times \pi \times \pi]$ -submodule of Λ generated by

$$(a, b, \lambda(f_3, A)), (a, \lambda(f_2, A), b), (\lambda(f_1, A), a, b) \in \Lambda$$

where $a, b \in \pi := \pi_1 X$ and $A \in \pi_2 X$ are arbitrary. The following result will be proven in Section 7.

Theorem 3 *In the above notation, assume that $\lambda(f_i, f_j) = 0$ for $i \neq j$. Then there is a well defined secondary obstruction*

$$\lambda(f_1, f_2, f_3) \in \Lambda/\mathcal{R}$$

which only depends on the homotopy classes of the f_i . It vanishes if and only if the f_i are homotopic to three maps with disjoint images. Moreover, it satisfies the following algebraic properties (where $a, a' \in \pi$ and $\sigma \in \mathcal{S}_3$):

- (i) $\lambda(a \cdot f_1 + a' \cdot f'_1, f_2, f_3) = (a, 1, 1) \cdot \lambda(f_1, f_2, f_3) + (a', 1, 1) \cdot \lambda(f'_1, f_2, f_3)$,
- (ii) $\lambda(f_{\sigma(1)}, f_{\sigma(2)}, f_{\sigma(3)}) = \lambda(f_1, f_2, f_3)^\sigma$,
- (iii) $\lambda(f, f, f) = \sum_{\sigma \in \mathcal{S}_3} \tau(f)^\sigma$ if f has trivial normal bundle,
- (iv) $\tau(f_1 + f_2 + f_3) - \tau(f_1 + f_2) - \tau(f_1 + f_3) - \tau(f_2 + f_3) + \tau(f_1) + \tau(f_2) + \tau(f_3) = \lambda(f_1, f_2, f_3)$,
- (v) $\tau(a \cdot f) = a^{-1} \tau(f) a$.

These properties are the precise analogues of the fact that Wall's (λ, μ) is a “quadratic form” on $\pi_2(X)$ (or a hermitian form with a quadratic refinement), see [14, §5]. To make this precise one has to identify $\mathbb{Z}[(\pi \times \pi)/\Delta(\pi)]$ with $\mathbb{Z}[\pi]$ via the map

$$(a, b) \mapsto a \cdot b^{-1}.$$

Then the usual involution $a \mapsto a^{-1}$ corresponds to flipping the two factors which explains why (ii) above generalizes the notion of a *hermitian* form. It would be nice if one could formalize these “cubic forms”, guided by the above properties.

Note that if the primary intersection numbers $\lambda(f_i, A)$ vanish for all $A \in \pi_2 X$, then $\lambda(f_1, f_2, f_3)$ is well defined as an element of $\mathbb{Z}[\pi_1 X \times \pi_1 X]$. If X is simply-connected, this reduces to the Matsumoto triple from [10]. Garoufalidis and Levine have also introduced equivariant $\mu(1, 2, 3)$ -invariants in [3] for null homotopic circles in a 3-manifold N^3 . These invariants agree with our triple λ applied to three disks in $N^3 \times [0, 1]$ that display the null homotopies. If one wants to get spheres instead of disks, one should attach 2-handles to all the circles, and glue the cores to the null homotopies. In [3] the indeterminacies of the invariants are not discussed but it is shown that they agree for two links if and only if they are surgery equivalent [3, Thm.5].

The obstruction $\lambda(f_1, f_2, f_3)$ generalizes Wall's intersection number $\lambda(f_1, f_2)$ which answers the disjointness question for two spheres but is not sufficient (in dimension 4) for three spheres. In an upcoming paper we will describe necessary and sufficient obstructions for making n maps $f_1, \dots, f_n : S^2 \rightarrow X^4$ disjoint. The last obstructions will lie in the group ring of $(n-1)$ copies of $\pi_1 X$, assuming that all previous obstructions vanish.

The current paper finishes with Section 8 by giving the following generalization of Theorem 1 and Theorem 2 to the case of arbitrarily many maps.

Theorem 4 *Given $f_1, \dots, f_n : S^2 \rightarrow X^4$ with vanishing primary μ and λ -obstructions, there exists a well-defined secondary obstruction $\tau(f_1, \dots, f_n)$ which depends only on the homotopy classes of the f_i . This invariant vanishes if and only if, after a homotopy, all intersections and self-intersections can be paired up by Whitney disks with interiors disjoint from all $f_i(S^2)$. This is in particular the case if the f_i are homotopic to disjoint embeddings.*

The invariant $\tau(f_1, \dots, f_n)$ takes values in a quotient of $\binom{n}{1} + 2\binom{n}{2} + \binom{n}{3}$ copies of Λ which reflects the number of different combinations of possible intersections between Whitney disks and spheres.

In this paper we assume that our 4-manifolds are oriented and we work in the smooth category. However, our methods do not distinguish the smooth from the topological category since the basic results on topological immersions [2] imply a generalization of our results to the topological world.

2 Preliminaries

We refer the reader to the book by Freedman and Quinn [2, §1] for the basic definitions of things like Whitney disks, Whitney moves, finger moves and Wall's

intersection and self-intersection numbers λ and μ (see also [14]). We only make a couple of summarizing remarks.

Let $f : S^2 \rightarrow X^4$ be a smooth map. After a small perturbation we may assume that f is a generic immersion. This means that the singularities of f consist only of transverse self-intersection points. Furthermore, we may perform some cusp homotopies to get the signed sum of the self-intersection points of f to be zero as an integer. By an old theorem of Whitney, immersions $f : S^2 \looparrowright X^4$ as above, modulo regular homotopy, are the same as homotopy classes of maps $S^2 \rightarrow X^4$. We will thus assume that our maps $S^2 \looparrowright X^4$ are immersions with only transverse self-intersections whose signed sum is zero. Then we work modulo regular homotopy. The advantage of this approach comes from the fact that by general position, a regular homotopy is (up to isotopy) the composition of finitely many finger moves and then finitely many Whitney moves. This implies that $\mu(f)$ is well-defined in the quotient of the group ring $\mathbb{Z}[\pi_1 X]$ by the \mathcal{S}_2 -action $a \mapsto a^{-1}$.

Let $f : S^2 \looparrowright X^4$ be a generic immersion and let $p, q \in X$ be double points of opposite sign. Choose two embedded arcs in S^2 connecting the inverse images of p to the inverse images of q but missing each other and all other double points of f . The image γ of the union of these *Whitney arcs* is called a *Whitney circle* for p, q in X . Let $W : D^2 \looparrowright X$ be an immersion which is an embedding on the boundary with $W(S^1) = \gamma$. The normal bundle of W restricted to γ has a canonical nonvanishing section s_γ which is given by pushing γ tangentially to f along one of the Whitney arcs and normally along the other. Therefore, the relative Euler number of the normal bundle of W is a welldefined integer. If one changes W by a (nonregular) cusp homotopy then the Euler number changes by ± 2 , see [2, §1.3]. This implies that one really has a $\mathbb{Z}/2$ -valued framing invariant. An additional boundary twist can be used to change the Euler number by one. Note that this introduces an intersection between W and f and thus does not preserve the last property below.

Definition 5 Let $W : D^2 \looparrowright X$ be an immersion as above.

- (i) If W has vanishing relative Euler number, then it is called a *framed Whitney disk*. Some authors also add the adjective *immersed* but we suppress it from our notation.
- (ii) If in addition W is an embedding with interior disjoint from f , then W is called an *embedded Whitney disk* for f .

If W is an embedded Whitney disk one can do the Whitney move to remove the two double points p and q . If one of the conditions for an embedded Whitney

disk are not satisfied the Whitney move can still be done but it introduces new self-intersections of f .

The vanishing of $\mu(f)$ means that the double points of f occur in *cancelling pairs* with opposite signs and contractible Whitney circles. Therefore, there exists a collection of framed Whitney disks pairing up all the double points of f .

3 The invariant τ

In this section we define the invariant τ of Theorem 1 in terms of fundamental group elements which are determined by two kinds of intersections: Intersections between the interiors of Whitney disks and the sphere f and intersections among the boundary arcs of the Whitney disks. The definition will involve first making choices and then modding out the resulting indeterminacies. Many of these indeterminacies will be noted during the course of the definition but a complete proof that $\tau(f)$ is indeed well-defined (and only depends on the homotopy class of f) will be given in Section 5.

In the following discussion we will not make a distinction between f and its image unless necessary. Also, basepoints and their connecting arcs (*whiskers*) will be suppressed from notation.

Let $f : S^2 \looparrowright X^4$ be an oriented generic immersion with vanishing Wall self intersection invariant $\mu(f) = 0$. As explained above, the vanishing of $\mu(f)$ implies that we may choose framed Whitney disks W_i for all canceling pairs (p_i^+, p_i^-) of double points of f where $\text{sign}(p_i^+) = +1 = -\text{sign}(p_i^-)$. We may assume that the interiors of the Whitney disks are transverse to f . The boundary arcs of the W_i are allowed to have transverse intersections and self-intersections (as arcs in f).

Remark 2 In the literature it is often assumed that a collection of Whitney disks will have disjointly embedded boundary arcs. Whitney disks with immersed boundaries were called “weak” Whitney disks in [2] and [12]. Allowing such weak Whitney disks in the present setting will simplify the proof that τ is well-defined.

For each W_i choose a preferred arc of ∂W_i which runs between p_i^+ and p_i^- . We will call this chosen arc the *positive arc* of W_i and the arc of ∂W_i lying in the other sheet will be called the *negative arc*. We will also refer to a neighborhood

in f of the positive (resp. negative) arc as the *positive* (resp. *negative*) sheet of f near W_i . This choice of positive arc determines an orientation of W_i as follows: Orient ∂W_i from p_i^- to p_i^+ along the positive arc and back to p_i^- along the negative arc. The positive tangent to ∂W_i together with an outward pointing second vector orient W_i . The choice of positive arc also determines a fundamental group element g_i by orienting the double point loops to change from the negative sheet to the positive sheet at the double points p_i^\pm . (See Figure 2) Note that changing the choice of positive arc reverses the orientation of W_i and changes g_i to g_i^{-1} . These orientation conventions will be assumed in the definitions that follow.

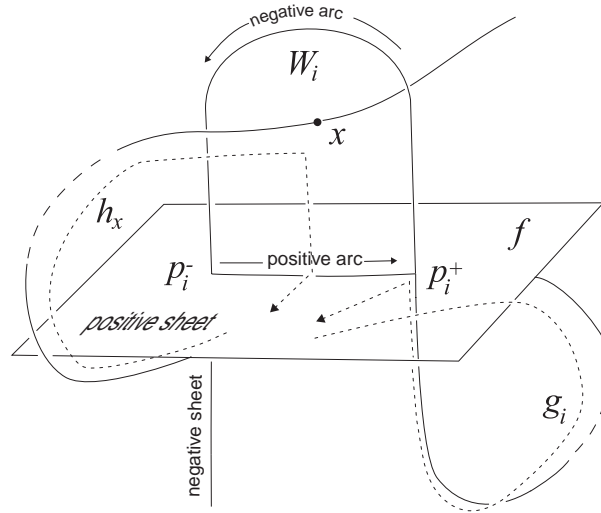

Figure 2: Whitney disk conventions.

For a point $x \in \text{int } W_i \cap f$, define $h_x \in \pi_1(X)$ from the following loop: Go first along f from the basepoint to x , then along W_i to the positive arc of W_i , then back to the basepoint along f . This loop (together with the whisker on f) determines h_x . (See Figure 2). Note that changing the choice of positive arc for W_i changes h_x to $h_x g_i^{-1}$.

NOTATION CONVENTION: For a sum of elements in the integral group ring $\mathbb{Z}[\pi_1 X \times \pi_1 X]$ with a common first component it will sometimes be convenient to write the sum inside the parentheses:

$$(g, \sum_j n_j \cdot g_j) := \sum_j n_j \cdot (g, g_j) \in \mathbb{Z}[\pi_1 X \times \pi_1 X].$$

We can now begin to measure intersections between the Whitney disks and f

by defining

$$I(W_i) := (g_i, \sum_x \text{sign}(x)h_x) \in \mathbb{Z}[\pi_1 X \times \pi_1 X]$$

where the sum is over all $x \in \text{int } W_i \cap f$, and $\text{sign}(x) = \pm 1$ comes from the orientations of f and W_i as above.

Remark 3 $I(W_i)$ encodes Wall-type intersections between W_i and f and can be roughly written as $(g_i, \lambda(W_i, f))$. We will see that $\tau(f)$ measures to what extent the *sum* over i is well-defined. This idea will be developed further in Section 7.

Next we set up notation to measure intersections between the boundaries of the Whitney disks. Denote the positive arc (resp. negative arc) of W_i by $\partial_+ W_i$ (resp. $\partial_- W_i$). Let y be any point in $\partial_{\epsilon_i} W_i \cap \partial_{\epsilon_j} W_j$ where the ordered basis $(\overrightarrow{\partial W_i}, \overrightarrow{\partial W_j})$ agrees with the orientation of f at y . Define

$$J(y) := \epsilon_i \epsilon_j (g_i^{\epsilon_i}, g_j^{\epsilon_j}) \in \mathbb{Z}[\pi_1 X \times \pi_1 X]$$

where $\epsilon_k \in \{+, -\} \hat{=} \{+1, -1\}$.

Note that by pushing W_i along ∂W_j , as in Figure 3, y could be eliminated at the cost of creating a new intersection point $x \in \text{int } W_i \cap f$ with $h_x = g_j^{\epsilon_j}$ whose contribution to $I(W_i)$ would be $\epsilon_i \epsilon_j (g_i^{\epsilon_i}, g_j^{\epsilon_j}) = J(y)$. Similarly, y could also be eliminated by pushing W_j along ∂W_i which would create a new intersection point in $\text{int } W_j \cap f$; however this new intersection point would contribute $-\epsilon_i \epsilon_j (g_j^{\epsilon_j}, g_i^{\epsilon_i})$ to $I(W_j)$ illustrating the need for the BC relation.

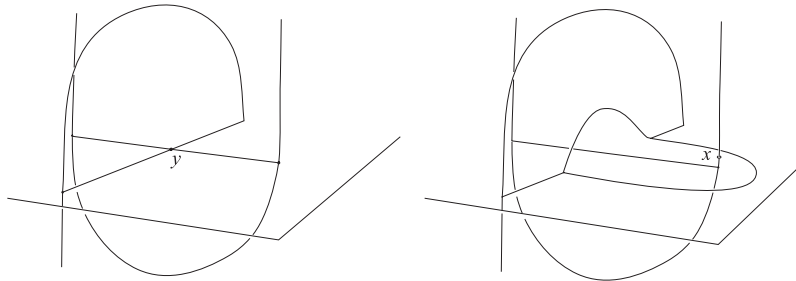

Figure 3: Eliminating an intersection between Whitneydisk boundaries creates an interior intersection between a Whitneydisk and f .

Having made the above choices we now define our invariant:

Definition 6 For f as above, define

$$\tau(f) := \sum_i I(W_i) + \sum_y J(y) \in \mathbb{Z}[\pi_1 X \times \pi_1 X]/\mathcal{R}$$

where the first sum is over all Whitney disks and the second sum is over all intersections between the boundaries of the Whitney disks.

The relations \mathcal{R} are additively generated by the following equations:

$$\begin{aligned} \text{(BC)} \quad & (a, b) = -(b, a) \\ \text{(SC)} \quad & (a, b) = -(a^{-1}, ba^{-1}) \\ \text{(FR)} \quad & (a, 1) = (a, a) \\ \text{(INT)} \quad & (a, \lambda(f, A)) = (a, \omega_2(A) \cdot 1). \end{aligned}$$

Here a and b are any elements in $\pi_1 X$ and $1 \in \pi_1 X$ is the trivial element. The labels BC, SC, FR and INT stand for “boundary crossing”, “sheet change”, “framing” and “intersections”, respectively. As discussed above, the BC relation comes from the indeterminacy in the J -component of $\tau(f)$ and the other three relations come from indeterminacies in the I -component of $\tau(f)$. The sheet change SC has been already discussed above, whereas FR comes about as follows: Changing a Whitney disk W_i by a boundary twist around the positive (resp. negative) arc creates $x \in \text{int } W_i \cap f$ with $h_x = 1 \in \pi_1(X)$ (resp. $h_x = g_i \in \pi_1 X$). After introducing an even number of boundary twists, the correct framing on W_i can be recovered by introducing interior twists (if necessary); this changes $I(W_i)$ by $(g_i, n + m \cdot g_i)$ where n and m are integers and $n \equiv m$ modulo 2. Note that by the BC and SC relations we have

$$(a, 1) = -(1, a) = (1, a) = -(a, 1) \iff (a, 2) = 0$$

and hence the relation FR above is all that is needed in addition to this relation.

The INT relation comes from changing the homotopy class of W_i by tubing into any 2-sphere A . After correcting the framing on W_i by boundary-twists (if necessary) this changes $I(W_i)$ by $(g_i, \lambda(f, A) + \omega_2(A) \cdot 1)$. The ω_2 term is only defined modulo 2 but still makes sense in $\mathbb{Z}[\pi_1 X \times \pi_1 X]/\mathcal{R}$ because $(g_i, 2) = 0$.

The INT relation should, in fact, be interpreted in a more general sense which we now describe. This goes back to an error in [2] as corrected by Stong [12]. In the case where $a \in \pi_1 X$ satisfies $a^2 = 1$, then we allow A to be not just any immersed 2-sphere in X but also any immersed \mathbb{RP}^2 in X representing a , that is, a is the image of the generator of the fundamental group of \mathbb{RP}^2 . In general, a Wall intersection between an immersed \mathbb{RP}^2 and f is not well-defined because

\mathbb{RP}^2 is not simply connected. However, the expression $(a, \lambda(f, A))$ makes sense in $\mathbb{Z}[\pi_1 X \times \pi_1 X]/\mathcal{R}$ because of the SC relation which accounts exactly for the fundamental group of \mathbb{RP}^2 and the orientation-reversing property of any non-trivial loop. As will be seen in the proof of Theorem 1 below, the INT relation in this case corresponds to a subtle indeterminacy in the choice of Whitney disk for a cancelling pair of double points whose group element a has order two.

Remark 4 It is interesting to note that one can always use finger moves to eliminate all intersections between f and the interiors of the W_i so that $\tau(f)$ is given completely in terms of the J contributions from intersections between the boundary arcs ∂W_i . On the other hand, the boundary arcs ∂W_i can always be made to be disjointly embedded (Figure 3) so that $\tau(f)$ is completely given in terms of the contributions to the $I(W_i)$ coming from intersections between f and the interiors of the W_i .

Remark 5 If X is simply connected then $\mathbb{Z}[\pi_1 X \times \pi_1 X]/\mathcal{R}$ is $\mathbb{Z}/2$ or 0 depending on whether f is spherically characteristic or not. Moreover, $\tau(f)$ reduces to the spherical Kervaire-Milnor invariant $km(f) \in \mathbb{Z}_2$ described in [2] and [12]. If X is not simply connected then $km(f)$ is equal to $\tau(f)$ mapped forward via $\pi_1 X \rightarrow \{1\}$.

Remark 6 One can modify the relations \mathcal{R} to get a version of τ that ignores the framings on the Whitney disks and a corresponding unframed version of Theorem 2: Just change the FR relation to $(a, 1) = 0$ and note that this kills the ω_2 term in the INT relation.

4 Examples

In this section we describe examples of immersed spheres $f : S^2 \looparrowright X$ such that $\mathbb{Z}[\pi_1 X \times \pi_1 X]/\mathcal{R}$ is infinitely generated and $\tau(f)$ realizes any value in $\mathbb{Z}[\pi_1 X \times \pi_1 X]/\mathcal{R}$.

Figure 4 shows the case $(l, m, n) = (2, 4, 3)$ of a family of 2-component links in $S^3 = \partial B^4$ indexed by triples of integers. A 4-manifold X is described by removing a tubular neighborhood of the obvious spanning disk (pushed into B^4) for the dotted component and attaching a 0-framed 2-handle to the other component. A meridian t to the dotted component generates $\pi_1 X = \langle t \rangle \cong \mathbb{Z}$. The other component is an “equator” to an immersed 2-sphere $f : S^2 \looparrowright X$ with $\mu(f) = 0$ which generates $\pi_2(X)$ as we now describe. One hemisphere of f is the

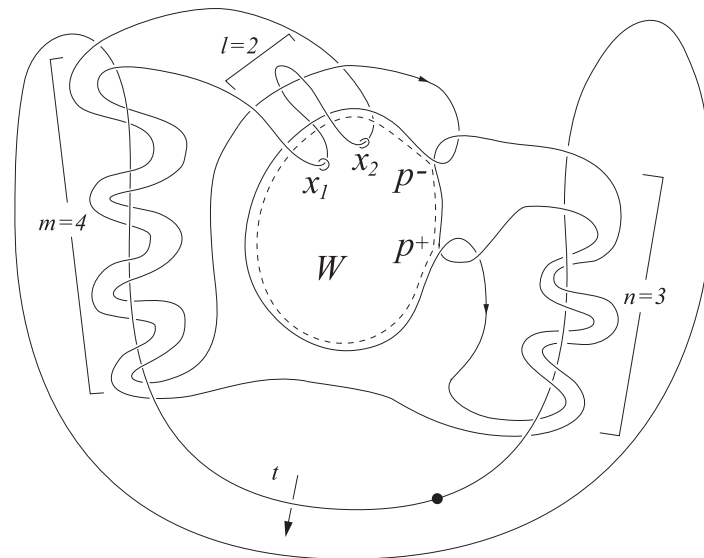

Figure 4

core of the 2-handle. The other hemisphere of f is the trace of a nullhomotopy of the equator in a collar of X . This nullhomotopy is described by changing the two crossings labeled p^\pm and then capping off the resulting unknot with an embedded disk. The only two double points of f come from the crossing changes of the nullhomotopy and form a canceling pair with corresponding group element t^n . The dashed loop indicates a collar of a framed embedded Whitney disk W for this canceling pair. The interior of W intersects f in l points x_j , $j = 1, 2, \dots, l$, with $h_{x_j} = t^m$ for all j . It follows that $\tau(f) = l(t^n, t^m) \in \mathbb{Z}[\pi_1 X \times \pi_1 X]$. By band summing different members of this family of links one can generalize this construction to describe $f : S^2 \looparrowright X$ with $\mu(f) = 0$, $\pi_1 X = \mathbb{Z}$, and $\pi_2(X) = \langle f \rangle$ such that $\tau(f)$ realizes any value in $\mathbb{Z}[\pi_1 X \times \pi_1 X]/\mathcal{R}$.

Since f generates $\pi_2(X)$ and $\mu(f) = 0$ (and $\omega_2(f) = 0$) the INT relation is trivial. So in this case $\mathbb{Z}[\pi_1 X \times \pi_1 X]/\mathcal{R}$ is the quotient of $\mathbb{Z}[\mathbb{Z}^2]$ by the order 6 orbits of the \mathcal{S}_3 action generated by the SC and BC relations together with the identification of the diagonal with the first factor given by the FR relation. In particular $\mathbb{Z}[\pi_1 X \times \pi_1 X]/\mathcal{R}$ is not finitely generated.

5 Proof of Theorem 1

To prove Theorem 1 we first show that $\tau(f)$ (as defined in Section 3) is well-defined by considering all the possible indeterminacies in the Whitney disk construction used to define τ and then check that $\tau(f)$ is unchanged by finger moves and Whitney moves on f which generate homotopies of f . The outline of our proof mirrors the arguments in [2], [12] with the added complications of working with signs and $\pi_1 X$.

In the setting of Section 3, let $f : S^2 \looparrowright X$ be a generic immersion with $\mu(f) = 0$ and cancelling pairs of double points (p_i^+, p_i^-) paired by framed Whitney disks W_i with chosen positive arcs.

Changing the choice of positive arc for a Whitney disk W_i changes the orientation of W_i and changes the contribution to $I(W_i)$ of each $x \in \text{int}(W_i) \cap f$ from $\pm(g_i, h_x)$ to $\mp(g_i^{-1}, h_x g_i^{-1})$. This does not change $\tau(f)$ by the SC relation.

Consider the effect on $I(W_i)$ of changing the interior of a Whitney disk W_i : Let W_i' be another framed Whitney disk with $\partial W_i' = \partial W_i$. After performing boundary twists on W_i (if necessary), W_i (minus a small collar on the boundary) and W_i' (with the opposite orientation and minus a small collar on the boundary) can be glued together to form an immersed 2-sphere A which is transverse to f . If n boundary twists were done around the positive arc and m boundary twists were done around the negative arc we have

$$I(W_i) - I(W_i') = (g_i, \lambda(f, A)) + n(g_i, 1) + m(g_i, g_i) = (g_i, \lambda(f, A)) + (n + m) \cdot 1$$

where the second equality comes from the FR relation. Since (before the boundary twists) W_i and W_i' were correctly framed we have $n + m \equiv \omega_2(A) \pmod{2}$. It follows that $I(W_i) - I(W_i')$ equals zero in $\mathbb{Z}[\pi_1 X \times \pi_1 X]/\mathcal{R}$ by the INT relation. Thus the contribution of $I(W_i)$ to $\tau(f)$ only depends on ∂W_i .

Now consider changing ∂W_i by a regular homotopy rel (p_i^+, p_i^-) . Such a homotopy extends to a regular homotopy of W_i which is supported in a small collar on ∂W_i . Away from the double points of f the homotopy can create or eliminate pairs of intersections between boundary arcs. These pairs have canceling J contributions so that $\tau(f)$ is unchanged. When the homotopy crosses a double point p_j of f a new intersection $x \in f \cap \text{int}(W_i)$ and a new intersection $y \in \partial_{\epsilon_i} W_i \cap \partial_{\epsilon_j} W_j$ are created (see Figure 5). One can check that the contribution of x to $I(W_i)$ is cancelled in $\mathbb{Z}[\pi_1 X \times \pi_1 X]/\mathcal{R}$ by $J(y)$: If $\epsilon_i = + = \epsilon_j$ and the orientation of f at y agrees with $(\overrightarrow{\partial W_i}, \overrightarrow{\partial W_j})$ then x contributes $-(g_i, g_j)$ and $J(y) = (g_i, g_j)$; If $\epsilon_i = + = \epsilon_j$ and the orientation of f at y agrees with $(\overrightarrow{\partial W_j}, \overrightarrow{\partial W_i})$ then x contributes $+(g_i, g_j)$ and $J(y) = (g_j, g_i) = -(g_i, g_j)$ by the

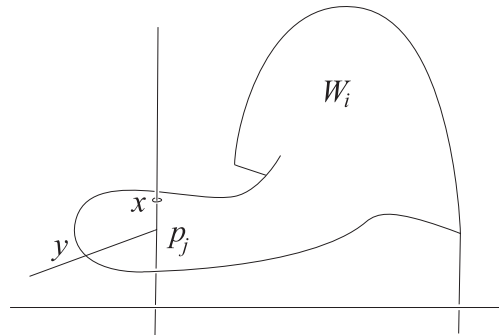

Figure 5

BC relation. Other cases are checked similarly. Since any two collections of immersed arcs (with the same endpoints) in a 2-sphere are regularly homotopic (rel ∂), it follows that $\tau(f)$ does not depend on the choices of Whitney disks for given pairings (p_i^+, p_i^-) of the double points of f .

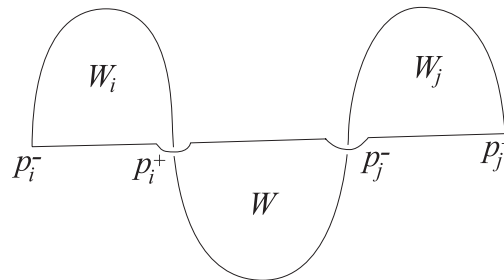

Figure 6

To show that $\tau(f)$ is well-defined it remains to check that it does not depend on the choice of pairings of double points. If (p_i^+, p_i^-) and (p_j^+, p_j^-) are paired by Whitney disks W_i and W_j with $g_i = g_j$ then (p_i^+, p_j^-) and (p_j^+, p_i^-) are also canceling pairs. Let W be a Whitney disk for (p_i^+, p_j^-) . A framed Whitney disk W' for (p_j^+, p_i^-) can be formed by connecting W to W_i and W_j using twisted strips as in Figure 6 so that

$$I(W) + I(W') = I(W) + I(W_i) + I(W_j) - I(W) = I(W_i) + I(W_j).$$

Since any two choices of pairings are related by a sequence of interchanging pairs of double points in this way, it follows that $\tau(f)$ does not depend on how the pairs are chosen from the double points with the same group elements and opposite signs.

There is one more subtlety to check regarding the pairings which is discussed in [12] but neglected in [2]: the pairing of the *pre-images* of a canceling pair (p_i^+, p_i^-) of double points with group element g_i such that $g_i^2 = 1$. Since $g_i = g_i^{-1}$, the inverse image of the positive arc of a Whitney disk W_i can join an inverse image of p_i^- to *either* of the two inverse images of p_i^+ .

Let W_i and W_i' be Whitney disks corresponding to the two ways of pairing the inverse images of such a canceling pair (p_i^+, p_i^-) with $g_i^2 = 1$. The union of the inverse images of the boundary arcs of W_i and W_i' is a loop c in S^2 which is the union of two pairs of arcs $c_{\pm} := f^{-1}(\partial_{\pm} W_i)$ and $c'_{\pm} := f^{-1}(\partial_{\pm} W_i')$ (see Figure 7). By previous arguments we may assume that c is embedded and bounds a 2-cell D in S^2 such that f restricts to an embedding on D . The union A of the image of D together with W_i and W_i' is (after rounding corners) an immersed $\mathbb{R}P^2$ representing g_i . Since W_i and W_i' are correctly framed, the number of new intersections between A and f that are created by perturbing A to be transverse to f will be congruent to $\omega_2(A)$ modulo 2. Each of these new intersections will have group elements g_i or 1 so that

$$I(W_i) - I(W_i') = (g_i, \lambda(f, A) + \omega_2(A)).$$

Thus $\tau(f)$ does not depend on the choice of the pairings of the pre-images of the double points by the INT relation.

Remark 7 If $\pi_1 X$ has no 2-torsion then the above immersion $\mathbb{R}P^2 \looparrowright X$ is spherical and hence the INT relation only consists of intersections with spheres.

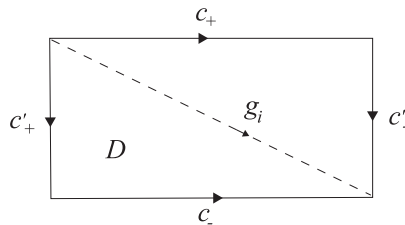

Figure 7: The inverse image of the boundaries of two Whitney disks for a canceling pair of doublepoints with group element g_i where $g_i^2 = 1$.

We have shown that $\tau(f)$ is well-defined; it remains to show that it is a homotopy invariant. As explained in Section 2 it suffices to show that it is invariant ambient isotopies, finger moves, and (embedded) Whitney moves so we will check that these moves do not change $\tau(f)$. Any isotopy of f can be extended to the Whitney disks without creating any new intersections between f and the

interiors of the Whitney disks so that $\tau(f)$ is unchanged. A finger move creates a cancelling pair of double points of f equipped with a *clean* Whitney disk W , i.e. W is embedded and $\text{int } W \cap f = \emptyset$. Since a finger move is supported in a neighborhood of an arc it can be assumed to miss all pre-existing Whitney disks. Thus $\tau(f)$ is unchanged by finger moves. A Whitney move on f pre-supposes the existence of a clean Whitney disk W . We may assume that W is included in any collection of Whitney disks used to compute $\tau(f)$. The boundaries of all other Whitney disks can be made disjoint from ∂W by applying the move of Figure 3 which does not change $\tau(f)$. A Whitney move on W eliminates the double points paired by W and creates a pair of new intersections between f and $\text{int } W_i$ for each point of intersection in $\text{int } W \cap \text{int } W_i$. These new pairs of intersections have cancelling contributions to $\tau(f)$ and so the net change is zero. \square

6 Proof of Theorem 2

The “if” directions of Theorem 2 are clear from the definition of $\tau(f)$. The “only if” direction will be shown using the following lemma.

Lemma 7 *If $\tau(f) = 0$ then after a homotopy of f (consisting of finger moves) the self-intersections of f can be paired up by framed Whitney disks W_i with disjointly embedded boundaries such that $I(W_i) = 0 \in \mathbb{Z}[\pi_1 X \times \pi_1 X]$ for all i .*

The geometric content of this lemma is that all the intersections between f and the interior of each Whitney disk W_i are paired by a second layer of Whitney disks: Since $I(W_i) = 0$ the intersections between $\text{int } W_i$ and f come in pairs x_{ij}^\pm where $h_{x_{ij}^+} = h_{x_{ij}^-} \in \pi_1 X$ and $\text{sign } x_{ij}^+ = -\text{sign } x_{ij}^-$. The union of an arc in W_i (missing all double points of W_i) joining x_{ij}^\pm and an arc in f joining x_{ij}^\pm (and missing all double points of f) is a nullhomotopic loop which bounds a Whitney disk V_{ij} for the pair x_{ij}^\pm (See Figure 8).

The proof of Lemma 7 will be given shortly, but first we use it to complete the proof of Theorem 2.

We may assume, as just noted, that the self-intersections of f are paired by framed Whitney disks W_i with disjointly embedded boundaries such that all intersections between the interiors of the W_i and f are paired by Whitney disks V_{ij} . The V_{ij} can be assumed to be correctly framed after introducing boundary twists (if necessary) around the arcs of the ∂V_{ij} that lie on the W_i .

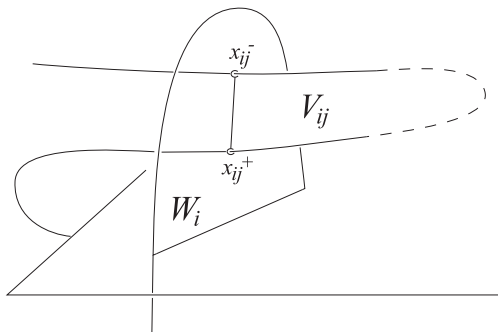
Figure 8: A secondary Whitneydisk V_{ij} .

The proof of Theorem 2 can be completed in two steps: First use finger moves on f to trade all intersections between f and the interiors of the V_{ij} for new self-intersections of f . These new self-intersections come paired by clean Whitney disks disjoint from all other W_i . Next use the V_{ij} to guide Whitney moves on the W_i eliminating all intersections between f and the interiors of the W_i . This second step may introduce new interior intersections between Whitney disks but these are allowed. These modified W_i together with the new clean Whitney disks have interiors disjoint from f and disjointly embedded boundaries. \square

It remains to prove Lemma 7. The idea of the proof is to first arrange for $\tau(f)$ to be given just in terms of cancelling pairs of intersections between f and the interiors of the Whitney disks; then using the move described in Figure 10 each cancelling pair can be arranged to occur on the same Whitney disk.

Proof Let f satisfy $\tau(f) = 0$ and W_i be framed Whitney disks pairing all the double points of f . The W_i may be assumed to have disjointly embedded boundaries after applying the move of figure 3. We now describe three modifications of f and the collection of Whitney disks which can be used to geometrically realize the relations FR, INT, and BC so that $\tau(f)$ vanishes in the quotient of $\mathbb{Z}[\pi_1 X \times \pi_1 X]$ by the single relation SC. (1) A finger move on f guided by an arc representing $a \in \pi_1(X)$ creates a cancelling pair of double points of f which are paired by a clean Whitney disk W . By performing boundary twists and interior twists on W one can create intersections between $\text{int } W$ and f so that $I(W) = n(a, 1) + m(a, a)$ for any integers n and m such that $n \equiv m$ modulo 2. (2) By similarly creating a clean Whitney disk W and tubing into any immersed sphere representing $A \in \pi_2(X)$ it can be arranged that $I(W) = (a, \lambda(f, A) + \omega_2(A))$. (3) If a Whitney disk W has an interior

intersection point x with f that contributes $\pm(a, b)$ to $I(W)$ then x may be eliminated by a finger move at the cost of creating a new pair p^\pm of double points of f which admit a Whitney disk W' (with embedded boundary disjoint from existing Whitney disks) such that $\text{int } W'$ has a single intersection with f and $I(W') = \mp(b, a)$ (See Figure 9). By using these three modifications we may assume that our collection of Whitney disks satisfies $\sum_i I(W_i) = 0$ in $\mathbb{Z}[\pi_1 X \times \pi_1 X]$ modulo the SC relation.

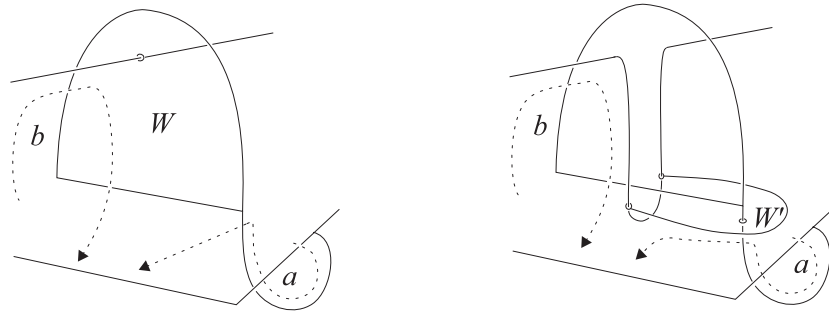

Figure 9

We can now move pairs of intersection points which have algebraically cancelling contributions to $\tau(f)$ on to the same Whitney disk as follows (see [16] for a detailed description of the simply-connected case.) The finger move illustrated in Figure 10 exchanges a point $x \in \text{int } W_j \cap f$ that contributes (a, b) to $I(W_j)$ for a point $x' \in \text{int } W_i \cap f$ that contributes (a, b) to $I(W_i)$. This finger move also creates two new double points of f which admit a Whitney disk W (with ∂W embedded and disjoint from all other Whitney disks) such that $I(W) = (b, a) - (b, a) = 0$. By performing this finger move through the negative arc of W_j instead of the positive arc one can similarly exchange a point $x \in \text{int } W_j \cap f$ that contributes $-(a^{-1}, ba^{-1})$ to $I(W_j)$ for a point $x' \in \text{int } W_i \cap f$ that contributes (a, b) to $I(W_i)$. In this way it can be arranged that all double points of f are paired by Whitney disks W_i such that $I(W_i) = 0 \in \mathbb{Z}[\pi_1 X \times \pi_1 X]$ for all i .

□

7 An invariant for a triple of immersed spheres

In this section we define the cubic invariant $\lambda(f_1, f_2, f_3)$ of Theorem 3 and sketch the proof that it gives a complete obstruction to making the f_i disjoint.

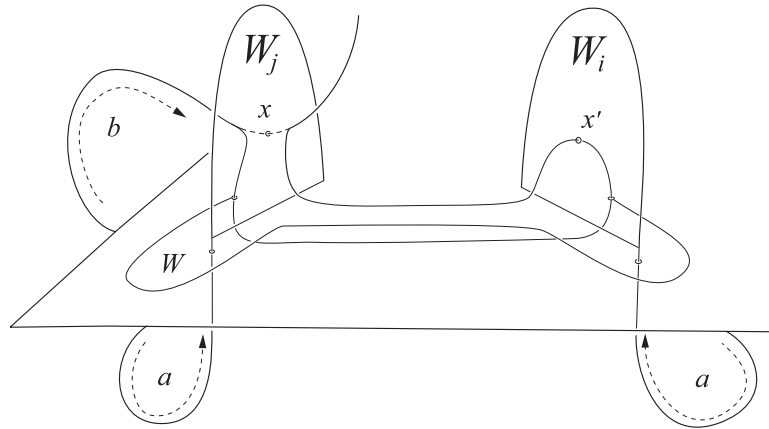

Figure 10

The invariant is again given in terms of fundamental group elements determined by secondary intersections, where in this case the relevant intersections are between Whitney disks on two of the spheres and the *other* sphere. However, we will pursue the point of view of Remark 3 and define the group elements via Wall-type intersections between the f_i and the Whitney disks. While this approach initially increases the indeterminacy (due to choosing whiskers for all the Whitney disks) it will eventually serve to symmetrize the algebra and clarify the origin of the \mathcal{S}_3 -action in the invariant $\tau(f)$ for a single map of a sphere. As before, we get an invariant taking values in a quotient of $\mathbb{Z}[\pi \times \pi]$, this time via the identification with $\mathbb{Z}[\pi \times \pi \times \pi / \Delta(\pi)]$ where Δ denotes the diagonal right action of $\pi := \pi_1 X$.

Let $f_1, f_2, f_3 : S^2 \looparrowright X$ be an ordered triple of oriented immersed spheres with pairwise vanishing Wall intersections $\lambda(f_i, f_j) = 0$ in an oriented 4-manifold X . Choose Whitney disks with disjointly embedded boundaries pairing all intersections between f_i and f_j for each pair $i \neq j$. The notation for Wall intersections tacitly assumes that each f_i is equipped with a whisker (an arc connecting a basepoint on f_i to the basepoint of X). Now choose whiskers for each of the Whitney disks. Orient all the Whitney disks as follows: If W^{ij} is a Whitney disk for a cancelling pair of intersections between f_i and f_j with $i < j$ then take the positive (resp. negative) arc of W^{ij} to lie on f_i (resp. f_j). As in Section 3, orient W^{ij} by orienting ∂W^{ij} in the direction of the positive intersection point along the positive arc then back to the negative intersection point along the negative arc and taking a second outward-pointing vector. To each intersection point x between f_k and the interior of a Whitney disk W^{ij}

for a cancelling pair in $f_i \cap f_j$ we associate three fundamental group elements as follows: The *positive* (resp. *negative*) group element is determined by a loop along the positive (resp. negative) sheet, then back along W^{ij} (and the whisker on W^{ij}). The *interior* group element is determined by a loop along f_k to x and back along W^{ij} . The three group elements are ordered by the induced ordering of $\{i, j, k\}$ on the sheets. Thus each such x determines an element in $\Lambda := (\pi \times \pi \times \pi)/\Delta(\pi)$ where the diagonal right action Δ is divided out in order to remove the choice of the whisker for the Whitney disks. Denoting the positive, negative and interior elements for $x \in \text{int } W_r^{ij} \cap f_k$ by g_r^+ , g_r^- and h_x respectively, we now set up notation to measure the intersections between the spheres and the Whitney disks by defining three elements in the abelian group $\Lambda := \mathbb{Z}[(\pi \times \pi \times \pi)/\Delta(\pi)]$ as follows:

$$I_3(W_r^{12}) := \sum_{x \in W_r^{12} \cap f_3} \text{sign}(x)(g_r^+, g_r^-, h_x) \in \Lambda,$$

$$I_2(W_r^{13}) := \sum_{x \in W_r^{13} \cap f_2} -\text{sign}(x)(g_r^+, g_r^-, h_x) \in \Lambda,$$

and

$$I_1(W_r^{23}) := \sum_{x \in W_r^{23} \cap f_1} \text{sign}(x)(g_r^+, g_r^-, h_x) \in \Lambda.$$

Denote by \mathcal{R} the subgroup additively generated by

$$(a, b, \lambda(f_3, A)), (a, \lambda(f_2, A), c), (\lambda(f_1, A), b, c) \in \Lambda$$

where $a, b, c \in \pi$ and $A \in \pi_2 X$ are arbitrary.

Definition 8 In the above setting define

$$\lambda(f_1, f_2, f_3) := \sum_r I(W_r^{12}) + \sum_r I(W_r^{23}) + \sum_r I(W_r^{31}) \in \Lambda/\mathcal{R}.$$

where the sums are over all Whitney disks for the intersections between the f_i .

Remark 8 By modifying the construction of Section 4 one can describe many triples with non-vanishing $\lambda(f_1, f_2, f_3)$, for instance by shrinking three components of the Bing double of the Hopf link in the complement of the fourth component.

Before sketching the proof of Theorem 3 we now describe a nice formalism which explains the presence of the \mathcal{S}_3 indeterminacy in the definition of $\tau(f)$ which is absent in the case of $\lambda(f_1, f_2, f_3)$ for a triple. In both cases one assigns (two respectively three) fundamental group elements to each intersection point between the interior of a Whitney disk and a sheet of a sphere which we will refer to as the *interior* sheet.

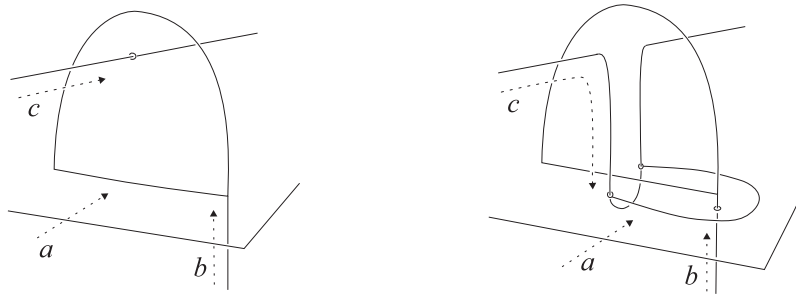

Figure 11

For each such intersection point the corresponding interior sheet “interacts” with the positive and negative sheets of the Whitney disk in the following sense: By pushing down the interior sheet into the positive (resp. negative) sheet one can eliminate the original intersection point at the cost of creating a new cancelling pair of intersections which admits a new Whitney disk which has an interior intersection point with the negative (resp. positive) sheet (see Figure 11). Note that this trading of one intersection point for another takes place in a neighborhood of the original Whitney disk and the effect of pushing down into a sheet is the same as the effect of doing a Whitney move (see Figure 12). It is clear that any invariant defined in terms of such intersections will have “local” indeterminacies corresponding to this local interaction between the three sheets.

This interaction can be described by associating a decorated uni-trivalent tree with one interior vertex to each intersection point x between the interior of a Whitney disk and a sheet as follows (see Figure 13). The interior vertex represents the Whitney disk and the three univalent vertices represent sheets of f_i , f_j and f_k , two of which are the positive and negative sheets of the Whitney disk, the other being the interior sheet corresponding to x . The three edges are oriented inward and represent the corresponding positive, negative and interior group elements. *The relations that are forced on the triple of group elements by the above described interactions between the sheets correspond to (signed) graph automorphisms of the tree which preserve the labels of the univalent vertices*

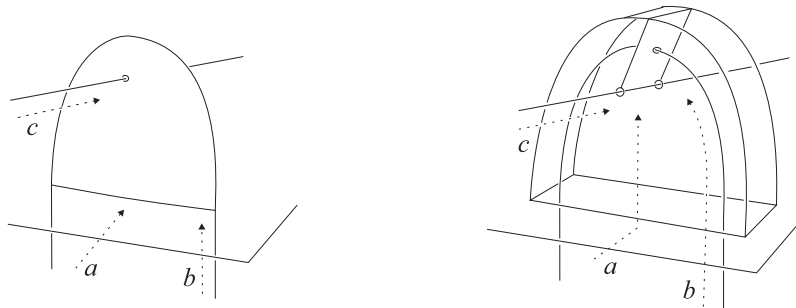

Figure 12

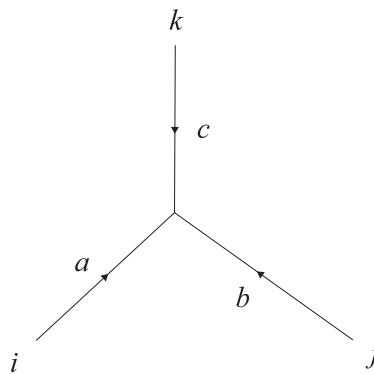

Figure 13

(with the sign given by the sign of the induced permutation of the vertices).

In particular, if $i = j = k$ as in the case of $\tau(f)$, then the automorphism group is \mathcal{S}_3 . In fact, if one defines $\tau(f)$ by the conventions of this section (i.e., choosing whiskers for the Whitney disks, etc.) then the \mathcal{S}_3 -action is obvious because the SC and BC relations become $(a, b, c) = -(b, a, c)$ and $(a, b, c) = -(a, c, b)$ respectively. If i, j and k are distinct as in the case of $\lambda(f_1, f_2, f_3)$ then the automorphism group is trivial and no “local” relations are needed. We will see in Section 8 that the expected \mathcal{S}_2 indeterminacy (corresponding to graph automorphisms which fix one univalent vertex) is present in the definition of $\tau(f_1, f_2)$ for a pair.

Remark 9 Higher order generalizations of τ will have indeterminacies that correspond to antisymmetry and Jacobi relations known from the theory of finite type invariants of links in 3-manifolds.

We now give a proof of Theorem 3. Since the arguments are essentially the same as those of Section 5 (with the added convenience of working with much less indeterminacy) the steps will be indicated with details omitted.

Proof First note that since the f_i are ordered all the Whitney disks are canonically oriented via our convention. Thus the signs associated to the intersections between the Whitney disks and the f_i are well-defined. Also, the element of Λ associated to such an intersection point does not depend on the choice of whisker for the Whitney disk because we are modding out by the diagonal right action $\Delta(\pi)$ of π . Since any two Whitney disks with the same boundary differ by an element $A \in \pi_2 X$, $\lambda(f_1, f_2, f_3)$ does not depend on the choices of the interiors of the Whitney disks because it is measured in the quotient of Λ by \mathcal{R} .

In order to show that $\lambda(f_1, f_2, f_3)$ does not depend on the boundaries of the Whitney disks it is convenient to generalize the definition of $\lambda(f_1, f_2, f_3)$ to allow weak Whitney disks along the lines of Section 3. For each $y \in \partial W^{ij} \cap \partial W^{ik}$, where $j \neq k$ and $(\overrightarrow{\partial W^{ij}}, \overrightarrow{\partial W^{ik}})$ agrees with the orientation of f_i at y , define $J(y) \in \Lambda$ from the following three group elements: Give W^{ij} and W^{ik} a common whisker at y then take the positive and negative group elements of W^{ij} together with the group element of W^{ik} corresponding to the sheet f_k . Define the sign of $J(y)$ to be equal to the sign of the permutation (ijk) . The generalized definition of $\lambda(f_1, f_2, f_3)$ includes the sum of $J(y)$ over such y . Note that this generalization does not require any new relations and reduces to the original definition after eliminating the intersections and self-intersections between boundaries of the Whitney disks in the usual way (Figure 3). The arguments of Section 5 now apply to show that $\lambda(f_1, f_2, f_3)$ does not depend on the boundaries of the Whitney disks: pushing the boundary of a Whitney disk across an intersection point (Figure 5) creates an interior intersection in the collar of the Whitney disk and a boundary intersection with cancelling contributions to $\lambda(f_1, f_2, f_3)$. Independence of the choice of pairings of the intersection points (see Figure 6) also follows. Note that in the present setting there are no subtleties concerning the pre-images of intersection points. Thus $\lambda(f_1, f_2, f_3)$ is well-defined.

To see that $\lambda(f_1, f_2, f_3)$ is invariant under homotopies of the f_i it suffices to check invariance under finger moves and Whitney moves on embedded Whitney disks. Finger moves only create embedded Whitney disks which clearly don't change $\lambda(f_1, f_2, f_3)$. A Whitney move on an embedded Whitney disk W which eliminates a pair of self-intersections on f_i will create a new pair of intersections between f_i and W^{jk} for each intersection between W^{jk} and W , but these

new intersections have cancelling contributions to $\lambda(f_1, f_2, f_3)$ which remains unchanged. The same applies to a Whitney move that eliminates a pair of intersections between two different spheres and since the embedded Whitney disk can be assumed to have been included in any collection used to compute $\lambda(f_1, f_2, f_3)$ again the invariant is unchanged. Thus $\lambda(f_1, f_2, f_3)$ only depends on the homotopy classes of the f_i .

It follows directly from the definition that $\lambda(f_1, f_2, f_3)$ satisfies properties (i), (ii), (iv) and (v) of Theorem 3. Property (iii) can be checked as follows: $\lambda(f, f, f) = \lambda(f_1, f_2, f_3)$ where the f_i are parallel copies of f . Since the normal bundle of f is trivial, each self-intersection of f gives nine intersection points among the f_i of which exactly three are self-intersections. Thus each Whitney disk W for a canceling pair of *self*-intersections of f yields six canceling pairs of intersections among the f_i paired by Whitney disks which are essentially parallel copies of W . If W has an interior intersection with f that contributes (a, b, c) to $\tau(f)$ (expressed in the notation of this section) then there will be six corresponding terms contributing $\sum_{\sigma \in \mathcal{S}_3} (a, b, c)^\sigma$ to $\lambda(f_1, f_2, f_3)$. See Figure 14 for a schematic illustration where we have circled the points corresponding to one of the contributions, an intersection between f_3 and a Whitney disk on f_1 and f_2 .

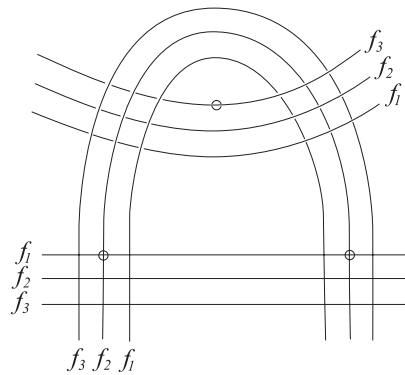

Figure 14

To complete the proof of Theorem 3 we now show that the f_i can be homotoped to pairwise disjoint maps if $\lambda(f_1, f_2, f_3) = 0$ (the converse is clear). First use $\lambda(f_1, f_2) = 0$ to separate f_1 and f_2 by pushing f_2 off the Whitney disks W^{12} and then doing Whitney moves on f_1 . Now $\lambda(f_1, f_2, f_3) = 0$ is given completely in terms of Whitney disks pairing $f_3 \cap f_1$ and Whitney disks pairing $f_3 \cap f_2$. The arguments of Lemma 7 (tubing the Whitney disks into spheres and using the move of Figure 10) can now be applied to get a second layer of Whitney disks

which pair all intersections between f_1 and the Whitney disks for $f_3 \cap f_2$. After pushing any intersections between the secondary Whitney disks and f_1 down into f_1 , the secondary Whitney disks can be used to make f_1 disjoint from the Whitney disks for $f_3 \cap f_2$. After pushing down any intersections with f_2 , the Whitney disks on $f_3 \cap f_2$ may now be used to eliminate all intersections between f_2 and f_3 . After similarly applying the arguments of Lemma 7 to get secondary Whitney disks pairing the intersections between f_2 and the Whitney disks for $f_3 \cap f_1$, one can push down intersections and do Whitney moves to eliminate all intersections between f_1 and f_3 so that the f_i are pairwise disjoint. \square

8 An invariant for n immersed spheres

In this section we define the invariant $\tau(f_1, \dots, f_n)$ of Theorem 4 which obstructs homotoping n immersed spheres in a 4-manifold X to disjoint embeddings and is the complete obstruction to raising the height of a Whitney-tower. As before, the invariant is determined by intersections between the spheres and their Whitney disks. We continue along the lines of Section 7 by working with *based* Whitney disks, i.e. choosing a whisker for each Whitney disk, and identifying $\pi \times \pi$ with the quotient $(\pi \times \pi \times \pi)/\Delta(\pi)$, where Δ denotes the diagonal *right* action of $\pi := \pi_1 X$. Since there are now n different choices for each of the three sheets interacting at any Whitney disk, $\tau(f_1, \dots, f_n)$ will take values in $\binom{n}{1} + 2\binom{n}{2} + \binom{n}{3}$ copies of $\mathbb{Z}[(\pi \times \pi \times \pi)/\Delta(\pi)]$ modulo some relations which are generalized versions of the SC, BC, FR and INT relations of Section 3. The ideas of this section are completely analogous to those of previous sections, the only novelty being the need to develop notation and conventions to handle n maps. Proofs will be omitted.

Let $f_1, \dots, f_n : S^2 \looparrowright X^4$ be a collection of oriented immersed spheres with vanishing primary μ and λ intersection numbers. Choose based, framed Whitney disks with disjointly embedded boundaries pairing all intersections and self-intersections among the f_i . Orient all the Whitney disks as follows: If W^{ij} is a Whitney disk for a cancelling pair of intersections between f_i and f_j with $i \leq j$ then take the positive arc of W^{ij} to lie on f_i . Orient W^{ij} by orienting ∂W^{ij} in the direction of the positive intersection point along the positive arc and taking a second outward-pointing vector. To each intersection point x between f_k and the interior of a Whitney disk W^{ij} for a cancelling pair in $f_i \cap f_j$ we associate three fundamental group elements corresponding to the three sheets as follows: The *positive* (resp. *negative*) group element is determined by a loop along the positive (resp. negative) sheet, then back along W^{ij} (and the whisker on W^{ij}).

The *interior* group element is determined by a loop along f_k to x and back along W^{ij} . The three group elements are ordered by the induced ordering of the maps on the sheets together with the convention that the positive element precedes the negative element which precedes the interior element. Thus each such x determines an element in $\mathbb{Z}[(\pi \times \pi \times \pi)/\Delta(\pi)]$ where the sign is given by $\text{sign}(x)$ times the sign of the permutation (ijk) with the above ordering conventions.

Denoting the positive, negative and interior elements for $x \in \text{int } W_r^{ij} \cap f_k$ by g_r^+ , g_r^- and h_x respectively, we now set up notation to measure the intersections between the spheres and the Whitney disks. For $i < j < k$ define

$$\begin{aligned} I_i(W_r^{ii}) &:= \sum_{x \in W_r^{ii} \cap f_i} \text{sign}(x)(g_r^+, g_r^-, h_x)_{iii} \in \Lambda_{iii} \\ I_j(W_r^{ii}) &:= \sum_{x \in W_r^{ii} \cap f_j} \text{sign}(x)(g_r^+, g_r^-, h_x)_{ijj} \in \Lambda_{ijj} \\ I_i(W_r^{ij}) &:= \sum_{x \in W_r^{ij} \cap f_i} (-1) \text{sign}(x)(g_r^+, h_x, g_r^-)_{ijj} \in \Lambda_{ijj} \\ I_j(W_r^{ij}) &:= \sum_{x \in W_r^{ij} \cap f_j} \text{sign}(x)(g_r^+, g_r^-, h_x)_{ijj} \in \Lambda_{ijj} \\ I_i(W_r^{jj}) &:= \sum_{x \in W_r^{jj} \cap f_i} \text{sign}(x)(h_x, g_r^+, g_r^-)_{ijj} \in \Lambda_{ijj} \\ I_k(W_r^{ij}) &:= \sum_{x \in W_r^{ij} \cap f_k} \text{sign}(x)(g_r^+, g_r^-, h_x)_{ijk} \in \Lambda_{ijk} \\ I_j(W_r^{ik}) &:= \sum_{x \in W_r^{ik} \cap f_j} (-1) \text{sign}(x)(g_r^+, h_x, g_r^-)_{ijk} \in \Lambda_{ijk} \\ I_i(W_r^{jk}) &:= \sum_{x \in W_r^{jk} \cap f_i} \text{sign}(x)(h_x, g_r^+, g_r^-)_{ijk} \in \Lambda_{ijk}. \end{aligned}$$

Denote by Λ the direct sum

$$\bigoplus_i \Lambda_{iii} \bigoplus_{i < j} (\Lambda_{ijj} \oplus \Lambda_{ijj}) \bigoplus_{i < j < k} \Lambda_{ijk}.$$

where each Λ_{abc} is a copy of the abelian group $\mathbb{Z}[(\pi \times \pi \times \pi)/\Delta(\pi)]$.

Definition 9 In the above setting define

$$\tau(f_1, \dots, f_n) := \sum I_i(W_r^{jk}) \in \Lambda/\mathcal{R}$$

where the sum is over i and all the Whitney disks W_r^{jk} ($j \leq k$). The relations \mathcal{R} are additively generated by the following equations:

For all i and j with $i \leq j$,

$$\begin{aligned} (a, b, c)_{ijj} &= -(b, a, c)_{ijj}, \\ (a, b, c)_{ijj} &= -(a, c, b)_{ijj}, \\ (a, a, b)_{ijj} &= (a, b, b)_{ijj}, \end{aligned}$$

$$\begin{aligned} \sum_{k \leq i} (\lambda(f_k, A), a, b)_{kij} - \sum_{i < k < j} (a, \lambda(f_k, A), b)_{ikj} + \sum_{k \geq j} (a, b, \lambda(f_k, A))_{ijk} \\ + (\omega_2 A)(a, b, b)_{ijj} = 0, \end{aligned}$$

where the sums are over k . Here $a, b \in \pi$ and $A \in \pi_2 X$ are arbitrary. As in Section 3, A may be any immersed $\mathbb{R}P^2$ representing ab^{-1} whenever $i = j$ and ab^{-1} is of order two.

Remark 10 The first three equations give local relations corresponding to the interaction of the sheets at a Whitney disk (the third equation corresponds to the boundary-twist operation). The fourth equation gives global relations corresponding to indeterminacies due to changing the homotopy class of a Whitney disk by tubing into A .

Remark 11 Note that $\tau(f_1, \dots, f_n)$ reduces to the invariant $\tau(f)$ of Section 3 in the case $n = 1$ (via the map $(a, b, c) \mapsto (ba^{-1}, ca^{-1})$). Also, by ignoring all terms with any non-distinct indices in the case $n = 3$ we recover the invariant $\lambda(f_1, f_2, f_3)$ of Section 7.

Acknowledgement The second author is supported by the National Science Foundation under grant 0072775.

References

- [1] **T Cochran, K Orr, P Teichner**, *Knot concordance, Whitney towers and L^2 -signatures*. Preprint 1999, posted at <http://xxx.lanl.gov/abs/math/9908117>
- [2] **MH Freedman, F Quinn**, *The topology of 4-manifolds*, Princeton Math. Series 39, Princeton, NJ, 1990

- [3] **S Garoufalidis, J Levine**, *Homology surgery and invariants of 3-manifolds*, Preprint 2000, see <http://xxx.lanl.gov/abs/math.GT/0005280>
- [4] **S Garoufalidis, L Rozansky**, *The loop expansion of the Kontsevich integral, abelian invariants of knots and S-equivalence*. Posted at <http://xxx.lanl.gov/abs/math.GT/0003187>
- [5] **I Hambleton, M Kreck**, *Cancellation of hyperbolic forms and topological four-manifolds*, J. Reine Angew. Math. 443 (1993) 21–47
- [6] **W C Hsiang, R H Szczarba**, *On embedding surfaces in four-manifolds*, Proc. Sympos. Pure Math. 22 (1971) 97–103
- [7] **M Kervaire, J Milnor**, *On 2-spheres in 4-manifolds*, Proc. Nat. Acad. Sci., Vol. 47, (1961) 1651–1657
- [8] **R Lee, D Wilczynski**, *Locally flat 2-spheres in simply connected 4-manifolds*, Comment. Math. Helv. 65, no. 3 (1990) 388–412
- [9] **G S Li**, *An invariant of link homotopy in dimension four*, Topology 36 (1997), 881–897
- [10] **Y Matsumoto**, *Secondary intersectional properties of 4-manifolds and Whitney's trick.*, Proc. Symp. Pure Math. 32 Part II (1978) 99–107
- [11] **V Rohlin**, *Two-dimensional submanifolds of four dimension manifolds*, J. Func. Anal. Appl. 5 (1971), 39–48
- [12] **R Stong**, *Existence of π_1 -negligible embeddings in 4-manifolds: A correction to Theorem 10.5 of Freedman and Quinn*, Proc. of the A.M.S. 120 (4) (1994) 1309–1314
- [13] **A G Tristram**, *Some cobordism invariants for links*, Proc. Cambridge Philos. Soc. 66 (1969) 251–264
- [14] **C T C Wall**, *Surgery on Compact Manifolds*, London Math.Soc.Monographs 1, Academic Press 1970 or Second Edition, edited by A. Ranicki, Math. Surveys and Monographs 69, A.M.S
- [15] **H Whitney**, *The self intersections of a smooth n -manifold in $2n$ -space*, Annals of Math. 45 (1944) 220–246
- [16] **M Yamasaki**, *Whitney's trick for three 2-dimensional homology classes of 4-manifolds*, Proc. Amer. Math. Soc. 75 (1979) 365–371

Dept. of Mathematics, University of California at Berkeley
Berkeley, CA 94720-3840, USA

and

Dept. of Mathematics, University of California at San Diego
La Jolla, CA 92093-0112, USA

Email: schneido@math.berkeley.edu, teichner@euclid.ucsd.edu

Received: 6 August 2000