

Hippocampus as Comparator: Role of the Two Input and Two Output Systems of the Hippocampus in Selection and Registration of Information

O.S. Vinogradova[†]

*Laboratory of Systemic Organization of Neurons,
Institute of Theoretical and Experimental Biophysics,
Puschino, Moscow District, Russia*

ABSTRACT: Processing of multimodal sensory information by the morphological subdivisions of the hippocampus and its input and output structures was investigated in unanesthetized rabbits by extracellular recording of neuronal activity. Analysis shows principal differences between CA3 neurons with uniform multimodal, mainly inhibitory, rapidly habituating sensory responses, and CA1-subicular neurons, substantial parts of which have phasic reactions and patterned on-responses, depending on the characteristics of the stimuli. These differences result from the organization of the afferent inputs to CA1 and CA3. Analysis of neuronal responses in sources of hippocampal inputs, their electrical stimulation, and chronic disconnection show the greater functional significance of the brain-stem reticular input for tonic responses characteristic of CA3. This input signal before entering the hippocampus is additionally preprocessed at the MS-DB relay, where it becomes more uniform and frequency-modulated in the range of theta-rhythm. It is shown that the new sensory stimuli produce inhibitory reset, after which synchronized theta-modulation is triggered. Other stimuli, appearing at the background of the ongoing theta, do not evoke any responses of the hippocampal neurons. Thus, theta-modulation can be regarded as a mechanism of attention, which prolongs response to a selected stimulus and simultaneously protects its processing against interference.

The cortical input of the hippocampus introduces highly differentiated information analyzed at the highest levels of the neocortex through the intermediary of the entorhinal cortex and presubiculum. However, only CA1-subiculum receives this information directly; before its entrance into CA3, it is additionally preprocessed at the FD relay, where the secondary simplification of signals occurs. As a result, CA3 receives by its two inputs (MS-DB and FD) messages just about the presence and level of input signals in each of them, and performs relatively simple functions of determination of match/mismatch of their weights. For this comparator system, the presence of signal only in the reticulo-septal input is equivalent to quality of novelty. The cortical signal appears with some delay, after its analysis in the neocortex and shaping in the prehippocampal

structures; besides, it is gradually increased due to LTP-like incremental changes in PP and mossy fiber synapses. The CA3 neurons with potentiated synapses of cortical input do not respond to sensory stimuli; that is, the increased efficacy of the cortical signals can be regarded as "familiarity" of a signal, terminating the reactive state of the CA3 neurons. The integrity of both inputs is necessary for gradual habituation of sensory responses in the hippocampus.

The output signals of CA3 following in the precommissural fornix to the output relay-LS nucleus and to the brain-stem structures have strong regulatory influence on the level of brain activity (arousal), which is an important condition for processing and registration of information. The primary targets of this output signal are raphe nuclei, which suppress activity of the ascending excitatory RF. In the background state, activity of the CA3 neurons through the intermediary of raphe keeps RF under tonic inhibitory control. Inhibition of the majority of CA3 pyramidal neurons during a novel stimulus action decreases the volume of its output signal to raphe and releases RF from tonic inhibition (increase in level of activity of the forebrain, arousal). When the responses of CA3 neurons habituate, the initial high background activity is reinstated, as well as tonic suppression of RF. Analysis of the second output of CA3 (by Schaffer's collaterals to CA1) shows that activity in this pathway can block access of cortical signals from PP to CA1 neurons by action upon the local system of inhibitory neurons, or by shunting the propagation of signals in apical dendrites. Thus, CA3 can act as a filter controlling the information transmission by CA1; such transmission at any given moment is allowed only in those CA1 neurons which receive SC from CA3 neurons, responding to the sensory stimulus by suppression of their activity. Disconnection of the CA3 output fibers results in disappearance of habituation in all its target structures (raphe, RF, CA1).

The output signal of CA1-subiculum follows by post-commissural fornix to the chain of structures of the main limbic circuit: mammillary bodies (medial nucleus), anterior thalamic nuclei (mainly antero-ventral nucleus), and cingulate limbic cortex (mainly posterior area). In each of these links, the signal is additionally processed. Habituation is nearly absent in these structures; instead, strong incremental dynamics are observed. Various types of reaction shaping, often with changes in level and structure of background activity, are observed in them. Within this output circuit, the farther is the output structure from the hippocampus,

Abbreviations: AVT, antero-ventral nucleus of thalamus; CA1 and CA3, hippocampal fields; cing, cingulum; FD, fascia dentata; F.pre, fornix pre-commissuralis; F.post, fornix postcommissuralis; LEC, lateral entorhinal cortex; LS, lateral septal nucleus; MEC, medial entorhinal cortex; MFB, medial forebrain bundle; MMB, medial mammillary body nucleus; MS-DB, medial septal nucleus and nucleus of diagonal band; MTT, mammillothalamic tract; NC, neocortex; PLC, posterior limbic cortex; PP, perforant path; PSB, presubiculum; RF, reticular formation; SC, Schaffer collaterals; SUB, subiculum.

Grant sponsor: Russian Foundation for Support of Basic Science; Grant number: N 99-04-48281.

[†]Deceased June 8, 2001.

*Correspondence to: Dr. John Lisman, Department of Biology, Brandeis University, 415 South Street, Waltham, MA 02454.

Accepted for publication 1 June 2001

the more repetitions of stimulus are required for shaping the sensory response. That is why this system is regarded as a chain of integrators, where each one starts to respond only after reaction develops at the previous link, and as a delay line, preventing premature fixation of spurious, irrelevant, low probability signals. The responses in the higher link of this system, the posterior limbic cortex, may be regarded as the ultimate signal for information fixation in the nonprimary areas of the neocortex. In this way, the two morpho-functional circuits, regulatory (based on CA3) and informational (based on CA1), perform the unified functions of attention and initial stages of memory trace fixation. *Hippocampus* 2001;11:578–598. © 2001 Wiley-Liss, Inc.

KEY WORDS: neuronal activity; novelty; habituation; attention; memory

INTRODUCTION

The hippocampus is one of the most vulnerable brain structures. Specific dysfunctions of the hippocampus are described in connection with at least 15 types of brain pathology with various etiologies: traumatic, genetic, and infectious. Hippocampus-dependent psychological defects were investigated in detail in patients with intractable temporal epilepsy with sclerotization of the hippocampus and in Alzheimer's disease, although the scattered data on other types of pathology involving the hippocampus give highly congruent supporting evidence. Two processes suffer in connection with hippocampal dysfunction. The first is selective attention, which becomes unstable, highly sensitive to interference from irrelevant stimuli, and, paradoxically, also rigid, with difficulties in shifting from one item to another. The second process is memory, or, more specifically, transfer from short-term memory into long-term memory storage, which we shall call "registration of information." It should be noted, using the modern terminology, that the hippocampus is responsible only for explicit, declarative, episodic, perceptual memory. Many forms of implicit, procedural, motor memory (including simple conditioning, habits, and on up to speech production) can be preserved without the hippocampus, although in the normal brain it may participate at early stages of shaping of such types of activity.

Probably variable, multiple, and bizarre manifestations of schizophrenia initially masked defects of attention and memory in schizophrenic patients for investigators of this disease. As far as I know, only during the last decade (or a little more) were defects of information gating and selective attention (Cohen et al., 1987; Oades and Sartory, 1997; Grace, 2000), as well as of working memory (Stabenau and Pollin, 1993; Heckers et al., 1999; Stratta et al., 1999), demonstrated in schizophrenic patients. Simultaneously there appeared many investigations which showed defects of fine neuronal organization (Bogerts, 1993; Jonsson et al., 1997; Benes, 2000) and decrease in volume of the hippocampus in schizophrenics (Marsh et al., 1994; Csernansky et al., 1997; Furuzako et al., 1997; Copolov et al., 2000), as well as changes in several transmitter receptor systems of the hippocampus, especially in various types of glutamate receptors (Kerwin et al., 1990; Collinge and Curtis, 1991; Tamming, 1998; Meador-Woodruff and

Healey, 2000). Changes in microtubule-associated proteins, polysialated neural cell adhesion molecules, and growth associated protein-43, various substances involved in the development and plasticity of neurons, were also observed in the hippocampus during schizophrenia (Barbeau et al., 1995; Cother et al., 1997; Eastwood and Harrison, 1998).

This paper by no means should be regarded as an attempt to elucidate the role of the hippocampus in schizophrenia, which is beyond the competence of the author. It is just a very short review of the work by the author and her colleagues on systematic neuronal analysis of the hippocampus and related structures for the last 35 years. Only the data on processing, gating, and registration of sensory information will be presented here. We hope that this analysis promotes understanding of the inner logic of the hippocampal system and those concrete operations, performed by its neurons, which provide for emergence of attention and organization of the earlier stages of memory. However, it is necessary to add a few words explaining why the investigation of neuronal dynamics in the hippocampus during repeated presentations of sensory stimuli was initiated (Vinogradova, 1966).

This was preceded by 12 years of work with E.N. Sokolov on investigation of the orienting reaction in human subjects by the polygraphic method. The following principles were developed in the course of this work:

- 1) The craving for novel information satisfied during orienting-exploratory activity should be regarded as one of the basic drives of living organisms. Its importance increases with the phylogenetic status of an organism. In higher mammals, the need of brain for information is nearly as important as the need of body for food.
- 2) The orienting reaction is an adaptive form of behavior providing the optimal conditions for perception and analysis of novel information.
- 3) The orienting reaction does not reflect any qualitative characteristics in the wide range of multimodal stimuli. Its specific trigger is the quality of novelty, i.e., the absence of information in the memory.
- 4) Gradual habituation of the orienting reaction, which develops with progress of analysis, should be regarded as "negative learning" the disappearance of a response to novelty, indicating to parallel formation of a corresponding memory trace, or "nervous model of the stimulus" (Sokolov, 1960). It should be noted that relative novelty (appearance of a stimulus against the stable background after some time interval), and not only absolute novelty of a stimulus, is of importance.
- 5) Although the efferent expression of the orienting response is uniform, it participates in fine differentiation of afferent stimuli. After habituation to a stimulus, the orienting response can be evoked again by a change nearly equal to the differential threshold of sensitivity.
- 6) The orienting reaction, providing for analysis of stimuli and their relations, is necessary for any kind of learning. Even simple conditioning can be retarded by the preceding deep habituation of the orienting response to the future conditioned stimulus ("latent inhibition"). All changes of the established pattern of learning normally occur through the phase of reappearance of the orienting

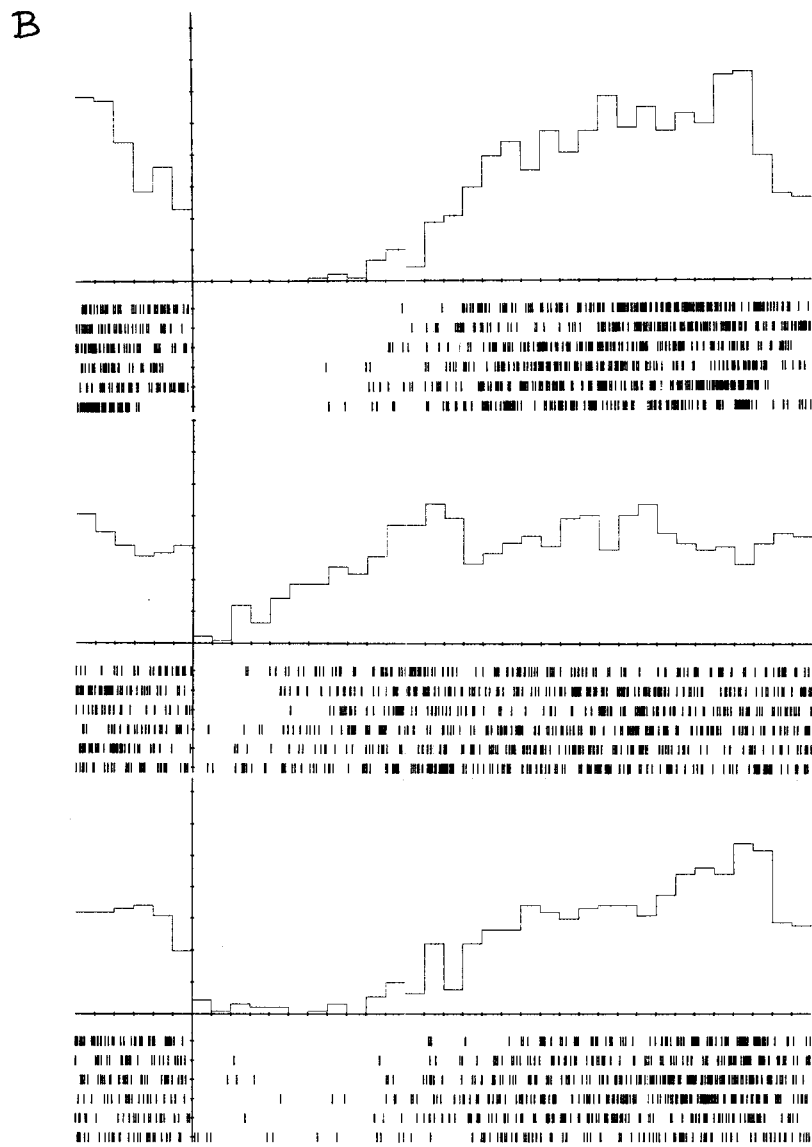
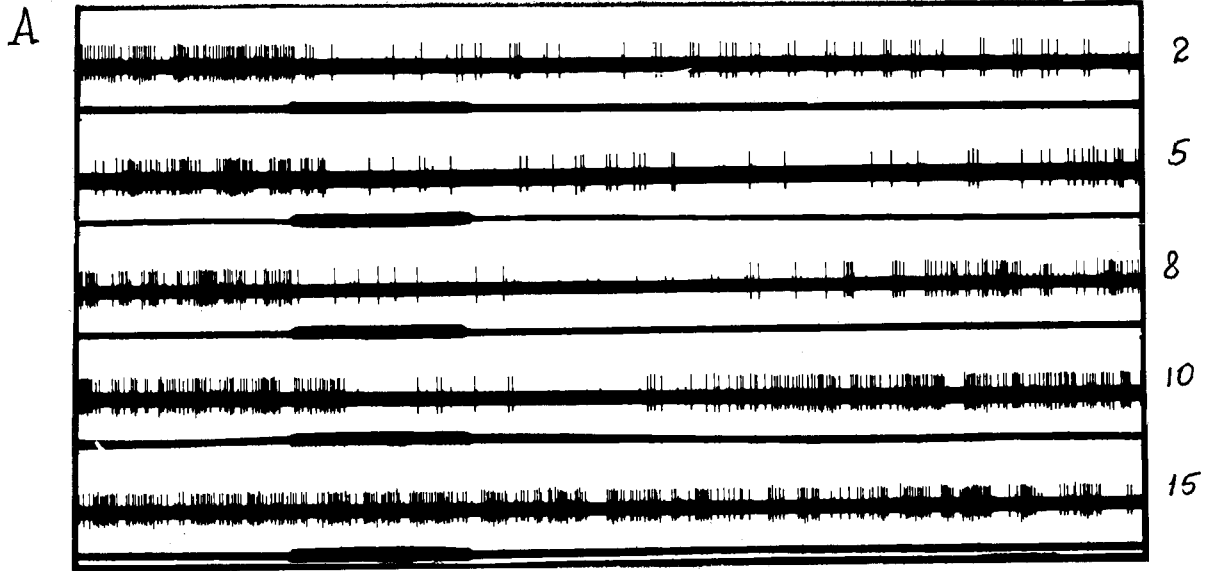

FIGURE 1

response, with renewal of analysis and temporary suppression of the previously established behavior (Vinogradova, 1959, 1961).

At the time when these characteristics of the orienting response were described and it was decided to look for the brain structures and neuronal mechanisms responsible for them, significant developments occurred in the clinical and experimental investigations of the hippocampus. Penfield and Milner (1958) presented detailed clinical analysis of memory after hippocampal lesions, while experimental data from hippocampectomized animals described "non-habituating orienting reflex," "insatiable curiosity," and a "tendency for incessant exploration" (Roberts et al., 1962; Jarrard and Bunnell, 1968; Glickman et al., 1970; Kim et al., 1970). This means that for such animals, "new" does not become "old," which would indicate defective habituation of reaction to novelty and memory trace formation. This, and the exceptional structure of the hippocampus, with its two afferent inputs entering from the opposite sides, suggestive of a comparator device, made the hippocampus the primary and long-term object of our investigations.

It should be noted that the idea of the hippocampus as novelty detector and comparator was suggested by many authors on the basis of various data: clinical, behavioral, and neurophysiological (Pribram, 1986a; Miller and Matzel, 1988; Squire et al., 1988; Grossberg and Merrill, 1992; Salzmann, 1992; Eichenbaum, 1997). This idea has fundamental significance for understanding the double interconnected function of the hippocampus: selective attention with inhibitory control protecting the processing of information from interference, and global function of the selected information (e.g., relational, temporal, spatial) transfer into the cortical memory storage (Weiskrantz and Warrington, 1975; Grastyan, 1985; Pribram, 1986b; Squire, 1992; Wood et al., 1999).

BASIC CHARACTERISTICS OF NEURONAL SENSORY RESPONSES IN THE HIPPOCAMPUS

All experiments on the analysis of sensory responses in subdivisions of the hippocampus proper and its input and output structures were performed in unanesthetized waking rabbits in strictly constant conditions. During the experiments, the animal was placed into a soundproofed chamber in a special box, slightly restricting gross (locomotor) movements. About 12–15 experiments were performed in each animal. Auditory, visual, and tactile stim-

uli were presented in series. Neuronal activity was recorded extracellularly by tungsten microelectrodes introduced into the investigated structure with the help of a distant hydraulic micromanipulator. Neuronal activity was tape-recorded and processed off-line.

Characteristics of sensory responses and their dynamic changes during repeated presentations of stimuli were determined for each morphological subdivision of the hippocampus itself, its input structures, and the targets of its output signals. The particular contribution of each input structure was determined in experiments with its electrical stimulation and local transection of interconnecting pathways. The general system of functional interactions between the links of this system was gradually developed on the basis of these data.

The following characteristics were observed in the CA3 neurons:

- 1) Usually the proportion of reactive neurons was about 70%. By special modification of the experiments (long intervals between sessions, widely varied stimuli), it was possible to show that in fact nearly all neurons were initially responsive to sensory stimuli
- 2) The absolute majority of responsive neurons (94%) responded to all stimuli applied (unspecificity of input).
- 3) For each neuron, responses were uniform, independent of the stimulus characteristic (unspecificity of output).
- 4) Reactions consisted of diffuse tonic shifts of background frequency level for up to several seconds, gradually returning to the initial state. Reactions of individual neurons are expressed in either tonic increase, or tonic decrease of activity level. The last type (inhibitory effects) always dominated over excitatory ones (60% vs. 40% of reactive neurons) (Fig. 1).
- 5) With repeated presentations of a stimulus, the reaction became shorter, decreased, and disappeared (habituated) altogether by 8–20 stimulus presentations. Application of the same stimulus after some time interval, or intervening presentations of other stimuli, usually evoked response again, but it rapidly disappeared after a few (1–2) additional presentations ("recognition"). Special experiments with repeated applications of the same stimulus from day to day showed complete chronic disappearance of its effect in all CA3 neurons, while they retained normal reactivity to other, previously not tested stimuli (Vinogradova, 1966; Brazhnik and Vinogradova, 1973).
- 6) Any perceptible change of the signal after its habituation restored the initial effect. This can be obtained by change of quality or intensity of the stimulus (e.g., its sudden decrease), by prolongation, shortening, or omission of the standard signal, or by subtraction of a component from the complex stimulus.

These data were obtained in the CA3 field of the dorsal hippocampus. The testing of neurons in the same field of the ventral hippocampus revealed similar characteristics with minor differences (longer latencies, longer responses, greater significance of the stimuli duration) (Semyonova and Vinogradova, 1970).

It is necessary to note that in the rabbit, CA3 and CA1 pyramidal neurons are characterized by high level of mean frequency ($18.0 \pm 1.5 \text{ sp} \cdot \text{s}$) and presence of theta-modulation. Low level of activity with intermittent complex spikes is usually observed dur-

FIGURE 1. CA3. Typical inhibitory responses to sensory stimuli with gradual habituation. **A:** Record of neuronal activity. Period of stimulation (tone, 400 Hz) is indicated below records; number of a presentation is indicated at right. Time calibration, 200 ms. **B:** Peristimulus time histograms and raster dot displays of responses of a similar cell. **Top:** First to sixth presentations of the stimulus (tone, 850 Hz). **Middle:** Seventh to twelfth presentations of the same stimulus. **Bottom:** Change to tone of 900 Hz. Period of counting 7.5 s, bin 200 ms. Calibration for y-axis is 5 spikes.

ing somnolence with cortical inactivation and is better expressed in the sequence CA3 < CA1 < subiculum. Multiple series of experiments with registration of activity in the pyramidal layer of the hippocampus, and special analysis using several criteria, confirmed this conclusion (Vinogradova et al., 1992).

Investigation of the field CA1 and its main target, the subiculum, the place of origin of the precommissural fornix, revealed some important differences from CA3 neurons:

- 1) Nearly half of the reactive neurons in these structures have unimodal responses (41–44%);
- 2) Some multimodal neurons are modality-unspecific (as in CA3). However, many of them have differentiated responses to stimuli of different modalities, and even to various stimuli within a single modality.
- 3) Many CA1 and subicular neurons respond by phasic (equal to stimulus duration and returning to background level abruptly, not gradually) and “specific” (on-off effects with stimulus-specific pattern) responses (41% in CA1 and 49% in the subiculum). Tonic reactions in these areas are on average shorter than those in the field CA3 by 1–2 s. (Fig. 2).
- 4) The neurons with inhibitory responses are encountered less frequently than those with various types of excitatory effects.
- 5) Habituation is present, but in slightly lower proportions of the neurons (71–75%). The special feature of the dynamics is the absence of response to the first (in the CA1) or several (in subiculum) initial stimuli in a series. Sometimes reaction first gradually increases and then habituates.

The following conclusions can be done on the basis of these data:

- 1) Functionally, the hippocampus may be regarded as a relatively homogenous structure in its dorso-ventral extension, and as a differentiated one in medio-lateral extension (the fields CA3, CA1, subiculum).
- 2) The adequate stimulus for the CA3 neurons is novelty, i.e., the absence of the corresponding trace in memory storage, and not any specific physical characteristics of the stimuli.
- 3) The dynamics of appearance, habituation, and dishabituation of CA3 neuronal responses are similar to those of the orienting response to novelty at macrolevel.
- 4) CA3 neurons do not code (and thus cannot transmit) information on characteristics of the input signals. Their activity can be regarded as strong global regulatory signal which can tonically control the targets of CA3 influences.
- 5) On the basis of the functional characteristics of neurons and details of structural organization (see below), it is suggested that the CA3 field has the function of comparator, matching the signals in its two inputs. Mismatch between these signals is equivalent to detection of novelty (Vinogradova and Dudaeva, 1972; Vinogradova, 1975a).
- 6) The principal difference between the neurons in CA1 and the subiculum from those of CA3 is retention (within certain limits) of differentiated coding of some qualitative characteristics of sensory stimuli, and not just the presence or absence of novelty. These responses are shaped with some delay (Vinogradova and Dudaeva,

1971; Vinogradova, 1975b; Stafekhina and Vinogradova, 1979a,b).

To understand the nature of these differences between hippocampal fields, it is necessary to analyze the input signals received by them.

RETICULO-SEPTAL INPUT

Surprisingly, till now some investigators have referred to the cortical input of the hippocampus as its only or at least “most important” afferent pathway. However, the ascending medial fore-brain bundle, including fibers of various kinds of transmitter from multiple structures of the brain stem, is the source of complex and functionally important informational and regulatory signals. We have investigated only one of the brain-stem sources, the midbrain reticular formation (RF). Although this structure was investigated before us, it was important to obtain data on neuronal characteristics in standard conditions of testing. These data were compared to neuronal characteristics of the prehippocampal relay area, i.e., the medial septal nucleus and vertical limb of the nucleus of diagonal band (MS-DB).

Investigation of RF and MS-DB showed the following neuronal characteristics:

- 1) The neurons of RF were highly responsive to the afferent stimuli applied (70%). According to our data, the level of multimodal convergence was not very high (38%).
- 2) The neurons could be subdivided into two equal groups: those with prolonged tonic effects, and those with complex stimulus-specific effects of phasic and on-response types. Excitatory reactions absolutely dominated (85%) (Fig. 3A).
- 3) A similar division was observed on the basis of dynamic transformations of the responses. About half of all responses underwent rapid linear habituation with repeated presentations of a stimulus, while others remained absolutely stable. The tonic effects were especially prone to habituation.
- 4) In comparison to RF, the MS-DB neuronal responses had more uniform characteristics. All reactive neurons were polymodal and responded by uniform decrease or increase of activity. Only in 12% of neurons were tonic responses preceded by simple on-effects, consisting of a short burst of spikes (Fig. 3B).
- 5) As a rule, these responses showed only partial habituation: their duration linearly decreased during the first 8–15 presentations of a stimulus, but when reactions became approximately equal to a stimulus duration, they were stably reproduced for many additional presentations of the stimulus.
- 6) The unique characteristic of the MS-DB neurons was the presence of theta-bursts (4.5–6.5 Hz) in their activity. In the background state (without theta-rhythm in the hippocampal EEG), theta-bursts were present in 28% of neurons; during sensory stimulation they appeared in additional groups of neurons, with both excitatory and inhibitory reactions (68%) which resulted in arousal response with theta rhythm in EEG. In some neurons, rhythmic

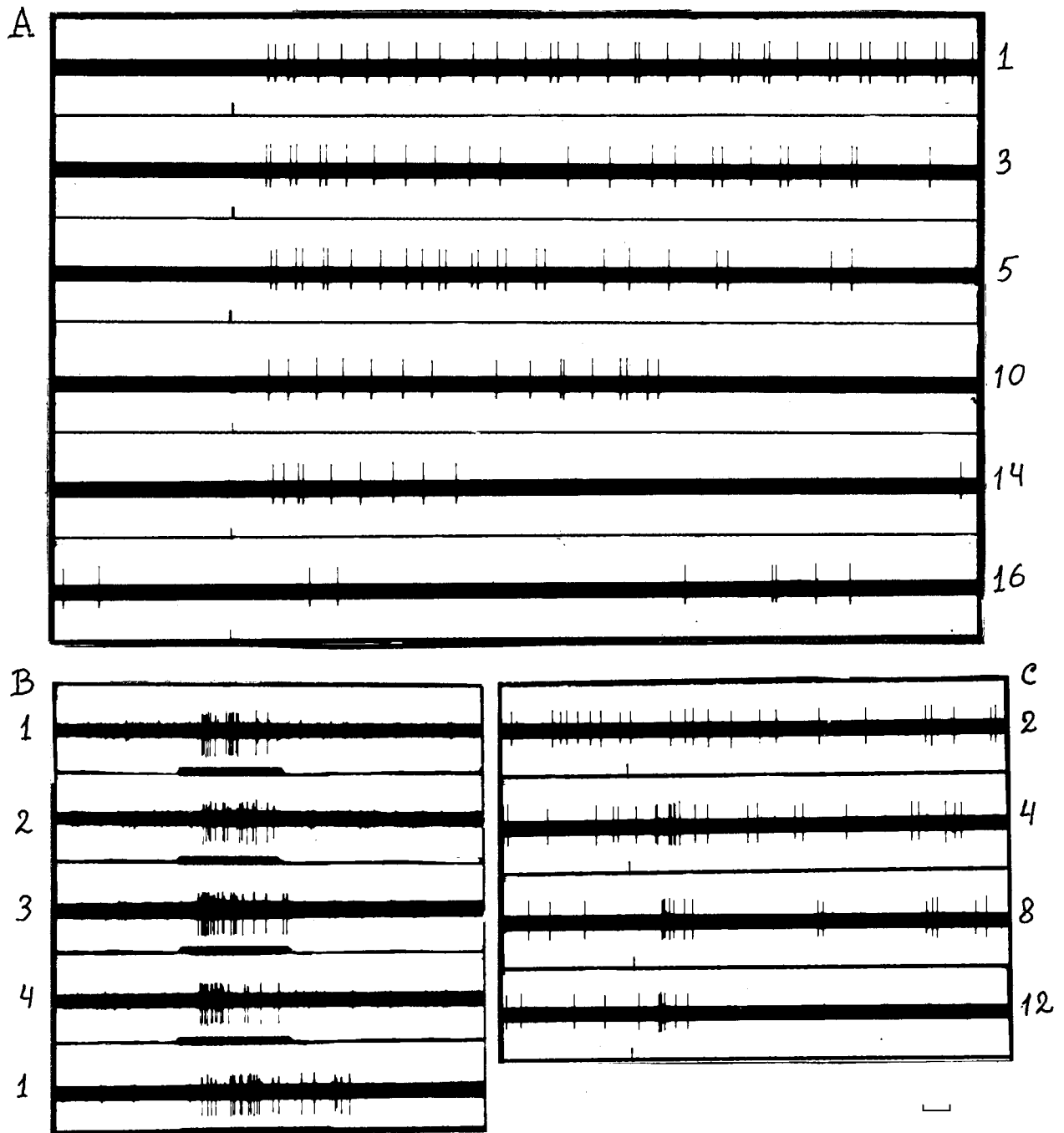

FIGURE 2. CA1 and subiculum. A: CA1. Tonic excitatory response to click with gradual habituation. B: Subiculum. Phasic response to tone of 700 ms; on the last record, duration of tone is increased (1,000 ms). C: Subiculum. On-response to light flash with initial rapid shaping. All indications here and further on, as in Figure 1A.

theta modulation may appear without any change of background frequency (Vinogradova and Zolotukhina, 1972; Kitchigina and Vinogradova, 1974).

To analyze the role of reticulo-septal input in processing of sensory information by hippocampal neurons, several experimental approaches were used:

1) Electrical stimulation of RF (usually short high-frequency trains of stimuli of 100 Hz, for 100 ms) evoked general tonic shifts in the level of neuronal activity in the hippocampus for periods of several seconds. These effects of decrease or increase of background frequency were more often observed in CA3 (79% of neurons) than in CA1 (64%). Significant correlation between direction of changes during sensory and RF stimulation was present in CA3

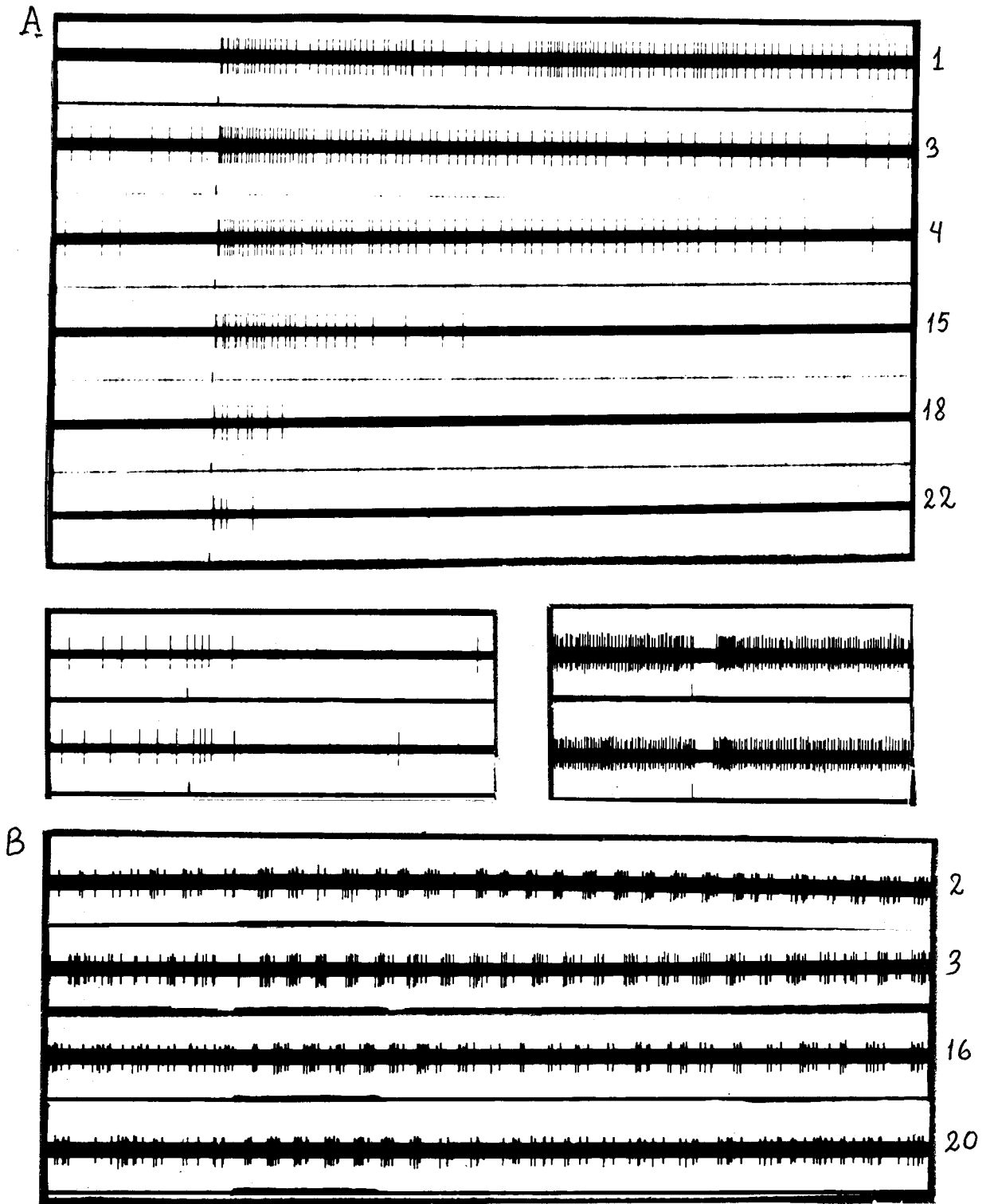

FIGURE 3. RF and MS-DB. A: RF. Gradually habituating tonic response with initial on-component to click. Below are on-responses of two other cells to light flash (left) and tactile stimulation of ear (right). B: MS. Tonic response to tone of 300 Hz with limited habituation.

($P = 0.84$). For tonic sensory effects in CA1 this correlation was lower ($P = 0.62$); phasic and on-responses did not show any correlation.

2) After complete habituation of responses to a sensory stimulus, brief electrical stimulation of RF restored the initial response (dishabituation). Sensory responses appeared also in some neurons which do not respond in initial tests.

3) Elimination of the reticulo-septal input by transection between the septum and rostral hippocampus in chronic animals did not decrease the level of hippocampal reactivity to sensory stimuli tested 2 weeks after the lesion. However, the characteristics of responses were radically changed, especially in CA3. Tonic responses were greatly reduced in number (15–20%) and duration (1.5–2 s). Phasic and “specific” patterned responses, normally present only in CA1 and the subiculum, dominated in all three areas. Inhibitory reactions were nearly absent. Some decrement of responses could be observed only in a minor group of neurons (15%). The latencies of reactions were increased; the majority of responses had an initial period of gradual shaping, after which they remained stable (Fig. 4) (Vinogradova and Brazhnik, 1978).

Analysis of the role of reticulo-septal input to the hippocampus would be incomplete without data on the significance of theta-rhythm in this process. This is especially important now, when the presence of theta in EEG of humans and other primates, as well as its significance for attention and memory, is recognized (e.g., Burgess and Gruzelier, 1997; Doppelmayr et al., 1999; Klimesch, 1999; Kahana et al., 1999). The dynamics of theta-rhythm, as an EEG component of arousal, are identical to those of the orienting response: they appears in novel or changed conditions and disappear when the stimuli are known and responses are well-learned. The unique site of theta origin is the MS-DB complex.

1) The MS-DB contains a limited group of the bursting pacemaker neurons which retain the ability to generate rhythmic burst activity without either of the afferent inputs *in vivo*, in slices, in intraocular grafts, and after blockade of synaptic transmission (Vinogradova, 1995). Synchronized generation of neuronal theta-bursts after an initial short (30–120 ms) inhibitory reset period can be triggered by sensory and reticular stimulation in large additional groups of septal neurons (up to 98%).

2) However, the stable background neuronal theta, evoked by increase of endogenous acetylcholine in MS-DB (*i.v.* injection of physostigmine), drastically decreased the sensory responsiveness of hippocampal neurons. In nearly 80% of neurons, responses were completely blocked or decreased; this involved nearly all inhibitory effects. Only in 21% of neurons responses were not changed, and in some of them, which retained reset phase at the background of physostigmine, excitatory responses were even increased and prolonged (Vinogradova et al., 1993a,b).

3) Persistent background neuronal theta-rhythm can be evoked also by a quite different method: by functional blockade (intra-structural injection of lidocaine) of the median raphe nucleus (mRph), which normally has a tonic inhibitory influence on the septal pacemaker of theta-rhythm. The drastic decrease of sensory responsiveness in the hippocampal neurons under this condition

was identical to that observed under physostigmine (Vinogradova et al., 1999).

4) Blockade of the muscarinic receptors by systemic injection of scopolamine resulted in an opposite change of responses: their increase and stabilization without decremental changes.

The following conclusions on the role of reticulo-septal input in information processing by hippocampal neurons can be given on the basis of the above data:

1) Analysis of responses to sensory stimuli confirms the presence in the ascending RF of tonic excitatory responses as well as of differentiated effects of patterned and phasic type. However, at the prehippocampal MS-DB relay, responses are more multimodal and less differentiated, which indicates some secondary simplification and unification of signals before their entrance into the hippocampus.

2) Rapid complete linear habituation, characteristic of half of the RF neurons, is not present in the MS-DB, where only partial limitation of a response occurs, with stable reproduction of its initial part. That means that complete habituation of the hippocampal responses cannot be explained by suppression of reactions at the septal relay.

3) On the basis of the effects of stimulation of RF and abolishment of reticulo-septal input, it is possible to state that this input is functionally more important for the sensory responses in the field CA3 than in CA1.

4) The dynamics of gradual habituation in both fields depend on the integrity of reticulo-septal input. Effects of electrical stimulation of RF indicate that an increase of activity in this input for the hippocampal neurons is equivalent to the quality of novelty.

5) Theta-producing septo-hippocampal projection neurons participate in organization of hippocampal tonic sensory responses. GABAergic components of this input are responsible for initial reset and synchronization of neuronal activity, while slower cholinergic influences prolong the period of stimulus processing. Once theta-rhythm is triggered by a natural stimulus or experimental means, all other signals appearing in its background cannot reset the ongoing rhythmic process; they are filtered out and do not receive access to the processing mechanisms of the hippocampus.

6) Thus, reticulo-septal input may be regarded as a mechanism improving processing of novel information in the hippocampus and simultaneously protecting it from interference, *i.e.*, as a part of attention mechanism.

CORTICO-HIPPOCAMPAL INPUT

Highly preprocessed complex information from the neocortex reaches the hippocampus through the perirhinal and entorhinal cortex and presubiculum. These cortical areas subserving the hippocampus gather information from the highest integrative levels, *i.e.*, secondary and associative areas of posterior and anterior neocortex, which make them the last stage of information processing in the cortical hierarchy (Mishkin et al., 1998). The major part of

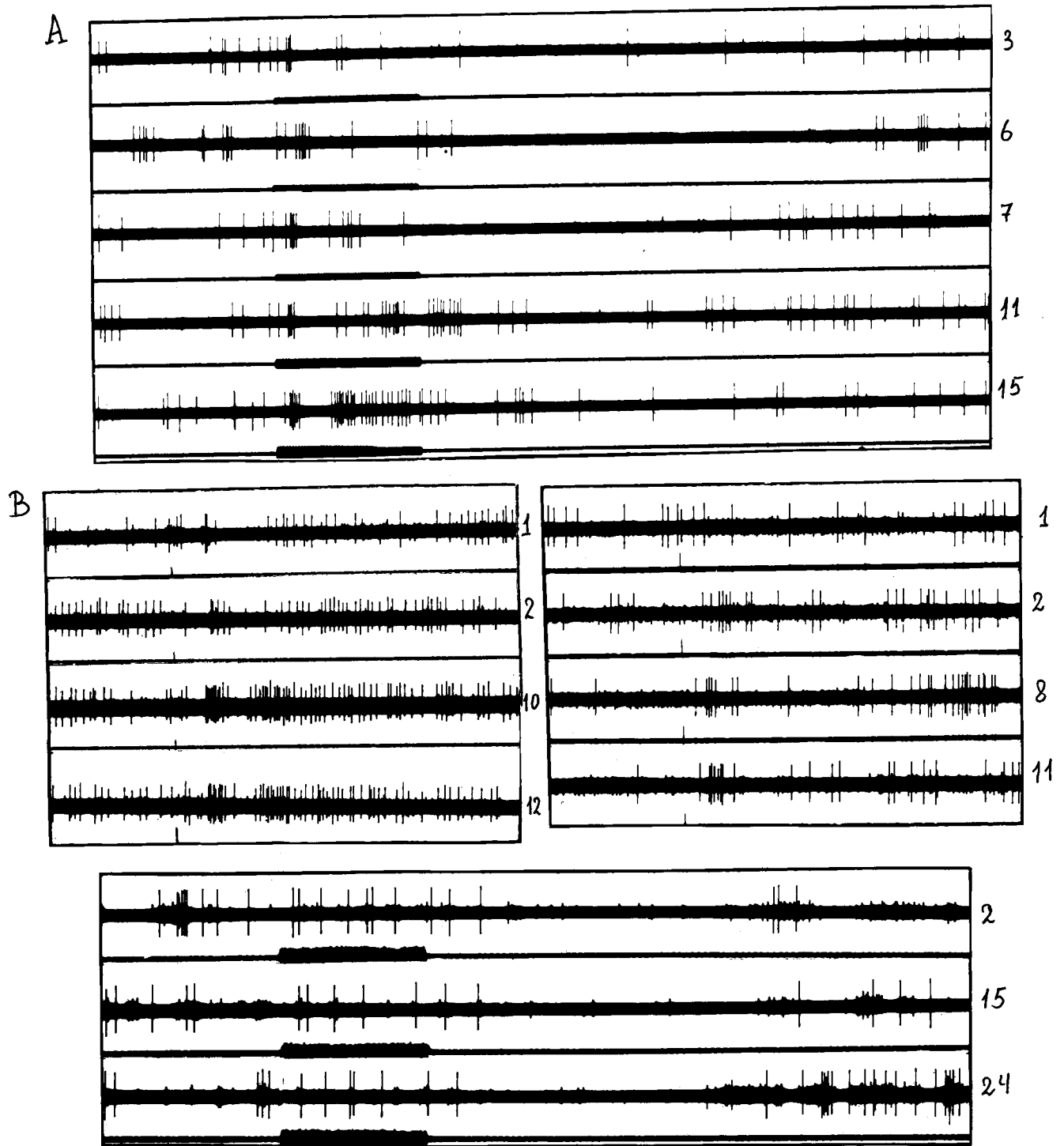

FIGURE 4. Effects of elimination of the reticulo-septal input. A: Gradual shaping of complex response to tone 400 Hz in CA1. B: Atypical responses of CA3 neurons, gradually shaping on-response to light flash (left) and click (right). Below, phasic excitation with following inhibitory phase to tone of 2,500 Hz.

FIGURE 5. EC and PSB. A: Differentiated responses of MEC neuron. From top: phasic inhibition with following phase of excitation to tone of 2,000 Hz; tonic inhibition to tone of 4,800 Hz; tonic excitation to stimulation of vibrissae. B: Responses of LEC to tactile stimuli: phasic effect of vibrissae stimulation (left) and complex on-off response to tactile stimulation of the ear (right). C: PSB. Complex rhythmic effects. Above, gradually developing response to light flash; below, rhythmic response to tone of 1,500 Hz. Components of response are indicated by dots above them.

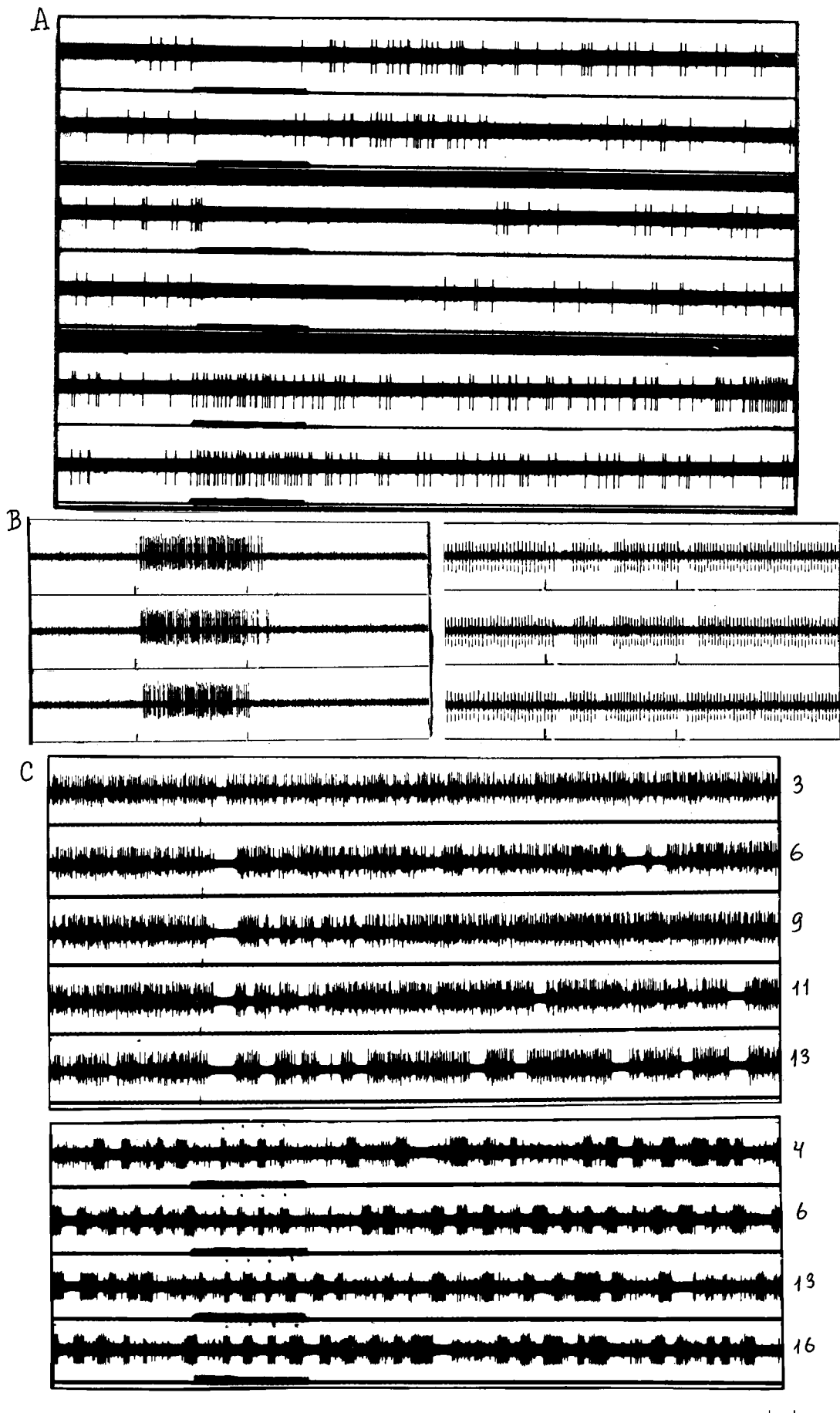

FIGURE 5

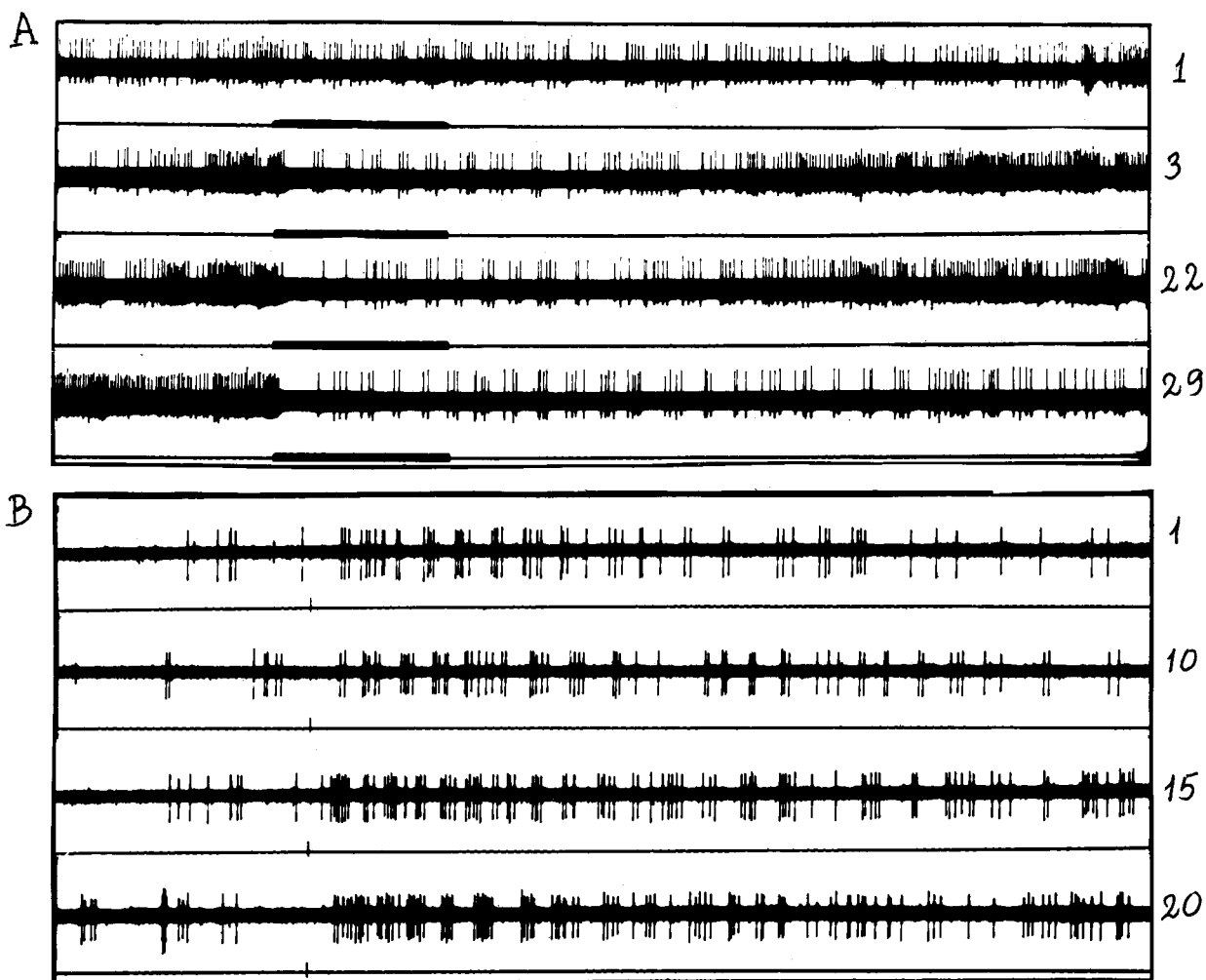

FIGURE 6. Effects of elimination of cortical input to the hippocampus. A: Incremental tonic inhibitory response of a CA3 neuron to a tone of 400 Hz. B: Incremental tonic excitatory response of a CA1 neuron to light flash. Both responses are theta-modulated.

cortical input (perforant path, PP) reaches CA3 after additional switching on the intrahippocampal relay structure, the fascia dentata. In our experiments we investigated sensory responses of the medial and lateral entorhinal cortex (MEC and LEC, areas 28a and b), presubiculum (PSB), and fascia dentata (FD).

The neuronal characteristics of these structures can be summarized in the following ways:

- 1) The neurons of EC and PSB responded to sensory stimuli by highly differentiated stimulus-specific patterned and phasic effects; diffuse tonic reactions were observed only in minor group of the neurons (13–16%).
- 2) Although responses to all modalities tested were encountered in all three structures, only MEC can be regarded as a really polymodal structure, vigorously responding to auditory, visual, and somatosensory stimuli. The LEC neurons responded specifically and selectively to tactile stimuli, while only rare, weak, and diffuse effects were evoked by the stimuli of other modalities. Visual re-

sponses dominated in PSB. Our experiments with electrical stimulation supported the existing morphological data on pathways to LEC mainly from the anterior neocortex, and connections to MEC from posterior associative areas. The afferents to PSB from the lateral geniculate body and pulvinar were described in morphological studies.

- 3) Decremental dynamics of complete habituation type are absent in these structures. More than half of all responses slowly develop and stabilize after 5–15 repeated presentations of a stimulus. Emergence of responses often occurs simultaneously, with complex transformations of the background activity. In PSB, with its very complex polyrhythmic burst spontaneous activity, responses are formed by selection and stabilization of a certain rhythmic pattern from the background activity. Some responses in all these structures change their pattern after 10–12 repeated presentations of a stimulus and retain it further on (Fig. 5) (Stafekhina and Vinogradova, 1978, 1979a,b).
- 4) Multimodal responses of the FD neu-

rons which relay signals of PP to CA3 are much less variable and selective. They constitute three nearly equal groups of inhibitory tonic, excitatory phasic, and simple on-responses. The stable responses with gradual formation dominate (Vinogradova and Bragin, 1975).

5) Experiments with electrical stimulation showed that direct influences of the PP are much more effective in CA1 than in CA3. This was confirmed in experiments on hippocampal slices with elimination of FD and transection of Schaffer collaterals between CA3 and CA1 (Bragin et al., 1977).

6) Weak electrical stimulation of the PP or mossy fibers of FD (usually 15 Hz for 1 s) leads to complete blockade or significant depression of hippocampal responses to the following sensory stimuli. With repeated daily stimulation in chronic animals, the persistent increase of efficacy of electrical stimuli was observed, the phenomenon which we named "chronic potentiation" (Bragin and Vinogradova, 1973) and which became known as long-term potentiation (LTP). In special experiments where a fixed point in FD was stimulated and a recording electrode was shifted by the longitudinal axis of the field CA3, the gradient of LTP was shown, with maximum of LTP about 1.5 mm around the projection of the stimulated bundle of the mossy fibers, and with decrease of expression in more distant points. This gradient had perfect negative correlation with sensory responsiveness of CA3 neurons recorded at various distances from the point of stimulation in FD, with complete nonreactivity in the potentiated zone and normal levels of responsiveness in distant zones (Bragin et al., 1976). Reactivity of the neurons to sensory stimuli recovered parallel to the decrement of LTP.

7) Transection of PP was followed by disappearance of complex patterned responses in CA1. However, even in this condition a group of CA1 neurons responded to sensory stimuli by simple single-component on-responses. It is important that all these neurons (and only these neurons) responded to stimulation of the RF by single -spike driving (up to 15–30 Hz).

8) Tonic responses were preserved in CA3 after PP transection and increased in number in CA1. Responses to sensory stimuli (excitation or inhibition) were highly correlated with the effects of RF stimulation. Total reactivity level was significantly increased in both fields (82–87%). The gradual habituation typical of tonic effects was absent and substituted by rapid unlimited increase in duration of responses. In the majority of neurons, strong theta-modulation was triggered by the stimuli (Fig. 6).

9) In both fields, elimination of cortical input resulted in instability of "direction" of tonic responses. In some neurons, regular alternations of excitatory and inhibitory effects, strongly depending on the level of prestimulus background activity, were present during repeated presentations of the stimuli (Brazhnik and Vinogradova, 1977).

The following conclusions on functional significance of the cortical input to the hippocampus can be done on the basis of these data:

1) The sources of direct cortical input to the hippocampus (MEC, LEC, and PSB) transmit complex, highly differentiated signals of various modalities, preprocessed at the highest levels of their input

neocortical structures. The quality of these informational signals is partly preserved in CA1 and the subiculum, which can be regarded as primary targets for direct cortical input. This conclusion is supported by the disappearance of such responses in CA1 after transection of the cortical input.

2) The main part of the cortical input to CA3 reaches it after additional processing by FD neurons. Analysis of morphological organization of PP contacts with dendrites of granular cells (as well as those of mossy fibers with CA3 pyramidal cells) supports the role of FD as preliminary "mixer" of cortical information to CA3, where sensory messages are secondarily generalized and simplified before their transmission to CA3 neurons. Presumably, such symmetric transformation of signals at both inputs to CA3 (by MS-DB and FD) is essential for its action as a comparator which must detect only the presence and level of signals in its two inputs without their detailed analysis.

3) Retarded shaping of responses in sources of the cortical input may be a consequence of multistage processing of signals in the hierarchy of cortical areas.

4) All links of cortical input (PP, mossy fibers) are characterized by the presence of LTP, which can be easily evoked in vivo even by relatively weak stimuli. Hippocampal neurons with potentiated cortical input do not respond to sensory stimuli. Conversely, elimination of cortical input results in increased reactivity and complete disappearance of habituation, with prolongation of tonic responses. Thus, increase of the cortical input signal for CA3 neurons is equivalent to familiarity of a stimulus (Fig. 7).

5) Complete habituation is absent at both hippocampal inputs. Thus, rapid suppression of responses typical of the CA3 neurons is not a passive reflection of habituation at some of its inputs, but is organized in the hippocampus itself. It is probable that the effects of partial and complete habituation, present in some input structures (RF, MS-DB), can be organized with participation of the efferent modulating influences of the hippocampus itself (see below).

6) Additionally it should be noted that excitation or inhibition are not intrinsically determined qualities of the tonic responses. They depend on functional interactions of segmental organized hippocampal connections (PP, mossy fibers, and Schaffer collaterals). Without these connections, the direction of change during tonic sensory responses becomes destabilized.

REGULATORY OUTPUTS OF CA3

The field CA3 has an important strategic position in the hippocampal circuitry. On the one hand, its output fibers, partly relayed at the lateral septal nucleus (LS), descend in the precommissural fornix to diencephalic-brain stem structures and control their activity. This output flexibly regulates the level of arousal, necessary for optimal processing and registration of information. On the other hand, through the powerful system of Schaffer collaterals, the CA3 may strongly influence informational processes in the CA1.

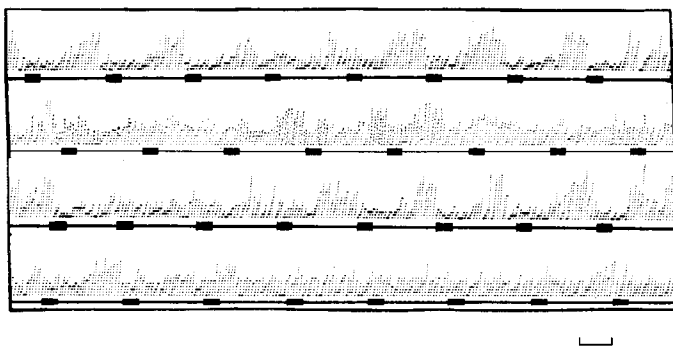

FIGURE 7. Effects of stimulation of input pathways on sensory responses of a CA3 neuron. Record of ongoing neuronal activity by integrator. Top trace, tonic inhibitory responses to a tone of 700 Hz in control state. Second trace, same tone after short tetanization of entorhinal cortex (10 Hz, 5 s). Third trace, the same stimulus after identical stimulation of reticular formation. Bottom trace, the same stimulus after simultaneous cortical and reticular inputs. Time calibration, 1 s.

Analysis of descending CA3 output signals was done in LS, RF, and median raphe nucleus (mRph) neurons. The following facts were obtained:

- 1) In LS, the neuronal responses to sensory stimuli are represented by excitatory and inhibitory tonic, stimulus-unspecific effects. All responses linearly habituate with repeated presentations of stimuli. Regarding the present interest in the functions of the nucleus accumbens, which also receives substantial projection from CA3, it is worthwhile to mention that in our experiments, responses of the accumbens neurons, which were represented exclusively by long-latency multimodal phasic effects, also were characterized by rapid linear habituation (Zolotukhina and Vinogradova, 1973). Responses of RF neurons were described above. The neurons of mRph with high, often extremely regular (“pacemaker-like”) background spike discharges responded to various stimuli by tonic shifts in level of activity. In 40% of neurons, initial very simple (single spike or short burst) on-effects are also present; about half of responses habituated.
- 2) Electrical stimulation of the hippocampus suppressed responses in a major group of LS neurons. It also influenced theta-generating neurons of the MS-DB, invariably suppressing theta-bursts or decreasing their frequency and synchrony.
- 3) Hippocampal stimulation was highly effective for the neurons of mRph. It evoked prolonged tonic shifts of neuronal discharges to higher frequencies and increases or even emergence of previously absent responses to sensory stimuli. In RF, the effects were opposite: a gradual shift to the lower frequencies with repeated stimulation, and blockade or decrease of sensory responses in an absolute majority of neurons (91%).
- 4) After transection of the CA3 descending pathways, the main characteristics of sensory responses in targets were not significantly changed. However, habituation of responses was absent, and gradual increase of reactions was observed (Fig. 8). We did not test the nucleus accumbens in these conditions, but there are reasons to suggest that the same disappearance of gradual habituation occurred also its neurons.

5) In the brain stem, the mean frequency of spontaneous activity was changed, especially in mRph, where it decreased from 30.2–6.8 sp/s to 21.3–5.4 sp/s ($P < 0.005$); in RF it became higher, but the difference was statistically nonsignificant. Reactivity of mRph neurons to sensory stimuli decreased (50% vs. 73%), while it increased in RF (71% vs. 58%). Latencies of on-effects became significantly shorter in RF and longer in mRph (Brazhnik and Vinogradova, 1975; Kitchigina and Vinogradova, 1979).

Schaffer collaterals (SC) constitute another significant output from CA3. Previously, when effectiveness of the sensory input synapsing on the terminal parts of apical dendrites was not recognized, SC were regarded as the last link in “the three-synaptic chain” (PP-FD-CA3-CA1), by which the cortical input signals reach CA1. The principal difference between diffuse responses of CA3 and differentiated reactions of CA1 neurons indicated that this long-standing statement was wrong. Now it is clear that CA1 neurons indeed receive their main afferent input directly from the cortical structures, but the character of SC influences remains one of the most difficult problems in functional organization of the hippocampus.

Here we summarize the data on analysis of this associative pathway:

- 1) Stimulation of SC evoked strong driving of single-spike responses in CA1, but with the parameters of stimulation used in our *in vivo* experiments (low intensity, 15 Hz), which evoked LTP in PP-FD and mossy fiber-CA3 synapses, LTP was not observed in SC, although it could be easily evoked *in vitro*. The changes of sensory responses after stimulation of SC lasted not more than 20–30 s and consisted of suppression or decrease of excitatory components and increase of the inhibitory ones.
- 2) Elimination of SC in a part of the hippocampus with registration of CA1 neurons in the corresponding segments was performed by two methods: local coagulation of a part of CA3, or local injection of GABA with functional suppression of CA3 activity. Both methods gave nearly the same results. The responsiveness to sensory stimuli in the CA1 in absence of CA3 influences was increased (82% vs. 67%), but the characteristics of responses were changed. The proportion of neurons with tonic responses decreased by half. Correspondingly, the number of neurons with “specific” responses increased. Complete habituation was nearly absent; reactions had prolonged phases of initial shaping and increment (Kitchigina and Vinogradova, 1975).

The following conclusions about the functions of the CA3 output signals can be done:

- 1) CA3 output signals are not necessary for neuronal sensory responses in their targets.

FIGURE 8. Result of CA3 output signal elimination: transformation of decremental responses into incremental ones. A: LS. Responses of two neurons (high-frequency and low-frequency-high-amplitude spikes) to click. B: Responses of a reticular neuron to stimulation of ear. C: Responses of a CA1 neuron after local elimination of Schaffer’s collaterals to a train of 5 light flashes.

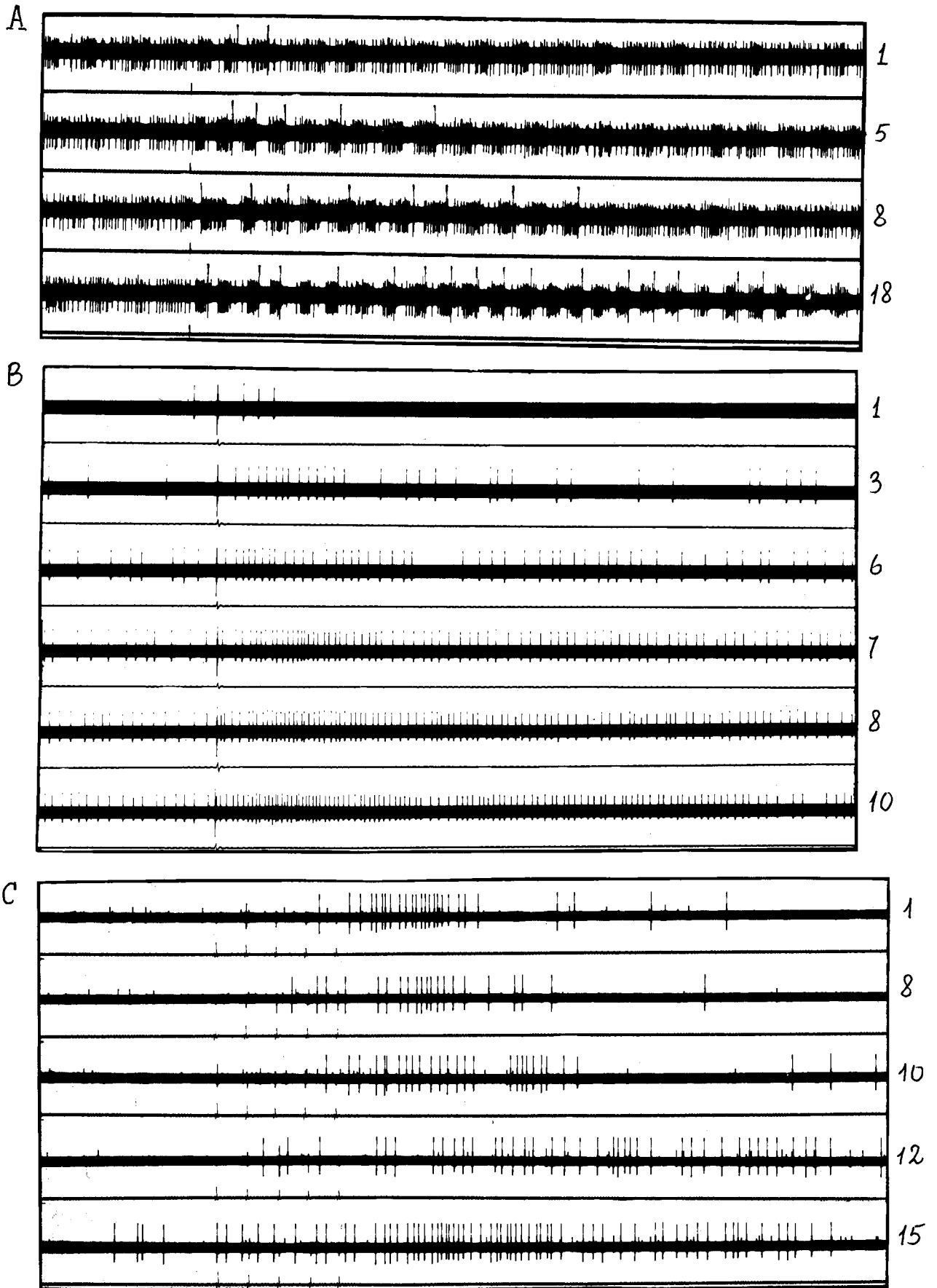

FIGURE 8

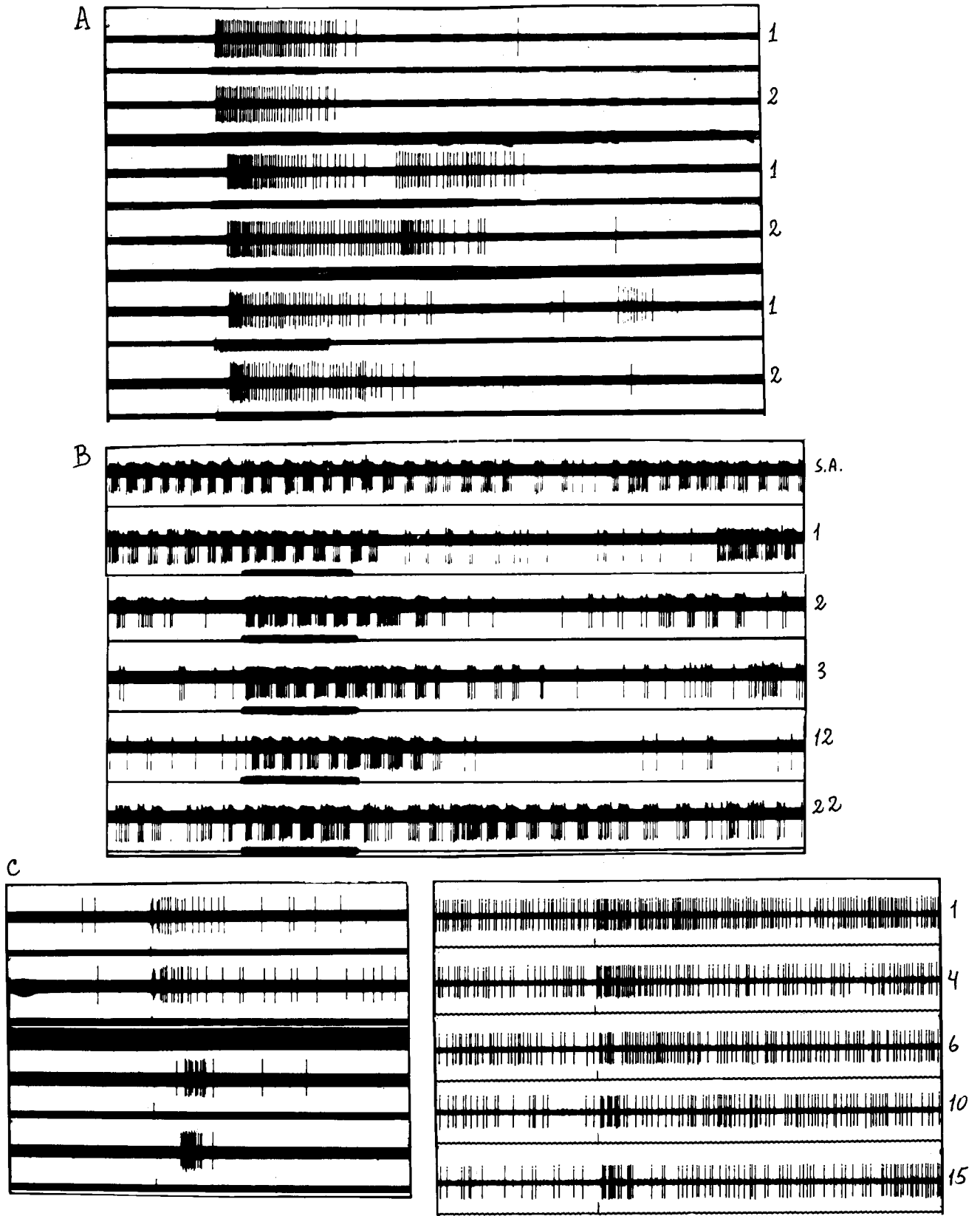

FIGURE 9

2) Habituation of sensory responses is completely determined by the integrity of CA3 influences.

3) Of the investigated brain-stem structures, mRph by all criteria is the primary target of hippocampal excitatory tonic control. It is probable that the inhibitory tonic control of RF by CA3 is mediated through the intermediary of mRph, the inhibitory influences of which upon RF were shown. The control of LS neurons by CA3 probably is realized through intrastructural inhibitory interneurons, which receive hippocampal influences.

4) It is suggested that in a constant environment, CA3, by tonic activation of mRph, keeps RF under inhibitory control. During the appearance of a novel stimulus, the output signal of CA3 decreases (the majority of neurons become tonically suppressed). Its influence on mRph is decreased, and RF is released from inhibitory control. Increase of arousal level creates the optimal conditions for orienting response and information processing. When CA3 responses habituate, and their dominating tonic inhibitory responses disappear, the volume of the CA3 descending output impulsion augments and the initial background conditions are reestablished.

5) The influences of SC, contrary to some previous interpretations, cannot act as signals that may summate with distally placed cortical inputs and help their signals to propagate to the cell bodies in CA1. Rather, by shunting the propagation of dendritic spikes, or by excitation of local inhibitory neurons at the border of the radiatum-lacunosum and moleculare in CA1, SC may block propagation of distal cortical signals. In this case, only those CA1 neurons which at the given period do not receive CA3 input (because of dominating tonic inhibitory responses) may participate in processing and transmission of information. Thus, SC are regarded as filters for access of cortical information to CA1 neurons.

INFORMATIONAL OUTPUT OF CA1-SUBICULUM

Information from CA1 neurons is relayed in the subiculum, which is the source of the postcommissural fornix. By this system, the output signal starts its long travel through the main limbic circuit, comprising mammillary bodies, anterior thalamic nuclei, and the cingulate limbic cortex. Their ultimate signal carries information, which returns to the neocortex (Fig. 9).

FIGURE 9. Structures of main limbic circuit. A: Phase responses of a neuron in medial mammillary nucleus. Two upper records: tone of 800 Hz, 1 s. Two middle records: same tone prolonged up to 2.5 s. Two bottom records: return to initial stimulus duration of 1 s. After each change of stimulus there was a tendency to reproduce the reaction to the previous stimulus length. B: Responses with theta-modulation and suppression of background activity in AV nucleus of thalamus. First record: spontaneous activity (S.A.); response is first shaped, and then masked by spontaneous activity. C: On-responses of PLC neurons. Left: responses of a neuron to click (above) and to light flash (below). Right: gradual shaping of on-response to tactile stimulation of the ear, with simultaneous decrease of level of background activity.

1) The main target of the postcommissural fornix, the medial mammillary nucleus (MMN), consists of typical relay neurons. Half of these neurons have high, extremely regular activity of pacemaker type, while the other half have very low-frequency irregular discharges or no background activity at all. Only these neurons respond to stimuli by strictly phasic discharge of regular spikes.

2) MMB neurons can be unimodal or multimodal, but they never respond differentially to the stimuli within one modality.

3) In a considerable number of cells, the responses are stable (48%). Responses of other neurons often appear only by third to fourth stimulus presentations; some of them later gradually habituate, with a simultaneous increase of latency and shortening of the response ("V-type" of habituation).

4) The most prominent characteristic of MMB neurons consists of a strong tendency to reproduce the temporal characteristics of a stimulus. After a series of stimuli (e.g., 1 s long, with 5-s intervals) and sudden shortening of the stimulus (e.g., to 0.5 s), responses continue up to the usual duration in spite of that, or stop at the usual duration after its sudden prolongation (e.g., 5 s), and can be reproduced several times with the standard intervals after switching off the series of stimuli (Vinogradova et al., 1970).

The main target of MMB axons, following in the mammillothalamic tract (MTT), is the anteroventral nucleus of the thalamus (AVT). We will not consider here the nuclei of the anterior thalamus (anteromedial and anterodorsal), which do not participate in the mainstream of information processing and have, as was shown in our experiments, quite different characteristics of responses. The AVT, which progressively develops in mammals, receives direct inputs from CA1-subiculum and MS. Activity of 20% of AVT neurons is strongly modulated by theta-frequencies.

1) AVT neurons are highly reactive to sensory stimuli (90%); half of the neurons are multimodal. Responses of the majority of neurons are of phasic and complex patterned type, but tonic responses of limited duration (2–3 s) are also present. Excitatory responses dominate (80%).

2) Neurons respond selectively to stimuli within one modality, e.g., different neurons respond optimally or exclusively to the pure tones in some frequency band. Responses to pure tones were very weak or absent in some neurons in the medial part of AVT, but vigorous responses could be evoked by "natural sounds" (speech sounds and imitations produced by the experimenter) with very fine differentiation.

3) All types of responses, including tonic ones, in many neurons (49%) develop gradually, by fifth to eighth repeated presentations of a stimulus. As a rule, emergence of responses occurs at the expense of transformation of spontaneous activity, i.e., its suppression or increase in the intervals between stimuli. Habituation in this case develops as gradual recovery of the initial level of spontaneous activity. Trace reproduction of responses after cessation of stimulation is also often observed in AVT.

4) Three types of AVT deafferentation were used for the analysis of functional significance of its inputs: transection of MTT (elimination of MMB), transection of the postcommissural fornix (elimination of direct and relayed influences of hippocampus), and transection of the fornix and capsula interna, through which the

afferents from the posterior cingulate cortex and PSB reach AVT. Decrease of reactivity, “despecialization” of responses, and defects of habituation progressively increased after these three kinds of lesions. Only diffuse but very stable shifts of the level of activity remained in the AVT neurons with total frontal deafferentation (Pakhotin and Vinogradova, 1981, 1984).

From AVT, activity is transmitted through the cingulum to the posterior limbic cortex (PLC). We investigated various subfields of the anterior and posterior mesial cortex, but only PLC neurons, as the highest level of processing information in the limbic circuit, will be described here.

- 1) Reactions of PLC neurons are highly differentiated. Diffuse tonic responses are nearly absent. Complex patterned reactions and phasic effects can be combined in a single neuron; its responses to various stimuli of different and a single modality may have different latencies and patterns.
- 2) Gradual habituation of responses is nearly absent (17%), and usually is observed only as a partial reduction of the late components of response. Gradual emergence and shaping are characteristic of all types of PLC responses. They can develop in the course of the above-described process of transformation of spontaneous activity, and their masking may occur as a result of reappearance of the initial background activity, without reduction of the responses themselves.
- 3) The process of reaction formation is slow: in some cells it is necessary to repeat a stimulus for 12–18 times and more. The neurons with early emergence of responses often demonstrate a sudden change of reaction pattern after the same number of stimuli, which is steadily reproduced afterwards (Vinogradova and Stafekhina, 1974; Vinogradova, 1975b).

The following conclusions can be made on the basis of investigation of the structures of the limbic circuit:

- 1) On the whole, stimuli-specific codes are preserved at the outputs of all these structures. Tonic regulatory effects are nearly absent in them. Moreover, the specificity of highly differentiated neuronal codes is not only retained, but increased from one link of the system to another. MMB neurons obviously have some special function; although their reactions are not so complex and differentiated as in the following links, they are specifically tuned to fixation of the temporal parameters of information.
- 2) Habituation is not typical of these structures. All show incremental dynamics, which are slower, the further the structure is from the hippocampus. The increase in number of neurons with gradual shaping of responses, along with their slower development, allows us to regard the structures of the limbic circuit as a series of successively wired integrators and as a delay chain preventing premature fixation of memory trace.
- 3) The gradually shaping polymodal, complex, differentiated, information-specific responses in the highest structure of the limbic circuit (PLC) are the final signals received from the hippocampal system by the neocortex. It is suggested that these signals are critical for permanent fixation of information in the cortical memory storage.

MODE OF OPERATION OF THE HIPPOCAMPAL SYSTEM

The compressed description of the basic features of sensory responses in the main links of the hippocampal system and the interactions between them presented here do not include many details, without which some of our conclusions may seem too speculative. We could not include references to the vast and important data of morphological and functional (neuronal, electrophysiological, behavioral, clinical) investigations of this system which were the basis for planning the experiments and interpretation of the data obtained.

The hippocampal system is regarded as consisting of two large circular subsystems (Fig. 10). The first of them, linking the hippocampus (especially the CA3 area) to the brain-stem structures through the relay nuclei of the septum, is regarded as regulatory circuit. This system introduces into CA3 primary information about the changes in a relatively stable environment, and controls the general level of brain activity. Its increase by release of RF excitatory influences is necessary for arousal, orienting-response, attention-providing conditions for effective processing and fixation of information in the neocortex. Its suppression by the hippocampus through the intermediary of mRph is necessary for the “disconnection” of attention and its switching to other stimuli.

The system, which is linked mainly through the CA1 area, introduces into the hippocampus the same signals preprocessed in the neocortex and, after additional complex transformations of the information at its multiple relays (subiculum, MMB, AVT, PLC), returns it back to the neocortex as a final order for its registration in nonprimary areas. This system is regarded as an informational circuit, because the neuronal responses in its links retain the qualitative characteristics of the stimuli. The important feature of this system is the incremental dynamics of responses, which are slower, the further a relay structure is from CA1. This allows us to regard the structures of the main limbic circuit as a chain of successively linked integrators, in which each next link became active only after the signal is shaped at the preceding link, and as a delay line, which prevents rigid fixation of spurious, low-probability signals and helps to obtain the best organization of the classificatory system of trace storage in the long-term memory.

Both systems are connected through the CA3 area, which is regarded as a comparator device, detecting the novelty of a stimulus (i.e., absence of its trace in the memory system) on the basis of signals in its two inputs: those from the brain stem and cortex. Both signals are additionally preprocessed at the symmetrical relay structures at the entrance to CA3: MS-DB and FD. At both these relays, the additional procedure of secondary simplification and generalization of the input signals is performed. Large multipolar neurons of MS-DB with their widely distributed dendrites may summate and mix the signals ascending from the brain stem. The morphological features of the perforant-path contacts with the granular cells of FD (multiple en passant synapses of each single perforant fiber with dendrites of many granular cells within a segment of FD) and, additionally, the mode of mossy-fiber contacts

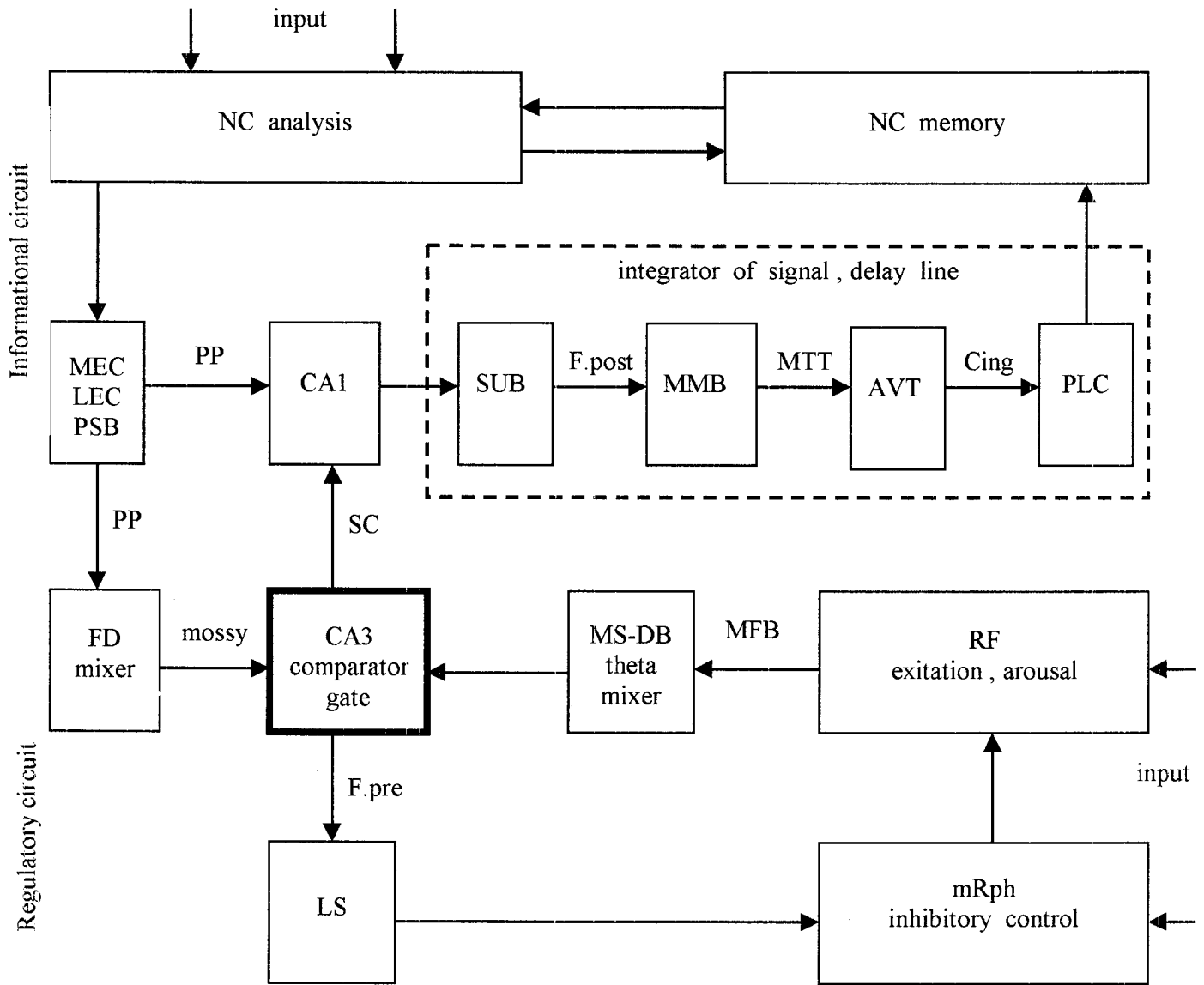

FIGURE 10. Scheme of two limbic circuits: regulatory and informational. Only principal connections are shown. For explanations, see text.

with pyramidal neurons, allow us to regard FD as a special mixer of cortical information for CA3. As a result, CA3 performs the very important but rather simple function of match-mismatch of signal weight (presence and level) in its two inputs, regardless of the concrete characteristics of the stimuli. The CA3 system is "opened" when the gradually forming cortical signal is absent or weak, and "closed" when a cortical signal develops.

One additional feature is important for the work of the comparator. The brain-stem input signal at the MS-DB relay is transformed into "quantal" form: strong theta-modulation is imposed on it by the septal pacemaker neurons before its entrance into the hippocampus. When theta is triggered by a sensory stimulus (or by RF stimulation), the first effect consists of a short inhibitory reset period stopping the spontaneous activity in the MS-DB and hippocampal neurons, after which synchronized theta-modulation follows at the background of tonic inhibition or excitation of the

neurons. When tonic theta-modulation is triggered by natural stimuli, by injection of physostigmine, or by functional switching off of inhibitory influences of mRph, other stimuli cannot "reset" the activity and are "filtered out," without access to the processing mechanisms of the hippocampus. Conversely, suppression of theta in the hippocampus leads to loss of selectivity and unlimited access of stimuli: thus, theta can be regarded as the mechanism of selective attention, which improves processing of a stimulus and simultaneously protects against the interference of other signals. It is important that secondary theta-modulation is imposed also on the main links of the cortical input (PSB, MEC, and FD). Thus, theta may have an additional function of the synchronization of both inputs, providing a "temporal window" for processing information only when the signals appear with a definite phase relation, which must increase the precision of the comparator's work.

We do not know yet the exact neurophysiological mechanism of the input interaction at the comparator CA3 neurons, but at the phenomenological level it is shown beyond doubt that stimulation of RF, effects of which have high correlation with CA3 sensory responses, increases its responses and recovers them after habituation, acting as a signal of novelty. On the other hand, stimulation of cortical input suppresses and blocks effects of sensory stimuli. Long-term potentiation of the perforant path and mossy fibers results in complete suppression of CA3 sensory responses. In this way, it may be said that potentiation in the cortical input is equivalent to the familiarity of a stimulus. Integrity of both inputs is necessary for the development of gradual habituation typical of CA3 sensory responses.

The descending output signal of CA3 neurons keeps RF under tonic inhibitory control. This control is not direct, but mediated through the serotonergic raphe neurons, which have a strong inhibitory influence on RF and its relay link, MS-DB, where stimulation of mRph slows down and blocks theta-rhythm.

The second CA3 output, by SC to CA1, probably works as an "or-filter," which may block transmission of cortical signals from the distal part of apical dendrites, where PP terminates. In this case, processing of a cortical signal and its further conduction are possible only for those CA1 pyramidal neurons, which at this time do not receive impulsation by SC, because the corresponding CA3 cells are tonically inhibited. Elimination of the input from CA3 does not change the main patterns of sensory responses in its targets (LS, mRph, RF, CA1), but their habituation disappears and is substituted by incremental dynamics.

The following mode of operation of the hippocampal system is suggested. In the constant environment, the hippocampus is in balanced "closed" state. The relatively high descending output signal of CA3 tonically activates mRph, which keeps RF under slight tonic inhibitory control (quiet waking). A change in the background of the constant environment evokes tonic inhibition in the majority of CA3 neurons. As a result, suppression of RF decreases; theta rhythm is triggered in the hippocampus and related structures by pacemaker neurons of MS-DB (detection of novelty, orienting response, attention). Simultaneously, the block of transmission of the cortical signals in some CA1 neurons is also switched off. The cortical signal which undergoes processing at higher levels is formed with delay. Its gradual increase in the discrete potentiated fibers of the cortical input results in gradual habituation of CA3 tonic responses. In parallel, the output signal of CA1 step by step passes through the system of the main limbic circuit. The signal is additionally processed and shaped at each level. From the highest link of this system, PLC, it returns to the nonprimary areas of the neocortex as the ultimate command for the trace record, after which it can be suppressed or masked by background activity. The system returns to the "closed" state (habituation of the orienting response, "disconnection" of attention, registration of information in memory). If a known stimulus appears after some time, the initial process with responses of CA3 neurons, arousal, and orienting response may occur again. However, it will be immediately stopped, because the corresponding cortical signal is already shaped and rapidly appears at the input of the system (recognition). This is a schematic description of the mode of hippocampal

participation in joined functions of attention and memory. This system is especially important at early stages of learning, for memorizing stimuli and their complex relations, and evaluation of signals against their environmental context. In spite of the general indifference of the comparator system to modality and other qualitative characteristics of signals, this system is absolutely necessary for organization of selective perception and suppression of irrelevant information, for habituation to invariant signals, and for detection of novel and significant changes which should be recorded in memory.

Acknowledgments

The author thanks V. Kitchigina, A. Karanov, and E. Lebedyeva for their help in preparation of the manuscript.

REFERENCES

- Barbeau D, Liang JJ, Robifaille Y, Quirion R, Srivastava LK. 1995. Decreased expression of the embryonic form of the neural cell adhesion molecule in schizophrenic brains. *Proc Natl Acad Sci USA* 92:2785–2789.
- Benes FM. 2000. Emerging principles of altered neural circuitry in schizophrenia. *Brain Res Rev* 31:251–269.
- Bogerts B. 1993. Recent advances in the neuropathology of schizophrenia. *Schizophr Bull* 19:431–445.
- Bragin AG, Vinogradova OS. 1973. Phenomenon of chronic potentiation in the cortical afferent input to the CA3 pyramidal neurons of the hippocampus. In: Gromova EA, editor. *Physiological mechanisms of memory*. Puschino: Puschino Publishing House. p 8–24 [in Russian].
- Bragin AG, Vinogradova OS, Emel'yanov VV. 1976. Influence of the fascia dentata on sensory responses of hippocampal neurons in area CA3. *Neurosci Behav Physiol* 7:334–339.
- Bragin AG, Otmakhov NA, Vinogradova OS. 1977. Analysis of non-switched influences of the perforant path on the CA3 neurons in vitro. *Proc Acad Sci USSR* 233:249–252 [in Russian].
- Brazhnik ES, Vinogradova OS. 1973. Chronic extinction of neuronal reactions to sensory stimuli in the hippocampal field CA3. In: Cherkashin AN, Kultas KN, editors. *Limbic system*. p 174–190. Puschino: Puschino Publishing House. p 174–190 [in Russian].
- Brazhnik ES, Vinogradova OS. 1975. Effect of septo-hippocampal disconnection upon neuronal activity of the septum. *Zh Vyssh Nerv Deiat* 25:1044–1052 [in Russian].
- Brazhnik ES, Vinogradova OS. 1977. Effect of interruption of the cortical input on hippocampal unit activity. *Neurosci Behav Physiol* 8:177–184.
- Burgess AP, Gruzelier JH. 1997. Short duration synchronization of human theta rhythm during recognition memory. *Neuro Rep* 8:1039–1042.
- Cohen RM, Semple WE, Gross M, Nordahl TE, LeLisi LE, Holcomb HH, King AC, Morihisa JM, Pickar D. 1987. Dysfunction in a prefrontal substrate of sustained attention in schizophrenia. *Life Sci* 40:2031–2039.
- Collinge J, Curtis D. 1991. Decreased hippocampal expression of a glutamate receptor gene in schizophrenia. *Br J Psychiatry* 159:857–859.
- Copolov D, Velakoulis D, McGorry P, Mallard C, Yung A, Rees S, Jackson G, Rehn A, Brewer W. 2000. Neurobiological findings in early phase schizophrenia. *Brain Res Rev* 31:157–165.
- Cother D, Kerwin R, Doshi B, Sanchez-Martin C, Everall IP. 1997. Alterations in hippocampal non-phosphorylated MAP2 protein expression in schizophrenia. *Brain Res* 765:238–246.

- Csernansky JG, Joshi S, Wang L, Haller JW, Gado M, Miller JP, Grenander U, Miller MJ. 1998. Hippocampal morphometry in schizophrenia by high dimensional brain mapping. *Proc Natl Acad Sci USA* 95:11406–11411.
- Doppelmayr M, Klimesch W, Schwaiger J, Auinger P, Winkler T. 1998. Theta synchronization in the human EEG and episodic retrieval. *Neurosci Lett* 257:53–56.
- Eastwood SL, Harrison P.J. 1998. Hippocampal and cortical growth-associated protein-43 messenger RNA in schizophrenia. *Neuroscience* 86:437–448.
- Eichenbaum H. 1997. To cortex: thanks for the memories. *Neuron* 19:481–484.
- Furuzako H, Yamada K, Kodama S, Yonezawa T. 1997. Hippocampal volume asymmetry and age at illness onset in males with schizophrenia. *Eur Arch Psychiatry Clin Neurosci* 247:248–251.
- Glickman SE, Higgins TJ, Isaacson RL. 1970. Some effects of hippocampal lesions on the behavior of Mongolian gerbils. *Physiol Behav* 5:931–938.
- Grace AA. 2000. Gating of information flow within the limbic system and the pathophysiology of schizophrenia. *Brain Res Rev* 31:330–341.
- Grastyan E. 1985 Historical overview of the search for behavioural correlation of brain rhythms. In: Buszaki G, Vandervolf CH, editors. *Electrical activity of the archicortex*. Budapest: Akademiai Kiado. p 1–20.
- Grossberg S, Merrill JWL. 1992. A neural network model of adaptively timed reinforcement learning and hippocampal dynamics. *Cogn Brain Res* 1:3–38.
- Heckers S, Rauch SL, Goff D, Savage CK, Schacter DL, Fischman AJ, Alpert NM. 1999. Impaired recruitment of the hippocampus during conscious recollection in schizophrenia. *Nat Neurosci* 2:24–30.
- Jarrard LE, Bunnell BN. 1968. Open field behavior of hippocampal-lesioned rats and hamsters. *J Comp Physiol Psychol* 66:500.
- Jonsson SAT, Luts A, Guldborg-Kjaer N, Brun A. 1997. Hippocampal pyramidal cell disarray correlates negatively to cell number: Implications for the pathogenesis of schizophrenia. *Eur Arch Psychiatry Clin Neurosci* 247:120–127.
- Kahana MJ, Sekuler R, Caplan JB, Kirschen M, Madsen JR. 1999. Human theta oscillations exhibit task dependence during virtual maze navigation. *Nature* 399:781–784.
- Kerwin R, Patel S, Meldrum B. 1990. Quantitative autoradiographic analysis of glutamate binding sites in the hippocampal formation in normal and schizophrenic brain post mortem. *Neuroscience* 39:25–32.
- Kim C, Choi H, Kim JK, Chang HK, Park PS, Kong IY. 1970. General behavioral activity and its component patterns in hippocampotomized rats. *Brain Res* 19:379–394.
- Kitchigina VF, Vinogradova OS. 1974. Effects of hippocampal stimulation on neuronal activity of reticular formation. *Physiol J USSR* 60:1648–1656 [in Russian].
- Kitchigina VF, Vinogradova OS. 1975. Significance of Schaffer's collaterals for sensory responses of the neurons in CA1 hippocampal field. *Zh Vyssh Nerv Deiat* 25:1266–1273 [in Russian].
- Kitchigina VF, Vinogradova OS. 1979. Effects of elimination of the hippocampal influences upon some midbrain nuclei. *Zh Vyssh Nerv Deiat* 29:159–166 [in Russian].
- Klimesch W. 1999. EEG alpha and theta oscillations reflect cognitive and memory performance: a review and analysis. *Brain Res Rev* 29:169–195.
- Marsh L, Suddath RL, Higgins N, Weinberger DR. 1994. Medial temporal lobe structures in schizophrenia: relationship of size to duration of illness. *Schizophr Res* 11:225–238.
- Meador-Woodruff JH, Healey DJ. 2000. Glutamate receptor expression in schizophrenic brain. *Brain Res Rev* 31:288–294.
- Miller RR, Matzel RD. 1988. The comparator hypothesis: a response rule for the expression of associations. In: Bower GH, editor. *Psychology of learning and motivation*. New York: Academic Press. p 51–92.
- Mishkin M, Vargha-Khadem F, Gadian DG. 1998. Amnesia and the organization of the hippocampal system. *Hippocampus* 8:212–216.
- Oades RD, Sartory G. 1997. The problems of inattention: methods and interpretations. *Behav Brain Res* 38:3–10.
- Pakhotin PI, Vinogradova OS. 1981. Characteristics of neuronal reactions in limbic nuclei of thalamus. Anteroventral and anteromedial nuclei. *Zh Vyssh Nerv Deiat* 31:819–829 [in Russian].
- Pakhotin PI, Vinogradova OS. 1984. Activity of the neurons of anterior thalamic nuclei after lesion of the afferent connections from hippocampus and limbic cortex. *Zh Vyssh Nerv Deiat* 34:1135–1143 [in Russian].
- Penfield W, Milner B. 1958. Memory deficit produced by bilateral lesions in the hippocampal zone. *AMA Arch Neurol Psychiatry* 79:475–492.
- Pribram KH. 1986a. Preface. In: Isaacson RL, Pribram KH, editors. *The hippocampus, volume 4*. New York: Plenum Press. p vii–xiii.
- Pribram KH. 1986b. The hippocampal system and recombinant processing. In: Isaacson RL, Pribram KH, editors. *The hippocampus, volume 4*. New York: Plenum Press. p 329–370.
- Roberts W, Dember WN, Brodwick M. 1962. Alternation and exploration in rats with hippocampal lesions. *J Comp Physiol Psychol* 55:695.
- Salzmann E. 1992. Importance of the hippocampus and parahippocampus with reference to normal and disordered memory function. *Fortschr Neurol Psychiatrie* 60:163–176 [in German].
- Semyonova TP, Vinogradova OS. 1970. Characteristics of neuronal activity of the ventral hippocampus. *Zh Vyssh Nerv Deiat* 20:1031–1042 [in Russian].
- Sokolov EN. 1960. Nervous model of stimulus and the orienting reflex. *Voprosy Psichologii* 4:128–137 [in Russian].
- Squire LR. 1992. Memory and the hippocampus: a synthesis from findings with rats, monkeys and humans. *Psychol Rev* 99:195–231.
- Squire LR, Shimamura AP, Amaral DG. 1988. Memory and the hippocampus. In: Byrne IH, Berry WO, editors. *Neural models of plasticity*. New York: Academic Press. p 208–239.
- Stabenau JR, Pollin W. 1993. Heredity and environment in schizophrenia, revisited. *J Nerv Ment Dis* 181:290–307.
- Stafekhina VS, Vinogradova OS. 1978. Characteristics of the hippocampal cortical input. Functional differences between lateral and medial entorhinal areas. *Neurosci Behav Physiol* 9:8–14.
- Stafekhina VS, Vinogradova OS. 1979a. Characteristics of neuronal activity of the hippocampal formation subdivisions. I. Subiculum. *Zh Vyssh Nerv Deiat* 29:1009–1017 [in Russian].
- Stafekhina VS, Vinogradova OS. 1979b. Characteristics of neuronal activity of the hippocampal formation subdivisions. II. Presubiculum. *Zh Vyssh Nerv Deiat* 29:1276–1284 [in Russian].
- Stratta P, Daneluzzo E, Prosperini P, Bustini M, Marnangeli MG, Rossi A. 1999. Spatial working memory assessment by a visual-manual delayed response task: a controlled study in schizophrenia. *Neurosci Lett* 275:9–12.
- Tamming CA. 1998. Schizophrenia and glutamatergic transmission. *Crit Rev Neurobiol* 12:21–36.
- Vinogradova OS. 1959. The role of the orienting reaction in process of conditioning in human subjects. In: Sokolov EN, editor. *Orienting reflex and problems of higher neurons activity*. Moscow: Moscow University Press [in Russian] p 86–160.
- Vinogradova OS. 1961. Orienting relations and their neurophysiological mechanisms. Moscow: Pedagogical Academic Science Publishing House. 207 p [in Russian].
- Vinogradova OS. 1966. Dynamic classification of the reactions of hippocampal neurons to sensory stimuli. *Fed Proc [Neurosci Transl Suppl]* 25:1397–1403.
- Vinogradova OS. 1975a. Hippocampus and the orienting reaction. In: Sokolov EN, Vinogradova OS, editors. *Neuronal mechanisms of the orienting reflex*. Hillsdale, NJ: Erlbaum. p 183–215.
- Vinogradova OS. 1975b. Functional organization of the limbic system in registration of information. Facts and hypotheses. In: Isaacson RL, Pribram KH, editors. *The hippocampus, volume 2*. New York: Pergamon Press. p 3–70.
- Vinogradova OS. 1995. Expression, control, and probable functional significance of the neuronal theta-rhythm. *Prog Neurobiol* 37:523–583.

- Vinogradova OS, Bragin AG. 1975. Sensory characteristics of the hippocampal cortical input. Dentate fascia. *Zh Vyssh Nerv Deiat* 25:410–420 [in Russian].
- Vinogradova OS, Brazhnik ES. 1978. Neuronal aspects of the septo-hippocampal relations. In: Gray J, Weiskrantz L, editors. *Functions of the septo-hippocampal system*. Amsterdam: Elsevier. p145–171
- Vinogradova OS, Dudaeva KI. 1971. Functional characteristics of the hippocampal field CA1. *Zh Vyssh Nerv Deiat* 21:577–585 [in Russian].
- Vinogradova OS, Dudaeva KI. 1972. On comparator function of the hippocampus. *Proc Acad Sci USSR* 202:241–244 [in Russian].
- Vinogradova OS, Stafekhina VS. 1974. Some properties of dynamics of neuronal activity in the limbic cortex of the rabbit. *Zh Vyssh Nerv Deiat* 24:337–346 [in Russian].
- Vinogradova OS, Zolotukhina LI. 1972. Sensory responses of the neurons in the medial and lateral septal nuclei. *Zh Vyssh Nerv Deiat* 22:1260–1269 [in Russian].
- Vinogradova OS, Semyonova TP, Kononov VP. 1970. Trace phenomena in the neurons of the limbic structures. In: Pribram K, Broadbent A, editors. *Biology of memory*. New York: Academic Press. p 191–221.
- Vinogradova OS, Brazhnik ES, Kichigina VF, Stafekhina VS. 1992. The theta modulation of rabbit hippocampal neurons and its correlation with other indices of spontaneous and evoked activity. *Zh Vyssh Nerv Deiat Im IP Pavlova* 42:95–111 [in Russian].
- Vinogradova OS, Brazhnik ES, Stafekhina VS, Kitchigina VF. 1993a. Theta-rhythm, acetylcholine and activity of the hippocampal neurons in rabbit: IV. Sensory responses. *Neuroscience* 53:993–1007.
- Vinogradova OS, Brazhnik ES, Kitchigina VF, Stafekhina VS. 1993b. Theta modulation of neurons of the hippocampus of the rabbit and its interrelationship with other parameters activity. *Neurosci Behav Physiol* 23:226–239.
- Vinogradova OS, Kitchigina VF, Kudina TA, Zenchenko KI. 1999. Spontaneous activity and sensory responses of hippocampal neurons during persistent theta rhythm evoked by median raphe nucleus blockade in rabbit. *Neuroscience* 94:745–753.
- Weiskrantz L, Warrington EK. 1975. The problem of the amnesic syndrome in man and animals. In: Isaacson RL, Pribram KH, editors. *The hippocampus, volume 2*. New York: Plenum Press. p 411–428.
- Wood ER, Dudchenko PA, Eichenbaum H. 1999. The global record of memory in hippocampal neuronal activity. *Nature* 397:613–616.
- Zolotukhina LI, Vinogradova OS. 1973. Characteristics of neuronal responses in nucleus accumbens septi to sensory stimulation. *Zh Vyssh Nerv Deiat* 23:615–621 [in Russian].