



Delft University of Technology

Hourly and Daily Urban Water Demand Predictions Using a Long Short-Term Memory Based Model

Mu, Li; Zheng, Feifei; Tao, Ruoling; Zhang, Qingzhou; Kapelan, Zoran

DOI

[10.1061/\(ASCE\)WR.1943-5452.0001276](https://doi.org/10.1061/(ASCE)WR.1943-5452.0001276)

Publication date

2020

Document Version

Accepted author manuscript

Published in

Journal of Water Resources Planning and Management

Citation (APA)

Mu, L., Zheng, F., Tao, R., Zhang, Q., & Kapelan, Z. (2020). Hourly and Daily Urban Water Demand Predictions Using a Long Short-Term Memory Based Model. *Journal of Water Resources Planning and Management*, 146(9), [05020017]. [https://doi.org/10.1061/\(ASCE\)WR.1943-5452.0001276](https://doi.org/10.1061/(ASCE)WR.1943-5452.0001276)

Important note

To cite this publication, please use the final published version (if applicable). Please check the document version above.

Copyright

Other than for strictly personal use, it is not permitted to download, forward or distribute the text or part of it, without the consent of the author(s) and/or copyright holder(s), unless the work is under an open content license such as Creative Commons.

Takedown policy

Please contact us and provide details if you believe this document breaches copyrights. We will remove access to the work immediately and investigate your claim.

1 **Hourly and daily urban water demand predictions using a long short-term**
2 **memory based model**

3
4 Li Mu, Feifei Zheng*, Ruoling Tao, Qingzhou Zhang and Zoran Kapelan

5
6 **Li Mu:** Deputy Chief Engineer, Hefei Water Supply Group Co., Ltd, muli@hfwater.cn

7 **Feifei Zheng:** Corresponding author, Professor, College of Civil Engineering and Architecture,
8 Zhejiang University, 866 Yuhangtang Rd, Hangzhou, China 310058. feifeizheng@zju.edu.cn

9 **Ruoling Tao:** Master Student, College of Civil Engineering and Architecture, Zhejiang University,
10 taoruoling@zju.edu.cn

11 **Qingzhou Zhang:** Postdoctoral fellow, College of Civil Engineering and Architecture, Zhejiang
12 University, 866 Yuhangtang Rd, Hangzhou, China 310058. wdswater@gmail.com

13 **Zoran Kapelan,** Professor, Delft University of Technology, Faculty of Civil Engineering and
14 Geosciences, Department of Water Management, Stevinweg 1, 2628 CN Delft, Netherlands.
15 z.kapelan@tudelft.nl

16

17 **Abstract:**

18 This case study uses a long short-term memory (LSTM) based model to predict
19 short-term urban water demands for the Hefei City of China. The performance of the
20 LSTM based model is compared with autoregressive integrated moving average
21 (ARIMA) model, the support vector regression (SVR) model and the random forests
22 (RF) model based on data with time resolutions ranging from 15-minute to 24-hour.
23 Additionally, this paper investigates the performance of the LSTM based model in
24 predicting multiple successive data points. Results show that the LSTM based model
25 can offer predictions with improved accuracy than the other models when dealing
26 with data with high time resolutions, data points with abrupt changes and data of a
27 relatively high uncertainty level. It is also observed that the LSTM based model
28 exhibit the best performance in predicting multiple successive water demands with
29 high time resolutions. In addition, the inclusion of external parameters (e.g.,
30 temperature) cannot enhance the performance of the LSTM based model, but it can
31 improve ARIMAX's prediction ability (ARIMAX is the ARIMA with variables).
32 These obtained insights based on the Hefei case study provide additional and
33 improved knowledge as well as evaluations regarding the LSTM based models used

34 for short-term urban water demand forecasting, thereby enabling their wider take-ups

35 in practical applications.

36 **Key words:** Water demand prediction; long short-term memory; data-driven models;

37 ARIMA models

38

39 **Introduction**

40 Urban water demand predictions are often important to the sustainable
41 management of water supply systems for a range of purposes, including system
42 design, maintenance and operation (Billings and Jones, 2008; Zheng et al. 2016, 2017;
43 Qi et al., 2018). Accurate urban demand forecasts have become even more vital for
44 many cities in recent years due to the emerged water crisis as a result of rapid
45 urbanization and climate change, as well as driven by the need of real-time system
46 operation (Hutton and Kapelan, 2014; Pacchin et al., 2019). This, consequently, has
47 motivated intensive studies to develop models for urban demand prediction, thereby
48 enabling an effective water usage planning and scheduling (Pacchin et al., 2019).

49 A number of models are available for urban water demand forecasts with different
50 prediction periodicity and forecast horizon (Donkor et al., 2014). More specifically,
51 long-term forecasts usually focus on time periods more than ten years, often providing
52 guidance for city planning and development (Levin et al., 2006). Medium-term
53 forecasts often predict demands at a monthly or yearly resolution, and these
54 predictions are mainly used to develop strategies for water usages (Ghiassi et al.,

55 2008). Short-term forecasts at hourly or daily resolutions are generally employed to
56 enable the effective operations of water treatment plants or pumping stations,
57 typically aimed to provide sufficient demands for urban users with the lowest
58 operation cost (Guo et al., 2018).

59 Traditionally, urban demand forecast models are generally developed based on
60 statistical methods (Howe and Linaweaver, 1967). This is because demand variations
61 are often driven by a group of factors including meteorological parameters and
62 socioeconomic elements (Arbués et al., 2003). Therefore, various linear regression
63 models are used to reveal the underlying relationships between urban water demands
64 and the external affecting parameters, thereby providing long-term demand forecasts
65 based on the projections of the external parameters (e.g., populations, Jain et al.,
66 2001). However, the accuracies of these simple linear regression models are often
67 unsatisfactory, especially in the case of predicting short-term urban water demands
68 (e.g., daily, Wong et al., 2010).

69 In recognizing the potential limitation of simple linear regression models, many
70 data-driven models have been developed to improve demand forecast accuracy

71 (Donkor et al., 2014). Autoregressive models, one type of data-driven models, have
72 been widely used in both the academic field and engineering community, in which a
73 time series analysis is often used to analyze the historical data (Chen and Boccelli,
74 2018). It has been widely demonstrated that these autoregressive models, such as
75 autoregressive integrated moving average (ARIMA) model, can exhibit better
76 performance than traditional linear regression models in predicting short-term urban
77 water demands (Chen and Boccelli, 2018).

78 In parallel to the development of the autoregression models, many other
79 data-driven models are also proposed to predict urban water demands
80 (Ghalekhondabi et al., 2017). These include artificial neural networks (ANNs) that
81 have been broadly used for urban water demand forecasts (Ghiassi et al., 2008), the
82 support vector regression (SVR, Bai et al., 2015) model and the random forests (RF,
83 Chen et al., 2017) model that also show great merits for demand predictions. These
84 advanced data-driven models have shown improved performance than many
85 traditional prediction methods, such as autoregressive models (Villarin and
86 Rodriguez-Galiano, 2019).

87 In recent years, a type of recurrent neural networks named as the long short-term
88 memory (LSTM) based model has been emerged as an important prediction tool (Guo
89 et al., 2018). Compared to traditional ANNs, the LSTM based model is better suited
90 for time-series predictions as they possess the ability to preserve previous information
91 through learning time series data, thereby improving the accuracy of predictions
92 (Mikolov et al., 2010, Zhang et al., 2018). While the LSTM based models have been
93 broadly used in the area of artificial intelligence, such as language processing
94 (Sundermeyer et al., 2012), speech recognition (Graves and Jaitly, 2014), and image
95 captioning (Wang et al., 2016). To our best knowledge, only limited studies have been
96 undertaken so far to apply the LSTM based models to predict short-term urban water
97 demands. Guo et al. (2018) have made the first attempt to implement the LSTM
98 method for urban water demand predictions. In the study of Guo et al. (2018), the
99 performance of the LSTM based model has been compared with ARIMA and ANNs
100 based on data with 15-minute resolution, and results showed that the LSTM based
101 models exhibited better capacity than the other two methods in predicting accurate
102 water demands.

103 Given that the LSTM has only been investigated in Guo et al. (2018), there is
104 therefore a lack of sufficient case study application experience as well as
105 comprehensive understanding on its performance in dealing with short-term urban
106 water demand forecasts. These include how the LSTM based models perform (i)
107 when handling urban water demand predictions with various time resolutions as only
108 15-minute resolution data were considered in Guo et al. (2018), (ii) when predicting
109 inflection data points that have abrupt changes relative to their corresponding
110 neighbouring demand values, as well as data with a relatively high uncertainty level, (iii)
111 when comparing with other advanced data-driven models such as SVR and RF
112 models, in addition to the traditional ARIMA model considered in Guo et al. (2018),
113 and (iv) when predicting data with a 24-hour time resolution with the aid of external
114 covariates (such as temperature and rainfall). The present case study paper aims to
115 provide additional and improved knowledge as well as evaluations regarding the
116 LSTM' performance in predicting short-term urban water demands, thereby enabling
117 the wider up-takes of the LSTM based models for real-world applications.

118

119 **Short-term urban water demand prediction models**

120 As previously stated, the ARIMA, SVR and RF models are selected to enable the
121 performance comparison with the LSTM based models. The ARIMA is chosen due to
122 its wide applications in both the academic and industry fields, representing a standard
123 urban water demand prediction model (Guo et al., 2018). The SVR and RF models are
124 selected because they are advanced data-driven models that have shown great merits
125 for urban water demand forecasts (Bai et al., 2015, Chen et al., 2017), and hence it is
126 interested to demonstrate whether the LSTM based model (also a type of data-driven
127 model) can outperform the SVR and RF models or not (this comparison has not been
128 done in the area of the urban water demand prediction).

129 ***The long short-term memory (LSTM) based model***

130 A recurrent neural network (RNN) model is a specific kind of artificial neural
131 networks (ANNs), where the network of a RNN typically has connections between
132 neurons and form a directed cycle (Sutskever et al., 2014). This type of structure
133 creates an internal self-looped cell, which allows dynamic temporal behavior. The
134 gradients of RNNs can be computed via Backpropagation Through Time (BPTT)

135 algorithm (Gers et al., 2000), but this method is inefficient when learning patterns
136 from long-term dependency. To solve this problem, a long-short term memory
137 (LSTM) has been developed, where it is featured by that it can bring information
138 crossing several time steps, and hence prevent early signals from fading away (Zhang
139 et al., 2018). The main structure of the LSTM network is illustrated in Figure 1 (Gers,
140 2001), stressing the importance of three gates within the algorithm structure. These
141 are input gate, forget gate and output gate, with each gate represented by a sigmoid
142 neural network layer (σ) and a multiplicative unit (\times). These components allow the
143 weights converge dynamically, even though the model parameters are fixed.

144 The LSTM network computes a mapping from an input sequence to an output
145 sequence by calculating network unit activations using the equations as follows (Gers
146 et al., 2000):

$$i_t = \sigma(W_i x_t + U_i h_{t-1} + b_i) \quad (1)$$

$$f_t = \sigma(W_f x_t + U_f h_{t-1} + b_f) \quad (2)$$

$$o_t = \sigma(W_o x_t + U_o h_{t-1} + b_o) \quad (3)$$

$$g_t = \tanh(W_g x_t + U_g h_{t-1} + b_g) \quad (4)$$

$$s_t = g_t \otimes i_t + s_{t-1} \otimes f_t \quad (5)$$

$$h_t = \tanh(s_t) \otimes o_t \quad (6)$$

147 where \otimes denotes element-wise multiplication of two vectors; t denotes the current
148 time; $W_i, W_f, W_o, W_g, U_i, U_f, U_o$ and U_g denote the weights; b_i, b_f, b_o and b_g denotes the
149 bias; σ and \tanh are the sigmoid functions; x_t is the input vector; i_t refers to the
150 input threshold; f_t is the forget threshold; o_t refers to the output threshold; g_t is the
151 candidate cell state generated by the tanh neural network layer; s_t is the cell state at
152 time t ; h_t is the output vector. Specifically, the forget gate controls whether the cell
153 state of previous time is forgotten or not (Equation 2) and the input gate is responsible
154 for the input series at the current time (Equations 1). The two gates act on the
155 updating of current cell state (Equation 5) and then generate the output with the
156 output gate (Equations 3 and 6). One output h_t is the input of the recurrent procedure
157 as shown in Figure 1. Consequently, the LSTM method can prevent the gradient
158 explosion or vanishing issues during error back flow, and predict the output with
159 updated index.

160

161 ***Autoregressive integrated moving average (ARIMA)***

162 The development of ARIMA model can be dated back to 1976 by Box and
163 Jenkins (1976), and this model describes data sequence using linear functions of
164 previous data and random errors. The ARIMA is featured by its great ability to
165 capture the trend, seasonality and randomness of time series (Williams, 2001).
166 Generally, an ARIMA model consists of an autoregressive (AR) model, a difference
167 process that deals with non-stationary data, and a moving average (MA) model, with
168 details presented in Hao et al., (2013).

169 ***Support vector regression (SVR) models***

170 The core concept of the support vector regression (SVR) model is that it uses a
171 relatively small number of support vectors to represent the entire sample set and then
172 figures out a curve that can minimize the residual error for the data (Rasouli et al.,
173 2011). Given a set of l samples $[(x_1, y_1), \dots, (x_l, y_l)]$, where x_i are the input vectors and
174 y_i are the corresponding output values ($i=1, 2, \dots, l$), a group of functions $f(x, \alpha)$ can
175 be formulated to approximate the relationship between the x_i and y_i , where α is the

176 parameter vector of the function. Generally, a nonlinear decision function of an SVR

177 model ($f(w, b)$) can be expressed as:

$$f(w, b) = w \cdot \phi(x) + b \quad (7)$$

178 where w and b are the parameter vectors of the function; x is the input vector; $\phi(x)$

179 is a nonlinear function. The objective of the SVR model is to select a function from

180 the group of $f(x, \alpha)$ that can predict the output value as accurately as possible, which is

181 obtained by the minimization of the empirical risk R_{emp} as shown below,

$$R_{emp} = \frac{1}{N} \sum_{i=1}^N L_{\varepsilon}(y - f(x)) \quad (8)$$

182 where L_{ε} is the loss function between the observations (y) and model predictions ($f(x)$),

183 with details given in Gunn (1998). To solve the objective function in Equation (8), a

184 standard quadratic programming algorithm with a dual set of Lagrange multipliers is

185 often adopted (Yu et al., 2006), which is

$$\min_{w, b, \xi, \xi^*} \frac{1}{2} \sum_{i,j=1}^l (\alpha_i - \alpha_i^*)(\alpha_j - \alpha_j^*) \langle x_i \cdot x_j \rangle + \varepsilon \sum_{i=1}^l (\alpha_i + \alpha_i^*) - \sum_{i=1}^l y_i (\alpha_i - \alpha_i^*) \quad (9)$$

186 with constraints

$$\sum_{i=1}^l (\alpha_i - \alpha_i^*) = 0 \quad (10)$$

$$0 \leq \alpha_i, \alpha_i^* \leq C, i=1, 2, \dots, l \quad (11)$$

187 where C is the error penalty factor; l is the length of the training data; $\langle x_i \cdot x_j \rangle$ is the
 188 inner product of x_i, x_j ; α_i and α_i^* are the Lagrange multipliers for the i^{th} data point; ε is
 189 the error tolerance which is specified by the users ($\varepsilon=0.1$ is often used). To deal with
 190 nonlinear regressions, $\langle x_i \cdot x_j \rangle$ in Equation (9) is replaced by the computation of
 191 $\langle \phi(x_i) \cdot \phi(x_j) \rangle$ often using a radial basis function (RBF, Yu et al., 2006) as shown
 192 below,

$$\langle \phi(x_i) \cdot \phi(x_j) \rangle = e^{-\gamma |x_i - x_j|^2} \quad (12)$$

193 where γ is a user-defined parameter. In this study, the value of C and γ are determined
 194 based on a grid search method as described in Cherkassky and Ma (2004).

195 ***Random forests (RF)***

196 Given an input vector X and the corresponding output Y , the random forests (RF)
 197 model builds a number of q regression trees formed as $\hat{h}(X, S_n^{\theta q})$ followed by
 198 averaging the results, which can be presented as (Villarin and Rodriguez, 2019)

$$Y = \frac{1}{q} \sum_{l=1}^q \hat{h}(X, S_n^{\theta l}) \quad (13)$$

199 Where S_n is the training set; n is the number of observations; the bagging method
 200 selects several bootstrap samples $(S_n^{\theta_1}, \dots, S_n^{\theta q})$, and accordingly a set of trees

201 $(\hat{h}(X, S_n^{\theta_1}), \dots, \hat{h}(X, S_n^{\theta_q}))$; θ is the independent identically distributed random
202 variables representing the random selection.

203 Generally, two parameters need to be pre-specified for a RF model, that is, the
204 number of decision trees to be generated (q) and the number of selected input
205 variables m_t for each split θ . Since a RF model is often computationally efficient and
206 does not overfit, q can be set to a relatively large value (Guan et al., 2013). The
207 selection of m_t is based on the following equation (Were et al., 2015),

$$m_t = \left\lceil \sqrt{m} \right\rceil \quad (14)$$

208 where m is the total number of input variables (covariates), $\lceil x \rceil$ denotes the ceiling
209 function of x .

210 ***Benchmarking metrics***

211 Four metrics are considered in this study to enable the statistical analysis of the
212 model performance. These are the mean absolute percentage error (*MAPE*), the
213 Nash-Sutcliffe model efficiency (*NSE*), the coefficient of determination (R^2) and the
214 root mean square error (*RMSE*). Lower values of *MAPE* and *RMSE* indicate better fits
215 of the models, and larger values of *NSE* (the best value is 1) and R^2 (the best value is

216 1) represent better model performance These four metrics are selected due to their
 217 wide applications in the area of urban water demand forecasts (Chen et al., 2017,
 218 Zhang et al., 2018). The *MAPE* is defined as

$$MAPE = \frac{1}{N} \sum_{i=1}^N \left| \frac{Y_i - \hat{Y}_i}{Y_i} \right| \times 100\% \quad (15)$$

219 where Y_i represents the i^{th} observed value, and \hat{Y}_i is the i^{th} prediction value; N is the
 220 total number of data points being predicted; $\left| \frac{Y_i - \hat{Y}_i}{Y_i} \right|$ is the absolute relative error.

221 The *NSE* is defined as

$$NSE = 1 - \frac{\sum_{i=1}^n (Y_i - \hat{Y}_i)^2}{\sum_{i=1}^n (Y_i - \bar{Y})^2} \quad (16)$$

222 where \bar{Y} is the mean of the observations. The R^2 is defined as

$$R^2 = \frac{(\sum_{i=1}^n (Y_i - \tilde{Y})(Y_i - \bar{Y}))^2}{\sum_{i=1}^n (Y_i - \tilde{Y})^2 \sum_{i=1}^n (Y_i - \bar{Y})^2} \quad (17)$$

223 where \tilde{Y} is the mean of the predictions. The *RMSE* is defined as

$$RMSE = \sqrt{\frac{\sum_{i=1}^n (Y_i - \hat{Y}_i)^2}{n}} \quad (18)$$

224 **Case study**

225 ***Case study description***

226 The LSTM based model has been validated and its performance has been

227 compared to other three models on water demand records with a 15-minute resolution
228 in the city of Hefei, China. This city has a population of approximately eight million,
229 and the total water demands were approximately 0.59 billion m³ per year. As shown in
230 Figure 2, a total of seven water treatment plants (WTPs) are used to supply water to
231 this city. Such a large number of WTPs induces high operational complexities for this
232 system, and hence short-term water demand forecasts are important to enable an
233 effective operation of this system, thereby saving the clean water production and
234 operational cost. More specifically, the demand predictions of the 15-min resolution
235 can greatly facilitate the real-time modelling of this water supply system, which can
236 be accordingly used to, for example, enable the leakage and energy analysis (Creaco
237 et al. 2017). The 1-hour demand predictions are often utilized to determine optimal
238 scheduling strategies for the pump stations in the WTPs, thereby reducing the
239 operation cost (Guo et al. 2018).

240 A total of 70,080 records at a 15-min resolution from May 2016 to May 2018
241 have been collected from the local water utility in the city of Hefei. These demand
242 records are the total readings from the outflow meters at the water treatment plants as

243 there are no tanks in this water supply system. Figure 3(a) shows one-week records
244 with 15-min resolution for the total demands (TD), and Figure 3(b) presents one-week
245 demands with 15-minute resolution for a district metering area (DMA) within this
246 water supply system. It is seen that the demands of this DMA are very small relative
247 to the total demands of the entire city (TD), implying that this DMA only provides
248 water for a very small population size. Consequently, the demands of this DMA are
249 significantly more variable than the total demands as visualized in Figure 3,
250 representing a dataset with a relatively high uncertainty level.

251 *Computational experiments and model parameterizations*

252 A number of R and Python packages were used to develop the prediction models
253 applied to the case study. More specifically, the LSTM models were developed in the
254 python environment, with the aid of the functions from Keras library (Chollet, 2015).
255 R packages of “TSA”, “e1071” and “randomForest” were used to develop the
256 ARIMA, SVM and RF models respectively (Chang and Lin, 2001; Breiman, 2001).
257 The inputs of the LSTM based models were determined based on a comprehensive
258 sensitivity analysis, following the method outlined in Guo et al. (2018). More

259 specifically, for the LSTM based model applied to data with 15-min and 1-hour
260 resolutions, the timeline of the inputs was divided into three fragments, the current
261 day, the previous day and the day before yesterday. In each time fragment, a certain
262 number of data points between zero and ten have been tried to identify the inputs that
263 have the best performance. For the LSTM based model applied to data with 24-hour
264 resolution, one to ten previous consecutive days were tried as the inputs. The selected
265 inputs with the best model performance were presented in Table 1. As shown in this
266 table, to predict the data with the 15-min resolution at time t of the current day (Q_t^0),
267 the inputs were the demands of previous three time steps at the current day (Q_{t-3}^0 ,
268 Q_{t-2}^0, Q_{t-1}^0), demands of five consecutive time steps centered at time t at the previous
269 day ($Q_{t-2}^{-1}, Q_{t-1}^{-1}, Q_t^{-1}, Q_{t+1}^{-1}, Q_{t+2}^{-1}$), and demands of five consecutive time steps centered at
270 time t at the day before yesterday ($Q_{t-2}^{-2}, Q_{t-1}^{-2}, Q_t^{-2}, Q_{t+1}^{-2}, Q_{t+2}^{-2}$). In a similar way, the
271 inputs of the 1-hour and 24-hour resolutions for the LSTM based models, as well as
272 the inputs for the SVR and RF models were outlined in Table 1. For the ARIMA
273 model with 15-minute and 1-hour resolution at time t , the inputs were their
274 corresponding previous 672 consecutive data points as presented in Table 1, and the

275 previous 56 consecutive data points with 24-hour resolution were used to predict the
276 24-hour demand at time t .

277 A sensitivity analysis was conducted to determine the appropriate architecture
278 for the LSTM model, and the number of layers was 2 with the number of nodes being
279 128 and 16 respectively, the learning rate was 0.002, tanh and ReLU were used as the
280 activation functions, the number of epochs was 100 and the batch size was 60 (Guo et
281 al., 2018). The ARIMA parameters were automatically determined after model
282 calibrations. For the SVR models, the range of the C parameters was integer numbers
283 between 1 and 10, and potential γ values were 0.05, 0.06, 0.07, 0.08, 0.09, 0.1, 0.15
284 and 0.20 following the approach outlined in Friedrich and Igel (2005). Finally, $C=1$
285 and $\gamma=0.06$ were selected using the grid search method as this parameter combination
286 exhibited the best model performance (Cherkassky and Ma, 2004). For the RF models,
287 the number of decision trees $q=1000$ and $m_t=4$ based on the method described in Guan
288 et al. (2013). It is noted that the ARIMA models needed to be re-calibrated for each
289 new set of inputs, while RNNs, SVR and RF models only calibrated once using the
290 training data set. The training dataset were records of the first 21 months and data of

291 the last three months were used for model validations.

292 **Results and Discussions**

293 *Performance comparisons of models applied to total water demands*

294 Figure 4 presents the predictions versus the observations for the four models
295 applied to the total water demands (TD) with different time resolutions. All the four
296 models were able to capture the overall trend of the observations, with errors mainly
297 produced at the extreme values of the observations. The detailed comparisons of these
298 four models are given below.

299 Boxplots in Figure 5 show the absolute relative errors of the predictions
300 generated by the four models applied to the total water demands (TD). It is noted that
301 these results were produced using the validation dataset. It is seen that the LSTM
302 based model exhibited moderately better performance than the other three models for
303 data with 15-minute and 1-hour resolutions, while the four models performed overall
304 similarly when dealing data with the 24-hour resolution. The LSTM's better
305 performance relative to its counterparts can also be supported by the statistics of the
306 prediction errors in Table 2. As shown in this table, the *MAPE* value of the LSTM

307 based models for the 15-minute and 1-hour resolution data were 1.40% and 2.56%
308 respectively, which were lower than those provided by other models. For all different
309 time resolutions, the values of NSE and R^2 of the LSTM based models were
310 consistently higher than the other models as shown in Table 2. For the $RMSE$ values,
311 the LSTM based model also showed better performance than the other three models
312 for 15-min and 1-hour time resolutions, but it performed similarly with the ARIMA
313 for the 24-hour resolution as shown in Table 2. It is noted that the extreme values of
314 the absolute relative errors are not presented in Figure 5 for the sake of easy
315 comparisons of the overall results.

316 ***Model comparisons for predicting multiple successive data points***

317 It is practically meaningful to predict multiple successive high time resolution
318 data as these predictions can be used to facilitate the decision-making regarding the
319 operation strategies for water production and pumping. Following the method used in
320 Guo et al. (2018), the prediction at time t was used as the potential inputs to predict
321 water demands at time $t+1$, thereby predicting multiple successive data points (the
322 number is referred as k). For instance, $k=4$ indicated that four successive data points

323 were generated using the model, and the *MAPE*, *NSE*, R^2 and *RMSE* values were
324 computed based on successive data predictions relative to their corresponding
325 observations.

326 In this study, the data with the 15-minute resolution were employed for model
327 developments, aimed to predict $k=4$ (1-hour time period) and 96 (24-hour time period)
328 successive data points, with results given in Figure 6. It is seen that while all models
329 exhibited deteriorated prediction accuracy as the number of k increased, the LSTM
330 based model performed significantly better than the ARIMA, SVR and RF models,
331 with advantages being more noticeable for a larger value of k . For instance, the *MAPE*
332 values of the LSTM based model were 2.21% and 5.23% for $k=4$ and $k=94$
333 respectively as shown in Table 3, which were appreciably lower than the other three
334 models. Similar observations can be made for the *NSE*, R^2 and *RMSE* values as
335 outlined in Table 3.

336 It is observed from Figure 6 and Table 3 that the performance of the ARIMA
337 model deteriorated in a significantly quicker rate compared to the other three models
338 when the value of k increased. This can be also supported by the results shown in

339 Figure 7, where large deviations were observed for the ARIMA predictions relative to
340 the observations, especially for $k=96$. The performance variation between the LSTM
341 based models (also the SVR and RF models) and the ARIMA model in predicting
342 multiple successive data points was caused by the differences of their model
343 structures. More specifically, the inputs of the LSTM based models (also SVR and RF
344 models) were formed by some records in the current day and some data points taken
345 from previous days (see Table 1), while the inputs of the ARIMA model were many
346 successive records before the prediction time. This, consequently, leads to that a
347 larger number of inputs of the ARIMA model would be replaced by the forecasts
348 compared to the LSTM based models, SVR and RF models when predicting multiple
349 successive data points ahead, resulting in larger accumulative errors within the
350 predictions.

351

352 ***Model comparisons for data points with abrupt changes***

353 The data points with abrupt changes are often difficult to predict, and hence they
354 can be used to demonstrate the ability of the prediction models. In this study, a new

355 dataset was extracted from the original observations using the following procedures.
356 Firstly, each data point was compared with its first previous data point and first data
357 point behind in terms of relative errors, followed by the identification of inflection
358 points based on the signs of the relative errors. Secondly, these inflection data points
359 were ranked based on their mean of the absolute relative errors in a descending order,
360 and finally a new dataset was formed by the first 10% of the ranked data points.
361 Within practical applications, these data points were often referred as “abrupt points”,
362 which were of great interest as many models often failed to produce accurate
363 predictions for them. In this study, the dataset with abrupt changes was respectively
364 extracted from the original 15-minute and 1-hour observations to enable the
365 prediction analysis, as shown in Table 4.

366 Interestingly, the LSTM based model exhibited significantly better performance
367 than the other three models when applied to datasets with abrupt changes as shown in
368 Table 4. This was supported by that the *MAPE* values of the LSTM based models
369 were lower than 3% for both datasets with 15-minute and 1-hour time resolutions,
370 while *MAPE* values of the other models were all around 5%. We also compared the

371 *MAPE* values of the four models used to produce multiple successive data points for
372 the dataset with abrupt changes extracted from 15-minute observations, with results
373 given in Table 4. Clearly, the LSTM based models also appreciably outperformed the
374 ARIMA, SVR and RF models, with similar observations when measured using *NSE*,
375 R^2 and *RMSE* metrics. Combining the results (Table 2 and 3) that the four models
376 applied to the full dataset, it can be deduced that the advantage of the LSTM based
377 models relative to the other three models can be more prominent when applying to
378 data with abrupt changes.

379 ***Model comparisons for data with a relatively high uncertainty level***

380 Table 5 shows the validation results measured by four statistic metrics of the four
381 models applied to the DMA demands with different time resolutions. As shown in this
382 table, the overall performances of the four models for this DMA demands were worse
383 than those from the total demands of the water supply system (see Table 2), especially
384 for the 15-min and 1-hour resolutions. This was expected as the DMA demands were
385 quite small relative to the total demands of this supply system and hence its demand
386 uncertainty was higher, resulting in challenges for the prediction models.

387 It is seen from Table 5, the LSTM based models consistently outperformed the
388 ARIMA, SVR and RF models for the dataset from the DMA demands. For instance,
389 for the LSTM applied to this dataset with 15-min resolution, $MAPE=11.77\%$,
390 $NSE=0.924$, $R^2=0.935$, and $RMSE=0.74\text{ m}^3$ were achieved, which were better than
391 those from the other three models. Same observations can be made for the four
392 models applied to DMA demands with 1-hour and 24-hour time resolutions.

393 *Model comparisons when accounting for external parameters*

394 To examine the influence of external parameters on the models' performance, a
395 range of parameters were considered as the covariates to develop the models for the
396 total water demands with the 24-hour resolution. These include daily maximum
397 temperature (T_{\max}), the daily average of the temperature (T_{avg}), and the accumulative
398 daily rainfall (R_c) as these external parameters have been demonstrated to be
399 important influential factors that could affect the prediction accuracy of the models
400 (Bai et al., 2015).

401 Figure 8 presents the results of the four models with external parameters
402 considered as covariates for model calibrations and validations, where NC indicated

403 that no external parameter were used. It was observed that external parameters had
404 limited impacts on the performances of the LSTM based models, but they can slightly
405 enhance the prediction accuracy of the ARIMA, SVR and RF models, especially
406 when the daily maximum temperature (T_{\max}) was used as the covariate. Similar
407 observations can be made based on *MAPE*, *NSE*, R^2 and *RMSE* metric values.

408 **Conclusions**

409 This case study paper proposed the use of the long short-term memory (LSTM)
410 network for short-term urban water demand predictions, motivated by that the LSTM
411 networks have already been demonstrated to be an effective forecast tool in many
412 other research fields. To systematically demonstrate the performance of the LSTM
413 based models, the autoregressive integrated moving average (ARIMA) model that has
414 been widely used so far, as well as the support vector regression (SVR) model and the
415 random forest (RF) model that have shown great potentials for urban demand
416 predictions were also implemented in this study. These four models were applied to
417 urban demand predictions with different time resolutions ranging from 15-minute to
418 24-hour for the Hefei City of China. The main observations based on the case study

419 results obtained are as follows,

420 (i) The LSTM based models exhibited better performance than the ARIMA,
421 SVR and RF models in predicting data with high time resolutions (e.g., 15-minute and
422 1-hour), with merits being more significant when handling data points with abrupt
423 changes and data with a relatively high uncertainty level. When predicting data with
424 relatively low time resolutions (e.g., 24-hour), the four models performed overall
425 similarly in terms of prediction accuracy. These observations are practically
426 meaningful as they can be used to facilitate the selection of the appropriate models for
427 real-world problems based on the data properties. In addition, it was found that the
428 LSTM based model showed the significantly improved performance when predicting
429 multiple successive high time-resolution demands, with advantage being more
430 noticeable for the larger number of successive data points. Such ability is of great
431 importance as it is often very important to predict a series of successive demands with
432 a high time resolution, thereby enabling the optimal decision regarding real-time
433 operation strategies.

434 (ii) External parameters such as temperature and rainfall had limited impacts on

435 the performance of the LSTM based models in predicting data with 24-hour
436 resolution, indicating that the performance of the LSTM based model was dominated
437 by its great ability in capturing the underlying relationships within the data
438 themselves. This is also a great merit of the LSTM based models for practical
439 applications as collecting external parameters in a high time resolution is often
440 time-consuming and costly.

441 The observations mentioned above based on the Hefei Case study provide
442 important additional experiences and evaluations regarding the applications of the
443 LSTM based models for short-term urban demand forecasts. These knowledge go
444 beyond the findings reported in Guo et al (2018) as in their study only data with
445 15-min resolution were considered (no covariates), as well as that the LSTM based
446 models were only compared with ARIMA and ANN models. In addition, this study
447 demonstrated that the LSTM based models can exhibit significantly better
448 performance than other models in predicting data points with abrupt changes as well
449 as data with a high uncertainty level, which have not been considered in Guo et al.
450 (2018).

451 **Data Availability Statement**

452 All data, models, or code generated or used during the study are available from the
453 corresponding author by request (feifeizheng@zju.edu.cn).

454 **Acknowledgments**

455 This work is funded by the National Natural Science Foundation of China (Grant No.
456 51922096), Excellent Youth Natural Science Foundation of Zhejiang Province in
457 China (LR19E080003), Funds for International Cooperation and Exchange of the
458 National Natural Science Foundation of China (No.51761145022), and National
459 Science and Technology Major Project for Water Pollution Control and Treatment
460 (2017ZX07201004).

461 **References**

- 462 Adamowski, J. (2008). Peak Daily Water Demand Forecast Modeling Using Artificial Neural
463 Networks. *Journal of Water Resources Planning and Management*, 134(2), 119-128.
464 doi:10.1061//ASCE/0733-9496/2008/134:2/119.
- 465 Arandia, E., Ba, A., Eck, B., & McKenna, S. (2016). Tailoring Seasonal Time Series Models
466 to Forecast Short-Term Water Demand. *Journal of Water Resources Planning and
467 Management*, 142(3), 04015067. doi:10.1061/(asce)wr.1943-5452.0000591.
- 468 Bai, Y., Li, C., & Xie, J. (2015). Dynamic Forecast of Daily Urban Water Consumption
469 Using a Variable-Structure Support Vector Regression Model. *Journal of Water
470 Resources Planning and Management*, 141(3).
471 doi:0.1061/(ASCE)WR.1943-5452.000045710.1061/(ASCE).

- 472 Bakker, M., Vreeburg, J. H. G., van Schagen, K. M., & Rietveld, L. C. (2013). A fully
473 adaptive forecasting model for short-term drinking water demand. *Environmental*
474 *Modelling Software*, 48(5), 141-151.
- 475 Bhanja, S. N. , Mukherjee, A. , Saha, D. , Velicogna, I. , & Famiglietti, J. S. . (2016).
476 Validation of grace based groundwater storage anomaly using in-situ groundwater
477 level measurements in india. *Journal of Hydrology*, 543, 729-738.
- 478 Billings, R. B., & Jones, C. V. (2008). *Forecasting Urban Water Demand* (2nd ed.). Denver,
479 CO: American Water Works Association.
- 480 Bougadis, J., Adamowski, K., & Diduch, R. (2005). Short-term municipal water demand
481 forecasting. *Hydrological Processes*, 19(1), 137-148. doi:10.1002/hyp.5763.
- 482 Breiman, L. (2001). Random forests. *Machine Learning*, 45, 5-23.
- 483 Chang, C. C., & Lin, C. J. (2001). *Libsvm: a library for support vector machines*.
- 484 Chen, G., & Boccelli, D. L. (2018). Forecasting Hourly Water Demands With Seasonal
485 Autoregressive Models for Real-Time Application. *Water Resources Research*, 54(2),
486 879-894.
- 487 Chen, G., Long, T., Xiong, J., & Bai, Y. (2017). Multiple Random Forests Modelling for
488 Urban Water Consumption Forecasting. *Water Resources Management*, 31(15),
489 4715-4729.
- 490 Cherkassky, V., & Ma, Y. (2004). Practical selection of SVM parameters and noise
491 estimation for SVM regression. *Neural Networks*, 17(1), 113-126.
- 492 Chollet, F. (2015). Keras. Retrieved from <https://github.com/fchollet/keras>.
- 493 Creaco, E., Pezzinga, G., and Savic, D. (2017). "On the choice of the demand and hydraulic modeling
494 approach to WDN real-time simulation." *Water Resources Research*, 53(7), 6159-6177.
- 495 Donkor, E. A., Mazzuchi, T. A., Soyer, R., & Roberson, J. A. (2014). Urban Water Demand
496 Forecasting- Review of Methods and Models. *Journal of Water Resources Planning*
497 *and Management*, 140(2), 146-156. doi:0.1061/(ASCE)WR.1943-5452.
- 498 Gers, F. A. (2001). *Long Short-Term Memory in Recurrent Neural Networks*. (Doctor),

499 University of Hannover.

500 Gers, F. A., Schmidhuber, J., & Cummins, F. (2000). Learning to forget: continual prediction
501 with LSTM. *Neural Computation*, *12*, 2451-2471.

502 Ghalehkhondabi, I., Ardjmand, E., Young, W. A., 2nd, & Weckman, G. R. (2017). Water
503 demand forecasting: review of soft computing methods. *Environ Monit Assess*, *189*(7),
504 313. doi:10.1007/s10661-017-6030-3.

505 Ghiassi, M., Zimbra, D. K., & Saidane, H. (2008). Urban Water Demand Forecasting with a
506 Dynamic Artificial Neural Network Model. *Journal of Water Resources Planning and
507 Management*, *134*(2), 138-146. doi:10.1061/(asce)0733-9496(2008)134:2(138).

508 Guan, H., Li, J., Chapman, M., Deng, F., Ji, Z., & Yang, X. (2013). Integration of
509 orthoimagery and lidar data for object-based urban thematic mapping using random
510 forests. *International Journal of Remote Sensing*, *34*(14), 5166-5186.

511 Guo, G., Liu, S., Wu, Y., Li, J., Zhou, R., & Zhu, X. (2018). Short-Term Water Demand
512 Forecast Based on Deep Learning Method. *Journal of Water Resources Planning and
513 Management*, *144*(12), 04018076. doi:10.1061/(asce)wr.1943-5452.0000992.

514 Hao, Y., Wu, J., Sun, Q., Zhu, Y., Liu, Y., Li, Z., & Yeh, T. J. (2013). Simulating effect of
515 anthropogenic activities and climate variation on Liulin Springs discharge depletion
516 by using the ARIMAX model. *Hydrological Processes*, *27*, 2605-2613.

517 Howe, C. W., & Linaweaver, F. P. (1967). The Impact Price on Residential Water Demand
518 and Its Relation to System Design and Price Structure. *Water Resources Research*,
519 *3*(1), 13-32.

520 Hyndman, R. J., & Khandakar, Y. (2008). Automatic Time Series Forecasting: The forecast
521 Package for R. *Journal of Statistical Software*, *26*(3).

522 Jain, A., Varshney, A., & Joshi, U. (2001). Short-term water demand forecast modelling at
523 IIT Kanpur using artificial neural networks. *Water Resources Management*, *15*(5),
524 299-321.

525 Kwiatkowski, D., Philips, P. C. B., Schmidt, P., & Shin, Y. (1992). Testing the null
526 hypothesis of stationarity against the alternative of a unit root. *Journal of*

- 527 *Econometrics*, 54, 159-178.
- 528 Levin, E., Maddaus, W., Sandkulla, N., & Pohl, H. (2006). Forecasting wholesale demand
529 and conservation savings. *Journal of American Water Works Association*, 98(2),
530 102-111.
- 531 Mikolov, T., Karafiat, M., Burget, L., Cernocký, J., & Khudanpur, S. (2010). *Recurrent*
532 *neural network based language model*. In: Proceedings of the 11th Annual
533 Conference of the International Speech Communication Association, Makuhari,
534 Chiba, Japan, pp. 1045–1048.
- 535 Pacchin, E., Gagliardi, F., Alvisi, S., & Franchini, M. (2019). A Comparison of Short-Term
536 Water Demand Forecasting Models. *Water Resources Management*, 33(4), 1481-1497.
537 doi:10.1007/s11269-019-02213-y
- 538 Prosdocimi, I., Kjeldsen, T. R., & Svensson, C. (2013). Non-stationarity in annual and
539 seasonal series of peak flow and precipitation in the UK. *Natural Hazards and Earth*
540 *System Sciences*, 1(5), 5499-5544.
- 541 Qi, Z., Zheng, F., Guo, D., Zhang, T., Shao, Y., Yu, T. Maier, H. R. (2018). A comprehensive
542 framework to evaluate hydraulic and water quality impacts of pipe breaks on water
543 distribution systems. *Water Resources Research*, 54(10), 8174-8195.
- 544 Rasouli, K., Hsieh, W. W., & Cannon, A. J. (2011). Daily streamflow forecasting by machine
545 learning methods with weatherand climate inputs. *Journal of Hydrology*, 414-415,
546 284-293.
- 547 Romano, M., & Kapelan, Z. (2014). Adaptive water demand forecasting for near real-time
548 management of smart water distribution systems. *Environmental Modelling Software*,
549 60(7), 265-276.
- 550 Sardinha-Lourenço, A., Andrade-Campos, A., Antunes, A., & Oliveira, M. S. (2018).
551 Increased performance in the short-term water demand forecasting through the use of
552 a parallel adaptive weighting strategy. *Journal of Hydrology*, 558, 392-404.
553 doi:10.1016/j.jhydrol.2018.01.047
- 554 Sundermeyer, M., Schluter, R., & Ney, H. (2012). *LSTM neural networks for language*

- 555 *modeling*. In: Proceedings of the 12th Annual Conference of the International Speech
556 Communication Association, Portland, Oregon, USA, pp. 601–608.
- 557 Sutskever, I., Vinyals, O., & Le, Q. V. (2014). *Sequence to sequence learning with neural*
558 *networks*. In: Proceedings of the 28th Conference on Neural Information Processing
559 Systems, Montreal, Canada, pp. 3104–3112. [\[SEP\]](#)
- 560 Vapnik, V. (1995). *The nature of statistical learning theory*. New York: Springer.
- 561 Villarin, M. C., & Rodriguez-Galiano, V. F. (2019). Machine Learning for Modeling Water
562 Demand. *Journal of Water Resources Planning and Management*, 145(5).
563 doi:0.1061/(ASCE)WR.1943-5452.0001067
- 564 Were, K., Bui, D. T., Dick, O. B., & Singh, B. R. (2015). A comparative assessment of
565 support vector regression, artificial neural networks, and random forests for predicting
566 and mapping soil organic carbon stocks across an Afromontane landscape. *Ecological*
567 *Indicators*, 52, 394-403.
- 568 Williams, B. M. (2001). Multivariate vehicular traffic flow prediction: evaluation of
569 ARIMAX modeling. *Transportation Research Record Journal*, 1776(1), 194-200.
- 570 Wong, J. S., Zhang, Q., & Chen, G. (2010). Statistical modeling of daily urban water
571 consumption in Hong Kong- Trend, changing patterns, and forecast. *Water Resources*
572 *Research*, 46. doi:0.1029/2009WR008147
- 573 Zhang, D., Lindholm, G., & Ratnaweera, H (2018). Use long short-term memory to enhance
574 Internet of Things for combined sewer overflow monitoring. *Journal of Hydrology*,
575 556, 409-418.
- 576 Zhang, J., Zhu, Y., Zhang, X., Ye, M., & Yang, J. (2018). Developing a Long Short-Term
577 Memory (LSTM) based model for predicting water table depth in agricultural areas.
578 *Journal of Hydrology*, 561, 918-929.
- 579 Zheng, F., Zecchin, A., Maier, H., and Simpson, A. (2016). "Comparison of the Searching
580 Behavior of NSGA-II, SAMODE, and Borg MOEAs Applied to Water Distribution
581 System Design Problems." *Journal of Water Resources Planning and Management*,
582 142(7), 04016017.

583 Zheng, F., Zecchin, A., Newman, J., Maier, H., and Dandy, G. (2017). "An Adaptive
584 Convergence-Trajectory Controlled Ant Colony Optimization Algorithm with
585 Application to Water Distribution System Design Problems." *IEEE Transactions on*
586 *Evolutionary Computation*, 21(5), 773-791.

587 Zhou, S. L., McMahon, T. A., Walton, A., & Lewis, J. (2002). Forecasting operational
588 demand for an urban water supply zone. *Journal of Hydrology*, 259, 189-202.

589

Table 1 Inputs of the four models

Mode types	Time resolutions	Inputs and outputs
LSTM	$t=15$ -minute	$Q_t^0 = f(Q_{t-3}^0, Q_{t-2}^0, Q_{t-1}^0, Q_{t-2}^1, Q_{t-1}^1, Q_t^1, Q_{t+1}^1, Q_{t+2}^1, Q_{t-2}^2, Q_{t-1}^2, Q_t^2, Q_{t+1}^2, Q_{t+2}^2)$
	$t=1$ -hour	$Q_t^0 = f(Q_{t-3}^0, Q_{t-2}^0, Q_{t-1}^0, Q_{t-1}^1, Q_t^1, Q_{t+1}^1, Q_{t-1}^2, Q_t^2, Q_{t+1}^2)$
	$t=24$ -hour	$Q_t^0 = f(Q_t^1, Q_t^2, Q_t^3)$
ARIMA	$t=15$ -minute	$Q_t = f(Q_{t-1}, Q_{t-2}, \dots, Q_{t-67}, Q_{t-67})$
	$t=1$ -hour	$Q_t = f(Q_{t-1}, Q_{t-2}, \dots, Q_{t-67}, Q_{t-67})$
	$t=24$ -hour	$Q_t = f(Q_{t-1}, Q_{t-2}, \dots, Q_{t-55}, Q_{t-56})$
SVR	$t=15$ -minute	$Q_t^0 = f(Q_{t-3}^0, Q_{t-2}^0, Q_{t-1}^0, Q_{t-2}^1, Q_{t-1}^1, Q_t^1, Q_{t+1}^1, Q_{t+2}^1, Q_{t-2}^2, Q_{t-1}^2, Q_t^2, Q_{t+1}^2, Q_{t+2}^2)$
	$t=1$ -hour	$Q_t^0 = f(Q_{t-5}^0, Q_{t-4}^0, Q_{t-3}^0, Q_{t-2}^0, Q_{t-1}^0, Q_t^1, Q_t^2)$
	$t=24$ -hour	$Q_t^0 = f(Q_t^1, Q_t^2, Q_t^3, Q_t^4, Q_t^5)$
RF	$t=15$ -minute	$Q_t^0 = f(Q_{t-5}^0, Q_{t-4}^0, Q_{t-3}^0, Q_{t-2}^0, Q_{t-1}^0, Q_t^1, Q_t^2)$
	$t=1$ -hour	$Q_t^0 = f(Q_{t-5}^0, Q_{t-4}^0, Q_{t-3}^0, Q_{t-2}^0, Q_{t-1}^0, Q_t^1, Q_t^2)$
	$t=24$ -hour	$Q_t^0 = f(Q_t^1, Q_t^2, Q_t^3)$

Table 2 Statistics of the model prediction errors for the total water demands

Time resolutions	Models	<i>MAPE</i>	<i>NSE</i>	<i>R</i> ²	<i>RMSE</i> (m ³)
15-minute	<i>LSTM</i>	1.40%	0.991	0.991	315
	ARIMA	2.14%	0.974	0.975	551
	SVR	2.01%	0.985	0.986	421
	RF	2.03%	0.984	0.984	425
1-Hour	<i>LSTM</i>	2.56%	0.978	0.981	1976
	ARIMA	4.26%	0.937	0.937	3367
	SVR	3.40%	0.963	0.966	2587
	RF	3.70%	0.945	0.945	3153
24-Hour	<i>LSTM</i>	2.89%	0.820	0.822	55,605
	ARIMA	2.94%	0.811	0.821	55,463
	SVR	3.82%	0.680	0.769	74,181
	RF	3.08%	0.816	0.821	56,179

596

Table 3 Statistics of prediction errors for models used for multiple successive

597

data forecasts

No. of successive predictions (k)	Models	<i>MAPE</i>	<i>NSE</i>	R^2	<i>RMSE</i> (m ³)
$k=4$	LSTM	2.21%	0.980	0.981	475
	ARIMA	3.19%	0.954	0.954	728
	SVR	3.05%	0.970	0.973	591
	RF	3.11%	0.959	0.959	685
$k=96$	LSTM	5.23%	0.899	0.909	1075
	ARIMA	16.28%	0.206	0.348	3018
	SVR	7.41%	0.832	0.836	1390
	RF	8.19%	0.751	0.754	1692

598

599

Table 4 Statistics of model prediction errors for data with abrupt changes

Time resolutions	Models	<i>MAPE</i>	<i>NSE</i>	R^2	<i>RMSE</i> (m ³)
15-minute	LSTM	2.96%	0.961	0.962	596
	ARIMA	5.58%	0.897	0.909	967
	SVR	4.56%	0.939	0.940	744
	RF	5.49%	0.916	0.916	873
1-Hour	LSTM	2.89%	0.979	0.982	2111
	ARIMA	5.75%	0.913	0.983	4307
	SVR	4.94%	0.956	0.974	3057
	RF	6.95%	0.884	0.973	4973
<i>k</i> =4*	LSTM	3.56%	0.962	0.963	588
	ARIMA	5.33%	0.929	0.936	803
	SVR	4.69%	0.933	0.938	780
	RF	4.76%	0.920	0.923	853
<i>k</i> =96*	LSTM	7.19%	0.821	0.862	1274
	ARIMA	15.69%	0.315	0.368	2492
	SVR	9.57%	0.688	0.731	1681
	RF	9.36%	0.678	0.732	1708

601 **k*=4 and 96 represents 4 and 96 successive predictions with 15-min resolution.

602

603

Table 5 Statistics of prediction errors for models used for data with a relatively

604

uncertainty level

Time resolutions	Models	<i>MAPE</i>	<i>NSE</i>	<i>R</i> ²	<i>RMSE</i> (m ³)
15-minute	LSTM	11.77%	0.924	0.935	0.74
	ARIMA	19.94%	0.843	0.843	0.94
	SVR	17.78%	0.856	0.861	0.90
	RF	18.95%	0.856	0.856	0.90
1-hour	LSTM	10.29%	0.942	0.942	2.18
	ARIMA	19.14 %	0.860	0.859	3.39
	SVR	14.59 %	0.898	0.905	2.92
	RF	13.90%	0.899	0.900	2.86
24-hour	LSTM	1.36%	0.878	0.895	11.23
	ARIMA	1.86%	0.811	0.852	13.99
	SVR	7.66%	-1.704	0.280	52.92
	RF	2.64%	0.425	0.642	24.39

605

606



607
608
609
610

Figure 1: The structure of a long-short term memory (LSTM) network, where the dotted lines represent the recurrent procedure

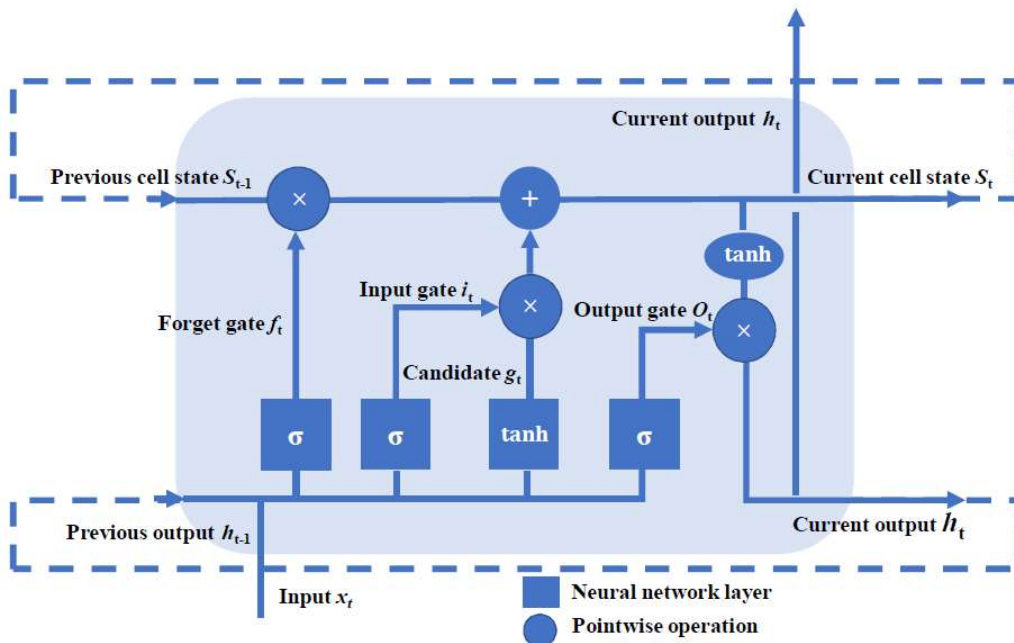

611
612
613
614

Figure 2: Water treatment plants (WTPs) distributed in the city of Hefei, China, with green lines representing the water distribution pipelines.

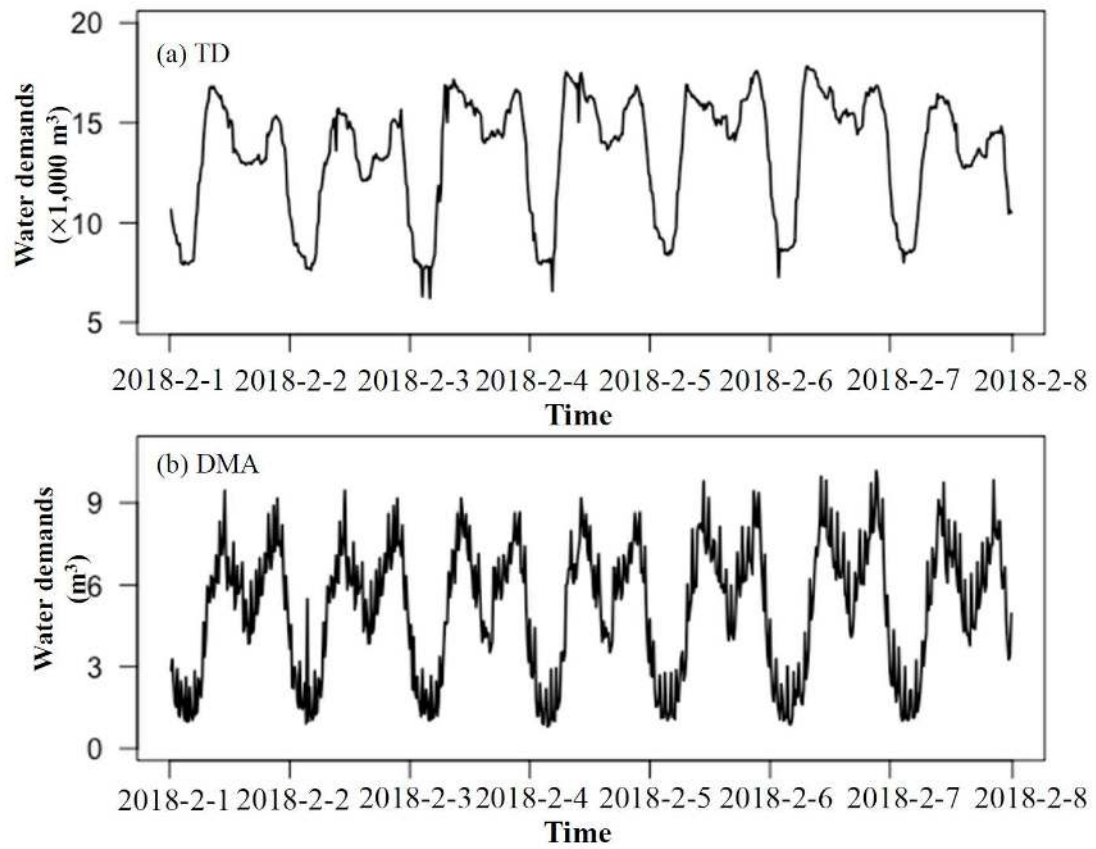

615

616

617

618

619

Figure 3: Records of total water demands (TD) and from a DMA with 15-min resolution

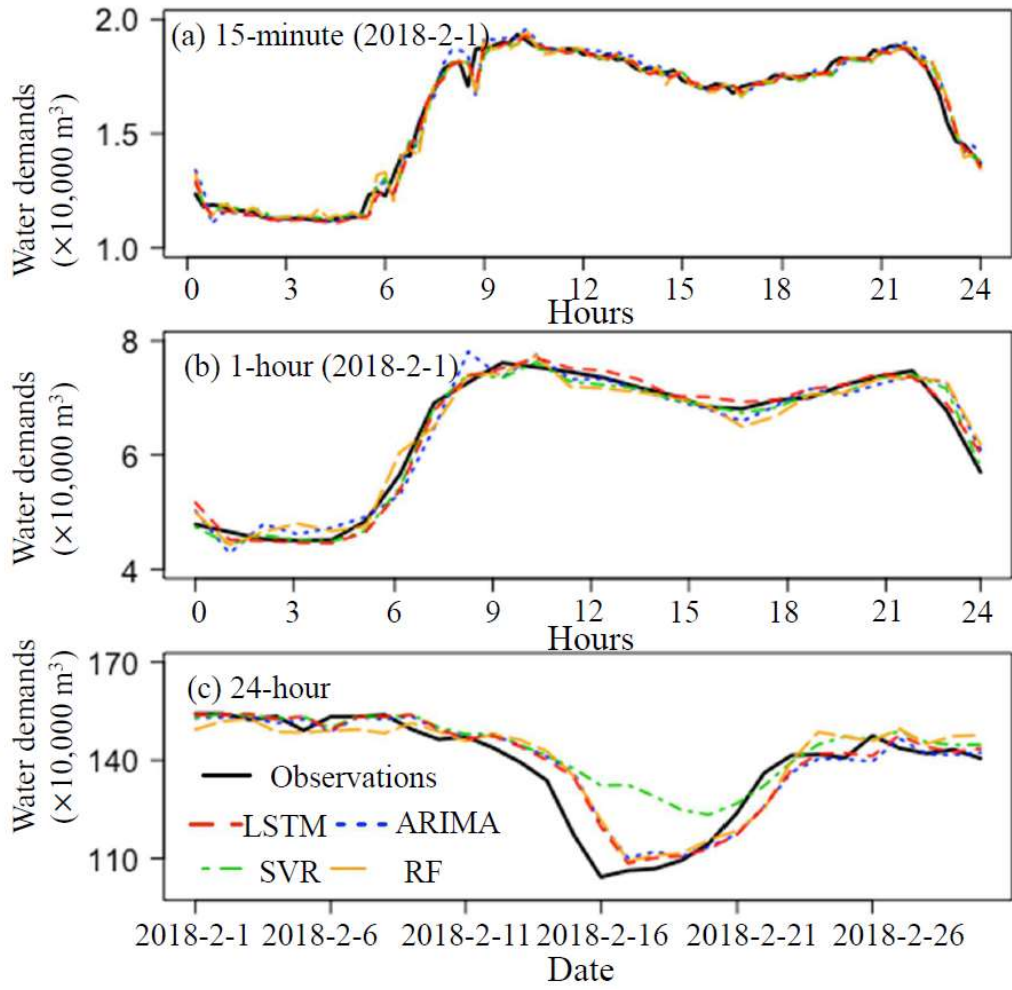

620
 621
 622
 623
 624
 625

Figure 4: Predictions versus observations for the four models applied to the total water demands (TD)

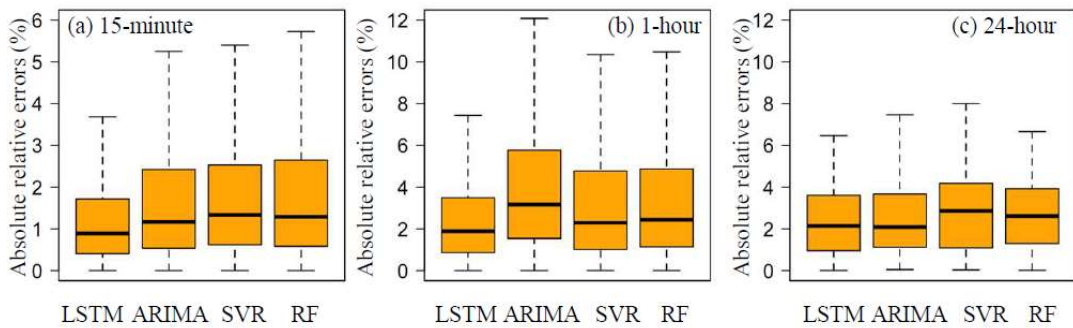

626
 627
 628
 629

Figure 5: Absolute relative errors of the model predictions for the total water demands

630

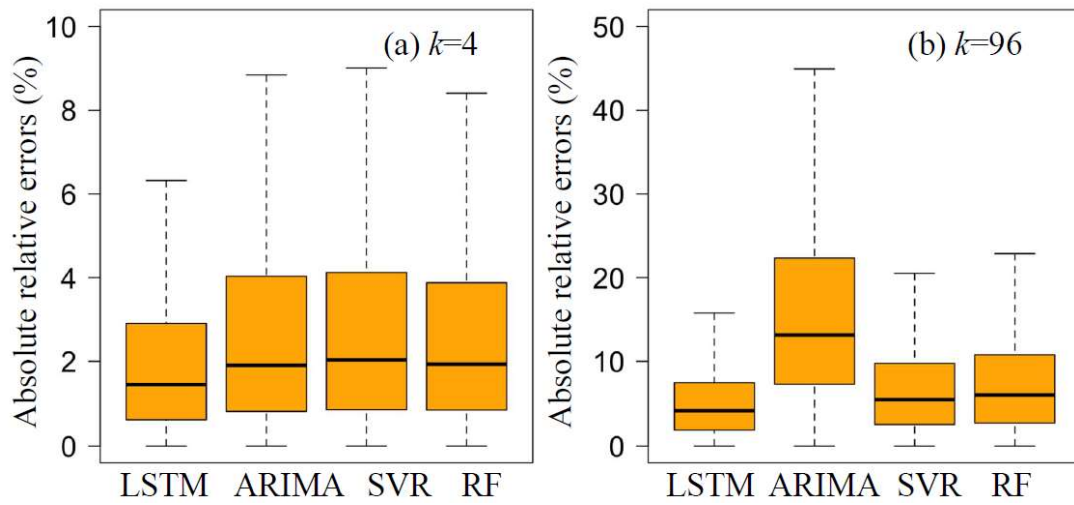

631

632 **Figure 6: Absolute relative errors for models used to predict multiple successive**
633 **data points, where k is the number of multiple successive data points**

634

635

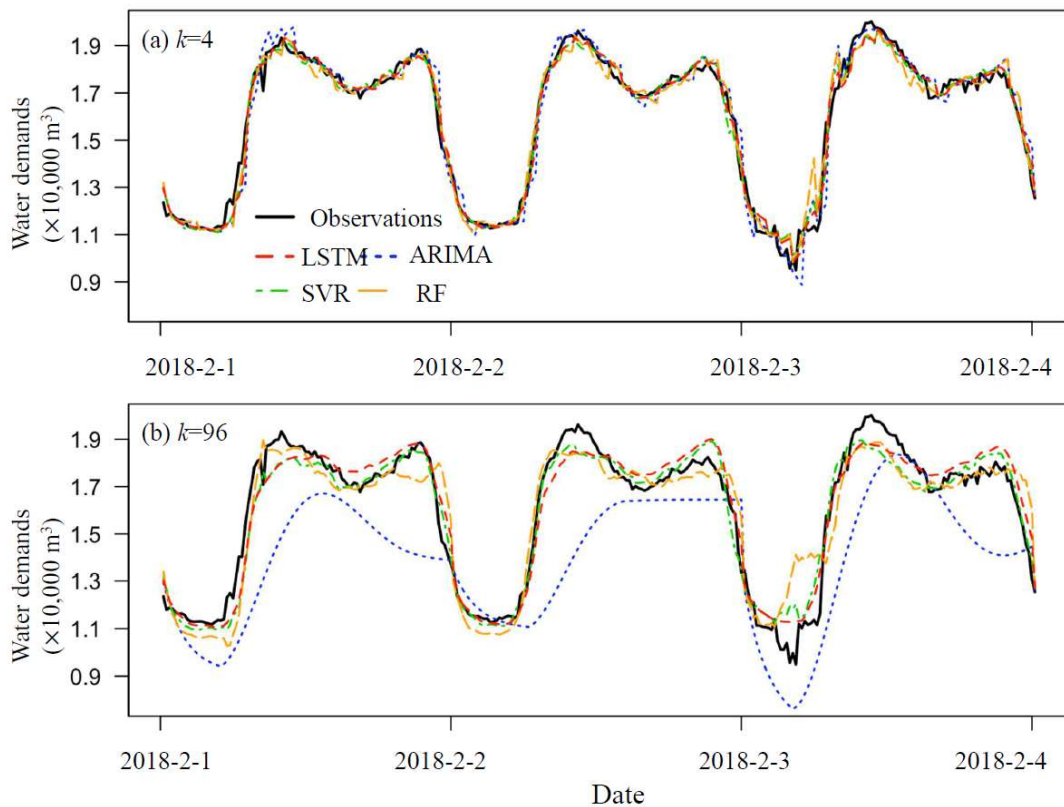

636

637 **Figure 7: Predictions versus observations for the four models used to generate**
638 **multiple successive data points**

639

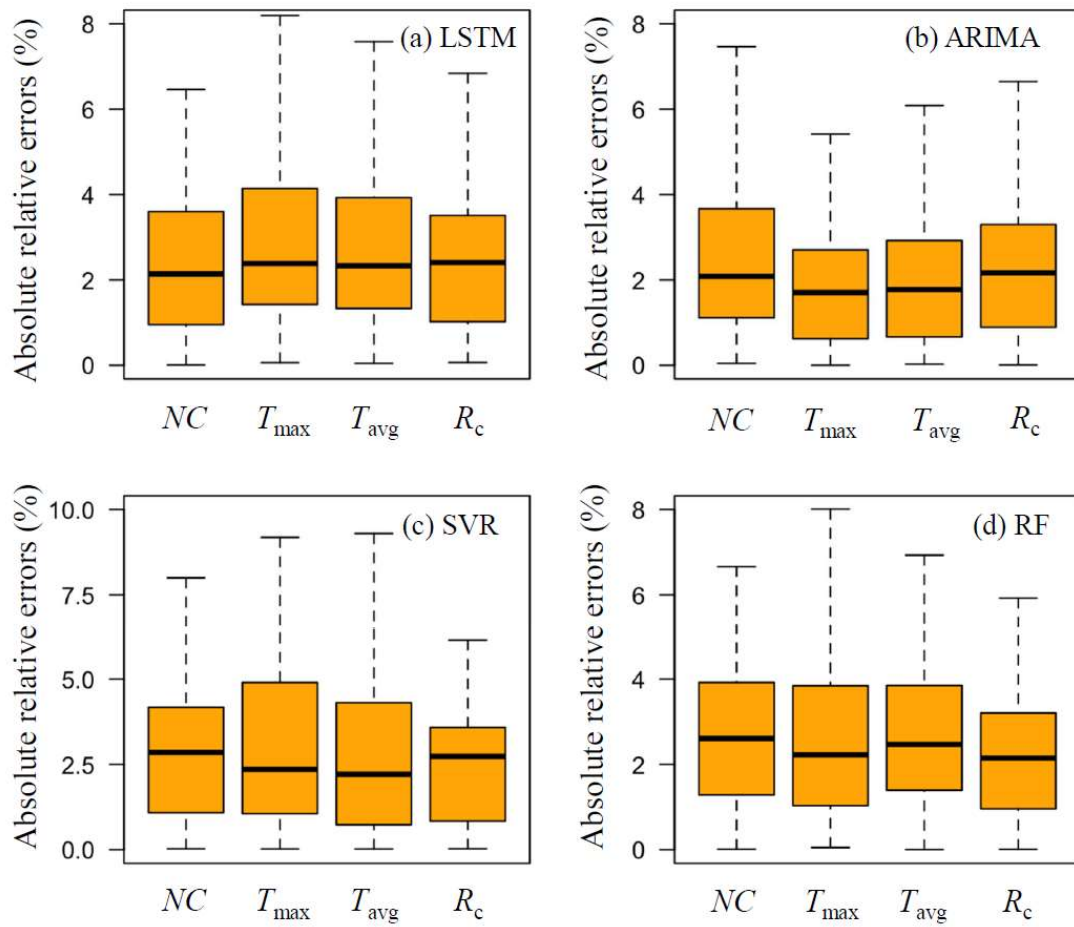

641

642

643

Figure 8: Absolute relative errors of the four models with different external parameters applied to the total water demands with the 24-hour resolution