

# Masters Program in **Geospatial Technologies**



***HUMAN AND CLIMATIC CHANGE IMPACT MODELLING ON  
THE HABITAT SUITABILITY FOR THE CHIMPANZEE (*Pan  
troglodytes ellioti*)***

***Case study: The proposed Mount Cameroon National Park***

Francis Molua Mwambo

Dissertation submitted in partial fulfilment of the requirements  
for the Degree of *Master of Science in Geospatial Technologies*

**HUMAN AND CLIMATIC CHANGE IMPACT MODELLING ON  
THE HABITAT SUITABILITY FOR THE CHIMPANZEE  
(*Pan troglodytes ellioti*)**

**Case study: The proposed Mount Cameroon National Park**

Dissertation supervised by  
Professor Pedro Cabral, Ph.D

Dissertation co-supervised by  
Professor Mario Caetano, Ph.D  
Professor Jorge Mateu, Ph.D  
Professor Edzer Pebesma, Ph.D

March 2010

## **DEDICATION**

This thesis has been dedicated back to God Almighty.  
The provider of the wisdom, knowledge, understanding and all it took to realise this  
publication.

**(Psalm 127:1)**

## **ACKNOWLEDGEMENTS**

I express my profound gratitude to the following personalities and institutions for their invaluable contributions without which it would have been impossible to pursue the course. These include:

The European Commission; for funding through the Erasmus Mundus Programme, M.Sc. in Geospatial Technologies, Project No. 2007 – 0064.

I remain in debt to my supervisors: Professors Pedro Cabral, Jorge Mateu, Mario Caetano and Edzer Pebesma. I express my heartfelt gratitude to: Profs Marco Painho, Werner Kuhn, Drs. Christoph Brox, Filomena Caria, Maria do Carmo Teixeira, Gisela Gracia and Oliver Fernandes for their great assistance on administrative issues

I am grateful for the support I received from Mr. Lawrence Nsoyuni and Mr. Eno Nku Manasseh who provided the data I used in this study. I remain in great debt to the Limbe Botanic Garden - Cameroon and WWF Coastal Forest Programme Office in Limbe – Cameroon; for the copyright of the land cover and species presence datasets respectively.

I appreciate the immense motivation and support I benefited from my family during the programme. I express my weighty gratitude most especially to the following persons: Anastasia Nalova Mwambo, Doris Bate Mwambo, Doris Eposi Mwambo, Sally Monjoa Mwambo, Peter Engange Mwambo, Emmanuel Njoh Mwambo, Tony-Pierre Engange Mwambo, Emmanuel Molua Mwambo and many others.

I am thankful for the companionship from friends, colleagues and coursemates I met during the programme. My regards to all who assisted me in one way or another but whose names have escaped my mind at moment.

**Above all, I acknowledge God Almighty for all He has done.**

**(Proverbs 3:6)**

# **HUMAN AND CLIMATIC CHANGE IMPACT MODELLING ON THE HABITAT SUITABILITY FOR THE CHIMPANZEE (*Pan troglodytes ellioti*)**

**Case study: The proposed Mount Cameroon National Park**

## **ABSTRACT**

The prediction of species' distribution is fundamental to many applications in ecology, wildlife conservation and the science of evolution. Variations in the abundance within a species' geographic range provide the connection between the disciplines of ecology, geostatistics and biogeography. Species predictive modelling is quite intricate considering the spatial and aspatial variables that both play interactive roles in predicting a species' occurrence. Like many primates across Africa, *Pan troglodytes ellioti* has both the least geographic distribution and population relative to the other chimpanzee subspecies continent wide. With the proposed Mount Cameroon National Park as the study area, predictions displayed as maps further enhance spatial visualisation. Predictions in Maxent had an estimated accuracy assessment of approximately 0.7 and 67.41% being currently suitable respectively. The observed shift in the habitat suitability from lower to higher altitudes suggests climatic conditions prevailing in the suitable range will likely be attainable only at much higher altitudes in the future. A likely consequence on species shall be to ascend towards the summit in order to meet their needs both physiologically and resource wise.

## KEYWORDS

Chimpanzee subspecies (*Pan troglodytes ellioti*)

Climate change

Endangered primate species

Habitat suitability

Human impact

Maximum entropy species distribution (maxent) model

Mount Cameroon National Park

Spatial modelling

## ACRONYMS

- AUC** - Area Under the Curve
- CCCMA** - Canadian Centre for Climate Modelling and Analysis
- CERI** - Craighead Environmental Research Institute
- CITES** - Convention on International Trade in Endangered Species
- CO<sub>2</sub>** - Carbon dioxide
- DEM** - Digital Elevation Model
- ETM+** - Enhanced Thematic Mapper
- GHGs** - Green House Gases
- GIS** - Geographic Information Systems
- GLCF** - Global Land Cover Facility
- GPS** - Global Positioning Systems
- H<sub>a</sub>** – Alternative hypothesis
- H<sub>o</sub>** – Null hypothesis
- IPCC** -Intergovernmental Panel on Climate Change
- IUCN** - International Union for the Conservation of Nature
- LBG** - Limbe Botanic Garden; Cameroon
- Maxent** - Maximum Entropy Distribution Model
- Maxent-T** - Maximum Entropy Distribution Model-Threshold
- MCNP** - Mount Cameroon National Park
- MINEF** - Ministry of Environment and Forestry; Cameroon
- Mt. Cameroon** - Mount Cameroon
- Mt. Etinde** - Mount Etinde
- Mt. Fako** - Mount Fako
- ROC** - Receiver Operating Characteristic
- RS** - Remote Sensing
- WWF** - World Wildlife Fund for Nature

# TABLE OF CONTENTS

ACKNOWLEDGEMENTS.....	iv
ABSTRACT.....	v
KEYWORDS.....	vi
ACRONYMS.....	vii
INDEX OF TABLES.....	x
INDEX OF FIGURES.....	xi
1. INTRODUCTION.....	1
1.1 Problem statement.....	1
1.2 Aim and objective of the study.....	5
1.3 Research questions and hypothesis.....	6
1.4 Structure of the thesis.....	7
2. BIOGEOGRAPHY OF THE AFRICAN CHIMPANZEE.....	9
2.1 Basic terminologies.....	9
2.2 Spatial distribution of chimpanzees in Africa.....	10
2.3 The study area: the proposed Mount Cameroon National Park.....	13
2.4 Endemism of the Mount Fako area.....	15
2.5 The taxonomy of the chimpanzees on Mount Fako.....	17
3. MATERIALS and METHODS.....	19
3.1 Materials.....	19
3.1.1 Data on species occurrence.....	19
3.1.2 Data on local human activities.....	20
3.1.3 Environmental data.....	20
3.1.4 The land cover /use of the study area.....	21
3.2 Methods.....	23
3.2.1 Models for species distribution.....	23
3.2.2 The maximum entropy distribution model (MaxEnt).....	25
3.2.3 Modelling for the habitat suitability.....	26



4. RESULTS and DISSCUSSION.....	29
4.1 Variable importance.....	29
4.2 Predicted habitat suitability based on current climate (1950-2000).....	33
4.3 Predicted habitat suitability based on future climate (2001-2050).....	35
4.3.1 Based on b2a modelled scenario.....	35
4.3.2 Based on a2a modelled scenario.....	36
4.4 Accuracy assessment of predicted result.....	46
4.5 Modelled human activities.....	46
5. CONCLUSIONS .....	49
5.1 Conclusions.....	49
5.2 Limitations.....	51
5.3 Recommendations.....	51
BIBLIOGRAPHIC REFERENCES .....	53
APPENDICES .....	66
1 Response curves.....	67
2 Tables.....	67

## **INDEX OF TABLES**

Table 1: Taxonomic ranking of the chimpanzee subspecies in the study area .....	18
Table 2: Environmental layers used in the model.....	19
Table 3: signs depicting local human activities .....	20
Table 4: Software used in the study.....	28
Table 5: selected key variables for the model.....	29
Table 6: Land cover classes with high habitat suitability .....	32
Table 7: Variables and their percentage contribution .....	33
Table 8: Variables and their percentage contribution .....	35
Table 9: Variables and their percentage contribution .....	36
Table 10: The summary statistics for the different scenarios .....	37
Table 11: Accuracy assessment of predicted results .....	46

## INDEX OF FIGURES

Figure 1: Classification for biodiversity conservation status by the IUCN (IUCN 2001)	2
Figure 2: Structure of the thesis	8
Figure 3: The spatial distribution of chimpanzees in Africa over time.	12
Figure 4: The biogeographic habitats of chimpanzees in Africa	12
Figure 5: The study area; the proposed MCNP located on Mt. Fako	14
Figure 6: The endemism of the Mount Cameroon region in Africa.	16
Figure 7: The land cover/use map of the proposed MCNP	22
Figure 8: The flowchart of the methodology	28
Figure 9: Response curve for altitude	30
Figure 10: Response curve for slope	31
Figure 11: Response curve for the land cover type	31
Figure 12: Jackknife of regularised training gain using all variables	32
Figure 13: Jackknife of the regularised training gain under the current scenario	33
Figure 14: The habitat suitability based on the current climate scenario	34
Figure 15: Jackknife of the regularised training gain under the b2a climate scenario	35
Figure 16: Jackknife of the regularised training gain under the a2a climate scenario	36
Figure 17: The habitat suitability based on the b2a climate scenario	38
Figure 18: The habitat suitability based on the a2a climate scenario	39
Figure 19: Predicted changes in suitability from current to b2a scenario	41
Figure 20: Predicted changes in suitability from current to a2a scenario	42
Figure 21: Overlay of points on predicted suitability under the current scenario	43
Figure 22: An illustration of shift in predicted suitability under the b2a scenario	44
Figure 23: An illustration of shift in predicted suitability under the a2a scenario	45
Figure 24: Local human activities modelled as points on the land cover	47
Figure 25: Local human activities modelled as points on the current suitability	48

# 1. INTRODUCTION

## 1.1 Problem statement

Empirical evidence from available sources suggest that many African primate species are increasingly being threatened by anthropogenic actions which basically include deforestation, the hunt for fauna species as meat (commonly referred to as *bush meat*), diseases among species, habitat destruction and climate change (Chapman 2006). What used to be the nature and magnitude of threats to wildlife decades ago are likely not the same today. Even where threats seem to have remained unchanged, external anthropogenic factors from diverse sources and forms have in many cases accelerated and aggravated the threats to biodiversity and nature as a whole. It is currently estimated that not more than 5,000-10,000 Cameroon - Nigeria trans-boundary chimpanzee individuals remain in the wild and these are separated into increasingly fragmented sub-populations throughout much of their former range (Pilbrow *et al.*, 2006). The population of the robust chimpanzee (*Pan troglodytes*) including other species of apes in the wild is on a rapid decline across tropical Africa; caused by diseases and human activities that adversely impact the habitats occupied by these species (Huijbregts *et al.*, 2003, Leroy *et al.*, 2004, Walsh *et al.*, 2003, Morgan *et al.*, 2006). Even though the Cameroon - Nigeria trans-boarder chimpanzees have been noted to be peculiar and unique, the subspecies' population is decreasing. *Pan troglodytes ellioti* is presently red listed as an endangered species by the International Union for the Conservation of Nature; IUCN, (Oates *et al.*, 2008, IUCN 2009, Walsh *et al.*, 2003). Figure 1 shows the classification scheme used by the IUCN for assessing the conservation status of biological species around the world. The situation is even aggravated by the fact that this subspecies has not yet been fully studied compared to the other chimpanzee subspecies across Africa (Pilbrow *et al.*, 2006). Species that are rare either in terms of their distribution or population densities are generally more vulnerable to extinction risks compared to species that are not rare (Gaston, 1994). Even though studies on species population in Africa could be intricate and controversial (Oates 2006) the problem of population declined becomes knotty due to the fact that there are no precise baseline ape

density estimates for most Central African forests (Butynski 2001, Oates 1996, Teleki 1989). And even where such estimates exist, there are criticism on the survey methods as being biased or limited in their ability to detect trends and the lack of casual interference (Oates 2006, Plumptre 2000). The salient veracity is that *Pan troglodytes ellioti* has both the least geographic distribution and population size relative to the other chimpanzee subspecies across the Continent (Oates *et al.*, 2007 in IUCN 2008, Oates *et al.*, 2008 in IUCN 2009). Population estimate for the subspecies figures about 6,500 individuals in the wild. The situation is even worsened by the declining population (Oates *et al.*, 2008, IUCN 2009) which is under growing pressure from human activities.

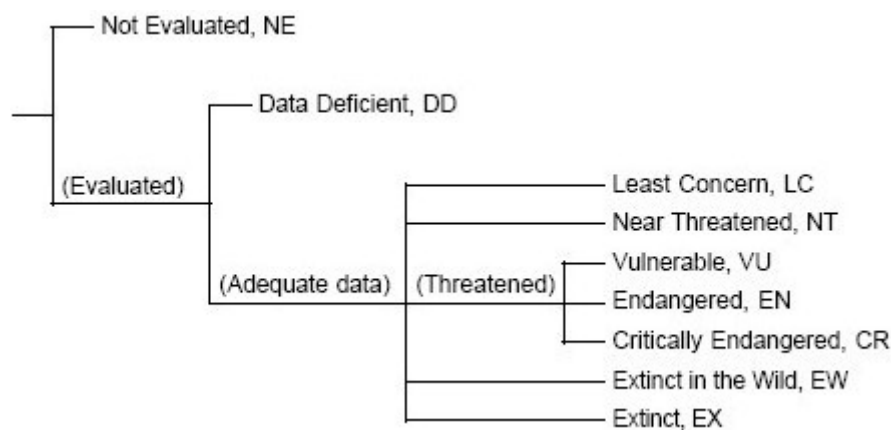

Figure 1: Classification for biodiversity conservation status by the IUCN (IUCN 2001)

Local anthropogenic disturbances are diverse and take various forms: hunting –for meat; forest clearing -for agriculture leading to habitat fragmentation and destruction; logging -for commercial timber; poaching, illegal commercial trade and smuggle of the species in to zoos and laboratories -even though the convention on international trade in endangered species (CITES) has banned the trade on *Pan troglodytes ellioti* and other related species. The collection of wild honey (a supplement for the species’ diet) by locals also adds to the several odds faced by the species in the wild. Occasional wild bush fires also contribute to the threats. Encroaching agricultural activities turn to shrink the species’ habitat. Evidence of these local anthropogenic disturbances in the study area included: agricultural plantations, traps and snares laid for game, trails and tracks used for exploiting the natural resources from these forest habitat, wild honey collection,

cartridge shells which were indicative of hunting activities, tree cuts which were indications of wood collection, and stripped bark (mostly from *Prunus africana*) indicating medicinal extracts for commercial purposes. Human activities are the most impacting of all the disturbances that interact with the proposed Mount Cameroon National Park (MCNP). The natural disturbances that occasionally hit the region range from volcanic eruptions, earth quakes and other seismic activities. These are less impacting and wildlife can quickly adapt or recover from their effects since they are occasional unlike the persistent activities from humans.

Following the ecological niche theory; a species depend on the existence of a specific set of environmental conditions for its long-term survival (Hutchinson 1957). These environmental conditions are composed of both biotic and abiotic components. The former may be other organisms with which the species may have relationships such as: trophic, symbiotic, parasitic or simply other forms of ecosystem services. Abiotic components include other non-living environmental conditions including climate. There are growing evidences to support the climate change phenomenon. Global warming exerts a remote threat to wildlife. There is no doubt about the considerable efforts that have been devoted to draw the world's attention to the rising mean global temperatures and changing climate (IPCC 1992, Lugina *et al.*, 2004, Kattenberg *et al.*, 1996, Jones and Moberg 2003, Gates 1993). A number of studies carried around the world have scientifically proven the reality of the phenomenon through the use of ice cores, pollen cores, coral samples and growth phases in tree ringing (Parmesan 2006, Benson *et al.*, 2002, LaMarche 1973, Beever *et al.*, 2005, Mayewski *et al.*, 2004). There is a growing wealth of knowledge on how climate change may affect Africa's biodiversity (Hannah *et al.*, 2002, Lovett *et al.*, 2005a, Lovett *et al.*, 2005b, McClean *et al.*, 2005). Climate change and its effects on species may be one of the most challenging treats to be faced this century. Climate change is one of the threats responsible for the decline in the population of many African primates (Chapman 2006). Climate is a principal determinant to habitat suitability for species since it relates directly to species' physiology and indirectly to the availability of resources such as water and other species

that may serve as food supplies. Mean global temperatures are been forecasted to increase by as much as 1.5 - 4°C even though these increases may not be globally uniform (Kattenberg *et al.* 1996, Sarjent 1988). The IPCC (2007) forecasts a rise of as much as 6.4°C by the close of the century, which is even much higher. Such changes in temperature may cause dramatic distribution in vegetation and other natural land cover types. For instance; there is a possibility of North America experiencing greater vegetation changes during the next 200-500 years compared to changes that have occurred during the past 7000 - 10000 years (Peters 1991, Overpeck *et al.*, 1991). This would imply considerable shifts in biogeographic habitat suitability ranges for most species. Although the effects of climate change may not adversely affect all regions and species equally, the certainty is that species whose habitats are confined to high altitude vegetational areas are more vulnerable to ecological stress that may eventually result from climate change compared to species whose habitats are at lower altitudes or have greater mobility potentials (Cox 1985). In our case, the species of utmost concern finds a refuge on a mountain peak implying its survival is in greater jeopardy should future climates adversely warm up. As humans, we may moderate the deleterious effects from climatic changes through homeostatic adaptations, innovative technologies or by migration. However, this is not the case with wildlife especially those that are sedentary or land logged. MacArthur (1972) predicted an ascend of 500m or a migration of 250km polewards as mitigative measures for active species to adapt for 3°C rise in the mean global temperature. Numerous studies have proven that species are already migrating as an adaptative response to climate change (Beever *et al.* 2003, IPCC 2007, Kelly and Goulden 2008, Lenoir *et al.*, 2008, Parmesan 2006, Schneider and Root 2002). The salient veracity is that not all of these migrations may guarantee the survival of the species involved considering the availability of food, water, shelter including other environmental conditions needed for the species' optimal physiology at the new sites. Besides, habitats may be limited by barriers which restrict further migration. Such shifts may become critical for a species whose tolerance is sensitive to slight changes in climate. This study is an attempt of what may become of the habitat of *Pan troglodytes ellioti* on Mt. Fako if the climate changes adversely in the future. This highlights how

essential this study may be for the conservation of chimpanzees in the proposed MCNP. This study seems timely following the strong indications for a warming climate.

According to Purves *et al.*, (2000) who demonstrated that geographical range size is significantly associated with high extinction risk in declining species coupled with studies on the rarity of species by Gaston (1994); *Pan troglodytes ellioti* faces greater risks of becoming vulnerable to the threats of climate change. Such threats from remote sources could be difficult to identify or even to visualise except through modelling. This further underscores the importance of this study and the need for greater integration of geospatial techniques in to biodiversity conservation and wildlife management to halt the incessantly growing local and global threats whose action are gradual but persistent towards impounding on the nature around us. We may better plan for conservation needs following possible and meaningful predictions.

## **1.2 Aim and objective of the study**

Few scientific studies have focused on the investigative modelling of the impact of climate change on the survival of individual medium-large primate species and as such the body of knowledge related to this subject is relatively sparse. Even where attempts had been made, they were mostly devoted towards whole terrestrial ecosystems (Pastor and Post 1988, Kauppi and Posch 1985, Mellilo *et al.*, 1996, Rosenzweig 1989, Rosenzweig and Parry 1994) or either plant or birds species (Hamburg and Cogbill 1988, Davis and Zabinski 1992) and lastly on small mammal species. For instance, the Craighead Environmental Research Institute (CERI) also developed a habitat suitability model to predict the effects of global warming on three species of pikas using a Geographic Information Systems (GIS). The results of the study were based on predictions made by MacArthur (1972) on ascending 500m or migrating 250km polewards. Millar and Westfall (2009) also studied the distribution and climatic relationships of the American pika (*Ochotona princeps*) in the western Great Basin with periglacial landforms as refugia in a warming climate. Among some early attempts that have focused on medium-large primate species feature the work of the following:



McDonald and Brown (1992) who modelled for the extinction of species following global warming using montane mammals in the Great Basin. The results of their study showed that 14 mammal species are likely to become extinct in the 21<sup>st</sup> century. However, these results have been argued by Skraggs and Boecklen (1996) for empirical reasons. Dundar (1998) carried out a study on the impact of global warming on the survival and conservation of gelada baboon (*Theropithecus gelada*) a medium-sized African primate species on the Ethiopian Highlands. A systems model of the gelada behavioural ecology earlier developed (Dunbar 1992a) was used. The results of the study revealed that the gelada baboons are likely to be confined to high altitude areas in the phase of a global warming condition. Under such confinement, the possibilities for the species' survival will be greatly narrowed.

The aim of this study is to investigate how climate change including other local anthropogenic activities carried within and around the proposed MCNP may affect the habitat suitability for *Pan troglodytes ellioti*. The principal objective is for biodiversity conservation and wildlife management purposes.

### **1.3 Research questions and hypothesis**

This research shall attempt to provide answers to the following questions:

- What are the environmental variables most sensitive to predictions on habitat suitability for *Pan troglodytes ellioti* on Mount Fako?
- Where are the suitable habitats for *Pan troglodytes ellioti* on Mount Fako?
- Do human activities overlap with the suitable habitats for the species, and if so; to what extent?
- Has climate change any effect on the habitat suitability for *Pan troglodytes ellioti* on Mount Fako?

Based on the above research questions, the following hypotheses were formulated respectively:

**Ho:** All the environmental variables have the same sensitivity on the predicted habitat suitability for *P. t. ellioti* on Mount Fako.

**Ha:** Some environmental variables have greater sensitivity on the predicted habitat suitability for *P. t. ellioti* on Mount Fako.

**Ho:** There is no suitable habitat for *P. t. ellioti* in the study area.

**Ha:** There is a suitable habitat range for *P. t. ellioti* in the study area.

**Ho:** There is no overlap between human activities and the suitable habitat for *P. t. ellioti* in the study area.

**Ha:** There is an overlap between human activities and the suitable habitat for *P. t. ellioti* in the study area.

**Ho:** Climate change has no effect on the suitable habitat for *P. t. ellioti* on Mount Fako.

**Ha:** Climate change has an effect on the suitable habitat for *P. t. ellioti* on Mount Fako.

## **1.4 Structure of the thesis**

This dissertation is entirely composed of five interrelated chapters which are structured as shown in Figure 2. Below is a succinct presentation of the structure:

### **1**

The study is introduced to the reader in order to draw her/his attention to grasp all that follows. Here, the problems and threats to *Pan troglodytes ellioti* are identified and raised. The aim of this study including the research questions are defined and the hypotheses are formulated.

### **2**

The study area is presented. A presentation of spatial distribution of the species in the African Continent and the taxonomy are briefly examined.

### **3**

This study is situated in the context of historic studies previously done by others. An overview of the maxent model and methodology to be pursued in order to arrive at the expected results.

**4**

This is the core of paramount interest in this study. The key variables are selected, the model is run and predictions made. The output is analysed. An explanation of the results is given in terms of the observed trends in suitability in relation to the human induced climate change.

**5**

The study closes with a recap. The hypotheses earlier raised in **1** are validated based on the results obtained in **4**. Limitations to the study are highlight. Suggested recommendations that might be useful to other scholars or the management of the MCNP (if deemed necessary) are made.

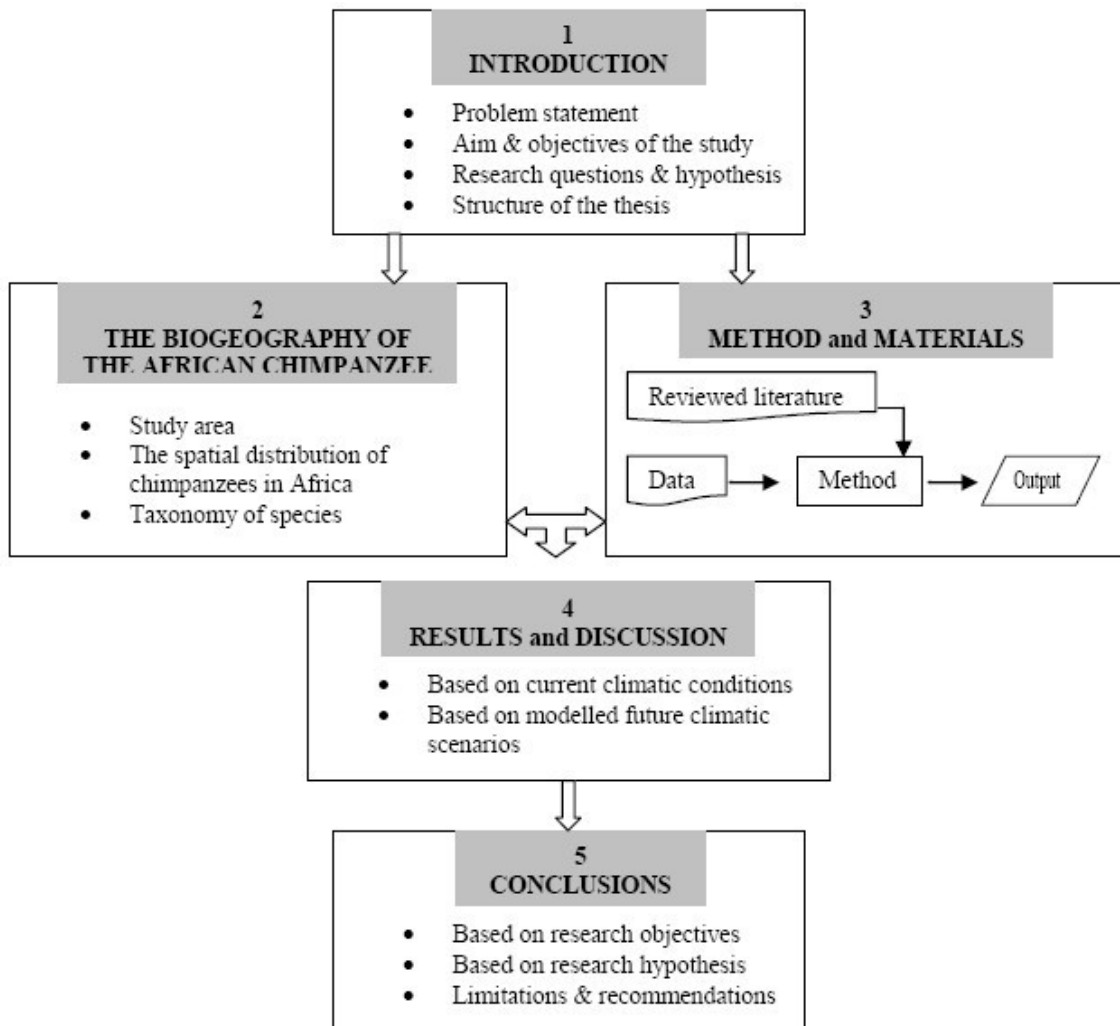

Figure 2: Structure of the thesis

## **2. BIOGEOGRAPHY OF THE AFRICAN CHIMPANZEE**

### **2.1 Basic terminologies**

Various authors have attempted the definition of the term “habitat” as applied to ecology. The habitat of a species has been recognised as a fundamental concept in ecology, wildlife management and distribution (Corsi *et al.*, 2000). For instance, a habitat could be defined as the locality where a plant or animal naturally grows or lives no matter how briefly or as actual or potential environment where a species lives (de Leeuw *et al.*, 2006,). Furthermore, Corsi *et al.*, (2000) attempted to give a classification of the term as whether it relates to a species, community, land, geographic location or environmental space. Based on the above definitions, habitat is commonly considered a property of the species under consideration (de Leeuw *et al.*, 2002). According to Corsi *et al.*, (2000) a habitat could be seen as a species related concept (that is, the environmental description of where a species lives) or a land related concept (that is, a description of the occurrence of a species). The latter use developed with habitat mapping wherein the term habitat refers to homogenous land units or suitable land for wildlife. In this case, the habitat suitability index model or habitat suitability map; where these maps refer to land units and not species (Corsi *et al.*, 2000, de Leeuw *et al.*, 2002). However, the use of the term following this approach introduces an ambiguity. Thus, all land should be considered habitat otherwise unsuitable land could be considered “non habitat”. Finally, to avoid the contradictory use of the term “habitat” in our study, this term is restricted to the occurrence of a specific biota and in this case the chimpanzee subspecies; *Pan troglodytes ellioti*, within the study area.

By principle, species would hardly occupy the whole of a fundamental niche in any given habitat. That is, the ecological geographic space that meets their requirement needs (Anderson *et al.*, 2003) but often occupy a portion (referred to as realised niche) of this available geographic space (Brown and Lomolino 1998). The realised niche is a subset of the fundamental niche. The essence of this concept in species distribution modelling is that the occurrence of a species is possibly sampled principally from the

realised niche. In other words, sampling is limited to the realised niche. Therefore, predicted results in real terms may underestimate the actual potential distribution (Phillips *et al.*, 2006).

## **2.2 Spatial distribution of chimpanzees in Africa**

Throughout the dim vistas of geologic time, tropical rainforests in Africa have expanded and contracted by shifting their biogeographic boundaries. Alterations in palaeo-climates have often been responsible for these shifts. Palaeo-environments and their climatic conditions have been reconstructed through the study of pollen and spores from a deep sea cores such as the one located west of the Niger delta. This revealed that the West African rainforest from Guinea stretched uninterruptedly to Congo through Mount Fako during the last interglacial and early Holocene (Dupont and Weinelt 1996). This Guineo-Congolian rainforest became disjointed by the present day Dahomey Gap in Togo and Benin during the glacial stages of 6, 4, 3 and 2. However, the extension of the gap can not be attributed to climatic changes alone (Dupont and Weinelt 1996). This strongly suggests that the possibility of induced human activities can not be completely ruled out. According to the “refugia” theory, present day biotas in the tropics have originated from “ecological islands” otherwise referred to as “refugia” or “refuges” which resulted from cycles of forest fragmentation and subsequent expansion (Hamilton 1976, Livingstone 1975, Coetzee 1964, Bonnifille and Riolet 1988, van Zinderen Bakker and Coetzee 1972). According to biogeographic theory, chimpanzees were restricted to localised refugia during periods of minimal forest cover (Goldberg 1996). Subsequently, these chimpanzees dispersed outwards from these refugia when forests re-expanded during post glacial climatic conditions (Goldberg 1996).

The robust chimpanzee; scientifically referred known as *Pan troglodytes* (Blumenbach 1775), literally meaning “*cave dwellers*” in Greek; are the most widely spread primate species throughout the forested zone of Africa covering variety of habitats that range from moist forest, dry forests and forest galleries that extend into savannah woodlands (Butynski *et al.*, 2000, Oates *et al.*, 2007). The former range of chimpanzees in Africa

used to be the tropical rainforest that stretched across the continent from west to east along the equatorial belt spanning from Sierra Leone to Tanzania. Taxonomic subdivisions among the species are mainly based on genetic attributes, morphological differences, behavioural aspects and geographical distribution. The western most subspecies; *Pan troglodytes verus*, has its biogeographic range stretching from Senegal to Nigeria (Schwarz 1934) but interrupted by the Dahomey gap in Togo; where the subspecies is presumed to be extinct (IUCN 2006, IUCN 2008). The west bank of River Niger in Nigeria demarcates the subspecies' eastern most geographic barrier (Schwarz 1934). *Pan troglodytes ellioti* (Matschie 1914, Matschie 1919) which was initially confused to be *Pan troglodytes vellerosus* in earlier publications (Gray 1862) occupies the biogeographic range that starts from the lower east bank of River Niger in Nigeria to north west of River Sanaga in Cameroon (Oates *et al.*, 2009). Dental studies carried out by Pilbrow *et al.*, (2006) on the skull remains from all the subspecies distinguished *Pan troglodytes ellioti* as a distinct subspecies from the rest. Hu *et al.*, (2001) also found this subspecies to be distinct and not merged with the others in the continent. While the biogeographic range of *Pan troglodytes troglodytes* occupies the central African region that spans from south of River Sanaga to the Congo and Ubangi Rivers in the Democratic Republic of Congo and Central African Republic respectively (Blumenbach 1799). *Pan troglodytes schweinfurthii* has its biogeographic range from the Congo and Ubangi Rivers in the Democratic Republic of Congo and the Central African Republic respectively to western Uganda, Rwanda and Tanzania (Giglioli 1872). This subspecies occupies two habitats; medium to high altitude forest (Goldberg 1996). Noack (1887) identified *Pan troglodytes marunguensis* as another subspecies that occupying the biogeographic habitat west of Lake Tanganyika. Figures 3 and 4 show the biogeography of chimpanzees in Africa.

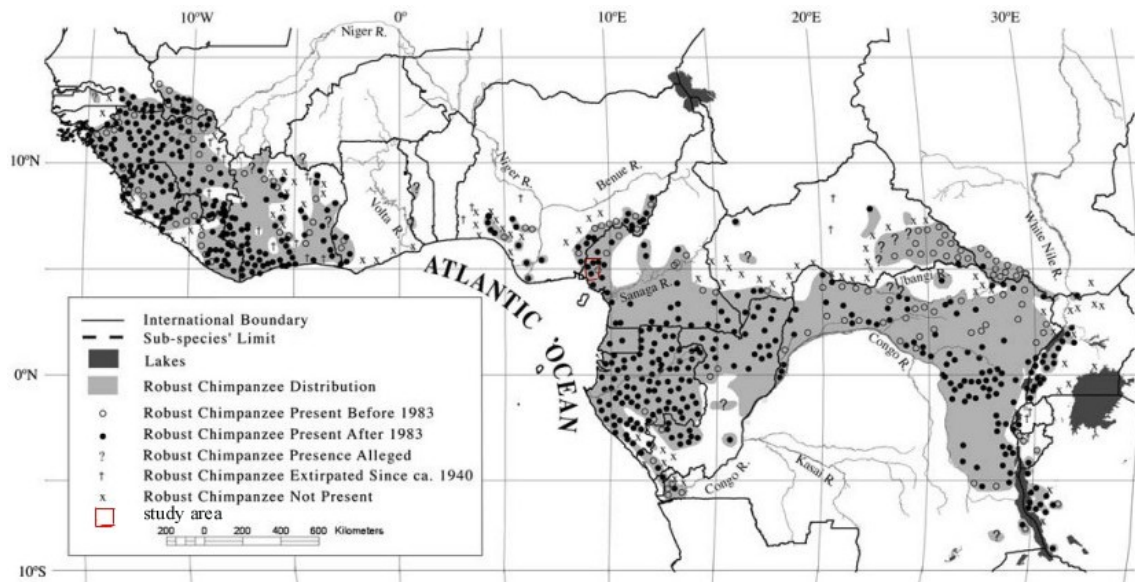

Figure 3: The spatial distribution of chimpanzees in Africa over time.  
 Source: Adapted from Oates (2006) after Butynski (2003), who provides a full list of sources

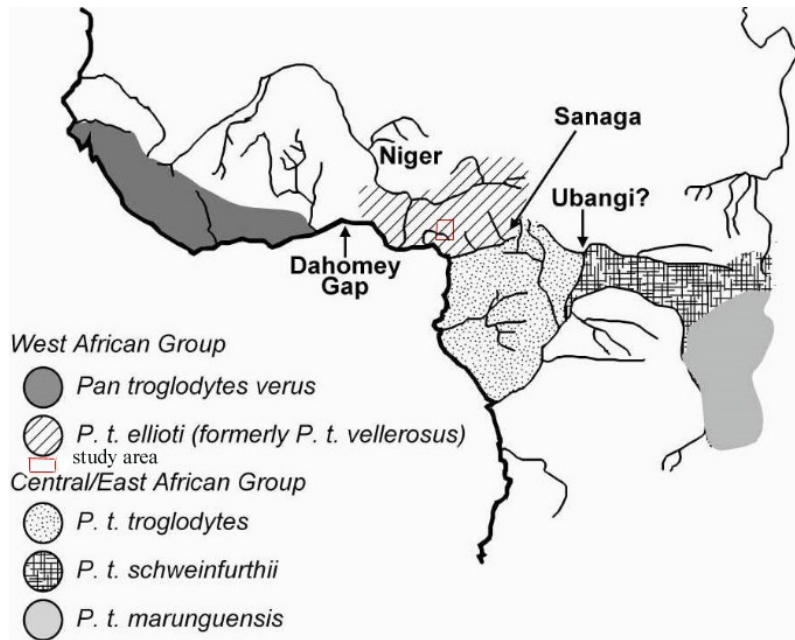

Figure 4: The biogeographic habitats of chimpanzees in Africa  
 Source: <http://www.vellerosus.org/site/history.shtml>

The nomenclature of the chimpanzees from the area around Mount Fako has in the past been a subject of controversy between *Pan troglodytes ellioti* (Matschie 1914, Matschie 1919) and *Pan troglodytes vellerosus* (Gray 1862). Thanks to Oates (2009) whose in

depth review of related literature has settled the score and salvaged us from the doubts and confusion on the nomenclature as the former over writes the latter. Thus, the chimpanzee subspecies on Mt. Fako is *Pan troglodytes ellioti* (Matschie 1914, Matschie 1919, Oates 2009). Geographic barriers have restricted subspecies in their respective biogeographic habitats and this has succeeded in preventing gene flow across these barriers. The restrictions of gene flow across such barriers have led to each subspecies developing typical genetic compositions which are responsible for the respective phenotypic characters. For instance, *Pan troglodytes schweinfyrthii* has longer hair compared to its counterparts and has bronze or copper facial skin. While *Pan troglodytes troglodytes* has a black facial skin. The western most *Pan troglodytes versus* has pinkish facial skin that tends to darken as the chimpanzee ages (IUCN 2008).

A proper understating of a species' biogeography is important for addressing conservation issues. Biogeography reveals the geographical features that may act as barriers to restrict the expansion of species beyond biogeographic zones. The confinement of species within a biogeographic area limits the possibility of gene flow and this makes the species more liable to greater vulnerability of extinction risks should the species be threatened within a particular habitat. As a consequence of biogeographic barrier, many African primates face greater extinction risks (Eeley and Lawes 1999, Lawes and Eeley 2000).

### **2.3 The study area: the proposed Mount Cameroon National Park**

The study area shown on Figure 5 is the proposed Mount Cameroon National Park (MCNP). It is located on Mount Fako and Etinde commonly referred to as Mount Cameroon. The study area is bounded by the following pairs of geographic coordinates; longitudes 9°0.6' and 9°18' east of the Greenwich; latitudes 4°27' and 4°3' north of the equator.



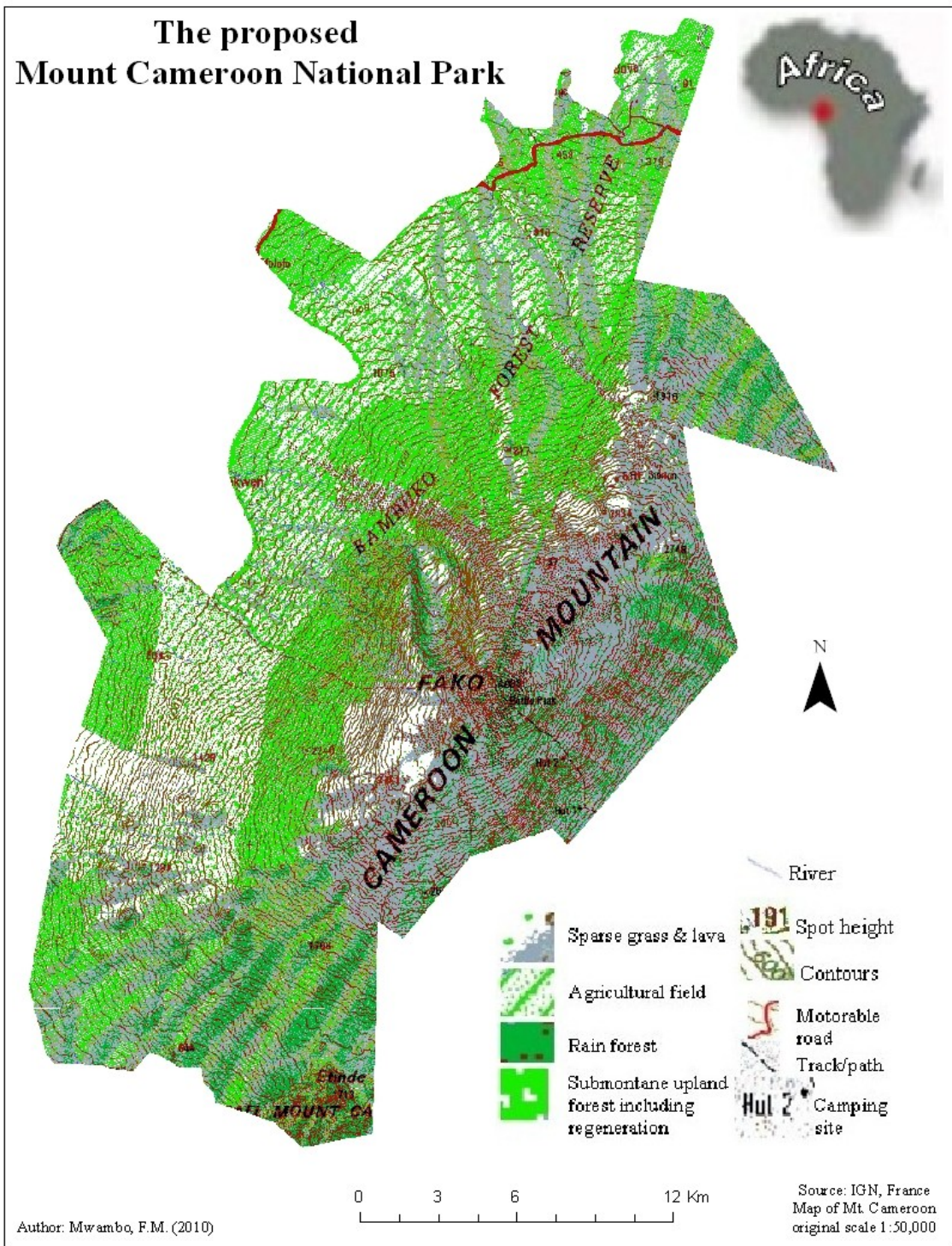

Figure 5: The study area; the proposed MCNP located on Mt. Fako

## **2.4 Endemism of the Mount Fako area**

The studies of variation in the abundance within a species' geographic range define the link between the disciplines of ecology, geostatistics and biogeography. Empirical studies of various taxonomic groups show that the density of a given species is unevenly distributed in space, with few "hotspots" and many "coldspots" where abundance is order of magnitudes lower (Brown *et al.*, 1995). An explanation for such observed pattern is the spatial variation in habitat suitability. That is, the variation in density is developed by how closely sites correspond to a species' niche (Brown *et al.*, 1995). At a global scale; as early as 1983, Whites (1983) in his phytogeographic framework had identified the Mt. Fako area as part of the afro-montane archipelago-like regional centre of endemism. This region which constitutes part of the Guinean Forest of West Africa biodiversity hotspot was again identified as one of the world's 10 biodiversity hotspots (Myers 1988) and still featured the list in the revisited version in which the number increased to 18 (Myers 1990). The latter still features as one of the world's biodiversity hotspots composed of all ecosystem types which currently number well over 25 (Myers 2003, Myers *et al.*, 2000, Mittermeier *et al.*, 1999). Continent wide, Cameroon is often described as "Africa in miniature". The reasons being: though the national territory makes only about 1.6% of the total surface area of Africa, all the major ecosystems of the Continent are well represented in Cameroon. She ranks 5<sup>th</sup> in terms of biological diversity and accounts for about 21% of the fish species; 48% of mammals; 54% of bird species; 50% of amphibian species; 30-75% of reptiles and 42% of butterflies that have been recorded from Africa (MINEF 1996a). Cameroon ranks second in the number of primate species recoded from Africa (Cowlshaw and Dunbar 2000). Figure 6 shows the endemism of the study area within the African Continent.

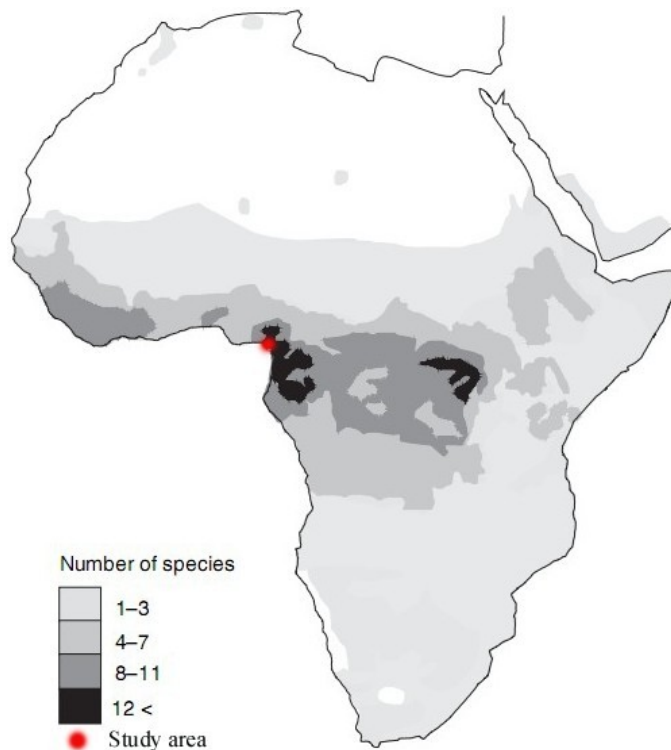

Figure 6: The endemism of the Mount Cameroon region in Africa.  
Source: Adapted from Chapman (2006)

Within the national territory, the Cameroon – Nigeria trans-boarder area; other wise referred to as the “Mount Cameroon region” represents an area of high biological species diversity and endemism (Forboseh *et al.*, 2007, Cable *et al.*, 1998, Kingdon 1989, Sayer *et al.*, 1992). According to the “refugia” theory, which postulates that present day biotas in the tropics have originated from “ecological islands” or “refugia” which in turn resulted from cycles of forest fragmentation and subsequent expansion (Hamilton 1976, Livingstone 1975, Coetzee 1964, Bonnifille and Riolet 1988, van Zinderen Bakker and Coetzee 1972). The area around Mt. Fako is one of such Pleistocene biogeographic “refugia” of endemism in the Central African region. It is the only region in both west and central Africa where there is a continuous chain of stratified vegetation from the mangroves at the inter-tidal brackish waters that borders the continent to the sub-alpine at the summit which stands at an altitude of 4100m a.s.l (Colyn *et al.*, 1991). This Guineo-Congolian region of endemism is disjointed from the Guinean forest of West Africa by the Dahomey gap in Benin and Togo (Aubréville 1949, Booth 1954, Booth 1957, Goldberg 1996).

The area around Mt. Fako is endowed with a fascinating array of both floral and faunal species. The exceptionally high species richness and endemism is an attribute of the wide altitudinal range which rises from sea level to a majestic height of 4100m a.s.l. This altitudinal interval provides a great variety of habitats with differing micro-climatic conditions under which different species favourably flourish. The region is biogeographically unique to both west and central Africa. New species are increasingly being discovered and identified from the area (Cheek *et al.*, 2000, Læssøe *et al.*, 2002, Roberts 2003). These are some proofs to highlight the ecoregion's biological richness in terms of species diversity. The fact that new species are still being discovered even lately (Cheek *et al.*, 2000, Læssøe *et al.*, 2002, Roberts 2003) perhaps, one may be tempted to conclude that the region has not been fully explored for its potential floristic and faunistic checklists. Thus, the need to support conservation efforts in the region is of utmost importance.

## **2.5 The taxonomy of the chimpanzees on Mount Fako**

The present day taxonomy of chimpanzees has gained much from the work of Schwarz (1934), though with some modifications. He identified a single species of chimpanzee which he named *Pan satyrus* and later four subspecies which were distinguished as; *P. s. verus* (western Africa subspecies); *P. s. troglodytes* (central Africa subspecies); *P. s. schweinfyrthii* (east Africa, north of Democratic Republic of Congo and east of Congo River subspecies) and *P. s. paniscus* (south of Congo river subspecies) respectively. The name *Pan satyrus* was then changed to *Pan troglodytes* in harmonisation with previous studies that had been carried out by Blaumenbach (1775, 1799) on the same species. Scientific support on this change of nomenclature is also given by Stiles and Orleman (1927). However, *Pan paniscus* was moved to a species hierarchy by Coolidge (1933). Table 1 shows the taxonomical hierarchy of the chimpanzee subspecies in the study area.

<b>Taxonomic rank</b>	<b>Taxonomic name</b>	<b>Reference</b>
Domain	<i>Eukaryota</i>	Whittaker & Margulis, 1978
Kingdom	<i>Animalia</i>	Linnaeus, 1758
Subkingdom	<i>Balateria</i>	Hatschek, 1888) Cavalier-Smith, 1983
Branch	<i>Deuterostomia</i>	Grobben, 1908
Infrakingdom	<i>Chordonia</i>	Haeckel, 1874; Cavalier-Smith, 1998
Phylum	<i>Chordata</i>	Bateson, 1885
Subphylum	<i>Vertebrata</i>	Cuvier, 1812
Infraphylum	<i>Gnathostomata</i>	Auct. - Jawed Vertebrates
Superclass	<i>Tetrapoda</i>	Goodrich, 1930
Class	<i>Mammalia</i>	Linnaeus, 1758 - Mammals
Subclass	<i>Theriiiformes</i>	Rowe, 1988; Mckenna & Bell, 1997
Infraclass	<i>Holotheria</i>	Wible <i>et al.</i> , 1995; Mckenna & Bell, 1997
Superlegion	<i>Trechnotheria</i>	Mckenna, 1975
Legion	<i>Cladotheria</i>	Mckenna, 1975
Sublegion	<i>Zatheria</i>	Mckenna, 1975
Infralegion	<i>Tribosphenida</i>	Mckenna, 1975; Mckenna & Bell, 1997
Supercohort	<i>Theria</i>	Parker & Haswell, 1897; Mckenna & Bell, 1997
Cohort	<i>Placentalia</i>	Owen, 1837; Mckenna & Bell, 1997
Magnorder	<i>Epitheria</i>	Mckenna, 1975; Mckenna & Bell, 1997
Superorder	<i>Preprototheria</i>	Mckenna, 1975; Mckenna, in Stucky & Mckenna, in Benton (Ed.) 1993
Grandorder	<i>Archonta</i>	Gregory, 1910; Mckenna, 1975
Order	<i>Primates</i>	Linnaeus, 1758
Suborder	<i>Haplorrhini</i>	Pocock, 1918
Infraorder	<i>Simiiformes</i>	Haeckel, 1866
Parvorder	<i>Catarrhini</i>	Geoffroy Saint-Hilaire, 1812
Superfamily	<i>Hominioidea</i>	Gray, 1825; Gregory & Hellman, 1923
Family	<i>Hominidae</i>	Gray, 1825
Genus	<i>Pan</i>	Oken, 1816
Specific name	<i>troglodytes</i>	Blumenbach, 1775
Subspecies	<i>elliotti</i>	Matschie, 1914
Scientific name	<i>Pan troglodytes elliotti</i>	Matschie, 1914

Table 1: Taxonomic ranking of the chimpanzee subspecies in the study area

Source: [http://zipcodezoo.com/Animals/P/Pan\\_troglodytes/](http://zipcodezoo.com/Animals/P/Pan_troglodytes/) and <http://www.berggorilla.de/english/gjournal/texte/11men.html>

### 3. MATERIALS and METHODS

#### 3.1 Materials

The collection of data was closely followed by the processing phase. These included simple tasks (for instance saving the samples data in .CSV format) to complex tasks (for instance the correction of the missing elevation values and the image processing prior to the land cover /use classification). The originally downloaded digital elevation model (DEM) had some missing elevation values. The problem was rectified as follows. Firstly, the DEM was vectorised. Missing elevation values were then computed by averaging the nearest surrounding pixels values. The corrected DEM was then rasterised as a grid. The shape file of the proposed MCNP (on geographic projection) was used to clip the environmental layers and the DEM serving as the mask. The essence was to have all the data layers to be of both the same geographic projection and dimensions for acceptance and compatibility with the model. Table 2 shows the environmental layers used as input data in the model. Besides the altitude which was directly downloaded from *worldclim*, the slope and aspect were derived from the DEM using ArcGIS software.

Variable	Unit	Source	Proxy
Elevation	meter	DEM	food availability, human activity, health risks
Slope	degrees	DEM	food, nesting place
Aspect	degree	DEM	nesting, food
Precipitation	mm/year	worldclim	food, species activity pattern, seasonality
Minimum temperature	°C	worldclim	species activity, health
Maximum temperature	°C	worldclim	species activity, seasonality
Average temperature	°C	worldclim	species activity, seasonality
Land cover type	Category	supervised & unsupervised classification of Landsat images of study area	food quality, availability, nesting & shelter

Table 2: Environmental layers used in the model

#### 3.1.1 Data on species occurrence

The data related to the occurrence of *Pan troglodytes ellioti* in the proposed MCNP was collected by the staff of World Wildlife Fund for Nature (WWF); Coastal Forests

Programme Office, Limbe - Cameroon. The spatial locations of chimpanzee nests were obtained using the global positioning systems (GPS) receiver. Surveys were done along transect lines. The exercise was conducted between September 2006 and January 2007. During this period, 59 nests were recorded. The data is constituted of the following attribute fields: date, transect, species name, group size, transect length, perpendicular distance, nest type, nest height and nest age. The age was given in descriptive terms; fresh, recent and old corresponding to progressive stages in the decay process of nests respectively. During the course of collecting the data, some signs of human activities were equally recorded as shown in Table 3.

### 3.1.2 Data on local human activities

The human signs that were encountered during the course of collecting the data on the species are shown in Table 3.

<b>Human sign</b>	<b>Indication</b>
agricultural farms	deforestation and habitat destruction
tree cuts and peeled bark	wood collection and forest exploitation for medicinal purposes
wild honey collection	reduction of food resources for species
traps and snares	hunting
bush paths and tracks	locus for forest exploitation by locals
cartridge shells	hunting / poaching

Table 3: signs depicting local human activities

### 3.1.3 Environmental data

The occurrence of species within a habitat is not by chance but controlled by both spatial and aspatial predictors which interactively play a predictive role in determining the occurrence of species at any given location. Two main types of environmental predictors were used as inputs into the model. These were the continuous and the categorical variables; which were the climatic / topographic related data and the land cover / use data respectively. Since enormous sampling stations were needed for accurate measurements on the climatic conditions from the region which is indeed very sparsely covered by a network of few meteorological stations, the problem was minimised using downloaded climate data from *worldclim*. Two datasets for the climate were downloaded. The dataset for the past 50 years (1950-2000) was considered to give the

current climatic conditions. While the data modelled by the Canadian Centre for Climate Modelling and Analysis (CCCMA) for next 50 years (2001-2050) was considered to give the likely future climatic conditions, with two scenarios under consideration. These are the *a2a* and the *b2a*. Based on the current expulsion rates of green house gases, (GHGs) chiefly Carbon Dioxide (CO<sub>2</sub>); the former scenario is a medium-high emission rate which assumes that the CO<sub>2</sub> concentration in the atmosphere shall be doubled by 2050 while the latter scenario assumes that the climate will remain relatively unchanged during the next half century.

#### **3.1.4 The land cover /use of the study area**

The accurate classification of the land cover/use of the region was provided by the Geographic Information Systems and Remote Sensing (GIS/RS) Unit of the Limbe Botanic Garden (LBG) Cameroon. The bases of this land cover input layer was the classification of a geo-referenced Enhanced Thematic Mapper (ETM+) image which was acquired in 2000 by the Landsat sensor. Due to the geographic position and relief of the region, the area is often cloudy during most periods of the year. Where clouds were problematic in the image acquired in 2000, another image which was acquired in 1986 was used to minimise the problem. With the expert knowledge on the botanical and forest management of the area by the LBG; coupled with adequate ground truthing, 25 land cover/use classes were distinguished with a complete metadata. Since the study area is a subset of Mt. Fako and her environs, some land cover classes risk the chances of being missing within the study area. Figure 7 shows the land cover/use of the study area.



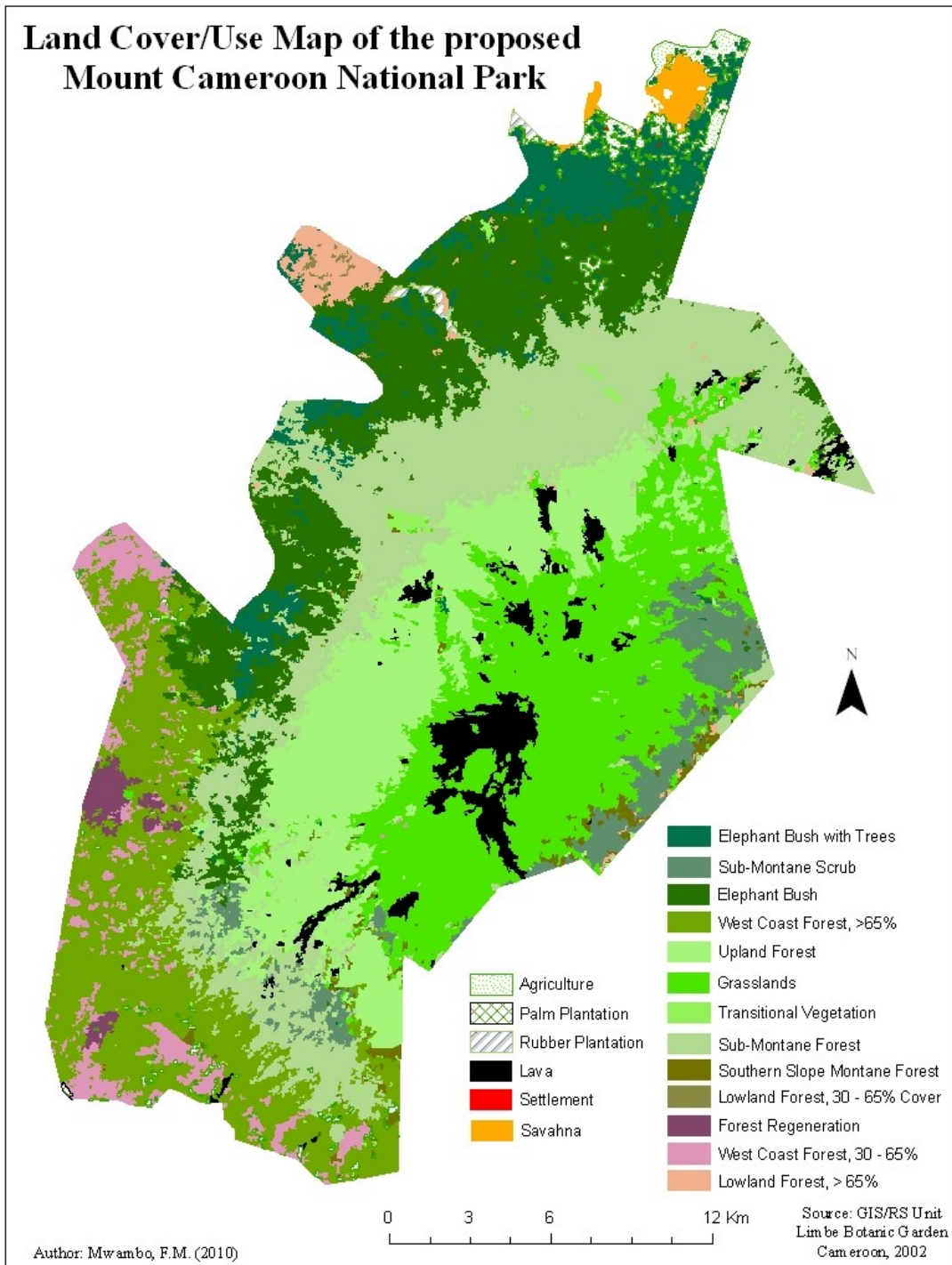

Figure 7: The land cover/use map of the proposed MCNP

## **3.2 Methods**

### **3.2.1 Models for species distribution**

Models that predict species occurrence and their relationship with the environment are of paramount concern in most ecological studies (Guisan and Zimmermann 2000). Such models have been very versatile to wildlife management for the investigation of parameters such as the species distribution, possibilities of biological invasion by alien species, population variability analysis as well as human-wildlife interactions (Hirzel *et al.*, 2001, Hirzel *et al.*, 2006). Models of this type are generally referred to as habitat suitability models and they depict the probability or likelihood of the occurrence of a species (Store and Kangas 2001). Two approaches could be distinguished; inductive and deductive habitat modelling approaches (Corsi *et al.*, 2000). The inductive habitat suitability modelling generalises the characteristics of locations where species occur to the rest of the management area whereas the deductive habitat modelling makes inferences from a general to a particular case. The deductive approaches are determined a priori and the prediction of the organism is by selection of key criteria while in inductive, habitat choices of the subset of the organism are observed and then extrapolated over a much wider region (Skidmore 2002). The occurrence of a species in a habitat is controlled by predictors (Guisan and Zimmermann 2000). Three basic components make up a predictive distribution model. These are; the ecological model which selects the environmental variables for input; the data model which determines how the data will be collected, measured and estimated; and the statistical model which calibrates and analyses the data respectively (Austin 2002). Statistic models are often developed based on strong assumptions (Hirzel and Gisan 2002). There are several types of models which could be categorised into seven main types. These include: multiple regression, classification techniques, environmental envelopes, Bayesian approach, ordination techniques, neural networks and mixed approach - with more than one method (Guisan and Zimmermann 2000). For instance, models that use presence/absence data often make use of multiple regressions with generalised techniques.

Presently, there exist an overwhelming plethora of methods for predicting species' geographic distribution (Elith *et al.*, 2006). With such a wide spectrum, choice depends on the strengths and weaknesses of one method over others or either a function of the nature of the species' occurrence data or based on the objective for the prediction. Such objectives could be to investigate the relationship between an environmental parameter and the species' richness (Mac Nally and Fleishman 2004); the spatial characteristics that may allow for species to flourish in a particular geographic space (Araujo and Williams 2000, Scotts and Drielsma 2003, Ferrier *et al.*, 2002a); the invasive potentials of alien species to colonise non-native geographical locations (Goolsby 2004, Peterson 2003); ecological and geographical differentiation of closely related species (Graham *et al.* 2004b); species distribution history (Hugall *et al.*, 2002); for casting a species geographic distribution in the future based on modelled climatic conditions (Araujo *et al.*, 2004, Skov and Svenning 2004,). The problem of errors and uncertainties are almost ubiquitous and unavoidable in all predictive models. An understanding of the source, magnitude and pattern of these errors is essential if the models are to be used transparently in decision making (Barry *et al.*, 2006). Besides the limitations of accuracy, precision and uncertainties is also the problem of sparsely occurrence data on species (Elith *et al.*, 2006); a commonly encountered situation in the field which reduces the practicability of using most dataset in some models. The predictive formulation of species' distribution is based on abundance of species in relation to an environmental predictor. In other words, species abundance is a function of some environmental predictors. Empirical studies of various taxonomic groups show that the density of a given species is unevenly distributed in space, with few "hotspots" and many "coldspots" where abundance is order of magnitudes lower (Brown *et al.*, 1995). An explanation for such observed pattern is the spatial variation in habitat suitability. In other words, the variation in density is developed by how closely sites correspond to a species' niche (Brown *et al.*, 1995). Thus, many species' distribution models have been developed on the bases of species presences/absence or abundance data where the regions of concern have been sampled systematically (Austin and Cunnigham 1981, Hirzel and Guisan 2002, Cawsey *et al.*, 2002).

Initial methods of species predictive distribution were built on the bases of “presence only” data. They often focused on distances-based measurements (Busby 1991). Later methods then adapted to a “presence-absence” approach wherein the “presence-only” data was modelled against a background that was randomly sampled. This approach was binomial in the sense that both the “presence-only” data along side a false background were modelled (Ferrier *et al.*, 2002a, Keating and Cherry 2004). Unlike in the past, there has been an increase in the use of remotely sensed environmental layers (Turner *et al.*, 2003) and sophisticated interpolation of climatic data in species’ distribution modelling nowadays (Thornton *et al.*, 1997). Also with the passage of time, the human-computer interaction has increased and there has been improvement both in terms of computing power and spatial technology. As a result, modern methods of species predictive distribution have appeared on the horizon. These are basically “machine learning” methods that have better integrated the fundamentals of both ecology and statistics in the modelling approach (Phillips *et al.*, 2006, Elith *et al.*, 2006). So far, two principal “machine learning” methods namely the maximum entropy distribution models (otherwise referred to as Maxent and Maxent-T) and the boosted regression tree also referred to as stochastic gradient boosting have been developed (Phillips *et al.*, 2006, Elith *et al.*, 2006). To differentiate the two basically: boosted tree regression combines two algorithms; the boosting algorithm which interactively combines trees. It is often preferred because of its capability in selecting variables and is also good at modelling interactions (Elith *et al.*, 2006). While maximum entropy employs a “presence-only” data approach (Phillips *et al.*, 2006, Elith *et al.*, 2006). The two sub-models of the latter are Maxent and Maxent-T (that is, Maxent with threshold). However, most attention shall be directed to Maxent since it makes the pivotal model of this study.

### **3.2.2 The maximum entropy distribution model (MaxEnt)**

In this study, the maximum entropy species distribution model; Maxent (version 3.3.1) was used as a statistical model. Maxent is a “machine learning” method and is based on the principle of maximum entropy. The probability distribution of species is assessed by

estimating the probability of maximum entropy. That is, the algorithm includes as many “options” as possible into the probability distribution while there is simultaneous exclusion of all “options” known to be outside the target distribution as specified by certain constraints. The modelling process in Maxent is iterative and begins with an assumption of a uniform probability (Phillips *et al.*, 2004, Dudík *et al.*, 2004, Phillips *et al.*, 2004). Following studies on predictive distribution of species on terrestrial environments, Maxent is by far preferred. For instance, a comparative study of 16 models by Elith *et al.*, (2006) ranked Maxent as the top most for predicting species distribution on a terrestrial environment. Kayijamahe (2008) used variables that were related to the land cover type, climatic and topographic data in Maxent and GARP to model for the biophysical habitat suitability for gorilla (*Gorilla beringei beringei*) on the Virunga volcanic peaks. His results proved that Maxent out performed GARP. Much of the strengths of Maxent lay on the ease with which results could be interpreted by humans. Models generated have a natural probabilistic interpretation which gives a smooth gradation ranging from least to most suitable conditions. In Maxent, constraints are quantified as “features” and they represent few characteristics known about the target distribution. The features and their corresponding weights get updated; the “gain” equally increases exponentially at suitable locations to maximum attained value. “Regularisation” helps in reducing the gain in other to avoid overfitting of the model. The higher the regularisation the wider the corresponding predicted distribution. Maxent accepts both continuous and categorical dataset. Outputs are continuous. The jackknife gives the relative importance of each contributing variable to the model (Phillips *et al.*, 2004, Dudík *et al.*, 2004, Phillips *et al.*, 2006).

### **3.2.3 Modelling for the habitat suitability**

The data processing was closely followed by the modelling phase in which the habitat suitability for *Pan troglodytes ellioti* was modelled in relation to the different scenarios through which climate change is being presented in this study. The model was trained then tested. The dataset was split in the ratio of 3:1 for the training and testing respectively. Data was input in to the model which was ran and the predicted output was

imported into ArcGIS (version 9.3) where the analyses were done. The prime interest of this study was not to compare the results on species predictive distribution using Maxent to results obtained from other models. Rather our interest is placed on the singular use of maxent to investigate the impact climate change may have on the suitability of the habitat, on the assumption that the maxent model ranks relatively high compared to other models in terms of predicting species distribution on terrestrial biomes. Appraisals on the model's strength on prediction have been cited in a number of publications which include: (Elith *et al.*, 2006, Kayijamahe 2008) who compared prediction results from more than one model; (Kumar and Stohlgren 2009, Boubli and de Lima 2009) who uniquely used the model for predicting species distribution without a control model for comparison and concluded that predicted results were satisfactorily of high success. The choice for maxent as a statistical model in the methodology of this study was buttressed by the following facets: the relatively low sensitivity to noise, the relatively small sample size, its capability of accepting both categorical and continuous datasets, ability to model iterations and lastly supported by successes recorded in historic studies in which maxent was used for modelling (Elith *et al.*, 2006, Hernandez *et al.*, 2006, García Márquez, 2006, Herkt 2007, Kayijamahe 2008). These earlier success appraisals on the strengths of maxent contributed to the impetus for our singular choice of using maxent without comparison to other models.

Although the study is being carried in 2010, the climate dataset from 1950 – 2000 shall be referred to as current climate data while the dataset from 2001 – 2050 modelled by the CCCMA shall be referred to as future climate data, with two scenarios; namely *a2a* and *b2a*. Figure 8 shows the flowchart of the methodology used in this study.

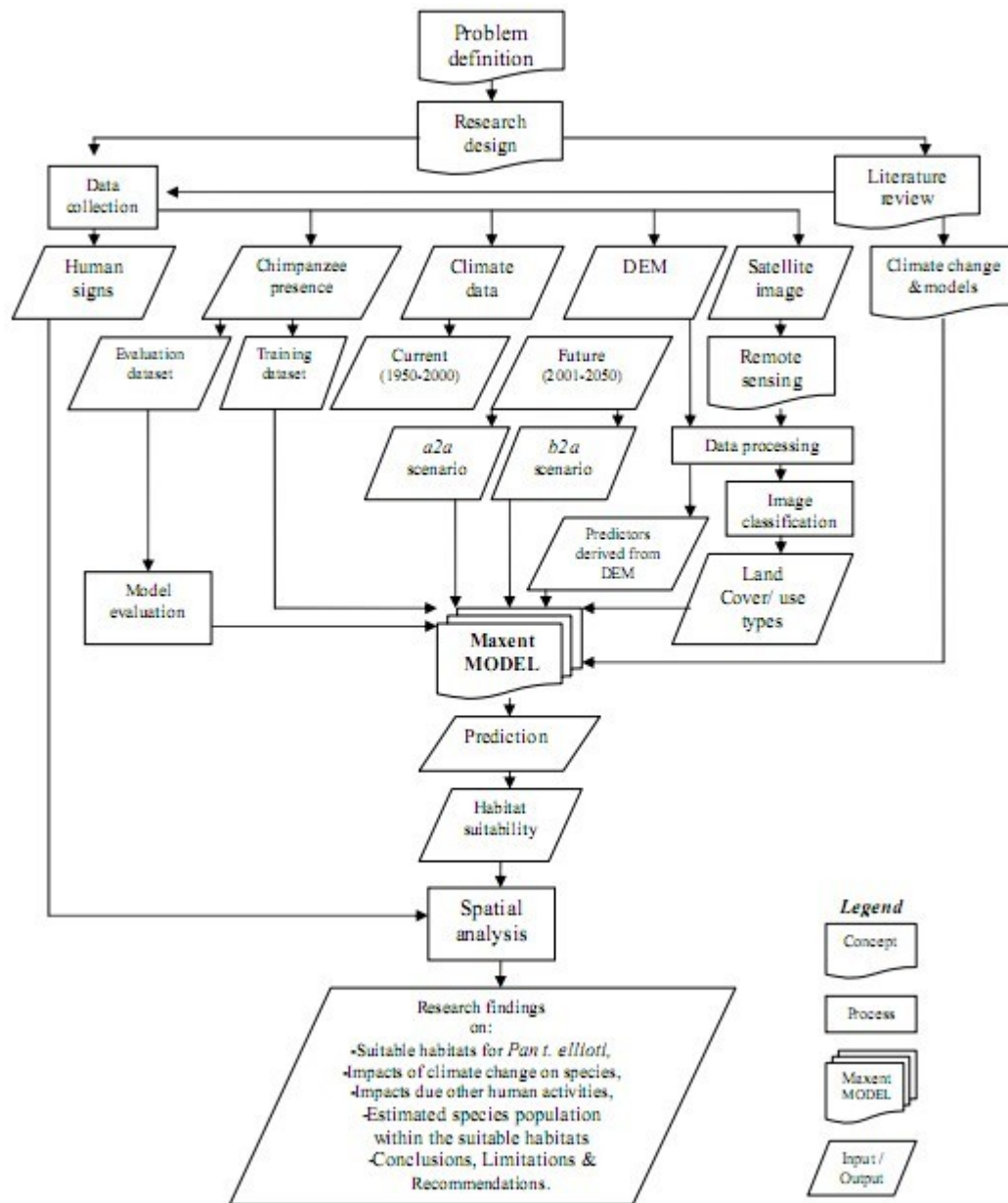

Figure 8: The flowchart of the methodology

The model was complemented by other software shown on Table 4.

Software	Use
Maxent 3.1	habitat suitability modelling
Arc GIS 9.3	data processing, spatial analysis & map preparation
Micro Soft Word	reporting
Micro Soft Excel	sample data processing
Micro Soft Power point	power point preparation of research results

Table 4: Software used in the study

## 4. RESULTS and DISSCUSSION

### 4.1 Variable importance

The dataset having the current climatic conditions was used to predict for the species occurrence in the study area. To begin, the model was ran several times in order to check the stability, consistency and pattern of the predicted results. All the environmental variables were used in initial runs and later selective variables were retained. The preliminary runs were used to identify and discriminate for the key variables which were later retained for comparative predictions from the different scenarios. The environmental variables used in the initial runs were: altitude, aspect, maximum temperature, minimum temperature, mean temperature, slope, vegetation type and precipitation. While the selective variables that were retained were: altitude, maximum temperature, minimum temperature, slope, vegetation type and precipitation. The spatial reasons for making the choice on the selective variables are shown in Table 5.

<b>Variable</b>	<b>Proxy</b>
altitude	determines the micro-climate and in turn availability of resources
maximum temperature	informative on the upper limit for a species' temperature tolerance
minimum temperature	informative on the lower limit for a species' temperature tolerance
slope	determines the possibility of nesting
precipitation	relates to availability of resources (water and food)
vegetation type	relates to availability of resources (food, shelter and nest)

Table 5: selected key variables for the model

The same altitude, slope and land cover type were used while the climatic variables were varied based on the different climate scenarios. The altitude and slope were constant in all cases since these would hardly change. The land cover type was also maintained for the following reason. Primarily, the vegetation type was of paramount importance in making meaningful predictive species' distribution since it contains information that is not contained by the other variables and thus, the vegetation can not be excluded. Secondly, the vegetation cover of the area may likely remain the same over the next few decades (excluding intense human influence). Also, considering the time span over which the geological processes of weathering may act on the basaltic lava flows which make the local lithology of the area to form well developed volcanic soils capable of



supporting dense vegetation at the summit stretches well beyond 2050. Taking advantage of the response curves generated by the model during the run, below is a succinct explanation of the relationship between the variables (altitude, slope, land cover) and the probability of species presence. It may be worth noting that, in each graph all other variables are assumed to remain constant with respect to variable in question.

Generally, lower altitudes turn to offer more suitable conditions relative to very high altitudes. The reason being that at much higher altitudes the temperatures drop drastically as temperature near freezing point may be encountered at the summit of Mt. Fako. These temperatures seem not to favour the species' physiological processes since the species may not be well adapted for such temperatures. Also, at much higher altitudes the availability of resources becomes scarcer. Moisture may be frozen, lesser food supplies and increasing difficulties for shelter are encountered as the vegetation transitionally become mosses and lichen making nest building difficult. Figure 9 shows the altitude varying with the probability of species presence.

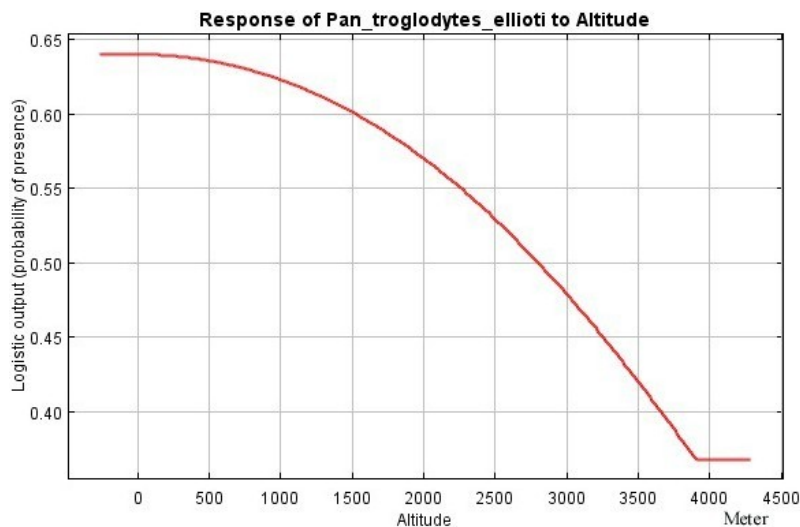

Figure 9: Response curve for altitude

The slope or gradient or inclination mostly affects the favourability for nesting conditions. Flat - very gently sloping areas with a slope close to zero are preferred to steeply sloping area. For nesting reasons, gently inclined areas are relative more suitable

to areas with very steep slope. Figure 10 shows the slope varying with the probability of species presence.

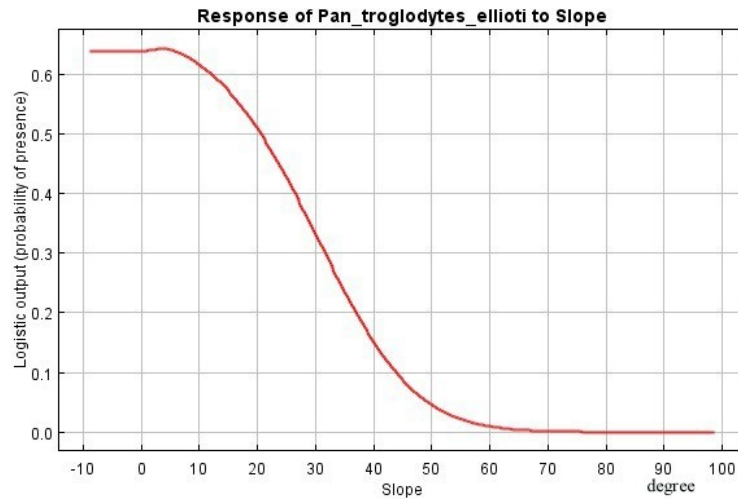

Figure 10: Response curve for slope

The variation of land cover/use and the probability of species presence is shown in Figure 11. Relating the values for the land cover classification in Appendix 2, it would appear that the land cover classes in Table 6 offer greater suitability conditions compared to other vegetation types in the study area. These vegetation classes may apparently offer greater supplies for food, shelter and nesting material making the areas where they grow to be relatively more suitable habitat compared to other places within the study area.

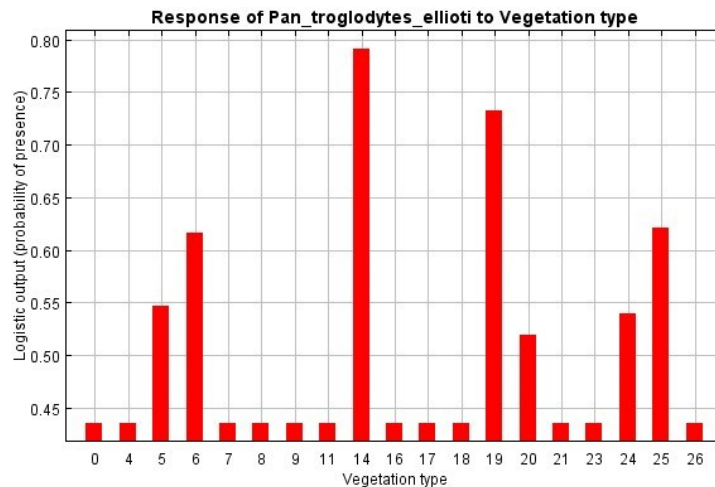

Figure 11: Response curve for the land cover type

Land cover code	Land cover / use class
14	Transitional vegetation
19	Forest regeneration
5	Elephant bush with tree
6	Elephant bush
20	Sub-Montane Forest
24	West Coast Forest, >65%

Table 6: Land cover classes with high habitat suitability

The altitude had the highest gain when used in isolation meaning it had the most useful information by itself. Simultaneously, the land cover decreased the gain most when omitted; implying the land cover contained the information which the other variables did not contain. In relative term, these would mean the habitat suitability was much sensitive to both the altitude and the land cover type besides the other variable. The reason for this sensitivity is that slight changes in altitude could likely bring about significant changes in the micro-climatic conditions and in turn a change in suitability which will eventually result to a change in the spatial distribution of *Pan troglodytes ellioti* in the study area. The importances of the variables are expressed as gain in the jackknife diagrams. Figure 12 shows the jackknife of regularised training gain using all the variables.

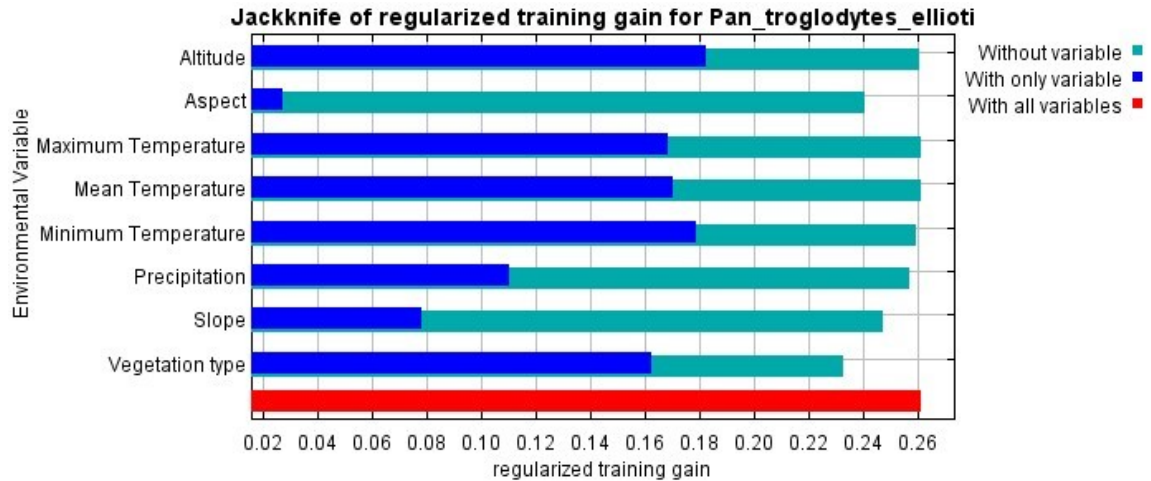

Figure 12: Jackknife of regularised training gain using all variables

## 4.2 Predicted habitat suitability based on current climate (1950-2000)

The selected key variables from the current climate dataset were input in to the model which was ran several times. From the predictions, four habitat suitability classes namely: *Most Suitable*, *Suitable*, *Less Suitable* and *Least Suitable* were distinguished. The “suitable class” was sandwiched between a pair of “less suitable” and “least suitable” classes on either sides. The suitable class lays at an altitude where the climatic conditions favour the physiological process of *Pan troglodytes ellioti* including other requirements for survival (Hutchinson 1957). The used variables and their percentage contributions as well as the jackknife of the regularised training gain and the predicted habitat suitability are shown in Table 7, Figures 13 and 14 respectively.

Variables	Percentage contribution
Minimum Temperature	54.1
Vegetation type	21.8
Altitude	11.6
Precipitation	7.5
Slope	5
Maximum temperature	0

Table 7: Variables and their percentage contribution

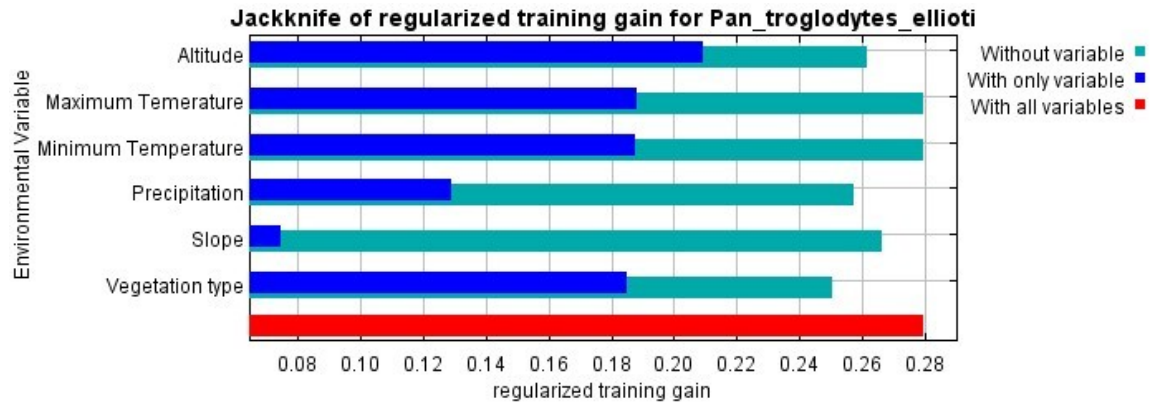

Figure 13: Jackknife of the regularised training gain under the current scenario

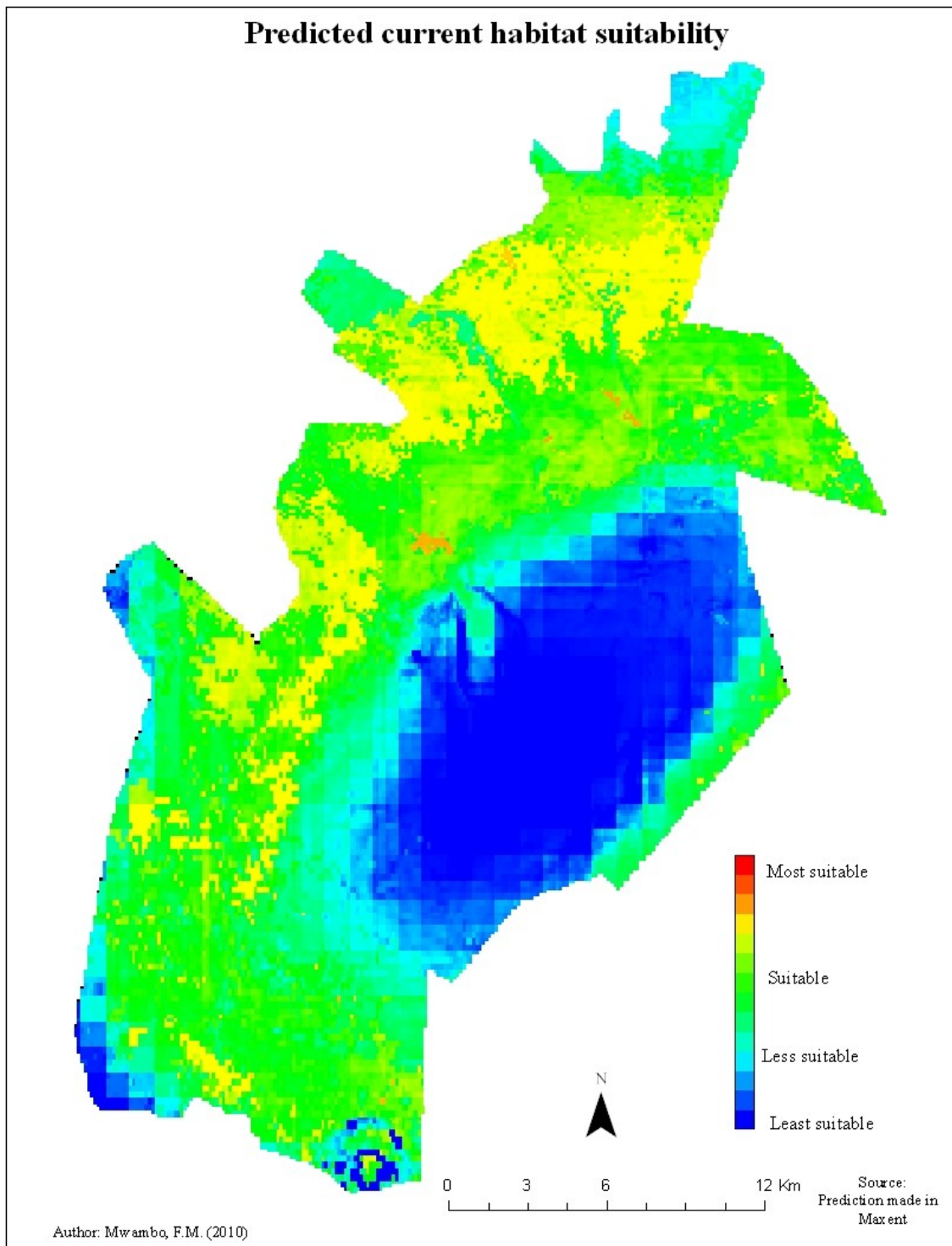

Figure 14: The habitat suitability based on the current climate scenario

### 4.3 Predicted habitat suitability based on future climate (2001-2050)

#### 4.3.1 Based on b2a modelled scenario

The same set of selected key variables from the b2a dataset was input in to the model. Predictions were made by running the model several times. The variables and their percentage contributions, the jackknife of regularised training gain and the predicted habitat suitability are shown on Table 8, Figures 15 and 17 respectively.

Variables	Percentage contribution
Altitude	64.8
Vegetation type	26.7
Slope	6.5
Precipitation	1.6
Maximum Temperature	0.4
Minimum Temperature	0

Table 8: Variables and their percentage contribution

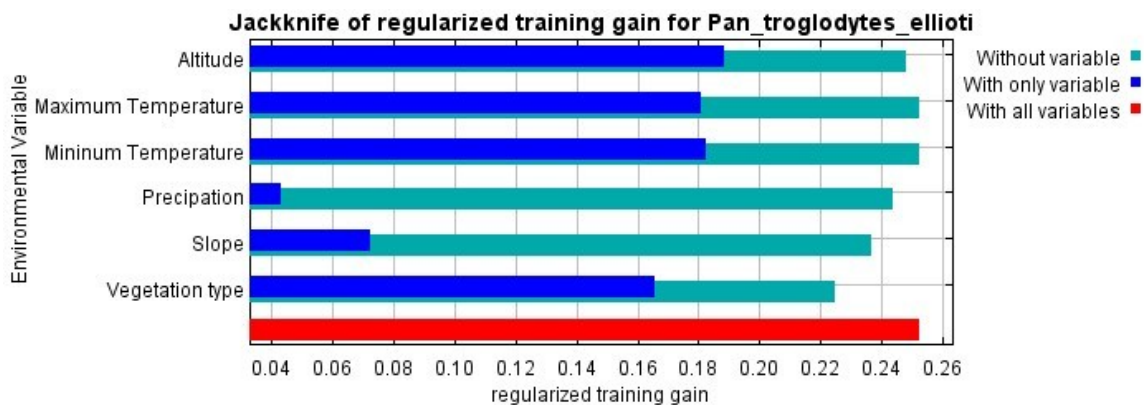

Figure 15: Jackknife of the regularised training gain under the b2a climate scenario

This scenario assumes the climate to remain relatively unchanged in the future. The general order of the habitat suitability is maintained. That is; the “suitable class” being sandwiched between a pair of “less suitable” and “least suitable” classes on either sides. But there is a relative shift in the suitability from lower altitudes to higher altitudes. This shift is a likely consequence of a change in the climate which causes an apparent ascend in the suitability. The phenomenon of a shifting suitability could be visualised from the increased yellow colouration which seems to cluster around the less and least suitable classes located at the summit as shown in Figure 17. Simultaneously, the less suitable and least suitable classes crowning the peak also shrink relatively to the current scenario

seen in Figure 14. The shift in suitability is a likely influence of a corresponding rise in the mean global temperatures. That is; in the future higher altitudes are likely to attain temperatures that can only be reached at lower altitudes under the current climate scenario. In the future, the shift in suitability may cause the *Pan troglodytes ellioti* in the study area to migrate towards the summit in order to re-encounter suitable habitats.

### 4.3.2 Based on a2a modelled scenario

The same set of selected key variables from the a2a dataset was input in to the model. The model was ran several times and the prediction under this scenario made. The variables and their percentage contributions, the jackknife of regularised training gain and the predicted habitat suitability are shown in Table 9, Figures 16 and 18 respectively.

Variables	Percentage contribution
Altitude	63.1
Vegetation type	20.4
Precipitation	11.4
Slope	4.8
Minimum Temperature	0.2
Maximum Temperature	0

Table 9: Variables and their percentage contribution



Figure 16: Jackknife of the regularised training gain under the a2a climate scenario

This scenario assumes the concentration of CO<sub>2</sub> in the atmosphere will double by 2050. Still both the general order of the habitat suitability is maintained and the shift is much greater as evident from the less and least suitable classes which shrink much further at the summit as shown in Figure 18. Furthermore, the peripheral less suitable class at

much lower altitudes increasingly become least suitable. For instance, the less suitable class at the extreme north of study area in Figure 14 becomes least suitable in Figure 18. Like under the b2a climate scenario, the likely increment in mean global temperatures resulting from increased concentration of GHGs brings about a shift in suitability which in turn causes the species to migrate towards the summit in the study area.

The apparent shift in suitability is due to the likely changes in precipitation levels and increases in temperatures with the changing climate as the global climate gets warmer. In other words, there is an apparent ascend in suitability from lower altitudes to higher altitudes with respect to climatic conditions of the current and future eras respectively. A reason for this observed trend is that the suitability is strongly influenced by altitude which determines the micro-climatic conditions at any given location. This means, the climatic conditions of temperature and precipitation which currently prevail in the suitable habitat range under the current scenario will likely be attainable only at much higher altitudes in the future. Since climate affects both the physiology of the species and availability of food and water supplies; in the future, species currently occupying the suitable habitat may likely undergo a migratory ascend towards the summit in order to encounter favourable climatic conditions that will be similar to those currently prevailing in the suitable habitat range under the current scenario. Table 10 summarises the predicted results for the different scenarios.

<b>Suitability classes</b>	<b>Current</b>	<b>B2A</b>	<b>A2A</b>
Most suitable	0.29	0.25	0.18
Suitable	67.41	67.11	67.06
Less suitable	6.06	6.34	6.37
Least suitable	26.24	26.30	26.39

Table 10: The summary statistics for the different scenarios



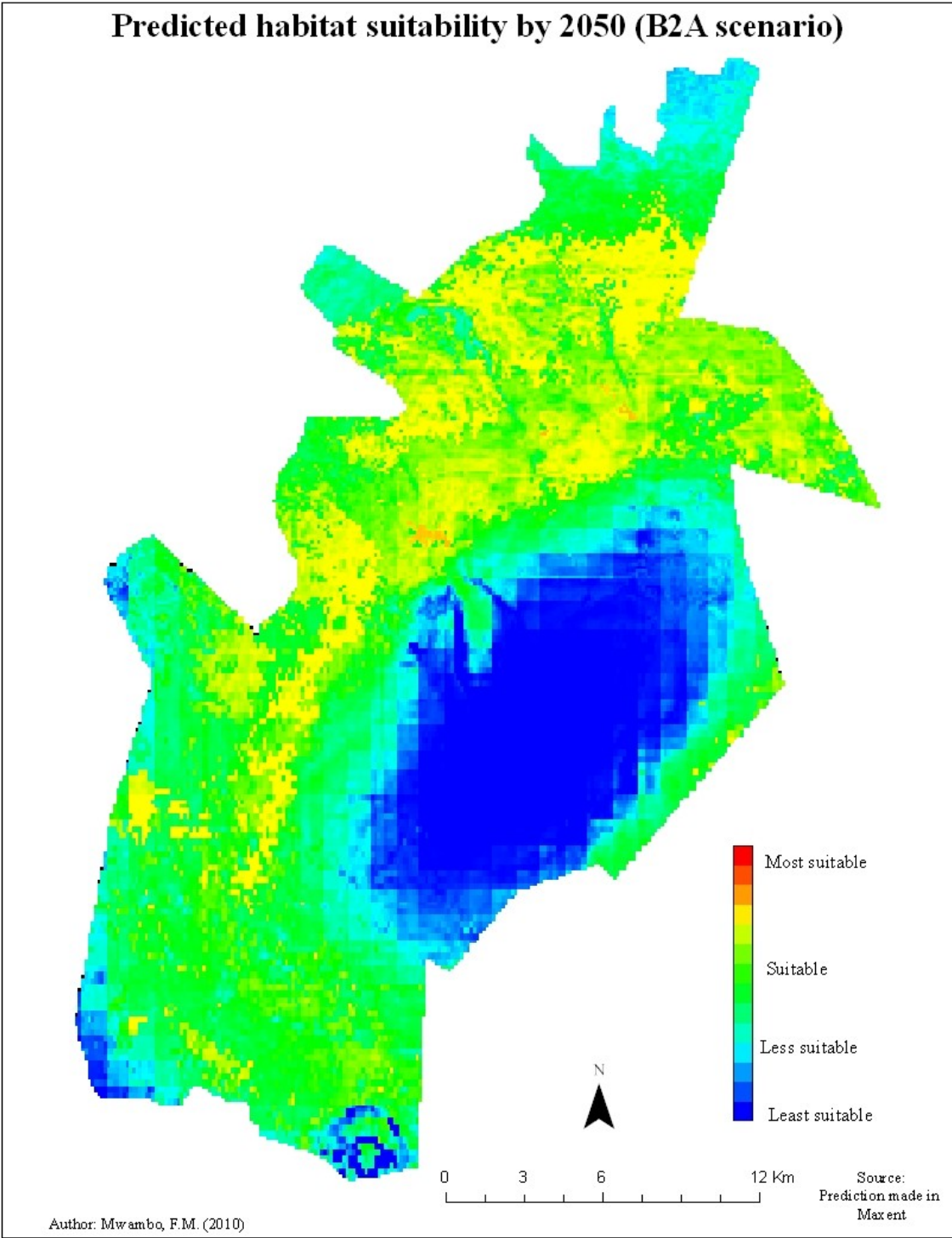

Figure 17: The habitat suitability based on the b2a climate scenario

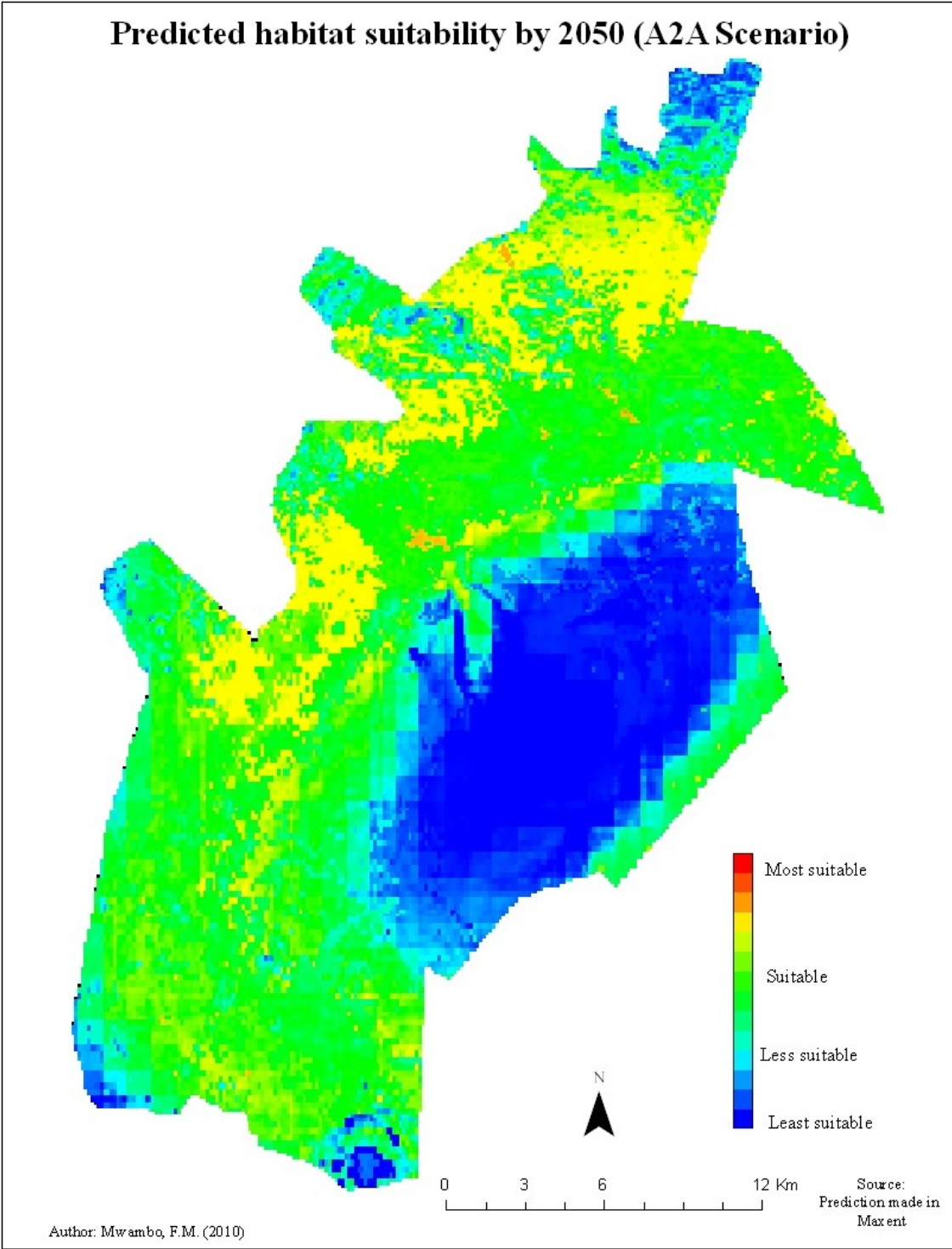

Figure 18: The habitat suitability based on the a2a climate scenario

Furthermore, in order to better visualise and understand the effects of climate change on the habitat suitability, maps showing where such predicted changes may occur as well as the apparent shift have been illustrated. Figures 19 and 20 show the predicted changes following the different climate change scenarios earlier discussed. The former depicts the likely changes that may occur where the current climate will follow a b2a scenario while the latter assumes an a2a scenario. The a2a scenario shows more changes compared to b2a and thus, greater risks and threats to biodiversity. The apparent shift in suitability has been illustrated using 35 points which were neither used in training nor testing the model, but related to the species presence were used. These points were overlaid on the predicted suitability maps. Under the current climate scenario, more than 85% of the points were found within the suitable habitat class. Under the future climate scenarios, the same points were used and the overlay repeated on the predicted suitability for both b2a and a2b scenarios. The results showed that the habitat suitability has apparently shifted towards the summit in both cases, thus, confirming the likely migration of species as suggested by MacArthur (1972) as an adaptive response of species to overcome a warming climate. The overlays on the predicted results are shown on Figures 21, 22 and 23 for the current, b2a and a2a climate scenarios respectively.

**Predicted changes in habitat suitability from Current to B2A scenario**

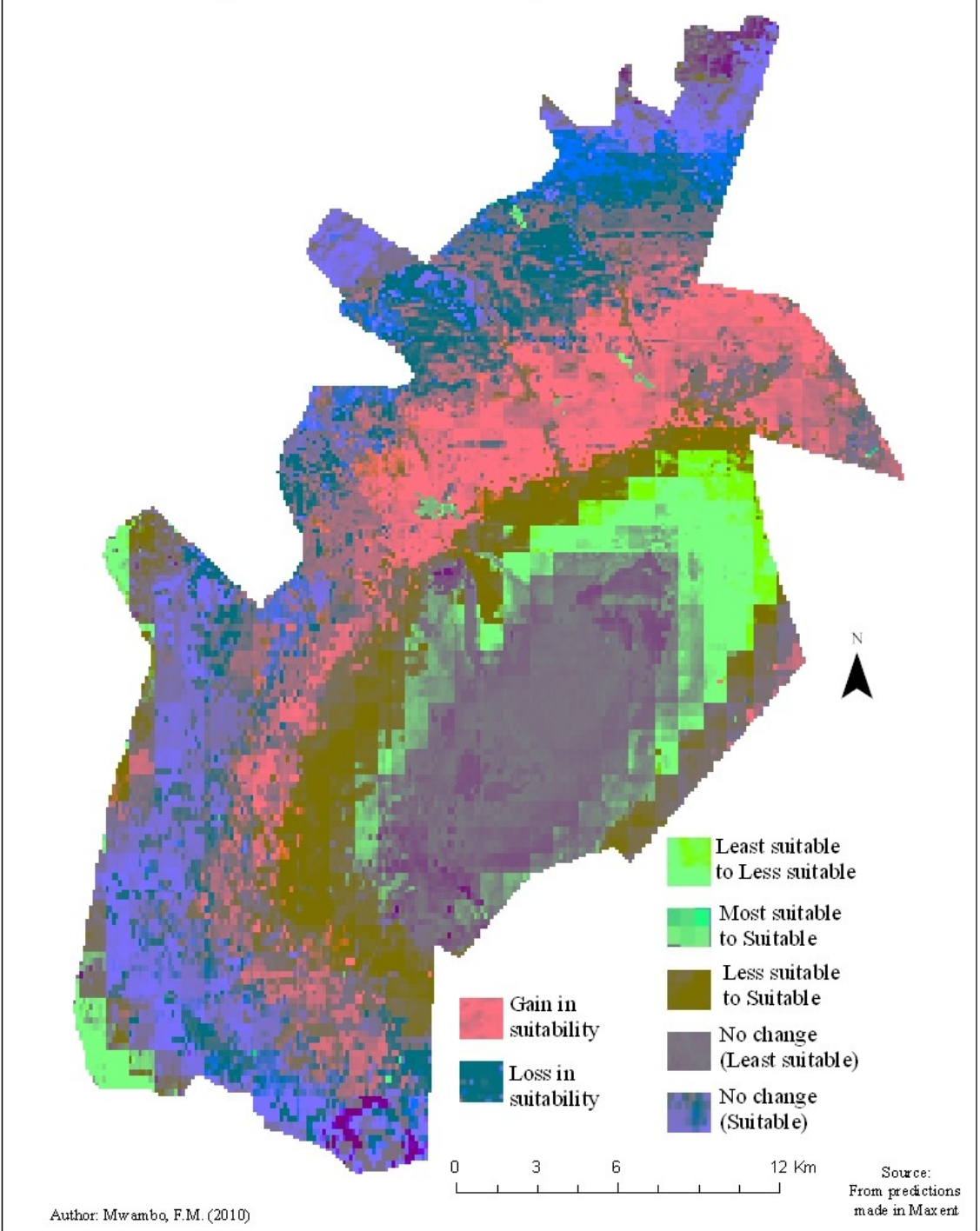

Figure 19: Predicted changes in suitability from current to b2a scenario

**Predicted changes in habitat suitability from Current to A2A scenario**

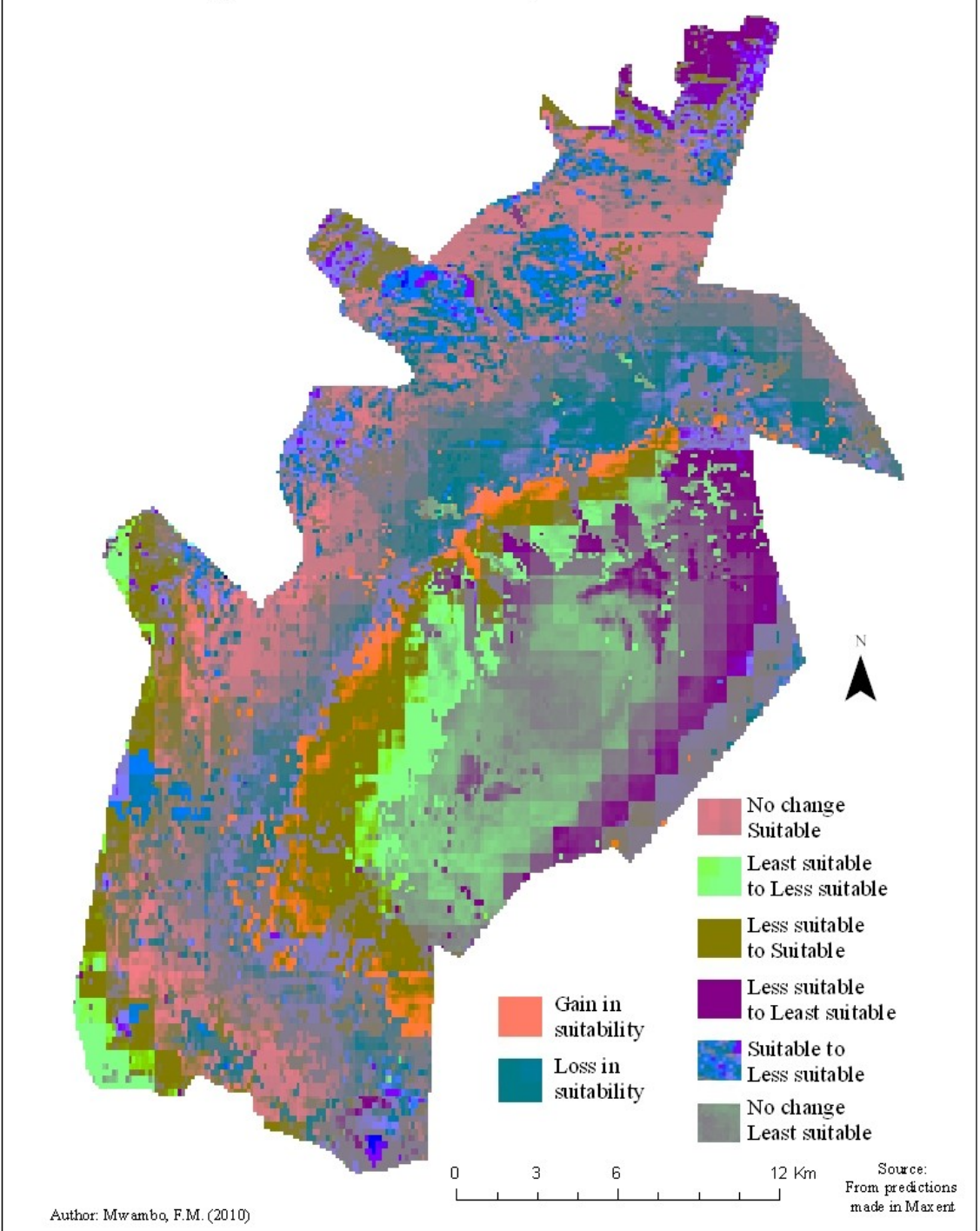

Figure 20: Predicted changes in suitability from current to a2a scenario

### Approximate locations of species on predicted current suitability

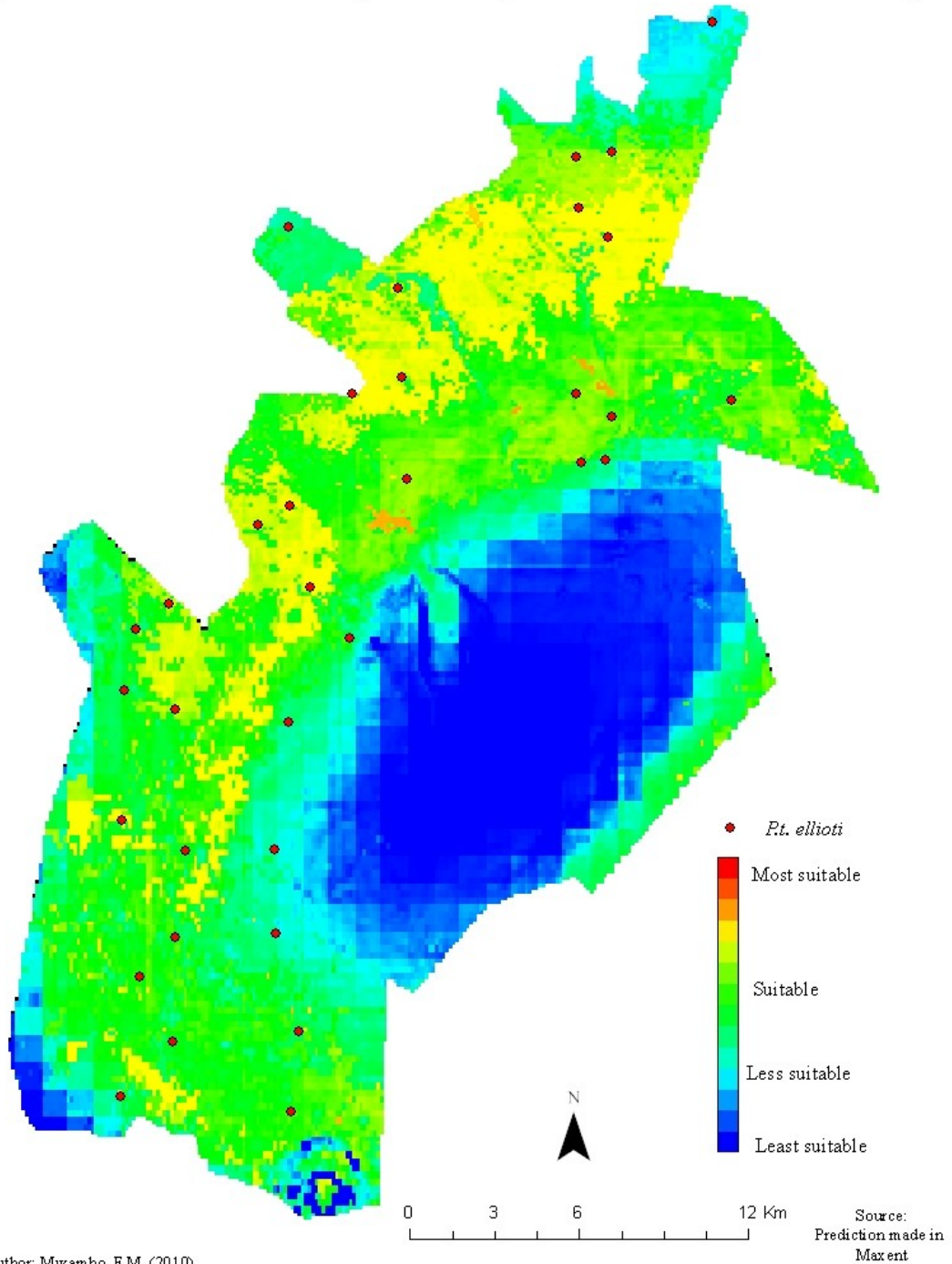

Figure 21: Overlay of points on predicted suitability under the current scenario

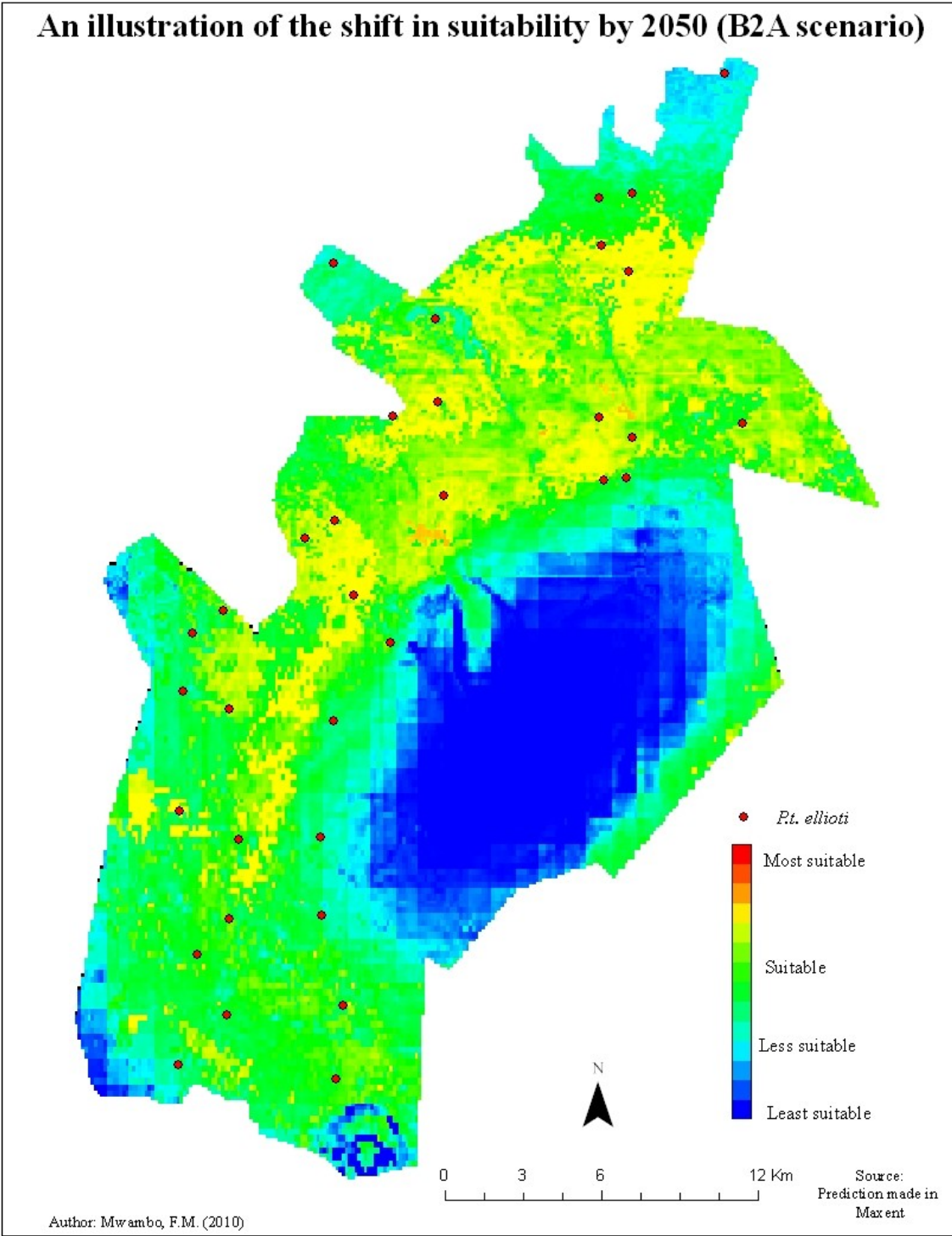
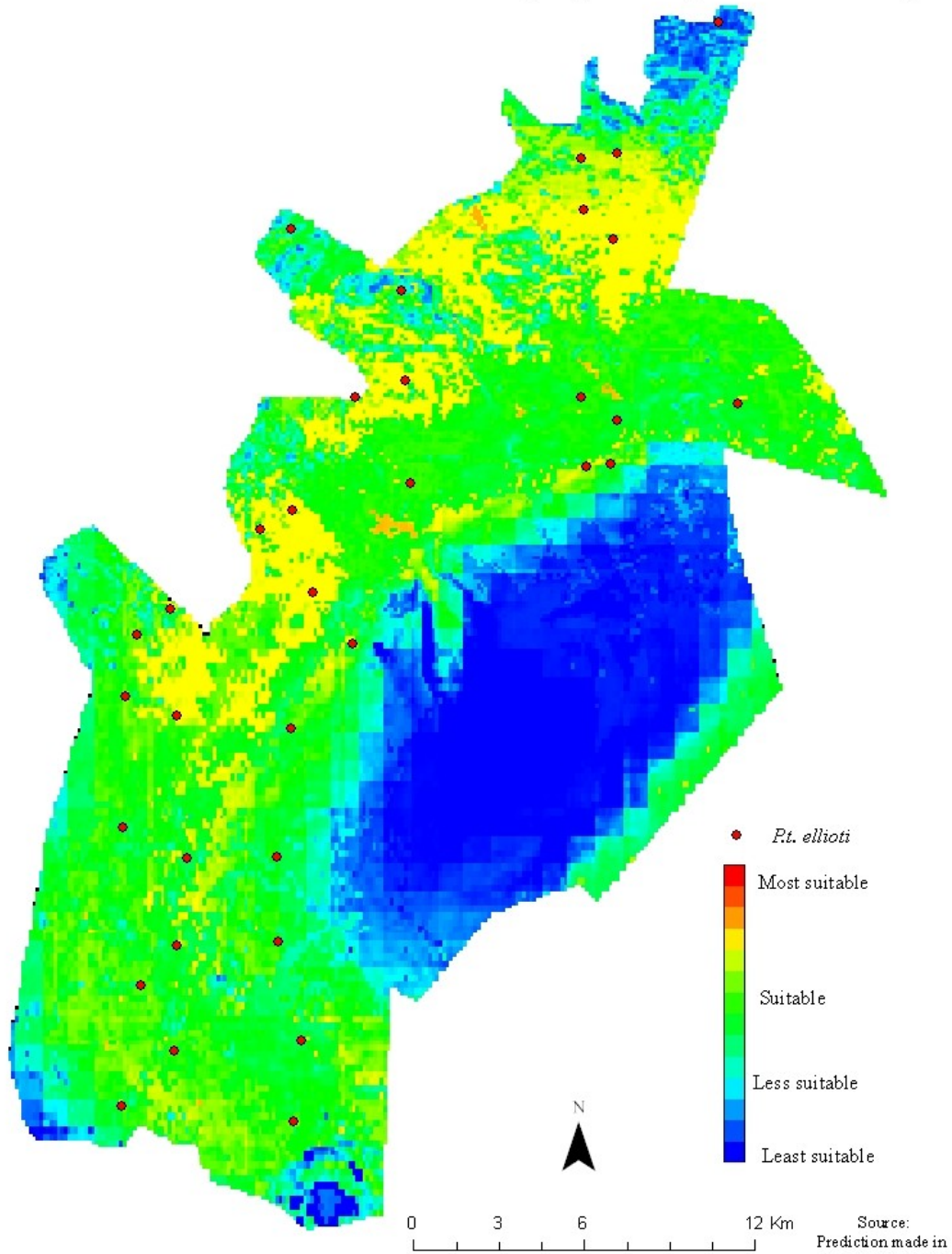

Figure 22: An illustration of shift in predicted suitability under the b2a scenario

**An illustration of the shift in suitability by 2050 (A2A Scenario)**



Author: Mwambo, F.M. (2010)

Figure 23: An illustration of shift in predicted suitability under the a2a scenario



#### 4.4 Accuracy assessment of predicted result

There are different methods for assessing the accuracy of such predictions (Skidmore 1999, Corsi *et al.*, 2000, de Leeuw *et al.*, 2002). The receiver operating characteristic (ROC) and the area under the curves (AUC) are fundamentally important in assessing the accuracy (Hanley and McNeil 1982). The ROC which is a plot of sensitivity (also referred to as 1-omission rate) against 1-specificity (also referred to as fractional predicted area) is typical of presence-absence modelling. Analogical to the absence is the background point in maxent (Phillip *et al.*, 2006). In this case, the AUC was developed based on the background data instead of the absence data. In our study, the achieved AUC are shown in Table 11. Following the AUC classification by Hosmer and Lemeshow (2000) and the maximum possible test AUC<sup>1</sup> gotten from the model, the predicted results approximate to the acceptable standards.

AUC	Current	Max. possible value <sup>1</sup>	B2A	Max. possible value <sup>1</sup>	A2A	Max. possible value <sup>1</sup>
Training	0.726	/	0.728	/	0.720	/
Testing	0.650	0.694	0.609	0.687	0.623	0.699

Table 11: Accuracy assessment of predicted results

#### 4.5 Modelled human activities

The local human activities have a direct impact on the habitat suitability and the general state of the park compared to global climatic changes which act relatively remotely. Figures 24 and 25 show these activities modelled as point features, though some may be extensive and are not limited to the point locations. The use of points depict the activities were locally recorded along transect lines which cut across these locations. Figures 24 and 25 show the local human activities modelled as points on the land cover and on the current habitat suitability respectively. Figure 24, shows the human activities being concentrated within the range currently suitable for the species. This overlap between the two puts the species in to greater vulnerability risks since human activities thins the forest and making it less appreciated by the species for a suitable habitat.

---

<sup>1</sup> In practice the test AUC in Maxent may exceed the stated maximum possible test AUC.

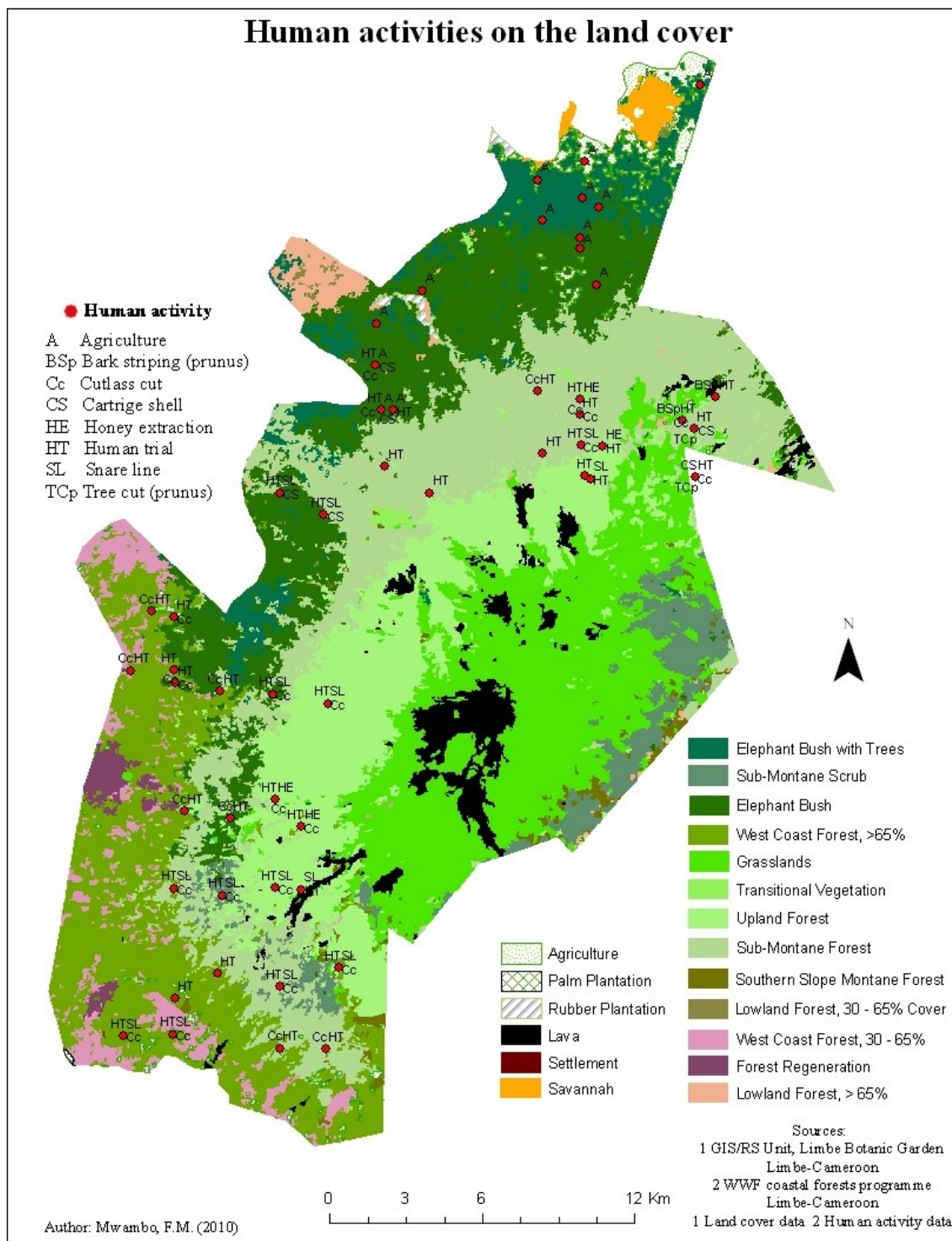

Figure 24: Local human activities modelled as points on the land cover

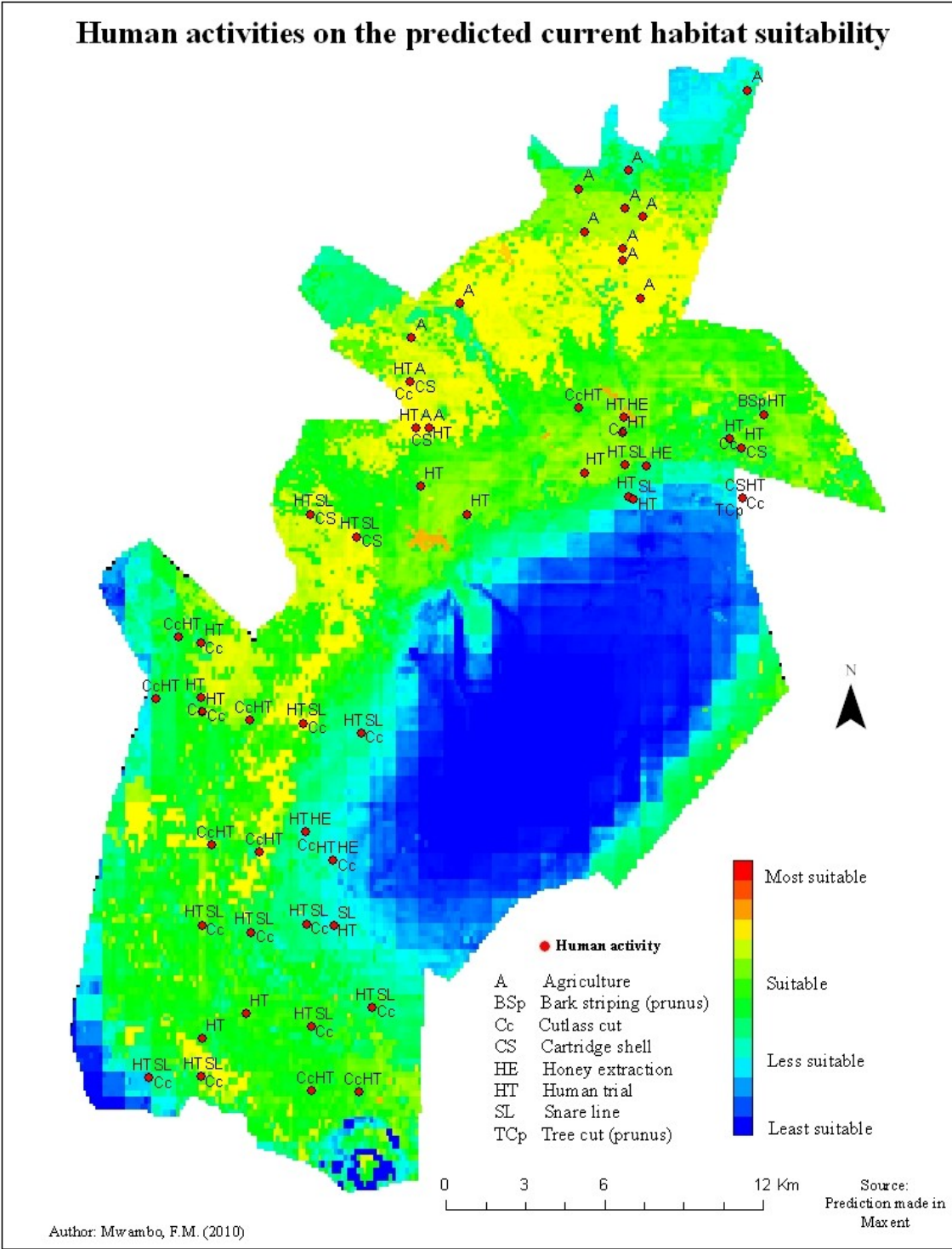

Figure 25: Local human activities modelled as points on the current suitability

## 5. CONCLUSIONS

### 5.1 Conclusions

*Pan troglodytes ellioti* is one of the several biological species which refuge in the proposed MCNP. Like many other species in tropical Africa, the survival of *Pan troglodytes ellioti* is threatened by pressure from both environmentally unsustainable human activities carried in and around the park along side the mean global climate changes which seemingly affect all of nature. Local anthropogenic activities have a direct impact compared to climate changes which act remotely on the habitat suitability for the species. However, the species' habitat suitability is interactively impacted by both direct and indirect threats and these call for concern from both national and international levels to ensure the species' survival in the future. Based on the research interest, the aim and objectives were fulfilled and satisfactory answers have been provided to the research questions earlier stated in section 1.3. Below is a validation of the hypotheses that were earlier raised in section 1.3.

- The predicted results made use of all the variables used in the model. However, the altitude was found to have the most useful information by it self while the land cover appeared to contain the information that was not present in the other variables. Thus, the variables had differing sensitivities on the habitat suitability. The altitude and land cover were the most sensitive to the habitat suitability. The null hypothesis was found to be false while the alternative hypothesis was found to be true.
- Four habitat suitability classes were distinguished with an approximate accuracy assessment of 0.7 and 0.6 under the current and future climate scenarios respectively. About 85% of the study area was found to be currently suitable for *Pan troglodytes ellioti*. The suitable habitat is sandwiched between the less and least suitable habitats which are located at very low and very high altitudes respectively. The null hypothesis was found to be false while the alternative hypothesis was found to be true.

- The suitable habitat for *Pan troglodytes ellioti* and areas on which human activities are carried both overlap in the study area. This overlap makes the species more vulnerable to greater threats and risks that may accelerate extinction. The null hypothesis was found to be false while the alternative hypothesis was found to be true.
- Climate change has an influence on the habitat suitability for *Pan troglodytes ellioti* in the study area. Climate change is likely to cause a shift in the suitability from lower altitudes to higher altitudes in the future. This shift may in turn force the species to migrate towards higher altitudes in the future. The null hypothesis was found to be false while the alternative hypothesis was found to be true.

On a general note, the results showed that besides the other environmental variables used in the model, the altitude plays a pivotal role on the habitat suitability for *Pan troglodytes ellioti* in the proposed MCNP. Also, there is an apparent shift in the suitability from lower altitudes to higher altitudes with the changing climate from current through the a2a and b2a scenarios of the future modelled climate. Local human activities are concentrated in the habitat range currently suitable for *Pan troglodytes ellioti* in the study area. This overlap puts the species' future survival in to greater vulnerability and risks of extinction since many human activities turn to comb the forest of its vital resources in the course of exploitation. Such human activities which are unsustainable with regards to nature and biodiversity conservation often leave the forest open. The upshot of such uncontrolled human activities will negatively impact the habitat suitability since many primate species do not appreciate open forests for habitats.

## **5.2 Limitations**

As a major limitation, the original DEM that was downloaded from GLCF had some elevation values missing. A greater portion of the crest of Mount Etinde and a few smaller patches were missing. Although the error was minimised during the data processing phase which has been briefly explained in section 3.1, the final results were slightly affected in the areas where these errors occurred. For instance; the crest of Mount Etinde (smaller isolated blue peak located on the south eastern part of the study area) appears to be suitable in Figure 14 but in actual terms is least suitable.

It is important to note that the predicted results are outputs from a model, in this case the maximum entropy species distribution (Maxent). The salient veracity about predictions got from models is that they all have a degree of uncertainty associated with them. In other words, the problem of uncertainty is ubiquitous with all models. As such we must be frank with the predicted results as having some uncertainties, thus, predictions would hardly have an accuracy assessment of 1 in any case. In this study, the predicted results under the future climate scenarios likely inherited a certain level of uncertainty from the modelled climate dataset that was used since the climatic conditions for the future are themselves predictions from the model developed by the CCCMA. Thus, accuracy assessments of 0.7 and 0.6 for the current conditions and future scenarios respectively can not be prodigious while bearing in mind that in maxent, the actual accuracies may exceed the stated values. Also, if the dataset on species presence could be increased that would lead to better training of the model and in turn better predictions. It is advisable to run the model as many times as possible while observing the trend in the predicted outputs in order to make meaningful predictions and conclusions.

## **5.3 Recommendations**

As recommendations; the survival of species in the future calls for concern from both the national and international communities; at least for bequest value. However, efforts from the national level are of utmost importance. The government of Cameroon through her related ministries could step up the protection of the MCNP in order to control the

indiscriminate exploitation of natural resources within the park. However, the use of law to stop the local peasant population from exploiting the local resources from the park upon which part of their livelihood depends may be hard to archive successfully due to economic hardship and level of literacy. A much sustainable option may be to adopt a participatory approach whereby individuals from the surrounding communities may be recruited as part of the labour force involved in the management of the park. It may also be worth for the State to provide the surrounding rural communities with basic social amenities. Such facilities may include primary healthcare, public capacity build institutions, improved communication network, pipe born water supply and electricity facilities (as the need may be). In this way, the local communities may cooperate with the State in managing the park since they receive some benefits in return to support their livelihood. Such measures by the government of Cameroon could better ensure sustainability both in terms of nature and biodiversity conservation while alleviating poverty from among her people.

At the international level, global efforts to curb on the emission levels of GHGs may contribute immensely to ensure not only *Pan troglodytes ellioti* in the proposed MCNP to flourish in an environmentally safe heaven but for all biological forms that inhabit on the globe.

## BIBLIOGRAPHIC REFERENCES

- Anderson, R. P., Lew, D. and Peterson, A. T. (2003): Evaluating predictive models of species' distributions: Criteria for selecting optimal models. *Ecological Modelling*, 162, 211-232.
- Araujo, M. B. et al. 2004. Would climate change drive species out of reserves? An assessment of existing reserve-selection methods. *Global Change Biol.* 10: 1618-1626.
- Araujo, M. B. and Williams, P. H. 2000. Selecting areas for species persistence using occurrence data. *Biol. Conserv.* 96: 331-345.
- Austin, M. P. (2002): Spatial prediction of species distribution: An interface between ecological theory and statistical modelling. *Ecological Modelling*, 157, 101-118.
- Austin, M. P. And Cunningham, R.B. (1981): Observational analysis of environmental gradients. *Proc. Ecological Society of Australia* 11: 109-119.
- Aubréville, A., (1949): *Climats, forêts et désertification de l'Afrique Tropicale*. Paris *Société d'Édition Géographique, Maritimes et Coloniales*.
- Barry, S. and Elith, J. (2006): Error and uncertainty in habitat models. *Journal of Applied Ecology* 43, pp 413 – 423.
- Beever, E.A., Pyke, D.A.; Chambers, J.C.; *et al.*, (2005): Monitoring temporal change in riparian vegetation of Great Basin National Park. *Western North American Naturalist* 65(3):382-402.
- Beever, E.; Brussard, P. and Berger, J. (2003): Patterns of apparent extirpation among isolated populations of pikas (*Ochotona princeps*) in the Great Basin. *Jour. Mammology* 84: 37-54.
- Benson, L.; Kashgarian, M.; Rye, R.; *et al.*, (2002): Holocene multidecadal and multicentennial droughts affecting Northern California and Nevada. *Quaternary Science Review*. 21, 659-682.
- Blumenbach, J. F. (1799): *D. J. F. Blumenbach's Handbuch der Naturgeschichte*. Sechste Auflage: Göttingen.



- Blumenbach, J. F. (1775): *De Generis Humani Varietate Nativa*. M D thesis, University of Göttingen, Germany.
- Bonnifille, R. and Riolet, G. (1988): The Kashiru pollen sequence (Burundi) palaeoclimatic implications for the last 40,000years B.P. in tropical Africa. *Quat. Res.* 30: 19-35.
- Booth, A.H. (1957) The Niger, the Volta and the Dahomey gap as geographic barriers. *Evolution* 12: 48-62
- Booth, A.H. (1954): The Dahomey gap and the mammalian fauna of West African forests. *Rev. Zool. Bot. Afr.* 50: 3-4
- Boubli, J. P. and de Lima, M. G. (2009): Modeling the geographical distribution and fundamental niches of *Cacajao* spp. and *Chiropotes israelita* in Northwestern Amazonia via a Maximum Entropy Algorithm. *Int. Journal of Primatol.* 30: 217–228
- Brown, J. H. and Lomolino, M. V. (1998): *Biogeography*. Sunderland, Massachusetts.
- Brown J.H., Mehlman, D.W. and Stevens, G.C. (1995): Spatial variation in abundance. *Ecology* 76: 2028-2043.
- Busby, J. R. 1991. BIOCLIM a bioclimate analysis and prediction system. In: Margules, C. R. and Austin, M. P. (eds), *Nature conservation: cost effective biological surveys and data analysis*. CSIRO, pp. 64-68.
- Butynski, T. M. (2003): The robust chimpanzee (*Pan troglodytes*) taxonomy, distribution, abundance and conservation status. In: *West African chimpanzee status survey and conservation action plan*. IUCN/SSC Primate Specialist Group, Gland, Switzerland, pp 5-12 Kormos, R., Boesch, C., Bakarr, M.I. and Butynski, T.M. (eds).
- Butynski, T. M. (2001). Africa's Great Apes. In Beck, B. B., Stoinski, T. S., Hutchins, M., Maple, T. L., Norton, B., Rowan, A., Stevens, E., and Arluke, A. (eds.), *Great apes and humans: The Ethics of Coexistence*, Smithsonian Institution Press, Washington, DC, pp. 3–56.
- Butynski, T. and Members of the Primate Specialist Group (2000). *Pan troglodytes* ssp. *vellerosus*. In: IUCN 2006. *2006 IUCN Red List of Threatened Species*.

- Cable, S. and Cheek, M. (1998): The plants of Mount Cameroon: a conservation checklist. Kew Publishing, 277pp.
- Cawsey, E. M., Austin, M. P. and Baker, B. L. (2002): Regional vegetation mapping in Australia: a case study in the practical use of statistical modeling. *Biodiversity Conservation* 11: 2239-2274.
- Chapman, C. A.; Lawes, M. J. and Eeley, H. A. C. (2006): What hope for the African primate diversity. (review), *Afr. J. Ecol.*, 44, 116–133
- Cheek, M., Radcliffe-Smith, A., Faruk, A. (2000): A new species of *Drypetes* (Euphorbiaceae) from Western Cameroon. *Kew Bulletin* 55:895-898
- CITES: Convention on International Trade in Endangered Species [online]. Available from <http://www.cites.org/eng/resources/species.html> [cited (January 2010)]
- Coetzee, J. A., (1964) Evidence of a considerable depression of the vegetation belt during the Upper Pleistocene in the East Africa Mountains. *Nature* 204: 564-566.
- Colyn, M., Guatier-Hion, A. and Verheyen, W. (1991): A re-appraisal of palaeoenvironmental history in Central Africa: evidence of a major fluvial refuge in the Zaire Basin. *Journal of Biogeography* 18: 403-407.
- Coolidge, H.J. (1933): *Pan paniscus*: pygmy chimpanzee from south of the Congo river. *American Journal of Physical Anthropology*, 18:1-59.
- Corsi, F., de Leeuw, J. and Skidmore, A.K. ,2000, Modelling species distribution with GIS. In: *Research techniques in animal ecology: controversies and consequences*/Biotani, L. and Fuller, T. K. (eds) 2000 Columbia University Press 2000 pp 389-434
- Cowlishaw, G. and Dunbar, R. (2000): *Primate conservation biology*. University of Chicago Press, Chicago.
- Cox, B.C. and Moore, P.D (1985): *Biogeography: An ecological and evolutionary approach*. Blackwell Scientific Publications, Oxford.
- Davis, M.B., and C. Zabinski. 1992. Changes in geographical range resulting from greenhouse warming effects on biodiversity in forests. Pages 298-308 in R.L. Peters and T.L. Lovejoy, eds. *Global warming and biological diversity*. Yale University Press, New Haven, CT

- de Leeuw, J et al. (2006): Comparing accuracy assessment to infer superiority of image classification methods. *Int. Jour. of Remote sensing* 27(1)
- de Leeuw, J., Ottichilo, W.K., Toxopeus, A.G. and Prins, H.H.T. (2002): Application of remote sensing and geographic information systems in wildlife mapping and modeling. In: *Environmental modeling and remote sensing*, Skidmore, A. (ed.) 2002 London, Taylor & Francis 2002 pp 121-145
- Dunbar, R. I. M. (1992a): A model of the gelada socio-ecological system. *Primates* 33: 69-83
- Dunbar, R. I. M. (1998): Impact of global warming on the distribution and survival of the gelada baboon: a modelling approach. Blackwell Science Ltd, *Global Change Biology* 4: 293-304
- Dudík, M., Phillips, S. J. and Schapire, R. E. (2004): Performance guarantees for regularized maximum entropy density estimation. *Proceedings of the 17th Annual Conference on Computational Learning Theory*
- Dupont, L. M. and Weinelt, M. (1996): Vegetation history of the savanna corridor between the Guinean and the Congolian rain forest during the last 15,000 years. *Vegetation History and Archaeobotany*. Springer Berlin/Heidelberg. Vol.5 No.4: 273-292.
- Eeley, H. and Lawes, M.J. (1999): Large-scale patterns of species richness and species range size in anthropoid primates. In: *Primate Communities* (Eds J. Fleagle, C. Janson and K. E. Reed). Cambridge University Press, Cambridge.
- Elith, J., Graham, C. H., Anderson, R. P., *et al.*, (2006): Novel methods improve prediction of species' distributions from occurrence data. *Ecography* 29: 129-151.
- Ferrier, S. *et al.*, 2002a. Extended statistical approaches to modelling spatial pattern in biodiversity: the north-east New South Wales experience. I. Species-level modelling. *Biodiv. Conserv.* 11: 2275-2307.
- Forbeseh, P.F.; Sunderland, T.C. H and Eno-Nku, M. (2007). Priority setting for conservation in south-west Cameroon based on large mammal surveys. *Oryx*, 41, 255-262.

- García Márquez, J. R. (2006): Multiscale assessment of the potential distribution of two herpetofaunal species. NRM. Enschede, ITC.
- Gaston, K.J. (1994): *Rarity*. Chapman & Hall, London.
- Gates, D.M. (1993): *Climate change and its biological consequences*. Sinauer, Sunderland, M.A.
- Giglioli, (1872): *Pan troglodytes schweinfurthii* on mammalian species of the world. Wilson, D.E. and Reeder, D. A. M(eds.) 2005. *Mammal species of the world. A taxonomic and geographic reference* (3<sup>rd</sup> ed).
- GLCF: Global Land Cover Facility. Available from <http://www.landcover.org/index.shtml> [cited (January 2010)]
- Gonder, M.K., Disotell, T.R., Oates, J.F. (2006): New genetic evidence on the evolution of chimpanzee populations and implications for taxonomy. *Int J Primatol* 27:1103–1127
- Gorilla Journal (1995): Men who Named the African Apes.[online]. Available <http://www.bergorilla.de/english/gjournal/texte/11men.html> from Available from [cited (January 2010)]
- Goldberg, T. L. (1996) Genetics and biogeography of East African chimpanzees (*Pan troglodytes schweinfurthii*) Ph.D Thesis, Harvard University Cambridge, Massachusetts. 287pp.
- Goolsby, J. A. 2004. Potential distribution of the invasive old world climbing, fern, *Lygodium microphyllum* in north and south America. *Nat. Areas J.* 24: 351-353.
- Gray, J.E., (1862): List of mammalian from the Cameroon Mountains, collected by Captain Burton, H.M. Consul, Fernando Po. *Proc Zoological Society of London* 1904: 180-181.
- Gray, J. E. (1825) "A list and description of some species of shells not taken notice of by Lamarck (continued)". *Annals of Philosophy* (2)9: 407-415.
- Guisan, A. and Zimmermman, N.E. (2000): Predictive habitat distribution models in ecology. *Ecological Modelling*, 135(2-3): 147-186
- Hamilton, A. (1976): The significance of patterns of distribution shown by forest plants

- and animals in tropical Africa for the reconstruction of the Upper Pleistocene palaeoenvironments: a review paleoecology of Africa 9: 63-97.
- Hannah, L., Midgley, G.F., Lovejoy, T., Bond, W.J., Bush, M., Lovett, J.C., Scott, D. & Woodward, F.L. (2002): Conservation of biodiversity in a changing climate. *Conserv. Biol.* 16: 264–268.
- Herkt, M. (2007): Modelling habitat suitability to predict the potential distribution of Erhard's Wall Lizard *Podarcis erhardii* on Crete. M.Sc. Thesis. Enschede, ITC
- Hernandez, P. A., Graham, C. H., Master, L. L. & Albert, D. L. (2006): The effect of sample size and species characteristics on performance of different species distribution modeling methods. *Ecography*, 29, 773-785.
- Hizel, A. H., La Lay, G. Helfer, V., Randin, C. and Guisan, A. (2006): Evaluating the ability of habitat suitability models to predict species presence. *Ecological Modelling* 199(2): 142-152
- Hirzel, A. H. and Guisan, A. (2002): Which is the optimal sampling strategy for habitat suitability modelling? *Ecological Modelling* 157: 331-341.
- Hizel, A. H., Helfer, V. and Metral, F. (2001): Assessing habitat suitability models with a virtual species. *Ecological Modelling* 145(2-3): 111-121.
- Hamburg, S.P. and C.V. Cogbill. 1988. Historical decline of red spruce populations and climatic warming. *Nature* 331:428-431.
- Hosmer, D. W. and Lemeshow, S. (2000): Applied logistic regression. 2<sup>nd</sup> edition. Wiley, New York.
- Hu, X.; Javadian, A.; Gagneux, P. and Robertson, B.H. (2001): Paired chimpanzee hepatitis B virus (ChHBV) and mtDNA sequences suggest different ChHBV genetic variants are found in geo-graphically distinct chimpanzee subspecies. *Virus Res* 79:103-108
- Hugall, A. et al. 2002. Reconciling paleodistribution models and comparative phylogeography in the Wet Tropics rain-forest land snail *Gnarosiphia bellendenkerensis* (Brazier 1875). *Proc. Natl. Acad. Sci. USA* 99: 6112-6117.
- Huijbregts, B.; de Wachter, P.; Obiang, L. S. N. and Akou, M. E. (2003). Ebola and the

- decline of gorilla *Gorilla gorilla gorilla* and chimpanzee *Pan troglodytes troglodytes* in Minkebe Forest, north-eastern Gabon. *Oryx* 37: 437–443.
- Hutchinson, G. E. (1957): Concluding remarks.
- IPCC: Intergovernmental Panel on Climate Change (2007): Climate change impacts, adaptation and vulnerability. Contribution to Work Group II to the Fourth assessment report of the Intergovernmental Panel on Climate Change: summary policy makers. IPCC-Geneva.
- IPCC Intergovernmental Panel on Climate Change (2007). Climate change 2007: The physical science basis. Summary for policy makers, fourth assessment report, work group I
- IPCC (1992): Climate change: the IPCC 1990 and 1992 assessments. World Meteorological Organization and the United Nations Environment Program, New York.
- IUCN (2009): IUCN Red List of Threatened Species. Version 2009.2
- IUCN (2008): 2008 IUCN Red List of Threatened Species.
- IUCN (2006): 2006 IUCN Red List of Threatened Species.
- Jones, P.D. and Moberg, A., (2003): Hemispheric and large-scale surface air temperature variations: an extensive revision and update to 2001. *Journal of climate* 16, 206-223 American Meteorological Society.
- Kattenberg, A.; Giorgi, F.; Grassl, H.; *et al.*, (1996): Climate models-projection of future climate. In: *Climate change 1995: The science of climate change* (eds. Houghton, J.F.; Meira Filho, L.G.; Callander, B.A; Harris, N.; Kattenberg, A. and Maskell, K.), pp 285-357. Cambridge University Press, Cambridge.
- Kauppi, P. and Posch, M. (1985): Sensitivity of boreal forests to possible climatic warming. *Climatic Change*, 7, 45 54.
- Kayijamahe, E. (2008): Spatial modelling of mountain gorillas (*Gorilla beringie beringie*) habitat suitability and human impact: Virunga Volcanoes Mountains, Rwanda, Uganda, and Democratic Republic of Congo. M.Sc. Thesis. Enschede, ITC
- Kelly, A. and Goulden, M. (2008): Rapid shifts in plant distribution with recent climate

- change. Proc. National Academy of Sciences 105:11823-11826.
- Kingdon, J. (1989): East African mammals. London, New York: Academic Press.
- Kumar, S. and Thomas J. Stohlgren, T.J. (2009): Maxent modeling for predicting suitable habitat for threatened and endangered tree *Canacomyrica monticola* in New Caledonia. Journal of Ecology and Natural Environment Vol. 1(4):094-098
- Læssøe, T. & Cheek, M. 2002. A new Xylaria (Xylariaceae, Ascomycota) from Cameroon. - Kew Bulletin 57: 687-691.
- LaMarche, V. (1973): Holocene climatic variations inferred from treeline fluctuations in the White Mountains, California. Quaternary Research 3:632-660.
- Lawes, M.J. and Eeley, H.A.C. (2000): Are local patterns of anthropoid primate diversity related to patterns of diversity at a larger scale? J. Biogeogr. 27:1421–1435.
- LBG (2002). Limbe Botanic Garden (Mount Cameroon Biodiversity Conservation Centre) under the 'control' of the Mount Cameroon Project: Mount Cameroon Vegetation Mapping Project Final Report, Final version 8 March 2002.
- Lenoir, J., Gegout, J., Margquet, P., *et al.*, (2008): A significant upward shift in plant species optimum elevation during the 20<sup>th</sup> century. Science 320:1768-1771.
- Leroy, E. M., Rouquet, P., Formenty, P., *et al.*, (2004). Multiple ebola virus transmission events and rapid decline of central African wildlife. Science 303: 387–390.
- Livingstone, D. A. (1975): Late Quaternary climate change in Africa. Ann. Rev. Ecol. Syst. 6: 249-280.
- Lovett, J.C., Midgley, G.F. and Barnard, P. (2005b): Climate change and ecology in Africa. Afr. J. Ecol. 43:167–169.
- Lovett, J.C., Barnard, P. and Midgley, G.F. (2005a): National climate change conference in South Africa. Afr. J. Ecol. 43:1–3.
- Lugina, K. M., Groisman, P. Ya., *et al.*, (2004): Monthly surface air temperature time series area-averaged over the 30-degree latitudinal belt of the globe, 1881-2003. In: Trends online: A compendium of data on global change. Carbon Dioxide

- information analysis center, Oak Ridge National Laboratory, U.S. Department of Energy, Oak Ridge, Tennessee, U.S.A.
- MacArthur, R. (1972): *Geographical Ecology*. Harper & Row, New York.
- Mac Nally, R. and Fleishman, E. 2004. A successful predictive model of species richness based on indicator species. *Conserv. Biol.* 18: 646-654.
- McClellan, C.J., Lovett, J.C., Kuper, W., *et al.*, (1992): Using mountane mammals to model extinction due to global change. *Conserv. Biol.* 6: 409-415
- Matschie, P., (1919) Neue Ergebnisse der Schimpansenforschung. *Z Ethnol* 51:62-82
- Matschie, P., (1914) Neue Affen aus Mittelafrrika. *Sitzungsber Ges Naturforsch Freunde Berlin* 1914: 323-342
- Maxent software for species habitat modeling. (Version 3.3.2) Available from <http://www.cs.princeton.edu/~schapire/maxent/> [cited (January 2010)]
- Mayewski, P., Rohling, E.; J. Stager, J.; *et al.*, (2004): Holocene climate variability. *Quaternary Research.* 62, 243-255.
- Melillo J. M., Houghton R. A, Kicklighter D. W, McGuire A. D (1996) Tropical deforestation and the global carbon budget. *Annual Review of Energy and the Environment* 21, 293-310.
- Millar, C.I. and Westfall, R.D. (2009): Distribution and climatic relationships of the American pika (*Ochotona princeps*) in the Sierra Nevada and Western Great Basin, USA; periglacial landforms as refugia in warming climates. (From version submitted to *Arctic, Antarctic, and Alpine Research*).
- MINEF-Cameroon (1996a): Ministry of Environment and Forestry, Cameroon Report
- Mittermeier, R. A., N. Meyers, P. R. Gil, and C. G. Mittermeier. (1999): Hotspots: Earth's biologically richest and most endangered ecoregions. Toppan Printing Co., Tokyo, Japan.
- Morgan, D., Sanz, C., Onononga, J.R. and Strindberg, S., (2006) Ape abundance and habitat use in the Goualougo Triangle, Republic of Congo. *International Journal of Primatology* vol.27 No.1 February 2006 pp. 147-179
- Myers, N. (2003): Biodiversity hotspots revisited. *BioScience*, Vol.53, No.10, 916–917.
- Myers, N., Mittermeier R.A., Mittermeier C.G., da Fonseca, G.A.B. and Kent, J., (2000).



- Biodiversity hotspots for conservation priorities. *Nature* 403: 853-858.
- Myers, N. (1990): The biodiversity challenge: Expanded hot spots analysis. *The Environmentalist* 10: 243–256.
- Myers, N. (1988) Threaten biotas: “Hotspots” in tropical forests. *The Environmentalist*. Springer Netherlands Vol.8 No.3 187-208.1-20
- Noack, T. 1887. Beiträge zur Kenntniss der Säugthier—Fauna von Ost- and Central-Afrika. *Zoologische Jahrbuch. Zeitschrift für Systematik, Geographie und Biologie der Thiere*, Jena 2:193–302.
- Oates, J. F., Groves, C. P. and Jenkins, P. D. (2009): The type localities of *Pan troglodytes vellerosus* (Gray, 1962), and the implications for the nomenclature of the West African chimpanzees. *Primates* 50:78-80
- Oates, J.F., Tutin, C.E.G., Humle, T., et al., (2008). *Pan troglodytes*. In: IUCN 2009. IUCN red list of threatened species. Version 2009.2
- Oates, J.F., Dunn, A., Greengrass, E. and Morgan, B.J. (2007). In: IUCN 2008. 2008 *IUCN Red List of Threatened Species*.
- Oates, J. F., (2006): Is the chimpanzee, *Pan troglodytes*, an endangered species? It depends on what “endangered” means. *Primates* Vol.47 No.1:102-112.
- Oates, J. F. (1996). African primates: Status survey and conservation action plan (rev. ed.). Gland, Switzerland: International Union for the Conservation of Nature and Natural Resources.
- Overpeck, J. T.; Bertli, P.J.; Webb, T. (1991): Potential magnitude of future vegetation change in eastern north America: comparison with the past. *Science* 254:692-695
- Parmesan, C. (2006): Ecological and evolutionary responses to climate change. *Annual review of Ecology and Systematics* 37: 637-669.
- Pastor, J., and W. M. Post. (1988): Response of northern forests to CO<sub>2</sub>-induced climate change. *Nature* 334:55-58.
- Peters, R.L. (1991): Consequences of global warming for biological diversity. In: *Global climate change and life on earth*. (ed. Wyman, R.L.), pp 99-118. Routledge/Chapman and Hall, New York.

- Peterson, A. T. 2003. Predicting the geography of species' invasions via ecological niche modeling. *Quart. Rev. Biol.* 78: 419-433.
- Pilbrow, V. (2006): Population systematics of chimpanzees using molar morphometrics. *Journ. Hum Evol* 51: 646-662
- Phillips, S. J., Anderson, R. P. and Schapire, R. E. (2006): Maximum entropy modeling of species geographic distributions. *Ecological Modelling*, 190, 231-259.
- Phillips, S. J., Dudik, M. and Schapire, R. E. (2004) A maximum entropy approach to species distribution modelling. In: *Proceedings of the 21<sup>st</sup> International Conference on Machine Learning*, Banff, Canada.
- Plumptre, A. J. (2000). Monitoring mammal populations with line transect techniques in African forests. *J. Appl. Ecol.* 37: 356–368.
- Purves, A.; Agapow, P.; Gittleman, J.L. and Mace, G.M. (2000): Non random extinction and the loss of evolutionary history. *Science* 288, 328–330.
- Roberts, P. (2003) *Tremella arachispora*: a new species from Mount Cameroon. *Kew Bulletin* 58: 763 – 764.
- Rosenzweig, C., 1989: Global climate change: Predictions and observations. *Amer. J. Agri. Econ.*, 71, no. 5, 1265-1271.
- Rosenzweig, C.E. and M. Parry, 1994: "Potential Impact of Climate Change on World Food Supply", *Nature*, 367: 133-138.
- Sarjent, N. E. (1988): Redistribution of the Canadian boreal forest under a warmed climate. *Climate Bulletin* 23: 23-34
- Sayer, J.A., Harcourt, C.S. and Mark Collins, N. (eds.) (1992). *The conservation atlas of tropical forests. Africa*. Simon & Schuster, New York.
- Schneider, S. and T. Root. (Editors) 2002. *Wildlife Responses to Climate Change: North American Case Studies*. Island Press, Washington D.C. 437 pp.
- Schwarz, E. (1934): On the local races of the chimpanzee. *Ann Mag Nat. Hist Ser* 10 13:576–583
- Scotts, D. and Drielsma, M. 2003. Developing landscape frameworks for regional conservation planning: an approach integrating fauna spatial distributions and ecological principles. *Pac. Conserv. Biol.* 8: 235-254.

- Skidmore, A. K. (1999): Accuracy assessment of spatial information. In: Spatial statistics for remote sensing. Stein, A., van de Meer, F. and Gorte Dodrecht B. (eds.) Kluwer Academic Publishers. Remote sensing and digital image processing 1 pp197-209
- Skidmore, A. K. (2002): Taxonomy of environmental models in spatial sciences. In : Environmental modelling with GIS and remote sensing. Skidmore, A.K (ed) London, Taylor & Francis 2002, pp 8-24.
- Skov, F. and Svenning, J. C. 2004. Potential impact of climatic change on the distribution of forest herbs in Europe. *Ecography* 27: 366-380.
- Skragsgs, R. W. and Boecklen, W. J. (1996): Extinction of montane mammals reconsidered: putting a global warming scenario on ice. *Biodiversity and conservation* 5: 759-778.
- Stiles, C.W. and Orleman, M.B. (1927): The nomenclature for man, the chimpanzee, the orangutan, and the Barbary ape. *Bulletin of the Hygienic Laboratory, U.S.Public Health Service (Washington, D.C.)* 145:160.
- Store, R. and Kangas, J., (2001): Integrating spatial multi-criteria evaluation and expert knowledge for GIS-based habitat suitability modelling. *Landscape and Urban Planning*, 55(2): 79-93
- Teleki, G. (1989). Population status of wild chimpanzees (*Pan troglodytes*) and threats to survival. In *Understanding Chimpanzees*, Harvard University Press, Cambridge, M.A. Heltne, P. and Marquardt, L. (eds.).
- Thornton, P.E., Running, S. W. and White, M. A. (1997): Generating surfaces of daily meteorological variables over large regions of complex terrain. *Journal of Hydrology* 190: 214-251.
- Turner, W. Spector, S., Gardiner, N., Fladeland, M., Sterling, E. and Sterninger, M. (2003): Remote sensing for biodiversity science and conservation. *Trends Evol.* 18: 306-314.
- Van Zinderen-Bakker, E. M. and Coetzee, J. A. (1972): A re-appraisal of late Quaternary of climatic evidence from tropical Africa. *Palaeoecology of Africa* 7: 151-181.

Walsh, P. D., Abernathy, K. A., Bermejo, M., *et al.*, (2003): Catastrophic ape decline in western equatorial Africa. *Nature* 422: 611–613.

White, F. (1983). The vegetation of Africa, a descriptive memoir to accompany the UNESCO/AETFAT/UNSO Vegetation Map of Africa (3 Plates, North western Africa, North eastern Africa, and Southern Africa, 1:5,000,000). UNESCO, Paris.

WorldClim: Global Climate Data. Available from <http://www.worldclim.org/> [cited (January 2010)]

## **APPENDICES**

# 1 Response curves

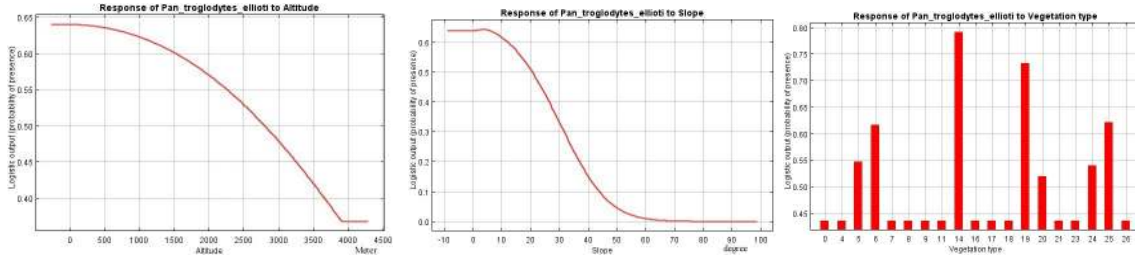

# 2 Tables

Land cover/use classification (LBG 2002)

Value	Definition	Definition
1	Water	Open water bodies.
2	Mudflats	Mudflats in mangroves, may include beaches.
3	Mangroves	Mangrove forests.
4	Grasslands.	Vegetated areas with grass as the dominant vegetative component.
5	Elephant Bush with Trees	Elephant Bush with at least 10 percent tree cover.
6	Elephant Bush	Elephant Bush with no trees or scattered trees (less than 10 percent cover)
7	Agriculture	Complex of agriculture with mixtures of settlements, grassland, savannah, and forest elements.
8	Palm Plantation	Industrial palm plantations.
9	Rubber Plantation	Industrial rubber plantation.
10	Banana Plantation	Industrial banana plantations.
11	Lava	Recent lava flows. May have significant amounts of grass.
12	Sub-Montane Scrub	Scrubby/Shrubby vegetation found at higher elevations of Mount Cameroon.
13	Urban	Built up areas, settlements, transportation features.
14	Transitional vegetation	Vegetation that has undergone disturbance and in a transitional process.
15		
16	Lowland Forest,30-65%	Forest not located on Mt. Cameroon slopes, discontinuous canopy.
17	Lowland Forest, > 65%	Forest not found on Mt. Cameroon slopes, continuous canopy.
18	Upland Forest	OR Montane Forest. Forests found on the upper slopes of Mt. Cameroon. No distinct elevational cutoff available.
19	Forest Regeneration	Forest that is going through regeneration.
20		
21	Sub-Montane Forest	Forest on the slopes of Mt. Cameroon located in zone between lowland and upland forest.
22	Southern Slope Montane Forest	Forest found on the upper slopes of the southern side of Mt. Cameroon.
23	Sub-Montane Scrub	Scrubby/Shrubby vegetation found at higher elevations of Mount Cameroon.
24	West Coast Forest, >65%	Forest found on the West slopes of Mt. Cameroon, continuous canopy.
25	West Coast Forest,30 -65%	Forest found on the western slopes of Mt. Cameroon, discontinuous canopy.
	Savahna	Scattered savannah areas in the Mt. Cameroon region.
	Swampy Forest	Inundated or partially inundated forest.

AUC classification by Hosmer and Lemeshow (2000)

AUC range	Description
= 0.5	No discrimination
0.7 < AUC < 0.8	acceptable
0.8 < AUC < 0.9	excellent
AUC > 0.9	outstanding