

| | |
|--------------|--|
| Title | Image Processing for On-Line Detection of Welding Process (Report I) : Simple Binary Image Processor and its Application(Welding Physics, Processes & Instruments) |
| Author(s) | Inoue, Katsunori |
| Citation | Transactions of JWRI. 8(2) P.169-P.174 |
| Issue Date | 1979-12 |
| Text Version | publisher |
| URL | http://hdl.handle.net/11094/6346 |
| DOI | |
| rights | 本文データはCiNiiから複製したものである |
| Note | |

Osaka University Knowledge Archive : OUKA

<https://ir.library.osaka-u.ac.jp/>

Osaka University

Image Processing for On-Line Detection of Welding Process (Report I)[†] – Simple Binary Image Processor and its Application –

Katsunori INOUE*

Abstract

The features of the visual information processing technique are examined from the viewpoint of the detection for the automatic control of welding process. The image processing method that is most suitable for these features is proposed. The image of the object is processed and converted into binary data by the processor. The necessary informations are extracted from these binary data. This processor is called as the BIP (the binary image processor). The hard- and software of the BIP system are shown with its block diagram and its flow chart respectively.

As an example of the practical application of the BIP, it is shown that the on-line detection of the weld line in butt welding can be successfully performed.

KEY WORDS: (Automatic Control) (Measurement) (Television) (Computers) (Guidance System)

1. Introduction

Various optical methods have been proposed for automatic control of fusion welding process.^{1)~30)} As more advanced optical method, we can mention the image processing technique, by which two or three dimensional visual informations are processed and necessary informations can be extracted on using digital computer system. The application of image processing technique to the practical production system has ever been studied vigorously in many countries and its level comes up to the considerable high stage. However, the practical application of this technique involves many problems to be solved, it is not progressed so much.

In this report, the several special features which yield when the image processing technique is applied to the on-line detection of welding process are examined. The image processing method that is most suitable for these features is proposed. The hard- and software of the proposed system are shown with its block diagram and its flow chart respectively.

An example of the practical application of this method is also shown. The detection of the butt weld joint of flat plate is performed with high accuracy and high speed.

2. Features of Image Processing on On-Line Detection of Welding Process

The features which yield when the image processing technique is applied to the on-line detection of welding process are as follows;

- 1) In many cases, the image of the object is not clear-cut in shape and unstable in time.
- 2) We must take a measure to diminish the effect of such noise as superimposed in the image itself and electrical one that is generated in the circuit of the hardware.
- 3) From a view of practical use, the shape of the object to be processed is considerably simple, and the so-called top-down approach is possible in many cases.
- 4) The processing time required for one frame of the image may be about 10 (ms) ~ 1 (s), judging from the proceeding rate of welding process.
- 5) It is desirable that the processing apparatus is simple, in-expensive and durable as much as possible.

As the most suitable image processing system for above mentioned items, the system described in the next chapter is proposed.

3. Image Processing System and Binary Image Processor

3.1 Outline of image processing system

The block diagram of the image processing system is shown in Fig. 1. The image of an object is taken by TV

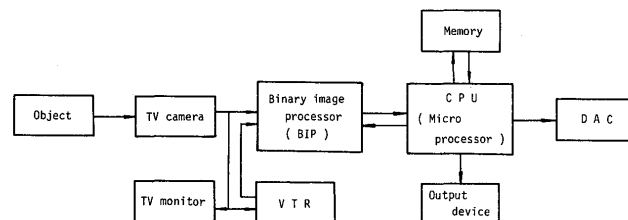

Fig. 1 Block diagram of image processing system.

[†] Received on September 17, 1979

* Professor

camera and recorded with VTR if necessary. The video signal of the image is processed with the binary image processor ; BIP which is controlled by the micro computer system and converted into binary data. The BIP is developed on taking the features described in the previous chapter into consideration and its detail is described in Section 2. The binary data are read with CPU (micro processor) and stored in memory. These data are read out again, processed in accordance with the preset program and required informations are extracted. These results are displayed with CRT, etc. or output as an analogue signal for automatic control.

3.2 Structure and behavior of BIP

The block diagram of the BIP is shown in Fig. 2

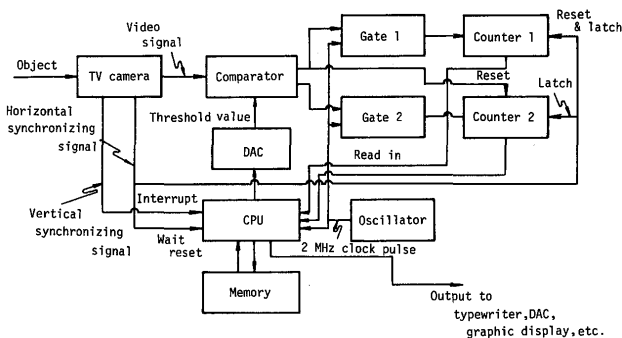

Fig. 2 Block diagram of binary image processor (BIP)

together with TV camera, CPU (micro processor i-8080) and memory. The BIP functions in two modes, that is data reading mode and data processing mode, and performs recognition of the shape of the object and extraction of the required informations from the binary image data. The each element in Fig. 2 is acted according to the instructions from CPU in the data reading mode. In the data processing mode, logic and arithmetic operations in CPU are main performance. The performance in the data reading mode is explained using Fig. 2 as follows;

The video signal corresponding to one horizontal scanning line of TV camera or VTR is converted with the comparator into a binary signal which has only two levels, high and low. The converted binary signal controls gate 1 and 2. The gate 1 and 2 are opened by the high and low level signal from the comparator respectively. (The reverse action is possible by the switch.) The clock pulse (2MHz) from the oscillator passes the opened gate and is counted with the counter 1 or 2. The counted value is latched by the horizontal synchronizing signal pulse (hssp), read in with CPU and stored in memory by the time the counted value of the next horizontal scanning is latched. The counter 1 is reset by the hssp immediately after

latching, the counter 2 is reset by the rising edge of the comparator output signal. Information of one frame of the image can be read and stored by repeating these actions to all the horizontal scanning. The vertical synchronizing signal acts as an interrupt signal for CPU, which prepares for reading the image data, such as setting the data store area, at the interrupt processing routine and returns to the main routine, where CPU outputs the wait request signal and becomes the "wait" state by itself stopping all the actions. The "wait" state is reset by the first horizontal synchronizing signal, CPU comes back again to the "run" state. In this manner, the action of video system such as TV camera and VTR is synchronized with that of CPU. The threshold value for binarization is output through DAC (digital-analogue converter) from CPU, where the threshold value can be controlled by the algorithm according to the preset program.

Usually, the data reading mode finishes after the image information of one frame has been taken in, the data processing mode begins. In this mode, the various processings of logic and arithmetic operations are given to the image data and the required informations are extracted. The results are output with such a device as a typewriter, a printer, a tape puncher and a graphic display, or as an analogue signal (in case of automatic control) through DAC.

3.3 An example of image data reading

An example of the algorithm for reading the image data of one frame is shown in Fig. 3 as a flow chart. At first, the necessary initial setting such as decision of the neglected area in the upper and lower parts of the picture frame, etc. are performed, then, CPU becomes the state of interrupt signal request. On arrival of the interrupt signal (the vertical synchronizing signal), the flow of the algorithm branches to the interrupt processing routine, where the threshold value for binarization, the top address of the data storing area, the required number of the data; N are set. After interrupt processing, the flow returns again to the main routine, where CPU outputs the wait state request signal at first and becomes the "wait" state by itself. This state is reset by the wait reset signal (the horizontal synchronizing signal), CPU begins to run again and reads the counted values of the counter 1 and 2 as B_I and D_I respectively which correspond to the bright and dark parts of the image of the object and stores them in the memory. These processes are repeated N times, then, the data reading mode finishes.

In the case of a bright object of arbitrary shape with dark background as shown in Fig. 4, the shape and the position of the bright part is defined by the values of B_I

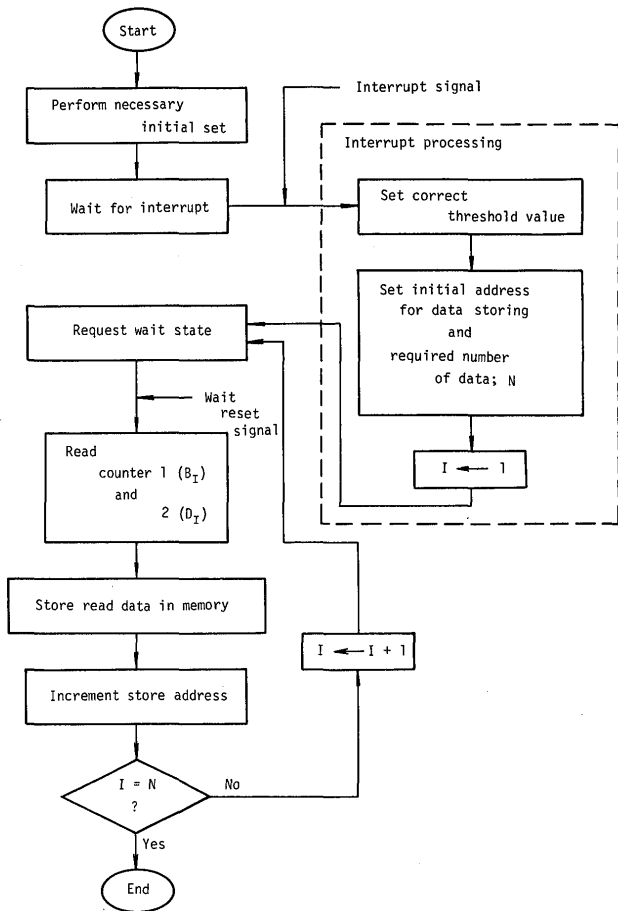

Fig. 3 Flow chart for reading one frame image data.

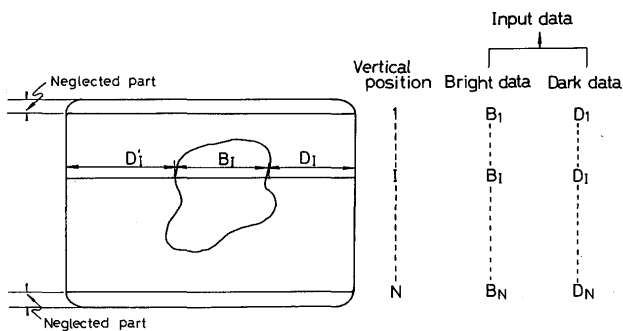

Fig. 4 Schematic explanation for reading image data.

and D_I ($I=1 \sim N$) in the figure.

However, on using this BIP, it is easily understood that the shape of the bright part must be so simple that the intersection of its outline and the horizontal scanning line is less than three. The upper and the lower parts of the picture are neglected as cut off parts because of their noisiness. As described previously, the relation of the bright and the dark parts can be reversed by switching in the hardware of this system. It is also possible to read D_I (see Fig. 4) instead of D_I . The resolution of the image in this processing method is $1/262$ in the vertical direction,

about $1/126$ in the horizontal direction respectively in case of using 2 : 1 interlacing type video system. (The resolution in the horizontal direction depends on the frequency of the oscillator in the BIP.)

4. An Example of On-Line Detection with BIP -- Weld Line Detection in Butt Welding

As an example of the application of the BIP system, the weld line detecting method in butt welding of flat plate is described as follows;

The situation is so severe that the gap of the joint is narrow and less than 0.5 (mm) as shown in Fig. 5(a), the tack weld parts exist in places on the weld line. The weld line detection method of an ordinary contact type, or, even if contactless type, but point detection type, can not be applied in this situation.

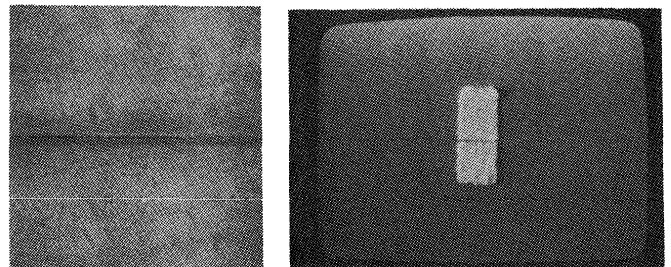

(a) View of butt weld joint (b) Rectangular spot light projected on weld line

Fig. 5 Test piece for butt weld joint detection

A new method is developed to overcome this situation.

In this method, as shown in Fig. 5(b), a rectangular spot light is projected on the weld line, which is detected as a dark line in the rectangular bright part with dark background. In this application, only the counter 1 of the BIP is utilized, because it is not necessary to know the shape and the position of the bright part, however, likewise in the other application, it is important to decide the threshold value for binarization precisely. The counted value B_I is plotted as abscisa against the vertical position I as ordinates in Fig. 6, where the plotted results shown clearly the pattern of the gap image as shown in a solid line if the threshold value is within the proper region, but the correct gap pattern can not be obtained if the threshold value is too high (a broken line), or, too low (a chain line).

The pattern of B_I s is changed in various ways due to rust, scale, flaw, smudge, discoloration by heat on the surface of the material and the deformation at the shearing in the actual weld material. An example is shown in

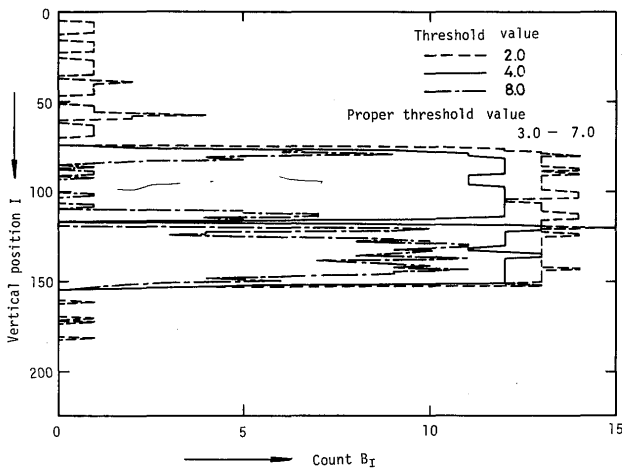

Fig. 6 Dependency of pattern of binary data on threshold value setting.

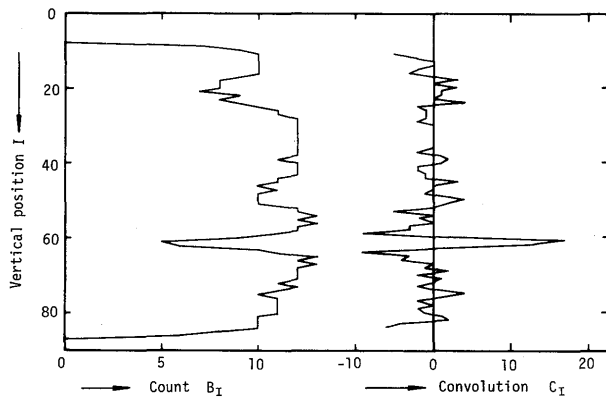

Fig. 7 Effect of digital filtering on binary image data.

Fig. 7, where the upper concave part of B_I graph (left side) is corresponding to smudge on the weld material surface. The digital filtering by the operation of one dimensional convolution expressed by Eq. (1) is made to the obtained B_I values to reduce these harmful influences.

$$C_I = 2(B_{I+2} + B_{I-2}) - (B_{I+1} + 2B_I + B_{I-1}) \dots (1)$$

As the result of filtering, the data showing the gap position are emphasized and S/N ratio for detecting it is improved as plotted in the right side of Fig. 7.

The transfer characteristic of digital filtering of Eq. (1) is expressed as the wave length - gain characteristic by Eq. (2)

$$|H(\lambda)| = 2 \left| 4 \cos \frac{2\pi}{\lambda} + 3 \right| \left(\cos \frac{2\pi}{\lambda} - 1 \right) \dots (2)$$

Where gain is represented by magnifying ratio $|H(\lambda)|$, wave length is represented by λ whose unit is a sampling distance in the vertical direction, therefore, a distance between adjacent scanning lines. The $\lambda - |H(\lambda)|$ curve

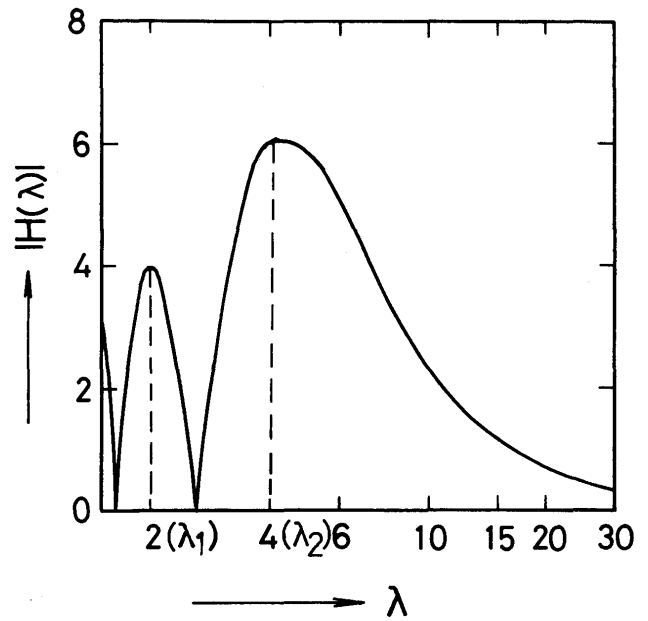

Fig. 8 Transfer characteristic of digital filter.

shown in Fig. 8 is obtained from Eq. (2). In Fig. 8, the wave length λ_1 of the minor peak corresponds to the rising and decaying slope of the B_I values which are caused by the gap image, and the wave length λ_2 of the major peak corresponds to the B_I values' changing pattern due to the whole image of the gap. Therefore, the information concerning the gap image is emphasized by digital filtering that follows Eq. (1).

The automatic weld line tracking is possible if the spot light is projected on the weld line which is preceding the welder whose torch installs the projector, the position of the gap in the spot lighted area is detected and the position of the torch is adjusted correctly.

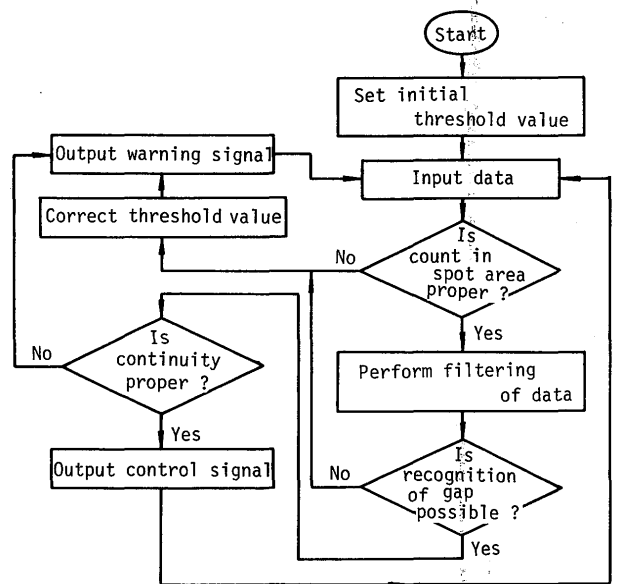

Fig. 9 Flow chart for real-time joint gap detection with BIP in butt welding.

The algorithm for performing this automatic tracking is shown in Fig. 9 as a flow chart, which is as follows;

At first, the initial threshold value is set immediately after the start, and then, the B_I data are input. The sum up value $\sum_{I=1}^N B_I$ for B_I is obtained and checked whether it is within the allowable limit or not. In the case beyond the limit, the threshold value is adjusted by following certain preset algorithm, the warning signal is output and the flow returns to the data input routine again. The warning signal expresses that the gap image, hence, the weld line can not be recognized. In the case the value $\sum_{I=1}^N B_I$ is within the limit, the flow advances to the next routine, where the input data are processed by filtering of Eq. (1). The filtered data are searched and checked whether the only one peak corresponding to the gap image exists or not. In case of passing the check, the gap position is determined from the peak position. The result of this determination is compared with the several past results stored in the memory and its continuity is checked. If abrupt change is noticed as to the determined gap position, the result is ignored as an error. In case the continuity is noticed, the relative position of the gap in the spot lighted area is obtained, its deviation is calculated and the control signal to the servo system is output to adjust the position of the welding torch, if necessary. If the remarkable peak is not found out or the plural peaks exist in the filtering result, it is judged that the weld line recognition is impossible and the flow also returns to the threshold value adjusting routine.

This algorithm is much resistive against various error factors and has high reliability, because it has many check routines which prevent it from generating misdetection.

As an example of processing by this algorithm, clarification of the gap position by adjusting the threshold value is shown. When the two peaks are recognized in the filtering result of the original data as shown in Fig. 10 left, the threshold value is adjusted, then, the data input and the filter processing are performed again following the flow chart. As the result, the data which correspond to

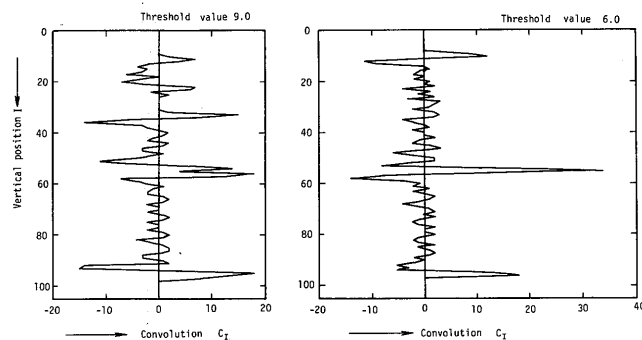

Fig. 10 Effect of threshold value adjustment on binary image of joint gap.

the gap image distinctly are obtained as shown in Fig. 10 right. The time required for this processing is about 60 (ms).

The weld line detection experiment by this method is performed with the butt weld test piece whose joint gap is less than 0.5 (mm), and on which the tack weld parts exist in places as shown in Fig. 11, and it is confirmed that the

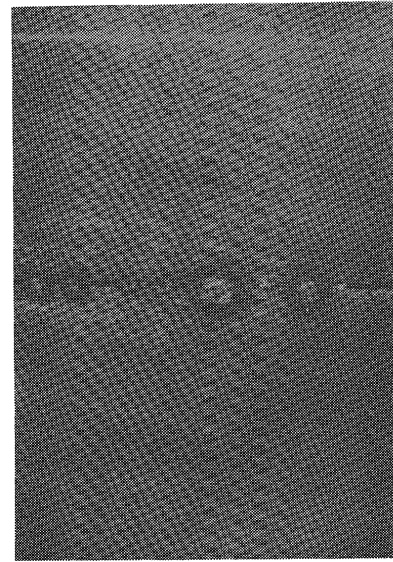

Fig. 11 View of tack weld on weld line in butt welding.

correct signal whose error is less than 0.2 (mm) is obtained every 70 (ms). It is the satisfactory result in practical usage.

5. Conclusion

This report is summarized as follows;

- (1) The features which yield when the image processing technique is applied to the on-line detection of welding process are examined.
- (2) The binary image processor (BIP) system which is most suitable for the above features is developed.
- (3) The structure and the performance of the BIP are explained about its hard- and software.
- (4) The BIP is applied to the weld line detection in butt welding. As the result, it is proved that this BIP has the necessary detecting ability and the sufficient practicality even under the disadvantageous condition.

References

- 1) Y. Arata and K. Inoue: Trans. JWRI, Vol.1 (1972), No.1, pp.99 - 113.
- 2) Y. Arata and K. Inoue: Trans. JWRI, Vol.2 (1973), No.1, pp.87 - 101.
- 3) Y. Arata and K. Inoue: Trans. JWRI, Vol.3 (1975), No.2, pp.101 - 104.
- 4) Y. Arata and K. Inoue: J. JWS, Vol.48 (1979), No.7, pp.55 - 60.
- 5) Y. Arata and K. Inoue: J. JWS, Vol.48 (1979), No.9,
- 6) R.M. Shirokovskii, Yu.A. Pachentsev and V.M. Shchigal'skii: Auto. Weld., Vol.20 (1967), No.9, pp.55 - 58.
- 7) V.K. Isachenko: Weld. Prod., Vol.15 (1968), No.4, pp.23 - 25.
- 8) L.V.Shergov, V.N. Kryukovskii and F.V. Voronin: Weld. Prod., Vol.16 (1969), No.16, pp.47 - 50.
- 9) W.A. Wall and D.L. Stephens: W. J., Vol.48 (1969), No.9, pp.713 - 720.
- 10) I.V. Shergov, F.V. Voronin and M.M. Sherlyagina: Auto. Weld. Vol.22 (1969), No.6, pp.69 - 72.
- 11) A.A. Solntsev and I.I. Efimov: Weld. Prod., Vol.16 (1969), No.5, pp.50 - 52.
- 12) G.A. Vorontsov: Weld. Prod., Vol.17 (1970), No.2, pp.28 - 31.
- 13) K.M. Demchenko, et al.: Weld. Prod., Vol.17 (1970), No.2, pp.31 - 33.
- 14) Ya.S. Vaisband, A.B. Voitsekovskii and A.P. Zhurishkin: Auto. Weld., Vol.24 (1971), No.7, pp.47 - 51.
- 15) O.K. Nazarenko, et al.: Auto. Weld., Vol.24 (1971), No.7, pp.51 - 52.
- 16) A.P. Igoshin, et al.: Weld. Prod., Vol.19 (1972), No.4, pp.21 - 25.
- 17) R.K. Snee and J.L. Taylor: Metal, Construction and British Welding Journal, Vol.4 (1972), No.4, pp.142 - 148.
- 18) D.D. Nikiforov, et al.: Weld. Prod., Vol.19 (1972), No.9, pp.29 - 31.
- 19) D.D. Nikiforov, et al.: Weld. Prod., Vol.20 (1973), No.5, pp.45 - 48.
- 20) A.A. Balatskii, V.P. Igumnov and M.S. Baranov: Weld. Prod., Vol.20 (1973), No.12, pp.29 - 30.
- 21) I.V. Shergov and F.V. Voronin: Auto. Weld., Vol.27 (1974), No.1, pp.49 - 53.
- 22) C.K. Dedkov and V.S. Popenko: Weld. Prod., Vol.21 (1974), No.6, pp.87 - 88.
- 23) H.W. Mishler and R.E. Monroe: Welding in the World, Vol. 12 (1974), No.7/8, pp.183 - 192.
- 24) V.K. Lebedev, Yu.A. Pachentsev and E.S. Ddragomiretskii: Auto. Weld., Vol.28 (1975), No.2, pp.18 - 20.
- 25) N.L. Burlinov, et al.: Weld. Prod., Vol.22 (1975), No.3, pp.26 - 28.
- 26) A.R. Vroman and H. Brandt: W.J., Vol.55 (1976), No.9, pp.742 - 749.
- 27) V.N. Lushpai, V.A. Timchenko, V.B. Bogdanovich and E.A. Kaganovich: Auto. Weld., Vol.29 (1976), No.4, pp.41 - 44.
- 28) V.M. Nesterenkov and S.N. Kobvasenko: Auto. Weld., Vol.29 (1976), No.12, pp.38 - 39.
- 29) E.I. Romanenkoy, et al.: Weld. Prod., Vol. 23 (1976), No. 9, pp.53 - 54.
- 30) V.A. Timchenko, et al.: Auto. Weld., Vol.30 (1977), No.9, pp.37 - 41.