



UNIVERSITY OF LEEDS

This is a repository copy of *Impact of Ambient Temperatures on Exhaust Thermal Characteristics during Cold Start for Real World SI Car Urban Driving Tests*.

White Rose Research Online URL for this paper:
<http://eprints.whiterose.ac.uk/2041/>

Proceedings Paper:

Li, H, Andrews, GE, Zhu, G et al. (4 more authors) (2005) Impact of Ambient Temperatures on Exhaust Thermal Characteristics during Cold Start for Real World SI Car Urban Driving Tests. In: Engineers, SOA, (ed.) SAE Proceedings: Powertrain and Fluid Systems Conference and Exhibition. SAE Proceedings: Powertrain and Fluid Systems Conference and Exhibition, 3-6 October 2005 Society of Automotive Engineers , USA . ISBN 0-7680-1652-5

SAE Paper # 2005-01-3896

Reuse

Unless indicated otherwise, fulltext items are protected by copyright with all rights reserved. The copyright exception in section 29 of the Copyright, Designs and Patents Act 1988 allows the making of a single copy solely for the purpose of non-commercial research or private study within the limits of fair dealing. The publisher or other rights-holder may allow further reproduction and re-use of this version - refer to the White Rose Research Online record for this item. Where records identify the publisher as the copyright holder, users can verify any specific terms of use on the publisher's website.

Takedown

If you consider content in White Rose Research Online to be in breach of UK law, please notify us by emailing eprints@whiterose.ac.uk including the URL of the record and the reason for the withdrawal request.



eprints@whiterose.ac.uk
<https://eprints.whiterose.ac.uk/>

Impact of Ambient Temperatures on Exhaust Thermal Characteristics during Cold Start for Real World SI Car Urban Driving Tests

Hu Li, Gordon E Andrews, Grant Zhu, Basil Daham
Margaret Bell, James Tate and Karl Ropkins
The University of Leeds

Copyright © 2005 SAE International

ABSTRACT

Thermal characteristics of SI engine exhaust during cold start and warm up period were investigated for different ambient temperatures (-2 to 32 °C). A Euro 1 emission compliance SI car was tested using a real world urban driving cycle to represent typical city driving patterns and simulate ECE15 urban driving cycle. The test car was equipped with 27 thermocouples along the engine and exhaust pipes so as to measure metal and exhaust gas temperatures along the engine, exhaust and catalyst. The characteristics of thermal properties of engine, exhaust system and catalyst were studied as a function of warm up time and ambient temperature. The temperature and time of the light-off of catalyst were investigated so as to evaluate the effect of thermal properties of the catalyst on emissions.

The results show that the coolant water reached the full warm up about 5 minutes in summer and 9 minutes in winter after a cold start. Lubricating oil reached the full warm up in 10 minutes in summer and 14 minutes in winter after a cold start. The light-off time of TWC was about 3 minutes in summer and 6 minutes in winter in terms of catalyst substrate temperatures. The determination of catalyst light off has been studied and discussed in terms of catalyst substrate temperatures and gas temperatures. The ambient temperature had little influence on engine out exhaust gas temperatures. The heat loss from the engine out to the catalyst was at highest level in the first 5~6 minutes and after this point the heat available at the catalyst was relatively stable.

The thermal properties of the engine and exhaust system had significant influence on emissions. The results indicate that in some urban driving conditions such as short journeys in cities especially under cold weather conditions, the function of catalysts for emission reductions is very limited.

INTRODUCTION

It is well known that a SI engine in cold conditions has much higher exhaust emissions than one that is fully warmed up (1-8). The new European passenger car emissions regulations has removed the first 40 seconds of idle period for the ECE driving cycle, in recognition of the importance of the cold start emissions. The new regulations also include -7°C tests for HC and CO emissions at cold start. It has to be addressed that Euro 1 cars were not developed to pass this cold test since developed prior to new -7°C regulation, and yet Euro 1 cars do cold starts at low temperatures in the real world. Extensive research had been undertaken in the past to investigate the influence of ambient temperature on exhaust emissions (2-8), normally using legislated test cycles and CVS test procedures. It was found that exhaust emissions could be drastically increased, relative to 25°C, at cold ambient conditions. For instance, the hydrocarbon emissions were found increase by 650% at -20°C and carbon monoxide emissions by 800% (8).

A satisfactory cold start is very difficult to achieve at sub-zero ambient temperature conditions in terms of the

balance between drivability, emissions and fuel consumptions, especially when the vehicle is cold soaked overnight, as was done in the present work. The -7°C ECE test regulations do not allow the use of block heaters that are common in very cold climates. These are very effective and show that it is not the air temperature that is the main problem. The cold soak makes the oil, water, all metal surfaces and catalysts cold and it is the thermal energy required to heat these that is the main problem in cold starts (9-14).

Heat loss between the engine out and before the catalyst will determine the energy gain of the catalyst thus affect the temperature rise of the catalyst so as to have a critical impact on catalyst light off time. For a given vehicle driving on a certain cycle, ambient temperatures will have significant influence on engine warm up rate. It is the objective of this paper that impact of ambient temperatures on warm up rate of engine coolant, exhaust system and light off of the catalyst are determined using a real world test cycle. The output of this work can be used for modeling of real world cold start emission predictions.

A low ambient temperature reduces lubricating oil pumpability and increases the viscosity of lubricating oil (15-20). This results in higher mechanical losses and hence higher fuel consumption for an engine under cold start (15-21). The fuel vaporization at the inlet port injection location is deteriorated due to the poor volatility of fuel at low ambient temperatures. The lower the ambient temperature, the richer the air fuel mixture that is required for a start up. The rich air fuel mixture results in incomplete combustion with excess fuel and thus increases carbon monoxide and hydrocarbon emissions, together with a further increase in the fuel consumption. The low ambient temperature also delays the light off of the catalyst, which is one of the most important reasons for high emissions at cold start.

Engine management settings have remarkable influences on emissions under different ambient temperatures. Spark timing and fueling play an important role on deciding the temperature and composition of the exhaust gases. In order to achieve a good drivability for cold start under cold ambient temperatures, considerable fuel enrichment (lower air/fuel ratio) and appropriate ignition retard are necessary. These will however increase HC and CO emissions; though retarded spark timing can raise the exhaust temperatures which will be beneficial for the light-off of the catalyst. The cold ambient temperatures can also extend the duration of open loop phase for the Lambda sensor.

The most convenient way to investigate the impact of the cold start and ambient temperature on exhaust thermal properties and emissions is to use an engine dynamometer test under specialized cold enclosure facilities. However, there are some limits for this sort of test, as they cannot represent the whole vehicle

response to cold start, including gearbox and cold tyre effects. Therefore, attention has been directed in this work on real world on road test in winter to complement dynamometer and CVS cold start tests (15). This work uses the variation of ambient temperature through the year to enable real world engine exhaust thermal properties for the same urban drive cycle to be determined as a function of ambient temperature.

A Euro 1 vehicle was used as they are a still a significant proportion of the UK vehicle fleet and hence major contributors to air pollution in cities. Future work will investigate Euro 2, 3 and 4 vehicles. It takes about 16 years for 90% of vehicles sold in any one year to be no longer in use (1) and this period is becoming longer for modern vehicles. Thus the work on Euro 1 vehicles has significance in terms of their current use in city driving and hence their impact on air quality. It will be at least 2013 before 90% of Euro 1 vehicles are not a significant proportion of city traffic. This work on Euro 1 vehicles will also be the basis for future work on the influence of ambient temperature and vehicles that meet subsequent lower emissions standards.

EXPERIMENTAL

TEST VEHICLE – A Ford Orion petrol car was used, fitted with a port fuel injected 1.8 litre Zetec spark ignition engine with DOHC 4 cylinders 16 valves. The car was instrumented with 27 thermocouples which measured the air inlet, engine cooling and lubricating oil temperatures. In addition the exhaust metal, gas and catalysts temperatures as well as the ambient temperature were also measured. All temperature measurements used grounded junction mineral insulated Type K thermocouples with a diameter of 1.45 mm.

Table 1 identifies the thermocouples by number location and function. These numbers are used in the graphical presentation of the warm-up temperature results in real-world driving. Figure 1 shows the schematic view of the thermocouple locations on the test car and Figure 2 shows the outline of the data logging system that was used. The total scan number was 480 during the 16 minutes of each test period, which was equivalent to one scan every two seconds. A Brantz International 2S Speed and Trip meter was used to measure vehicle's travel speed and distance, which was connected to a Daqbook/200 data logger along with all 28 thermocouples. The data logger was then connected to a Toshiba notebook PC.

Table 1 Thermocouple locations and functions

The number of thermocouple	The measuring target
1,2,3,4	Engine out gas temperatures from each cylinder.
5M,6M,7M,8M	Metal temperatures at four different locations on the manifold to monitor overall thermal profile on manifold
9, 10	Coolant water in and out from the engine
11W,12W,13W	Upstream TWC face temp. on left, right and centre positions.
14G,15G,16G	Gas temperature at the upstream (14), between the two catalyst bricks (15) and downstream of the TWC (16).
17W,18W,19W	Downstream TWC face temp. on left, right and centre positions
20,21	Engine oil in sump bottom (20) and dipstick top layer (21)
22M,23M,24M	Metal temperatures along the down-pipe
25G,26G,27G	Gas temperatures along the down-pipe
28 (not shown in graph)	Ambient temperature

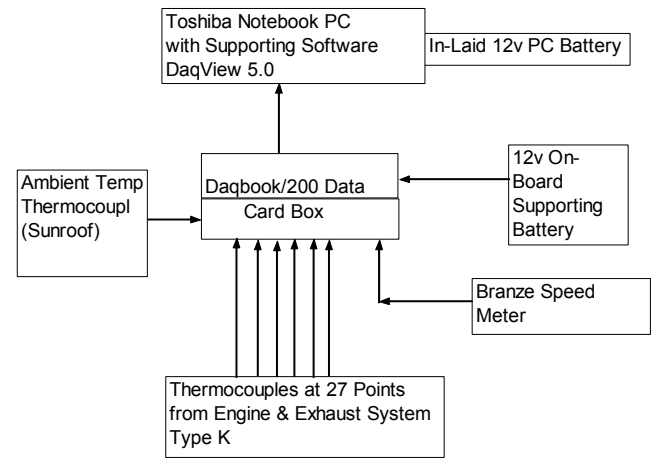

Figure 2 On-board thermal data logging system

TEST ROUTE AND CYCLE – An urban driving cycle was designed and coded as LU-UDTC – The Leeds University Urban Driving Test Cycle. Figure 3 shows the route of the test cycle. Leeds metropolitan district has a high population density of around 1,300/km² and there is a network of roads with many 90° turns and the test street circuit in Figure 3 is typical of congested urban street layouts. The car was started from the authors' engine dynamometer laboratory, which is close to a public road. The car was parked outside the laboratory and cold soaked in the open overnight.

The cold start bag sample was started at the same time as the car by switching the sample pump on immediately after successful ignition of the engine had been achieved; the cranking phase of the cold start was not sampled which was about 1~2 seconds. This is as close as possible to the new Euro 3 test procedures as could be achieved in real world cold start driving. The vehicle was first driven about 70m to the public road, where it was then driven around the street test circuit shown in Figure 3. This had a down hill and uphill portion in the top left part of the circuit in Figure 4, the rest of the circuit was flat. There were seven 90° turns in the circuit; five of them left hand turns.

At the end of each lap of the 1.45 km test circuit the vehicle was stopped in a car park and the sample bags were changed. Then the circuit was repeated. The first cold-start circuit was thus slightly different to the other three circuits. The main road to the right of Figure 3 was a very busy major road with one the highest traffic densities for an urban road in the UK. However, the traffic densities on the test circuit were much lower and the repeatability of each lap was not greatly influenced by differences in traffic loads.

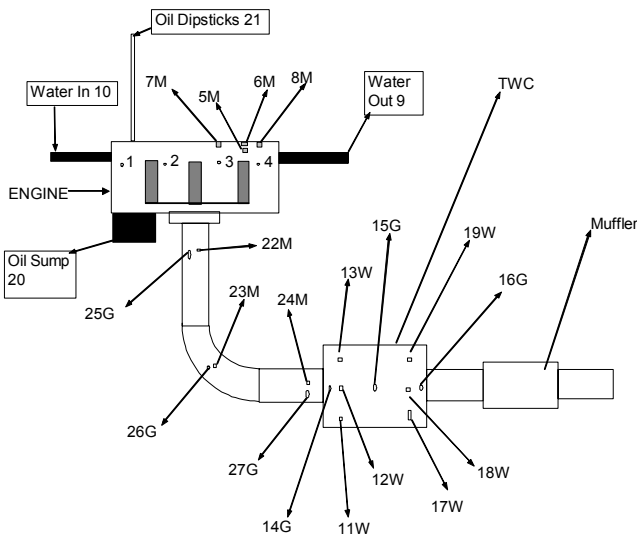

Figure 1 Schematic view of thermocouple locations on engine and exhaust system

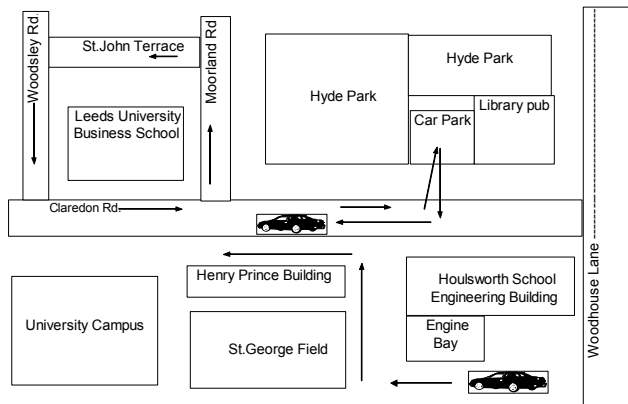

Figure 3 Driving route of LU-UDTC

The urban street test cycle was aimed at the simulation of the ECE15 urban driving cycle. Figure 4 shows the typical road speed profile of the test cycle driving mode in comparison with the ECE15 mode. This shows that the urban test circuit was very close to the ECE urban test cycle in terms of the duration of each lap and the peak speed. Each of the four laps of the urban street test circuit was regarded as one phase of the test, similar to the four phases of the ECE test cycle. The first phase was under cold start conditions, as in the ECE urban test cycle.

The distance traveled for each lap was 1.45 km, giving a total distance for the four laps of 5.8 km. It involved 18~21 gear changes for each lap, depending on the traffic conditions. The speed limit on these urban streets was 48 km/hr (30 mph) and the peak speed never exceeded this, as shown in Figure 4. Each section of the route involved acceleration from a 90° corner turn up to a peak speed close to the speed limit and then a deceleration to the next corner. Six or seven deceleration and acceleration modes were involved in each lap of the route. There were also short periods of idling between the laps due to traffic and changing the sampling bags.

Figure 5 shows the accelerations and decelerations of LU-UDTC in comparison with ECE15 cycle. The Leeds University Urban Driving Test Cycle has more frequent and sharper accelerations and decelerations than that in ECE15 cycle, indicating that the ECE15 cycle is less severe than real world driving cycle.

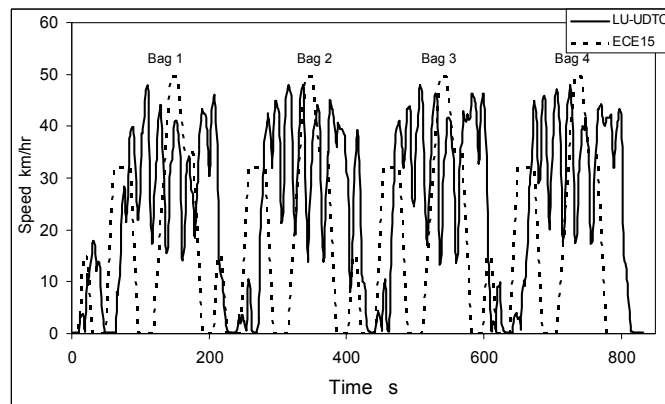

Figure 4 Typical road speed profile of LU-UDTC cycle

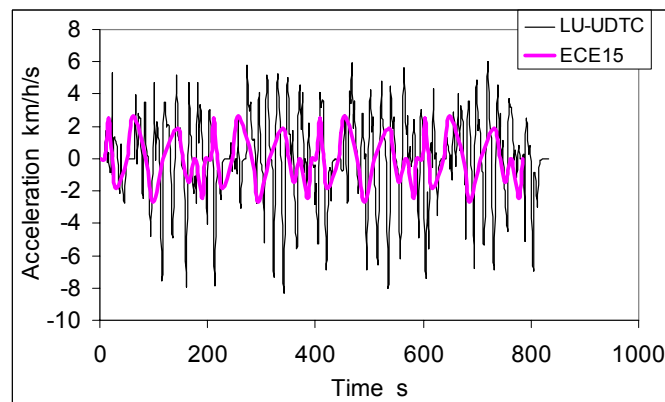

Figure 5 Comparison of accelerations and decelerations between LU-UDTC and ECE15 test cycles

WARM-UP OF THE ENGINE COOLANT AND LUBRICANT

The engine out cold start emissions are influenced by the thermal inertia of the engine and engine cold start strategy such as spark timing, fuel injection system and air/fuel ratio enrichment. For a given engine, influence of cold start on engine out emissions is mainly due to the thermal inertia of the engine, water and lubricating oil systems (9–12). The cold start influence on the catalyst performance is mainly due to the thermal inertia of the exhaust manifold, the downpipe and the underfloor catalyst. It was therefore important in this real world urban driving study of the influence of ambient temperature on cold start thermal characteristics and emissions, that the temperatures of the key engine and exhaust temperatures were recorded.

Two sets of typical results are presented below to show the comparison of engine and exhaust system between winter and summer. The coldest (-2°C) in winter and hottest (31°C) in summer ambient temperature test results are compared.

Figures 6-8 show the comparison of the warm up rate between winter and summer for the coolant water and engine lubricating oil. The results show that for LU-UDTC cycle in summer time the coolant water

temperature reached the fully warmed-up value, when the thermostatic control valve opened, after five and a half minutes. This was about three and a half minutes earlier than that in winter. The lubricating oil temperature reached the full warmed-up value in ten minutes in summer, six minutes earlier than that in winter. The full warm up of the water was taken as when the temperature of the water outlet from the engine reached 88°C and the thermostatic valve opened. This caused the temperature to decrease as the cold water in the radiator was added to the cooling water circulation.

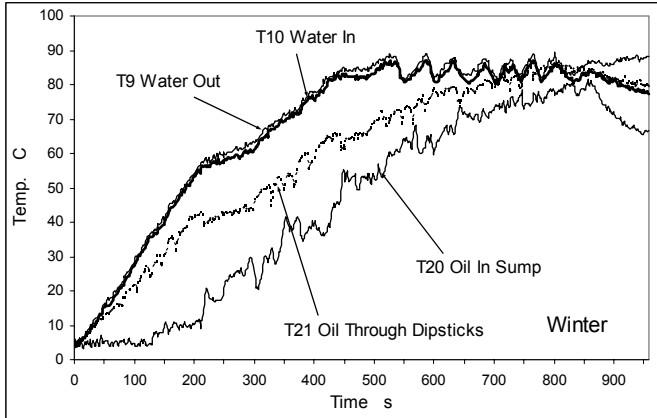

Figure 6 warm up of water and lube oil at -2°C

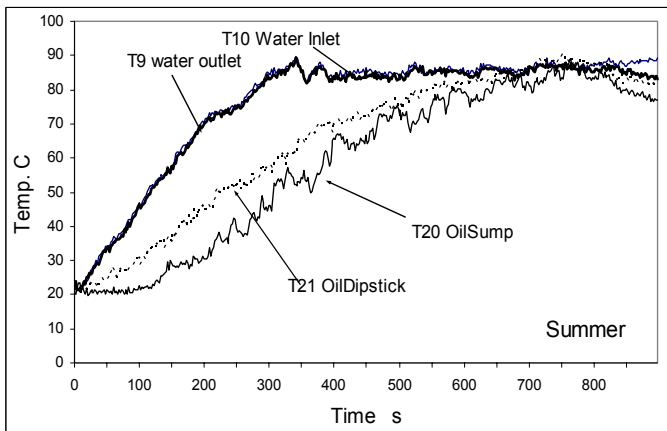

Figure 7 Warm up of water and lube oil at 31°C

The warm up period of the lubricating oil was taken as when the lubricating oil reached 80°C. Two lubricating oil temperatures were measured (T20 and T21), one close to the surface of the lubricating oil (dipstick, T21) and one close to the bottom of the sump (T20). The top temperature is higher than the bottom as the oil from its circuit around the engine is heated and hence accumulates on the top of the sump oil level. The oil pump picks up cold oil from the bottom of the sump. Hence the true lube oil warm-up temperature is that for the bottom of the sump (T20).

The difference in these temperatures is shown in Figures 6 and 7, which shows a much longer warm-up period for the oil at the bottom of the sump and a much greater difference in this temperature between winter

and summer, than for the corresponding difference for the top of the sump oil temperature (T21). The comparison in Figure 8 is for the bottom of the sump temperature (T20). This temperature difference between the top and bottom of the oil sump was also found in engine dynamometer warm-up tests (9-14).

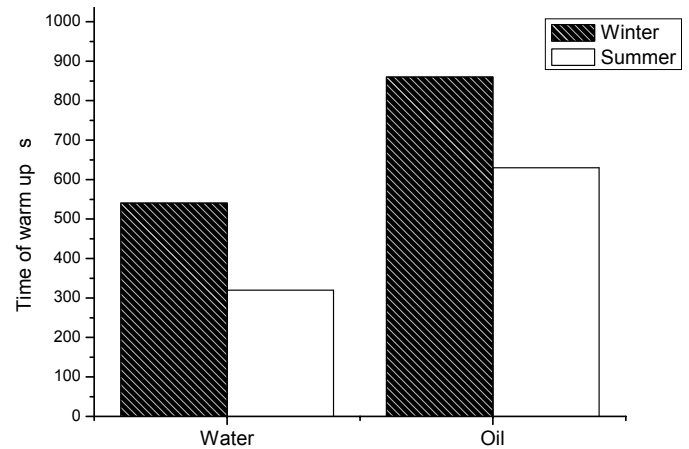

Figure 8 comparison of warm up time of coolant water and lubricant

These results show that in summer the water is not warm until the middle of the second lap and in winter this occurs in the middle of the third lap. For lubricating oil in summer the bottom of the sump oil warms-up at the end of the fourth lap and in winter it is not warmed-up by the end of the fourth lap. For the short urban journeys that are common in cities such as Leeds with a high population density ($1,300/\text{km}^2$) these results show that the slow warm-up of the water and lubricating oil are a significant factor in the higher engine out emissions and fuel consumption under cold start, which are detailed below. Normally, the lube oil is unlikely to warm up in any short urban journey and this has a major impact on the higher fuel consumption in urban driving.

WARM-UP OF ENGINE EXHAUST SYSTEM

EXHAUST MANIFOLD – Four thermocouples are installed at the exhaust manifold to measure metal temperatures at each pipe respectively, as illustrated in Figure 1. They are coded as Tw5 to Tw8 for manifold metal temperatures.

The temperature differences on different manifold pipes are partly due to the thermocouple locations, which do not have exactly same distance from exhaust port of each cylinder. Tw8 is the closest point to exhaust port. Tw7 is the furthest point to exhaust port.

All four metal temperature measurements show a rapid increase for the first 200 seconds, indicating a major heat absorption and transfer period. This period is corresponding to the lap 1 of the test cycle. The HC and CO emissions are at their highest, which will be discussed and shown later. The discrepancy in

temperatures between cold winter and hot summer is about 20~50°C.

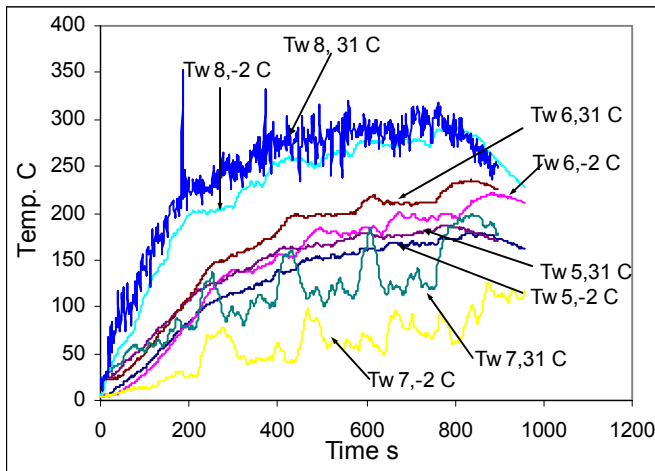

Figure 9 Exhaust manifold metal temperatures at -2°C and 31°C ambient temperatures

EXHAUST DOWNPIPE – Three thermocouples (Tw22-24) were installed along the exhaust downpipe to measure metal temperatures. Tw22 is located at the leading edge of the down pipe close to the connection to the exhaust manifold. Tw24 is located at the trailing edge of the down pipe near the TWC. Tw 23 is in the middle of the down pipe where there is a curved bend.

Figure 10 compares at 31°C and -2°C ambient temperature the downpipe metal temperatures at the inlet (Tw22) and outlet (Tw24), which is just upstream of the catalyst connection flange.

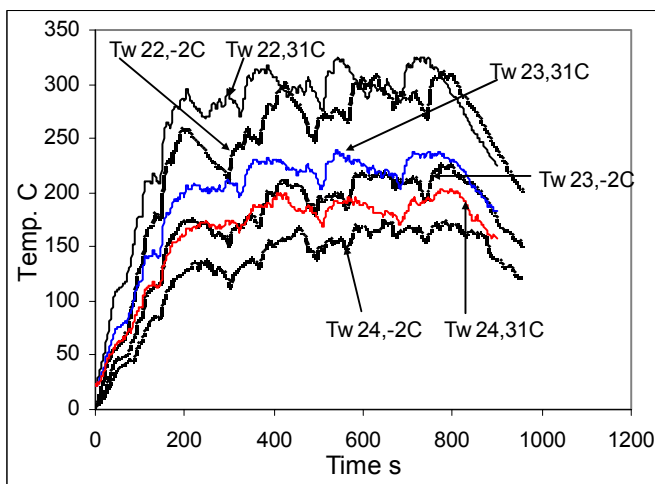

Figure10 comparison of metal temperatures along down pipe at -2°C and 31°C ambient temperatures

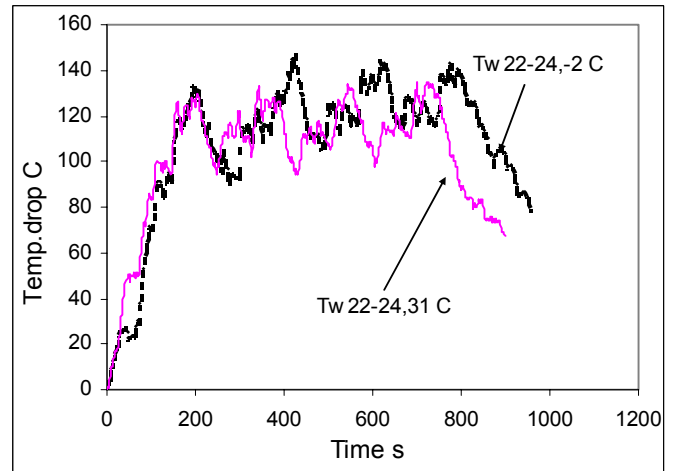

Figure11 Temperature drop along exhaust down pipe metal at -2°C and 31°C ambient temperatures

In these tests, the engine exhaust port temperature (gas temperatures) was at least 350°C within 10s of the cold start and never dropped below 400°C after 60s from the -2°C cold start (Figure12). All these exhaust port temperatures are above the light off temperature of a catalyst. The slow light off temperature of a catalyst in a Euro 1 vehicle is thus due to heat losses in the cold manifold and downpipe. The cold manifold heat losses dominate initially, as shown by the downpipe inlet metal temperatures in Figure 10, which are close to the manifold outlet metal temperatures. This shows that it takes 200s to reach 300°C at 31°C ambient temperature, by which time the exhaust port gas temperature is 600°C. This is roughly the time constant for the thermal inertia of the exhaust manifold.

The downpipe has further thermal inertia and Figure 10 shows that after 200s from the cold start the wall metal temperature upstream of the catalyst is only 170°C at 31°C ambient temperature and 130°C at -2°C. It is this slow heating of the exhaust system walls that extracts heat from the exhaust and causes the catalyst inlet temperature to be well below its light off temperature.

Figure 11 shows the comparison of temperature drops between inlet and outlet of exhaust downpipe (Tw22-Tw24). The metal wall temperature drops reached 120°C after 200 seconds and then reach a balance which is 100~120°C.

HEAT LOSS AS THE FUNCTION OF WARM UP AND AMBIENT TEMPERATURES

CALCULATION OF HEAT LOSS – The heat loss across the exhaust manifold and downpipe is calculated as the exhaust gas enthalpy drop between the engine out (manifold) and the inlet of the TWC (upstream of the TWC) using following equation:

Heat Loss ΔQ (kJ/s) = $Q_{geo} - Q_{gus}$

$$= M_{exh} \cdot C_{pexh1} \cdot T_{geo} - M_{exh} \cdot C_{pexh2} \cdot T_{gus} \quad (1)$$

Where: Q_{geo} - exhaust gas heat at engine out (manifold), kJ/s.

Q_{gus} - exhaust gas heat at upstream of the TWC

T_{geo} and T_{gus} - exhaust gas temperatures at engine out and upstream of the catalyist.

M_{exh} - Exhaust mass flow, kg/s.

C_{pexh} - Specific heat of exhaust gas, which is a function of temperature at constant pressures for a stoichiometric combustion process of a certain petrol fuel, for the exhaust temperature 200~600°C range, the following equation can be used to calculate the local exhaust specific heat(28,29):

$$C_{pexh} = 0.95 + 0.4254 \cdot 10^{-3} T - 1.1 \cdot 10^{-9} T^2 \quad \text{kJ/kgK}$$

T is absolute temperature, K.

Thus the equation (1) can be written as:

Heat Loss ΔQ (kJ/s) = $Q_{geo} - Q_{gus}$

$$= M_{exh} \cdot C_{peo} \cdot T_{geo} - M_{exh} \cdot C_{pus} \cdot T_{gus}$$

$$= M_{exh} (C_{peo} \cdot T_{geo} - C_{pus} \cdot T_{gus}) \quad (2)$$

Where: C_{peo} and C_{pus} are local exhaust gas specific heat at engine out and upstream of the catalyist.

EXHAUST GAS TEMPERATURE AT MANIFOLD – Figures 12 and 13 show the temperature profiles for exhaust gases at the manifold measured in hot summer and cold winter.

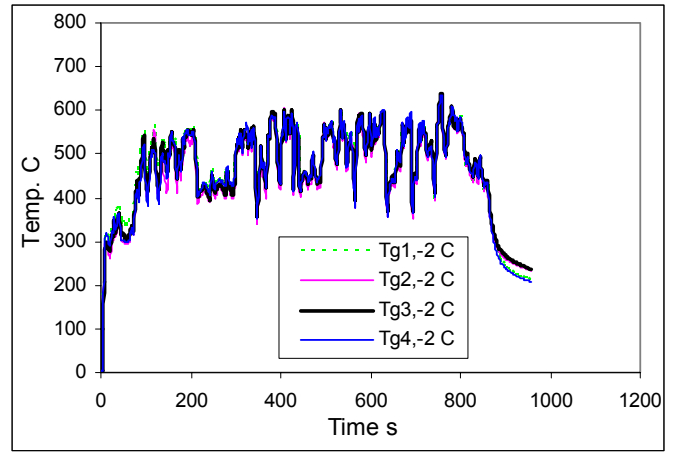

Figure 12 Engine out gas temperatures at -2°C ambient temperature

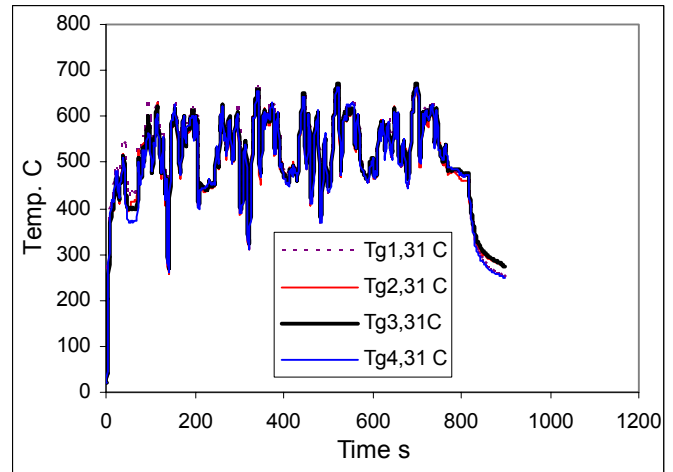

Figure 13 Engine out gas temperatures at 31°C ambient temperature

Results in Figures 12 and 13 show that exhaust gas temperatures are quite uniform in four manifold pipes and different from metal temperature features shown in Figure 9, though the thermocouple positions are paired and next to each other for metal and exhaust gas measurement at each measuring point. The uniformity of gas temperatures indicated even combustion processes in each cylinder. This gives an advantage for gaseous temperature measurement that one or two point measurement could well represent the average gas temperatures of engine out at the manifold.

The difference in exhaust gas temperatures at manifold is small between cold winter and hot summer. The main difference is in the first minute where the exhaust temperature reached 500°C in summer and only 400°C in winter. This is mainly due to colder air and fuel in winter.

Figure 14 shows the temperature drop of exhaust gases from engine out to inlet of the catalyist. It is clear that the largest temperature drop occurred during the first 200 seconds due to the inertia of metals at exhaust manifold and downpipe. With the warm up of manifold and down

pipe, the heat transfer reached equilibrium after 200 seconds. However, it is worth stating that the cold start period of the car is much longer than 200 seconds as coolant and lubricant are not fully warmed up yet. For Leeds urban driving test cycle, it takes about 15 minutes for the test car to reach fully warmed up conditions.

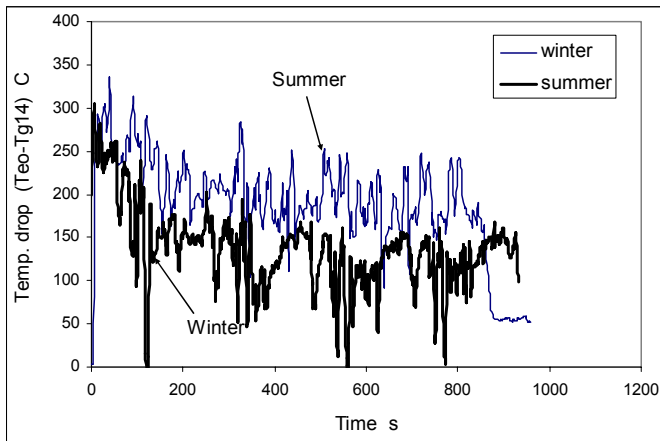

Figure 14 Temperature drops of exhaust gases from engine out to inlet of the TWC

HEAT LOSS FROM ENGINE OUT TO THE CATALYST

– Figure 15 shows the total heat of engine out exhaust gases in winter and summer. The engine produced similar heat and energy from combustion processes in hot summer and cold winter. However, this is achieved by consuming more fuel in winter which is shown in table 2 later.

Heat loss at the beginning of a cold start is mainly resulted from heating up the cold metals of the manifold and downpipe, which is known as the system thermal inertia. Thereafter the heat loss is linked with the heat transfer from exhaust gas to ambient air.

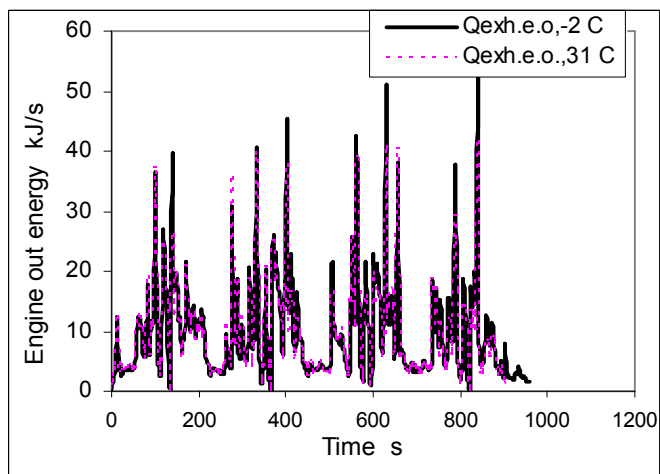

Figure 15 Engine out energy flow of exhaust gas at manifold

Heat losses of exhaust gases from engine out to inlet of the TWC are 2~5 kw (kJ/s) for the first 400 seconds and

gradually decrease to 1~2 kw towards the end of the test, as shown in Figure 16. Heat losses in summer are apparently lower than that in winter.

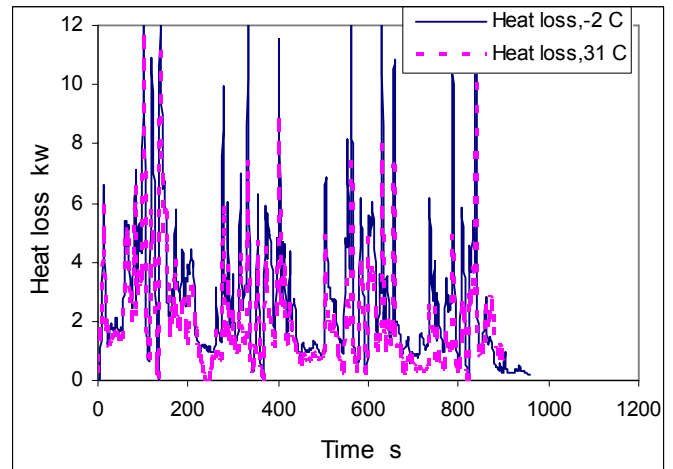

Figure 16 Exhaust gas heat loss from engine out to inlet of TWC at cold and hot weather

Exhaust gas heat losses along the manifold and downpipe are determined at different ambient temperatures and represented as function of ambient temperatures shown in Figure 17.

It is shown that the exhaust gas heat loss along the manifold and downpipe decreased with the rising of ambient temperatures. The heat loss at -2°C is about 1.8 times higher than that in summer.

The heat loss in the first 200 seconds was further analyzed and shown in Figure 18. The rate of heat loss Vs ambient temperatures for the first 200 seconds is larger, though the trend is similar to that of whole testing period in Figure 17. This demonstrates the influence of ambient temperatures on the thermal losses of exhaust manifold and downpipe. i.e. cold weather increased thermal losses of exhaust manifold and downpipe metals and lead to larger heat losses of exhaust gases.

Figure 17 represented the average heat loss during the whole test period while Figure 18 is the average heat loss during the first 200 seconds period. The increase in average heat loss is about one and half fold for the first 200 seconds, compared with that for the whole test period.

The tests for each ambient temperature were conducted once and this brings in some uncertainties. However, the heat losses measured at 5°C and 8°C ambient temperatures in Figures 17 and 18 can be used to reflect the repeatability of the tests, indicating reasonable results.

IMPACT OF HEAT LOSS ON CATALYST LIGHT-OFF

CATALYST INLET GAS TEMPERATURES AND ENERGY GAIN – Figure 20 shows inlet gas temperatures of the catalyst (T_{g14} , upstream of the catalyst) in winter and summer. The gas temperatures reached 300°C in about 200 seconds after a cold start and then fluctuated between 300 and 500°C except the period around 250 seconds when the first lap of trip had been completed and the car stopped for a sample bag change before the engine was fully warmed up. These temperature profiles were corresponding to the results in Figure 14. The overall T_{g14} temperature in winter is lower than that in summer. The catalyst inlet gas temperature in winter was apparently lower for the first 100 seconds compared to summer, indicating a higher thermal inertia of exhaust manifold and downpipe in cold winter.

From exhaust gas temperatures at upstream of the TWC and exhaust flow, the heat energy of exhaust gases at the inlet of the TWC, which would feed to the catalyst, is calculated and shown in Figure 21 for each lap of the four laps test cycles. The heat energy feed of exhaust gases to the TWC for the first lap is significantly lower (50% lower) than that in following laps due to greater heat losses in the first lap.

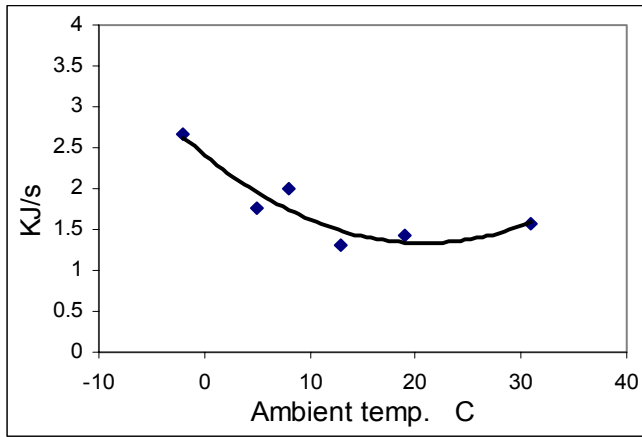

Figure 17 Heat losses as a function of ambient temperature

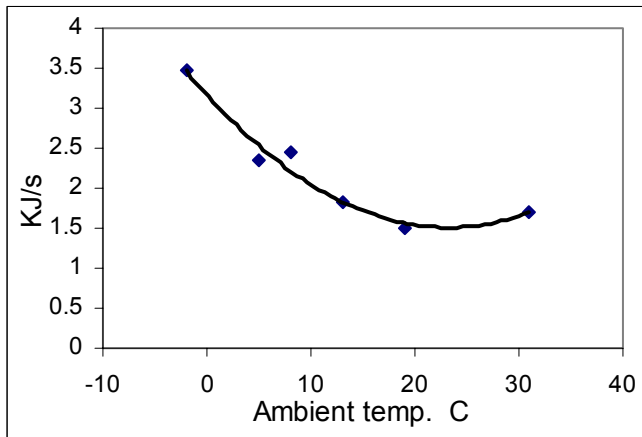

Figure 18 The first 200 seconds heat loss as a function of ambient temperature.

Figure 19 shows the heat loss per kilogram fuel burned. The heat loss was twice as high in winter as in summer. This lead to the deterioration of fuel economy and will be discussed later.

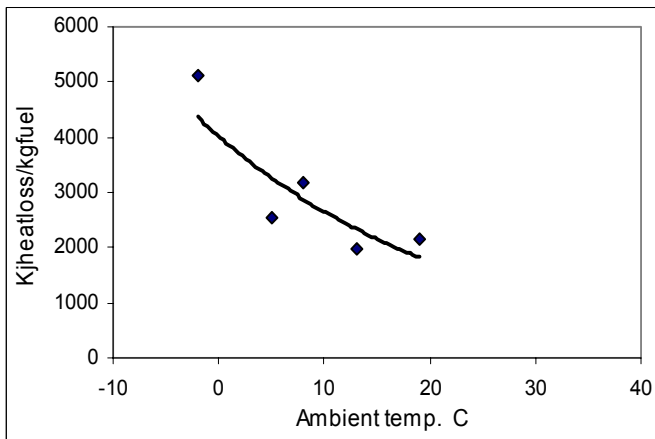

Figure 19 Heat loss per kgfuel burned

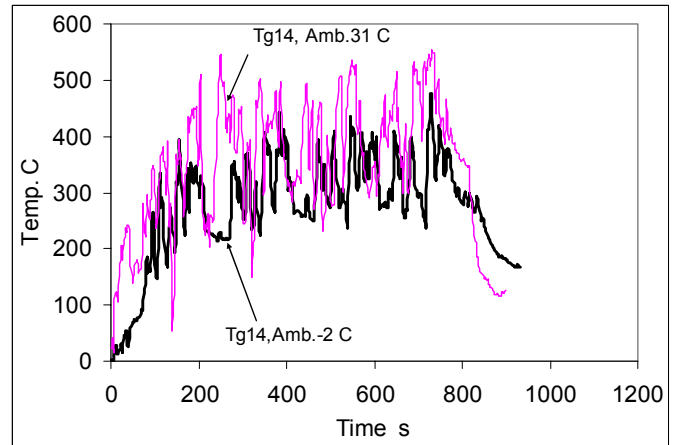

Figure 20 Comparison of gas temperatures upstream of the TWC

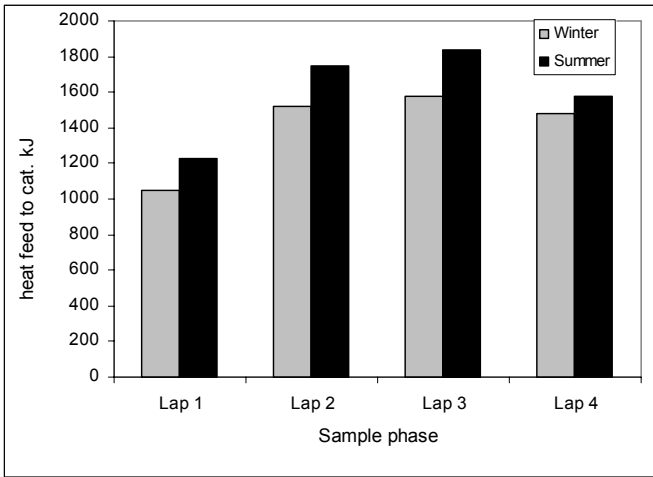

Figure 21 Comparison of heat feed to the TWC by exhaust gases for each lap of test cycle.

CATALYST SUBSTRATE TEMPERATURES AND LIGHT OFF – Figures 22 and 23 show for winter and summer conditions, the front face and rear face catalyst substrate temperatures on the center line and left hand side. The two temperatures were very similar for each face, although at the rear face when the catalyst was lit off one of the thermocouples was 50°C higher than the other, indicating a spatial non-uniformity in the activity of the catalyst. This occurred in the winter and summer tests. When the catalyst is active the heat release from the oxidation of hydrocarbons and CO increases the gas and substrate temperatures.

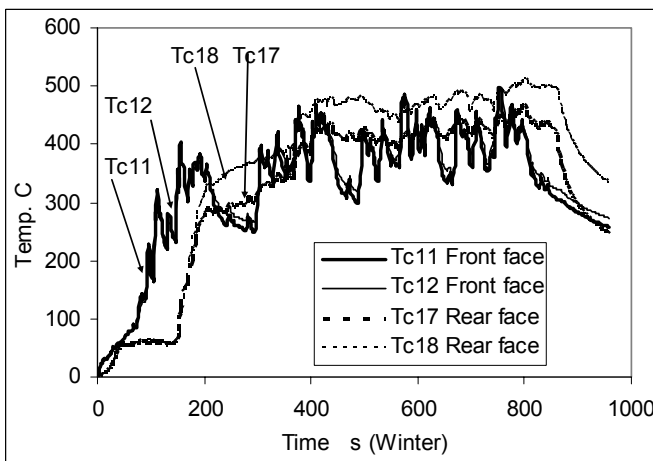

Figure 22 Front and rear face temperatures of catalyst substrate at -2°C

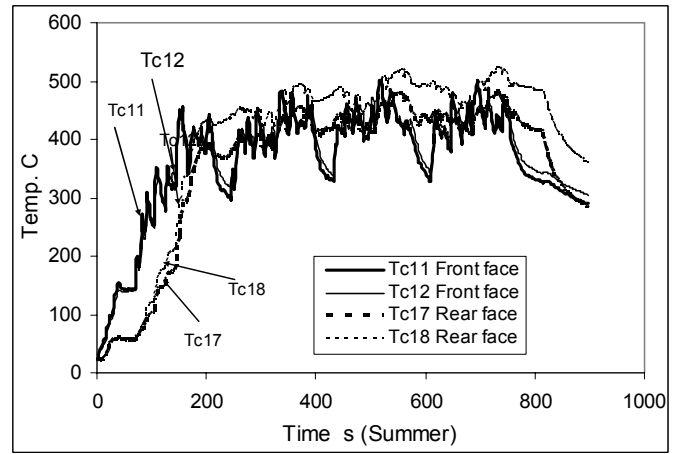

Figure 23 Front and rear face temperature of catalyst substrate at 31°C

CATALYST LIGHT OFF – One method of determining the catalyst light off temperature is when the downstream catalyst substrate face temperature is greater than the front face temperature. In other words, when the second brick of the catalyst substrate face temperature is higher than the first brick face temperature. This time is approximately twice as long in winter as in summer. Comparison with Figure 5 shows that the catalyst light off occurs just at the end of the first cold-start street circuit and in winter it occurs at the end of the second street circuit or about 3km. Many journeys in urban areas such as Leeds are less than 3 km and under these conditions Euro 1 vehicles in winter have little catalytic exhaust emissions clean up.

The gas temperatures were measured at the catalyst inlet (Tg14), between the two catalyst bricks (Tg15) and downstream of the catalyst (Tg16). The advantage of using these temperatures to determine the catalyst light off is that under cold start only the first catalyst brick is normally active, due to the lower exhaust mass flow rates at the low powers of the cold start urban cycles. Thus it is normally only the first brick that is heated in the first light off phase and hence the second brick acts as a thermal heat sink. This means that the downstream catalyst brick face may not be the best location to determine the catalyst light off. The centre thermocouple located between the two bricks is likely to be the best place to determine the catalyst light off using the temperature rise from catalytic activity.

The catalyst gas temperatures Tg14, 15 and 16 are shown in Figures 24 and 25 for winter and summer conditions. These results confirm that the central temperature between the two bricks rises to the highest temperature and demonstrates a clear catalyst light off, when compared with the inlet gas temperature. This central temperature is higher than the downstream temperature for most of the test period, indicating the effect of the thermal inertia of the downstream brick.

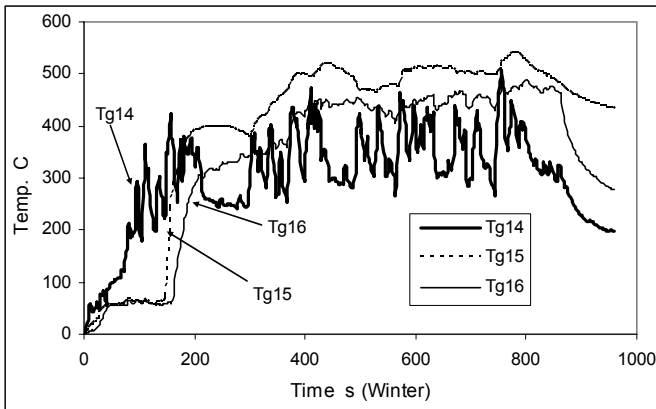

Figure 24 Exhaust gas temperatures across the catalyst at -2°C

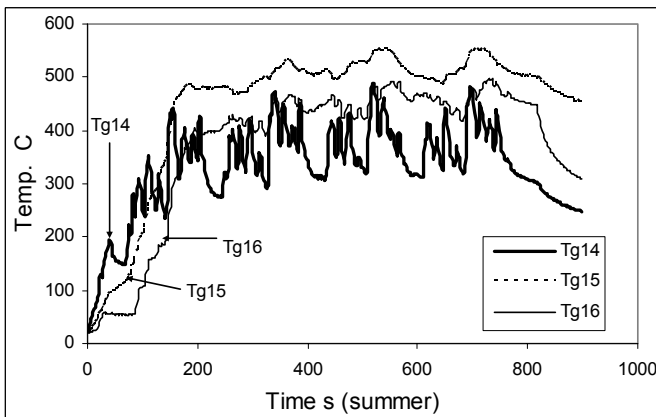

Figure 25 Exhaust gas temperatures across the catalyst at 31°C

As discussed above, the catalyst light off can be either indicated by the temperature of mid catalyst gas when the central gas temperature thermocouple Tg15 became hotter than the inlet gas temperature Tg14 or downstream of the catalyst substrate temperature when the temperature of downstream of the catalyst substrate face temperature is greater than upstream of the catalyst substrate face temperature. Comparisons between these two indicators are shown in Figure 26 for winter and summer tests. Substrate temperature indicators show much longer light off times, by a factor close to 2. Also, there is a smaller difference between summer and winter using the central gas thermocouple. Essentially, the light off time indicated by mid catalyst gas temperature is for the front brick and the light off time indicated by downstream of catalyst substrate face temperature is for the rear brick. This can also be shown by comparing the time at which the downstream gas temperature Tg16 is continuously hotter than the inlet Tg14. Figures 24 and 25 show that this is at 360s in winter and 200s in summer, in excellent agreement with the inlet and outlet catalyst face temperature light off times. For cold start emission control it is the light off of the first brick that is important, but having both bricks active is important in terms of achieving the best catalyst conversion efficiency.

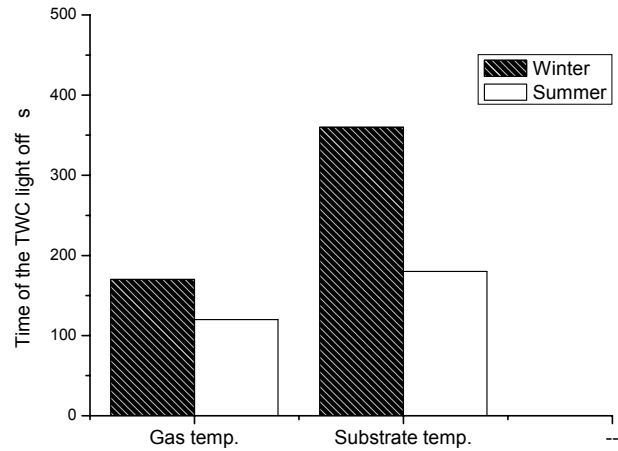

Figure 26 Comparison of light off time indicated by mid. catalyst gas temperatures and downstream substrate temperatures

INFLUENCE OF EXHAUST THERMAL CHARACTERISTICS ON EMISSIONS

HC AND CO EMISSIONS – Exhaust emissions have been measured upstream and downstream of the TWC for each Leeds Urban Driving Test Cycle using the bag sampling techniques under different ambient temperatures. The details have been published by authors (30), in which authors reported that the HC and CO emissions were strongly depending on thermal warm up processes of engine and exhaust system and affected by ambient temperatures. Figures 27 and 28 show the HC and CO emissions as a function of warm up process and comparisons between winter and summer.

The engine out HC emissions were decided by combustion conditions such as temperatures of fuel air mixtures, spark timing and fuelling management. Results show that engine out HC emissions were reduced by 60% between the first lap and second lap in winter; indicating the importance of engine water and lubricating oil warm up on the engine out cold start emissions.

Downstream of the TWC, the influence of warm up process is much stronger, especially in winter. The HC emissions were reduced by 75% within the first 8 minutes in winter.

The CO emissions show a similar pattern with a greater magnitude compared to HC emissions. Engine out CO emissions were reduced a great deal in the first 8 minutes of the test in winter, indicating the impact of cold weather on combustion processes.

Downstream of the TWC, the reductions of CO emissions as a function of the engine warm up are apparently shown not only in winter but also in summer. The extended emission reduction period indicates longer engine warm up process in winter.

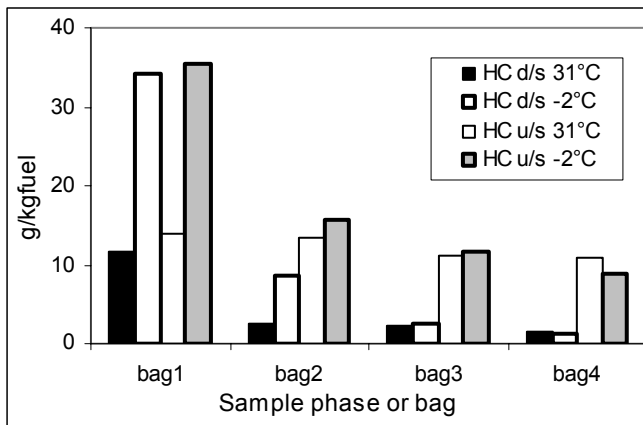

Figure 27 HC emissions as a function of warm up in winter and summer

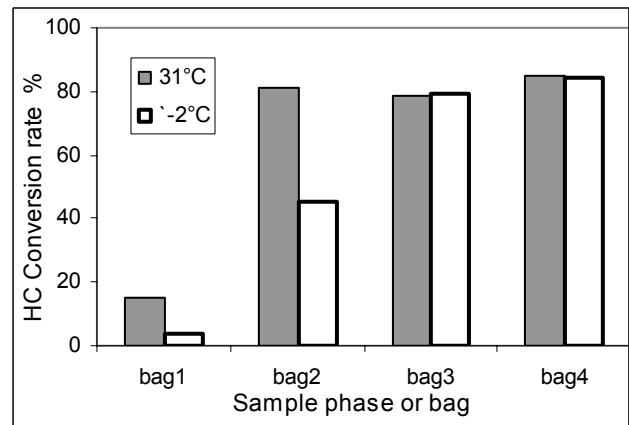

Figure 29 Catalytic conversion efficiency of HC emissions

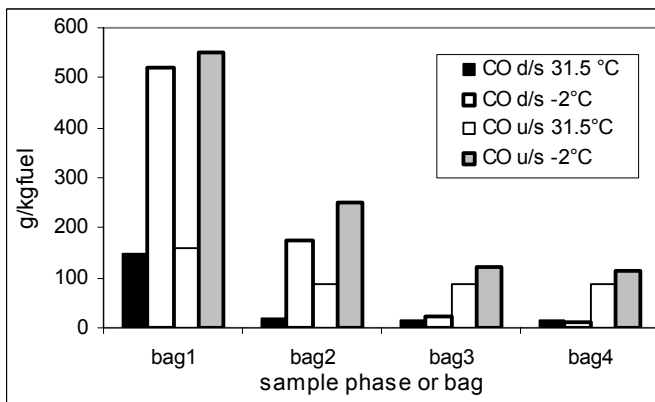

Figure 28 CO emissions as a function of warm up in winter and summer

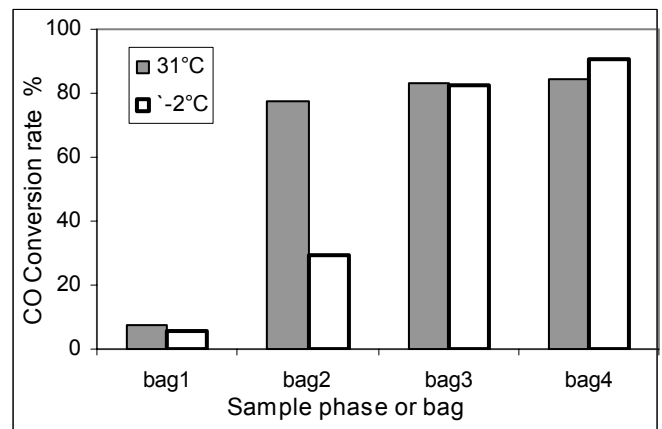

Figure 30 Catalytic conversion efficiency of CO emissions

CONVERSION EFFICIENCY OF THE TWC – The catalytic conversion efficiency of HC and CO is calculated by upstream and downstream emissions and shown in Figures 29 and 30. Very low conversion efficiency for the first bag of sample is corresponding to low temperature of the catalyst within the first 200 seconds. The second bag of samples shows rapid increases in HC and CO conversion efficiency in summer and still low conversion efficiency in winter. The difference in conversion efficiency for the second bag of samples is related to the discrepancy of light off time of the catalyst.

The light off time of the catalyst is 360s in winter, which is halfway through the second bag sampling process and 200 seconds in summer, which is before the second bag sampling process, in terms of second brick catalyst substrate face temperatures. Light off time indicated by mid catalyst gas temperatures is much shorter and before the end of the first gas sampling process for both summer and winter. Obviously, the HC and CO conversion efficiency is still low after the 1st lap in winter. The catalyst light off indicator by second brick catalyst substrate temperatures is more suitable to reflect conversion efficiency.

IMPACT OF AMBIENT TEMPERATURES ON FUEL CONSUMPTIONS

Total heat losses of exhaust gases from engine out to inlet of the catalyst during the Leeds Urban driving cycles are shown in table 2 below. Taking 42 MJ/kg as petrol calorific value, then fuel mass lost due to heat losses to exhaust metals is worked out. The results have shown that 10.5% of fuel is wasted due to exhaust metal thermal losses and heat transfer. The cold winter caused 1.4 % more fuel consumption than that in hot summer due to higher heat losses.

Table 2 Total heat loss and fuel loss comparison for whole test cycles in winter and summer

	Winter -2 °C	Summer 31 °C
Total Heat loss to exhaust manifold and downpipe for the whole test cycle kJ	2550	1593
Equivalent fuel mass for producing the same heat g	60.7	37.9
% of cycle fuel consumption	8.9	7.5

The first 200 seconds of the test cycle has the greatest heat losses as discussed above. Thus this period has the greatest energy loss. Table 3 lists the first 200 seconds total heat loss and fuel loss.

Table 3 Comparison of heat loss and fuel loss for the first 200 seconds of the test cycle

	Winter -2 C	Summer 31 C	% of total cycle	
			-2C	31C
Heat loss to exhaust manifold and downpipe for the 1 st 200 s kJ	747	488	29	32
Equivalent fuel mass for producing the same heat g	17.8	11.6	29	32
% of total fuel consumption	3.1	2.3		

The average fuel consumption of the test cycle is determined as the function of ambient temperatures and shown in Figure 31. The cold start fuel economy is deteriorated by 10~15% as the ambient temperature decreased by 33 °C. The increased fuel consumption in cold weather is mainly due to increased mechanical frictions and additional over-fueling and yet greater heat losses are also contributing to increased fuel consumptions in cold weather.

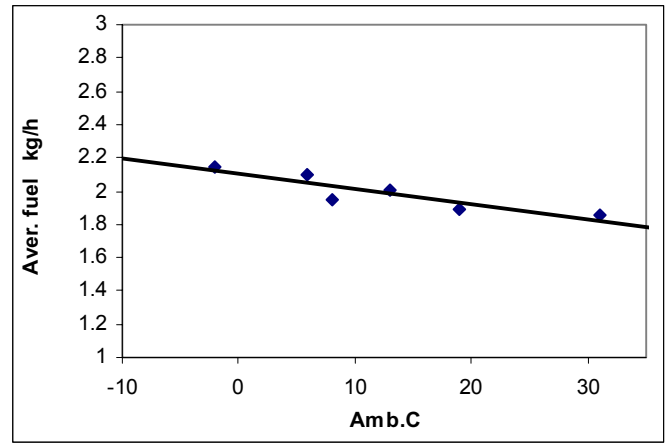

Figure 31 Fuel consumptions Vs Ambient temperatures

CONCLUSION

The Leeds urban driving test cycles represent real world driving conditions in the minor roads of busy metropolitan cities and are similar to ECE15 urban test cycle. Thermal measurements of exhaust system and exhaust emissions on a EURO 1 SI car under different ambient temperatures are conducted. The significance of this real world test lies in that this test represents the whole vehicle response to cold start, including gearbox and cold tyre effects that can not be achieved by dynamometer tests. The results from this research can be used for better understanding the vehicle response in the real world driving conditions, which is quite different from dynamometer tests and provide valuable information to modelers for better prediction of emissions and air qualities in cities. The results show:

1. The engine needs at least 5 minutes after a cold start to reach full warmed up condition in terms of the coolant water temperature and 10 minutes in terms of lubricating oil temperature. A decrease in the cold ambient temperature increases this period significantly.
2. The most significant heat losses at exhaust manifold and downpipe occur during the first 200 seconds after cold starts due to thermal inertial of metals. A decrease of ambient temperature increases heat losses.
3. Heat losses at exhaust manifold and downpipe take up 9~10% of total fuel consumption during cold starts.
4. Two methods for the indication of catalyst light off are discussed: mid catalyst gas temperatures and second catalyst brick substrate face temperatures. The latter one has longer light off time and is better linked to the catalyst conversion efficiencies.

5. The heat losses of exhaust system have direct and profound influence on catalyst light off time and thus emissions.
6. The results in this paper are obtained from single test for each ambient temperature. Thus there are some uncertainties and limitations for the interpretation of the results, though this test cycle has reasonably good repeatability.

ACKNOWLEDGMENTS

We would like to thank the UK EPSRC for a research grant, GR/M88167/01, for a JIF (Joint Infrastructure Fund) award for the LANTERN project (Leeds health Air quality, Noise, Traffic, Emissions Research Network). We would also like to thank the EPSRC for the research grant, GR/S31136/01, for the RETEMM (Real-world Traffic Emissions Measurement and Modeling) project award in support of this work. Grant Zhu and Basil Daham would like to thank the University of Leeds for research scholarships.

REFERENCES

1. Hans Peter and Christian Cozzarini: Emissions and Air Quality. SAE Reference book R-237.2000.
2. J.Laurikko, L. Erlandsson and R.Arbrahimsson; Exhaust in Cold Ambient Conditions: Considerations for a European Test Procedure. SAE Paper 95923.
3. J.Laurikko and P.Aakko: The Effect of Ambient Temperature on the Emissions of Some Nitrogen Compounds: A Comparative Study on Low-Medium and High Mileage Three-Way Catalyst Vehicles. SAE Paper 950933.
4. M.D.Gurney and J.R.Allsup: Predictability of Emissions from In-Use Vehicles at Low-Ambient Temperature and Alternate Driving Cycle Based on Standard Tests. SAE Paper 890625.
5. R.E.Larson: Vehicles Emissions Characteristics under Cold Ambient Condition. SAE Paper 890021.
6. G.W.R.Taylor and S Stewart: Cold start Impact on Vehicle Energy Use. SAE Paper 2001-01-0221.
7. J.Laurikko and N.Nylund: Regulated and Unregulated Emissions from Catalyst Vehicles at Low Ambient Temperature. SAE Paper 930946.
8. D.H.Jason and M.D.Checkel: Quantifying Vehicle Emission Factors for Various Ambient Conditions using an On-Road, Real-Time Emissions system. SAE Paper 2003-01-0301
9. G.E.Andrews, J.R.Harris and A.Ounzain: Transient Heating and Emissions of an SI Engine during the Warm-up period. SAE Paper 880264.
10. G.E.Andrews, J.R.Harris and A.Ounzain: SI Engine Warm-Up: Water and Lubricating Oil Temperature Influences. SAE Paper 892103.
11. G.E.Andrews, J.R.Harris and A.Ounzain: The Role of Cooling Water and Lubricating Oil Temperature

- on Transient Emissions during SI Engine Warm-up. I.Mech.E. 1989.
12. G.E.Andrews, J.R.Harris and A.Ounzain: Experimental Methods for Investigating the Transient Heating and Emissions of an SI Engine during the Warm-up Period. I.Mech.E. 1988.
13. G.E.Andrews, A.Ounzain, A.D.Al-fawaz, M.Ghazhikhani and P.H.Dyke: Catalyst Performance during the Warm-up period. 2nd British-Italian conference in Engine
14. G.E.Andrews, J.R.Harris and A.Ounzain: The Influence of External Heat Losses on the Transient SFC and Emissions during the Warm-up period of an SI Engine. IMechE 1990
15. B.Piotr and M. Jerzy: Cold Start Emissions Investigation at Different Temperature Conditions. SAE Paper 980401.
16. G.E.Andrews and F.M.Ahmad: The Composition of Spark Ignition Engine Steady State Particulate Emissions. SAE Paper 1999-01-1143.
17. G.E.Andrews, Hu Li, J.Hall, A.A.Rahman and P.Mawson: The Influence of an Oil Recycler on Emissions with Oil Age for a Refuse Truck in Service testing. SAE Paper 2001-01-0623.
18. G.E.Andrews, Hu Li, J.Hall, A.A.Rahman and P.Mawson: Impacts of an on Line Bypass Oil Recycler on Emissions with Oil Age for a Bus in Service testing. SAE Paper 2001-01-3677.
19. G.G.Zhu: Engine and Exhaust System Warm-up, Emissions and Catalyst Temperature Control. PhD thesis, Dept. of Fuel and Energy, The University of Leeds, 1999.
20. J.A.Wylie: Spark Ignition Engine Emissions during Cold Start under Real World Driving Conditions. MSc thesis. The University of Leeds, 2001.
21. Automotive Test Drive Cycles for Emission Measurement and Real-World Emission levels – A Review. Journal of Automobile Engineering, Vol.216, No.D7. Institution of Mechanical Engineers. London, 2002
22. Y.Ohyama: Mixture Formation during Cold Starting and Warm-up in Spark Ignition Engines. SAE Paper 960065.
23. P.Bielaczyc and J.Merkisz: Euro III/Euro IV Emissions – A Study of Cold Start and Warm Up Phases with a SI Engine. SAE Paper 1999-01-1073.
24. P.Bielaczyc and J.Merkisz: Exhaust Emission from Passenger Cars during Engine Cold Start and Warm-up. SAE Paper 970740.
25. P.Bielaczyc, J.Merkisz and J.Pielecha: Exhaust Emissions from Diesel Engine during Cold Start in Ambient Temperature Conditions. Paper presented at 2000 FISITA World Automotive Congress~Automotive Innovation for the New Millennium. Seoul, Korea, 2000
26. Spark Ignition Engine Emissions. Short course. Leeds University. 2003.
27. Website of Vehicle Certification Agency, UK. <http://www.vcacarfuedata.org.uk/>

28. G.P.Blair:, The Basic Design of Two-Stroke Engines. P214. Published by SAE. 1990
29. C.R.Ferguson: Internal Combustion Engines-applied thermosciences. 1985. ISBN 0-471-88129-5.
30. G.E.Andrews, Grant Zhu, Hu Li, A. Simpson, J.A.Wylie, M.C.Bell and J Tate: The Effect of Ambient Temperature on Cold Start Urban Traffic Emissions for a Real World SI Car. SAE Paper 2004-01-2903.

ABBREVIATIONS

SI: Spark Ignition.

LU-UDTC: Leeds University Urban Driving Test Cycle.

TWC: Three Way Catalyst.

HC: Hydrocarbons.

CO: Carbon monoxide.

CONTACT

Please contact Dr. Hu Li by Email: fuehli@leeds.ac.uk