







Implementation Challenges and Opportunities in Beyond-5G and 6G Communication

ULF GUSTAVSSON ¹, PÅL FRENGER¹, CHRISTIAN FAGER ² (Senior Member, IEEE),
THOMAS ERIKSSON ² (Senior Member, IEEE), HERBERT ZIRATH ² (Fellow, IEEE),
FRANZ DIELACHER³ (Senior Member, IEEE), CHRISTOPH STUDER ⁴ (Senior Member, IEEE),
AARNO PÄRSSINEN⁵ (Senior Member, IEEE), RICARDO CORREIA ^{7,8} (Member, IEEE),
JOÃO NUNO MATOS⁶ (Member, IEEE), DANIEL BELO⁶, AND NUNO BORGES CARVALHO ⁶ (Fellow, IEEE)

(Invited Paper)

¹Ericsson Research, 11259 Stockholm, Sweden

²Chalmers University of Technology, 412 96 Gothenburg, Sweden

³Infineon Technologies, 9500 Villach, Austria

⁴Department of Information Technology and Electrical Engineering, ETH Zurich, 8092 Zurich, Switzerland

⁵Center of Wireless Communications, University of Oulu, 90570 Oulu, Finland

⁶Instituto de Telecomunicações, Departamento de Electrónica, Telecomunicações e Informática, Universidade de Aveiro, 3810-193 Aveiro, Portugal

⁷Instituto de Telecomunicações, Sinuata SA., 3860-529 Estarreja, Portugal

⁸ESTGV, Instituto Politécnico de Viseu, 3504-510 Viseu, Portugal

CORRESPONDING AUTHOR: Ulf Gustavsson (e-mail: ulf.gustavsson@ericsson.com).

ABSTRACT As 5G New Radio (NR) is being rolled out, research effort is being focused on the evolution of what is to come in the post-5G era. In order to meet the diverse requirements of future wireless communication in terms of increased capacity and reduced latency, technologies such as distributed massive Multiple-Input Multiple-Output (MIMO), sub-millimeter wave and Tera-hertz spectrum become technology components of interest. Furthermore, to meet the demands on connectivity anywhere at anytime, non-terrestrial satellite networks will be needed, which brings about challenges both in terms of implementation as well as deployment. Finally, scaling up massive Internet-of-Things (IoT), energy harvesting and Simultaneous Wireless Information and Power Transfer (SWIPT) is foreseen to become important enablers when deploying a large amount of small, low-power radios. In this paper, we will discuss some of the important opportunities these technologies bring, and the challenges faced by the microwave and wireless communication communities.

INDEX TERMS Beyond-5G, distributed massive MIMO, sub-millimeter wave, non-terrestrial networks, energy harvesting.

I. INTRODUCTION

The evolution of modern digital communication systems continuously brings new practical implementation challenges as the need for increased capacity and lower latency grows. A prime example is the introduction of 5G New Radio (NR), which brought both new multi-antenna techniques such as massive Multiple-Input Multiple-Output (MIMO), [1], along with a flexible air-interface based on Orthogonal Frequency-Division Multiplexing (OFDM) using multiple numerologies over a large channel bandwidth, and thus higher carrier frequencies, [2]. Following the trends toward communication systems beyond 5G includes massively distributed MIMO,

[3], both at the current 5G frequency bands, but also exploring sub-millimeter wave frequencies recently allocated for communication. While parts of the sub-millimeter wave spectrum tends to be fragmented, such as the frequency bands around 70 GHz, there are still large parts of free, contiguous spectrum around 130–160 GHz and 195–225 GHz available.

In the area of sub-millimeter wave technology, challenges in terms of transceiver implementation is presented as limits in device physics impacts the transceiver performance. Due to factors like the Johnson limit, [4], generating output power becomes increasingly difficult as the carrier frequency increases. As material losses increase, highly integrated solutions will

likely be favored which presents challenges in terms of packaging.

Massive Internet-of-Things (IoT) is another emerging application which introduces new challenges. When deploying a large amount of small, low-power devices, Simultaneous Wireless Information and Power Transfer (SWIPT) becomes a potential candidate to supply power to the network. Radio Frequency (RF) Energy Harvesting (EH) presents an opportunity for these small devices to charge without physical connections. This presents a diverse set of challenges in terms of implementation, [5].

Providing coverage anywhere at anytime is an extremely challenging task. Recently, a renewed interest in satellite communication has emerged. Developing and launching a high number of Low Earth Orbit (LEO) constellations that can guarantee high throughput broadband services with very low latency is therefore a growing field, [6].

In this paper, we will outline some of the biggest opportunities along with the largest hurdles in terms of implementation needed to overcome in order to bring these technology components into a real deployment. First, in Chap. II, we will discuss issues related to distributed massive MIMO. Chap. III outlines some important aspects related to sub-millimeter wave semiconductor and hardware design. This is followed by Chap. IV, in which energy harvesting and SWIPT is discussed. Before the concluding discussion, we will discuss some opportunities in satellite communication in Chap. V.

II. DISTRIBUTED MASSIVE MIMO

One of the major innovation-steps toward beyond-5G communication on a network level, is cell-free and distributed massive MIMO. In this chapter, we will discuss some of the foreseen benefits of both concepts, along side with some of the major challenges regarding implementation.

A. CELL-FREE MASSIVE MIMO

Cell-free massive MIMO, also known as Large-Scale Distributed MIMO (LS-D-MIMO), [3], is a multi-antenna technique which makes use of a large number of distributed antennas in order to serve a set of User Equipment (UE). This technique builds on the theory of massive MIMO [7], but with the assumption that the antenna elements distributed in space instead of being co-located. UEs are surrounded and served by nearby antennas and, as seen from the UEs, there are no hard cell borders in the system. In many scenarios LS-D-MIMO can provide a more uniform performance and higher system capacity compared to centralized massive MIMO solutions [8]. On high frequency bands (millimeter-wave and above) where the radio propagation environment is characterized by high blocking, low object penetration, and little diffraction, the macro-diversity gains provided by large-scale antenna distribution can ensure that robust performance is achieved on the access link while UEs move around in the service area.

However, good theoretical performance is not sufficient for commercial success. Massive distribution of antennas in space

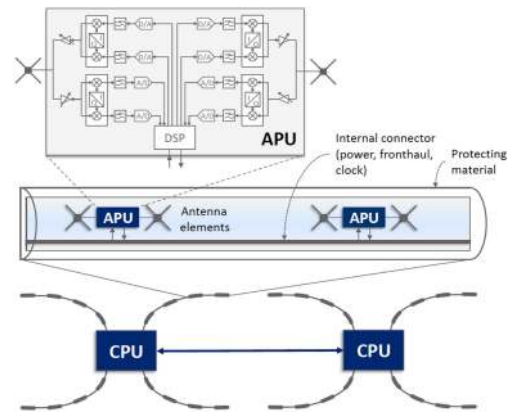

FIGURE 1. Example of large scale distribution of MIMO using a Radio stripe system design. Each radio stripe sends/receives data to/from one or multiple CPUs through a shared internal connector, which also provides synchronization and power supply to each APU.

requires a new approach to network deployment to become practical. Assuming dedicated front-haul cables to each distributed Antenna Processing Unit (APU) does not scale. If we are to deploy several tenths or hundreds of APU in an area then we cannot view the location of an APU as a *site* in the traditional sense, and each APU need to be extremely small compared to regular *small cell* equipment. Requirements on network planning need to be relaxed and APUs should be installed where possible rather than in optimal locations. The network rollout need to be a bulk process where many APUs are deployed at a low cost by non-expert personnel requiring as little manual labor as possible per APU-installation. To address these and other challenges the *radio-stripe* concept [9] is proposed recently, see Fig. 1. In a radio stripe system, the distributed antenna elements and the associated APU are serially connected and located inside the same cable, which also provides synchronization, data transfer, and power supply via a shared bus. The actual APU consist of a small group of antenna elements and circuit-mounted chips (including power amplifiers, phase shifters, filters, modulators, and Analogue-to-Digital Converter (ADC) and Digital-to-Analogue Converter (DAC)) inside the protective casing of a cable or a stripe. Each radio stripe is then connected to one or multiple Central Processing Unit (CPU) units.

Note that radio stripes, as depicted in Fig. 1, cannot provide a good solution for large scale distribution of antennas in every possible deployment scenario. The radio stripe in Fig. 1 is only one example on how the practical deployment problems with LS-D-MIMO can be addressed, but this is not the only solution possible. This solution assumes a digital and electrical front-haul interface such as Ethernet that can provide data transfer of digital base-band signals between the CPU and the APU (e.g. 10 Gbit Ethernet), power supply (e.g. up to 100 W with IEEE 802.3bt Type 4 PoE, *Power-over-Ethernet* [10]), and synchronization (e.g. IEEE 1588-2019 PTP, *Precision Time Protocol* [11] and ITU-T SyncE, *Synchronous Ethernet* [12]).

In the Fig. 1 example we further assume that the antenna pre-coding and combination weights are calculated in the distributed APU in a digital signal processing (DSP) device. This has the benefit of not requiring a large amount of channel state information (CSI) and antenna weights to be communicated over the front-haul but it does add complexity and power consumption to the APU. These things considered, a solution for LS-D-MIMO based on a digital Ethernet front-haul, as in the radio stripe example, can be suitable for lower frequency bands where only a limited bandwidth is available (e.g. sub-6 GHz).

For systems with very high bandwidth (e.g. mmW and above), a fronthaul bitrate of 10 Gbps may be insufficient and an optical or a wireless fronthaul interface may be required. An architecture with a digital front-haul will require DAC and ADC in the distributed APU which increases the power consumption (and thereby the required physical size due to heat dissipation) of the APU as the bandwidth increases. For high bandwidth deployment an fiber-based interface such as analog radio-over-fiber [13] or $\Sigma\Delta$ -over fiber [14] can be more suitable, as discussed further in Sub-section II-B and II-C.

B. DIGITAL SYNCHRONIZATION AND IMPAIRMENT MITIGATION TECHNIQUES FOR ACTIVE ANTENNA SYSTEMS

In 5G and beyond, active antenna systems play an important role for high-speed connectivity. A high array gain will be required at mm-wave, to compensate for power generation limitations and high path loss. At lower frequencies, it will be important to enable spatial multiplexing for efficient usage of the limited bandwidth resources.

A special challenge is the *calibration*.¹ For distributed antennas systems, there is an additional complexity in the synchronization, due to the use of independent oscillators at each APU. While calibration and synchronization are very important for Beam-forming (BF), they are even more so for null-forming, i.e. the process of canceling signals from certain directions or positions. To create a null in the radiation pattern requires extremely accurate calibration, and can be a challenge in 5G and beyond. The Down-Link (DL) is usually considered to be the most challenging to calibrate [15].

Calibration and Reciprocity Calibration: In order to calibrate a transmitter, the transmitted signal must be captured, to be used in algorithms to compensate the hardware and ensure that the desired signal is actually transmitted. Traditionally, this has been achieved by an observation receiver connected to each transmitter output. However, due to several reasons the per-antenna observation receiver is not desirable for 5G and beyond. Firstly, it will be costly with the possibly very

¹In this paper, we will mean calibration in a very general sense, not only including gain and phase of transmitters and receivers, but also linearization, I/Q imbalance compensation, phase noise tracking, and impairment mitigation in general. From this perspective synchronization is a special case, including phase, sampling time, carrier frequency calibration.

large number of antennas. Also, in a multi-antenna transmitter, the transmitted signal (or rather the signal that is experienced by a UE, or by a victim) is a combination of all the antenna signals, so that the output of individual transmitters does not tell the complete story. Further, the progress towards integrated systems makes it difficult to access the signals at the transmitter outputs. These issues means that Over-the-Air (OTA) signal acquisition will be necessary; perhaps through an antenna/receiver within the array, or through an external receiver.

While phased-array beamforming requires absolute calibration, i.e. the transmitter and receiver compensate the behavior of their own circuitry [16], in contrast so called reciprocity calibration is of particular interest in the context of this paper [17]. For reciprocity-based communication, as in the typical definition of massive MIMO, it has been shown that absolute calibration, as it is usually defined, is not necessary; the only calibration that is needed is to ensure that Transmitter (TX) and Receiver (RX) RF chains are reciprocal [18] (which they are typically not without calibration). Reciprocity calibration can be performed through the exchange of pilot signals [18], but it is more desirable with protocols that can work without collaboration with UE. In [19], a software-defined radio solution, implementing a Time Division Duplex (TDD) reciprocity calibration technique, was proposed. This technique use two-way signaling involving only the base station antennas, possibly also with an additional external reference antenna. Rogalin *et al.* [15] defines a graph of the network, where all access points exchange calibration pilots with their neighbors, and it is shown that the proposed solution scales favorably with network size, compared to previous proposals. In [20], Vieira *et al.* show that antenna coupling can be exploited for pilot-free calibration schemes, with the sole requirement that the coupled antenna channels are reciprocal.

OTA linearization (i.e., compensation of a nonlinear amplifiers) has been studied in e.g. [21], where nonlinear amplifiers are modeled and compensated based on known antenna coupling coefficients. The technique is further developed in [22] to also find the unknown coupling coefficients, and is demonstrated in a 4-antenna experimental setup. Other papers addressing this are [23], [24].

The calibration challenge in distributed MIMO is similar to the challenge in co-located MIMO. However, the issue of synchronization is more challenging for distributed systems; we discuss this in the the next subsection.

Synchronization: Synchronization is a subset of calibration, indicating the issues connected to the oscillators in the system. With any multi-user MIMO system, each UE will have independent oscillators, creating multiple synchronization tasks for each APU. Further, in a distributed MIMO system, the access points will also have independent oscillators, which will create problems when synchronized (phase-aligned) transmission should be used in the DL.

To achieve phase-coherent DL transmission, carrier frequency, sample time and phase must be accurately synchronized. Often, these issues are jointly estimated and

compensated [25], sometimes also combined with channel estimation [15]. In [26], Nasir *et al.* provides an overview of timing and carrier synchronization algorithms, both for single-antenna, and for co-located and distributed MIMO systems. Many proposed synchronization protocols in the literature does not scale well with the number of nodes (antennas) in the network. This is due to that they assume a central master station transmitting a beacon signal which all APU in the network must listen to [27], [28], or that proposed consensus protocols converge extremely slowly [29]. Others study more decentralized schemes [30], e.g. based on a few anchor nodes, [31].

In [32], it is shown that frequency synchronization in distributed MIMO requires approximately 50% more pilots than co-located MIMO, and that the Mean Squared Error (MSE) of the frequency estimator is M times worse for distributed MIMO, where M denotes the number of antennas used serving the UE. This is due to the fact that the antennas in distributed MIMO may all have different Doppler shifts, while it can be assumed that the Doppler shift is identical for all the co-located antennas. It is also illustrated that synchronization accuracy improves with M in a co-located system, while it is independent of M in the distributed case. The consequence on achievable rate in the two systems is that the distributed system needs more synchronization efforts to avoid severe degradation in throughput.

To achieve a synchronized MIMO DL, digital radio-over-fiber has been proposed [33]. An interesting technique is to use $\Sigma\Delta$ -modulation [14], allowing much simpler access points since no DAC is needed. Synchronized $\Sigma\Delta$ -encoded digital RF is transmitted over optical fibers to each access point, and phase-coherent transmission is relatively simple to implement. Up-Link (UL) is more challenging, but a low-complex 1-bit UL has been demonstrated and shows good performance [34].

In 3GPP standardization efforts, a Phase Tracking Reference Signal (PTRS) is introduced as a part of the frame structure in 5G NR [2]. The PTRS signal is mainly used to compensate for the common phase error in OFDM signaling, but its use can be extended for more elaborate purposes. By controlling the density of the PTRS signal, the tradeoff between synchronization accuracy and transmission overhead can be controlled [35].

C. BASEBAND ALGORITHMS: CENTRALIZED OR DISTRIBUTED?

For distributed massive MIMO systems, there are two obvious approaches for baseband processing: Centralized or Distributed. While centralized baseband processing enables best-in-class spectral efficiency, as channel estimation, data detection, precoding, etc., can be performed using well-established algorithms at a centralized processing node, such a naïve approach inevitably results in prohibitively high backhaul data rates if the number of APUs grows large. In fact, even if the backhaul would support the transfer of raw baseband data from hundreds of Remote Radio Heads (RRHs),

processing such a vast amount of information in a single computing fabric (e.g., an ASIC or FPGA) is likely to fail for two reasons: First, the chip input/output interface may not provide a sufficiently large number of pins, even with cutting-edge Serializer/Deserializer (SerDes) interfaces. Second, a single computing fabric is expected to be unable to process the high data rates of beyond 5G systems with hundreds of antennas and bandwidths in the GHz regime, even in the most advanced technology nodes—the power density and chip costs would simply be too high.

As a remedy to these challenges, Decentralized Baseband Processing (DBP) has been proposed in [36], which relegates the key baseband processing task closer to the antennas. More concretely, DBP divides the antennas into antenna clusters, each performing separate channel estimation as well as local equalization and precoding. While initial DBP schemes iteratively exchange consensus information among the antenna clusters [36], they increase processing latency to unacceptable levels. Hence, feedforward architectures, which avoid the latency bottleneck while providing optimal or near-optimal spectral efficiency have been proposed recently for both the UL [37] and DL [38]. In the uplink, the local equalization results are transported to the centralized processor which fuses the acquired information—this significantly reduces backhaul data rates, merely operating at the symbol rate. In the downlink, the centralized processor prepares a precoding vector which is then transferred to the APUs for further local precoding. Interestingly, DBP with feedforward architectures is able to achieve the same performance as centralized linear equalization and precoding schemes (such as linear Minimum Mean Square Error (MMSE) equalization or linear Wiener filter precoding) thereby offering a scalable solution that enables distributed massive MIMO systems in practice.

III. SUB-MILLIMETERWAVE/THZ COMMUNICATION

In parallel with the evolution towards distributed MIMO systems for increased capacity, there is also a strong push to exploit the large spectrum available at sub-millimeterwave / THz bands in 6G wireless communication systems. This section will review the main technological challenges and research ongoing to enable this development.

A. SEMICONDUCTOR TECHNOLOGY CAPABILITIES

Semiconductors with their continuously increasing computing power, energy efficiency and decreasing IC size, have revolutionized communications and computing over the last fifty years or so [39], [40]. However, the direction and pace of future semiconductor innovation and the vitality of Moore's law are increasingly uncertain.

In communications, Complementary Metal Oxide Semiconductor (CMOS) and system-on-chip integration are most relevant. However, to fulfill all the requirements from the infrastructure to the terminal/edge devices, the choice of the fabrication process has to be strictly linked to the final application specifications and to the technical implementation trade-offs, such as the desired level of integration, frequency, bandwidth

and operating range [39], [40]. With the deployment of 5G, and already having beyond-5G wireless communication systems in mind, there is a clear demand for high-performance computing combined with high quality analog functions and the push towards mm-wave and THz frequencies to be handled by the RF circuits. Therefore, a wide variety of technologies is required and there is a strong push for technology diversification to achieve benefits at the system level. In this respect, heterogeneous integration of different technologies is gaining in importance, and 3D integration and packaging with antenna in package capabilities play prominent roles as enabling technologies.

For high-performance digital signal processing and computing, current sub-10 nm CMOS and future technologies with logic transistors that can deliver even higher speed at reduced supply voltage and cost are required. In analog and RF design, not only a sufficiently high f_i/f_{\max} is necessary, but other parameters like output signal power, quality of on-chip passive components, noise issues and robustness to process and temperature variations, are most significant.

For RF-CMOS design, modern CMOS processes with a feature size of 28 nm and below yield transistors with f_i/f_{\max} well above 200/250 GHz, thus making mm-wave designs feasible. On the other hand, the continuous gate-length scaling, which simultaneously increases the intrinsic speed of Metal Oxide Semiconductor Field Effect Transistor (MOSFET) as a by-product, is leading to a deterioration of gate and wiring resistances and is limiting a further increase of f_{\max} . The relevant process options, in addition to bulk CMOS, are Fully Depleted Silicon on Insulator (FD-SOI) and FinFET technologies. FD-SOI is superior to bulk CMOS in terms of speed, series resistance and compatibility. Fin Field Effect Transistor (FinFET) has an advantage in gain, in subthreshold-slope and in shrink capability towards 5 nm.

In the Silicon-Germanium (SiGe) bipolar and Bipolar CMOS (BiCMOS) process development, there has been good progress and these technologies are extensively used for mm-wave RF design [41]. Today, SiGe technologies with $f_{\max} > 600$ GHz and $f_T > 300$ GHz are available. This excellent RF performance is achieved with a very cost efficient 90 nm process lithography. An extended temperature range, high reliability and a long process lifetime are important features of the SiGe technologies. Other SiGe-bipolar features, such as a four times higher breakdown voltage compared to CMOS (for identical f_{\max}), are most useful in circuits like power amplifiers and Voltage Controlled Oscillator (VCO) to achieve a very low phase-noise. In practical applications, the collector base breakdown voltage is most important and it is about 5V in a SiGe bipolar transistor with $f_{\max} > 600$ GHz. Moreover, the four fold improvement in the ratio of g_m/I_c (g_m/I_{DS} in CMOS) in the SiGe bipolar transistor is essential for saving current.

Contrary to CMOS technology, the speed of SiGe Heterojunction Bipolar Transistor (HBT) devices is projected to continue to improve with transistor scaling in the future [42]. Results obtained from a theoretical analysis of the electrical

performance limits of SiGe HBT indicate that operating frequencies exceeding 1 THz are within reach [43]. It is expected that an f_{\max} of 1 THz will be achieved with a 40 nm process lithography. Therefore, SiGe-BiCMOS technologies are an interesting option for mm-wave and THz circuits at a very reasonable price-performance ratio.

Finally, because of the limited output power capability of silicon-based technologies, Gallium Nitride (GaN) or other III-V devices with their unique properties of high sheet charge, high electron mobility and wide bandgap are needed to fulfill the output-power and efficiency requirements [40]. For example, GaN devices can deliver a power density of 3.6 W/mm at 86 GHz in continuous wave operation and a P_{\max} of 3.6 Watt at 83 GHz was reported in pulse mode [44]. For an efficient implementation, there is also an ongoing effort to co-integrate GaN or III-V devices with CMOS or BiCMOS [45]. This co-integration can be enabled either by using monolithic integration where the III-V devices are placed next to CMOS in the same substrate or by employing heterogeneous integration to develop modules also incorporating microwave elements as well as Antennas-in-Package (AiP).

B. INTEGRATED THZ TRANSCEIVER CIRCUIT DESIGN

While commercial chipsets for wireless communication exist for transmitters and receivers up to frequencies of about 100 GHz, RX/TX solutions above 100 GHz is a challenge and still a subject of intense research. As mentioned above, possible process candidates include silicon CMOS, SiGe BiCMOS, as well as III-V based Indium Phosphide (InP) High Electron Mobility Transistor (HEMT), InP Double Heterojunction Bipolar Transistor (DHBT), Gallium Arsenide (GaAs) HEMT, and GaN-HEMT technologies, in some cases in combination with photo mixing. Several challenges become serious above 100 GHz, such as generating the required output power, noise figure, the signal-to-interference level, local oscillator noise, I-Q imbalance, semiconductor process stability, reliability, process yield, packaging, chip-to-chip transitions etc.

A typical transceiver architecture consists of a receiver with a low-noise amplifier, I-Q mixer, and local oscillator chain with frequency multipliers. The transmitter-part has a similar architecture, but the mixer is followed by a power amplifier. The local oscillator including circuits for phase locked loop is mostly not included. Instead of an I-Q mixer, a modulator supporting simple, low-order modulation-types can be implemented, which however limits the flexibility of the RX/TX chipset. An I-Q architecture gives a large flexibility in the choice of waveform. In addition, side-band rejecting receivers and transmitters can be easily implemented.

The RF-power generation in the transmitter is a key challenge, which becomes increasingly serious as the frequency is increasing. The required output power of the wireless system might be the most important factor when a semiconductor technology is selected, if the power amplifier should be included in the transmitter chip. If the power amplifier and the TX is separated, the electromagnetic transition between them

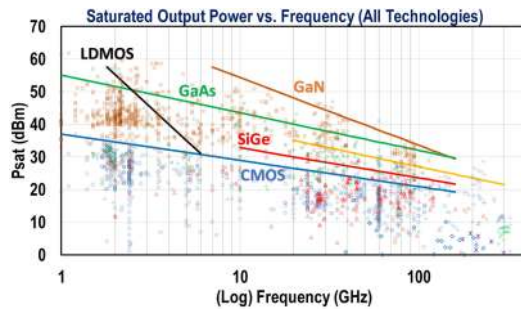

FIGURE 2. Estimated saturated output power for different technologies versus frequencies, [46].



FIGURE 3. Example of a packaged 90–140 GHz MMIC amplifier utilizing E-plane probes with bond wire connections.

will degrade the overall performance in terms of loss, efficiency and bandwidth. A survey of the saturated output power from Power Amplifier (PA) Monolithic Microwave Integrated Circuit (MMIC), recently demonstrated in different semiconductor technologies, are shown in Fig. 2. The represented technologies are GaN-HEMT, GaAs pseudomorphic HEMT (pHEMT), InP DHBT, SiGe HBT, InP HEMT and CMOS. The highest output power is generated by GaN-HEMT PA up to frequencies of approximately 100 GHz, followed by GaAs pHEMT PA. Well above 100 GHz, InP DHBT, InP HEMT, and SiGe HBT become apparently the most interesting alternatives. Note a very steep slope of output power versus frequency, of the order of $\sim 1/f^3$. Most published integrated transmitter chips well above 100 GHz have integrated PA with modest output power, typically below 10 dBm.

C. INTEGRATION, PACKAGING AND ON-CHIP INTEGRATED ANTENNAS

The full realization of high data rate data transmissions beyond 100 GHz is setback by the lack of low-loss and low-cost interconnects. This challenge is more critical in highly integrated systems where the whole radio front-end is integrated in a single MMIC. In such a case, conventional packaging techniques are not suitable for several reasons. The problems of packaging active circuits at these frequencies are mainly at the interface between the RF ports of the circuit to a waveguide, which is the preferred guide-media at frequencies above 67 GHz. Bond-wires are commonly used to connect the RF port of the MMIC to an intermediate waveguide-to-microstrip transition as shown in Fig. 3. The transition has a subcritical width and does not allow waveguide modes to enter the cavity housing the MMIC. Bond-wires, however, exhibit large reactance above 100 GHz, which is difficult to

match and existing compensation techniques result in narrow-band performance. In addition, bonding to small-sized high-frequency RF pads presents repeatability challenges, reduction in yield and increased manufacturing cost. The large bond-wire reactance and unwanted radiations inhibit its application at mm-wave or sub-mm-wave frequencies, both in terms of manufacturability and performance. The ultimate solution to the problem of connecting the MMIC to a rectangular waveguide would be to integrate a waveguide transition in the circuit and thus avoid the need for bond-wires. This approach has a drawback that the circuit has to be narrow in order to block waveguide modes propagating between the waveguide and the cavity in the circuit. One solution is to have an oversized MMIC with integrated waveguide-to-microstrip transition coupled directly to the waveguide, where the unwanted mode-coupling between the waveguide and the cavity containing the MMIC is suppressed by using a periodic metal pin structure as demonstrated in [47]. Such a structure acts as a Perfect Magnetic Conductor (PMC) and changes the boundary conditions inside the MMIC cavity, thus suppressing all unwanted higher-order cavity modes without detrimental effects on the desired microstrip mode [48]. To illustrate, a probe-loss of less than 0.4 dB has been demonstrated at W-band. This concept has also been successfully implemented in highly integrated D-band RX MMIC [49]. The packaging concept also utilizes the periodic pin structure to suppress higher-order cavity modes. This transition concept cover the full D-band with typical insertion loss of 0.5 dB.

Radiating elements integrated onto the MMIC can be coupled to an external optical component or radiated directly into free-space in applications where the transition from the MMIC to a rectangular waveguide is not required. Previous research efforts in mm-wave imaging resulted in compact integration of active circuitry, such as Low Noise Amplifier (LNA) mixers and sources, with antenna elements where a number of pixels can be coupled to the same optical component.

Integration of an LNA and a mixer, together with a planar antenna has been demonstrated in [50] at 220 GHz where the MMIC is directly mounted on a silicon lens. The technology used in this work is the 100 nm metamorphic HEMT (mHEMT) from IAF. This RX is a part of an active imaging radar featuring a noise figure of 8.4 dB, bandwidth of 40 GHz and antenna efficiency of 80%.

Some MMIC processes, such as Teledyne Scientific's 250 nm DHBT, offers a multi-layer metal and dielectric structures on top of the wafer which opens new possibilities for the designs of compact planar antennas combined with active circuits. The RX, shown in Fig. 5, consists of an LNA and a power detector integrated with a double slot antenna, [51]. Mounting the chip on a silicon lens with diameter of 10 mm results in directivity of 24 dBi with efficiency of around 1.7 dB. The measured noise figure at 160 GHz is 10 dB.

An attractive solution for THz-modules is based on micro-machined waveguides in silicon [52], [53]. Active and passive circuits like filters, phase shifters, switches, antennas etc

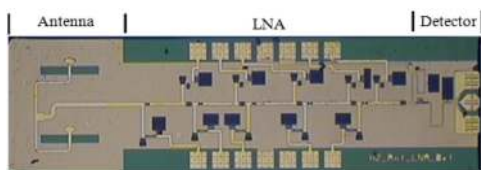

FIGURE 4. Photo of 160 GHz RX front end based on a multilayer DHBt process.

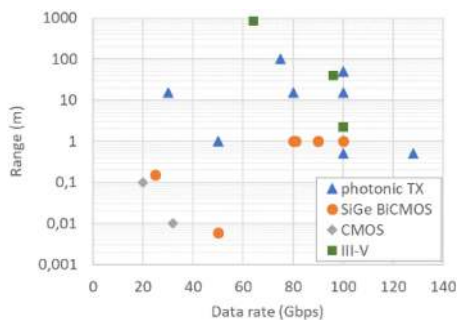

FIGURE 5. Reported data rates with achieved link distances in radio link demonstrators at 190–425 GHz region [56]–[72].

can be heterogeneously integrated for operation at frequencies even beyond 1 THz. This technology has a potential of low-cost production since batch processing of large silicon wafers can be utilized, similar to CMOS technology. The very low loss of micromachined waveguides [54], of the order 0.086 dB/mm at 400 GHz.

D. SYSTEM DEMONSTRATIONS

Demonstrating radio system or only individual link performance beyond current 5G test beds is extremely challenging. Such systems require a comprehensive setup to measure the quality of the modulation, at least in RF-to-RF characterization with transmit and receive modules operating through antennas OTA, and preferably also signal up and down conversion functions. OTA is of course already a necessity in 5G system testing but more and more RF link characterization at early research phase must be moved to OTA as frequency moves up. That is due to difficulty of reliable measurement interfaces when even very small parasitics have a major impact on the result and antennas need to be either integrated on-chip or otherwise with very small parasitic load to RF electronics. Fortunately, with advanced OTA methods it is possible to evaluate link performance and even noise figure, other RF parameters, and maximum link ranges based on Error Vector Magnitude (EVM) or other means for the whole system [55]. Of course, extracting details from the whole system, including both receiver and transmitter, is not straightforward and information of separate parts from stand-alone probe measurements is highly preferred.

Another major difficulty in defining real performance of extremely high speed and wideband communications systems is the challenge of bit processing. Complete modem solutions

are typically only available once standards are ready and matured. Further, the high-speed requirement poses several other issues when capturing signals. When very high-speed signal analyzers are not available in the market, a typical solution is to use very fast multi-channel oscilloscopes and post process signals offline to prove the feasibility. As signal processing complexity and quality requirements are proportional to sampling speed and accuracy, the prototyping of high-speed links is typically done using simple single carrier-type modulations and relatively low Signal-to-Noise Ratio (SNR) requirements. Still in that case, in addition to phase noise, issues like channel/phase equalization, not so visible in OFDM based systems, should be considered with care taking also other RF impairments like frequency dependent IQ imbalance into account. These insights are also highly valid in the discussion of waveforms for beyond-5G systems. Already in 5G, digital signal processing consumes a lot of power including data conversion. OFDM, massive MIMO, and high-order modulations are therefore no longer obvious choices for future extremely high-speed systems. Instead, simple and hardware-friendly modulation schemes should be considered seriously at the cost of extreme spectral efficiency, finding the best compromise between spectral and hardware efficiency for different frequency regions.

Link performance has been demonstrated for tens of Gbps communications in several OTA trials both for optical [56]–[61] and electrical [62]–[72] transmitters using different technologies. The receive end is typically electrical. Fig. 5 shows achieved data rate vs. link range reported in those references. Technology demonstrations have been built around measurement equipment and they represent Line-of-Sight (LOS) performance without beam steering capability. Signal capture and processing of SC modulations up to 64-QAM have been performed using measurement equipment with or without offline processing.

As link performance is limited by output power, noise, antenna gain and many other factors, rather low complexity of the recently published high-speed radios will not give straightforward trends to evaluate technological boundaries. Still some rather obvious conclusions can be made. Optical and III-V semiconductor technologies can boost the link range significantly while conventional technologies for highly integrated 5G transceivers i.e. SiGe and CMOS suffer from more limited output power and higher noise. Therefore, search for cost efficient and well performing technology is one of the key challenges in the path towards future communications systems.

IV. ENERGY CONCERNS AND ENERGY HARVESTING

Energy consumption is a significant concern for 5G, and it is expected that also future mobile communication networks needs to consider energy efficiency carefully. One of the strategic lines of 5G and beyond is the massification of IoT devices, [73], allowing continuous monitoring of a vast number of devices. This is to optimize the overall ecosystems and smart environments in all aspects that is considered useful for

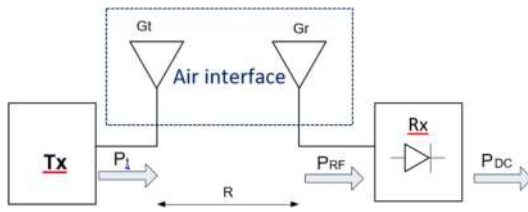

FIGURE 6. Wireless Power Transmission approach.

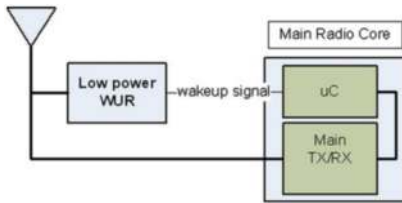

FIGURE 7. Simplified block-diagram of a Wakeup Radio receiver.

the well being of humanity and environmental sustainability. The problem facing the massification of IoT devices is the amount of batteries used to operate the sensors. This can create a significant impact in CO₂ creation for 5G communication and beyond, unless alternative solutions are competitive. Some alternative solutions including energy harvesting for the sensors, [74], coming from thermal converters, solar energy aggregators, mechanical generators using wind of other sources of kinetic energy and ultimately electromagnetic energy harvesting [74], where electromagnetic energy is collected over the air interface and converted back to DC energy.

The electromagnetic energy harvester can use existing electromagnetic signals already present in the air, such as 4G/5G, WiFi and others, or can be harvested from a specifically tailored beam of energy that is directed to the sensor itself. Typically, an RF or laser beam is created and transmitted to energize the sensor, so-called Wireless Power Transmission (WPT), and it is expected to supply a significant part of the energy in 5G and beyond for IoT sensor sustainability.

WPT can be implemented using electromagnetic beams and—similar to wireless communications—create an RF signal, transmit it using an antenna and collect it using a RF-DC converter, as depicted in Fig. 6. This normally allows power transmission to sensors that are at a few meters of distance. Another way is to use inductive coupling, something used already today in wireless charging of mobile phones, where the transfer distance can be in the order of centimeters or up to 1 meter if resonant inductive coupling is used, [74]. Another approach to increasing the energy efficiency in these sensors is to use Wakeup Radio (WUR), [75], where the sub-systems are placed in sleep-mode until triggered into operation, as depicted in Fig. 7. In this scenario the main radio is sleeping, consuming no energy, and is waked up according to a wake up radio signal.

On top of this, user-specific data can also be added on top of the power transfer, creating what is called SWIPT. The signal

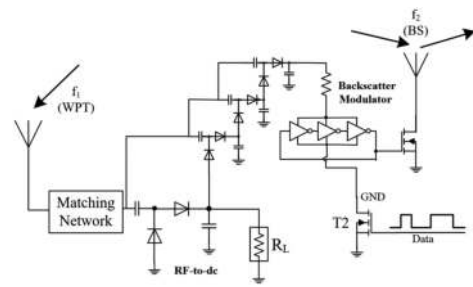

FIGURE 8. Schematic representation of the IoT wireless energy receiving unit with backscatter capabilities.

which charges the sensors also contains information, and in this case we can achieve traditional wireless communication links, [76], and/or backscatter communications on top of WPT [77]. We will now discuss some enabling circuit-solutions.

A. WIRELESS POWER TRANSMISSION FOR SUSTAINABLE IOT SENSORS

WPT has three main alternatives: inductive/capacitive coupling, resonant inductive/capacitive coupling or far-field electromagnetic transmission. The coupling solutions are quite interesting for small distances, around tens of meters which have been reported in the literature, [74]. Figure 6 presents an overview of the general concept of WPT far-field systems, where three main components are denoted as:

- *DC-RF generator*: converts DC to RF energy.
- *RF-RF Air interface*: transmits the RF energy from the source to the probe.
- *RF-DC converter*: converts RF energy to DC, powering up the probe.

Advancing the state of the art will improve the conversion efficiency of each component. The main objective is to transmit an electromagnetic beam as a mean to wirelessly transfer a desired amount of the electric power from the base station to the probe. After the DC conversion, we need a sufficient amount of energy to power up the IoT sensor itself. For this to be achieved the whole chain has to be optimized in terms of efficiency point. The overall efficiency is evaluated as:

$$\eta_{DC-DC} = \eta_{DC-RF} \cdot \eta_{BEAM} \cdot \eta_{RF-DC} = \frac{P_{DC,RX}}{P_{DC,TX}} \quad (1)$$

where the DC-RF conversion is denoted η_{DC-RF} , η_{BEAM} is the antenna beam efficiency and η_{RF-DC} is the RF-DC conversion. $P_{DC,RX}$ and $P_{DC,TX}$ denotes the received and transmitted power, respectively. These efficiencies can be optimized individually by exploring each of the sub-systems. The secret ingredient here is to try to create focus of energy rather than beams of energy, and thus be able to optimize the energy transmission between the transmitter and the receiver, while managing interference toward other devices and co-located systems. In [78], a solution was developed to track IoT autonomous sensors, and to focus energy on those sensors. Fig. 8 presents the IoT device energy approach that contains the

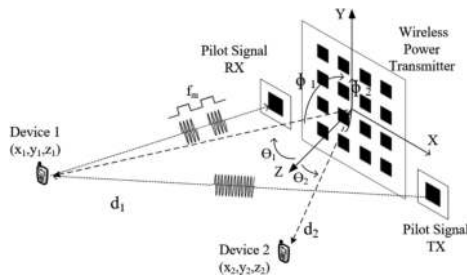

FIGURE 9. Representation of the WPT system for IoT devices.

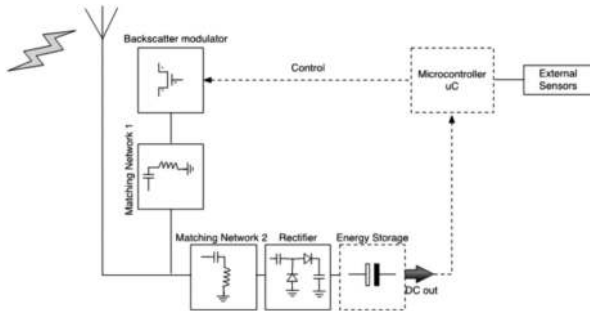

FIGURE 10. Circuit block-diagram of a SWIPT system with backscatter combination.

RF-DC converter but also a backscatter modulator that is used to feedback to the transmitter the amount of energy the sensor is receiving. More work is needed for future WPT links in beyond 5G IoT sensors. The overall solution will likely be similar to the one presented in Fig. 9, where an active array is used with backscatter receiver used for energy feedback approaches. Further on, for wearable and other body-near devices, health aspects needs to be considered before deployment.

B. SIMULTANEOUS WIRELESS INFORMATION AND POWER TRANSMISSION

Another concept is to add information to the signal used for transmitting power, this is called SWIPT. In this case, the data-signal can be added directly to the power transmission. Some examples are presented in [76], where a new concept towards 1G Mobile Power Networks is presented, or the solution used for communications can be completely changed, as in the case of using backscatter, as depicted in Fig. 10. In this case, the communication is not obtained using traditional super-heterodyne systems, but using a concept that goes back to radar-systems where the backscattered wave from an antenna can be changed if the antenna impedance changes. This can be implemented using an optimized solution in the design of the IoT sensor. In [77], the authors present the combination of WPT and backscatter communications using two frequency channels, which has the potential to enable a fully batteryless approach for IoT. In [79], the authors implemented a sensor with the capacity of transmitting Gbps with a 4 meter coverage and consuming pJ for the transmitter stage, making

it a candidate implementation-solution for future mobile IoT communication.

C. WAKEUP RADIO SOLUTIONS

WUR architectures use two radios as illustrated in Fig. 7: a main radio purposed for wireless communications, and a second low-power WUR, which is permanently monitoring the received signal, waiting for a specific wakeup pattern. Upon receiving the expected pattern, the WUR wakes the main radio up. Since the WUR is always on, this configuration will only be effective if the WUR exhibits negligible power consumption. So WUR are generally based on RF-DC converters, but with a more detailed specific characteristic where the receiver should be connected to an extremely low-power micro controller tasked only with decoding the specific wake-up pattern.

V. SATELLITE COMMUNICATION

The next generation wireless communication is envisioned as a flexible, efficient and resourceful platform, offering advanced capabilities that will form the basis for future applications and new business opportunities. The new applications will mainly depend on connectivity to new radio access networks that provide high bandwidth, ultra-high reliability and low latency. This scenario demands a great investment in the telecommunications field. In satellite communication, the market is already moving towards a generation of new satellite constellations in LEO and Medium Earth Orbit (MEO) as a way to solve the global coverage of mobile broadband. Since these satellites occupy lower orbits than Geostationary Earth Orbit (GEO), the systems complexity and their inherent costs can be reduced [80]. At the same time, transmission data rates, along with latency, might be improved.

As stated in [81], there are 40% of the Earth's regions without network coverage, which means that there are still 4 billion people on the planet without Internet access. In order to connect everyone, the satellite Internet proves to be a very good solution, more precisely by utilizing LEO communication satellites. With these new constellations it is possible to achieve ubiquitous wireless coverage with an easy access to information, especially in areas where terrestrial networks are difficult to implement or with a very high cost. These are the main motivations for the renewed interest in LEO communications and another key factor was the private investment and ventures.

A. LEO CONSTELLATION

The idea of providing Internet access from space has been emerging in recent years. A new wave of proposals for large constellations of LEO satellites to provide global broadband access appeared in 2014–2016 [82]. The main differences from the prior systems are:

- The increased performance that results from the use of digital communication payloads;
- Advanced modulation schemes;
- Multi-beam antennas;
- Reduced launch costs.

TABLE 1. User Terminal UL and DL Frequencies–Kuiper Constellation

| UL/DL Frequencies (GHz) | Satellite Antenna type | Link Polarization |
|-------------------------|--------------------------------------|-------------------|
| 28.35 - 28.6 (UL) | Phased Array | RHCP/LHCP |
| 28.6 - 29.1 (UL) | Phased Array | RHCP/LHCP |
| 29.5 - 30.0 (UL) | Phased Array | RHCP/LHCP |
| 17.7 - 18.6 (DL) | Phased Array | RHCP/LHCP |
| 18.8 - 19.3 (DL) | Phased Array | RHCP/LHCP |
| 19.3 - 19.4 (DL) | Phased Array </td <td>RHCP/LHCP</td> | RHCP/LHCP |
| 19.7 - 20.2 (DL) | Phased Array | RHCP/LHCP |

From all the registered proposals within the Federal Communications Commission (FCC), there are four that are in an advanced stage of development, with launches planned in the next years: OneWeb’s, SpaceX’s, Telesat’s and Amazon’s. Telesat’s Ka-band constellation [83] comprises at least 117 satellites (at heights of 1110 km and 1248 km) and will use a bandwidth of 1.8 GHz in the lower spectrum of the Ka-band (17.8–20.2 GHz) for the DL and a bandwidth of 2.1 GHz in the upper Ka-band (27.5–30.0 GHz) for the UL. OneWeb’s Ku and Ka-band constellation [84] comprises 720 satellites (at a height of 1200 km) and employs the Ku-band for user and the Ka-band for gateway communications. In particular, the 10.7–12.7 and 12.75–14.5 GHz bands will be used for DL and UL user communications respectively.

The bands of 17.8–20.2 GHz and 27.5–30.0 GHz will be used for the DL and UL gateway communications respectively. SpaceX’s Ku and Ka-band constellation [85] comprises 4425 satellites (at a height of 1110 km to 1325 km) that will be distributed across several sets of orbits and will use the Ku-band for the user and gateway communications will be carried out in Ka-band. The 10.7–12.7 GHz and 14.0–14.5 GHz bands will be used for the DL and UL user communications respectively, while the 17.8–19.3 GHz and the 27.5–30.0 GHz bands will be used for the DL and UL gateway communications respectively.

Amazon’s Kuiper constellation [92] will comprise 3236 satellites with three different altitudes (590 km, 610 km and 630 km). The system will provide service using Fixed-Satellite Service (FSS) and Mobile-Satellite Service (MSS) at Ka-band frequencies, 17.7–18.6 GHz and 18.8–20.2 GHz (space-to-Earth), and 27.5–30.0 GHz (Earth-to-space). The user UL and DL frequencies are detailed in Table 1. As noted, both Right Hand Circular Polarization (RHCP) and Left Hand Circular Polarization (LHCP) are being utilized. The user DL will take advantage of phased array solutions on the satellite and the spectrum is divided into 100 MHz channels and can be aggregated into wider channels from 200 MHz to 500 MHz in bandwidth. The gateway UL and DL frequencies on the Kuiper constellation can be seen in Table 2.

These LEO satellites are normally power limited and must be used with high efficiency. Additionally, due to the high speed of the LEO satellites (5 km/s to 10 km/s) the user on the ground can only be attended from one satellite within a few minutes before it switches to another. Thus, from the user perspective, it is essential to have phased array antennas (electronic beam steering) to improve the system reliability.

TABLE 2. Gateway UL and DL Frequencies–Kuiper Constellation

| UL/DL Frequencies (GHz) | Satellite Antenna type | Link Polarization |
|-------------------------|------------------------|-------------------|
| 27.5 - 28.6 (UL) | Parabolic | RHCP/LHCP |
| 28.6 - 29.1 (UL) | Parabolic | RHCP/LHCP |
| 29.1 - 29.5 (UL) | Parabolic | RHCP/LHCP |
| 29.5 - 30.0 (UL) | Parabolic | RHCP/LHCP |
| 17.7 - 18.6 (DL) | Parabolic | RHCP/LHCP |
| 18.8 - 19.3 (DL) | Parabolic | RHCP/LHCP |
| 19.3 - 19.7 (DL) | Parabolic | RHCP/LHCP |
| 19.7 - 20.2 (DL) | Parabolic | RHCP/LHCP |

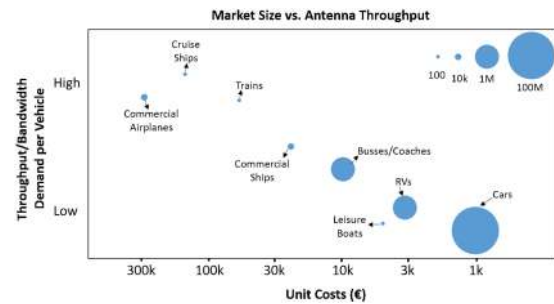

FIGURE 11. Market Size versus Antenna throughput.

B. USER TERMINAL

The 5G communication links promise a revolution in mobile communications with data rates in the order of Gb/s by using the available bandwidth at mm-wave bands, such as 28, 39 and 60 GHz. This next generation mobile network is envisioned as flexible, efficient and resourceful platform offering capabilities that will allow new businesses opportunities. To overcome the increased path loss at mm-wave bands, the next generation communication links will be based on directive communications, enabled by phased-array techniques which can result in low power consumption compared to sub-6 GHz links due to the array antenna gain [93]–[95]. As it is known, the phased-arrays have been used for many years for defense applications and satellite applications, but their need in the recent years for 5G applications made them a priority in terms of cost savings.

As can be seen from Figure 11 there are a lot of applications that can benefit from the use of phased arrays, although most manufacturers target small and high unit cost markets. In this context, satellite communications networks will have the task of: strengthening the capacity of land mobile networks, providing domestic and enterprise coverage where cable terrestrial networks fail to provide a high-performance alternative, especially for the business sector, where terrestrial networks do not have enough capacity and enable high-performance access for mobile applications (aeronautical, land and maritime transport). Thus, a low-cost and high data transfer system of electronically guided antennas to operate with non-stationary orbit satellites appears to be essential to fill the gaps in this emerging market. As can be seen in Figure 12, the user segment contains several user terminals, which include mobile and fixed terminals. In view of all this potential, several

TABLE 3. Fabricated MMIC Chips for Phased Arrays

| Reference | [86] | [87] | [88] | [89] | [90] | [91] |
|------------------------------|---------------------|---------------------------------------|---------------------------------------|---------------------------------|---------------------|---------------------------------|
| Process | 0.18~um SiGe BiCMOS | 28~nm LP-RF CMOS | 28~nm LP-RF CMOS | 0.13~um SiGe BiCMOS | 0.18~um SiGe BiCMOS | Multilayer PCB + 4 SiGe BiCMOS |
| Frequency (GHz) | 28 - 32 | 26.5 - 29.5 | 25.8 - 28.0 | 27.2 - 28.7 | 28.0 - 31.0 | 28.0 |
| Elements per chip | 4 TRX | 2x8 + 8 TRX | 8 TRX | 2x16 TRX | 4 TRX | 16 TRX |
| Elements in array | 64 TRX | 2x4 + 4 TRX | 2x8 TRX | 2x64 TRX | 32 TRX | 64 TRX |
| Chip area (mm ²) | 11.3 | 27.8 | 7.3 | 165.9 | 11.7 | 165 |
| IC integration level | RF front-end | RF front-end + PLL + RF/IF conversion | RF front-end + VCO + RF/IQ conversion | RF front-end + RF/IF conversion | RF front-end | RF front-end Antenna in Package |
| Polarization | Single | Dual | Dual | Dual | Single | Dual |
| Phase step (°) | 5.6 | 45 | 45 | 4.9 | 5.6 | - |
| EIRP at Psat (dBm) | 52 | 34-35 / pol. | 31.5 / pol. | 54 / pol. | 45 | 54 |
| RX NF/chip (dB) | 4.8 | 4.4 - 4.7 | 6.7 | 6.0 | 4.6 | - |
| Calibration | No | No | Yes | Yes | No | No |

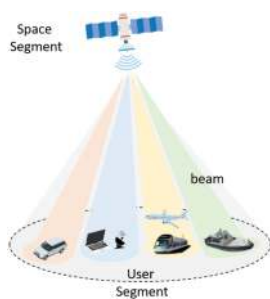
**FIGURE 12.** LEO satellite communication system from space to user segment.

companies have invested in electronic devices to position themselves as technology suppliers in this market segment.

This renewed interest in the LEO constellations have been explored during the past years, as can be seen on Table 3, which provides an overview of the state-of-the-art in fabricated MMICs for phased arrays. Most of the MMICs integrate both the RF front-end and RF/IF conversion to reduce the size and costs when produced in large scale.

Looking into the industry, there are some companies that have already developed phased arrays at Ka and Ku band. Isotropic Systems [96], Alcan Systems [97], C-Com Satellite Systems [98], Satixfy [99], Kymeta [100], Thinkom [101], Anokiwave [102], Hanwha Phasor Limited [103] are some of the examples that are already on the market commercializing user terminals with different approaches on the beamforming (mechanical or digital) or in some cases by using metamaterial (liquid crystal) for the phase shifting.

In summary, it is likely that satellite based communication will form an integral part of the beyond-5G and 6G communication infrastructure. Large synergies between hardware for millimeter wave terrestrial- and satellite terminals, combined with breakthroughs in reusable satellite launch systems could pave the way for bringing the costs down to a level where mass adoption is possible.

VI. DISCUSSION

In this review paper, we have outlined some of the opportunities and the associated key challenges facing the evolution

beyond-5G wireless communication. Technology components such as cell-free or distributed massive MIMO, sub-THz electronics, SWIPT and satellite communication are all possible enablers in the evolution toward 6G. However, for this to be brought to reality, a large amount of challenges still remains to be addressed in the research ahead.

REFERENCES

- [1] E. G. Larsson *et al.*, "Massive MIMO for next generation wireless systems," *IEEE Commun. Mag.*, vol. 52, no. 2, pp. 186–195, Feb. 2014.
- [2] A. Zaidi *et al.*, *5G Physical Layer: Principles, Models and Technology Components*. San Francisco, CA, USA: Academic, Sep. 2018.
- [3] G. Interdonato *et al.*, "Ubiquitous cell-free massive MIMO communications," *EURASIP J. Wireless Commun. Netw.*, vol. 2019, no. 1, 2019, Art. no. 197.
- [4] E. Johnson, "Physical limitations on frequency and power parameters of transistors," in *IRE Int. Conv. Rec.*, vol. 13, Mar. 1965, pp. 27–34.
- [5] T. D. Ponnimbaduge Perera *et al.*, "Simultaneous wireless information and power transfer (SWIPT): Recent advances and future challenges," *IEEE Commun. Surveys Tuts.*, vol. 20, no. 1, pp. 264–302, Jan.–Mar. 2018.
- [6] M. Giordani and M. Zorzi, "Non-terrestrial networks in the 6G era: Challenges and opportunities," 2020, *arXiv:1912.10226*.
- [7] T. L. Marzetta *et al.*, *Fundamentals of Massive MIMO*. New York, NY, USA: Cambridge Univ. Press, 2016.
- [8] H. Q. Ngo *et al.*, "Cell-free massive MIMO versus small cells," *IEEE Wireless Commun.*, vol. 16, no. 3, pp. 1834–1850, Mar. 2017.
- [9] G. Interdonato *et al.*, "Ubiquitous cell-free massive MIMO communications," *EURASIP J. Wireless Commun. Netw.*, vol. 2019, no. 1, p. 197, 2019.
- [10] *Overview of 802.3bt—Power Over Ethernet Standard*, Ethernet Alliance, Apr. 2018.
- [11] *IEEE Standard for a Precision Clock Synchronization Protocol for Networked Measurement and Control Systems*, IEEE 1588-2019, 2019.
- [12] *Timing and Synchronization Aspects in Packet Networks: Recommendation ITU-T G.8261/Y.1361*, ITU-T, Paris, France, Aug. 2019.
- [13] D. Apostolopoulos *et al.*, "Analog radio-over-fiber solutions in support of 5G," in *Proc. IEEE Int. Conf. Opt. Netw. Design Model.*, May 2018, pp. 266–271.
- [14] I. C. Sezgin *et al.*, "A flexible multi-Gbps transmitter using ultra-high speed sigma-delta-over-fiber," in *IEEE MTT-S Int. Microw. Symp. Dig.*, 2018, pp. 1195–1198.
- [15] R. Rogalin *et al.*, "Scalable synchronization and reciprocity calibration for distributed multiuser MIMO," *IEEE Trans. Wireless Commun.*, vol. 13, no. 4, pp. 1815–1831, Apr. 2014.
- [16] A. Bourdoux *et al.*, "Non-reciprocal transceivers in OFDM/SDMA systems: Impact and mitigation," in *Proc. IEEE Radio Wireless Conf.*, 2003, pp. 183–186.

- [17] M. Guillaud *et al.*, "A practical method for wireless channel reciprocity exploitation through relative calibration," in *Proc. Int. Symp. Signal Process. Appl.*, 2005, vol. 1, no. 9, pp. 403–406.
- [18] F. Kaltenberger *et al.*, "Relative channel reciprocity calibration in MIMO/TDD systems," in *Proc. IEEE Future Netw. Mobile Summit.*, 2010, pp. 1–10.
- [19] C. Shepard *et al.*, "Argos: Practical many-antenna base stations," in *Proc. Annu. Int. Conf. Mobile Comput. Netw.*, 2012, pp. 53–64.
- [20] J. Vieira *et al.*, "Reciprocity calibration methods for massive MIMO based on antenna coupling," in *Proc. IEEE Global Commun. Conf.*, Feb. 2014, pp. 3708–3712.
- [21] K. Hausmair *et al.*, "Modeling and linearization of multi-antenna transmitters using over-the-air measurements," in *Proc. IEEE Int. Symp. Circuits Syst.*, 2018, pp. 1–4.
- [22] S. Hesami *et al.*, "Intra-array coupling estimation for mimo transceivers utilizing blind over-the-air measurements," in *IEEE MTT-S Int. Microw. Symp. Dig.*, Jun. 2019, pp. 468–471.
- [23] R. N. Braithwaite, "Digital predistortion of a RF power amplifier using a remote closed loop estimator," in *Proc. IEEE Top. Conf. RF/Microw. Power Amplifiers Radio Wireless Appl.*, Jan. 2020, pp. 42–45.
- [24] X. Wang *et al.*, "Digital predistortion of 5G massive MIMO wireless transmitters based on indirect identification of power amplifier behavior with OTA tests," *IEEE Trans. Microw. Theory Techn.*, vol. 68, no. 1, pp. 315–327, Jan. 2020.
- [25] F. Sánchez *et al.*, "Cooperative space-time coded OFDM with timing errors and carrier frequency offsets," in *Proc. IEEE Int. Conf. Commun.*, 2011, pp. 1–5.
- [26] A. A. Nasir *et al.*, "Timing and carrier synchronization in wireless communication systems: A survey and classification of research in the last 5 years," *EURASIP J. Wireless Commun. Netw.*, vol. 2016, p. 180, 2016.
- [27] H. V. Balan *et al.*, "AirSync: Enabling distributed multiuser MIMO with full spatial multiplexing," *IEEE/ACM Trans. Netw.*, vol. 21, no. 6, pp. 1681–1695, Dec. 2013.
- [28] R. Mudumbai *et al.*, "Distributed transmit beamforming: Challenges and recent progress," *IEEE Commun. Mag.*, vol. 47, no. 2, pp. 102–110, Mar. 2009.
- [29] M. M. Rahman *et al.*, "A distributed consensus approach to synchronization of RF signals," in *Proc. IEEE Stat. Signal Process. Workshop.*, 2012, pp. 281–284.
- [30] K. Nikitopoulos and K. Jamieson, "FASTER: Fine and accurate synchronization for large distributed MIMO wireless networks," Tech. Rep. 279976, 2013.
- [31] R. Rogalin *et al.*, "Scalable synchronization and reciprocity calibration for distributed multiuser MIMO," *IEEE Trans. Wireless Commun.*, vol. 13, no. 4, pp. 1815–1831, Apr. 2014.
- [32] H. V. Cheng and E. G. Larsson, "Some fundamental limits on frequency synchronization in massive MIMO," in *Conf. Rec. Asilomar Conf. Signals, Syst. Comput.*, 2013, pp. 1213–1217.
- [33] L. M. Pessoa *et al.*, "Experimental evaluation of a digitized fiber-wireless system employing sigma delta modulation," *Opt. Exp.*, vol. 22, no. 14, pp. 17508–17523, Jul. 2014.
- [34] S. Jacobsson *et al.*, "Massive MU-MIMO-OFDM uplink with direct RF-sampling and 1-Bit ADCs," in *Proc. IEEE Globecom Workshops.*, Dec. 2019, pp. 1–6.
- [35] Y. Qi *et al.*, "On the phase tracking reference signal (PT-RS) design for 5G new radio (NR)," in *Proc. IEEE Veh. Technol. Conf.*, Jul. 2018, pp. 1–5.
- [36] K. Li *et al.*, "Decentralized baseband processing for massive MU-MIMO systems," *IEEE J. Emerg. Sel. Topics Circuits Syst.*, vol. 7, no. 4, pp. 491–507, Nov. 2017.
- [37] C. Jeon *et al.*, "Decentralized equalization with feedforward architectures for massive MU-MIMO," *IEEE Trans. Signal Process.*, vol. 67, no. 17, pp. 4418–4432, Sep. 2019.
- [38] K. Li *et al.*, "Feedforward architectures for decentralized precoding in massive MU-MIMO systems," in *Proc. 52nd Asilomar Conf. Signals, Syst., Comput.*, Oct. 2018, pp. 1659–1665.
- [39] W. M. Holt, "1.1 Moore's law: A path going forward," in *Proc. IEEE Int. Solid-State Circuits Conf.*, Jan. 2016, pp. 8–13.
- [40] N. Collaert, "1.3 Future scaling: Where systems and technology meet," in *Proc. IEEE Int. Solid-State Circuits Conf.*, Feb. 2020, pp. 25–29.
- [41] F. Dielacher *et al.*, "SiGe BiCMOS technology and circuits for active safety systems," in *Tech. Papers Int. Symp. VLSI Design, Autom. Test.*, Apr. 2014, pp. 1–4.
- [42] M. Schroter *et al.*, "SiGe HBT technology: Future trends and TCAD-based roadmap," *Proc. IEEE*, vol. 105, no. 6, pp. 1068–1086, Jun. 2017.
- [43] P. Hillger *et al.*, "Terahertz imaging and sensing applications with silicon-based technologies," *IEEE Trans. THz Sci. Technol.*, vol. 9, no. 1, pp. 1–19, Jan. 2019.
- [44] D. Y. C. Lie *et al.*, "A review of 5G power amplifier design at cm-wave and mm-wave frequencies," *Wireless Commun. Mobile Comput.*, vol. 2018, pp. 1–16, Jul. 2018.
- [45] A. Gutierrez-Aitken *et al.*, "A meeting of materials: Integrating diverse semiconductor technologies for improved performance at lower cost," *IEEE Microw. Mag.*, vol. 18, no. 2, pp. 60–73, Mar. 2017.
- [46] H. Wang *et al.*, "Power amplifiers performance survey 2000-present," [Online]. Available: https://gems.ece.gatech.edu/PA_survey.html
- [47] A. U. Zaman *et al.*, "Millimeter wave E-plane transition from waveguide to microstrip line with large substrate size related to MMIC integration," *IEEE Microw. Wireless Compon. Lett.*, vol. 26, no. 7, pp. 481–483, Jul. 2016.
- [48] E. Rajo-Iglesias *et al.*, "Parallel plate cavity mode suppression in microstrip circuit packages using a lid of nails," *IEEE Microw. Wireless Compon. Lett.*, vol. 20, no. 1, pp. 31–33, Jan. 2010.
- [49] A. Hassona *et al.*, "Nongalvanic generic packaging solution demonstrated in a fully integrated D-band receiver," *IEEE Trans. THz Sci. Technol.*, vol. 10, no. 3, pp. 321–330, May 2020.
- [50] S. Gunnarsson *et al.*, "A 220 GHz single-chip receiver MMIC with integrated antenna," *IEEE Microw. Wireless Compon. Lett.*, vol. 18, no. 4, pp. 284–286, Apr. 2008.
- [51] V. Vassilev *et al.*, "Imaging front-end for thermal detection using an inp dbbt process," in *Proc. IEEE 39th Int. Conf. Infrared, Millimeter THz Waves.*, 2014, pp. 1–3.
- [52] G. Chattopadhyay *et al.*, "Silicon micromachining for terahertz component development," in *Proc. IEEE MTT-S Int. Microw. RF Conf.*, Dec. 2013, pp. 1–4.
- [53] J. Campion *et al.*, "Toward industrial exploitation of THz frequencies: Integration of SiGe MMICs in silicon-micromachined waveguide systems," *IEEE Trans. THz Sci. Technol.*, vol. 9, no. 6, pp. 624–636, Nov. 2019.
- [54] P. Kirby *et al.*, "Characterization of micromachined silicon rectangular waveguide at 400 GHz," *IEEE Microw. Wireless Compon. Lett.*, vol. 16, no. 6, pp. 366–368, Jun. 2006.
- [55] M. E. Leinonen *et al.*, "System EVM characterization and coverage area estimation of 5G directive mmW links," *IEEE Trans. Microw. Theory Techn.*, vol. 67, no. 12, pp. 5282–5295, Dec. 2019.
- [56] I. Dan *et al.*, "A 300-GHz wireless link employing a photonic transmitter and an active electronic receiver with a transmission bandwidth of 54 GHz," *IEEE Trans. THz Sci. Technol.*, vol. 10, no. 3, pp. 271–281, May 2020.
- [57] S. Jia *et al.*, "0.4 THz photonic-wireless link with 106 Gb/s single channel bitrate," *J. Lightw. Technol.*, vol. 36, no. 2, pp. 610–616, Jan. 2018.
- [58] T. Nagatsuma *et al.*, "Millimeter-wave and terahertz-wave applications enabled by photonics," *IEEE J. Quantum Electron.*, vol. 52, no. 1, pp. 1–12, Jan. 2016.
- [59] T. Nagatsuma, "Advances in terahertz communications accelerated by photonics technologies," in *Proc. 24th OptoElectron. Commun. Conf. Int. Conf. Photon. Switching Comput.*, 2019, pp. 371–379.
- [60] V. K. Chinni *et al.*, "Single-channel 100 Gbit/s transmission using III-V UTC-PDs for future IEEE 802.15.3d wireless links in the 300 GHz band," *Electron. Lett.*, vol. 54, no. 10, pp. 638–640, 2018.
- [61] S. Koenig *et al.*, "Wireless sub-THz communication system with high data rate enabled by RF photonics and active MMIC technology," in *Proc. IEEE Photon. Conf.*, Dec. 2014, pp. 414–415.
- [62] P. Rodriguez-Vazquez *et al.*, "Towards 100 Gbps: A fully electronic 90 Gbps one meter wireless link at 230 GHz," in *Proc. 15th Eur. Radar Conf.*, 2018, pp. 369–372.
- [63] P. Rodriguez-Vazquez *et al.*, "Optimization and performance limits of a 64-QAM wireless communication link at 220–260 GHz in a SiGe HBT technology," in *Proc. IEEE Radio Wireless Symp.*, 2019, pp. 1–3.
- [64] F. Boes *et al.*, "Ultra-broadband MMIC-based wireless link at 240 GHz enabled by 64GS/s DAC," in *Proc. Int. Conf. Infrared, Millimeter THz Waves.*, 2014, pp. 1–2.
- [65] D. Fritsche *et al.*, "A low-power SiGe BiCMOS 190-GHz transceiver chipset with demonstrated data rates up to 50 Gbit/s using on-chip antennas," *IEEE Trans. Microw. Theory Techn.*, vol. 65, no. 9, pp. 3312–3323, Sep. 2017.

- [66] P. Rodríguez-Vázquez *et al.*, “A 16-QAM 100-Gb/s 1-M wireless link with an EVM of 17% at 230 GHz in an SiGe technology,” *IEEE Microw. Wireless Compon. Lett.*, vol. 29, no. 4, pp. 297–299, Apr. 2019.
- [67] P. Rodríguez-Vázquez *et al.*, “Performance evaluation of a 32-QAM 1-meter wireless link operating at 220–260 GHz with a data-rate of 90 Gbps,” in *Proc. Asia-Pacific Microw. Conf.*, Nov. 2019, pp. 723–725.
- [68] P. Rodríguez-Vázquez *et al.*, “Signal-processing challenges in leveraging 100 Gb/s wireless THz,” in *Proc. 2nd 6G Wireless Summit*, 2020, pp. 1–5.
- [69] M. H. Eissa *et al.*, “Wideband 240-GHz transmitter and receiver in BiCMOS technology with 25-Gbit/s data rate,” *IEEE J. Solid-State Circuits*, vol. 53, no. 9, pp. 2532–2542, Sep. 2018.
- [70] S. Hara *et al.*, “300-GHz CMOS transceiver for terahertz wireless communication,” in *Proc. Conf. Asia-Pacific Microw.*, 2019, pp. 429–431.
- [71] S. Hara *et al.*, “A 32Gbit/s 16QAM CMOS receiver in 300 GHz band,” in *IEEE MTT-S Int. Microw. Symp. Dig.*, Oct. 2017, pp. 1703–1706.
- [72] H. Hamada *et al.*, “300-GHz. 100-Gb/s InP-HEMT wireless transceiver using a 300-GHz fundamental mixer,” in *IEEE MTT-S Int. Microw. Symp. Dig.*, Jun. 2018, pp. 1480–1483.
- [73] I. Future, “IEEE 5G and beyond technology roadmap white paper,” *Int. J. Wireless Inf. Netw.*, 2019.
- [74] N. Carvalho and A. Georgiadis, *Wireless Power Transmission for Sustainable Electronics: COT WiPE-IC1301*. New York, NY, USA: Wiley, Mar. 2020.
- [75] A. Boaventura and N. Carvalho, “A low-power wakeup radio for application in WSN-based indoor location systems,” *Int. J. Wireless Inf. Netw.*, pp. 67–73, Mar. 2013.
- [76] B. Clerckx *et al.*, “Toward 1G mobile power networks: RF, signal, and system designs to make smart objects autonomous,” *IEEE Microw. Mag.*, vol. 19, no. 6, pp. 69–82, Sep./Oct. 2018.
- [77] R. Correia *et al.*, “Continuously power delivering for passive backscatter wireless sensor networks,” *IEEE Trans. Microw. Theory Techn.*, vol. 64, no. 11, pp. 3723–3731, Nov. 2016.
- [78] D. Belo *et al.*, “A selective, tracking, and power adaptive far-field wireless power transfer system,” *IEEE Trans. Microw. Theory Techn.*, vol. 67, no. 9, pp. 3856–3866, Sep. 2019.
- [79] R. Correia and N. B. Carvalho, “Ultrafast backscatter modulator with low-power consumption and wireless power transmission capabilities,” *IEEE Microw. Wireless Compon. Lett.*, vol. 27, no. 12, pp. 1152–1154, Dec. 2017.
- [80] D. Goto *et al.*, “LEO-MIMO satellite systems for high capacity transmission,” in *Proc. IEEE Glob. Commun. Conf.*, Dec. 2018, pp. 1–6.
- [81] K. Bahia and S. Suardi, “The state of mobile internet connectivity,” UK: Groupe Special Mobile Association (GSMA), 2019.
- [82] I. del Portillo *et al.*, “A technical comparison of three low earth orbit satellite constellation systems to provide global broadband,” *Acta Astronaut.*, vol. 159, pp. 123–135, Jun. 2019.
- [83] T. Canada, “Telesat Ka-band NGSO constellation FCC filing SAT-PDR-20161115-00108,” Ottawa, ON, Canada.
- [84] WorldVu Satellites Limited, “OneWeb Ka-band NGSO constellation expansion FCC filing SAT-MOD20180319-00022,” Federal Communications Commission, Washington, DC, USA, 2020.
- [85] L. Space Exploration Holdings, “SpaceX Ka-band NGSO constellation FCC filing SAT-LOA-20161115-00118,” Federal Communications Commission, Washington, DC, USA, 2020.
- [86] K. Kibaroglu *et al.*, “A 64-element 28-GHz phased-array transceiver with 52-dBm EIRP and 8-12-Gb/s 5G Link at 300 meters without any calibration,” *IEEE Trans. Microw. Theory Techn.*, vol. 66, no. 12, pp. 5796–5811, Dec. 2018.
- [87] J. D. Dunworth *et al.*, “A 28 GHz Bulk-CMOS dual-polarization phased-array transceiver with 24 channels for 5G user and basestation equipment,” in *Proc. IEEE Int. Solid-State Circuits Conf.*, Feb. 2018, pp. 70–72.
- [88] H.-T. Kim *et al.*, “A 28 GHz CMOS direct conversion transceiver with packaged antenna arrays for 5G cellular system,” in *Proc. IEEE Radio Freq. Integr. Circuits Symp.*, Jun. 2017, pp. 69–72.
- [89] B. Sadhu *et al.*, “A 28 GHz 32-element phased-array transceiver IC with concurrent dual polarized beams and 1.4 degree beam-steering resolution for 5G communication,” in *Proc. IEEE Int. Solid-State Circuits Conf.*, Feb. 2017, pp. 128–129.
- [90] K. Kibaroglu *et al.*, “A low-cost scalable 32-element 28-GHz phased array transceiver for 5G communication links based on a 2×2 beam-former flip-chip unit cell,” *IEEE J. Solid-State Circuits*, vol. 53, no. 5, pp. 1260–1274, May 2018.
- [91] X. Gu *et al.*, “A multilayer organic package with 64 dual-polarized antennas for 28 GHz 5G communication,” in *Proc. IEEE MTT-S Int. Microw. Symp.*, Jun. 2017, pp. 1899–1901.
- [92] Amazon, “Kuiper Satellite Constellation FCC filing SAT-LOA-20190704-00057,” Federal Communications Commission, Washington, DC, USA, 2020.
- [93] A. Puglielli *et al.*, “Design of energy- and cost-efficient massive MIMO arrays,” *Proc. IEEE*, vol. 104, no. 3, pp. 586–606, Mar. 2016.
- [94] S. Shakib *et al.*, “A highly efficient and linear power amplifier for 28-GHz 5G phased array radios in 28-nm CMOS,” *IEEE J. Solid-State Circuits*, vol. 51, no. 12, pp. 3020–3036, Dec. 2016.
- [95] W. Roh *et al.*, “Millimeter-wave beamforming as an enabling technology for 5G cellular communications: Theoretical feasibility and prototype results,” *IEEE Commun. Mag.*, vol. 52, no. 2, pp. 106–113, Feb. 2014.
- [96] Isotropic Systems, Inc. [Online]. Available: <https://www.isotropicsystems.com/>
- [97] ALCAN Systems. [Online]. Available: <https://www.alcansystems.com/>
- [98] C-COM Satellite Systems. [Online]. Available: <http://www.c-comsat.com/>
- [99] SatixFy. [Online]. Available: <http://www.satixfy.com/>
- [100] Kymeta. [Online]. Available: <https://www.kymetacorp.com/>
- [101] “Thin Air Falcon-Ka2517,” Tech. Rep. [Online]. Available: http://www.thinkom.com/wp-content/uploads/2018/04/ThinAir-Falcon-Ka2517-Data-Sheet_Rev02-18.pdf
- [102] Anokiwave. [Online]. Available: <https://www.anokiwave.com/products/index.html>
- [103] Hanwha Phasor Limited. [Online]. Available: <http://www.phasorsolutions.com/>

ULF GUSTAVSSON received the M.Sc. degree in electrical engineering from Örebro University, Örebro, Sweden, in 2006, and the Ph.D. degree from Chalmers University of Technology, Gothenburg, Sweden, in 2011. His background ranges from power amplifier design to radio signal processing. He is currently a Senior Specialist with Ericsson Research where his research interests include novel radio signal processing techniques for hardware impairment mitigation and behavioral modeling of radio hardware for future advanced antenna systems and communication engineering.

He is currently the Lead Scientist from Ericsson Research with the Marie Skodowska-Curie European Industrial Doctorate Innovative Training Network, SILIKA.

PÅL FRENGER received the Ph.D. degree in electrical engineering from Chalmers University of Technology, Gothenburg, Sweden.

He joined Ericsson Research in 1999. He is currently with the Radio Access Technologies Department, Ericsson Research, Linköping, Sweden, where he holds an Expert position in RAN energy efficiency. He has a background in link level research, in particular on turbo coding and OFDM modulation aspects. He has been involved in development and standardization efforts for both HSPA and LTE and 5G New Radio. He has more than 250 filed inventions and received the Ericsson Inventor of the Year Award in 2017.

CHRISTIAN FAGER (Senior Member, IEEE) received the Ph.D. degree from Chalmers University of Technology, Sweden, in 2003. He is currently a Full Professor with Chalmers University of Technology and Head of the Microwave Electronics Laboratory. He has authored or coauthored more than 140 publications in international journals and conferences. His current research interest includes energy efficient and linear transmitters for future wireless communication systems.

Dr. Fager serves as an Associate Editor of *IEEE Microwave Magazine* and *IEEE MICROWAVE AND WIRELESS COMPONENTS LETTERS*. He is a representative for Sweden, Norway, and Iceland in the European Microwave Association (EuMA). He is a TPC Member for the IEEE MTT-S International Microwave Symposium (IMS) and is also Chair/Co-Chair of the 2020 to 2021 IEEE Topical Conference on RF/Microwave Power Amplifiers and TPC Co-Chair for the 2020 European Microwave Integrated Circuits Conference. He was the recipient of the Chalmers Supervisor of the Year Award in 2018 and the IEEE International Microwave Symposium Best Student Paper Award in 2002.

THOMAS ERIKSSON (Senior Member, IEEE) received the Ph.D. degree in information theory from the Chalmers University of Technology, Gothenburg, Sweden, in 1996. From 1990 to 1996, he was with Chalmers. In 1997 and 1998, he was with AT T Labs—Research, Murray Hill, NJ, USA. In 1998 and 1999, he was with Ericsson Radio Systems AB, Kista, Sweden. Since 1999, he has been with Chalmers University, where he is currently a Professor of Communication Systems. Furthermore, he was a Guest Professor with Yonsei University, South Korea, in 2003 to 2004. He has authored or coauthored more than 250 journal and conference papers, and holds 14 patents. He is leading the research on hardware-constrained communications with Chalmers University of Technology. His research interests include communication, data compression, and modeling and compensation of non-ideal hardware components (e.g., amplifiers, oscillators, and modulators in communication transmitters and receivers, including massive MIMO). He is currently leading several projects on massive MIMO communications with imperfect hardware, MIMO communication taken to its limits: 100Gbit/s link demonstration; wideband linearization (DPD), satellite communication with phase noise limitations; and efficient and linear transceivers, etc. He is currently the Vice Head of the Department of Signals and Systems, Chalmers University of Technology, where he is responsible for undergraduate and master's education.

HERBERT ZIRATH (Fellow, IEEE) was born in Gothenburg, Sweden, on March 20, 1955. He received the M.Sc. and Ph.D. degrees in electrical engineering from Chalmers University, Gothenburg, Sweden, in 1980 and 1986, respectively.

From 1986 to 1996, he was a Researcher with the Radio and Space Science with Chalmers University, engaged in developing a GaAs and InP-based HEMT technology, including devices, models, and circuits. In 1998, he was a Research Fellow at Caltech, Pasadena, CA, USA, engaged in the design of monolithic microwave integrated circuit (MMIC) frequency multipliers and Class E Power amplifiers. He has been a Professor of High Speed Electronics with the Department of Microtechnology and Nanoscience, MC2, Chalmers University, since 1996. He became the Head of the Microwave Electronics Laboratory in 2001. At present, he is leading a group of approximately 40 researchers in the area of high frequency semiconductor devices and circuits. He is author or coauthor of more than 530 refereed journal/conference papers and hold five patents. His main research interests include MMIC designs for wireless communication and sensor applications based on III-V, III-N, Graphene, and silicon devices.

He is a Research Fellow at Ericsson AB, Gothenburg, Sweden, leading the development of a D-band (110-170 GHz) chipset for high data rate wireless communication. He is a Co-Founder of Gotmic AB, Gothenburg, a company developing highly integrated front-end MMIC chip-sets for 60 GHz and E-band wireless communication.

FRANZ DELACHER (Senior Member, IEEE) received the M.S. and Ph.D. degrees in electrical engineering from the Graz University of Technology, Austria. His doctoral research was directed towards the modeling, simulation, and design of oversampled analog-to-digital converters. From 1981 until 1999, he worked for Siemens Semiconductor Group in circuit development and system integration for wireline and wireless communications. Since 1999, He has been with Infineon Technologies in various positions in circuits and systems for communications like DSL, high-speed transceivers, and wireless infrastructure. He is currently a Senior Principal Engineer with the RF and Sensors Group. His international involvement includes ISSCC TPC member from 2001 to 2011, ISSCC wireline Sub-Committee Chair, ESSCIRC TPC member and TPC Chair, ESSCIRC Steering Board Member, IEEE SSCS AdCOM member and a Distinguished Lecturer and member of technical program committees for EUMIC, COMCAS, and VLSI-TSA. He is also a Scientific Advisory Board Member at the Ferdinand-Braun-Institute for High Frequency Technology in Berlin.

CHRISTOPH STUDER (Senior Member, IEEE) received the Ph.D. degree in electrical engineering from ETH Zurich, in 2009. He is an Associate Professor with the Department of Information Technology and Electrical Engineering, ETH Zurich, Zurich, Switzerland. From 2009 to 2012, he was a Postdoctoral Researcher with ETH Zurich and at Rice University, Houston, TX. In 2013, he held the position of Research Scientist with Rice University. From 2014 to 2019, he was an Assistant Professor with Cornell University. From 2019 to 2020, he was an Associate Professor with Cornell University and at Cornell Tech in New York City. In 2020, he joined ETH Zurich and since 2014, he is also an Adjunct Professor with Rice University.

His research interests include the design of application-specific integrated circuits, as well as wireless communications, digital signal processing, optimization, and machine learning.

Dr. Studer was the recipient of the ETH Medals for the M.S. and Ph.D. theses in 2006 and 2009, respectively. He received a Swiss National Science Foundation fellowship for Advanced Researchers in 2011 and a US National Science Foundation CAREER Award in 2017. He shared the Swisscom/ICTnet Innovations Award in both 2010 and 2013. He was the winner of the Student Paper Contest of the 2007 Asilomar Conference on Signals, Systems, and Computers, received a Best Student Paper Award of the 2008 IEEE International Symposium on Circuits and Systems (ISCAS), and shared the best Live Demonstration Award at IEEE ISCAS in 2013. He is currently an Associate Editor of IEEE OPEN JOURNAL OF CIRCUITS AND SYSTEMS. In 2019, he was the Technical Program Chair of the Asilomar Conference on Signals, Systems, and Computers, and a Technical Program Co-Chair of the IEEE International Workshop on Signal Processing Systems (SIPS). Since 2019, He has been an Associate Editor for IEEE OPEN JOURNAL OF CIRCUITS AND SYSTEMS (OJCS).

AARNO PÄRSSINEN (Senior Member, IEEE) received the Doctor of Science degree in electrical engineering from the Helsinki University of Technology, Finland, in 2000. In 1996, he was a Research Visitor with the University of California at Santa Barbara. From 2000 to 2011, he was with Nokia Research Center, Helsinki, Finland where he served as a member of Nokia CEO Technology Council from 2009 to 2011. From 2011 to 2013, he was with Renesas Mobile Corporation, Helsinki and then joined Broadcom, Helsinki as part of business acquisition until September 2014. Since September 2014, he has been with University of Oulu, Centre for Wireless Communications, Finland where he is currently a Professor. He is currently leading the device and circuits research area in 6G flagship program financed by the Academy of Finland. His research interests include wireless systems and transceiver architectures for wireless communications with special emphasis on the RF and analog integrated circuit and system design. He has authored and coauthored one book, two book chapters, more than 100 international journal and conference papers and holds several patents. He is also one of the original contributors to Bluetooth low energy extension, now called as BLE. He was a member of the technical program committee of the International Solid-State Circuits Conference in 2007–2017, chairing the wireless subcommittee in 2014–2017.

RICARDO CORREIA (Member, IEEE) received the M.Sc. degree in electronics and telecommunications engineering from the University of Aveiro, Aveiro, Portugal, in 2009, and the Ph.D. degree in electrical engineering from the University of Aveiro in 2019. He was an Automation and Electrical Engineer and a Researcher in embedded systems and signal processing. He is currently a Researcher with Sinuta SA, Estarreja, Aveiro where he works on transmission and reception system of electronically oriented signals for next generation satellite constellations. He is also a Collaborator at the Institute of Telecommunications, University of Aveiro. His current research interests include wireless power transfer, energy harvesting, wireless passive sensors for space applications, and low power communications. Dr. Correia is a member of the IEEE Microwave Theory and Techniques Society. He is also a reviewer for *IET Microwaves, Antennas and Propagation, Wireless Power Transfer Journal* and IEEE TRANSACTIONS ON MICROWAVE THEORY AND TECHNIQUES. He was the recipient of the 2016 URSI/ANACOM Prize awarded by the URSI Portuguese Section and Portuguese National Authority of Communications and second place in the Ph.D. category of 2019 Fraunhofer Portugal challenge.

JOÃO NUNO MATOS (Member, IEEE) was born in Oliveira de Azeméis, Portugal, in 1959. He received the Degree in electronic and telecommunications engineering from the University of Aveiro, Portugal, in 1982, the master's degree in electrical science from the University of Coimbra, Portugal, in 1989, and the Ph.D. degree in electrical engineering from the University of Aveiro, Portugal, in 1995. He worked twice in the industry from 1982 to 1983 with Portugal Telecom Innovation, Aveiro, Portugal, and in 1990 with Ensa Electronic, Madrid, Spain. From 1998 to 2000, he was the Head of the Electronics and Telecommunications Department, of the Aveiro University, Portugal. He is currently Associate Professor with the University of Aveiro and Senior Researcher with the Telecommunications Institute. He is author or coauthor of more than 100 international conference papers and journals. With the Telecommunications Institute, he participated or led dozens of research's projects in RF / microwave (MW) circuits, system design and system integration. His current topics of interests include satellite communications and radars with a special focus on front-end and smart antennas, and engineering education. Dr. Matos is a member of several scientific committees of conferences and journals, as well as professional organizations and is currently on the Executive Committee of the IEEE Portugal Education Chapter (2019 IEEE Education Society Chapter Achievement Award).

DANIEL BELO received the M.Sc. degree in electronics and telecommunications engineering in 2014 from University of Aveiro, Aveiro, Portugal, where he is currently working towards the Ph.D. degree. He is a Researcher with Instituto de Telecomunicações since 2013 and his main research interest include microwave electronic circuits, wireless power transfer systems, and analogue/digital control.

NUNO BORGES CARVALHO (Fellow, IEEE) was born in Luanda, Angola, in 1972. He received the Diploma and Doctoral degrees in electronics and telecommunications engineering from the University of Aveiro, Aveiro, Portugal, in 1995 and 2000, respectively. He is currently a Full Professor and a Senior Research Scientist with the Institute of Telecommunications, University of Aveiro. He coauthored *Intermodulation in Microwave and Wireless Circuits* (Artech House, 2003), *Microwave and Wireless Measurement Techniques* (Cambridge University Press, 2013), *White Space Communication Technologies* (Cambridge University Press, 2014), and *Wireless Power Transmission for Sustainable Electronics* (Wiley, 2020). He has been a reviewer and author of more than 200 papers in magazines and conferences. He is the Editor in Chief of the, an Associate Editor of the *IEEE Microwave Magazine* and former Associate Editor of *IEEE TRANSACTIONS ON MICROWAVE THEORY AND TECHNIQUES* and *IET Microwaves Antennas and Propagation Journal*. He is the co-inventor of six patents. His main research interests include software-defined radio front-ends, wireless power transmission, nonlinear distortion analysis in microwave/wireless circuits and systems, and measurement of nonlinear phenomena. He has recently been involved in the design of dedicated radios and systems for newly emerging wireless technologies.

Dr. Borges Carvalho is a member of the IEEE MTT ADCOM, Past-Chair of the IEEE Portuguese Section, MTT-20 and MTT-11 and also belongs to technical committees MTT-24 and MTT-26. He is also the Vice-Chair of the URSI Commission A (Metrology Group). He was the recipient of the 1995 University of Aveiro and the Portuguese Engineering Association Prize for the best 1995 student at the University of Aveiro, the 1998 Student Paper Competition (Third Place) of the IEEE Microwave Theory and Techniques Society (IEEE MTT-S) International Microwave Symposium (IMS), and the 2000 IEE Measurement Prize. He was a Distinguished Microwave Lecturer for the IEEE Microwave Theory and Techniques Society.