

# Improvement of Edible Mushroom Yield by Electric Stimulations

Koichi TAKAKI, Nobuyuki YAMAZAKI, Seiji MUKAIGAWA, Tamiya FUJIWARA  
and Hisayoshi KOFUJITA

*Iwate University, Ueda 4-3-5, Morioka, Iwate 020-8551, JAPAN*

Kyusuke TAKAHASI

*Morioka Forest Association, Konya-cho 2-9, Morioka, Iwate 020-0885, JAPAN*

Maki NARIMATSU

*Tono Agricultural and Forestry Center, Muikamachi 1-22, Tono, Iwate 028-0525, JAPAN*

Kenichi NAGANE

*Nagane Co. Ltd., Nakano 3-37-41, Hirono-cho, Kunohe-gun, Iwate 028-0790, JAPAN*

(Received: 23 August 2008 / Accepted: 16 December 2008)

Pulsed high voltage was applied to logs for mushroom culturing to clarify an effect of the pulse high-voltage stimulation on mushroom yield. Inductive energy storage system was employed to construct a pulsed power generator with compact size. Copper thin fuse was used as opening switch to interrupt large circuit current in short time. Four stages Marx generator was used to supply a large current to a secondary energy storage inductor. The output voltage of the inductive energy storage system pulsed power generator was 120 kV with 50 ns pulse width at 5 kV charging voltage to the primary energy storage capacitor. This pulsed high-voltage was applied to sawdust-based block for culturing *Lyophyllum decastes* and natural logs for culturing *Lentinula edodes*, *Pholiota nameko* and *Naematoloma sublateritium* as an electrical stimulation. The experimental results clearly showed that the yields for four kinds mushroom increased to 1.5-2.1 times larger yield by applying pulse voltage as electrical stimulation.

Keywords: Pulsed power, Electrical stimulation, Pulsed high voltage, Inductive energy storage, Mushroom, Culturing, *Lyophyllum decastes*.

## 1. Introduction

Mushroom extra ordinal grow-up around a hit point of a lightning have been reported by some mushroom farmers [1]. The mechanism of the mushroom outbreak is not clear, but some researchers suggest two possibilities. One is the generation of cracks in mycelium hyphae by the lightning because mushroom fruit bodies are generated from cracks in hyphae [1]. The other is the activity of enzymes. Some enzymes were activated by applying pulse electric field and, as the results, mushroom fruit bodies was actively developed [2].

An effectiveness of electrical sources such as high voltages in sinusoidal waves or pulses in cultivating mushrooms has been reported by several researchers since the 1950s. Mibuchi *et al.* reported that the yields of shiitake mushroom (*Lentinula edodes*) increases by electrical stimulation in 1984 [3]. They got the yield more than twice as many as no pulse applied mushrooms using an impulse generator with pulse-width of 40 $\mu$ s. Some other

researchers also achieved the improvement of mushroom yield using other electrical sources such as high voltages of sinusoidal waves or pulses [2-5]. For the commercial use of the cultivating technique, it is necessary to develop compact and portable high-voltage power sources.

Inductive energy storage (IES) pulsed power generators have favorable features for the mushroom cultivating applications e.g. compact, cost effective, light weight, high voltage amplification compared with capacitive energy storage generators such as the impulse generator. Tsukamoto *et al.* carried out high voltage pulse stimulation in *Lentinula edodes* culturing using IES pulsed power generator [7]. However, it is not clear that an effect of the high-voltage stimulation for other kinds of mushroom such as a nameko mushroom (*Pholiota nameko*) which is mainly cultured at north part of Japan; Tohoku area. In this paper, an effect of the pulsed high-voltage stimulation for sawdust-based substrate for *Lyophyllum decastes* culturing and natural logs for

*Lentinula edodes*, *Pholiota nameko* and *Naematoloma sublateralitium* culturing on mushroom growth is described.

## 2. Behavior of Pulsed Power Generator

### 2.1 Marx-IES Pulsed Power Generator

Figure 1 shows the IES pulsed power generator circuit used for the high-voltage electric stimulation for the mushrooms. The IES pulsed power generator basically consists of primary energy storage capacitors  $C$ , a closing switches  $GS$ , a secondary energy storage inductor  $L$ , and an opening switch [8]. Copper fuse of 0.03 or 0.05 mm diameter was used as the opening switch to interrupt large current in short time. The four primary energy storage capacitors of 0.22  $\mu\text{F}$  was connected in parallel and were charged up using high voltage dc power supply (50 kV maximum voltage). A charging voltage  $V_0$  of the each primary energy storage capacitor was controlled in range from 5 to 7 kV. After charging up the capacitor, the gap switch  $GS$  was triggered externally. The closing switch  $GS$  changed the connection of the capacitors changed from parallel to series. As the result, the voltage was stepped up from  $V_0$  to  $4V_0$  in same manner to the Marx generator. The fuse length and the total inductance  $L$  of the secondary energy storage inductor and the generator circuit were changed in range from 5 to 20 cm and from 1.3 to 38  $\mu\text{H}$ , respectively. The circuit current and the output voltage were measured with Pearson 110A current transformer and Pulse Electronics EP-100K high-voltage probe, respectively. The output signals from the current transformer and the voltage probe were monitored using a Tektronix TDS3054B digitizing oscilloscope.

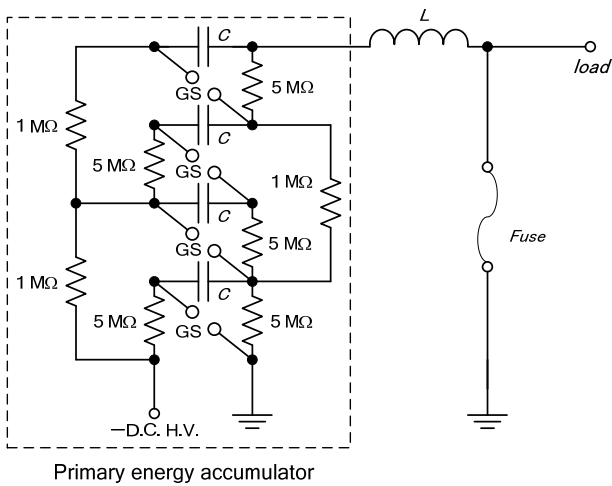

Fig.1 Marx-IES pulsed power generator using fuse as an opening switch. (C: Primary energy storage capacitor, L: Secondary energy storage inductor)

### 2.2 Output Voltage

Figure 2 shows typical circuit (fuse) current and output voltage waveforms without connection to the logs at 5 kV charging voltage. The fuse length and the inductance

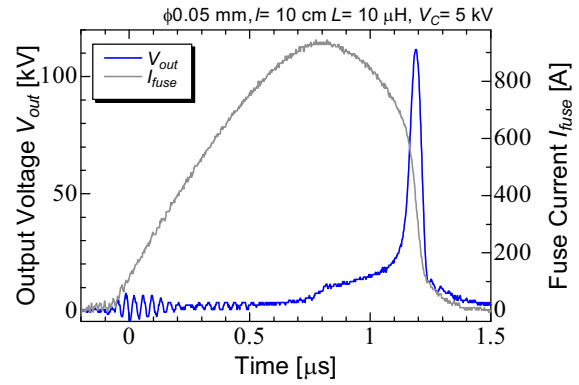

Fig.2 Typical waveforms of fuse current and output voltage at  $\phi=0.05\text{mm}$ ,  $l=10\text{ cm}$ ,  $V_C=5\text{ kV}$  and  $L=10\text{ }\mu\text{H}$ .

of the secondary energy storage inductor are chosen to be  $l=10\text{ cm}$  and  $L=10\text{ }\mu\text{H}$ , respectively. The time 0 means closing the switch  $GS$ . The circuit current starts to flow after closing the switch  $GS$  with  $LC$  oscillation. The peak value of the circuit current is about 920 A at 0.8  $\mu\text{s}$  after closing the switch. After the current peak, the current decreases gradually from 920 to 600 during 0.3  $\mu\text{s}$ . This time duration corresponds to a fuse melting phase. The circuit current is interrupted after fuse melting phase within 100 ns. The output voltage increases rapidly and has a maximum voltage of 110 kV, which corresponds to 22 of an amplification factor defined as ratio of the maximum output voltage to the charging voltage. The pulse width of the output voltage is 50 ns in FWHM (full-width at half-maximum). The high voltage pulse is produced by the total circuit inductance and rapid current interruption produces a high voltage pulse expressed as

$$v = V_0 - \frac{1}{C} \int i dt - L \frac{di}{dt} \approx -L \frac{di}{dt} \quad (1)$$

where,  $i$  means the circuit current.

Figure 3 shows peak value of the output voltage as a function of inductance of the secondary energy storage inductor for two different fuse diameters; 0.03 and 0.05 mm. The fuse length and charging voltage are 10 cm and 5 kV, respectively. The plots on the graph were obtained as

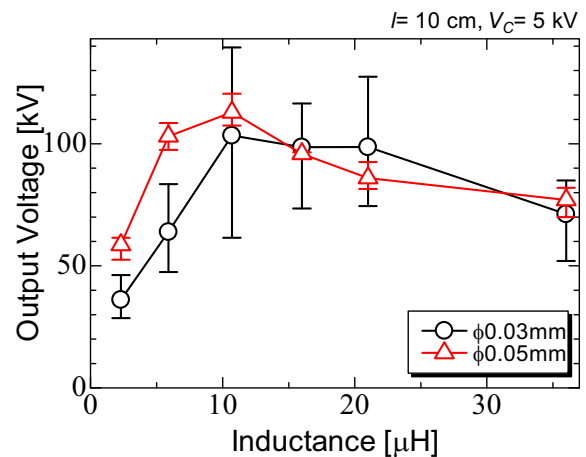

Fig.3 Peak value of the output voltage as a function of total inductance of the secondary energy storage inductor for two different fuse diameters.

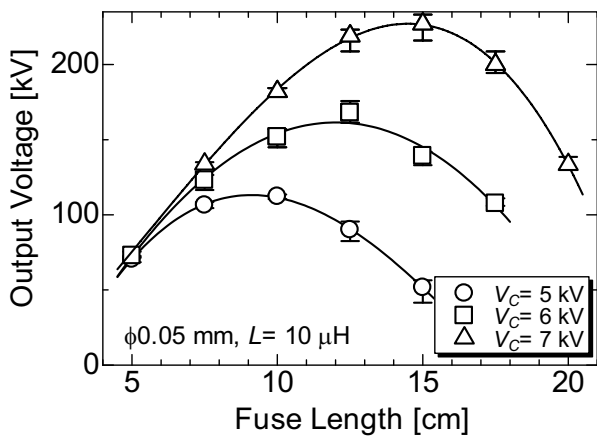

Fig.4 Peak value of the output voltage as a function of fuse length for various charging voltages of the primary energy storage capacitor.

average value through five times measurement. The error bar means scattering of the output voltage. The output voltage has maximum value around  $L=10 \mu\text{H}$  for both fuse diameter cases. The voltage scattering of 0.05 mm diameter fuse is smaller than those of 0.03 mm diameter fuse.

Figure 4 shows the peak value of the output voltage as a function of fuse length for three different charging voltages. The fuse diameter and the inductance of the secondary energy storage inductor were set to be 0.05 mm and  $L=10 \mu\text{H}$ , respectively. The peak voltage increases with increasing the charging voltage. The maximum values of the voltage are 110, 160 and 230 kV for charging voltage of 5, 6 and 7 kV, respectively. These values correspond to 22, 27 and 33 of voltage amplification factors. The result indicates that the voltage amplification factor increase with charging voltage. The output voltage also increases with increasing fuse length in the case of low fuse length and has maximum value in range from 10 to 15 cm. The optimum length for high output voltage changes with charging voltage of the capacitor.

### 3. Stimulation for Sawdust-Based Cultivation

Figure 5 shows experimental setup for pulsed power stimulation to sawdust-based blocks with dimension of 12 x 9 x 20 cm for *Lyophyllum decastes* cultivation. The blocks were inoculated *Lyophyllum decastes* fungus around one year before the stimulation. After inoculation of *Lyophyllum decastes* fungus they were matured in the dark room under wet condition during necessary period for each experiment. The experiment was carried out as an attempt to increase the yields of *Lyophyllum decaste* in autumn of 2007. The three blocks were used as applying voltage group. All data were the total value of the blocks. The blocks of the stimulated group were applied electrical stimulations with one pulse of 100 kV voltage. The pulse voltage was applied to needle electrode of 3 mm diameter driven in the sawdust block at 7 cm length. Three blocks of

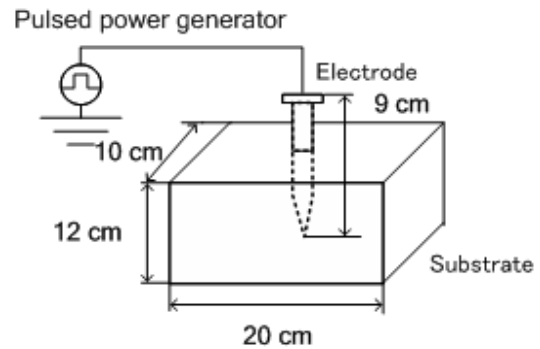

Fig.5 Experimental setup for pulsed power stimulation to sawdust-based block.

the control group were not applied the pulse voltage. Fruit bodies of *Lyophyllum decaste* mushrooms were cropped in same day.

Figure 6 shows the total weight of the mushroom cropped by three blocks for two different cultured places. The total cropped weight of the mushroom in stimulated group are 1.25 and 1.66 kg for the block located in the planter and in the field, and these values are larger than 1.77 and 1.50 kg of control group. Figure 7 shows the photograph of cultured *Lyophyllum decastes* taken in same day. The *Lyophyllum decastes* in stimulation group grow up faster than those in control group. This tendency almost coincides with the experimental result reported by Tsukamoto *et al* [1].

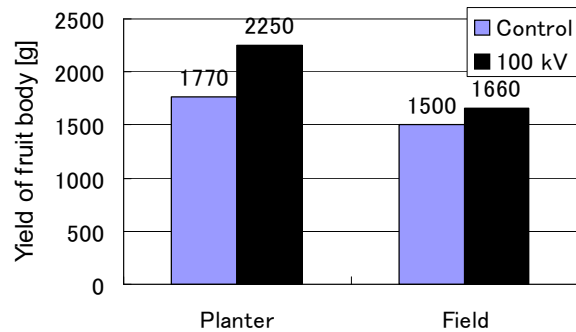

Fig.6 Total weight of cultured *Lyophyllum decastes* with and without the electric stimulation

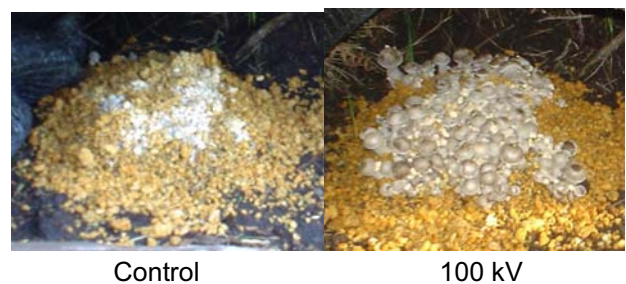

Fig.7 Typical photographs of the cultured *Lyophyllum decastes* with and without the electric stimulation.

### 4. Stimulation for Log-Based Cultivation

Figure 8 shows experimental setup for pulsed power stimulation for the natural log cultivation. Three different

kinds of mushrooms; *Lentinula edodes*, *Pholiota nameko* and *Naematoloma sublateritium*, are used as specimen. The funguses of the mushrooms were inoculated in the natural logs around two years before the experiment. The logs employed in the experiment have dimension of 90 cm length and 10 cm diameter. The needle electrode of 3 mm diameter and 9 cm length was driven in the logs with 7 cm and was applied the pulse voltage by the pulsed power generator shown in Fig. 1. The fruiting season of the strain is mainly in early autumn, partially in spring. After the inoculation of the funguses they were matured in the woods during necessary period for each experiment. The experiment was carried out as an attempt to increase the yields of the mushrooms in autumn of 2007. Logs of from 10 to 15 were used as one group because the mushroom yield has some scatter for each log. All data were the total value of all logs in one group.

Figure 9 shows the total weight of the *Lentinula edodes* cropped by 15 logs for five different pulse voltage stimulation conditions. One group is without pulse voltage stimulation indicates as control group. Three groups are stimulated by one time high-voltage pulse with three different amplitudes; 50, 90 and 125 kV. The last group is stimulated with 50 times of 50 kV pulse voltage. The total cropped weight of *Lentinula edodes* in 50 kV, 50 times group shows 2.29 kg, and this value is 2.1 times larger than that of 50kV x one time group. Figure 10 shows the photograph of cultured *Lentinula edodes* taken in same day. The *Lentinula edodes* in stimulation group of 50 kV x 50

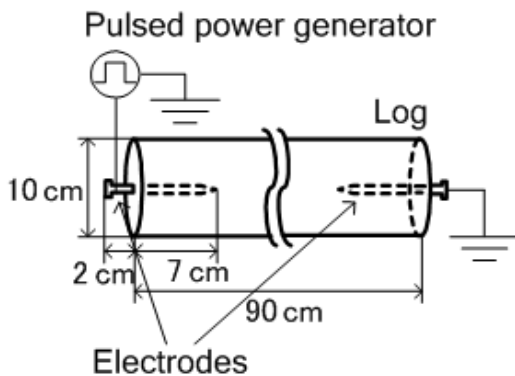

Fig.8 Experimental setup for pulsed power stimulation to the log.

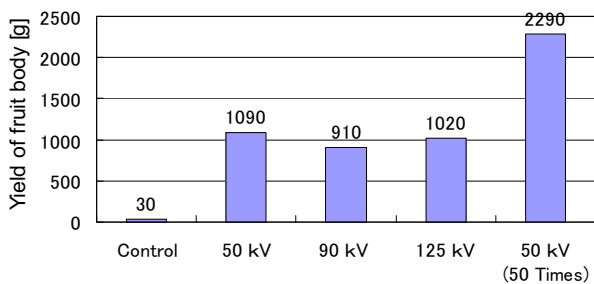

Fig.9 Total weight of cultured *Lentinula edodes* for various electric stimulation conditions.

Siitake mushroom (Oct 7, 07; Sotoyama park)

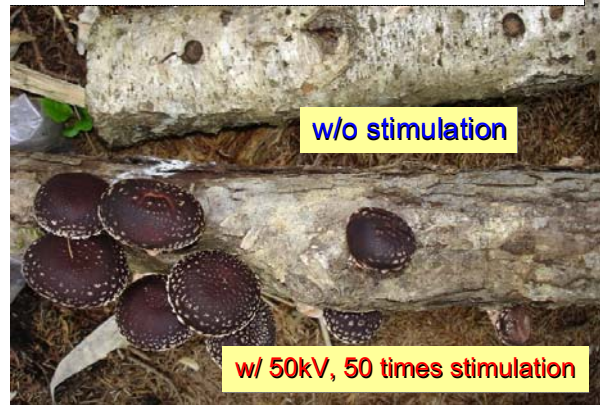

Fig.10 Typical photographs of the cultured *Lentinula edodes* with and without the electric stimulation.

times grow up faster than those in control group. Other kinds of the mushroom, such as *Pholiota nameko* and *Naematoloma sublateritium*, show almost same tendency with the experimental results of *Lentinula edodes* as shown in Fig. 9.

## 5. Conclusions

The pulsed high voltage was applied to logs for mushroom culturing to clarify an effect of the pulse high-voltage stimulation on mushroom yield. Inductive energy storage system was employed to construct a pulsed power generator with compact size. Four stages Marx generator was used to supply a large current to a secondary energy storage inductor. The output voltage of the inductive energy storage system pulsed power generator was 120 kV with 50 ns pulse width at 5 kV charging voltage to the primary energy storage capacitor. This pulsed high-voltage was applied to sawdust-based block of *Lyophyllum decastes* and natural logs of *Lentinula edodes*, *Pholiota nameko* and *Naematoloma sublateritium* as an electrical stimulation. The experimental results clearly showed that the yields for four kinds mushroom with the electrical stimulation were nearly 1.5-2.1 times larger than those without the stimulation.

- [1] S. Tsukamoto *et al.*, Proc. of the 15th Pulsed Power Conf., 1437 (2005).
- [2] S. Ohga and S. Iida, J. For. Res **6**, 37 (2001).
- [3] Y. Mibuchi and M. Yamamoto, Kyushu Electric Power Co. Research Report No.87004, 1 (1984) [in Japanese]
- [4] K. Kudo *et al.*, Journal of the Institute of Electrostatics Japan, **23**, 186 (1999) [in Japanese]
- [5] S. Ohga *et al.*, Journal of the Japanese Society of Mushroom Science and Biotechnology, **9**, 7 (2001)
- [6] K. Takaki *et al.*, Plasma Process and Polymer, **3**, 734 (2006)
- [7] S. Tsukamoto *et al.*, Proceeding of the 14th Pulsed Power Conference, 1116 (2003)
- [8] K. Takaki *et al.*, IEEE Trans. Diel. Elec. Insul., **14**, 834 (2007)